





Part #:	ADRF5046/47 & ADRF5024/25	  
Description:	<ul style="list-style-type: none"> • Widest bandwidth RF Switches Support up to 44GHz • Reflective architecture provides lowest insertion loss 	 Download Datasheet

EEVblog Electronics Community Forum

A Free & Open Forum For Electronics Enthusiasts & Professionals

Hello volvo_nut_v70

Show unread posts since last visit.
Show new replies to your posts.
March 05, 2020, 04:58:29 pm

This topic

- Home
- Help
- Search
- Profile
- About us
- My Messages
- Calendar
- Links
- Members
- Logout

EEVblog Electronics Community Forum » Electronics » Metrology » Teardown/repair : Time Electronics 9823 10ppm/year AC-DC calibrator

Low Prices. No Compromises.
Used Scopes up to **60% off.**

200 MHz Scope

1GHz Scope



1.5GHz Scope

[SHOP NOW >>](#)



5 PCBs for \$2, any color

\$5 off for the first 50 to order with the code "EEJLPCB"



« previous next »

Pages: 1 2 [All] [Go Down](#)

[REPLY](#) [NOTIFY](#) [MARK UNREAD](#) [SEND THIS TOPIC](#) [PRINT](#) [SEARCH](#)

Author

Topic: **Teardown/repair : Time Electronics 9823 10ppm/year AC-DC calibrator** (Read 17865)

volvo_nut_v70 and 0 Guests are viewing this topic.

TiN

Super Contributor



Posts: 4122

Country:

xDevs.com/live - 24/7 lab feed



Teardown/repair : Time Electronics 9823 10ppm/year AC-DC calibrator

« on: March 14, 2016, 03:43:32 pm »

[Say Thanks](#) [Reply](#) [Quote](#)

Let's dig into something rare. Not Keithley, not Fluke, but Time Electronics 9823 straight from England! 😊



This beast was bought on eBay (seller still have lesser version, 30ppm/year [9822](#)).

There is hardly any information on the web about this old beast, but from what is available, it's specifications are well competitive to monsters like Fluke 5500A/Datron 4808! I could not resist, you know.

Thing powers up, provide output but it's barely functional and have issues. E.g. if I set output

10.00000V, I get 9.845V. Adjustment to 10.1V making voltage jump and then quickly go back 9.845V. Sounds like digital/DAC issue to me. So, let's take it apart...

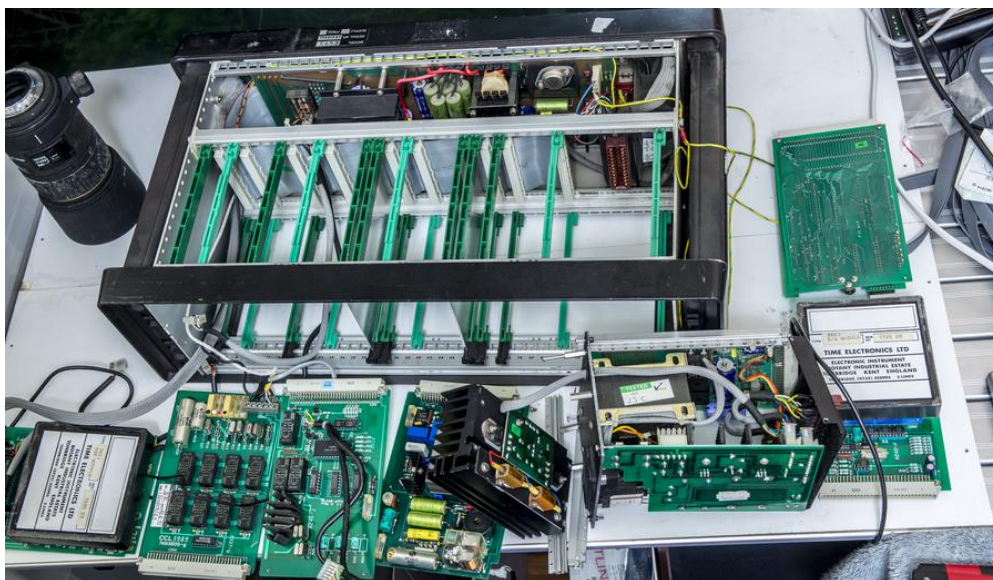

Construction is using aluminum frame with many boards. Most of parts numbers are dated 1988, some 1990. Everything is DIP and boards are 2-layer. Should be rather easy to recover schematics, yay.

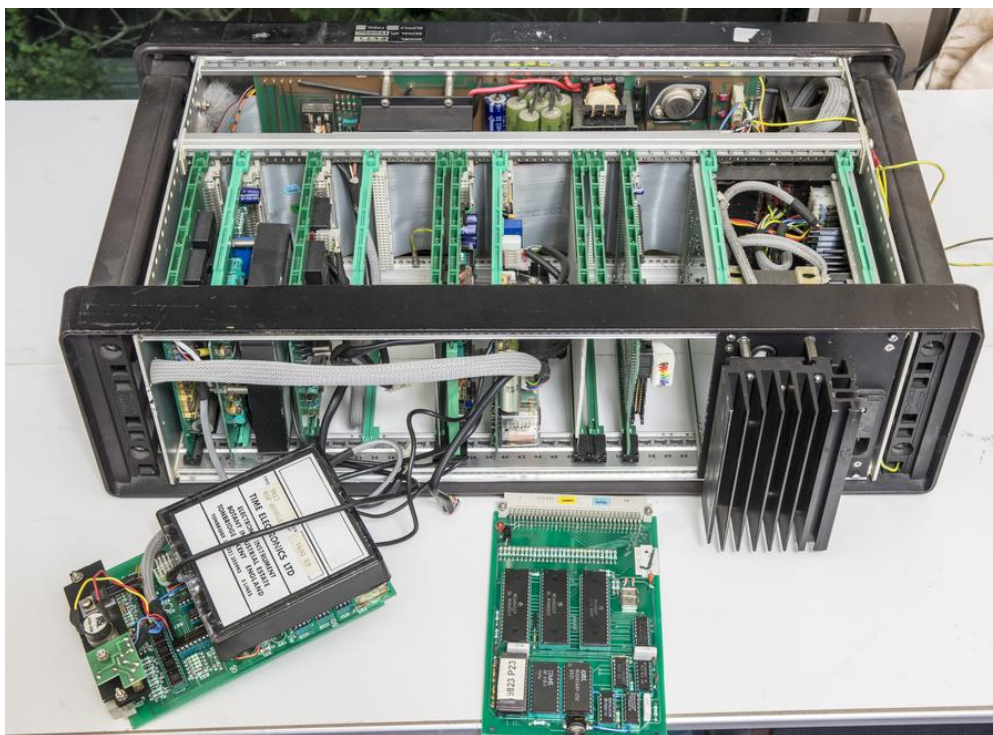

Take a look on boards:
I let you guess which one is what.

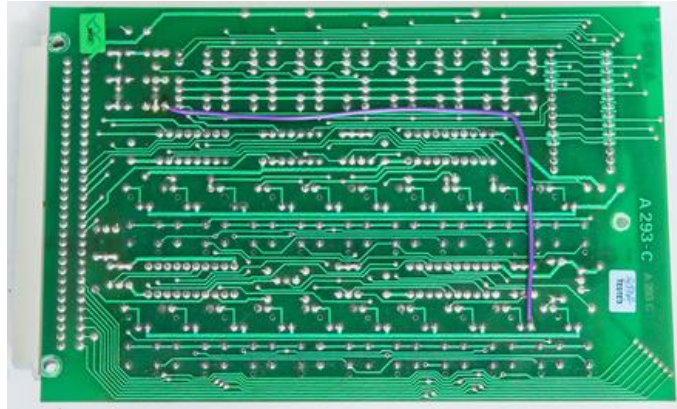
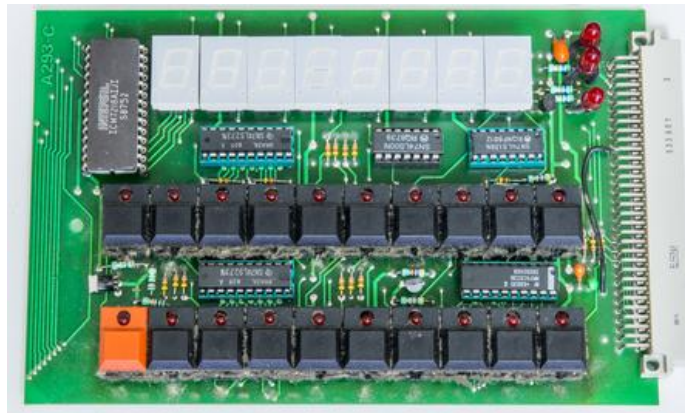

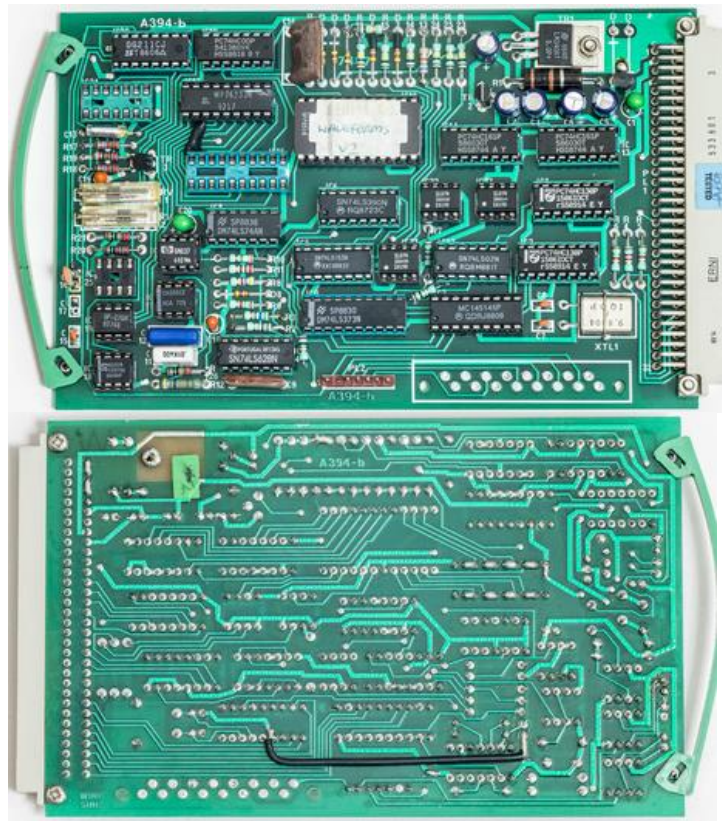

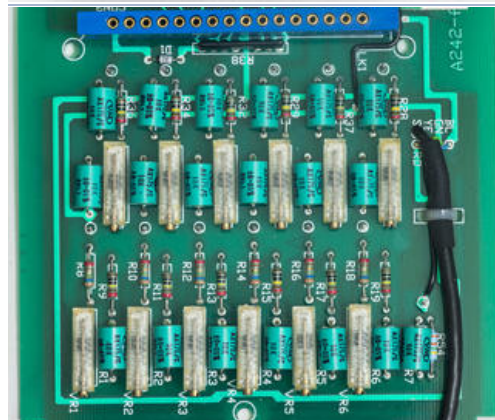
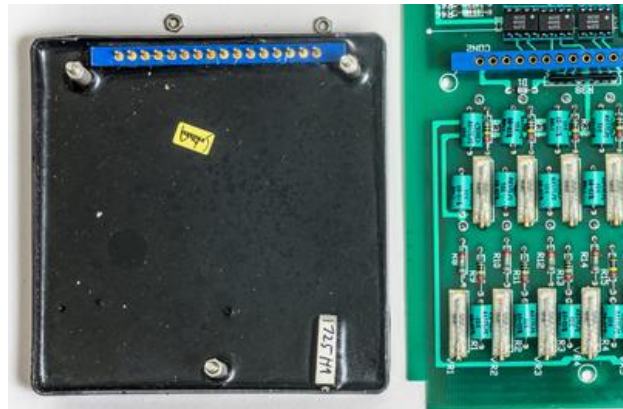
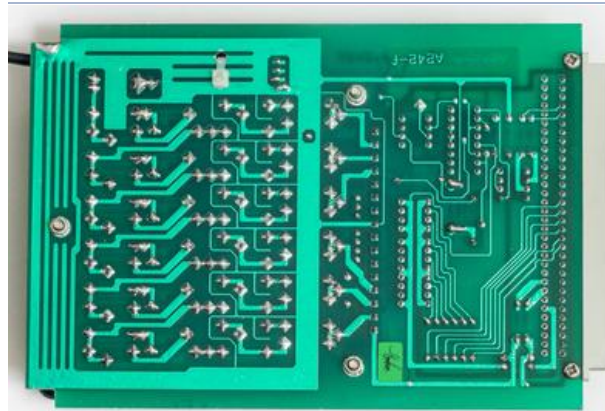

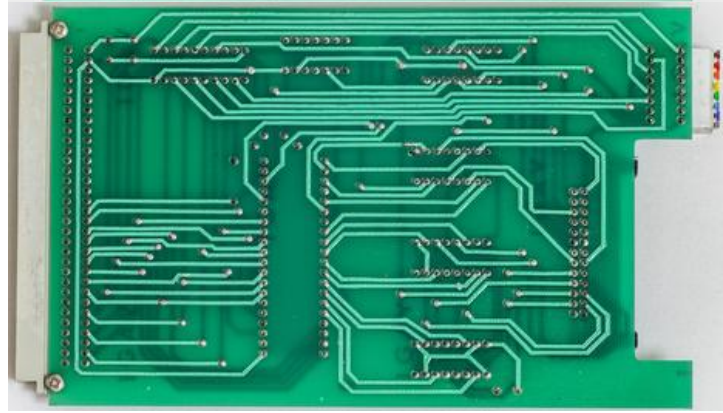
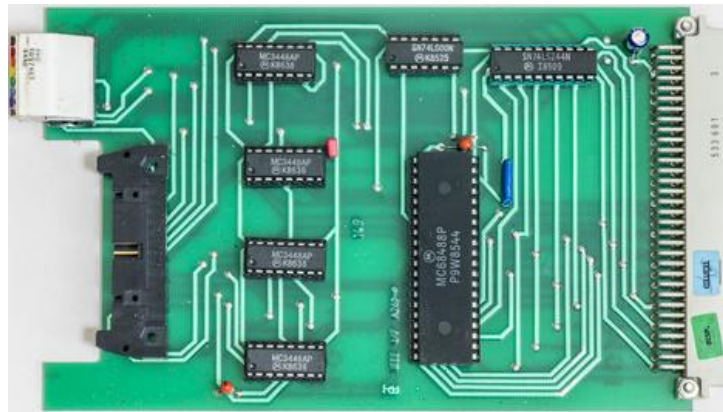
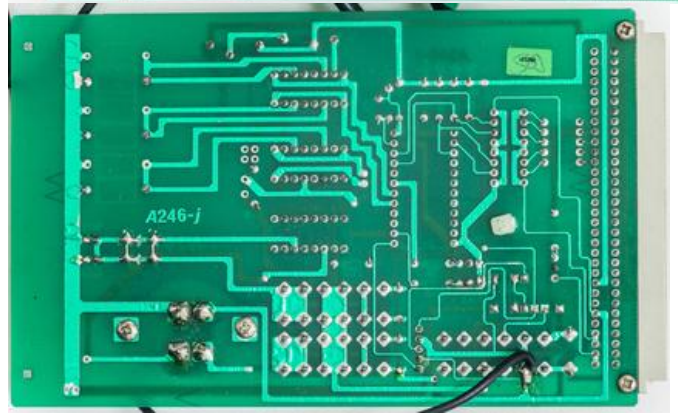

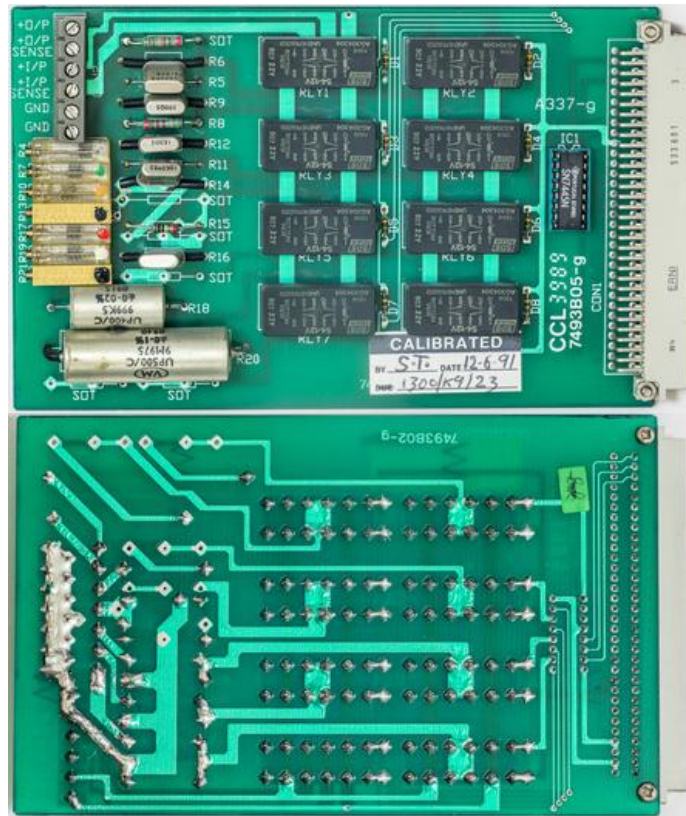

Some cleaning would help...



Too bad DAC and reference are potted in large blocks 😞. Seems it will remain a mystery what reference is used in this machine.

Anyone had experience with this calibrator? Any manuals/service info?

Report to moderator Logged

[YouTube](#) | [Metrology IRC Chat room](#) | [Live-cam](#) | Share T&M documentation? [Upload!](#) No MB limit, firmwares, photos.

The following users thanked this post: TheBay

Vgkid
Super Contributor



Posts: 2556
Country:

IanJ
Supporter



Posts: 1060
Country:
Pro EE guy many years ago,
now a hobby/home biz.

Re: Teardown/repair : Time Electronics 9823 10ppm/year AC-DC calibrator

Say Thanks Reply Quote

« Reply #1 on: March 14, 2016, 05:39:36 pm »

Thanks for the teardown, certainly an interesting beast.
Shame about the potting...

Report to moderator Logged

If you own any North Hills Electronics gear, message me. L&N Fan

Re: Teardown/repair : Time Electronics 9823 10ppm/year AC-DC calibrator

Say Thanks Reply Quote

« Reply #2 on: March 14, 2016, 07:02:42 pm »

Hi all,

Well I recognize the Euro card 19" rack kit.....sold by Farnell in the UK, we bought tons of them. Made by Vero I think. The green plastic guides were brittle and the little location protrusions at the ends would snap off rendering them useless. The dark green ones are original, looks like the lighter ones are a newer design.

I notice that Time Electronics elected to use a ribbon cable backplane rather than one long PCB.

Ian.

Report to moderator Logged

Ian Johnston
www.ianjohnston.com
Manufacturer of the PDVS2 & PDVS2mini

quarks
Frequent Contributor

Re: Teardown/repair : Time Electronics 9823 10ppm/year AC-DC calibrator

Say Thanks Reply Quote

« Reply #3 on: March 14, 2016, 07:22:26 pm »

9

Posts: 833
 Country: 
  

TiN

Super Contributor



Posts: 4122
 Country: 

xDevs.com/live - 24/7 lab feed



Hello TiN,
 how do you find all this jewels and even more interesting, how do you all things you do in only 24h per days?

Thanks again for sharing.

Bye

quarks

[Report to moderator](#)  Logged

 **Re: Teardown/repair : Time Electronics 9823 10ppm/year AC-DC calibrator**

[Say Thanks](#)

[Reply](#)

[Quote](#)

« **Reply #4 on:** March 14, 2016, 11:43:38 pm »

Quote from: quarks on March 14, 2016, 07:22:26 pm

how do you find all this jewels and even more interesting, how do you all things you do in only 24h per days?

You call that doing? Man, I don't want even making by backlog list, believe me. Some of the gear sitting in the piles for years(!). Blame all to precision-nuttery. And since it's funded by personal cash, simple "go buy F5720A" ain't happening, leaving room only for obscure and wierd gear like this one 😊.

For example, right now I need solve dilemma which one to work first, 9823 or 2002. 2002 is much easier, but still will take 20-40 hours, while 9823 can be 5 hour fix, or 500 hour one. I'm going to buy manual for it, hoping for schematics/service info. And that's ignoring any other projects I have to date..

DiligentMinds.com

To my regret, I don't have access to X-Ray.

IanJ

I got impression that outer rack kit is something standard. Thanks for details and info!

[Report to moderator](#)  Logged

[YouTube](#) | [Metrology IRC Chat room](#) | [Live-cam](#) | Share T&M documentation? [Upload!](#) No MB limit, firmwares, photos.

manganin

Regular Contributor



Posts: 109
 Country: 



 **Re: Teardown/repair : Time Electronics 9823 10ppm/year AC-DC calibrator**

[Say Thanks](#)

[Reply](#)

[Quote](#)

« **Reply #5 on:** March 15, 2016, 04:07:21 pm »

Quote from: TiN on March 14, 2016, 03:43:32 pm

it's specifications are well competitive to monsters like Fluke 5500A / Datron 4808!

Datron 4808: not even close in real life. Fluke 5500A: probably comparable, except the AC frequency upper limit, which can be a problem when calibrating some multimeters following the manufacturers original procedure. (The "high" frequency AC is where most of the weight and cost of the high end calibrators comes from.)

The good side is that the Times instrument is very simple and straightforward design. Seen what you have done before, should be easy for you to get it working.

Basically a good instrument for calibrating up to 6.5 digit multimeters, but most often seen in calibrating handhelds.

The problems are usually high voltage/current AC (follow the burn marks), connector (especially the ribbon) or relay related.

Quote from: TiN on March 14, 2016, 03:43:32 pm

Too bad DAC and reference are potted in large blocks

I am not familiar with that specific module, but the company has always potted the key circuits in their equipment. Usually there are a few standard ICs and some passives inside. Protecting their (repair) business rather than hiding any innovations.

Quote from: TiN on March 14, 2016, 03:43:32 pm

Any manuals/service info?

The company still exists. They can probably send/sell the User Manual, but getting service documents has been very difficult. (My guess would be that their current calibrator models are still very similar inside.)

Report to moderator Logged

The following users thanked this post: engiadina

TiN
Super Contributor



Posts: 4122
Country:
xDevs.com/live - 24/7 lab feed

Re: Teardown/repair : Time Electronics 9823 10ppm/year AC-DC calibrator

Say Thanks Reply Quote

« Reply #6 on: March 16, 2016, 04:56:06 am »

I got user manual and calibration manual from Time (linked in article). For service info, I'm attempting to get paper copy, will see how that goes.

Will be interesting to get this box fixed and perhaps pimp it out for better performance, replacing reference with LTZ-module and building better DAC?

Report to moderator Logged

[YouTube](#) | [Metrology IRC Chat room](#) | [Live-cam](#) | Share T&M documentation? [Upload!](#) No MB limit, firmwares, photos.

ManateeMafia
Frequent Contributor

Posts: 719
Country:

Re: Teardown/repair : Time Electronics 9823 10ppm/year AC-DC calibrator

Say Thanks Reply Quote

« Reply #7 on: March 16, 2016, 05:18:18 am »

It definitely looks more serviceable than my Datron 4700. You don't even need an extender board.

Report to moderator Logged

TiN
Super Contributor



Posts: 4122
Country:
xDevs.com/live - 24/7 lab feed

Re: Teardown/repair : Time Electronics 9823 10ppm/year AC-DC calibrator

Say Thanks Reply Quote

« Reply #8 on: March 19, 2016, 03:08:37 am »

Alright, thanks to fellow volt-nuts I got few pieces of schematics for REF and DAC boards. Full paper manual I paid for should be on it's way on monday too.

Reference board:

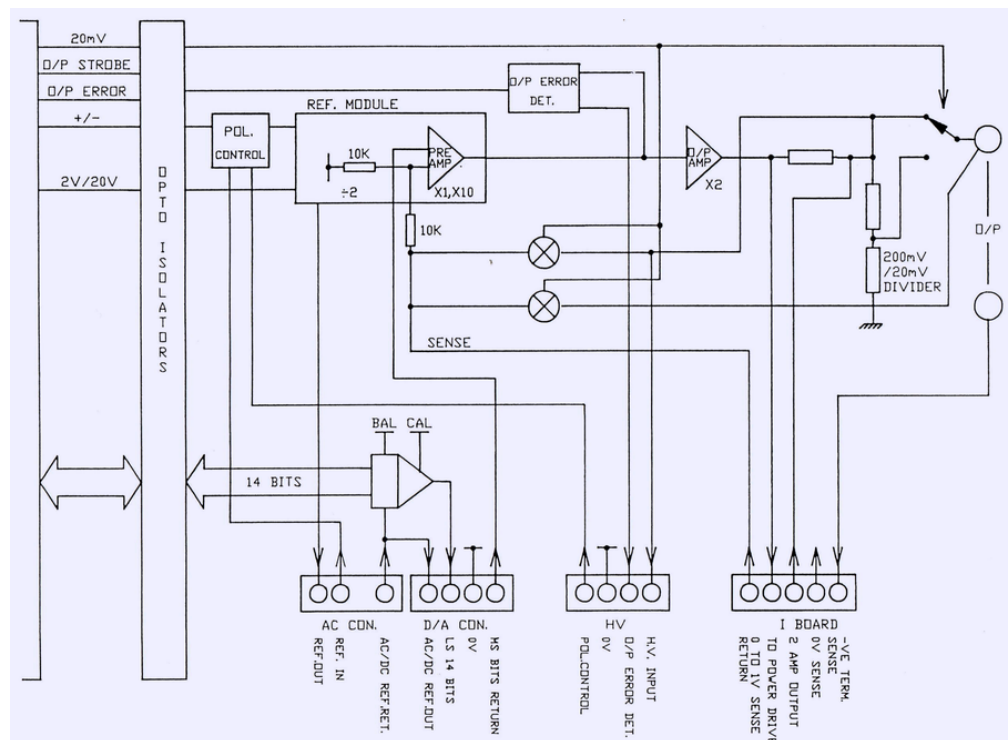

There is 14-bit AD DAC , output of which goes to DAC PCBA (net LS 14 bits, perhaps meaning least significant 14 bits?).

Then return from DAC module comes back to REF PCB (MS Bits return, most significant?) making 20 bits output?

Schematics:

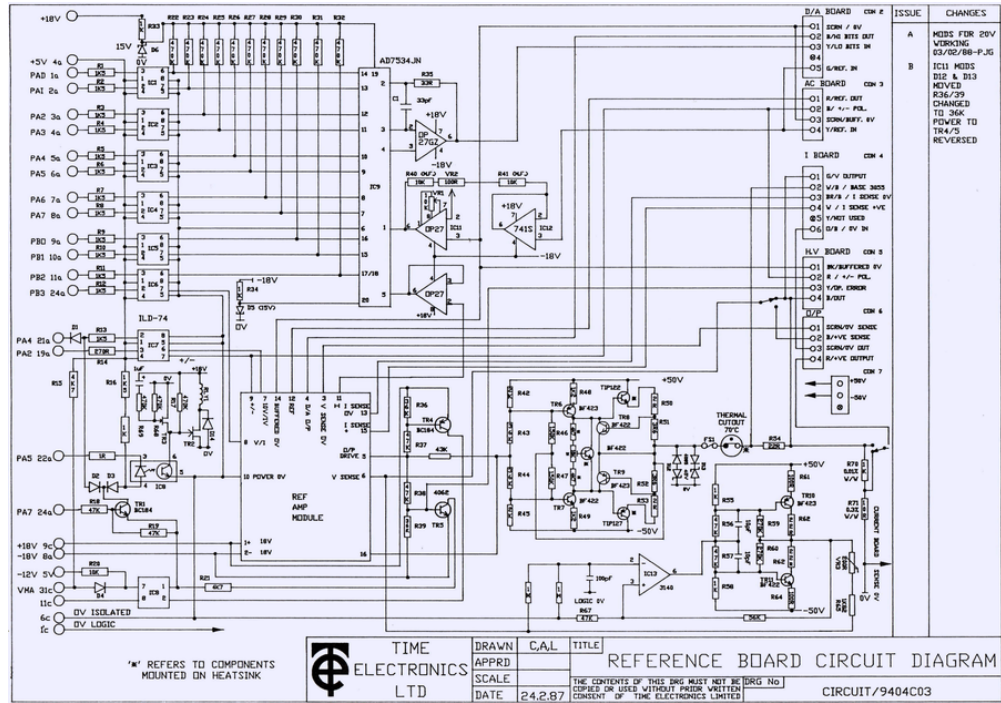

Elements location:

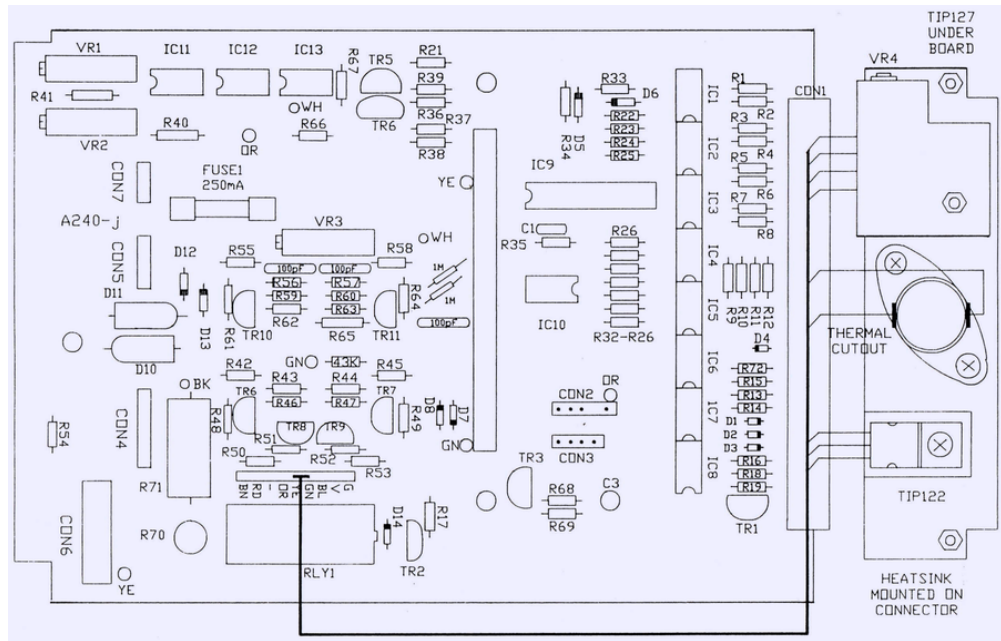

DAC PCBA

Block diagram:

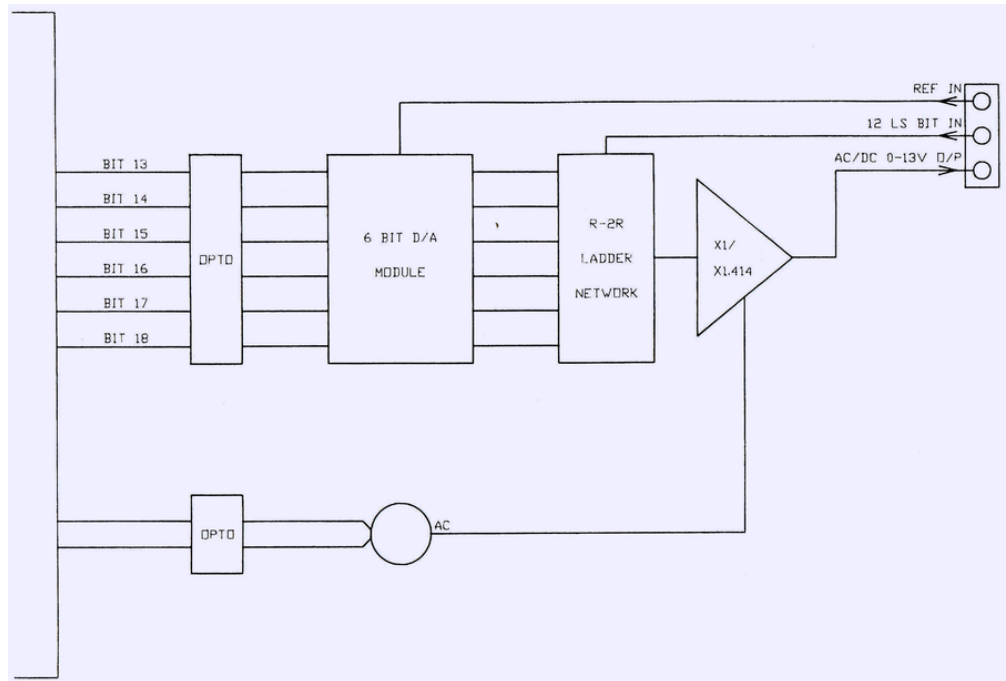

Calibration trimmer locations:

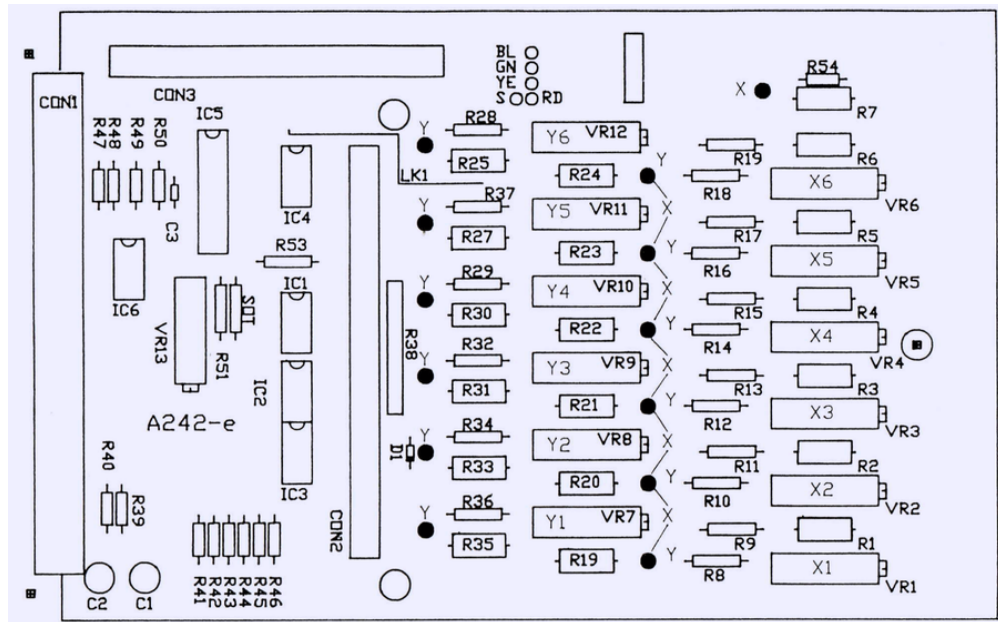

Schematics of DAC module.

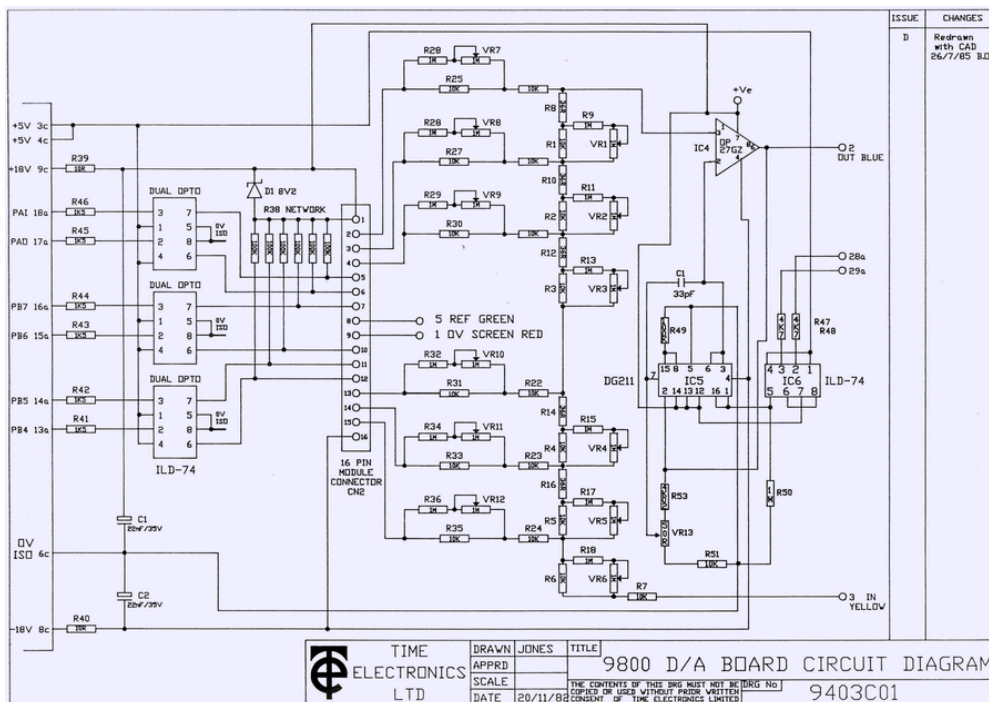

Now need to understand how this thing works to troubleshoot.

REF signal measurement against BUFFERED 0V show 10.42260V, pretty stable. But output from calibrator with 10V set shows stable 9.83417 VDC and it does not change if I change setting to 10.01 for example.

I'll make a jig to test all those optocoupler (ILDN14). There are many of them everywhere, perhaps some are dead?..

Report to moderator Logged

[YouTube](#) | [Metrology IRC Chat room](#) | [Live-cam](#) | Share T&M documentation? [Upload!](#) No MB limit, firmwares, photos.

The following users thanked this post: CalMachine

Jay_Diddy_B

Super Contributor



Posts: 1840

Country:



Re: Teardown/repair : Time Electronics 9823 10ppm/year AC-DC calibrator

Say Thanks Reply Quote

« Reply #9 on: March 19, 2016, 03:30:00 am »

Hi,

looking at the circuit for the 9800 D/A Board, I would guess that the module contains JFET switches or something like that.

Regards,

Jay_Diddy_B

Report to moderator Logged

TiN

Super Contributor



Posts: 4122

Country:

xDevs.com/live - 24/7 lab feed



Re: Teardown/repair : Time Electronics 9823 10ppm/year AC-DC calibrator

Say Thanks Reply Quote

« Reply #10 on: March 19, 2016, 01:20:09 pm »

Tested all ILD74 optocouplers. They all seem to be fine, but superslow, at 8kHz already barely useable, with ~11-28us of rise time.

Going to test AD7534 DAC on REF board now and check some local powers.

Report to moderator Logged

[YouTube](#) | [Metrology IRC Chat room](#) | [Live-cam](#) | Share T&M documentation? [Upload!](#) No MB limit, firmwares, photos.

TiN

Super Contributor

Re: Teardown/repair : Time Electronics 9823 10ppm/year AC-DC calibrator

Say Thanks Reply Quote

« Reply #11 on: March 20, 2016, 02:37:48 pm »



Posts: 4122

Country:

xDevs.com/live - 24/7 lab feed



Scope capture of optocoupler output on CS/WR signal to REF DAC:

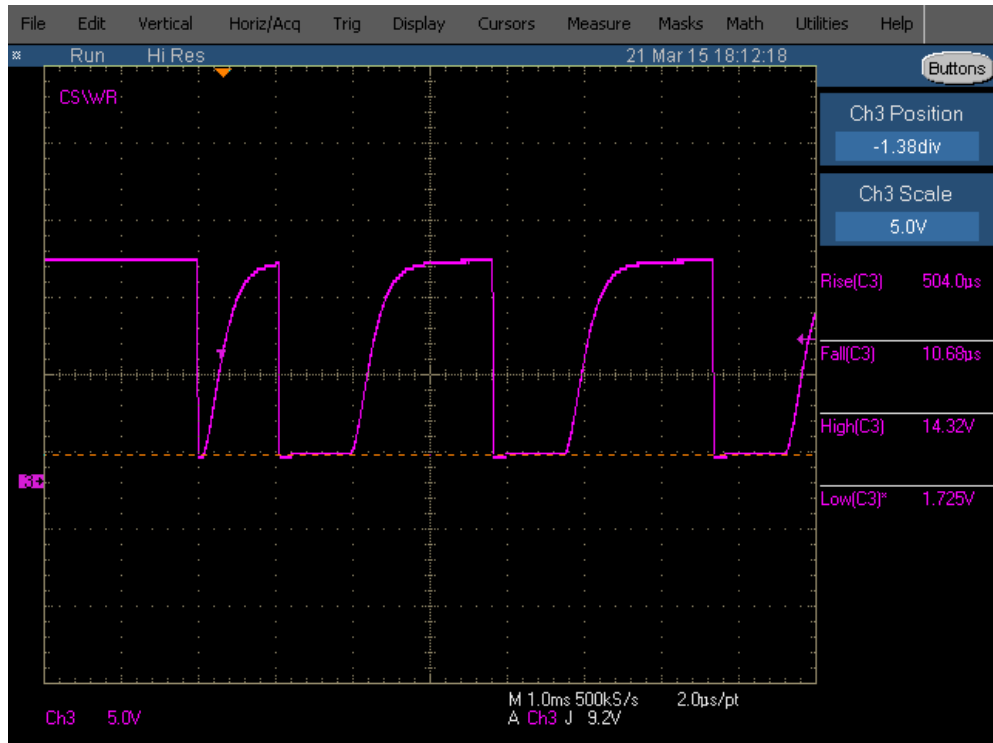

I'm not sure if this horrid rise time normal or not. Will see tomorrow, when I get digikey box with some new ILD74 couplers..

Disassembled more of front panel side to get access for high-current power amplifier/TA:

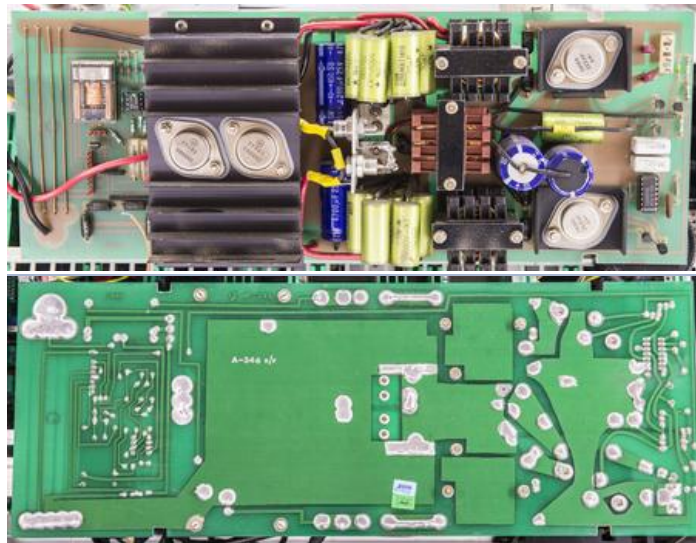

Front panel connections and cabling:

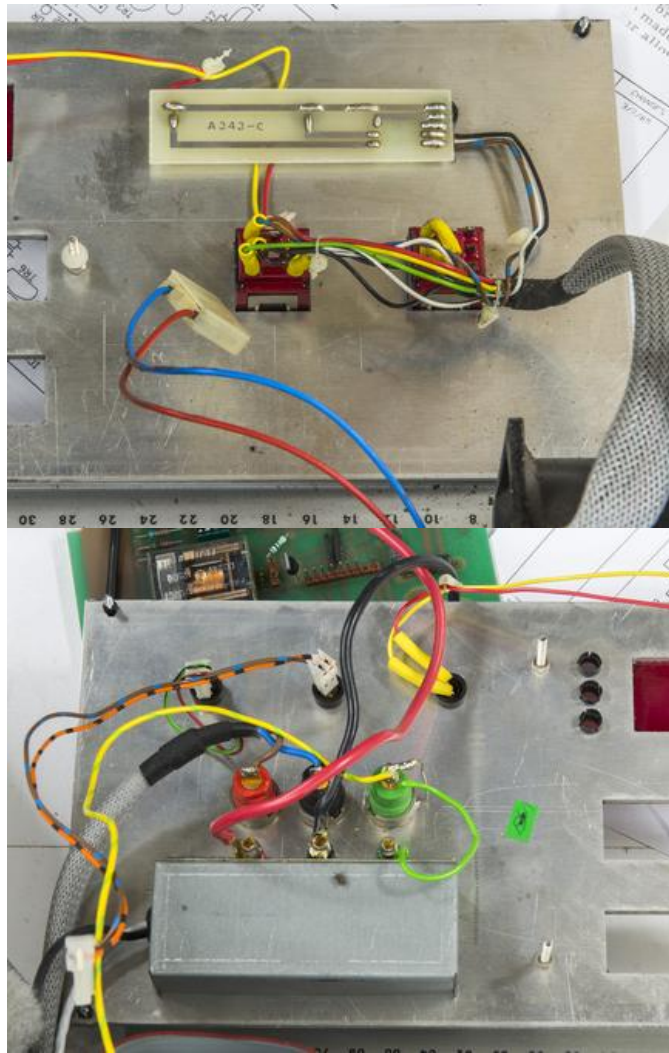

Main binding posts are gold-plated, very much likely made by copper. Shielded by steel cage.

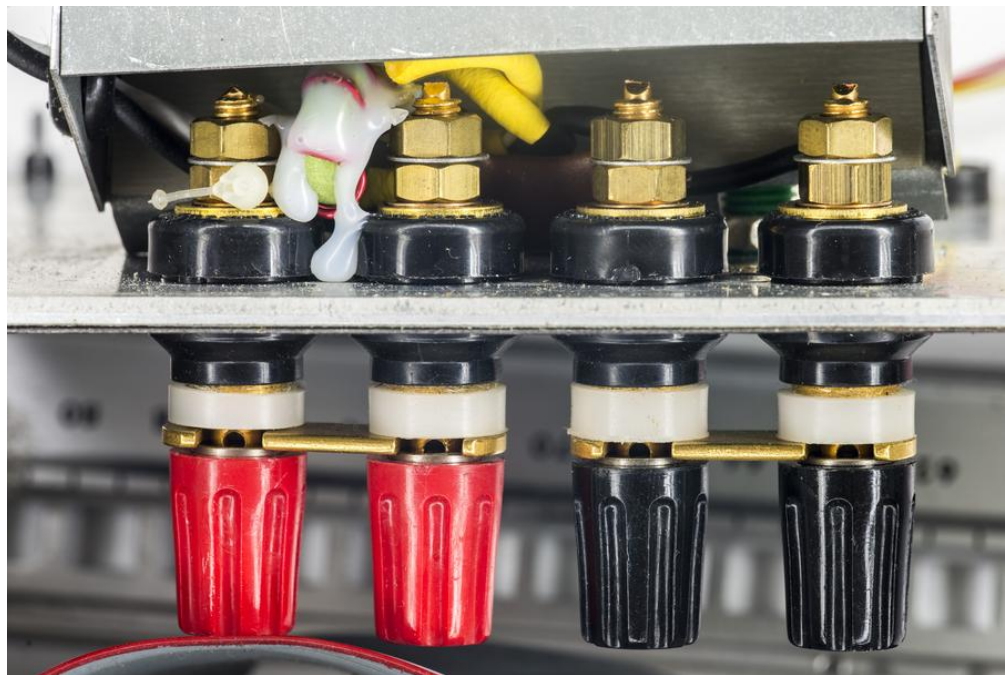

High-current output shunt formed by four brass wires?

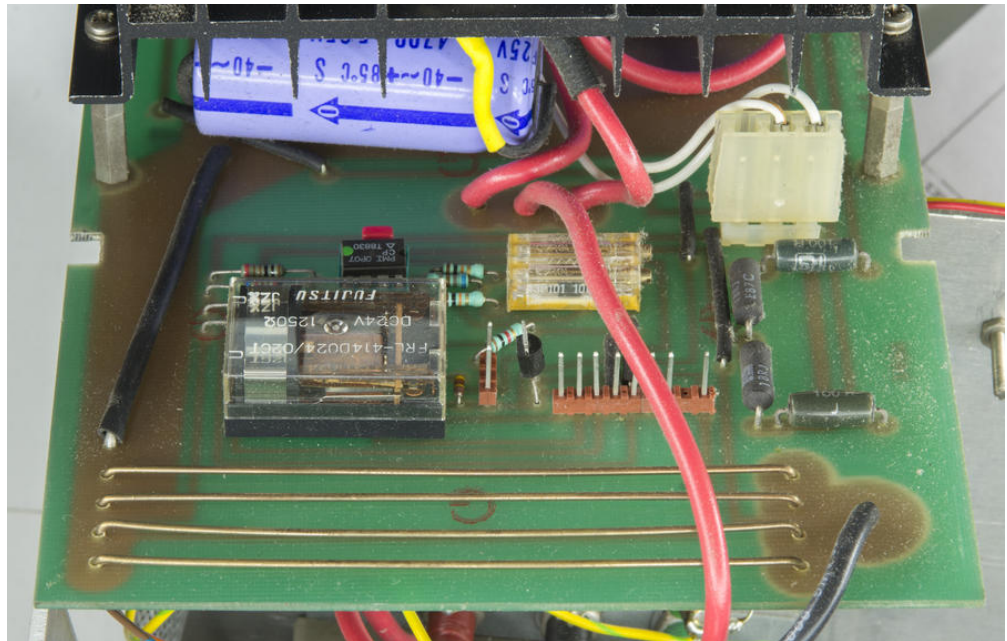

PA with all cables attached:

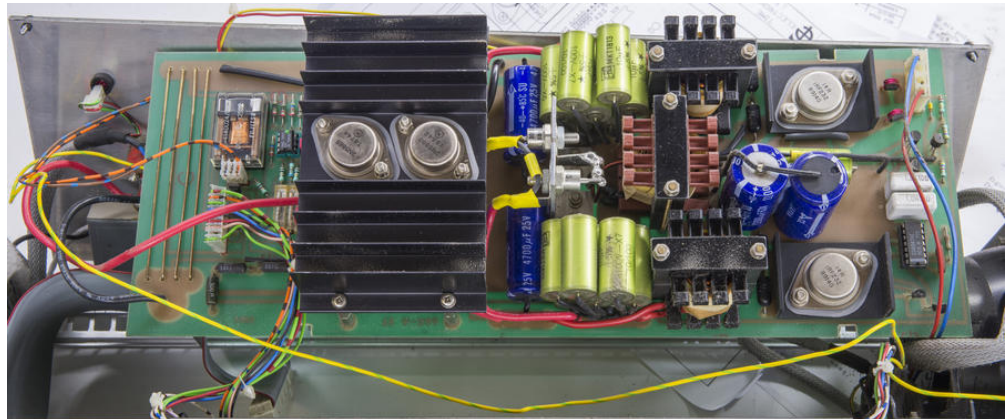

It's bit PITA to measure boards, as everything need to be plugged, seems like I need eurocard extender. Anyone have extra?

Report to moderator Logged

[YouTube](#) | [Metrology IRC Chat room](#) | [Live-cam](#) | Share T&M documentation? [Upload!](#) No MB limit, firmwares, photos.

SeanB
Super Contributor



Posts: 15322
Country:

Re: Teardown/repair : Time Electronics 9823 10ppm/year AC-DC calibrator

Say Thanks Reply Quote

« Reply #12 on: March 20, 2016, 04:14:59 pm »

Not surprising with a 100k pullup resistor, but you are going to be limited by CTR ratio if you reduce the value too much to get a better rise time. You might be able to replace the 100k pull ups with 10k and get a better rise time, but that might fail if you get some with the minimum 12% transfer ratio.

<http://pdf.datasheetcatalog.com/datasheet/siemens/ILD74.pdf>

Probably would be a good idea to look for a pin compatible one with better transfer ratio and which has a faster turn on time. 3us is not exactly fast, and turn off is really slow there, there must be more modern devices in the same package (or in a package that can be made to fit the DIL socket using a small board) that are both faster and higher transfer ratio, so you can drop the pull up resistor to 1k for most of the data lines.

« Last Edit: March 20, 2016, 04:18:20 pm by SeanB »

Report to moderator Logged

Kleinstein
Super Contributor

Posts: 6857

Re: Teardown/repair : Time Electronics 9823 10ppm/year AC-DC calibrator

Say Thanks Reply Quote

« Reply #13 on: March 20, 2016, 07:44:14 pm »

Country: 



The circuit once worked with these slow optocouplers. So there is no need to make them much faster, though a little faster might help. For this just a slightly reduced resistors (e.g. 68 K instead of 100 K) and maybe selecting the couplers to exclude the very poor ones should be good enough. With a 100 K (and in some places even 470 K) resistor such a slow rise time could be normal - it's also rare that old opto-couplers get slower. The normal type of ageing is a lower CTR, thus not fully reaching the low level and at the same time getting slightly faster as they don't reach saturation any more.

Even the poor looking signal shown from the scope should still give valid logic levels.

Besides the optos there is also the possibility for caps getting old. Access to testpoints might be a little hard without a riser board, but still possible. Some of the testpoint even have pins for connectors.

R22 on the DCI board looks really interesting - have not seen a resistor in TO3 before.

[Report to moderator](#)  [Logged](#)

Vgkid

Super Contributor



Posts: 2556

Country: 



 **Re: Teardown/repair : Time Electronics 9823 10ppm/year AC-DC calibrator**

[Say Thanks](#) [Reply](#) [Quote](#)

« **Reply #14 on:** March 20, 2016, 10:56:37 pm »

Quote from: Kleinstein on March 20, 2016, 07:44:14 pm

R22 on the DCI board looks really interesting - have not seen a resistor in TO3 before.

It is a 4 wire power resistor in that case. I have 2 in my CS-152 calibrator. Vishay vhp series.



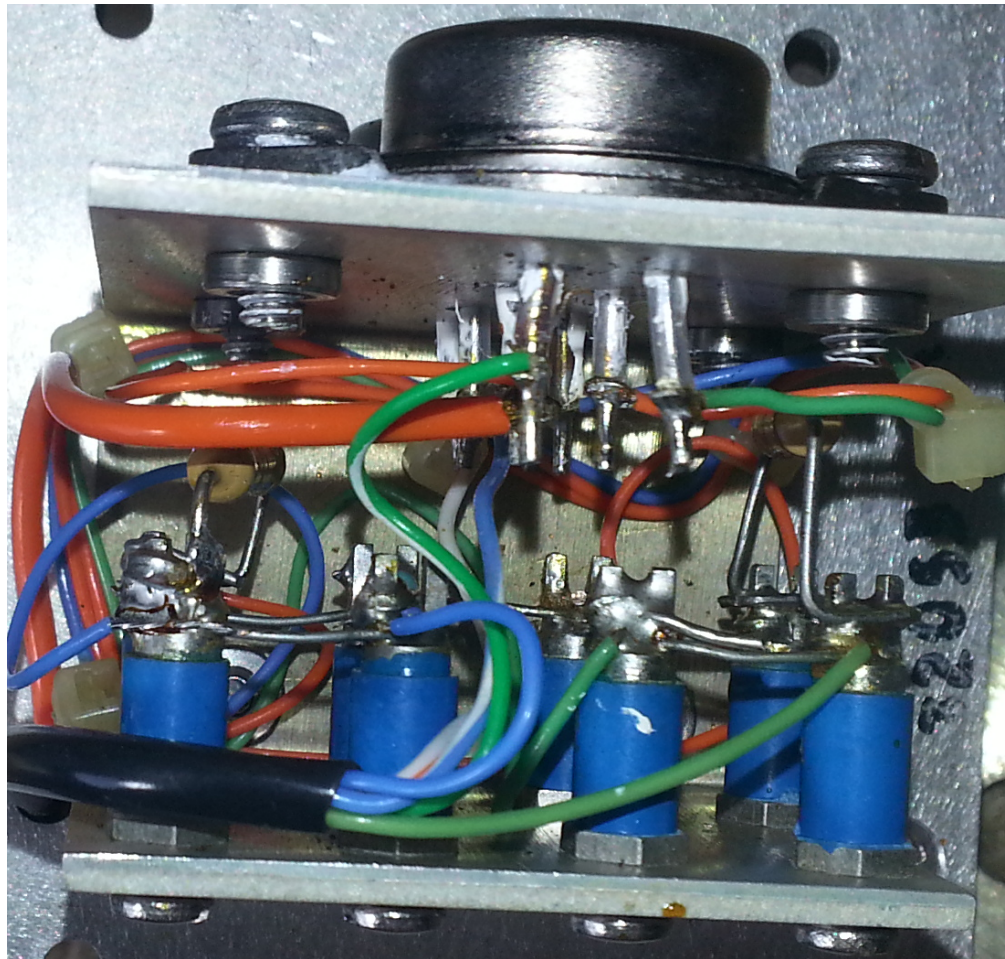

I'm tempted to replace the other 4 resistors, with some that are closer to being in spec/ less drifty with temps.

« Last Edit: March 20, 2016, 11:57:21 pm by Vgkid »

Report to moderator Logged

If you own any North Hills Electronics gear, message me. L&N Fan

TiN

Super Contributor



Posts: 4122

Country:

xDevs.com/live - 24/7 lab feed



Re: Teardown/repair : Time Electronics 9823 10ppm/year AC-DC calibrator

« Reply #15 on: March 21, 2016, 04:17:36 am »

Say Thanks

Reply

Quote

Yep, that's hermetic 4-terminal Vishay foil resistor.

What bothers me in optocouplers that they are specified for 3us both rise and fall times. To test I had breadboard bodge with datasheet conditions, they show still slow ~25us rise times, while fall is ok. Anyway, I just got DK box with set of new ILD74's (Vishay made), so will test those to see if it's better. I know logic levels would be still valid, but if some signals go in wrong time, than register would not latch correct data.

I don't think it's the cap issues here, as - there are not many of them elsewhere expect PSU/PA, and second - output is not adjusting unless I go in big steps in settings, but it should change if I just increase setting e.g. +1mV at 10V range. So far my eval shows that something wrong with DAC generation on REF board, so only MSB 6-bit DAC ladder on DAC PCB working.

If that does not help, I'll have to make some test jig to check DAC and opamps, but that will be likely at weekend.

Today will be Kei2002 repair time, as now all parts are here 😊 I expecting that one go easy.

« Last Edit: March 21, 2016, 04:26:24 am by TiN »

Report to moderator Logged

[YouTube](#) | [Metrology IRC Chat room](#) | [Live-cam](#) | Share T&M documentation? [Upload!](#) No MB limit, firmwares, photos.

amspire

Super Contributor



Posts: 3787

Country:

Re: Teardown/repair : Time Electronics 9823 10ppm/year AC-DC calibrator

« Reply #16 on: March 21, 2016, 01:12:38 pm »

Say Thanks

Reply

Quote

If the optocouplers are just controlling the 6 bit DAC, I cannot see any reason it needs speed.



That potted part of the DAC I think just contains the switches for the 6 bit DAC. Probably discrete MOSFET switches. I assume the 6 bit DAC provides the 6 most significant bits of a 20 bit DAC and the AD7534 provides the lower 14 bits.

It is not as if you have to change the 20 bit DAC output voltage 1000 times a second. 25uS is super fast compared to the 20 bit D/A settling time.

Not sure why the DAC switches are potted but it could be a number of reasons, including thermal reasons or to make it hard for other companies to copy their switch circuit since it is the secret to the 20 bit DAC. The R-2R bit is easy, but getting the switches right is for a 20 bit DAC is extremely hard. That module is Time's magic sauce to make the calibrator work to specification.

The switch resistance has to be constant to within 10 mOhms over temperature, but you cannot just stick in a big MOSFET because you also need off-current leakages of about 0.1nA or less. The leakage current increases exponentially with temperature, so they probably designed for near 1pA OFF leakage at 20 deg C. They are very tough specs to meet. They may be using a small geometry switch with a fairly high ON-resistance such as 0.1 ohms or even 1 ohms, and adding a temperature compensation network to each switch MOSFET to make the switch resistance constant to 10 mOhms over temperature. When the R-2R is calibrated, it will allow for the switch resistance. As long as the switch ON resistance is constant to 10mOhms and the OFF leakage is less then 0.1nA over temperature, the switches will have a no effect on the DAC accuracy.

Richard

« Last Edit: March 21, 2016, 01:55:12 pm by amspire »

Report to moderator Logged

The following users thanked this post: CalMachine

TiN

Super Contributor



Posts: 4122

Country:

xDevs.com/live - 24/7 lab feed



Re: Teardown/repair : Time Electronics 9823 10ppm/year AC-DC calibrator

Say Thanks Reply Quote

« Reply #17 on: March 29, 2016, 03:35:58 pm »

Got new DAC from UTsource, did not help the issue though.

To ensure it's this section issue, I removed DAC's output opamp OP27 which converts DAC's current output into voltage, and connected my [HP 3245A source](#) instead to supply stable voltage instead. And it worked as expected, adjusting source's output changes voltage accordingly, and there is no issue to get exact output voltage.

For example 10V:

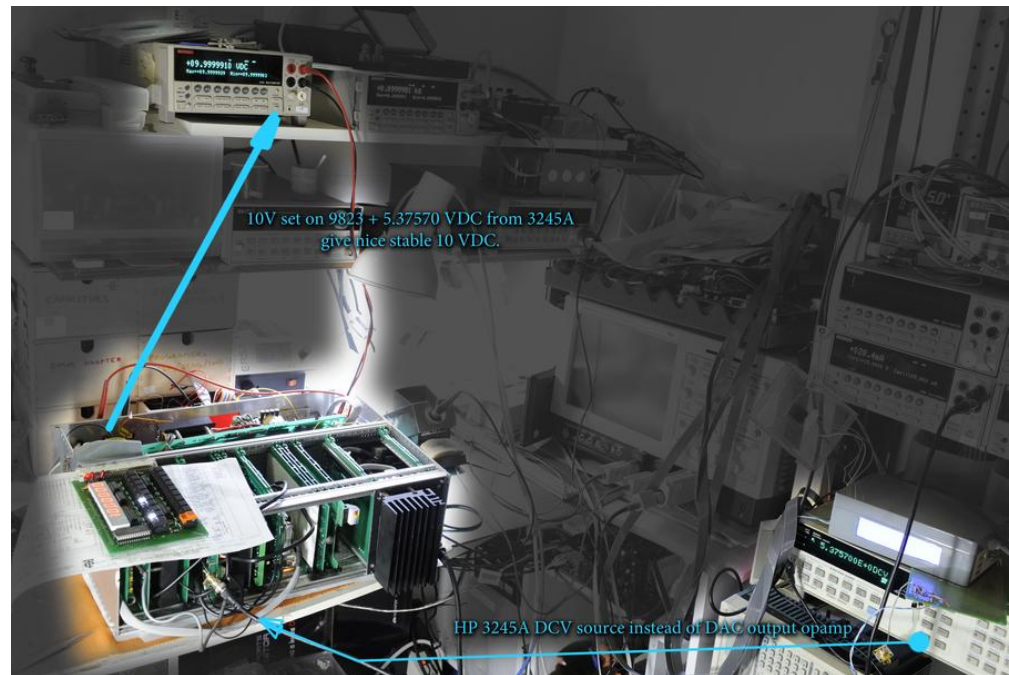

I ran it for 10 minutes, voltage is nice and stable, hovers around 1ppm, even with everything open and hanging around.

« Last Edit: March 29, 2016, 03:46:55 pm by TiN »

Report to moderator Logged

[YouTube](#) | [Metrology IRC Chat room](#) | [Live-cam](#) | Share T&M documentation? [Upload!](#) No MB limit, firmwares, photos.

TiN

Super Contributor



Posts: 4122

Country:

xDevs.com/live - 24/7 lab feed



Re: Teardown/repair : Time Electronics 9823 10ppm/year AC-DC calibrator

« Reply #18 on: March 29, 2016, 04:51:05 pm »

Say Thanks

Reply

Quote

I think I've gotcha.. Here's LA capture on DAC's digital inputs...

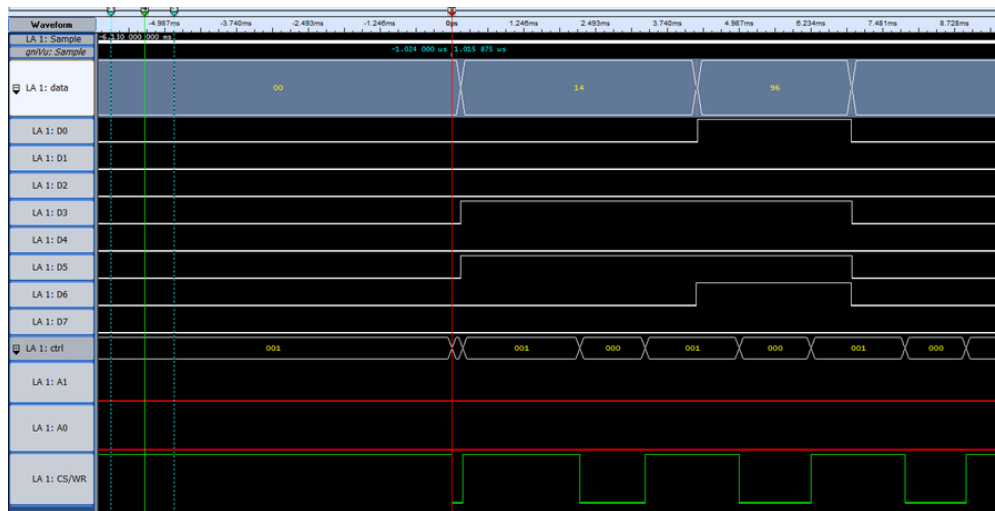

And here's from datasheet:

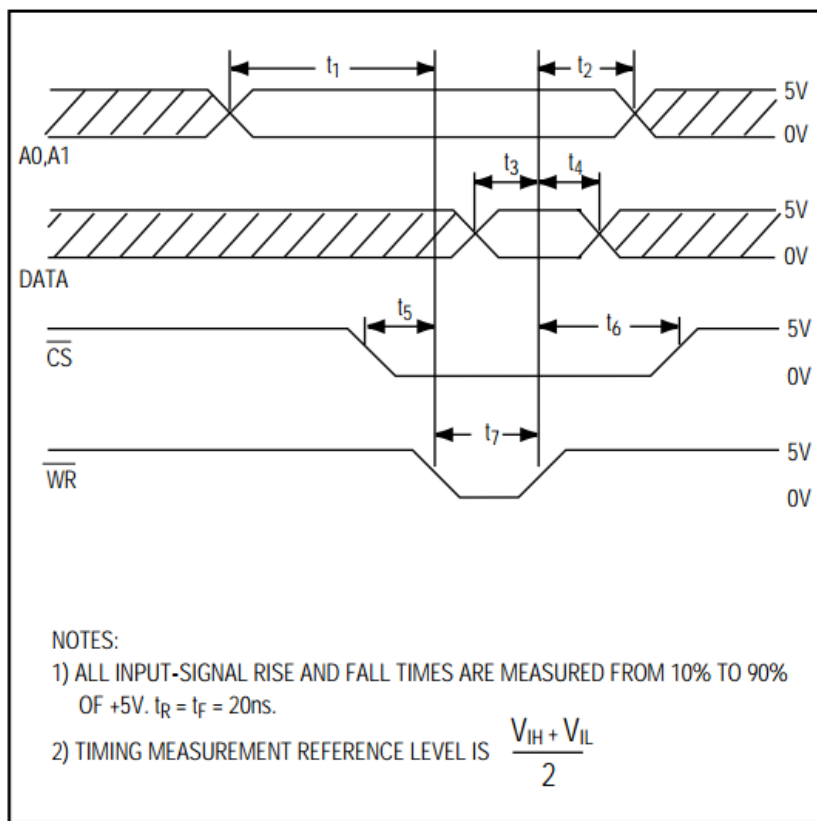

See anything wrong? 😊

Report to moderator Logged

[YouTube](#) | [Metrology IRC Chat room](#) | [Live-cam](#) | Share T&M documentation? [Upload!](#) No MB limit, firmwares, photos.

ManateeMafia

Frequent Contributor



Posts: 719

Country:

Re: Teardown/repair : Time Electronics 9823 10ppm/year AC-DC calibrator

« Reply #19 on: March 29, 2016, 04:57:11 pm »

Say Thanks

Reply

Quote



IC5?

Never mind. Looks like they are supposed to be LO.

« Last Edit: March 29, 2016, 05:02:02 pm by ManateeMafia »

Report to moderator Logged

TiN

Super Contributor



Posts: 4122

Country:

xDevs.com/live - 24/7 lab feed



Re: Teardown/repair : Time Electronics 9823 10ppm/year AC-DC calibrator

« Reply #20 on: March 29, 2016, 05:22:59 pm »

Say Thanks Reply Quote

Nope, i don't think they are supposed to be LO, as we have three write operations (CS goes down three times).
So it should be A[01] to load first 6 bits (which is 0x14 in LA above), then A[10] to load least 8 bits (which is 0x96 in LA above) and last one A[11] to load all 14 bits into DAC (data dont matter here, so 0x00 in capture).

But now instead DAC programmed to 0x1414 then to 0x9696 and then directly to 0x0000, Which is ain't right.

I guess I'll have to get service manual to trace where those A1/A0 go on processor board.

This brings my attention to processor board, where to PIA Motorola 68A21P are located next to CPU. I thought - ok, they are same, and not contain ROM inside, so what happen if I swap them in sockets. Aha, now A0/A1/CS toggling like crazy but Data bus at DAC stay dead zero. Perhaps one of PIA dead?

« Last Edit: March 29, 2016, 05:40:46 pm by TiN »

Report to moderator Logged

[YouTube](#) | [Metrology IRC Chat room](#) | [Live-cam](#) | Share T&M documentation? [Upload!](#) No MB limit, firmwares, photos.

ManateeMafia

Frequent Contributor



Posts: 719

Country:



Re: Teardown/repair : Time Electronics 9823 10ppm/year AC-DC calibrator

« Reply #21 on: March 29, 2016, 05:41:24 pm »

Say Thanks Reply Quote

You're right. I missed the footnote for both address lines being LO at the same time.

Report to moderator Logged

TiN

Super Contributor

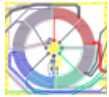

Posts: 4122

Country:

xDevs.com/live - 24/7 lab feed



Re: Teardown/repair : Time Electronics 9823 10ppm/year AC-DC calibrator

« Reply #22 on: April 18, 2016, 05:01:52 pm »

Say Thanks Reply Quote

I think this photo is self-explaining on the progress 😊

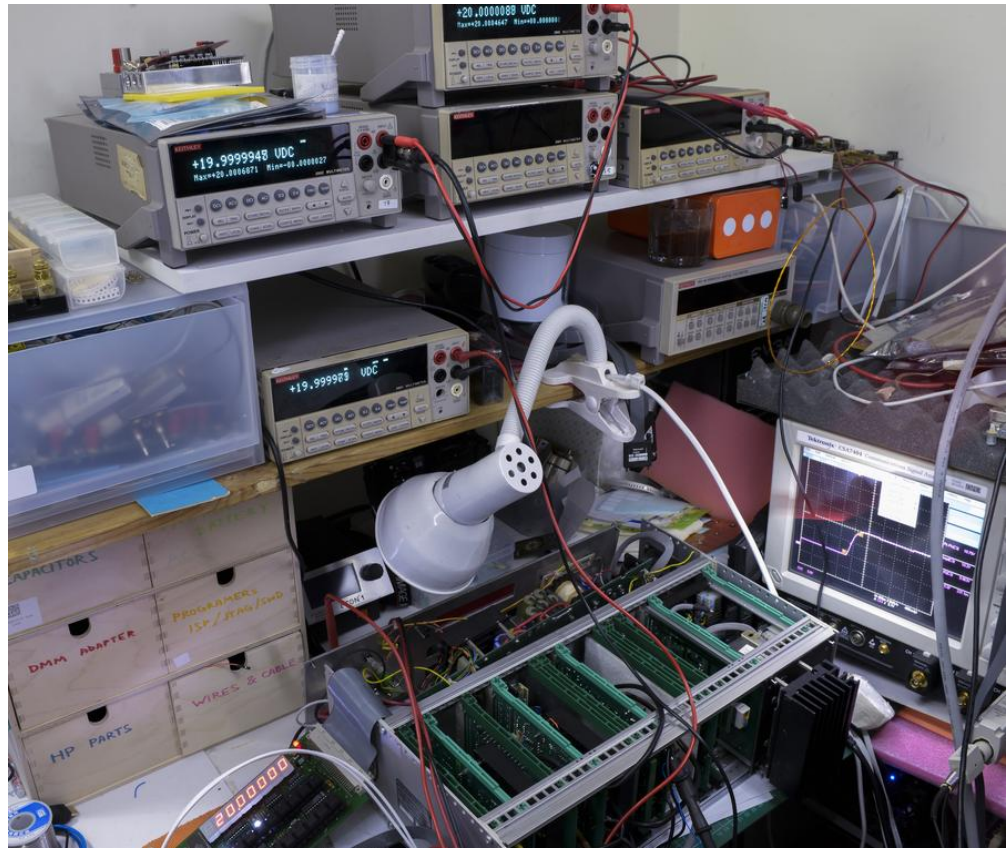

Here's also DAC signaling on jig from RPi connected as controller for test earlier:

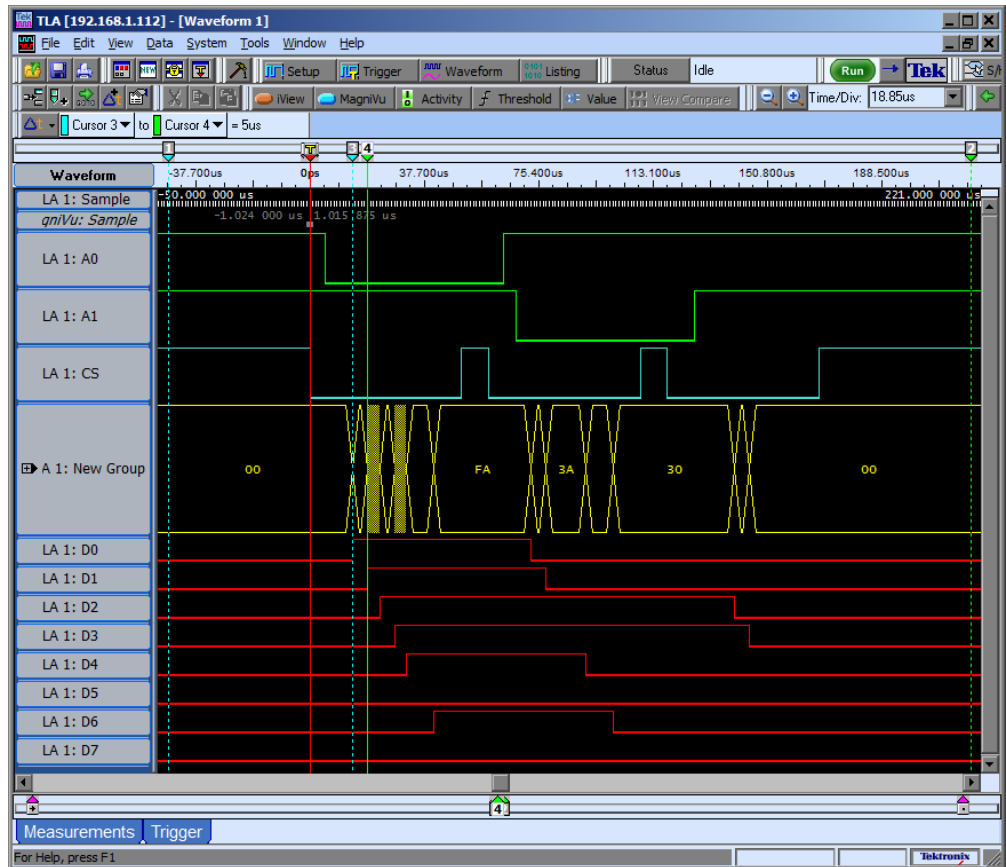

Btw, later DAC I've got from UTSOURCE was either fake or broken. Marking was looking legit though, I'll take macro shots later on of it.
So this is still original AD7534 in the calibrator now.

I hooked output to 3458A for overnight log, will see if it stays nice and stable, even though MFC is in

bits on the table without any covers.

Report to moderator Logged

[YouTube](#) | [Metrology IRC Chat room](#) | [Live-cam](#) | Share T&M documentation? [Upload!](#) No MB limit, firmwares, photos.

TiN

Super Contributor



Posts: 4122

Country:

[xDevs.com/live](#) - 24/7 lab feed



Re: Teardown/repair : Time Electronics 9823 10ppm/year AC-DC calibrator

Say Thanks

Reply

Quote

« **Reply #23 on:** April 24, 2016, 01:35:03 am »

Almost finished assembly, everything seem to be working fine. Here some shots with 10 VDC, kOhm and VAC.

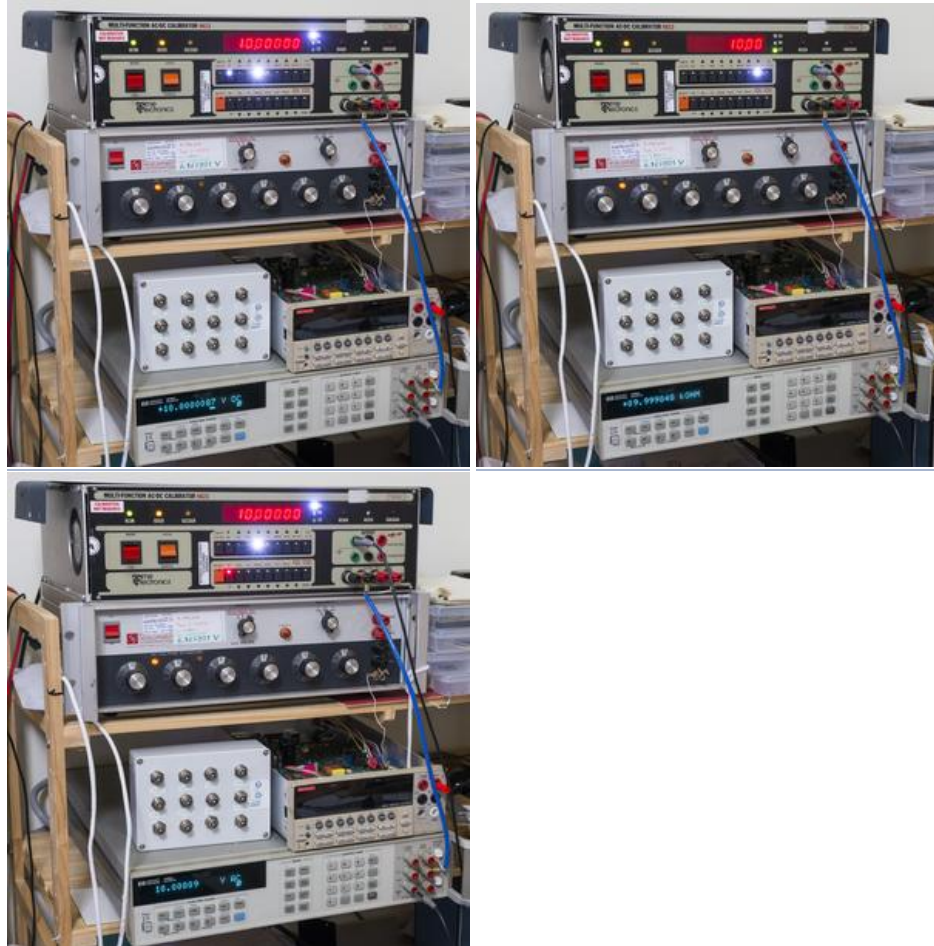

As usual, more pics and details in [my repair worklog](#).

Next step - testing and calibration.

Report to moderator Logged

[YouTube](#) | [Metrology IRC Chat room](#) | [Live-cam](#) | Share T&M documentation? [Upload!](#) No MB limit, firmwares, photos.

ManateeMafia

Frequent Contributor



Posts: 719

Country:



Re: Teardown/repair : Time Electronics 9823 10ppm/year AC-DC calibrator

Say Thanks

Reply

Quote

« **Reply #24 on:** April 24, 2016, 01:44:30 am »

Quote from: TiN on April 24, 2016, 01:35:03 am

... Next step - testing and calibration.

No need for cal, sticker says it is not required. 😊

Great job!

Report to moderator Logged

The following users thanked this post: CalMachine

Vgkid

Super Contributor



Posts: 2556

Country:



nidlaX

Frequent Contributor



Posts: 650

Country:



TiN

Super Contributor



Posts: 4122

Country:

xDevs.com/live - 24/7 lab

feed



Re: Teardown/repair : Time Electronics 9823 10ppm/year AC-DC calibrator

Say Thanks Reply Quote

« Reply #25 on: April 24, 2016, 01:52:59 am »

Nice job. Currently reading through the uploaded documents.

Report to moderator Logged

If you own any North Hills Electronics gear, message me. L&N Fan

Re: Teardown/repair : Time Electronics 9823 10ppm/year AC-DC calibrator

Say Thanks Reply Quote

« Reply #26 on: April 25, 2016, 11:46:27 pm »

Wow, nice bright LEDs you got there. Reminds me of gaming PCs nowadays. Oo

Report to moderator Logged

Re: Teardown/repair : Time Electronics 9823 10ppm/year AC-DC calibrator

Say Thanks Reply Quote

« Reply #27 on: April 26, 2016, 04:18:18 am »

Most still have stock resistors which is way too low for modern leds. It will be fixed, be sure 😊

Initial linearity data, if you want to call that "linearity". 📊

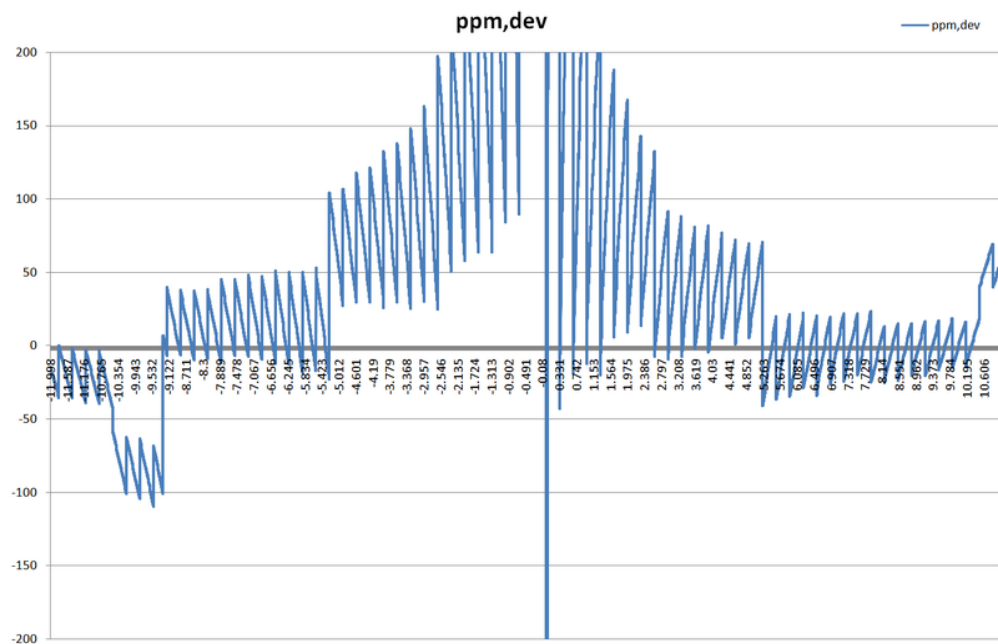

-12 to 12VDC in 1mV steps, measured by 3458A. There are two measurements, with first sample disregarded, 0.5 seconds delay, second sample used for the point. You can see it's not good, so will be investigating.

And here's another run, just -11 to -9V

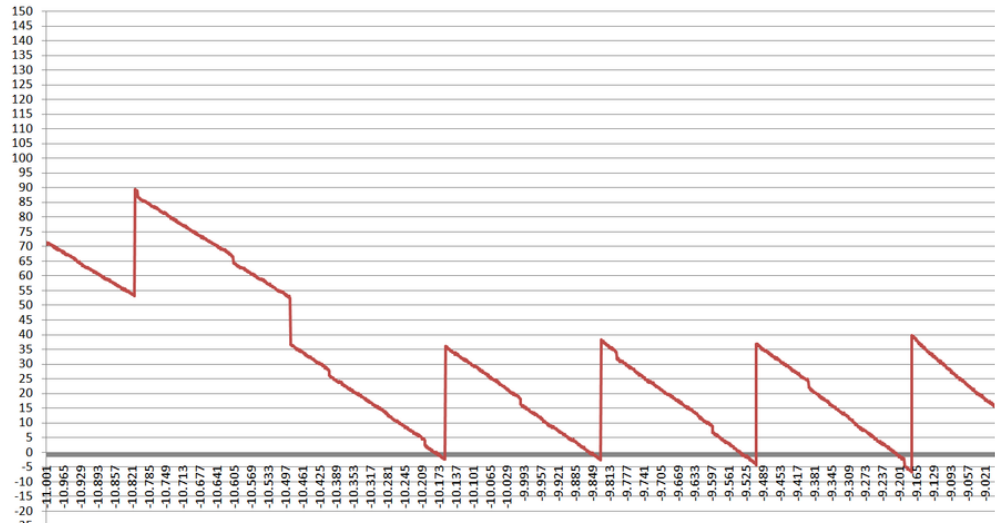

I'm likely to plot same graph, but with LS DAC removed, to get linearity of coarse 6-bit DAC as first step.

Then we will think of what to do with LS DAC. Maybe add bodge board to interface some modern DAC, like LTC2756 instead of original AD7534, if that would be the sticking point..

« Last Edit: April 26, 2016, 04:24:15 am by TiN »

Report to moderator Logged

[YouTube](#) | [Metrology IRC Chat room](#) | [Live-cam](#) | Share T&M documentation? [Upload!](#) No MB limit, firmwares, photos.

amspire

Super Contributor



Posts: 3787

Country:



Re: Teardown/repair : Time Electronics 9823 10ppm/year AC-DC calibrator

Say Thanks Reply Quote

« Reply #28 on: April 26, 2016, 04:49:33 am »

It doesn't look too bad - all I am seeing there is that the MSD resistors need calibrating, and cal for the DAC is a little too high. After calibration, it looks like it will be within a few PPM. Whether the resistors in the DAC drift will be the question then.

Do you have a calibration procedure?

Report to moderator Logged

TiN

Super Contributor

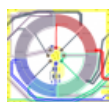

Posts: 4122

Country:

xDevs.com/live - 24/7 lab feed



Re: Teardown/repair : Time Electronics 9823 10ppm/year AC-DC calibrator

Say Thanks Reply Quote

« Reply #29 on: April 26, 2016, 04:53:45 am »

Yes, I have the procedure, but I'm not sure I fully understand it. I'll post it here later on to confirm few things.

Report to moderator Logged

[YouTube](#) | [Metrology IRC Chat room](#) | [Live-cam](#) | Share T&M documentation? [Upload!](#) No MB limit, firmwares, photos.

amspire

Super Contributor



Posts: 3787

Country:



Re: Teardown/repair : Time Electronics 9823 10ppm/year AC-DC calibrator

Say Thanks Reply Quote

« Reply #30 on: April 26, 2016, 05:43:53 am »

Quote from: TiN on April 26, 2016, 04:53:45 am

Yes, I have the procedure, but I'm not sure I fully understand it. I'll post it here later on to confirm few things.

Calibrating the R-2R networks are not the easiest things - two adjustments per bit. Every adjustment can affect every other adjustment.

Report to moderator Logged

Kleinstein

Super Contributor





Posts: 6857

Re: Teardown/repair : Time Electronics 9823 10ppm/year AC-DC calibrator

Say Thanks Reply Quote



« Reply #31 on: April 26, 2016, 10:41:50 am »

Country: 
 





The nonlinearity looks a little strange: besides the large steps with constant spacing there seem to be smaller steps that do not really line up with the rest. Most of it still looks like a problem with the MSB ADC.

So I am afraid there is more needed than just adjusting the MSB ADC and the scale of the LSB ADC.

[Report to moderator](#)   Logged

TiN
Super Contributor
  



Posts: 4122
Country: 
xDevs.com/live - 24/7 lab feed
  

 **Re: Teardown/repair : Time Electronics 9823 10ppm/year AC-DC calibrator**



[Say Thanks](#) [Reply](#) [Quote](#)





« **Reply #32 on:** April 26, 2016, 10:45:28 am »

You meant DAC, surely 😊
That is one of reasons why I want test MS DAC separately, to see if the issue there.

[Report to moderator](#)   Logged

[YouTube](#) | [Metrology IRC Chat room](#) | [Live-cam](#) | Share T&M documentation? [Upload!](#) No MB limit, firmwares, photos.

Dr. Frank
Super Contributor
  

Posts: 1781
Country: 
  

 **Re: Teardown/repair : Time Electronics 9823 10ppm/year AC-DC calibrator**

[Say Thanks](#) [Reply](#) [Quote](#)

« **Reply #33 on:** April 26, 2016, 03:57:33 pm »

The trimming of the 6 MSB of the DAC is very coarse, about 2500/5000ppm for 2R or R, respectively. Therefore, trim resolution and minimum linearity is worse than 10ppm, at best.



So the root cause could simply be a mis - adjustment.





Otherwise, I would first check, if the switches inside the potted case provide exact 0V and 5V to the six 2Rs.
Simply measure on pins 2,3,4 and 13,14,15 of the connector, when switching different values.

A nicer and more precise R2R - DAC is inside the Fluke 3330B, maybe interesting for understanding trimming scheme, and so on.

Frank

[Report to moderator](#)   Logged

amspire
Super Contributor
  

Posts: 3787
Country: 
  

 **Re: Teardown/repair : Time Electronics 9823 10ppm/year AC-DC calibrator**

[Say Thanks](#) [Reply](#) [Quote](#)

« **Reply #34 on:** April 26, 2016, 04:45:49 pm »

Quote from: Dr. Frank on April 26, 2016, 03:57:33 pm

The trimming of the 6 MSB of the DAC is very coarse, about 2500/5000ppm for 2R or R, respectively. Therefore, trim resolution and minimum linearity is worse than 10ppm, at best.

You are right. You would expect that at least the 3 or 4 most significant bits would have a much lower adjustment range. Trusting 5000ppm + 2500ppm to two trimpots for the MSB accuracy is scary. Just a 0.1% drift in both pots could cause up to a 7.5ppm error. It is a preventable source of error. Fluke would never do that.

Quote

So the root cause could simply be a mis - adjustment.

Otherwise, I would first check, if the switches inside the potted case provide exact 0V and 5V to the six 2Rs.
Simply measure on pins 2,3,4 and 13,14,15 of the connector, when switching different values.

The dac switches could have a significant resistance. Ideally the switch resistance should be less then about 40 milliOhm for the MSB - but they could be deliberately using a higher resistance and relying on the switch resistance being fairly constant. With the potting, they could be even combining MOSFET switches with a small temp compensation network. So depending on the other voltages in the R-2R chain, you could see voltage drops across the DAC switches as high as as 0.1mv but hopefully it is lower. The R-2R calibration will compensate for any switch resistance, so resistance is OK, as long as it is constant to about 40 milliOhms over temperature for the MSB down to within about 0.6 ohms over temperature for the LSB.

Quote

A nicer and more precise R2R - DAC is inside the Fluke 3330B, maybe interesting for understanding trimming scheme, and so on.

I am sure Fluke would do it right. I will have a look at the 3330B manual just to see how they do it.

Report to moderator Logged

manganin
Regular Contributor

Posts: 109
Country:

Re: Teardown/repair : Time Electronics 9823 10ppm/year AC-DC calibrator

Say Thanks Reply Quote

« Reply #35 on: June 12, 2016, 09:21:47 pm »

Someone is selling a Time 9823 in German Ebay. (I wouldn't pay the asking price...)

<http://www.ebay.de/itm/291790720463>

Report to moderator Logged

acbern
Frequent Contributor

Posts: 316
Country:

Re: Teardown/repair : Time Electronics 9823 10ppm/year AC-DC calibrator

Say Thanks Reply Quote

« Reply #36 on: June 13, 2016, 09:20:05 am »

Comes with manuals, i dont think its too bad a price actually.

Report to moderator Logged

TiN
Super Contributor

Posts: 4122
Country:
xDevs.com/live - 24/7 lab feed

Re: Teardown/repair : Time Electronics 9823 10ppm/year AC-DC calibrator

Say Thanks Reply Quote

« Reply #37 on: June 13, 2016, 10:09:13 am »

Price is OK for such box. I paid very similar for my broken one and not regretting it. It's rather easy to service this calibrator with its minimalistic design, and also much smaller to big expensive brothers from Fluke/Datron.

Report to moderator Logged

[YouTube](#) | [Metrology IRC Chat room](#) | [Live-cam](#) | Share T&M documentation? [Upload!](#) No MB limit, firmwares, photos.

acbern
Frequent Contributor

Posts: 316
Country:

Re: Teardown/repair : Time Electronics 9823 10ppm/year AC-DC calibrator

Say Thanks Reply Quote

« Reply #38 on: June 16, 2016, 06:27:29 pm »

It sold for that price.

Report to moderator Logged

TiN
Super Contributor

Posts: 4122
Country:
xDevs.com/live - 24/7 lab feed

Re: Teardown/repair : Time Electronics 9823 10ppm/year AC-DC calibrator

Say Thanks Reply Quote

« Reply #39 on: September 16, 2016, 01:30:19 pm »

Sorry for revive, just got 9823 finally assembled, adjusted linearity R2R network in DAC and calibrated vs 3458A (+/-1.5ppm DCV, +/-4ppm ohm).

Did quick manual linearity test on 20V range, and it does not look that impressive AFAIK. Still lightyears better than before, though 😊

Time 9823 after CAL, linearity 20VRNG vs 3458A

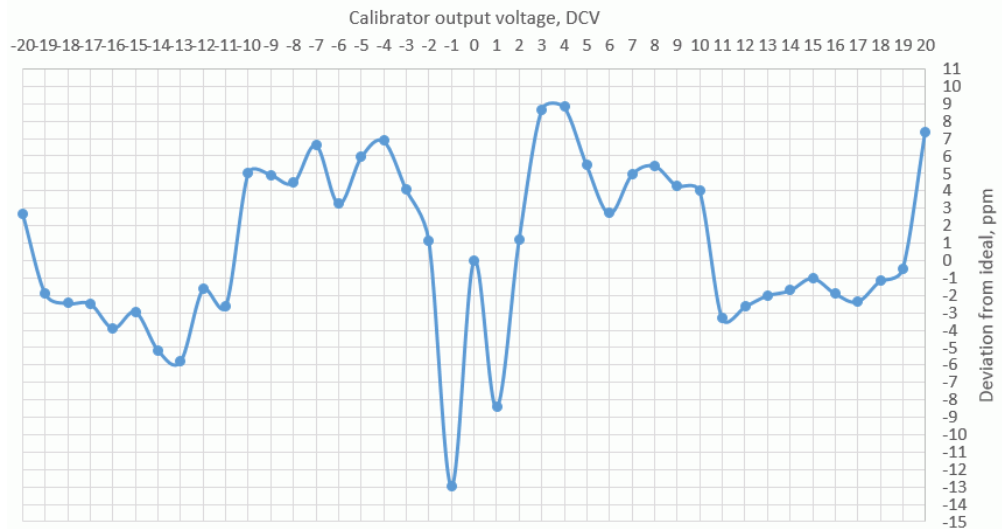

Calibration procedure is PITA as well, trimpots definition and location of actual hardware I have does not match either of two manuals.

Three of more times after whole adjustment (each range and each function) CAL ROM got borked (giving ERROR 7 on power on, with everything locked). Smart me, I had original CALROM backed up, so just reverted it and recal again (another few hours pushing knobs 🤔).

« Last Edit: September 16, 2016, 02:20:55 pm by TiN »

Report to moderator Logged

[YouTube](#) | [Metrology IRC Chat room](#) | [Live-cam](#) | Share T&M documentation? [Upload!](#) No MB limit, firmwares, photos.

mimmus78

Supporter



Posts: 674

Country:



Re: Teardown/repair : Time Electronics 9823 10ppm/year AC-DC calibrator

Say Thanks

Reply

Quote

« Reply #40 on: October 04, 2016, 10:09:14 pm »

Hi TiN, I have a 9823 too ... also mine was broken, going up and down of 100ppm and resetting every 5 minutes.

Lucky me just fiddling with the eurocards have fixed it and now is stable at 2ppm of my K2001 and not resetting anymore.

One strange thing to me is it takes more the 2h to reach it stable point ... this is written on the manual but I usually expect less time for warming up than the one specified on manual. Maybe because reference and ADC DAC are potted it takes some more time for both to reach the final temperature (actual drift from cold to worm is 15ppm). Do you noticed if your unit act like this?

Do you have the processor board schematic page? I got the technical manual but this page is missing and I only have processor board layout.

Thanks for your repair article over this, your work is quite good.

« Last Edit: October 05, 2016, 03:55:07 pm by mimmus78 »

Report to moderator Logged

TiN

Super Contributor

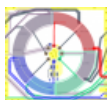

Posts: 4122

Country:

xDevs.com/live - 24/7 lab feed



Re: Teardown/repair : Time Electronics 9823 10ppm/year AC-DC calibrator

Say Thanks

Reply

Quote

« Reply #41 on: October 05, 2016, 04:30:35 am »

There is no oven on reference for 9823, so 2hours, better 4-8h to stabilize internal temperatures sounds reasonable for me. There is no ADC in 9823.

I did not test for warmup time, as I always have it turned a day prior to actual measurements, and 1hour if room temperature change more than 3°C.

I'll check on schematic page, I think I have it. After I scan it, I'll update the article.

Report to moderator Logged

[YouTube](#) | [Metrology IRC Chat room](#) | [Live-cam](#) | Share T&M documentation? [Upload!](#) No MB limit, firmwares, photos.

mimmus78

Supporter

Re: Teardown/repair : Time Electronics 9823 10ppm/year AC-DC calibrator

Say Thanks

Reply

Quote

« Reply #42 on: October 05, 2016, 03:52:19 pm »



Posts: 674
Country:

TiN
Super Contributor



Posts: 4122
Country:

xDevs.com/live - 24/7 lab feed

mikeselectricstuff
Super Contributor

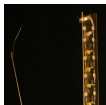

Posts: 12092
Country:



mimmus78
Supporter



Posts: 674
Country:

TiN
Super Contributor

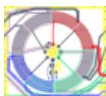

Posts: 4122
Country:

xDevs.com/live - 24/7 lab feed

Well yes I mean DAC not ADC :-).
Anyway this 15ppm drift is still from some sort of warming up ... maybe one day I will check if is reference drifting or some other stuff.

Report to moderator Logged

Re: Teardown/repair : Time Electronics 9823 10ppm/year AC-DC calibrator

Say Thanks Reply Quote

« Reply #43 on: October 06, 2016, 07:16:08 pm »

Ok, my DMM got free tonight, so i hooked it to cold MFC and started logging at 10VDC. First it was +4.7ppm, raised a bit to 5.x ppm in 10 minutes and now dropping down (+1.6ppm now after 15min). I'll post the graph tomorrow.

Report to moderator Logged

[YouTube](#) | [Metrology IRC Chat room](#) | [Live-cam](#) | Share T&M documentation? [Upload!](#) No MB limit, firmwares, photos.

Re: Teardown/repair : Time Electronics 9823 10ppm/year AC-DC calibrator

Say Thanks Reply Quote

« Reply #44 on: October 06, 2016, 08:09:49 pm »

Many years ago I did a few bits of work for Time, including redesigning one of their potted reference blocks - replacing a very complex hand-rolled chopper amp with a more modern single chip device. They usually used zeners for references, which they aged and characterised themselves over many months.

Many of their designs dated back from before you could buy precision parts easily so there were many hand-made circuit elements, that lasted way after they could have been done using off-the-shelf parts. These were considered "special sauce" which was why they were potted.

Report to moderator Logged

Youtube channel: Taking wierd stuff apart. Very apart.
Mike's Electric Stuff: High voltage, vintage electronics etc.
Day Job: Mostly LEDs

The following users thanked this post: mimmus78, CalMachine

Re: Teardown/repair : Time Electronics 9823 10ppm/year AC-DC calibrator

Say Thanks Reply Quote

« Reply #45 on: October 06, 2016, 09:53:39 pm »

I still have this puppy open so I attached a thermocouple to the reference pot stuff and verified that the power on drift is due to this guy warming up. My unit when turned on just go down ... except for the very first minutes I never checked.

I will soon have some GPIB stuff ... so I hope to characterise this behaviour.

Inviato dal mio Nexus 6P utilizzando Tapatalk

Report to moderator Logged

Re: Teardown/repair : Time Electronics 9823 10ppm/year AC-DC calibrator

Say Thanks Reply Quote

« Reply #46 on: October 07, 2016, 04:12:11 am »

Here you go: [Warm-up log](#)
I had logging issue after 4am, so restarted log in morning with reset DCV output to 0V and back 10V. So it's about 10ppm total delta from cold state to warmed up, which seem to be inline with your result.

Report to moderator Logged

[YouTube](#) | [Metrology IRC Chat room](#) | [Live-cam](#) | Share T&M documentation? [Upload!](#) No MB limit, firmwares, photos.



The following users thanked this post: mimmus78

mimmus78
 Supporter



Posts: 674
Country:

Re: Teardown/repair : Time Electronics 9823 10ppm/year AC-DC calibrator

Say Thanks Reply Quote

« Reply #47 on: October 09, 2016, 10:13:30 pm »

And this is mine 9823 warm-up curve, all reading by a K2001.



TE9823 Warmup curve.png (230.46 kB, 2250x1212 - viewed 151 times.)

« Last Edit: October 09, 2016, 11:49:42 pm by mimmus78 »

Report to moderator Logged

mimmus78
 Supporter



Posts: 674
Country:

Re: Teardown/repair : Time Electronics 9823 10ppm/year AC-DC calibrator

Say Thanks Reply Quote

« Reply #48 on: January 22, 2017, 12:01:13 am »

So after few weeks my unit developed another intermittent series of problems.

Those problems where:

- output went crazy now and there
- calibrator has also some problems throwing "operator error" even when set to resistor functions and no leads where connected
- started again to auto-reset.

So I decided to replace the PIA too.

After replacing those two chips it seems:

- the "DAC system" is still missing some bit now and there but it's really not so often as was before
- auto-rest and unjustified "operator error" are gone

Replacing PIA seems to have cured some of my problems but not all.

I also just discovered problems with the .. too.
Every time someone speaks to the bus the calibrator reset.
GPIB interface is also not working.

The saga will continue ...

Report to moderator Logged

Pages: 1 2 [All] [Go Up](#)

[REPLY](#) [NOTIFY](#) [MARK UNREAD](#) [SEND THIS TOPIC](#) [PRINT](#) [SEARCH](#)
« previous next »

Share me



EVBlog Electronics Community Forum » Electronics » Metrology » Teardown/repair : Time Electronics 9823 10ppm/year AC-DC calibrator

[LINK TO CALENDAR](#)

Jump to: => [Metrology](#) [go](#)

Quick Reply

BUDGET MULTIMETERS !!
 ANENG, UNI-T and more...

SMF 2.0.15 | SMF © 2017, Simple Machines
Simple Audio Video Embedder
SMFAds for Free Forums
[XHTML](#) [RSS](#) [Mobile](#) [WAP2](#)