

# Strain Gage Instrumentation

## Micro-Measurements

Stress Analysis Testing  
Structural Testing  
Materials Testing



INTERACTIVE Data Book  
VMM-DB0107-1106

Click on the VPG logo on any datasheet to go to the contents page for that section.

Click on the VPG logo on any contents page to go to the main table of contents page.

## *The Americas*

**United States** **Vishay Precision Group – Micro-Measurements**  
P.O. Box 27777 • Raleigh, NC 27611  
Ph: +1-919-365-3800 • Fax: +1-919-365-3945  
E-mail: mm.us@vishaypg.com

## *Asia*

**P.R. China** **Vishay Precision Group – Micro-Measurements**  
A8220, Shanghai Jia Hua Business Center  
No. 808 Hong Qiao Road • Shanghai 200030  
Ph: +86-21-6448-6090, Ext. 6098 • Fax: +86-21-6448-6070  
E-mail: mm.cn@vishaypg.com

## *Europe*

**France** **Vishay Precision Group – Micro-Measurements**  
16 Rue Francis Vovelle • 28000 Chartres  
Ph: +33-2-37-33-31-20 • Fax: +33-2-37-33-31-29  
E-mail: mm.fr@vishaypg.com

**Germany** **Vishay Precision Group – Micro-Measurements**  
Tatschenweg 1 • 74078 Heilbronn  
Ph: +49-7131-39099-0 • Fax +49-7131-39099-229  
E-mail: mm.de@vishaypg.com

**Spain** **Vishay Precision Group – Micro-Measurements**  
C/Copenhagen, N°4, 6 y 8 - Planta 1ª - Oficina 12 • Edificio Al Andalus  
Polígono Európolis • 28232 Las Rozas, Madrid  
Ph: +34-916-407-624 • Fax: +34-916-375-601  
E-mail: mm.es@vishaypg.com

**United Kingdom** **Vishay Precision Group – Micro-Measurements**  
Stroudley Road • Basingstoke • Hampshire RG24 8FW  
Ph: +44-(0)125-646-2131 • Fax: +44-(0)125-647-1441  
E-mail: mm.uk@vishaypg.com

# Strain Gage Instrumentation

**Vishay Precision Group  
Micro-Measurements**

P.O. Box 27777  
Raleigh, NC 27611  
U.S.A.

**Phone:** +1-919-365-3800

**Fax:** +1-919-365-3945

**[www.micro-measurements.com](http://www.micro-measurements.com)**

## Disclaimer

ALL PRODUCTS, PRODUCT SPECIFICATIONS AND DATA ARE SUBJECT TO CHANGE WITHOUT NOTICE.

Vishay Precision Group, Inc., its affiliates, agents, and employees, and all persons acting on its or their behalf (collectively, "Vishay Precision Group"), disclaim any and all liability for any errors, inaccuracies or incompleteness contained herein or in any other disclosure relating to any product.

The product specifications do not expand or otherwise modify Vishay Precision Group's terms and conditions of purchase, including but not limited to, the warranty expressed therein.

Vishay Precision Group makes no warranty, representation or guarantee other than as set forth in the terms and conditions of purchase. **To the maximum extent permitted by applicable law, Vishay Precision Group disclaims (i) any and all liability arising out of the application or use of any product, (ii) any and all liability, including without limitation special, consequential or incidental damages, and (iii) any and all implied warranties, including warranties of fitness for particular purpose, non-infringement and merchantability.**

Information provided in datasheets and/or specifications may vary from actual results in different applications and performance may vary over time. Statements regarding the suitability of products for certain types of applications are based on Vishay Precision Group's knowledge of typical requirements that are often placed on Vishay Precision Group products. It is the customer's responsibility to validate that a particular product with the properties described in the product specification is suitable for use in a particular application.

No license, express, implied, or otherwise, to any intellectual property rights is granted by this document, or by any conduct of Vishay Precision Group.

The products shown herein are not designed for use in life-saving or life-sustaining applications unless otherwise expressly indicated. Customers using or selling Vishay Precision Group products not expressly indicated for use in such applications do so entirely at their own risk and agree to fully indemnify Vishay Precision Group for any damages arising or resulting from such use or sale. Please contact authorized Vishay Precision Group personnel to obtain written terms and conditions regarding products designed for such applications.

Product names and markings noted herein may be trademarks of their respective owners.

Instrument Selection ..... 2

**Strain Indicators and Calibrators**

P3 ..... 6

D4 ..... 9

1550A ..... 11

Model V/E-40 ..... 13

**Signal Conditioning Amplifiers**

A2 ..... 16

2100 System ..... 20

2200 System ..... 24

2300 System ..... 28

**Digital Data Systems**

Software for Stress Analysis Testing ..... 34

System 5000 ..... 37

System 6000 ..... 41

System 7000 ..... 50

**Special-Purpose Instruments**

Model 1300 ..... 58

Model 700 ..... 60

RS-200 ..... 62

## Considerations for Instrument Selection

### STRAIN INDICATORS AND CALIBRATORS



Basic instrumentation requirements call for stability, accuracy and high resolution when making measurements under static loading conditions, and particularly where measurements are to be taken over long periods of time. Micro-Measurements offers our Model P3 Strain Indicator and D4 Data Acquisition Conditioner to meet these demanding criteria.

The Model P3 Strain Indicator and Recorder is a portable, battery-operated instrument while our D4 is a USB-powered instrument that connects to a personal computer. Both are capable of simultaneously accepting four inputs from quarter-, half-, and full-bridge strain-gage circuits, including strain-gage-based transducers. A highly stable measurement circuit, regulated bridge excitation supply, and precisely settable gage factor enable measurements of  $\pm 0.1\%$  accuracy and 1 microstrain resolution. The P3 can also be configured and operated directly from your PC with a separate software application included with each instrument. The D4 also has a separate software application and is programmable for custom applications.

### SIGNAL CONDITIONING AMPLIFIERS



When signals are produced by dynamically applied loads at frequencies above 0.1 Hz, or are transients, measuring instrumentation requires adequate frequency response, and a wide amplifier gain range for output to the appropriate recording or display device. Such an instrument consists of an amplifier and signal conditioner with a built-in or shared power supply. Individual units are normally required for each channel when simultaneous recording or multiple channels are needed. With the output sent to a suitable display device, signal conditioning amplifiers can be used for making long-term measurements under static loading conditions, when maximum stability and accuracy are not primary considerations.

The A2, 2100, 2200, and 2300 Systems accept low-level signals, and condition and amplify them into high-level outputs suitable for multiple channel, simultaneous, dynamic recording. All of these systems can be used in conjunction with a variety of recording devices.

### DIGITAL DATA SYSTEMS



Depending on their design, digital data systems can be used for measurement of static, dynamic, or both kinds of signals. Micro-Measurements offers three digital data systems, each controlled with StrainSmart® software and other third-party software.

System 5000 is a complete test and measurement data system for stress analysis and structural materials testing. Each 5100B scanner provides fast static data acquisition and digitization of 20 channels of various inputs. System flexibility allows for mixing types of input cards within a scanner for various input types including strain gages, thermocouples, LVDTs, load cells, and other transducer high level inputs. The system can be built up to 1200 channels, utilizing 60 scanners. Scan rates of up to 100 samples per second are available for simultaneous reading of all sensor inputs.

System 6000 is used for dynamic signals with scanning rates up to 10,000 samples per second per channel and up to 1200 channels. System 6000 provides individual analog-to-digital conversion on each channel and simultaneous sampling data acquisition for all channels. Selectable, digital Finite Impulse Response (FIR) low-pass filtering is incorporated into each instrumentation channel to meet a variety of testing requirements. Custom filters are also available.

System 7000 is a high performance dynamic data acquisition instrument with measurement accuracy of  $\pm 0.05\%$  of full scale. Each sensor card employs a 24-bit analog to digital converter enabling 0.5 microstrain resolution. Scan rates up to 2048 samples per second are available for simultaneous reading of all sensor inputs. A combination of analog and flexible Finite Impulse Response (FIR) filters are available to provide adequate anti-alias filtering at all scanning rates. Electronically selectable bridge completion resistors allow the user to choose between 120-, 350-, and 1000-ohm strain gages through software selection. System 7000 is capable of self-calibration with a removable calibration reference.

### Considerations for Instrument Selection

#### INSTRUMENT SELECTION GUIDE

<b>STRAIN INDICATORS AND CALIBRATORS</b>						
Instrument	Display	Operation	Bridge Excitation	Input Power	Multi-Channel	Remarks
P3	Digital	Manual, Direct-Reading	1.5 VDC	Battery, USB, or AC Adapter	Selectable	Portable, 4-Channel, 0.1% Accuracy
D4	Host PC	PC Controlled via USB	1.5 VDC	USB	Selectable	4-Channel, 0.1% Accuracy

<b>SIGNAL CONDITIONING AMPLIFIERS</b>						
Instrument	Frequency Response <sup>(1)</sup>	Output (±)	Amplifier Gain	Bridge Excitation	Input Power	Remarks
A2	DC 110 kHz -3 dB	10V	125-2500	DC 0.0-10V	DC (AC optional)	General-Purpose Signal Conditioner with Digital Control
2100	DC 15 kHz -3 dB	10V at 100 mA	Continuously Variable 1-2100	DC 0.5-12V	AC	High Performance Amplifier for Simultaneous Dynamic Recording
2200	DC 50 kHz -0.5 dB DC 100 kHz -3 dB	10V at 10 mA and 1 VRMS at 10 mA	Continuously Variable 1-3300	DC: 0.5-15V or 0.5-30 mA	AC	High Performance, for Demanding Environments
2300	DC 60 kHz -0.5 dB DC 145 kHz -3 dB	10V	Continuously Variable 1-11,000	DC: 0.7-15V (11 steps) 0.2-7V Variable	AC	High-Frequency Response Multi-Feature Signal Conditioner

(1) Typical—see specific product bulletin and/or instruction manual for detailed performance specifications.

<b>DIGITAL DATA SYSTEMS</b>						
Instrument	Operating Mode <sup>(2)</sup>	Channels	Scanning Rate	Bridge Excitation <sup>(3)</sup>	Input Power	Remarks
5000 (5100)	Stationary, Online	5-1200 (in increments of 5)	1-100 Samples/Sec/ Channel	0-10 VDC Programmable	AC	5-Hz Low-Pass Filter
6000 (6100)	Stationary, Online	1-1200	10-10,000 Samples/Sec/ Channel	0-10 VDC Programmable	AC	Programmable Digital Filters to 4 kHz
6000 (6200)	Remote, Stand-Alone	1-1200	10-10,000 Samples/Sec/ Channel	0-10 VDC Programmable	DC (AC Optional)	Programmable Digital Filters to 4 kHz
7000	Stationary, Online	Unlimited (in increments of 8)	10-2048 Samples/Sec/ Channel	0-10 VDC Programmable	DC (AC Optional)	Programmable Digital Filters to 800 Hz

(2) All systems can be operated with StrainSmart software for data acquisition, storage, reduction, and presentation, or with other third-party software.

(3) Strain gage cards only.

Considerations for instrument selection are provided on the previous page for all general-purpose instrumentation and data systems produced by Micro-Measurements. Additionally, our Applications Engineering staff is always available to assist you in selecting the right instrument for your specific applications.







P3 .....	6
D4 .....	9
1550A .....	11
V/E-40 .....	13

# Strain Indicators and Calibrators

## Strain Indicator and Recorder

### FEATURES

- Four input channels
- Direct reading LCD display
- On-board data storage
- 0 to 2.5 VDC analog output
- Quarter-, half-, and full-bridge circuits
- Built-in bridge completion
- 120-, 350-, and 1000-ohm dummy gages
- Automatic zero-balancing and calibration
- Intuitive, menu-driven operations
- USB data link
- Operation from keypad or PC
- Portable, lightweight, and rugged
- Battery, USB, or line-voltage power
- Optional 10-pin transducer connectors



### DESCRIPTION

The Model P3 Strain Indicator and Recorder is a portable, battery-operated instrument capable of simultaneously accepting four inputs from quarter-, half-, and full-bridge strain-gage circuits, including strain-gage-based transducers. Water-resistant grommets in the hinged cover allow the lid to be closed with leadwires attached. Designed for use in a wide variety of physical test and measurement applications, the P3 functions as bridge amplifier, static strain indicator, and digital data logger.

The Model P3 Strain Indicator and Recorder, utilizing a large LCD display for readout of setup information and acquired data, incorporates many unique operating features that make it the most advanced instrument of its kind. An extensive, easy-to-use menu-driven user interface operates through a front-panel keypad to readily configure the P3 to meet your particular measurement requirements. Selections include active input and output channels, bridge configuration, measurement units, bridge balance, calibration method, and recording options, among others.

Standard sensor input connection is via eccentric-lever-release terminal blocks. Optional transducer connection is available via side-mounted bayonet locking circular connectors.

Data, recorded at a user-selectable rate of up to 1 reading per channel per second, is stored on a removable flash card and is transferred by USB to a host computer for subsequent storage, reduction and presentation with the supplied software.

The P3 can also be configured and operated directly from your PC with a separate software application included with each instrument. Additionally, a full set of ActiveX components is provided for creating custom applications in any language supporting ActiveX.

A highly stable measurement circuit, regulated bridge excitation supply, and precisely settable gage factor enable measurements of  $\pm 0.1\%$  accuracy and 1 microstrain resolution. Bridge completion resistors of 120, 350 and 1000 ohms are built in for quarter-bridge operation. Also, input connections and switches are provided for remote shunt calibration of transducers and full-bridge circuits.

The P3 operates from two readily available D cells. Battery life depends upon mode of operation but ranges up to 600 hours of continuous use for a single channel. It can also be powered by connection to an external battery or power supply, a USB port on a PC or with an optional external line-voltage adapter, the Model P3-A105.

## Strain Indicator and Recorder

### HARDWARE SPECIFICATIONS

All specifications nominal or typical at +23°C unless noted.

#### Inputs

Eccentric-lever-release terminal blocks accept up to four independent bridge inputs. Accommodates 16-28 AWG (1.3 to 0.35 mm diameter) wire.

The Transducer Option includes four 10-pin bayonet locking circular connectors mounted on the side of the case and wired in parallel to the lever-release terminal blocks. The supplied mating connector has a 0.046 inch (1.17 mm) diameter solder well.

#### Bridge Configurations

Quarter-, half-, and full-bridge circuits. Internal bridge completion provided for 120Ω, 350Ω and 1000Ω quarter bridges, 60 to 2000Ω half or full bridge.

#### Display

Full dot-matrix structure with 128 dots x 64 dots FSTN positive, gray transfective LCD with backlight. Display update is twice a second.

#### Data Conversion

High-resolution sigma-delta converter. 60 Hz or 50 Hz noise rejection. User selectable.

#### Basic Range

±31,000 microstrain (±1 microstrain resolution) at Gage Factor = 2.000

#### Accuracy

±0.1% of reading ±3 counts. (Normal mode operation at Gage Factor = 2.000)

#### Gage Factor Settings

Range 0.500 to 9.900

#### Balance

Single key operation to initiate automatic software balance

#### Bridge Excitation

1.5 VDC nominal. Readings are fully ratiometric, and not degraded by variation in excitation voltage

#### Communication Interface

Universal Serial Bus with type B connector. Used for transferring stored data and firmware.

#### Data Storage

Media: Removable Secure Digital or Multimedia Card (2GB max).

Data Recording Rate: 1 reading per second maximum.

#### Calibration

Shunt calibration across each dummy resistor to simulate 5000 microstrain (±0.1%). Remote calibration supported via accessible switch contacts at input terminal block.

#### Analog Output

BNC connector. 0 to 2.5V maximum output. Device impedance of 2000Ω or greater. 480 samples/second DAC output update rate.

#### Power

Internal battery pack using two "D" cells. Battery life up to 600 hours (single channel, normal mode.) Can also be powered from USB or by external battery or other power source of 6 to 15 VDC. AC adapter optional (Model P3-A105).

#### Operational Environment

Temperature 0 to + 50°C. Humidity up to 90% RH, noncondensing

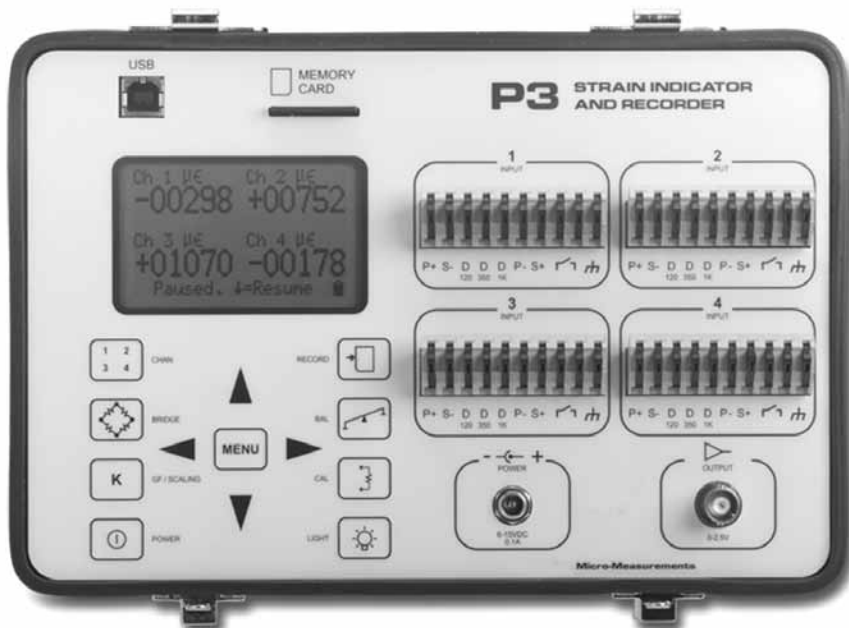

## Strain Indicator and Recorder

**FIRMWARE FEATURES****Display Update Rate**

2 readings per second

**Recording Rates**

Up to 64 data files

Automatic recording

1 reading every 1 to 3600 seconds

Individually selectable per channel

Manual recording

Automatic date/time stamping

**Scaling**

Automatic scaling for microstrain, based upon gage factor, with nonlinearity correction based upon bridge type

Automatic calculation of mV/V

Linear scaling for other engineering units

**Units**

$\mu\epsilon$	g	rpm	hp
mV/V	lbf	m	deg
psi	lb	s	rad
ksi	kg	A	oz
GPa	in	N	mV
MPa	mm	V	m/s <sup>2</sup>
Pa	mil	Ohms	ton

**Bridge Types**

Quarter bridge

Half bridge, adjacent arms, equal and opposite strains

Half bridge opposite arms equal strains

Shear bridge, 2 active arms

Poisson half bridge

Full bridge 4 fully active arms

Shear bridge, 4 active arms

Full bridge, Poisson gages in opposite arms

Full bridge, Poisson gages in adjacent arms

Undefined full bridge

Undefined half bridge/quarter bridge

**Bridge Balance**

Automatic

Manual offset adjust

Disabled (Raw offset)

**Backlight Control**

Programmable on time while in run mode

5, 15 or 60 seconds

Manual off/on

If illuminated, backlight will remain illuminated while operating menus

**Software Adjustable Contrast****Operating Modes**

Normal mode

Analog output (any one of four channels)

**Data Link**

USB interface

Windows-based P3 software provided for control and data storage

No device driver required (treated as an HID device)

**Real-time Clock****System Calibration/Verification**

Requires Model 1550A Strain Indicator calibrator or other compatible calibrator

Calibration date stored in flash memory

**Firmware Upgradeable**View Showing  
Optional Transducer  
Input Connectors

## Data Acquisition Conditioner

### FEATURES

- Four input channels with RJ-45 connectors
- Hardware and software support for quarter-, half- and full-bridge circuits
- Built-in precision bridge completion for 120-, 350-, and 1000-ohm half and quarter bridges
- 8-Hz sampling rate
- Intuitive, user-friendly software communicates with up to six D4 units simultaneously
- Automatic and manual zero-balance and calibration
- Full control of all functions via USB Interface
- Portable, lightweight, and rugged design
- Powered via USB interface
- Programmable for custom applications

### DESCRIPTION

The Model D4 Data Acquisition Conditioner is a portable, USB-powered precision instrument for use with resistive strain gages and strain gage-based transducers.

The Model D4 has four channels of data acquisition. Connection to each channel is via a RJ-45 connector. Each channel of input accepts either full-, half-, and quarter-bridge configuration. All required bridge completion components for 120-, 350-, and 1000-ohm bridges are supplied.

Operation of the Model D4 is performed with commands sent via the USB connection. User-friendly application software is provided to control the D4 with a MS Windows-based personal computer. The software connects with up to six D4 units to create a system of up to 24 channels. The D4 units can be connected directly to a computer through its USB ports or through a USB hub.

A Programmer's Reference Kit that includes a Programmer's Reference Manual, a NI LabVIEW instrument driver, and programming examples to simplify writing custom applications is also included. The D4 is also supplied with a calibration software utility that allows calibration of the D4 via the USB interface. The application software, Programmer's Reference Kit, and Instruction Manual are on a single CD included with the D4 unit.

The Model D4 uses modern digital signal processing technology to provide excellent noise rejection and stability. Proprietary scaling and linearization algorithms provide unsurpassed measurement accuracy for strain gage bridge measurements.



### SPECIFICATIONS

*Note: Performance may be degraded at high levels of repetitive electrostatic discharge; however, no damage to the unit will occur.*

#### INPUT CONNECTIONS

**Type:** RJ-45 Modular  
**Quantity:** Four

#### BRIDGE CONFIGURATIONS

**Types:** Quarter-, half-, and full bridges  
**Bridge Impedance:** 60 to 2000  $\Omega$   
**Internal Bridge Completion:**  
Quarter bridge: 120  $\Omega$ , 350  $\Omega$  and 1000  $\Omega$   
 $\pm 0.01\%$   
Half bridge: 1000  $\Omega$   $\pm 0.01\%$

#### DATA CONVERSION

**A/D Converter:** Delta-sigma with integral chopper-stabilized programmable gain instrumentation amplifier

**Resolution:** 24 bits. Noise-free resolution: 18 bits typ.

**Filter:** Integrated linear phase FIR Sinc5 filter followed by a Sinc3 filter with a programmable decimation rate. Software selectable output rate provides >120 dB rejection of 50 or 60 Hz and higher level harmonics.



Front Panel

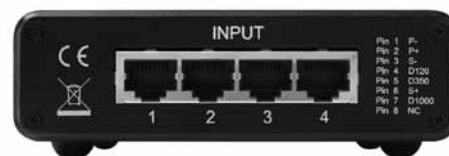

Back Panel

## Data Acquisition Conditioner

**MEASUREMENT RANGE/RESOLUTION**

**Strain Range:**  $\pm 31,000 \mu\epsilon$  at GF = 2.000.  
( $\pm 15.5$  mV/V)

**Resolution:**  $\pm 1 \mu\epsilon$  at GF = 2.000 ( $\pm 0.0005$  mV/V)

**MEASUREMENT ACCURACY**

$\pm 0.1\%$  of reading  $\pm 3$  counts. (Instrument Gage Factor = 2.000)

**GAGE FACTOR CONTROL**

**Range:** 0.500 to 9.900

**BALANCE CONTROL**

**Type:** Software

**Control:** Manual or automatic

**BRIDGE EXCITATION**

**Value:** 1.5 VDC nominal

**Control:** Software enable/disable

Measurements are fully ratiometric, and not degraded by variations in excitation voltage

**COMMUNICATION INTERFACE**

Universal serial bus (USB). Cable included

**SHUNT CALIBRATION**

**Location:** Across each quarter-bridge completion resistor

**Control:** Software

**Values:**

P- to D120:  $11.94K \Omega \pm 0.1\%$   
( $5000 \mu\epsilon$  at GF = 2.00)

P- to D350:  $34.8K \Omega \pm 0.1\%$   
( $5000 \mu\epsilon$  at GF = 2.00)

P- to D1000:  $99.5K \Omega \pm 0.1\%$   
( $5000 \mu\epsilon$  at GF = 2.00)

**POWER**

**USB:** 5 V 100 mA

**OPERATIONAL ENVIRONMENT**

**Temperature:**  $0^\circ$  to  $+50^\circ\text{C}$

**Humidity:** Up to 90% RH. Non-condensing.

**CASE**

**Material:** Aluminum

**SIZE AND WEIGHT**

**Size:** 4.3 W x 1.4 H x 5.7 L inches  
(110 x 36 x 145 mm)

**Weight:** 0.8 lb. (0.36 kg)

**ACCESSORIES**

D4-A106 Shielded Connectors

D4-A108 Crimping Tool

D4-A116 USB Cable (Type A to Type B—6-foot length)

## Strain Indicator Calibrator

### FEATURES

- True Wheatstone bridge circuitry
- Simulates quarter, half, and full bridge—both 120Ω/350Ω
- Three decades of push buttons
- Strain range direct reading: ±99 900 με. . . increments of 100 με
- Transducer range: ±49.95 mV/V. . . increments of 0.05 mV/V
- Reversing switch for plus and minus calibration
- High precision resistors used throughout to ensure excellent stability
- Accuracy 0.025 percent—traceable to the U.S. National Institute of Standards and Technology



A laboratory standard for verifying the calibration of strain and transducer indicators.

### DESCRIPTION

Sound engineering and laboratory practices require that the instrumentation used to make critical strain measurements be periodically calibrated to verify that it is within the manufacturer's original specifications. Additionally, each type of strain indicator exhibits some degree of nonlinearity, especially for large strains during quarter-bridge operation. Since this is the most common stress analysis application of strain gages, it is important that the strain indicator be calibrated in this mode. Instrumentation span should also be checked at a number of points before each important test to avoid inaccurate data.

The Model 1550A calibrator is a Wheatstone bridge and generates a true change of resistance in one or two arms of the bridge. It simulates the actual behavior of a strain gage in both positive and negative strain.

The 'star network' used in certain other commercial calibrators provides a substantially lower cost instrument design, because component specifications are less critical, and fewer components are required.

However, the 'star network' cannot simulate quarter-bridge strain gage behavior, and cannot simulate positive strain. Another serious problem with this circuit is that the bridge input and output resistances change in an abnormal manner, leading to inaccuracies in calibration under some conditions.

A calibrator based on the Wheatstone bridge principle requires stable components. A total of 66 ultra-stable precision resistors are used in the Model 1550A calibrator to provide the stability, repeatability, accuracy and incremental steps required in a laboratory standards instrument.

### WHEATSTONE BRIDGE / STAR NETWORK

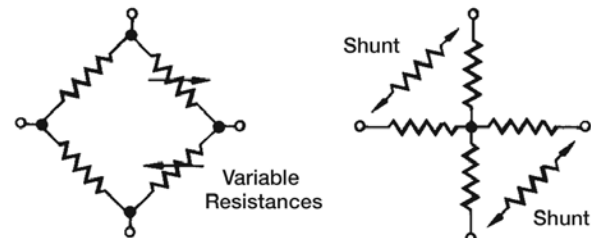

### SPECIFICATIONS

#### ACCURACY

0.025% of setting ±1 με (0.0005 mV/V), maximum  
Traceable to United States National Institute of Standards and Technology

#### REPEATABILITY

±1 με (0.0005 mV/V), maximum

#### STABILITY

(0.001% of setting ±1 με)/°C, maximum

#### THERMAL EMF

0.5 μV/V of excitation, maximum

## Strain Indicator Calibrator

**BRIDGE RESISTANCES**120 $\Omega$  and 350 $\Omega$ **INPUT RESISTANCE** $\pm 0.05\%$ , maximum, from nominal at all output settings**OUTPUT RESISTANCE** $\pm 0.05\%$ , maximum, from nominal at "000"  $\mu\epsilon$   
-0.25% at  $\pm 99\ 900\ \mu\epsilon$ **CIRCUIT**True  $\pm\Delta R$  in two adjacent arms (opposite signs), plus two fixed arms for bridge completion**SIMULATION**Quarter bridge, one active arm  
Half bridge, one or two active arms  
Full bridge, two active arms**RANGE****Two Active Arms**0 to  $\pm 99,900\ \mu\epsilon$  in steps of  $100\ \mu\epsilon$  @  $GF = 2.00$   
0 to  $\pm 49.95\ mV/V$  in steps of  $0.05\ mV/V$ **One Active Arm**0 to  $\pm 49.950\ \mu\epsilon$  in steps of  $50\ \mu\epsilon$  @  $GF = 2.00$ **EXCITATION****To Meet Accuracy and Repeatability Specifications**120 $\Omega$ : up to 10 VDC350 $\Omega$ : up to 15 VDC**Maximum Permissible**120 $\Omega$ : 25V AC or DC350 $\Omega$ : 30V AC or DC**OUTPUT @ 000**50  $\mu\epsilon$  (0.025 mV/V), maximum in full-bridge mode**ENVIRONMENT****Temperature**

+50°F to +100°F (+10°C to +38°C)

**Humidity**

Up to 70% RH, non-condensing

**SIZE**

Aluminum case (separable lid)

5-3/4 H x 8-1/4 W x 7-3/4 D in (145 x 210 x 195 mm)

**WEIGHT**

4.8 lb (2.2 kg)

All specifications are nominal or typical at +23°C unless noted.



*A certificate of calibration is provided with each Model 1550A Calibrator*



## Strain Gage Simulator

### FEATURES

- 5 Decade selector switches
- Resistance range: 30.00 to 1111.10Ω in 0.01Ω steps
- High precision resistors used throughout to ensure excellent stability
- Accuracy 0.02% of setting
- Simulates tension and compression strain for most widely used strain gage resistance values
- Simulates a broad range of RTDs for instrumentation setup and calibration



A precision decade resistor for accurately simulating the behavior of strain gages and RTDs

### DESCRIPTION

The V/E-40 Strain Gage Simulator is an accurate, stable, compact, five-decade resistor specially designed to simulate the behavior of strain gages and RTDs, and for use in a broad range of measurement and calibration applications.

As a precision strain gage simulator, the V/E-40 can be used to measure nonlinearity of the instrumentation in quarter-bridge operation, or to verify instrument calibration over the anticipated measurement range. It is also well suited to measuring desensitization of the strain gage circuit due to the finite resistance of the strain gage leadwire system.

In a similar manner, the V/E-40 can be temporarily substituted for an RTD over a resistance range of 30.00 to 1111.10 ohms to verify calibration of temperature measurement instrumentation.

The V/E-40 can also be used in conjunction with a conventional Wheatstone bridge strain indicator to measure arbitrary resistances between 30.00 and 1111.10 ohms, or to eliminate Wheatstone bridge nonlinearity effects when measuring high post-yield strains in quarter-bridge operation. In this mode, the resistance or strain gage to be measured is connected as one arm of a Wheatstone bridge, the V/E-40 is used as a decade resistor in an adjacent arm, and the strain measuring instrument as a null detector.

Other applications include use as an investigative tool to troubleshoot faulty strain gage installations, or as a precision decade resistor.

### SPECIFICATIONS

#### ACCURACY

0.02% of reading

#### MAXIMUM CURRENT (TO MEET ACCURACY AND REPEATABILITY SPECIFICATIONS)

**120Ω:** 65 mA

**350Ω:** 55 mA

**1000Ω:** 25 mA

#### STABILITY

±3 ppm/°C maximum

#### RESISTANCE RANGE

30.00 to 1111.10Ω in 0.01Ω steps

#### ENVIRONMENT

0°F to +120°F [-18°C to +49°C], up to 70% relative humidity, non-condensing

#### SIZE

3-7/8 H x 9-1/8 W x 3-1/8 D in [98 x 232 x 89 mm]

#### WEIGHT

1.9 lb [0.85 kg]

All specifications are nominal or typical at +23°C [+73°F]





A2 .....	16
2100.....	20
2200.....	24
2300.....	28

# Signal Conditioning Amplifiers

## Signal Conditioning Amplifier System

### FEATURES

- Strain gage, transducer, and thermocouple inputs
- Frequency response to 110 kHz
- Analog output of  $\pm 10$  VDC
- Operation with 12 to 15 VDC and 120/240 VAC power
- Scalable from 8 to 128 channels in high-density enclosures
- Digital control from both front panel and PC over Ethernet
- Remote channel-by-channel monitoring of signals by Ethernet



### DESCRIPTION

The A2 is an analog signal conditioner and amplifier system for strain gages, strain-gage-based transducers, thermocouples and various other sensors with high-level signals. Scalable in multiples of eight channels to a maximum of 128 for each system, the A2 features digital control of the system instrumentation and monitoring of the analog outputs, both locally on the control panel and remotely by Ethernet from a PC. The Model A2 is an embedded web server. All system, card, and channel settings are accessible using simple HTTP (hypertext transfer protocol) commands or by using the graphical user interface provided by the system. Ordinary web browsers, such as Internet Explorer, can be used to control the system. The A2 is specially designed to function as the front-end for DAQ's and recorders accepting high-level analog signals.

Instrumentation hardware, available as individual eight-channel cards for strain gage, thermocouples, and high-level signals, features high stability with temperature and time. Strain-gage instrumentation accepts full-, half-, and quarter-bridge circuits and has built-in bridge completion resistors for 120-, 350- and 1000-ohm quarter bridges. Amplifiers gain, bridge excitation and balance, shunt calibration, and signal filtering are digitally controlled. Instrument design enables sensors to remain connected when cards are removed from the system for bridge configuration.

### SPECIFICATIONS

#### General

All specifications are nominal or typical at  $+23^{\circ}\text{C}$  unless noted. Performance may be degraded in the presence of high-level electromagnetic fields.

#### System Configuration

Each system consists of a Model A2-MC-8 Controller and at least one 8-channel instrumentation card. Stackable expansion cabinets are added when two or more instrumentation cards are used.

### Physical Dimensions

#### Eight Channel Enclosure with Controller

17" W x 12" D x 8.5" H  
[43.2 cm W x 30.5 cm D x 21.6 cm H]

#### 40 Channel Enclosure with Controller

17" W x 12" D x 17.5" H  
[43.2 cm W x 30.5 cm D x 44.6 cm H]

#### 72 Channel Enclosure with Controller

17" W x 12" D x 26.5" H  
[43.2 cm W x 30.5 cm D x 67.3 cm H]

#### 104 Channel Enclosure with Controller

17" W x 12" D x 35.5" H  
[43.2 cm W x 30.5 cm D x 90.2 cm H]

#### 128 Channel Enclosure with Controller

17" W x 12" D x 44.5" H  
[43.2 cm W x 30.5 cm D x 113.0 cm H]

### Input Power

115 or 230 VAC with optional external "line lump" power supply (15 VDC output). Will also work from a 12V battery with reduced specifications.



Controller with Model A2-EC Expansion Cabinet

## Signal Conditioning Amplifier System



### MODEL A2-MC-8 CONTROLLER

Supports hardware identification, setup and output data monitoring of each type of plug-in card via a local keyboard interface or remotely via an Ethernet Interface. Each controller supports 8 channels of signal conditioning and up to 128 channels of signal conditioning when expansion cabinets are added.

#### Front Panel User Interface

Membrane keypad with illuminated 128 x 64 pixel FSTN positive, gray transfective LCD

#### Communication Interface

Physical: 10/100 Base-T

Protocol: HTTP

IP Addressing: Static. Configurable by the front panel controls

#### Size

17" W X 12" D X 8.5"H

[43.2 cm W x 30.5 cm D x 21.6 cm H]

#### Weight

12.6 lbs [5.7 kg]

### MODEL A2-SG-8-BX STRAIN GAGE CARD

(Specify **Model A2-SG-8-BW** (with Butterworth filter characteristics) or **Model A2-SG-8-BS** (with Bessel filter characteristics).)

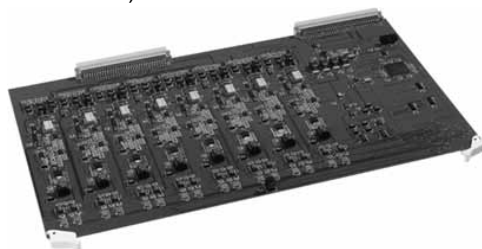

These specifications apply for each of eight independent channels of signal conditioning per removable card.

#### Amp Input

##### Inputs

Quarter (120 ohms, 350 ohms, and 1000 ohms), half and full bridge (50-1000 ohms)

Bridge completion resistors are provided for quarterbridge circuits

##### Input Impedance

>100 M $\Omega$

#### Source Current

$\pm 5$  nA typical;  $\pm 10$  nA max.

#### Amplifier

##### Zero Temperature Stability

$\pm 1.7$   $\mu\text{V}/^\circ\text{C}$  RTI\*,  $\pm 100$   $\mu\text{V}/^\circ\text{C}$  RTO\*\*, after 30-minute warm-up

##### Input Range

4 to 80 mV full-scale input range (x2500 to x125)—adjustable by software control per channel

##### Output Range

$\pm 10\text{V}$  into 600 $\Omega$  minimum load (When powered from 15 VDC)

##### DC Gain Accuracy and Stability

$\pm 0.10\%$ ;  $\pm 50$  ppm/ $^\circ\text{C}$

##### Common-Mode Rejection (DC to 100 Hz)

105 dB typical

##### Common-Mode Voltage

$\pm 10\text{V}$  typical

##### Bandpass

Full Power Frequency response DC to 110 kHz; -3 dB. (Wideband operation)  
Slew Rate: 7 V/ $\mu\text{s}$

#### Dynamic Characteristics

##### Noise RTI

1  $\mu\text{V}$  p-p at 0.1 Hz to 10 Hz

6  $\mu\text{VRMS}$  at 0.1 Hz to 110 kHz

##### Total Harmonic Distortion

0.014% at 1 kHz

#### Filter

##### Type

Software-settable 5th order filter—DC to 40 kHz max: -3 dB. (Butterworth or Bessel characteristics)

##### Settings

Wideband, 40 kHz, 20 kHz, 10 kHz, 5 kHz, 1 kHz,

100 Hz, and 10 Hz

Software-programmable per channel.

#### Bridge Excitation

##### Type

Constant voltage

##### Settings

0.0, 0.5, 1.0, 1.5, 2.0, 2.5, 3.0, 3.5, 4.0, 4.5, 5.0, 5.5, 6.0, 6.5, 7.0, 7.5, 8.0, 8.5, 9.0, 9.5 and 10.0 VDC

Software-programmable per channel

##### Accuracy

$\pm 3$  mV typical

##### Current

50 mA max. Over-current protected

##### Load Regulation

<0.05% of full scale for a load variation of 10% to 100% of full load

##### Temperature Stability

Better than  $\pm 0.005\%/^\circ\text{C}$

\*Referred to input

\*\*Referred to output

## Signal Conditioning Amplifier System

**Bridge Balance**

99% of measurement range

**Calibration**Standard factory-installed resistors ( $\pm 0.1\%$ ) simulate 5000 microstrain at  $GF=2$  for 120-, 350-, and 1000-ohm quarter bridge**8 Channel Strain Gage Card Size**

15.13" W x 9" D [38.4 cm W x 22.9 cm D]

**8 Channel Strain Gage Card Weight**

0.80 lbs [0.36 kg]

**MODEL A2-TC-8-BX THERMOCOUPLE CARD**(Specify **Model A2-TC-8-BW** (with Butterworth filter characteristics) or **Model A2-TC-8-BS** (with Bessel filter characteristics)).

These specifications apply for each of eight independent channels of signal conditioning per removable card.

**Amp Input****Inputs**Thermocouple types J, K, T, E, N, R, S, B.  
Built-in electronic cold-junction compensation  
Software-selectable**Input Impedance**10 M $\Omega$  differential, 100 K $\Omega$  common mode**Source Current** $\pm 5$  nA typical;  $\pm 10$  nA max.**Amplifier****Zero Temperature Stability** $\pm 1.7$   $\mu\text{V}/^\circ\text{C}$  RTI\*,  $\pm 100$   $\mu\text{V}/^\circ\text{C}$  RTO\*\*, after 30-minute warm-up**Input Range**

4 to 80 mV full-scale input range (X2500 to X125)—adjustable by software control per channel

**Output Range** $\pm 10\text{V}$  into 600 $\Omega$  minimum load (when powered from 15 VDC)**DC Gain Accuracy and Stability** $\pm 0.05\%$ ;  $\pm 50$  ppm/ $^\circ\text{C}$ **Common-Mode Rejection (dc to 100 Hz)**

105 dB typical

**Common-Mode Voltage** $\pm 10\text{V}$  typical**Bandpass**Full Power Frequency response DC to 110 kHz; -3 dB (Filter not selected)  
Slew Rate: 7 V/ $\mu\text{s}$ **Dynamic Characteristics****Noise RTI**1  $\mu\text{Volt}$  p-p at 0.1 Hz to 10 Hz  
6  $\mu\text{VRMS}$  at 0.1 Hz to 110 kHz**Total Harmonic Distortion**

0.014% at 1 kHz

**Filter****Type**Software-settable 5th order filter—  
DC to 40 kHz: -3 dB (Butterworth or Bessel characteristics)**Settings**Wideband, 40 kHz, 20 kHz, 10 kHz, 5 kHz, 1 kHz, 100 Hz, and 10 Hz  
Software-programmable per channel**8 Channel Thermocouple Card Size**

15.13" W x 9" D [38.4 cm W x 22.9 cm D]

**8 Channel Thermocouple Card Weight**

0.80 lbs [0.36 kg]

**MODEL A2-HL-8-BX HIGH LEVEL CARD**(Specify **Model A2-HL-8-BW** (with Butterworth filter characteristics) or **Model A2-HL-8-BS** (with Bessel filter characteristics)).

These specifications apply for each of eight independent channels of signal conditioning per removable card.

**Amp Input****Inputs**

DC voltage (differential)

**Input Impedance**>100 M $\Omega$ **Source Current** $\pm 5$  nA typical;  $\pm 10$  nA max.**Amplifier****Zero Temperature Stability** $\pm 1.7$   $\mu\text{V}/^\circ\text{C}$  RTI\*,  $\pm 100$   $\mu\text{V}/^\circ\text{C}$  RTO\*\*, after 30-minute warm up**Input Range**

1 to 10V full-scale input range—adjustable by software control per channel

**Output Range** $\pm 10\text{V}$  into 600 $\Omega$  minimum load (when powered from 15 VDC)**DC Gain Accuracy and Stability** $\pm 0.10\%$ ;  $\pm 50$  ppm/ $^\circ\text{C}$ **Common-Mode Rejection (dc to 100 Hz)**

105 dB typical

**Common-Mode Voltage** $\pm 10\text{V}$  typical**Bandpass**Full Power Frequency response DC to 110 kHz; -3 dB. (Filter not selected)  
Slew Rate: 7 V/ $\mu\text{s}$ **Dynamic Characteristics****Total Harmonic Distortion**

0.014% at 1 kHz

\*Referred to input

\*\*Referred to output

## Signal Conditioning Amplifier System

### Filter

#### Type

Software-settable 5th Order filter—DC to 40 kHz max:  
-3 dB. (Butterworth or Bessel characteristics)

#### Settings

Wideband, 40 kHz, 20 kHz, 10 kHz, 5 kHz, 1 kHz,  
100 Hz, and 10 Hz  
Software-programmable per channel

### Bridge Excitation

#### Type

Constant voltage

#### Settings

0.0, 0.5, 1.0, 1.5, 2.0, 2.5, 3.0, 3.5, 4.0, 4.5, 5.0, 5.5,  
6.0, 6.5, 7.0, 7.5, 8.0, 8.5, 9.0, 9.5 and 10.0 VDC  
Software-programmable per channel

#### Accuracy

±3 mV typical

#### Current

50 mA max. Over-current protected

#### Load Regulation

<0.05% of full scale for a load variation of 10% to  
100% of full load

#### Temperature Stability

Better than ±0.005%/°C

### 8 Channel High Level Card Size

15.13" W x 9" D [38.4 cm W x 22.9 cm D]

### 8 Channel High Level Card Weight

0.80 lbs [0.36 kg]

## MODEL A2-EC-X EXPANSION CABINET

(Specify **Model A2-EC-8** (supports one additional instrumentation card) or **Model A2-EC-16** (supports two additional instrumentation cards) or **Model A2-EC-32** (supports four additional instrumentation cards).

Stackable expansion cabinets are added when two or more instrumentation cards are used. Up to 16 instrumentation cards (128 channels) can be used with one Model A2-MC Master Controller. Control and power are routed via the Model A2-MC-8 Controller.



Front View

Back View

Controller with Model AZ-EC Expansion Cabinet

### Expansion Cabinets Size

Model A2-EC-8 Expansion Cabinet:  
17" W X 12" D X 3.0" H  
[43.2 cm W x 30.5 cm D x 7.6 cm H]

Model A2-EC-16 Expansion Cabinet:  
17" W X 12" D X 5.0" H  
[43.2 cm W x 30.5 cm D x 12.7 cm H]

Model A2-EC-32 Expansion Cabinet:  
17" W X 12" D X 9.5" H  
[43.2 cm W x 30.5 cm D x 24.1 cm H]

### Expansion Cabinets Weight

Model A2-EC-8 Expansion Cabinet: 4.5 lbs [2.04 kg]  
Model A2-EC-16 Expansion Cabinet: 6.8 lbs [3.08 kg]  
Model A2-EC-32 Expansion Cabinet: 12.0 lbs [5.44 kg]

## MODEL A2 CONTROL AND MONITORING SOFTWARE

**Recommended Browser (User Supplied):** Internet Explorer version 6 or later, running under a Windows operating system (XP, Vista, and 7). A PC with Intel Pentium class, or better, processor (450 MHz or higher), 64 MB RAM and a 100 Base-T Ethernet interface is recommended.

## Signal Conditioning Amplifier

### FEATURES

- Accepts full, half, or quarter bridges; all bridge-completion gages built in, including 120/1000- and 350-ohm dummies
- Fully adjustable and regulated bridge excitation on each channel; up to 12 VDC by front-panel control
- Continuously variable amplifier gain up to 2100 by front-panel control
- Separate bridge-power switch
- Output 10 VDC at 100 mA, short-circuit-proof and current limiting standard
- LED null indicators provided on each channel to indicate amplifier and bridge-balance condition
- High stability with temperature and time
- Frequency response up to 50 kHz
- Direct channel-by-channel display of data, with optional peak hold/retention capability

### DESCRIPTION

The demands of today's measurement applications are more exacting than ever before. An instrumentation system must provide durability and versatility, reliability with ease of operation, and economy with no sacrifice of accuracy.

The 2100 System was engineered with all of these requirements in mind, and to provide a durable, multi-channel signal conditioner/amplifier system capable of performing equally well in a wide variety of test applications and environments. And the 2100 System has proven itself through applications ranging from measurements on the ocean floor to testing of the space shuttle.

The 2100 System accepts low-level signals, and conditions and amplifies them into high-level outputs suitable for multiple-channel simultaneous dynamic recording. The 2100 System is compatible with strip charts, magnetic tape and X-Y recorders.

Strain gage, load/pressure transducer and nickel temperature sensor inputs can be handled by the 2100 System without any rewiring.

An important design objective achieved is miniaturization of the system while maintaining adequate spacing around the front-panel controls. All operational controls are located on the front panel for maximum setup efficiency. Frequently used controls are finger-operated, while initial setup adjustments are made through the front panel with a screwdriver.

Continuously variable amplifier gain is achieved via a locking ten-turn concentric-dial counting knob, which permits resetting to a predetermined value for repeating routine tests.

A combination of integrated circuits and discrete components assures maximum performance and ease of service at the lowest possible price.

### CONFIGURATION

A 2100 System consists of:

- One to five modules—Model 2120B Strain Gage Conditioner/Amplifier (two channels/module)
- One Model 2110B Power Supply
- One Model 2150 Rack Adapter



### OR

- One or two modules—Model 2120B Strain Gage Conditioner/Amplifier (two channels/module)
- One Model 2110B Power Supply
- One Model 2160B Portable Four-Channel Enclosure

### ADDITIONAL DETAILS

- A **separate bridge power switch** removes bridge excitation, enabling the operator to detect unwanted signals due to electrical interference and/or noise, thermocouple effects, and shifts of the instrument zero during a long-term test. This feature is an absolute must for dynamic testing, and for validating test results.
- An **adjustable bridge excitation control** on each channel permits excitation to be set as specified by the strain gage or transducer manufacturer. It also allows for any special consideration which may be dictated by the test material; for example, the poor thermal conductivity normally associated with plastics.
- In addition to adjustable bridge excitation, each channel has its own **regulator circuit**. This prevents interaction of adjacent channels during setup or operation.
- Each channel has a **continuously variable gain control**. In combination with recommended excitation, the independent gain control can provide a large output signal so that small signals can be resolved without overpowering the strain gage or transducer.
- An **LED display for each channel** gives positive indication of amplifier and resistive balance. This capability accelerates setup and verifies tension/compression loading.
- Easily read **reference marks** on the setup meter indicate acceptable line voltage and proper operation of internal power supplies.
- A switch contained in the Model 2110B Power Supply allows adjustment when the **line voltage** is too high or too low.
- The 2100 System provides **true quarter-bridge, three-leadwire capability**, including internal dummies and sufficient plug connections for remote shunt calibration.
- A convenient network in the Model 2120B Strain Gage Conditioner/Amplifier **allows the operator to change the factory-supplied shunt values**, as well as shunt any arm of the bridge, as required.



Signal Conditioning Amplifier

**MODEL 2120B**  
**STRAIN GAGE CONDITIONER AMPLIFIER**

A two-channel plug-in amplifier module that includes bridge completion, bridge balance, amplifier balance, bridge excitation regulator, and shunt calibration.

SPECIAL PORTION OF PRINTED CIRCUIT BOARD FOR SHUNT CALIBRATION RESISTORS AND JUMPERS

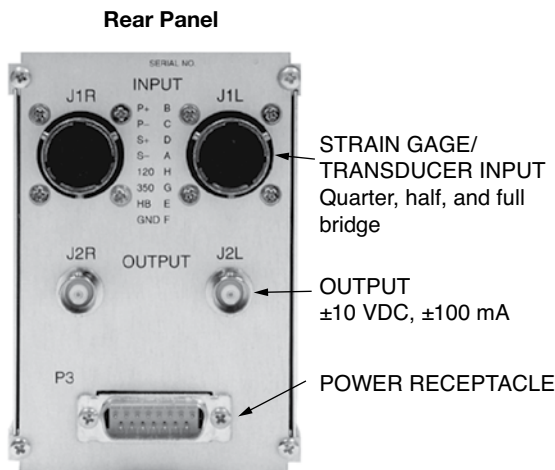
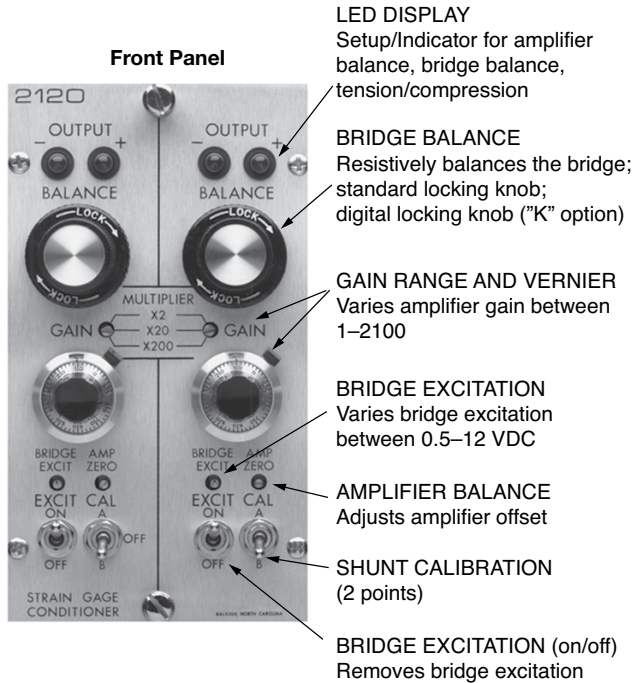
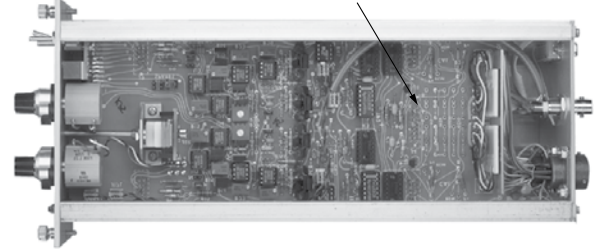

**SPECIFICATIONS**

All specifications in this datasheet are nominal or typical at +23°C unless noted. Performance may be degraded in the presence of high-level electromagnetic fields.

**Inputs**

Quarter (120Ω/1000Ω and 350Ω), half and full bridge (50–1000Ω). Quarter-bridge dummy gages provided.

**Bridge Excitation**

0.5 to 12 VDC (adjustable for each channel) with 120Ω full-bridge load.

Short-circuit current: <40 mA

Ripple, noise, and 10% line change: ±2 mV max.

Load regulation: ±0.2% no-load to 120Ω load (10% line change)

**Bridge Balance**

±2000 με (quarter, half, or 350Ω full bridge), range can be changed by internal jumper to ±4000 με or ±6000 με

**Calibration**

Two-position (center off) toggle switch

Standard factory-installed resistors (±0.1%) simulate ±1000 με at GF=2

**Amp Gain**

1 to 2100 continuously adjustable ±1%.

**Bandpass**

DC to 5 kHz (min): -0.5 dB (-5%)

DC to 15 kHz: -3 dB

Can be extended by internal jumper to:

DC to 17 kHz: -0.5 dB

DC to 50 kHz: -3 dB

**Amp Input**

**Temperature coefficient of zero**

±1 μV/°C RTI\*, ±210 μV/°C RTO\*\*

-10°C to +60°C (after 30 minute warm-up)

**Noise RTI: (350Ω source impedance)**

1 μV p-p at 0.1 Hz to 10 Hz

2 μV p-p at 0.1 Hz to 100 Hz

2 μVRMS at 0.1 Hz to 50 kHz

\*Referred to input

\*\*Referred to output

## Signal Conditioning Amplifier

### Noise RTO

50  $\mu$ V p-p at 0.1 Hz to 10 Hz  
 80  $\mu$ V p-p at 0.1 Hz to 100 Hz  
 100  $\mu$ VRMS at 0.1Hz to 15 kHz  
 200  $\mu$ VRMS at 0.1Hz to 50 kHz

### Input Impedance

>100 M $\Omega$  (balance limit resistor disconnected)

### Common-Mode Rejection

(DC to 60 Hz)

Gain Multiplier	CMR (dB)
X2	67
X20	87
X200	100

### Source Current

$\pm$ 10 nA typical;  $\pm$ 40 nA max.

### Output

$\pm$ 10V (min) at  $\pm$ 100 mA  
 Current limit: 140 mA

### Size

5.25 H x 2.94 W x 10.97 D in (133 x 75 x 279 mm)

### Weight

2.2 lb (1.0 kg)

### MODEL 2110B POWER SUPPLY

A plug-in module capable of powering up to ten channels (five Model 2120B modules) at a maximum rated voltage or current.

Provides initial bridge and amplifier voltages. All supplies are current-limited against amplifier malfunction.



**BRIDGE-VOLTS METER**  
 Used to set up/monitor bridge excitation, also line and power supply levels

**CHANNEL SELECTOR**  
 AC monitors ac line input. DC monitors the power supplies. Positions 1-10 select and display bridge excitation for each channel

**PILOT LAMP**  
 Indicates main power

**POWER SWITCH**  
 Main power on-off

**EXTERNAL METER**  
 Used with an external digital voltmeter to precisely adjust bridge excitation

### SPECIFICATIONS

#### Outputs

$\pm$ 15V at 1.2A and +17.5V at 1.1A; all regulators current-limited against overload

#### Input

107, 115, 214, 230 VAC  $\pm$ 10% 50/60 Hz (selected internally)

Power: 40W typical, 100W max.

#### Meter

0 to 12 VDC (with switch) to read bridge excitation. Also AC input and DC output go/no-go monitor

#### Size

5.25 H x 2.44 W x 12.34 D in (133 x 62 x 313 mm)

#### Weight

6.7 lb (3.1 kg)

### MODEL 2150 RACK ADAPTER

A prewired rack adapter which accepts one Model 2110B or up to five Model 2120B Strain Gage Conditioner Amplifiers. It has its own fuse and power cord and can be housed in any standard 19-in (483-mm) electronic equipment rack.

#### Power

2-ft (0.6-m) 3-wire line cord; 10-ft (3-m) extension available

Fuse: 1A size 3 AG (32 x 6.5 dia. mm)

Receptacle to accept line cord from adjacent 2150 Rack Adapter

#### Size

5.25 H x 19 W x 14.17 D in (133 x 483 x 360 mm)

#### Weight

6.6 lb (3.0 kg)

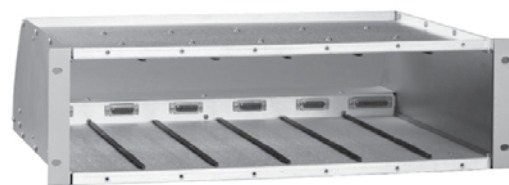

MODEL 2150 FRONT

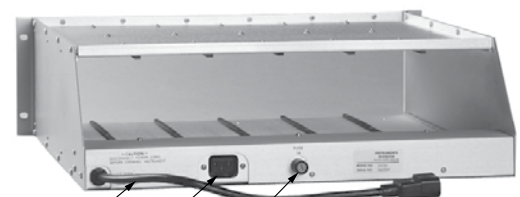

MODEL 2150 REAR  
 LINE CORD  
 AUXILIARY RECEPTACLE  
 FUSE

Signal Conditioning Amplifier

**MODEL 2160B**  
**PORTABLE FOUR-CHANNEL ENCLOSURE**

**Model 2160:** A prewired, fused enclosure which houses up to three (3) modules. A carrying handle ensures maximum portability. An additional snap-down bail support on the bottom can be used to elevate the 2160 for excellent work efficiency during bench-top operation. The Model 2160 would be substituted for the Model 2150 when two or four channels and maximum portability are required.

**SPECIFICATIONS**

**Size**

5.55 H x 8.75 W x 13.80 D in (141 x 222 x 350 mm)

**Weight**

5.2 lb (2.4 kg)



## Signal Conditioning Amplifier

### FEATURES

- Plug-in amplifier design; amplifiers are removable from the front panel without rear access
- Constant-voltage or constant-current excitation; 0.5 to 15V or 0.5 to 30 mA; selectable by single internal switch
- Calibrated gain from 1 to 3300; adjustable front-panel gain switch and calibrated front-panel ten turn potentiometer
- Front-panel monitoring of:  $\pm 10V$  output; excitation; automatic balance status; and amplifier balance
- Automatic wide range-bridge balance with battery backup to retain balance in power-off condition
- Input coupling; selectable AC or DC by internal jumpers
- Fully grounded input amplifier;  $\pm 350$  VDC or peak AC common-mode operating voltage
- Full-power bandwidth of 100 kHz at all gain settings; slew rate of 6.3 V/ $\mu$ s
- Built-in four-pole Bessel low-pass filter with cutoff frequencies of 1 Hz, 10 Hz, 100 Hz, 1 kHz and 10 kHz; front-panel frequency selection switch
- Two simultaneous buffered outputs;  $\pm 10V$  and tape 1.0 VRMS; will drive up to 0.15  $\mu$ F without instability
- Stable, proprietary bridge completion module for quarter- and half-bridge 120- and 350-ohm strain gage and transducer circuits
- 120-ohm dummy easily configured for 1000-ohm completion
- Built-in shunt calibration circuits; internal user-selectable configurations to provide two-point shunting of any bridge component or two-point double shunt calibration of transducers
- Optically isolated shunt calibration relays provided as standard; built-in power supply for relay operation is provided in ten-channel rack adapter and four-channel enclosure

### DESCRIPTION

The 2200 Signal Conditioning System incorporates, as standard, all the features necessary for precise conditioning of strain gage and transducer inputs in the most severe operating environments.

The 2210B Amplifiers plug in from the front of the ten-channel 2250A Rack Adapter or four-channel 2260B Portable Enclosure without removing the rear-panel input connections.

Among the features of the 2210B Amplifier are isolated constant-voltage/constant-current excitation, guarded input structure with  $\pm 350V$  common-mode capability,  $\pm 10V$  and tape outputs, automatic wide-range bridge balance and four-pole Bessel low-pass filter.

Operating controls of the 2210B Amplifier are conveniently arranged and clearly marked to minimize the possibility of operator error. Constant-voltage or constant-current excitation, calibration configuration, and other optional operating modes are selected by easily accessible internal switches or jumpers.



### TYPICAL 2200 SYSTEM CONFIGURATIONS

The 2200 Signal Conditioning Amplifier Modules can be used as stand-alone single-channel units, or can be plugged into racks for multi-channel testing.

Model 2260B Portable Enclosure accepts up to four signal conditioning/amplifier modules.

Model 2250A Rack Adapter allows assembly of signal conditioning amplifier modules for multi-channel testing. Ten-channel system shown in rack. All wiring is built-in to accept adjacent ten-channel systems.

Complete specifications are given on the following pages.

## Signal Conditioning Amplifier

### 2210B SIGNAL CONDITIONING AMPLIFIER SPECIFICATIONS

#### INPUT

##### Input Impedance

DC-coupled: 22 M $\Omega$  shunted by 250 pF  
AC-coupled: 1.1  $\mu$ F in series with 20 k $\Omega$   
low frequency cutoff (3 dB) 8 Hz norm.

##### Source Current

$\pm$ 10 nA typical;  $\pm$ 20 nA maximum

##### Configuration

2- to 10-wire plus guard shield accepts quarter-, half-, or full-bridge strain gage or transducer inputs. Internal half-bridge, dummy 350 $\Omega$  and dummy 120 $\Omega$  completion gages, remote sense and four-wire calibration capability provided. 1000 $\Omega$  completion capability also provided. Accepts inputs from ground-referenced or isolated devices.

##### Differential Input

Maximum differential input voltage of  $\pm$ 50 VDC or peak AC

##### Common-Mode Input

Maximum common-mode input voltage of  $\pm$ 350 VDC or peak AC

##### Guard Impedance

Greater than 250 k $\Omega$  to output common; greater than 1000 M $\Omega$  to power and rack ground

#### AMPLIFIER

##### Gain

1 to 3300; continuously variable; direct reading.  
Gain steps X1, X10, X100, X300; with 10-turn counting knob, X1 to X11. Accuracy  $\pm$ 0.5%

##### Linearity

$\pm$ 0.01% of full scale at DC

##### Frequency Response

DC to 100 kHz:  $3\pm 0.2$  dB at all gain settings and full output  
DC to 50 kHz: 0.5dB max at all gain settings and full output

##### Gain Step vs Frequency Response (3 dB):

X300	100 kHz	X10	135 kHz
X100	120 kHz	X1	240 kHz

##### Slew Rate

6.3 V/ $\mu$ sec min at all gain settings

##### Noise

(350 $\Omega$  source impedance, DC-coupled)

##### Referred-to-Input (RTI)

1  $\mu$ V 0.1 Hz to 10 Hz p-p; 2  $\mu$ V 0.1 Hz to 100 Hz p-p  
3  $\mu$ V 0.1 Hz to 100 kHz RMS

##### Referred-to-Output (RTO)

Output related noise is a function of the setting of the gain multiplier potentiometer

##### Zero Stability

$\pm$ 2  $\mu$ V RTI,  $\pm$ 200  $\mu$ V RTO at constant temp.

##### Temperature Coefficient of Zero

$\pm$ 1  $\mu$ V/ $^{\circ}$ C RTI,  $\pm$ 100  $\mu$ V/ $^{\circ}$ C RTO;  $-10^{\circ}$ C to  $60^{\circ}$ C

##### Common-Mode Rejection

Gain	CRM (dB)	Gain	CRM (dB)
X1	82	X100	122
X10	102	X300	135

##### Common Mode Voltage

$\pm$ 350 VDC or peak AC, max operating

##### Standard Output

$\pm$ 10V @ 10 mA max

##### Tape Output

1.0 VRMS @ 10 mA max, or

##### Output AC-coupled

$\pm$ 10V @ 10 mA max (7 Hz, 3 dB)

##### Output Monitor

$\pm$ 10V standard monitored via front-panel jacks

##### Output Isolation

>1000 M $\Omega$  from power and rack ground

##### Output Protection

Protected against continuous short

##### Capacitive Loading

Up to 0.15  $\mu$ F

##### Low Pass Filter

Four-pole Bessel low-pass filter with selectable 3 dB bandwidths of 1 Hz, 10 Hz, 100 Hz, 1 kHz and 10 kHz

#### CONSTANT-VOLTAGE EXCITATION

##### Range

0.50 to 15.0 VDC @ 85 mA max.

##### Noise

100  $\mu$ V + 0.002% of excitation p-p max DC to 20 kHz

##### Line Regulation

200  $\mu$ V + 0.01% of excitation max for line voltage change of 10% from nominal

##### Load Regulation

200  $\mu$ V + 0.01% of excitation max for load variation of 10% of 90% of full load

## Signal Conditioning Amplifier

**Stability**

$\pm 0.01\%/^{\circ}\text{C}$  or  $100\ \mu\text{V}/^{\circ}\text{C}$ , whichever is greater

**Remote Sense**

Error  $< 0.0005\%/\Omega$  of lead resistance

**Monitoring**

Front-panel monitoring jacks

**Isolation**

Isolated from power ground and output common; floats with guard

**CONSTANT-CURRENT EXCITATION****Range**

0.50 to 15.0 mA DC or 1.00 to 30.0 mA DC  
 Compliance voltage: 0.50 to 16.0V

**Noise**

$(1\ \mu\text{A} + 10\ \mu\text{V})$  p-p; DC to 20 kHz

**Line Regulation**

$\pm 1\ \mu\text{A} \pm 0.01\%$  max for line voltage change of  $\pm 10\%$  from nominal

**Load Regulation**

$\pm 1\ \mu\text{A} \pm 0.01\%$  max for 100% load change

**Stability**

$\pm 0.01\%/^{\circ}\text{C}$  or  $1\ \mu\text{A}/^{\circ}\text{C}$ , whichever is greater

**Monitoring**

Front-panel monitoring jacks; 10 mV/mA

**Isolation**

Isolated from power ground and output common; floats with guard

**BALANCE****Method**

Electronically injected automatic balance

**Range**

$\pm 15,000\ \mu\epsilon$  (7.5 mV/V) RTI (X2 with internal jumper)

**Resolution**

$0.50\ \mu\epsilon$  RTI (X2 with internal jumper)

**Balance Time**

4 seconds typical; 8 seconds max.

**Accuracy**

$\pm 2\ \text{mV}$  RTO;  $\pm 2\ \mu\epsilon$  RTI

**Balance Trim**

$\pm 375\ \mu\epsilon$  (188  $\mu\text{V}/\text{V}$ ) RTI

**Storage**

Digital with battery backup. Battery life 3-5 years.

**Activation**

Activated by front-panel switch or by optically isolated remote switch or low TTL level

**CALIBRATION**

**Four internal shunt calibration resistors,**  
 $\pm 0.1\%$  tolerance

174.8K	1000 $\mu\epsilon$ (0.50 mV/V)	350 $\Omega$ bridge
874.8K	200 $\mu\epsilon$ (0.10 mV/V)	350 $\Omega$ bridge
59.94K	1000 $\mu\epsilon$ (0.50 mV/V)	120 $\Omega$ bridge

Activated by front-panel switch, or by optically isolated remote contact closure or low TTL level.

Internal selector switches for selection of two-point unipolar, bipolar, or two-point double shunt calibration circuits

Calibration resistors plug into fixed terminals (no soldering)

**SIZE AND WEIGHT**

7 H x 1.71 W x 17.88 D in (178 x 43 x 454 mm)  
 3.7 lb (1.67 kg)

**MODEL 2250A RACK ADAPTER**

A prewired rack adapter which accepts up to ten Model 2210B plug-in amplifier modules. The Model 2250A also fits standard 19-in (483-mm) mainframe electronic equipment racks so that multi-channel system configurations can be conveniently housed. The Model 2250A contains all built-in wiring for connecting one rack adapter to another.

**SPECIFICATIONS**

All references to microstrain assume a gage factor of 2.00.

All specifications are nominal or typical at  $+23^{\circ}\text{C}$  unless noted. Performance may be degraded in the presence of high-level electromagnetic fields.

**INPUT**

Input plugs are provided for up to ten channels; Bendix PT06A-14-15 (SR)

**OUTPUT**

Standard  $\pm 10\text{V}$ , BNC receptacle (10 ea)  
 Tape 1.0 VRMS, BNC receptacle (10 ea)

**REMOTE**

Provides access to remote calibration and remote balance functions of 2210B Amplifiers. The required +5V power supply is an integral part of the 2250A Rack Adapter.

**POWER**

115/230 VAC, 50-60 Hz, 120W max.  
 Fuse: 1.5A, 3 AG (115V) or 3/4A, 3 AG (230V)

**SIZE AND WEIGHT**

7 H x 19 W x 18.87 D in (178 x 483 x 479 mm)  
 13.8 lbs (6.25 kg)

Signal Conditioning Amplifier

**MODEL 2260B PORTABLE ENCLOSURE**

A self-contained prewired rack/enclosure which accepts up to four 2210B Amplifiers. All input/output connectors are provided on the rear panel of the enclosure. A carrying handle allows convenient portability, and a snap-down bail support on the bottom is used to elevate the 2260B for work efficiency during bench-top operation.



**SPECIFICATIONS**

**INPUT**

Input plugs are provided for up to four channels  
Bendix PT06A-14-15 (SR)

**OUTPUT**

Standard  $\pm 10V$ , BNC receptacle (4 ea)  
Tape 1.0 VRMS, BNC receptacle (4 ea)

**REMOTE**

Provides access to remote calibration and remote balance functions of 2210B Amplifiers. The required +5V power supply is an integral part of the 2260B Portable Enclosure

**POWER**

115/230 VAC, 50/60 Hz, 50W max.  
Fuse: 3/4A, 3 AG (115V) or 3/8A, 3 AG (230V)

**SIZE AND WEIGHT**

7.31 H x 7.20 W x 20.16 D in (186 x 183 x 512 mm)  
8.1 lb (3.67 kg)

**THE 2200 SYSTEM PROVIDES BETTER DATA**

A **floating, guarded input** environment maximizes the rejection of common-mode voltages up to  $\pm 350V$  (operating). The input amplifier can also be AC-coupled for situations where only dynamic signals are of interest.

The **independent, isolated bridge excitation** system provides either **constant-voltage** or **constant-current** excitation. A front-panel LED serves as a supervisory indicator, and a front-panel switch removes bridge excitation to assist in evaluation of circuit integrity.

An **automatic balance** circuit is used to provide wide balance range and **electronic injection** of balance voltage. This feature eliminates transducer loading and assures sufficient balance capability for practically all input configurations. The automatic balance circuit can be disabled from the front panel to allow measurement of initial unbalance, input noise, thermal offsets or zero shifts.

The **four-pole Bessel low-pass filter** provides five selectable bandwidths from **1 Hz to 10 kHz**. The 1 Hz or 10 Hz positions can be used for quasi-static data with excellent rejection of line frequency (60 Hz) noise. The output of the low-pass filter can be routed to either the standard or tape output, or either output can be wideband.

**Wide bandwidth and high slew rate** at all gain settings and at **full output** ( $\pm 10V$ ). This characteristic ensures that integrity of the system's performance is not compromised when higher gain settings are required.

A **standard** ( $\pm 10V$ ) and a **tape** (1.0 VRMS) output are provided for each channel. The outputs are **isolated** from the guarded input and from chassis (system) ground. This feature gives the user complete independence to establish a high-quality instrumentation ground system at the recording or data acquisition site. Both outputs can drive long (high capacitance) coaxial cables without instability.

The system provides **optically isolated shunt calibration circuits** on each channel. Any desired calibration configuration can be selected by internal switches. External contact closures are also accessible via the input connector to facilitate double-shunt (two-level) transducer calibration. Calibration resistors can easily be changed to any special values. No soldering is required.

Individual amplifiers are **removable from the front panel** without disconnecting the input or output wiring. This gives the user the option of dedicated rack or enclosure wiring, sharing of amplifiers, and ease of amplifier replacement under emergency conditions.

## Signal Conditioning Amplifier

### FEATURES

- Accepts all strain gage inputs (foil and piezoresistive), potentiometers, DCDT's, etc
- Selectable bridge excitation, 0.7 to 15 VDC (11 steps), plus 0.2 to 7 VDC continuously variable
- Fully adjustable calibrated gain from 1 to 11,000
- Dual-range ( $\pm 5000 \mu\epsilon$  and  $\pm 25,000 \mu\epsilon$ ) automatic bridge balance, with "keep-alive" power to preserve balance for months without external power
- All bridge completion built in, including 120- or 1000- and 350-ohm dummies
- Dual polarity two-step double shunt calibration
- Bandpass:
  - 76 kHz ( $-0.5$  dB)
  - 155 kHz ( $-3$  dB)
- Switchable active filter—a 6-pole Butterworth is standard
- Two simultaneous buffered outputs
- Playback mode to filter and observe or re-record previously recorded low-level data
- Input impedance above 100 megohms

### DESCRIPTION

The 2300 System conditions and amplifies low-level signals to high-level outputs for multiple-channel, simultaneous dynamic recording and display on external devices.

Among its features, each 2310B Module includes a built-in power supply, active filtering, two simultaneous outputs, playback mode, wide frequency response, and voltage injection bridge balance.

Up to ten 2310B Modules can be mounted in a Model 2350 Rack Adapter; or up to four modules in a Model 2360B Portable Enclosure; or, a single 2310B can serve as a standalone unit using the 2310-A20 Line Cord and Stabilizer.

The 2310B Modules may be interchanged between the 2350 Rack Adapter and the 2360B Portable Enclosure to best satisfy testing requirements.

### MODEL 2310B SIGNAL CONDITIONING AMPLIFIER

The 2310B Conditioner/Amplifier Modules accept inputs from strain gages, load/pressure/DC displacement transducers, potentiometers, RTD's and nickel temperature sensors, without any internal modification.

Controls on the 2310B are arranged in sections, permitting easy setup. Clearly marked push-button and single-purpose switches minimize the possibility of operator error during use. With the exception of the playback switch, all operational and monitor controls are on the front panel. Switches for selecting remote sense and specific shunt calibration configurations are located on the printed circuit board inside the unit.



- Calibration: Momentary two-position switches,  $\pm A$  and  $\pm B$ , control shunt calibration levels; 4 point
- LED Display: Set up indicator for amplifier balance, bridge balance and for monitoring the output polarity
- Filter Section: Push-button controls for activating appropriate low- and high-pass active filters
- Electronic Bridge Balance Section: Three-position switch—OFF, ON, RESET—for electronic bridge balance; auto ranging up to  $\pm 25\,000 \mu\epsilon$  with nonvolatile zero storage; yellow light indicates high-range operation or over range condition
- Vernier trim control is used to refine bridge balance when desired
- AC IN: Capacitive coupling in the amplifier; eliminates static component of the signal
- Bridge Excitation: ON-OFF switch for removing bridge excitation from the strain gage or transducer for noise documentation
- Amplifier Balance: Adjusts amplifier offset
- Excitation Level: Twelve-position switch; values arranged for doubling power with each step, with one 0.2 to 7 VDC continuously variable
- Amplifier Gain Section: Continuously variable potentiometer (1.00 to 11.00) plus push-button course gain multipliers control amplifier gain; direct-reading
- Battery Test: Momentary push button determines battery level for bridge zero storage
- Main Power: Turns unit on/off; LED pilot light
- Pin Jacks: Monitoring of Excitation, Unamplified Input, Amplified Output



FRONT PANEL



Signal Conditioning Amplifier

- AC Line Switch: Selects nominal 115 or 230 VAC operation.
- Playback Section: Slide switch activates playback operating mode. Connects the input to the filter circuits and post amplifiers. BNC input connector.
- Low-level Output: Full-scale  $\pm 1.4V$  level available at this BNC connector for driving various recording devices and low-level analog-to-digital converters.
- High-Level Output: Full-scale  $\pm 10V$  level available at this BNC connector for driving an oscilloscope, digital voltmeter, analog-to-digital converter, etc.
- Input Receptacle: All sensor inputs made through this 15-pin quarter-turn connector. Pin selection determines mode of operation (mating plug included).
- Power Connector: Main power input from the rack adapter, portable enclosure or individual line plug. Additional pins for optional remote operation of shunt calibration, bridge excitation (ON/OFF), and electronic bridge balance.



REAR PANEL

**SPECIFICATIONS**

All specifications are nominal or typical at +23°C unless noted. Performance may be degraded in the presence of high-level electromagnetic fields.

**INPUT**

**Strain Gages**

Quarter, half or full bridge (50Ω to 1000Ω)  
Built-in 120Ω and 350Ω dummy gages; 1000Ω dummy capability

**Transducers**

Foil or piezoresistive strain gage types  
DCDT displacement transducers  
Potentiometers

**EXCITATION**

**Eleven Fixed Settings**

0.7, 1, 1.4, 2, 2.7, 3.5, 5, 7, 10, 12 and 15 VDC  
1% max.

**One Variable Setting**

0.2 to 7 VDC

**Current**

0–100 mA, min, limited at 175 mA, max.

**Regulation (0–100 mA  $\pm 10\%$  line change)**

$\pm 0.5$  mV;  $\pm 0.04\%$ , max measured at remote sense points. (Local sense:  $-5$  mV, typical, @ 100 mA, measured at plug)

**Remote Sense Error**

0.0005% per Ω of lead resistance (350Ω load)

**Noise and Ripple**

0.05% p-p, max (DC to 10 kHz)

**Stability**

$\pm 0.02\%/^{\circ}C$

**Level**

Normally symmetrical about ground; either side may be grounded with no effect on performance

**BRIDGE BALANCE**

**Method**

Counter-emf injection at pre-amp; automatic electronic; dual range; can be disabled on front panel

**Ranges (auto ranging)**

$\pm 5000 \mu\epsilon$  ( $\pm 1\%$  bridge unbalance or  $\pm 2.5$  mV/V), resolution  $2.5 \mu\epsilon$  (0.0012 mV/V)  
 $\pm 25,000 \mu\epsilon$  ( $\pm 5\%$  bridge unbalance or  $\pm 12.5$  mV/V), resolution  $12.5 \mu\epsilon$  (0.006 mV/V)

**Balance Time**

2 seconds, typical

**Manual Vernier Balance Range**

$100 \mu\epsilon$  (0.050 mV/V)

**Interaction**

Essentially independent of excitation and amplifier gain

**Storage**

Non-volatile digital storage without line power for up to two years

**SHUNT CALIBRATION**

**Circuit (two-level, dual polarity)**

Single-shunt (for stress analysis) across any bridge arm, including dummy gage

Double-shunt (for transducers) across opposite bridge arms

Provision for four dedicated leads to shunt external arms

CAL circuit selected by switches on PC board

**Standard Factory-Installed Resistors ( $\pm 0.1\%$ ) Simulate**

$\pm 200$  and  $\pm 1000 \mu\epsilon$  @ GF=2 across dummy half bridge;  $\pm 1000 \mu\epsilon$  @ GF=2 across dummy gage (120Ω and 350Ω).

$\pm 1$  mV/V (double shunt) for 350Ω transducer

## Signal Conditioning Amplifier

**Remote-Operation Relays (Option Y)**

Four relays (plus remote-reset relay for bridge balance and relay for excitation on/off). Each relay requires 10 mA @ 5 VDC except excitation on/off 25 mA

**AMPLIFIER****Gain**

1 to 11, 000 continuously variable. Direct reading,  $\pm 1\%$  max. 10-turn counting knob (X1 to X11) plus decade multiplier (X1 to X1000)

**Frequency Response, All Gains Full Output**

DC coupled: DC to 145 kHz,  $-3$  dB max.

DC to 60 kHz,  $-0.5$  dB max.

AC coupled: 1.7 Hz typ. to 150 kHz,  $-3$  dB max.

**Frequency Response Versus Gain, Full Output:**

Gain	$-0.5$ dB	$-3$ dB
1-11	130 kHz	300 kHz
10-110	110 kHz	250 kHz
100-1100	80 kHz	160 kHz
1000-11000	76 kHz	155 kHz

**Slew Rate**

7.8 V/ $\mu$ s typical

**Input Impedance**

100 m $\Omega$ , min, differential or common-mode, including bridge balance circuit

**Bias Current**

$\pm 40$  nA, typical max., each input

**Source impedance**

0 to 1000 $\Omega$  each input

**Common-Mode Voltage**

$\pm 10$ V

**Common-Mode Rejection (gain over X100)**

Shorted input: 100 dB, min, at DC to 60 Hz;

90 dB, min, DC to 1 kHz;

350 $\Omega$  balanced input: 90 dB, typical, DC to 1 kHz

**Stability (gain over X100)**

$\pm 2$   $\mu$ V/ $^{\circ}$ C, max, RTI (referred to input)

**Noise (gain over X100, all outputs)**

0.01 to 10 Hz: 1  $\mu$ V p-p RTI

0.5 to 125 kHz: 6 $\mu$  VRMS, max, RTI

**FILTER****Characteristic**

Low-pass active six-pole Butterworth standard

**Frequencies ( $-3 \pm 1$  dB)**

10, 100, 1000 and 10,000 Hz and wide-band

**Outputs Filtered**

Either one or both (switch-selected on printed circuit board)

**AMPLIFIER OUTPUTS****Standard Output**

$\pm 10$ V @ 5 mA, min.

Slew Rate: 7.8 V/ $\mu$ s (typical)

**Low-Level Output**

$\pm 1.414$ V (1 VRMS) @ 5 mA, min.

**Linearity @ DC**

$\pm 0.02\%$ ;

Either output can be short-circuited with no effect on the other

**PLAYBACK****Input**

$\pm 1.414$ V full scale; input impedance 20 k $\Omega$

**Gain**

X1 to low-level output; X7.07 to standard output

**Filter Selection**

As specified above

**Outputs**

Both as specified above

**OPERATING ENVIRONMENT****Temperature**

0 $^{\circ}$ C to +50 $^{\circ}$ C

**Humidity**

10% to 90%, noncondensing

**POWER**

105V to 125V or 210V to 250V (switch-selected), 50/60 Hz, 10 watts, max.

**Keep-Alive Supply (for bridge balance)**

Lithium 3.6V, 1/2 AA or equal

Shelf life approximately two years

**SIZE AND WEIGHT****Panel**

8.75 H x 1.706 W in (222.2 x 43.3 mm)

**Case Depth Behind Panel**

15.9 in (404 mm)

**Weight**

6 lb (2.7 kg)

Signal Conditioning Amplifier

**MODEL 2350 RACK ADAPTER**



A prewired rack adapter which accepts up to ten Model 2310B plug-in amplifier modules. The Model 2350 also fits standard 19-in (483-mm) mainframe electronic equipment racks so that multi-channel system configurations can be conveniently housed.

**SPECIFICATIONS**

**APPLICATION**

- Fits standard 19-in (483-mm) electronic equipment rack
- Accepts up to ten 2310B Amplifiers
- AC line completely wired
- Wiring for remote calibration with Option Y

**POWER**

115 or 230 VAC switch selected in amplifiers, 50/60 Hz, 100 Watts max.

**SIZE AND WEIGHT**

8.75 H x 19 W x 19.06 D overall (222 x 483 x 484 mm)  
13.5 lb (6.1 kg)

**MODEL 2360B 4-CHANNEL ENCLOSURE**



Model 2360B Portable Enclosure includes all AC wiring. Accepts up to four amplifier modules.

**SPECIFICATIONS**

**APPLICATION**

- Enclosure to accept up to four 2310B Amplifiers
- AC wiring complete
- Wiring for remote calibration with Option Y

**POWER**

115 or 230 VAC (switch selected in amplifiers), 50/60 Hz, 100 Watts max.

**SIZE AND WEIGHT**

9.06 H x 7.20 W x 18.90 D in (229 x 183 x 480 mm)  
6.75 lb (3.1 kg)





Software for Stress Analysis Testing .....	34
System 5000 .....	37
System 6000 .....	41
System 7000 .....	50

# Digital Data Systems

## StrainSmart® Data Acquisition System

StrainSmart is a ready-to-use, Windows®-based software system for acquiring, reducing, presenting, and storing measurement data from strain gages, strain-gage-based transducers, thermocouples, temperature sensors, LVDTs, potentiometers, piezoelectric sensors, and other commonly used transducers.

And, it is designed to function seamlessly with a variety of Micro-Measurements instrumentation hardware, including System 5000, System 6000, and System 7000 StrainSmart Data Systems.

### DESCRIPTION

Ready-to-use StrainSmart software makes test setup fast and easy for strain gages, strain-gage-based transducers, thermocouples, temperature sensors, LVDTs, potentiometers, piezoelectric sensors, and other commonly used transducers. Using the parameters input for sensors, materials, and instrumentation hardware, StrainSmart automatically outputs the results of the test data in engineering units. Test setups and measurement data can also be permanently stored for offline display or for use in databases, word processors, and spreadsheets.

StrainSmart has the capability to reduce data in both the time and frequency domains. FFT analysis may be elected for data acquired at scanning rates greater than 100 samples per second.

Accurate strain measurements require attention to the unique characteristics of the strain gage and measurement system—thermal output, temperature coefficient of gage factor, and transverse sensitivity of strain gages, as well as nonlinearity errors inherent in the Wheatstone bridge. StrainSmart software takes these into account automatically.

All strain-gage bridges are scaled for the number of active bridge arms. Data from measurements with delta, rectangular, and tee rosettes can be reduced to principal strains and stresses, as well as the equivalent stresses for common failure mode criteria.

Fully reduced and corrected measurement data can be monitored online, and recorded at predetermined limits or at user-defined intervals.

### THE STRAINSMART ADVANTAGE

Strain gage technology is the stress/strain measurement technique most widely used around the world. Over the years, we have developed the tools necessary for accurate acquisition and understanding of strain gage measurements. The primary factors affecting strain gage and instrument performance are incorporated into our extensive selection of Tech Notes, Application Notes, Instruction Bulletins, and other technical publications that are recognized and used as the authoritative references for strain gage measurement by practitioners throughout the world. StrainSmart software automatically applies the



techniques and corrections covered by these publications to your test measurements.

### STRAINSMART SOFTWARE FEATURES

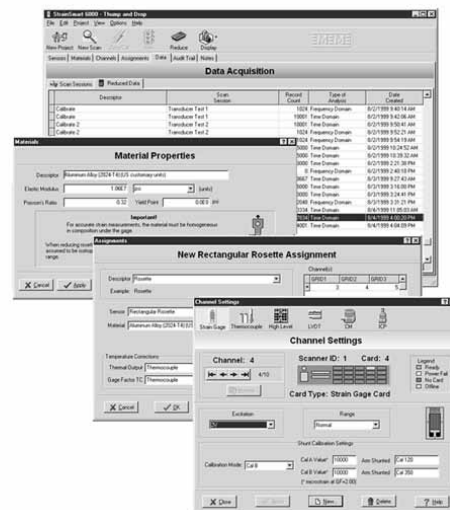

- Complete Windows-based software designed for the experimental stress analyst
- Easy-to-use StrainSmart Wizards for fast test setup and for data acquisition, reduction, and presentation
- Sensor-specific assignment of inputs (strain gages, thermocouples, etc.), as well as user-defined assignments for mathematical manipulation of measurement data
- One-touch autobalance
- Shunt calibration of strain-gage inputs
- Reduced data available offline as Paradox data tables, ASCII text, HTML or Microsoft Office (Word, Excel, Access) document, or online by OLE Automation connection to spreadsheets, word processors, LabView, and other third-party applications
- Online interactive Help system
- Test setup and commonly used parameters available for saving and reuse for subsequent testing

## StrainSmart® Data Acquisition System

### ACQUISITION/REDUCTION/PRESENTATION

- Data reduction for delta, rectangular, and tee rosettes, including the conversion of principal strains to stresses
- Calculation of equivalent stresses for common failure mode criteria
- Online monitoring of key channels and/or rosettes in fully reduced and corrected numeric and graphic formats
- Offline presentation of all reduced data in numeric and graphical formats
- FFT analysis (System 6000 and System 7000)
- Thermal output compensation
- Correction for temperature coefficient of gage factor
- Wheatstone bridge nonlinearity correction
- Transverse sensitivity correction
- Thermocouple linearization

- Scaling for number of active bridge arms
- Data storage for later analysis and processing
- Record on limits or user-defined time intervals
- Automatic audit trail
- Self calibration (System 7000)
- Barcode input of strain gage datasheet information

### MULTI-CHANNEL MEASUREMENTS

Through StrainSmart software, the appropriate setup information is entered—gage factor, materials properties, transducer sensitivities, etc. Using these parameters, StrainSmart automatically outputs the results of test data in engineering units. Setup information and measurement data can also be permanently retained for offline display or for export to databases, word processors, and spreadsheets.

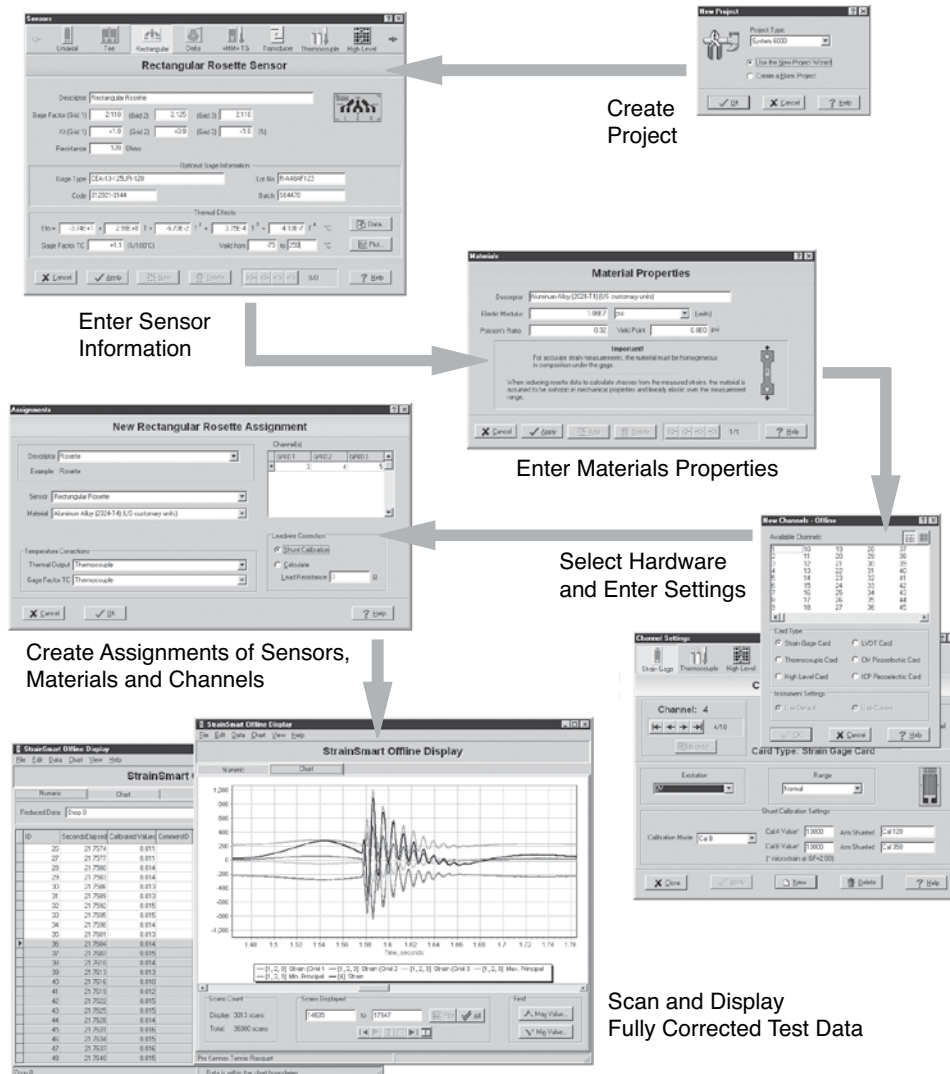

## StrainSmart® Data Acquisition System

### STRAINSMART DATA SYSTEMS

StrainSmart software is designed to function with a variety of instrumentation hardware to meet your needs.

#### System 5000

- 10 to 100 measurements per second per sensor
- Fixed analog input filter



#### System 6000

- 10 to 10,000 measurements per second per sensor
- Selectable digital filtering of measurement signals
- Time and frequency domain analysis
- Desktop and remote operation



#### System 7000

- 10 to 2048 measurements per second per sensor
- Selectable digital filtering of measurement signals
- Time and frequency domain analysis
- Self calibration with internal calibration reference





## StrainSmart® Data Acquisition System

### FEATURES

- From 5 to 1200 input channels—can be configured as needed at any time
- Inputs accepted from strain gages and strain-gage-based transducers (Model 5110A), thermocouples (Model 5120A), sensors with high-level voltage output (Model 5130B), and LVDTs (Model 5140A)
- Built-in bridge completion for 120-, 350-, and 1000-ohm strain gages
- Scanning and recording intervals as short as 0.02 seconds for up to 1200 inputs
- Stable, accurate, low-noise signal conditioning
- Available with PCI and PCIe hardware Interface



### DESCRIPTION

System 5000's Model 5100B Scanners acquire test data within 1 millisecond from up to 1200 channels at scan intervals as short as 0.02 seconds. This translates into more accurate test results, and the ability to capture data under static loading conditions immediately before failure.

Sensor connections are quickly made to the cards at the rear of each scanner in System 5000. Strain gage cards include built-in bridge completion for quarter and half bridges, and a constant voltage power supply for 0, 0.5, 1, 2, 5, and 10 VDC bridge excitation.

System 5000's instrumentation hardware is designed to incorporate all the features required for precision strain measurement under static loading conditions, while maintaining flexibility and ease of use. A system can be configured with as few as 5, and as many as 1200, sensors. Since each Model 5100B Scanner can function independently, your System 5000 components can easily be configured with StrainSmart software for each test requirement.

### MODEL 5100B SCANNER SPECIFICATIONS



The Model 5100B Scanner is sized for standard 19-in (483-mm) instrumentation racks. Cabinets are available for various system configurations for bench-top or field use.

Since each Model 5100B Scanner can function independently, your System 5000 components can be easily configured for each test requirement. A 100-channel system, for example, can be used as five independent 20-channel systems simply by purchasing additional interface hardware installations.

### INPUTS

Accepts up to four cards (five channels per card and up to 20 channels per scanner).

### A/D CONVERTER

16-bit (15-bit plus sign) successive approximation converter. Usable resolution is typically 15 bits. 40  $\mu$ s total conversion time per reading.

### SCAN RATE

1 ms per scan. Fifty complete scans per second typical usage. Concurrent scanning for all scanners.

Input channels in each single scanner are scanned sequentially at 0.04-ms intervals and stored in random access memory within a 1-ms window.

### DIGITAL OUTPUT

NO and NC relay contacts (500 mA at 30 VDC into a resistive load)

### OPERATIONAL ENVIRONMENT

#### Temperature

-10° to +50°C

#### Humidity

Up to 90% RH, non-condensing

### SIZE

3.5 H x 19 W x 16 D in (89 x 483 x 381 mm)

### WEIGHT

16 lb (7.25 kg)

### POWER

115 or 230 VAC user-selectable  
±10% of setting; 50/60 Hz; 140W max

## StrainSmart® Data Acquisition System

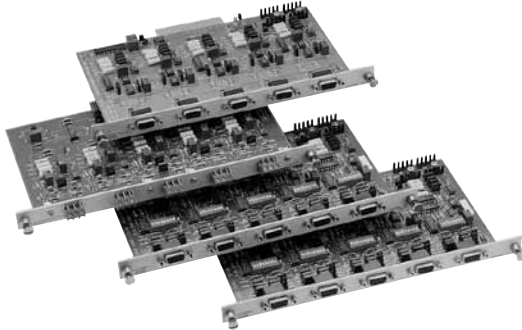
**SENSOR CARD SPECIFICATIONS**

Strain gages, strain-gage-based transducers, thermocouples, LVDTs, potentiometers and other transducers can be intermixed in multiples of 5 by choosing the appropriate sensor card.

**MODEL 5110A STRAIN GAGE CARD****CHANNELS**

Five per card

**INPUTS****Strain Gages**

120 $\Omega$ , 350 $\Omega$ , 1000 $\Omega$  quarter bridges; 60 $\Omega$  to 5000 $\Omega$  half and full bridges

Jumper-selectable completion resistors  
(0.02%  $\pm$ 3 ppm/ $^{\circ}$ C typ)

**Measurement Range**

Normal range mode:  $\pm$ 16,380  $\mu\epsilon$

High range mode:  $\pm$ 163,800  $\mu\epsilon$

Low range mode:  $\pm$ 1638  $\mu\epsilon$

**Resolution**

Normal range mode: 1  $\mu\epsilon$

High range mode: 10  $\mu\epsilon$

Low range mode: 0.1  $\mu\epsilon$

**Strain Gage Based Transducers**

60 $\Omega$  to 5000 $\Omega$  impedance

**Measurement Range**

Normal range mode:  $\pm$ 8 mV/V

High range mode:  $\pm$ 80 mV/V

Low range mode:  $\pm$ 0.8 mV/V

**Resolution**

Normal range mode: 0.5  $\mu$ V/V

High range mode: 5.0  $\mu$ V/V

Low range mode: 0.05  $\mu$ V/V

**Input Impedance**

220 M $\Omega$  each input

**Input Protection**

$\pm$ 40V

**Source Current**

$\pm$ 25 nA max.

**Input Connector**

Nine-pin D-sub style

**AMPLIFIER****Zero Temperature Stability**

$\pm$ 1.2  $\mu$ V/ $^{\circ}$ C RTI,  $\pm$ 100  $\mu$ V/ $^{\circ}$ C RTO, after 30-minute warm-up

**Gain Accuracy and Stability**

$\pm$ 0.1% at +23 $^{\circ}$ C;  $\pm$ 100 ppm/ $^{\circ}$ C

**Common-Mode Voltage**

$\pm$ 10V

**Common-Mode Rejection (DC to 5 Hz)**

100 dB typical

**System Noise (Normal Mode Operation)**

$\pm$ 2  $\mu\epsilon$  typical ( $\pm$ 4 ADC counts)

**System Coarse Balance Range**

$\pm$ 100% of measurement range (typically  $\pm$ 16,383  $\mu\epsilon$ )

**CALIBRATION**

Two shunt calibration points are available on each channel

Switch-selectable

Calibration switches, A and B, are software selectable

**EXCITATION**

0.0, 0.5, 1.0, 2.0, 5.0, and 10.0 VDC

Software-programmable

**Accuracy**

$\pm$ 5 mV typical

**Current**

250 mA max. (50 mA per channel)

Over-current protected

**Load Regulation**

<0.05% of full scale for a load variation of 10% to 100% of full load

**Temperature Stability**

Better than  $\pm$ 0.005%/ $^{\circ}$ C

**FILTER****Type**

Four-pole Butterworth

**Cutoff Frequency (-3 dB)**

5 Hz

StrainSmart® Data Acquisition System

**MODEL 5120A THERMOCOUPLE CARD**

**CHANNELS**

Five per card

**INPUTS**

Thermocouple types J, K, T, E, R, S, and B  
Built-in electronic cold-junction compensation  
Software-selectable

**Open sensor detection:**

Input Impedance: 22 M $\Omega$  each input  
Input Protection:  $\pm 40V$   
Source Current:  $\pm 0.5$  nA typical;  $\pm 5$  nA max

**Input Connector**

Removable three-position screw terminal

**AMPLIFIER**

**Zero Temperature Stability**

$\pm 1.2$   $\mu V/^{\circ}C$  RTI,  $\pm 100$   $\mu V/^{\circ}C$  RTO, after 30-minute warm-up

**Gain Accuracy and Stability**

0.1%  $\pm 100$  ppm/ $^{\circ}C$

**Common-Mode Rejection (DC to 5 Hz)**

100 dB typical

**Common-Mode Voltage**

$\pm 10V$

**System Noise (Normal Mode Operation)**

$\pm 10$   $\mu V$  typical ( $\pm 4$  ADC counts)

**MEASUREMENT RANGE**

$\pm 81.9$  mV

**RESOLUTION**

2.5  $\mu V$

**FILTER**

**Type**

Four-pole Butterworth

**Cutoff Frequency (-3 dB)**

5 Hz

**MODEL 5130B HIGH-LEVEL INPUT CARD**

**CHANNELS**

Five per card

**INPUTS**

DC volts (differential)

**Input Impedance**

22 M $\Omega$  each input

**Input Protection**

$\pm 40V$

**Source Current**

$\pm 0.5$  nA typical;  $\pm 5$  nA max

**Input Connector**

Nine-pin D-sub style

**AMPLIFIER**

**Zero Temperature Stability**

$\pm 1.2$   $\mu V/^{\circ}C$  RTI,  $\pm 100$   $\mu V/^{\circ}C$  RTO, after 30-minute warm-up

**Gain Accuracy and Stability**

0.1%  $\pm 100$  ppm/ $^{\circ}C$

**Common-Mode Rejection (DC to 5 Hz)**

100 dB typical

**Common-Mode Voltage**

$\pm 10V$

**System Noise (Normal Mode Operation)**

$\pm 4$  ADC counts typical (0 to 15V excitation)  
 $\pm 10$  ADC counts typical (20 to 30V excitation)

**MEASUREMENT RANGES**

$\pm 1$ ,  $\pm 2$ ,  $\pm 5$ ,  $\pm 10$  VDC

**RESOLUTION**

30.5, 61, 152.5, 305  $\mu V$

**EXCITATION**

0, 0.5, 1.0, 2.0, 5.0, 10.0, 15.0, 20.0, 25.0 and 30.0 VDC

**Accuracy**

$\pm 10$  mV typical

**Current**

250 mA max (50 mA per channel) at 1 to 15V  
200 mA max (40 mA per channel) at 20V  
150 mA max (30 mA per channel) at 25 to 30V

Over-current protected

Max current limit selected by jumpers

**Load Regulation**

<0.05% of full scale for a load variation of 10% to 100% of full load

**Temperature Stability**

Better than  $\pm 0.005\%/^{\circ}C$

**FILTER**

**Type**

Four-pole Butterworth

**Cutoff Frequency (-3 dB)**

5 Hz

## StrainSmart® Data Acquisition System

### MODEL 5140A LVDT INPUT CARD

#### CHANNELS

Five per card

#### INPUTS

Three- to six-wire transducers

#### Input Impedance

10 M $\Omega$  each input

#### Input Protection

$\pm 40V$

#### Source Current

$\pm 0.5$  nA typical;  $\pm 5$  nA max

#### Input Connector

Nine-pin D-sub style

#### AMPLIFIER

##### Zero Temperature Stability

$\pm 1.2$   $\mu V/^{\circ}C$  RTI,  $\pm 100$   $\mu V/^{\circ}C$  RTO, after 30-minute warm-up

##### Gain Accuracy

0.25% typical

##### Common-Mode Rejection (DC to 5 Hz)

100 dB typical

##### Common-Mode Voltage

$\pm 10V$

##### System Noise (Normal Mode Operation)

$\pm 4$  ADC counts typical

##### Measurement Ranges

$\pm 0.5$ ,  $\pm 1$ ,  $\pm 2.5$ ,  $\pm 5$  VRMS

#### RESOLUTION

15.25, 30.5, 76.2, 152.5  $\mu$ VRMS

#### CALIBRATION

Excitation sample

#### EXCITATION

3.0 VRMS, 5000 Hz or 2500 Hz sine wave

Software-selectable

#### Accuracy

$\pm 5$  mVRMS typical

#### Current

$\pm 250$  mA max ( $\pm 50$  mA per channel)

Over-current protected

#### Load Regulation

$< 0.1\%$  of full scale for a load variation of 10% to 100% of full load

#### Temperature Stability

Better than  $\pm 0.05\%/^{\circ}C$

#### FILTER

##### Type

Four-pole Butterworth

##### Cutoff Frequency ( $-3$ dB)

5 Hz

### CONFIGURATIONS

StrainSmart Data Systems can be configured in a variety of ways to meet the specific requirements of each user. Each system consists of (1) software, (2) instrumentation hardware, and (3) personal computer.

### SOFTWARE

It is strongly recommended that StrainSmart Software be installed on a Windows-based personal computer for data acquisition, reduction, display, and storage.

*While the hardware for StrainSmart Data Systems may be used with third-party data acquisition software, total system operation becomes the user's responsibility when third-party software is used.*

### INSTRUMENTATION HARDWARE

In addition to a one-time purchase of StrainSmart Software, the initial purchase for each system would normally include one of the following:

#### System 5000 with PCI or PCIe Interface:

Model 5101 PCI or PCIe Interface Card; one or more Model 5100 Scanners; and one or more Model 5110, 5120, 5130, or 5140 Input Cards

### PERSONAL COMPUTER REQUIREMENTS

In addition to StrainSmart Software and Hardware purchased from Micro-Measurements, the system requires access to a properly configured personal computer. The hardware requirements for StrainSmart are:

- Fast Intel Core-2 Duo or better
- 4 GB of memory or better
- 20 GB of available free space or better
- XGA (1024 x 768) or better

### STRAINSMART SOFTWARE

StrainSmart Software is designed to function with all System 5000, 6000, and 7000 hardware. It contains everything needed to acquire, reduce, display, and store measurement data, including:

- StrainSmart Main Operating Program
- Offline Data Presentation Program
- Interactive Help System

All components are supplied on CD-ROM along with a utility for installing them.

An unlimited number of installations can be made within your facility with the one-time purchase of a single copy of StrainSmart.

## StrainSmart® Data Acquisition System

### FEATURES

- From 1 to 1200 input channels
- Individual input cards for strain gage and strain-gage-based transducers (Model 6010A), thermocouples (Model 6020), sensors with high-level voltage outputs (Model 6030A), LVDTs (Model 6040A), piezoelectric sensors (Model 6050), and digital tachometer (Model 6095)
- Built-in bridge completion for 120-, 350-, and 1000-ohm strain gages
- Maximum scan rate of 10,000 samples per second per channel; maximum throughput of 200,000 samples per second
- Simultaneous sampling with anti-aliasing filter and analog-to-digital conversion for each channel
- Stable, accurate, low-noise signal conditioning
- Selectable digital filtering of measurement signals
- High-speed PCI or PCIe hardware interface (Model 6100) and Ethernet network interface (Model 6200A)
- Digital I/O for triggering external events



### DESCRIPTION

System 6000 features data acquisition rates of up to 10,000 samples per second per channel. The hardware is designed to incorporate all the features required for precision strain measurement under a variety of loading conditions, while maintaining flexibility and ease of use. A system can be configured with 1 to 1200 sensors. Strain gages, strain-gage-based transducers, thermocouples, LVDTs, potentiometers, accelerometers, piezoelectric sensors and other transducers can be intermixed by choosing the appropriate sensor card.

All System 6000 components can be easily configured for each test requirement. Both the Model 6100 Scanner (holding up to 20 input cards) and the Model 6200A Scanner (holding up to 16 input cards) function independently. Additionally, the smaller, lighter, portable Model 6200A can operate from a variety of DC power sources, and can be configured to remotely perform data acquisition and storage.

Utilizing the benefits of individual analog-to-digital conversion on each channel and simultaneous sampling data acquisition for all channels, System 6000's Model 6100 Scanners record test data at rates of up to 10,000 samples per second per channel of instrumentation hardware. The PCI or PCIe hardware interface between the scanners and a PC running Strain-Smart software in the Windows XP/Vista/7 environment enables a combined throughput of up to 200,000 samples per second for all channels (for example, 20 channels at 10,000 samples per second per channel or 40 channels at 5000 samples per second per channel).

Selectable, digital FIR low-pass filtering is incorporated into each instrumentation channel to meet a variety of testing requirements. Custom filters are also available.

### MODEL 6100 SCANNER SPECIFICATIONS



- AC powered
- 19-in rack-mountable, 3.5-in high package
- Accepts up to 20 plug-in input cards
- Supports high-speed data transfer and setup of the plug-in cards
- Supports local diagnostics
- Supports software identification and setup of each type of plug-in card

#### OPERATION

Direct software control

#### INPUTS

Accepts up to 20 cards (one channel per card and up to 20 channels per unit)

#### SYNC

Automatic

#### DATA STORAGE

None

#### INTERFACE

Proprietary PCI or PCIe

### StrainSmart® Data Acquisition System

#### SIZE

3.5 H x 19 W x 16 D in (89 x 483 x 381 mm)

#### WEIGHT

17 lb (7.7 kg) empty

19.5 lb (8.8 kg) loaded with 20 plug-in cards

#### POWER

115 or 230 VAC user-selectable;  $\pm 10\%$  of setting;  
50/60 Hz; 200W max.

#### MODEL 6200A SCANNER SPECIFICATIONS



- DC powered (AC optional)
- Compact package
- Accepts up to 16 plug-in input cards
- Supports network communication via a 100BASE-T Ethernet connection
- Multiple units can be linked together to provide common control and synchronous sampling
- Offers user-selectable decimal-based (radix 10) and binary-based (radix 2) scanning rates
- On-board program and data storage
- Supports local diagnostics
- Supports software identification and setup of each type of plug-in card

#### OPERATION

Stand-alone or direct software control

#### INPUTS

Accepts up to 16 cards (one channel per card and up to 16 channels per unit)

#### SYNC

Multiple scanners synchronized with synchronization cable links

#### DATA STORAGE

##### Can be configured:

Internal: 1 GB solid state

Removable: ATA form factor removable storage devices, solid state

#### INTERFACE

**Type:** Ethernet

**Topology:** 100Base-T

**Protocol:** TCP/IP (HTTP)

#### OPERATING VIBRATION

6G peak in all three axes, sweep to 10 Hz (solid state media)

#### OPERATING SHOCK

20G peak in all three axes, 5 shocks in each axis (solid state media)

#### SIZE

4 H x 10 W x 12.3 D in (102 x 254 x 312 mm)

#### WEIGHT

9.1 lb (4.1 kg) empty, 11.1 lb (5.0 kg) loaded with 16 plug-in cards

#### POWER

Designed for use with DC power; 9–32 VDC, 100W max  
Optional power adapter (Model 6207); 120/240 VAC

#### SENSOR CARD SPECIFICATIONS

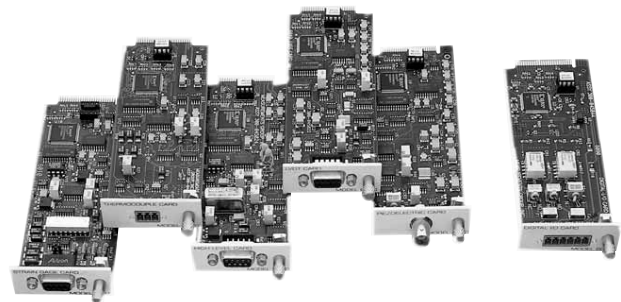

#### MODEL 6010A STRAIN GAGE CARD

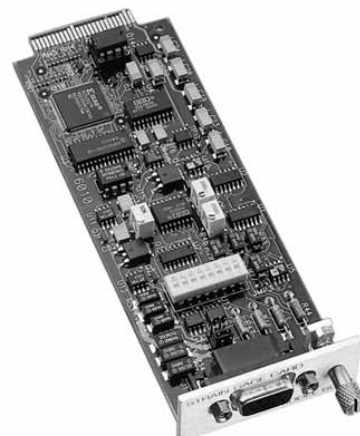

## StrainSmart® Data Acquisition System

- Supports software identification and setup of each type of plug-in card
- Complete strain gage signal conditioner with 16-bit analog-to-digital converter
- Programmable digital filter
- Programmable excitation supply per channel. The supply is settable to 0, 0.5, 1, 2, 5, and 10V. Up to 50 mA of excitation current is available on each channel. Remote sense is provided for full-bridge transducers.
- Programmable gain to complement the excitation steps of 1, 2, 5, and 10V. Full-scale input range will be  $\pm 16,383 \mu\epsilon$ . An excitation setting of 0.5V will use the 1V gain range, but with one-half the resolution. Gain settings are independent per channel.
- Internal bridge completion resistors: 120 $\Omega$ , 350 $\Omega$ , and 1000 $\Omega$  dummy resistors (jumper selectable); 1000 internal half bridge
- Programmable coarse balance range of  $\pm 16,300 \mu\epsilon$  (4096  $\mu\epsilon$  steps)
- Fixed low-pass anti-aliasing filter (six-pole)
- Two programmable shunt calibration circuits
- Input connections to user's strain gage via nine-pin D-sub connector

### CHANNELS

One per card

### INPUTS

#### Strain Gages

120 $\Omega$ , 350 $\Omega$ , 1000 $\Omega$  quarter bridges; 60 $\Omega$  to 5000 $\Omega$  half and full bridges

Jumper-selectable completion resistors (0.01%  $\pm 2.5$  ppm/ $^{\circ}$ C typical)

#### Measurement Range

Normal range mode:  $\pm 16,380 \mu\epsilon$   
High range mode:  $\pm 163,800 \mu\epsilon$   
Low range mode:  $\pm 1638 \mu\epsilon$

#### Resolution

Normal range mode: 0.5  $\mu\epsilon$   
High range mode: 5  $\mu\epsilon$   
Low range mode: 0.05  $\mu\epsilon$

#### Strain Gage Based Transducers

60 $\Omega$  to 5000 $\Omega$  impedance

#### Measurement Range

Normal range mode:  $\pm 8$  mV/V  
High range mode:  $\pm 80$  mV/V  
Low range mode:  $\pm 0.8$  mV/V

#### Resolution

Normal range mode: 0.25  $\mu$ V/V  
High range mode: 2.5  $\mu$ V/V  
Low range mode: 0.025  $\mu$ V/V

### Input Impedance

220 M $\Omega$  each input

### Source Current

$\pm 25$  nA max.

### Input Connector

Nine-pin D-sub style

### AMPLIFIER

#### Zero Temperature Stability

$\pm 1.5 \mu$ V/ $^{\circ}$ C RTI,  $\pm 100 \mu$ V/ $^{\circ}$ C RTO, after 30-minute warm-up

#### DC Gain Accuracy and Stability

( $\pm 0.1\%$  at 23 $^{\circ}$ C)  $\pm 50$  ppm/ $^{\circ}$ C

#### Common-Mode Rejection (DC to 60 Hz)

100 dB typical

#### Common-Mode Voltage

$\pm 6$ V typical

#### AC Accuracy (Typical)

Input Frequency/Bandwidth	500/3000	50/200
Spurious Free Dynamic Range	100 dB	110 dB
Signal to Noise	90 dB	95 dB
Signal to Distortion	100 dB	110 dB

#### Coarse Balance Range

$\pm 99\%$  of measurement range (typically  $\pm 16,300 \mu\epsilon$ )

### CALIBRATION

Two shunt calibration points are available on each channel

Switch-selectable

Calibration switches, A and B, are software selectable

### EXCITATION

0.0, 0.5, 1.0, 2.0, 5.0, and 10.0 VDC. Software programmable.

#### Accuracy

$\pm 3$  mV typical

#### Current

50 mA max; over-current protected

#### Load Regulation

<0.05% of full scale for a load variation of 10% to 100% of full load

#### Temperature Stability

Better than  $\pm 0.005\%/^{\circ}$ C

#### Remote Sense

15 $\Omega$  maximum lead resistance

### StrainSmart® Data Acquisition System

#### A/D CONVERTER

##### Type

16-bit successive approximation with integrated sample and hold

##### Integral Linearity Error

±2 LSB

#### FILTERS

Linear phase, analog, 6-pole anti-aliasing filter, and 256-tap, programmable, FIR digital filter (lowpass)

##### Passband Frequency

User-selectable 1 Hz to 4 kHz

#### ANALOG OUTPUT (6010A Version Only)

##### Type

±5.00V max for typical full-scale input of ±16,380 µε

##### Output Load

2000Ω min

##### Bandwidth

DC to 15 kHz (–0.5 dB typical)

#### MODEL 6020A THERMOCOUPLE CARD

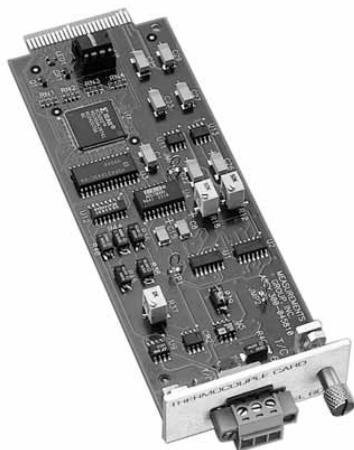

- Complete thermocouple signal conditioner with 16-bit analog-to-digital converter
- Programmable digital filter
- Programmable common cold-junction reference
- Compensation is provided for J, K, T, N, E, R, S, and B thermocouple types
- Fixed low-pass anti-aliasing filter (six-pole)
- Connections to user's thermocouple circuit via a removable three-terminal screw connector

#### CHANNELS

One per card

#### INPUTS

Thermocouple types J, K, T, E, N, R, S, B. Built-in electronic cold-junction compensation. Software-selectable.

Open sensor detection

##### Input Impedance

10 MΩ differential, 100 KΩ common mode

##### Source Current

±0.5 nA typical; ±5 nA max.

##### Input Connector

Three-position screw terminal

#### AMPLIFIER

##### Zero Temperature Stability

±1.5 µV/°C RTI, ±100 µV/°C RTO, after 30-minute warm-up

##### DC Gain Accuracy and Stability

0.05% at 23°C ± 50 ppm/°C

##### Common-Mode Rejection (DC to 60 Hz)

100 dB typical

##### Common-Mode Voltage

±6V typical

##### AC Accuracy (Typical)

Input Frequency/Bandwidth	500/3000	50/200
Spurious Free Dynamic Range	100 dB	110 dB
Signal to Noise	90 dB	95 dB
Signal to Distortion	100 dB	110 dB

#### MEASUREMENT RANGE

±81.9 mV

#### RESOLUTION

2.5 µV

#### A/D CONVERTER

##### Type

16-bit successive approximation with integrated sample and hold

##### Integral Linearity Error

±2 LSB

#### FILTERS

Linear phase, analog, 6-pole anti-aliasing filter, and 256-tap, programmable, FIR digital filter (lowpass)

##### Passband Frequency

User-selectable 1 Hz to 4 kHz



StrainSmart® Data Acquisition System

**MODEL 6030A HIGH-LEVEL INPUT CARD**



- Complete high-level signal conditioner with 16-bit analog-to-digital converter
- Programmable gain
- Programmable digital filter
- Programmable excitation supply. The supply is settable to 0, 0.5, 1, 2, 5, 10, 15, 20, 24, and 30V. Up to 50 mA of current is available on each channel
- Fixed low-pass anti-aliasing filter (six-pole)
- Input connections to user's voltage source via nine-pin D-sub connector
- Analog output

**CHANNELS**

One per card

**INPUTS**

DC volts (differential)

**Input Impedance**

22 MΩ each input

**Source Current**

±2 nA typical

±100 nA max

**Input Connector**

Nine-pin D-sub style

**AMPLIFIER**

**Zero Temperature Stability**

±2 μV/°C RTI, typical. ±100 μV/°C RTO, after 30-minute warm-up

**DC Gain Accuracy and Stability**

±0.05% at 23°C ± 20 ppm/°C

**Common-Mode Rejection (DC to 60 Hz)**

86 dB typical at X1 gain

94 dB typical at X10 gain

**Common-Mode Voltage**

±12V typical

**AC Accuracy (Typical)**

Input Frequency/Bandwidth	500/3000	50/200
Spurious Free Dynamic Range	100 dB	110 dB
Signal to Noise	90 dB	95 dB
Signal to Distortion	100 dB	110 dB

**MEASUREMENT RANGES**

±1, ±2, ±5, ±10 VDC

**RESOLUTION**

30.5, 61, 152.5, 305 μV

**EXCITATION**

0, 0.5, 1.0, 2.0, 5.0, 10.0, 15.0, 20.0, 24.0, 30.0 VDC

**Accuracy**

±10 mV typical at 0 to 24 VDC; ±5% at 30 VDC

**Current**

50 mA max. Over-current protected

**Load Regulation**

<±0.05% of full scale for a load variation of 10% to 100% of full load

**Temperature Stability**

Better than ±0.005%/°C

**A/D CONVERTER**

**Type**

16-bit successive approximation with integrated sample and hold

**Integral Linearity Error**

±2 LSB

**FILTERS**

Linear phase, analog, 6-pole anti-aliasing filter, and 256-tap, programmable, FIR digital filter (lowpass)

**Passband Frequency**

User-selectable 1 Hz to 4 kHz

**ANALOG OUTPUT (6030A Version Only)**

**Type**

±5.00V max for typical full-scale input of ±32,767 μe

**Output Load**

2000Ω min

**Bandwidth**

DC to 15 kHz (-0.5 dB typical)

## StrainSmart® Data Acquisition System

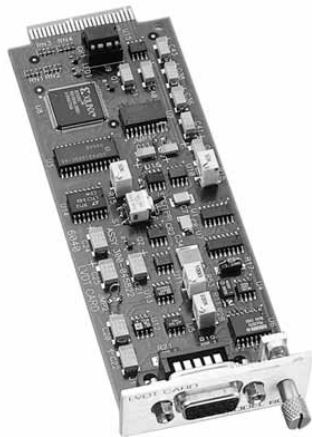
**MODEL 6040A LVDT CARD**

- Complete LVDT signal conditioner with 16-bit analog-to-digital converter
- Programmable digital filter
- Independent AC excitation supply
- Programmable gain steps of 1, 2, 5, and 10
- Supports six-, five-, four-, and three-wire transducers
- Fixed low-pass anti-aliasing filter (six-pole)
- Excitation reference provided for calibration
- Input connections to user's transducer via nine-pin D-sub connector

**CHANNELS**

One per card

**INPUTS**

3- to 6-wire transducers

**Input Impedance**

10 M $\Omega$  each input

**Source Current**

$\pm 2$  nA typical;  $\pm 100$  nA max

**Input Connector**

Nine-pin D-sub style

**AMPLIFIER****Zero Temperature Stability**

$\pm 2$   $\mu\text{V}/^\circ\text{C}$  RTI, typical.  $\pm 100$   $\mu\text{V}/^\circ\text{C}$  RTO, after 30-minute warm-up

**Gain Accuracy and Stability**

$\pm 0.25\%$  typical

**Common-Mode Rejection (DC to 60 Hz)**

86 dB typical at X1 gain

94 dB typical at X10 gain

**Common-Mode Voltage**

$\pm 12\text{V}$  typical

**MEASUREMENT RANGES**

$\pm 0.5$ ,  $\pm 1$ ,  $\pm 2.5$ ,  $\pm 5$  VRMS

**RESOLUTION**

15.25, 30.5, 76.2, 152.5  $\mu\text{VRMS}$

**CALIBRATION**

Excitation sample

**EXCITATION**

3.0 VRMS at 2500, 5000, or 10000 Hz sine wave  
Software-selectable

**Accuracy**

$\pm 5$  mVRMS typical

**Current**

$\pm 50$  mA max. Over-current protected

**Load Regulation**

$< \pm 0.1\%$  of full scale for a load variation of 10% to 100% of full load

**Temperature Stability**

Better than  $\pm 0.05\%/^\circ\text{C}$

**A/D CONVERTER****Type**

16-bit successive approximation with integrated sample and hold

**Integral Linearity Error**

$\pm 2$  LSB

**FILTERS**

Butterworth, six-pole anti-aliasing analog filter, and 256-tap, programmable, FIR digital filter (lowpass)

**Passband Frequency**

User-selectable 1 Hz to 4 kHz

**ANALOG OUTPUT (6040A Version Only)**

Linear Output:  $\pm 5.00\text{V}$  for typical full-scale input

Output Load: 2000 $\Omega$  min

Bandwidth: DC to 1 kHz ( $-3$  dB typical)

StrainSmart® Data Acquisition System

**MODEL 6050 PIEZOELECTRIC CARD**

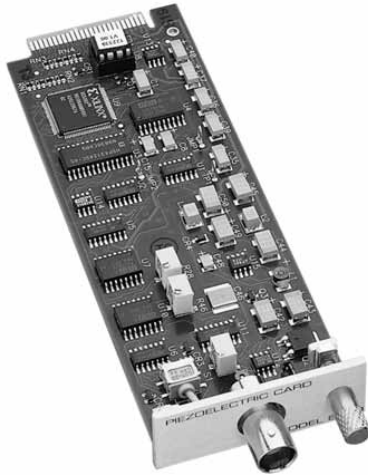

- Complete piezoelectric signal conditioner with 16-bit analog-to-digital converter
- Supports both VM (voltage mode, low impedance) and CM (charge mode, high impedance) type piezoelectric transducers
- Programmable constant current excitation supply for VM transducers is software settable to 1, 2, 4, 5, 10 and 20 mA
- Programmable gain steps of 1, 2, 5, and 10 for VM transducers and steps of 1, 2, 5, 10, 20, 50 and 100 for CM transducers
- Programmable digital filter
- Fixed low-pass anti-aliasing filter (six-pole)
- Input connections to user's transducer via BNC connector

**CHANNELS**

One per card

**INPUTS**

Voltage mode (VM) or charge mode (CM) piezoelectric type transducers (type is switch-selectable)

**Coupling**

**CM Type:** Charge amplifier with software-selectable time constants of 0.5 and 5 seconds

**VM Type:** AC coupling to remove DC bias voltage with high pass response of 0.1 Hz (-3 dB)

**Input Connector**

Female BNC

**AMPLIFIER**

**Zero Temperature Stability**

$\pm 10 \mu\text{V}/^\circ\text{C}$  RTI, typical, after 30-minute warm-up

**Charge Amplifier Zero Stability**

$\pm 1.2 \text{ pC}/^\circ\text{C}$  RTI typical at 0.5 second time constant

**DC Gain Accuracy and Stability**

$\pm 0.1\%$  at  $+23^\circ\text{C}$ ;  $\pm 25 \text{ ppm}/^\circ\text{C}$

**AC Accuracy (Typical at X2 Gain Step)**

Input Frequency/Bandwidth	500/3000	50/200
Spurious Free Dynamic Range	100 dB	110 dB
Signal to Noise	90 dB	95 dB
Signal to Distortion	100 dB	110 dB

**MEASUREMENT RANGES**

**VM Type Transducers**

$\pm 10.5\text{V}$ ,  $\pm 5.25\text{V}$ ,  $\pm 2.1\text{V}$ , and  $\pm 1.05\text{V}$

**CM Type Transducers**

$\pm 200\,000 \text{ pC}$ ,  $\pm 100\,000 \text{ pC}$ ,  $\pm 40\,000 \text{ pC}$ ,  $\pm 20\,000 \text{ pC}$ ,  $\pm 10\,000 \text{ pC}$ ,  $\pm 4000 \text{ pC}$ , and  $\pm 2000 \text{ pC}$

**RESOLUTION**

0.0015% of range

**CALIBRATION**

Excitation sample

**EXCITATION**

0, 1, 2, 4, 5, 10 and 20 mA selections for VM type transducers

**Accuracy**

$\pm 1\% + (\pm 30 \mu\text{A})$  typical at 1 to 20 mA

**Voltage Compliance**

0 to 28V

**Temperature Stability**

$\pm 50 \text{ ppm}/^\circ\text{C}$

**A/D CONVERTER**

**Type**

16-bit successive approximation with integrated sample and hold

**Integral Linearity Error**

$\pm 2 \text{ LSB}$

**FILTERS**

Linear phase, analog, 6-pole anti-aliasing filter, and 256-tap, programmable, FIR digital filter (lowpass)

**Passband Frequency**

User-selectable 1 Hz to 4 kHz

### StrainSmart® Data Acquisition System

#### MODEL 6095 DIGITAL/TACHOMETER CARD

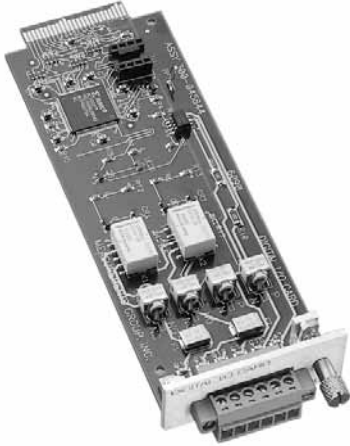

- Multi-function digital input card
- Relay output for control functions
- Compatible with all System 6000 hardware
- Supported by StrainSmart software

When used in conjunction with Micro-Measurements StrainSmart® Software, the Model 6095 Digital/Tachometer Card enables the user to capture and reduce data in any one of five operating modes:

- Tachometer Mode
- Interval Mode
- Quadrature Mode
- Counter Mode
- Digital Input Mode

Depending upon the mode selected, data can be reduced as a digital input; counts; interval counts; pulses; rate; shaft angle; RPM; radians or degrees per second; elapsed time (milliseconds, seconds or minutes); or calculated values.

Multiple Model 6095 Cards can be used in each system, and each card in a system can be configured individually to any operating mode. However, the relay provides one distinct control function (on/off control for testing machines, etc.) per system when using a Model 6100 Scanner, or one per scanner when using multiple Model 6200 Scanners.

The Model 6095 is compatible with all Model 6100 and 6200 Scanners. It is supported by Version 3.0, and later, StrainSmart Software; no-charge upgrades are available upon request.

#### INPUT CONNECTOR

Nine-pin, D-sub style

#### RELAY OUTPUTS

##### Quantity

One

##### Configuration

NO and NC, 500 mA contact at 30 VAC or 30 VDC into resistive load

#### DIGITAL INPUTS

##### Quantity

Four

##### Configuration

Optically isolated. TTL Schmitt-trigger input thresholds accept up to 28 VDC without damage. 2.23 $\Omega$  pull-up resistors can be selected for each input.

##### Impedance

50 k $\Omega$

##### Data Rate

DC to 200 kHz

##### Accessory Supply

5 Volt  $\pm$  5%, 75 mA

#### CONFIGURATIONS

StrainSmart Data Systems can be configured in a variety of ways to meet the specific requirements of each user. Each system consists of (1) software, (2) instrumentation hardware, and (3) personal computer.

#### SOFTWARE

It is strongly recommended that StrainSmart Software be installed on a Windows-based personal computer for data acquisition, reduction, display, and storage.

While the hardware for StrainSmart Data Systems may be used with third-party data acquisition software, total system operation becomes the user's responsibility when third-party software is used.

#### INSTRUMENTATION HARDWARE

In addition to a one-time purchase of StrainSmart Software, the initial purchase for each system would normally include one of the following:

- **System 6000 with PCI or PCIe Interface**—Model 6101PCI or Model 6101PCIe Interface Card, at least one Model 6100 Scanner, and at least one Model 6010, 6020, 6030, 6040, 6050, or 6095 Input Card
- **System 6000 with Ethernet Interface**—At least one Model 6200 Scanner and at least one Model 6010, 6020, 6030, 6040, 6050, or 6095 Input Card

StrainSmart® Data Acquisition System

**PERSONAL COMPUTER REQUIREMENTS**

In addition to StrainSmart® Software and Hardware purchased from Micro-Measurements, the system requires access to a properly configured personal computer. The hardware requirements for StrainSmart are:

- Fast Intel Core-2 Duo or better
- 4 GB of memory or better
- 20 GB of available free space or better
- XGA (1024 x 768) or better

**STRAINSMART SOFTWARE**

StrainSmart Software is designed to function with all System 5000, 6000, and 7000 hardware. It contains everything needed to acquire, reduce, display, and store measurement data, including:

- StrainSmart Main Operating Program
- Offline Data Presentation Program
- Interactive Help System

All components are supplied on CD-ROM along with a utility for installing them.

An unlimited number of installations can be made within your facility with the one-time purchase of a single copy of StrainSmart.

## StrainSmart® Data Acquisition System

### FEATURES

- Stable, accurate, low-noise signal conditioning
- Measurement accuracy  $\pm 0.05\%$
- Measurement resolution 0.5 microstrain
- Individual input cards for strain gage and strain-gage based transducers, thermocouples, sensors with high-level voltage outputs, and LVDTs
- Electronically selectable, built-in bridge completion for 120-, 350-, and 1000-ohm strain gages
- Virtually unlimited number of channels in increments of 8 channels
- Maximum scan rate of 2048 samples per second
- Self calibration traceable to NIST standard
- Simultaneous sampling with anti-aliasing filter and analog-to-digital conversion for each channel
- Selectable digital filtering of measurement signals
- High-speed Ethernet network interface
- Remote Utility includes capability for acquiring data without connection to a computer (field upgradeable)

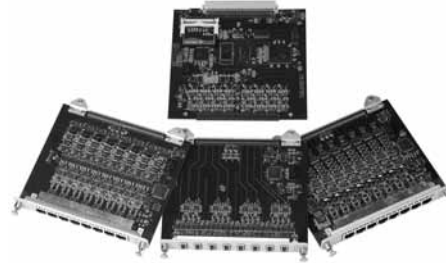

### DESCRIPTION

Micro-Measurements System 7000 builds upon the years of experience gained since the introduction of Systems 4000, 5000, and 6000 by continuing to provide a complete hardware/software approach to data acquisition, reduction, and presentation for strain gages and related sensors for stress analysis testing.

System 7000 hardware is designed to incorporate all the features required for precision strain measurement in a high channel density enclosure. Strain gages, strain-gage-based transducers, thermocouples, LVDTs, and other sensors with high level voltage outputs can be intermixed in groups of eight (8) by choosing the appropriate sensor card for up to 128 channels in a 4U height, 19-inch rack-mountable scanner (7000-128-SM). A 32-channel scanner is also available (7000-32-SM). The Ethernet interface allows flexible positioning of scanners, and multiple scanners can easily be synchronized using a single sync cable (maximum length 100 meters). A system can be configured with virtually an unlimited number of sensors.

System 7000 is a high performance data acquisition instrument with measurement accuracy of  $\pm 0.05\%$  of full scale. Each sensor card employs a 24-bit analog-to-digital converter enabling 0.5 microstrain resolution. Scan rates up to 2048 samples per second are available for

simultaneous reading of all sensor inputs. A combination of analog and flexible Finite Impulse Response (FIR) filters are available to provide adequate anti-alias filtering at all scanning rates. Each sensor card has high-capacity nonvolatile data storage capability. Electronically selectable bridge completion resistors allow the user to choose between 120-, 350-, and 1000-ohm strain gages through software selection.

Several design features are provided to reduce total cost of ownership. System 7000 is capable of self-calibration with a removable calibration reference (7000-SM-VC). Calibration can be performed anywhere and there is no need to return the entire system to the factory for calibration. Down-time while waiting for calibration is essentially eliminated. Input connectors are RJ-45 type and assembly time is fast using simple cable crimping tools. Sensor input cards all use common Analog Input Cards (Model 7003-8-A-I), which thereby allow users to interchange sensor input cards with analog input cards. Individual scanners can be separated and located near sensors to reduce sensor cabling costs.

A feature for acquiring data without a connection to a computer has been added. This Remote Utility Feature is field upgradeable on units purchased prior to the introduction of this feature. With this feature, data can be collected then exported to other applications for analysis.

StrainSmart® Data Acquisition System

**SCANNER SPECIFICATIONS  
(128 CHANNEL VERSION)**



The purpose of the Model 7000-128-SM Scanner is to house and retain the acquisition cards, regulate power to the cards, establish and maintain communication between the Ethernet interface and the input cards, synchronize the analog-to-digital converters in the system, and provide visual status information to the operator.

**CAPACITY**

Up to 16 Input Cards. 128 channels maximum

**CONFIGURATIONS**

Rack-mount (19-inch) or bench-top

**LCD DISPLAY**

64 x 128 white LED-backlit display

**LED PANEL**

128 individual red/green LEDs; one per channel

**KEYPAD**

Membrane. 20-key; 12-key numeric keypad, 5 key navigation keypad, and 3 soft-keys

**INPUT POWER**

11–32 VDC, 30A max

**POWER INDICATION**

Green LED (illuminated when power is on)

**ETHERNET INTERFACE**

IEEE 802.3, 802.3u 10Base-T, 100Base-TX, half- and full-duplex, auto-detect

**COMPACT FLASH® CAPACITY**

1 GB supplied (removable)

**PROCESSOR**

250 MHz floating point digital signal processor

**MEMORY**

64 MB SDRAM

**INTERNAL COMMUNICATION**

Asynchronous command bus, synchronous data bus

**SYSTEM SYNCHRONIZATION**

**Connections:** Sync In, Sync Out

**Topology:** Daisy-chain

**Cable Connection:** TIA/EIA RJ-45, Category 5

**Max. Distance:** 100m

**SYSTEM CALIBRATION REFERENCE**

Firmware-controlled

**Drift:** 1.9 ppm/°C ±0.6 µV/°C typical, 9.4 ppm/°C ±2.1 µV/°C maximum

**Resolution:** 150 µV nominal

**Voltage Range:** ±5V

**DIMENSIONS**

7.5 H x 17.5 W x 13.5 D in (190 x 445 x 343 mm)

**WEIGHT**

20 lb (9.1 kg)

**SCANNER SPECIFICATIONS  
(32-CHANNEL VERSION)**



The purpose of the Model 7000-32-SM Scanner is to house and retain the acquisition cards, regulate power to the cards, establish and maintain communication between the Ethernet interface and the input cards, synchronize the analog-to-digital converters in the system, and provide visual status information to the operator.

**CAPACITY**

Up to 4 Input Cards. 32 channels maximum

**CONFIGURATIONS**

Bench-top

## StrainSmart® Data Acquisition System

### LCD DISPLAY

64 x 128 white LED-backlit display

### LED PANEL

32 individual red/green LEDs; one per channel

### KEYPAD

Membrane. 20-key; 12-key numeric keypad, 5 key navigation keypad, and three soft-keys

### INPUT POWER

11–32 VDC, 30A max

### POWER INDICATION

Green LED (illuminated when power is on)

### ETHERNET INTERFACE

IEEE 802.3, 802.3u 10Base-T, 100Base-TX, half- and full-duplex, auto-detect

### COMPACT FLASH® CAPACITY

1 GB supplied (removable)

### PROCESSOR

250 MHz floating point digital signal processor

### MEMORY

64 MB SDRAM

### INTERNAL COMMUNICATION

Asynchronous command bus, synchronous data bus

### SYSTEM SYNCHRONIZATION

**Connections:** Sync In, Sync Out

**Topology:** Daisy-chain

**Cable Connection:** TIA/EIA RJ-45, Category 5

**Max. Distance:** 100m

### SYSTEM CALIBRATION REFERENCE

Firmware-controlled

**Drift:** 1.9 ppm/°C ± 0.6 µV/°C typical, 9.4 ppm/°C ± 2.1 µV/°C maximum

**Resolution:** 150 µV nominal

**Voltage Range:** ±5V

### DIMENSIONS

7.5 H x 7.1 W x 13.5 D in (190 x 180 x 343 mm)

### WEIGHT

10.1 lb (4.6 kg)

### STRAIN GAGE INPUT CARDS



A choice of two Strain Gage Input Cards (7003-8-SG or 7003-8-SG-A) are used in conjunction with the Model 7003-8-A-I Analog Input Card to perform bridge excitation, bridge completion, shunt calibration, and signal conditioning for eight quarter, half, and full bridges. Note that the 7003-8-SG-A Strain Gage Input Card with Analog Output has an analog output which provides an amplified representation of the input source.

### CHANNELS

Eight per card

### INPUTS

Software selectable for S+/S-, VCAL+/VCAL-, or excitation

**Strain Gage:** 120Ω, 350Ω, 1000Ω quarter-bridges; 60Ω to 5000Ω half- and full-bridges

**Input Impedance:** 220 MΩ nominal each input

**Source Current:** ±5 nA per volt excitation

### ANALOG OUTPUT (MODEL 7003-8-SG-A ONLY)

**Fixed Gain:** 50.3 V/V ±1%

**Output Range:** ±10V min

**Output Load:** 2000Ω min

**Bandwidth:** DC to 4.2 kHz (–3 dB ±0.25 dB)

### MEASUREMENT RANGE AND RESOLUTION

Total range depends upon excitation setting (see table).

**Resolution:** 0.5 µε (GF=2)

EXCITATION VOLTS	MEASURING RANGE Includes Full Scale Imbalance	
	µε @ GF=2	mV/V
0	48,000	24*
0.25	100,000	50
0.5	96,000	48
0.75	70,000	35
1	48,000	24
2	24,000	12
3	16,000	8
4	50,000	25
5	40,000	20
6	35,000	17.5
7	30,000	15
8	25,000	12.5
9	20,000	10
10	20,000	10

\*Based on 1 volt excitation



StrainSmart® Data Acquisition System

**INPUT CONNECTOR**

Eight-pin TIA/EIA RJ-45 (Amp type 554739 or equivalent)

**AMPLIFIER**

**Zero Temperature Stability:**  $\pm 1 \mu\text{V}/^\circ\text{C}$  RTI, after 60-minute warm-up

**DC Gain Accuracy and Stability:**  $\pm 0.05\%$ ;  $\pm 50 \text{ ppm}/^\circ\text{C}$  (1 year without periodic VCAL)

**Analog Input (Including Full-Scale Balance):**

Low Range:  $\pm 50 \text{ mV}$

High Range:  $\pm 220 \text{ mV}$

Linearity:  $\pm 0.02\%$  of Full Scale

Common-Mode Rejection:  $>90 \text{ dB}$  (DC to 60 Hz)

Common-Mode Voltage Range:  $\pm 12\text{V}$  typical

**BALANCE**

**Type:** Software (mathematical)

**Range:** Full ADC range

**EXCITATION**

**Selection:** Software controlled

**Resolution:** 1 mV

**Accuracy:**  $\pm 4 \text{ mV}$  typical (Firmware measures excitation variations during arming process)

**Current:** 50 mA max. per channel

Over-current limited

Over-current indication

**Load Regulation:**  $<0.05\%$  of full scale for 10% to 100% of full scale load with remote sense

**Temperature Stability:**  $\pm 10 \text{ ppm}/^\circ\text{C}$

**QUARTER-BRIDGE COMPLETION**

**Selection:** Firmware controlled

**Accuracy and Drift:**

120 $\Omega$  and 350 $\Omega$ :  $\pm 0.01\%$ , 2.8 ppm/ $^\circ\text{C}$  max.

1 k $\Omega$ :  $\pm 0.01\%$ , 1.6 ppm/ $^\circ\text{C}$  max. (socketed)

**SHUNT CALIBRATION**

**Selection:** Firmware controlled

**Configuration:**

Internal: P- to D120, P- to D350, P- to D1000

Remote: RcalA to RcalB

**Sockets:** Tin-plated

**Levels:** Simulates 10,000  $\mu\epsilon$  @ GF = 2.0

**Values:**

P- to D120: 5940 $\Omega$   $\pm 0.1\%$

P- to D350: 17,325 $\Omega$   $\pm 0.1\%$

P- to D1000: 49,500 $\Omega$   $\pm 0.1\%$

**SYSTEM CALIBRATION**

Firmware controlled

**Calibration voltage:** Supplied by Model 7000-SM-VC voltage calibration card

**Type:** Ten point calibration

**SIZE**

6.5 L x 6.5 W x 0.9 H in (165 x 165 x 23 mm)

**WEIGHT**

0.45 lb (0.2 kg)

**THERMOCOUPLE INPUT CARD**



The Model 7003-8-TC Thermocouple Input Card is used in conjunction with the Model 7003-8-A-I Analog Input Card to perform signal conditioning and cold-junction compensation for thermocouple types J, K, T, E, N, R, S, and B.

**CHANNELS**

Eight per card

**INPUTS**

**Supported Thermocouple Types:** J, K, T, E, N, R, S, B

Cold-junction compensation, software-selectable

Open-sensor detection

**Input Impedance:** 220 M $\Omega$  nominal each input

**INPUT CONNECTORS**

Five-position connector with screw terminals

**AMPLIFIER**

**Zero Temperature Stability:**  $\pm 2 \mu\text{V}/^\circ\text{C}$  RTI,  $\pm 10 \mu\text{V}/^\circ\text{C}$  RTO, after 60-minute warm-up

**DC Gain Accuracy and Stability:**  $\pm 0.1\%$ ;  $\pm 30 \text{ ppm}/^\circ\text{C}$

**Linearity:**  $\pm 0.02\%$  of Full Scale

**Common Mode Rejection (DC to 60 Hz):**  $>90 \text{ dB}$

**Common Mode Voltage Range:**  $\pm 12\text{V}$  typical

## StrainSmart® Data Acquisition System

### MEASUREMENT RANGE AND RESOLUTION

Range:  $\pm 81.9$  mV  
 Resolution: 1°C minimum

### ACCURACY

$\pm 2^\circ\text{C}$

### SIZE

6.5 L x 6.5 W x 0.9 H in (165 x 165 x 23 mm)

### WEIGHT

0.45 lb (0.2 kg)

### HIGH LEVEL INPUT CARD



The Model 7003-8-HL High Level Input Card is used in conjunction with the Model 7003-8-A-I Analog Input Card to perform signal conditioning and excitation for high level ( $\pm 10\text{V}$ ) inputs.

### CHANNELS

Eight per card

### INPUTS

Differential

**Input Impedance:** 220 M $\Omega$  nominal each input

**Input Bias Current:**  $\pm 0.5$  nA typical ( $\pm 2$  nA max.)

### INPUT CONNECTOR

Eight-pin RJ-45

### AMPLIFIER

**Zero Temperature Stability:**  $\pm 2$   $\mu\text{V}/^\circ\text{C}$  RTI, typical,  $\pm 10$   $\mu\text{V}/^\circ\text{C}$  RTO, after 60-minute warm-up

**DC Gain Accuracy and Stability:**  $\pm 0.1\%$ ;  $\pm 30$  ppm / $^\circ\text{C}$

**Linearity:**  $\pm 0.02\%$  of Full Scale

**Common-Mode Rejection (DC to 60 Hz):**  $>90$  dB

**Common-Mode Voltage Range:**  $\pm 12\text{V}$  typical

### MEASUREMENT RANGES AND RESOLUTION

**Range:**  $\pm 10\text{V}$

**Resolution:** 100  $\mu\text{V}$  effective

### EXCITATION

**Selection:** Software controlled

**Bipolar Range:** 0 to  $\pm 12$  VDC (24 VDC total)

**Unipolar Range:** 0 to +12 VDC

**Accuracy:**  $\pm 0.1\%$  of full scale using remote sense

**Current:** 50 mA max. Over-current/over-temperature protected

**Load Regulation:**  $<0.05\%$  of full scale (bipolar mode) for a load variation of 10% to 100% of full scale load (with remote sense)

**Temperature Stability:** Better than  $\pm 30$  ppm/ $^\circ\text{C}$

### DIMENSIONS

6.5 L x 6.5 W x 0.9 H in (165 x 165 x 23 mm)

### WEIGHT

0.45 lb (0.2 kg)

### LVDT CARD



The Model 7003-8-LVDT is used in conjunction with the Model 7003-8-A-I Analog Input Card to perform signal conditioning, polarity demodulation and AC excitation for transformer type transducers.

### CHANNELS

Eight per card

### INPUTS

Six-, five-, four- and three-wire transducers

**Input Impedance:** 220 M $\Omega$  nominal each input with 0.001  $\mu\text{F}$  parallel to both inputs

**Input Bias Current:**  $\pm 0.5$  nA typical ( $\pm 2$  nA max.)

### INPUT CONNECTOR

Eight-pin RJ-45

### AMPLIFIER

**Zero Temperature Stability:**  $\pm 2$   $\mu\text{V}/^\circ\text{C}$  RTI, typical,  $\pm 10$   $\mu\text{V}/^\circ\text{C}$  RTO, after 60-minute warm-up

**DC Gain Accuracy and Stability:**  $\pm 0.25\%$ ,  $\pm 30$  ppm/ $^\circ\text{C}$

**Common-Mode Rejection (DC to 60 Hz):**  $>90$  dB

**Common-Mode Voltage Range:**  $\pm 12\text{V}$  typical

StrainSmart® Data Acquisition System

**POST DEMODULAR FILTER**

**Type:** Low-Pass  
**Frequency:** 1.0 kHz @ -3 dB  
**Number of Poles:** Six  
**Topology:** Butterworth

**MEASUREMENT RANGE AND RESOLUTION**

**Range:** ±5 VRMS  
**Resolution:** 50 µVRMS effective

**EXCITATION**

**Selection:** Software controlled  
**Frequency:** 2500, 5000, or 10000 Hz sine wave  
**Amplitude:** 3 VRMS  
**Accuracy:** ±0.5% of full scale typical  
**Current:** 50 mA max. Over-current/over-temperature protected  
**Load Regulation:** <0.1% of full scale for a load variation of 10% to 100% of full scale load  
**Temperature Stability:** Better than ±0.05%/°C

**SIZE**

6.5 L x 6.5 W x 0.9 H in (165 x 165 x 23 mm)

**WEIGHT**

0.45 lb (0.2 kg)

**ANALOG INPUT CARD**

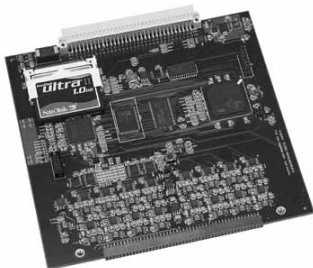

The Model 7003-8-A-I Analog Input Card performs the analog anti-alias filtering, analog-to-digital conversion and data storage for the System. The Model 7003-8-A-I is used in conjunction with a Sensor Input Card, which performs the sensor-specific analog conditioning.

The Model 7003-8-A-I consists of eight dedicated 3-pole constant delay analog anti-alias filters, eight fully synchronized, 24 bit analog-to-digital converters operating at 40k samples/second/channel, a dedicated digital signal processor to perform scaling and digital filtering, a pretrigger buffer with a capacity of over one-half million samples per channel, and 1 GB of CompactFlash® memory for data storage.

**CHANNELS**

Eight per card

**A/D CONVERTER**

**Quantity:** Eight (one per channel)  
**Architecture:** Sigma-delta  
**Resolution:** 24 bits  
**Conversion Rate:**  
Radix-10: 40k samples/second/channel  
Radix-2: 40.96k samples/second/channel

**DATA RECORDING RATES**

2048, 1024, 512, 256, 128, or 64 samples/second/channel (radix-2)  
2000, 1000, 500, 200, 100, or 10 samples/second/channel (radix-10)

**PRE-TRIGGER BUFFER**

**Type:** SDRAM, firmware-controlled  
**Depth:** 645,276 samples/channel

**ANALOG ANTI-ALIAS FILTER**

**Type:** Low-pass  
**Frequency:** 3.5 kHz @ -3 dB  
**Number of Poles:** Three  
**Topology:** GIC, constant delay

**PROCESSOR**

**Type:** 32-bit floating point digital signal processor  
250 MHz operating frequency

**RAM**

**Type:** SDRAM  
**Size:** 64 MB

**PROGRAM AND CALIBRATION DATA STORAGE**

**Type:** Flash Memory  
**Size:** 1 MB

**DATA STORAGE**

**Type:** Sandisk Ultra-Series II® CompactFlash  
**Quantity:** One per card  
**Capacity:** 1 GB supplied. Removable

**SIZE**

6.8 L x 6.5 W x 0.7 H in (173 x 165 x 18 mm)

**WEIGHT**

0.35 lb (0.16 kg)

## StrainSmart® Data Acquisition System

### CONFIGURATIONS

StrainSmart® Data Systems can be configured in a variety of ways to meet the specific requirements of each user. Each system consists of (1) software, (2) instrumentation hardware, and (3) personal computer.

### SOFTWARE

It is strongly recommended that StrainSmart Software be installed on a Windows-based personal computer for data acquisition, reduction, display, and storage.

While the hardware for StrainSmart Data Systems may be used with third-party data acquisition software, total system operation becomes the user's responsibility when third-party software is used.

### INSTRUMENTATION HARDWARE

In addition to a one-time purchase of StrainSmart Software, the initial purchase for each system would normally include one of the following:

**System 7000 with Ethernet Interface**—At least one Model 7000-128-SM Scanner or Model 7000-32-SM Scanner, and at least one Model 7003-8-SG, 7003-8-SG-A, 7003-8-HL, or 7003-8-TC Input Card, each connected to a Model 7003-8-A-I Analog Input Card

### PERSONAL COMPUTER REQUIREMENTS

In addition to StrainSmart Software and Hardware purchased from Micro-Measurements, the system requires access to a properly configured personal computer. The hardware requirements for StrainSmart are:

- Fast Intel Core-2 Duo or better
- 4 GB of memory or better
- 20 GB of available free space or better
- XGA (1024 x 768) or better

### STRAINSMART SOFTWARE

StrainSmart Software is designed to function with all System 5000, 6000, and 7000 hardware. It contains everything needed to acquire, reduce, display, and store measurement data, including:

- StrainSmart Main Operating Program
- Offline Data Presentation Program
- Interactive Help System

All components are supplied on CD-ROM along with a utility for installing them.

An unlimited number of installations can be made within your facility with the one-time purchase of a single copy of StrainSmart.



Model 1300 .....	58
Model 700 .....	60
RS-200 .....	62

# Special-Purpose Instruments

## Gage Installation Tester

### FEATURES

- A compact, battery-powered instrument used to verify the electrical quality of a strain gage installation BEFORE it is placed in service
- Reads with the push of a button—no warm-up
- Reads insulation resistance (leakage) to 20,000 megohms with 15 VDC
- Measures deviation of installed gage resistance from precise standards to a resolution of 0.02%
- Ohmmeter scale for troubleshooting questionable installations
- Verifies the complete gage circuit, including leadwires



### DESCRIPTION

Two of the most important measurements used to verify the quality of a strain gage installation are insulation resistance (leakage to ground) and shift in gage resistance due to installation procedures. While these two measurements are not a complete guarantee of eventual proper strain gage performance, any installation that produces questionable values should not be relied upon where accuracy of results is necessary.

For example, a voltage difference between the specimen and strain gage frequently exists. A low insulation resistance will permit this voltage differential to introduce extraneous signals during strain measurement.

Several sources of variations in insulation resistance and shifts in gage resistance are:

- Insulation resistance in excess of 20,000 megohms should be expected for foil strain gages when installed under laboratory conditions. A value of 10,000 megohms should be considered minimum. A reading below this value generally indicates trapped foreign matter, moisture, residual flux or backing damage due to soldering, as well as incomplete solvent evaporation from an overcoating.
- Deterioration of the insulation resistance with time may be an indication of an improperly coated installation.
- At higher test temperatures, particularly above +300°F [+150°C], it is normal to expect lesser values. Ten megohms is considered to be the lower allowable value.
- Shifts in gage resistance during installation should not normally exceed 0.5% when using room-temperature-curing adhesives. Resistance shifts greater than 0.5% generally indicate damage to the gage due to improper handling or clamping. However, strain gages installed using elevated-temperature-curing adhesives may exhibit greater shifts in resistance due to adhesive lock-up at elevated temperatures (difference in linear coefficient of thermal expansion between the strain gage and specimen). These shifts will vary depending upon the specific cure temperature and materials used. The shifts should never exceed 2% and should be uniform within 0.5%.

### SPECIFICATIONS

#### INPUT CIRCUITS

**Gages:** Three-wire quarter bridge (120Ω and 350Ω) and half bridge. Other value quarter bridges using customer's reference, at readily accessible panel terminals.

**As ohmmeter:** Two leads (500Ω and 500 MΩ mid-scale)

#### INPUT LEADS

4-ft [1.2m] 4-conductor AWG #26 [0.4-mm diameter] twisted Teflon®-insulated cable supplied (with ground clip and three tinned leads)

#### METER

3.5-in size (3.00-in [76-mm] scale length) with mirror  
Tracking accuracy ±1% full range

#### MODE SWITCH

Five momentary push buttons: battery check, ±5% deviation, ±1% deviation, gage resistance (ohms), and insulation resistance (megohms)

#### DEVIATION MODE

Two ranges, ±1% and ±5%, F.S. (50 graduations either side of zero)

#### Accuracy:

1% range: 0.04% ΔR (2 meter graduations)

5% range: 0.2% ΔR (2 meter graduations)

**Excitation:** 1.0 VDC per gage

#### INSULATION RESISTANCE MODE

Graduated 5 MΩ to 20,000 MΩ (500 MΩ mid-scale)

**Accuracy:** 1 scale division

**Test Voltage:** 15 VDC open circuit

Gage Installation Tester

**OHM MODE**

Graduated 5Ω to 20 kΩ (500Ω mid-scale)

**Accuracy:** 1 scale division

**Test Voltage:** 2 VDC open circuit (0.4 VDC @ 120Ω)

**ENVIRONMENTAL**

+15°F to +125°F [-10°C to +50°C]; up to 80% relative humidity, non-condensing

**SIZE**

Aluminum case (separable lid) 5 H x 7 W x 5 D in with lid [125 x 180 x 126 mm]

**WEIGHT**

3.6 lb [1.6 kg] with batteries

**POWER SUPPLY**

Four 9V NEDA 1604 batteries (Eveready® 216 or equivalent)

**Life:** Will fully test 1000–5000 installation.

*All specifications are nominal or typical @ +23°C unless noted.*

*Teflon is a Registered Trademark of DuPont*

*Eveready is a Registered Trademark of Eveready Battery Co Inc.*



## Portable Strain Gage Welding and Soldering Unit

### FEATURES

- Separate visual and audible indicators monitor welder status. Weld energy is continuously adjustable from 3 to 50 joules, making the Model 700 an excellent choice for installing weldable strain gages and temperature sensors, as well as small thermocouples and light-gauge metal.
- Supplied with a lightweight soldering pencil. A front-panel control adjusts soldering tip temperature for a wide range of soldering applications in the field or in the laboratory.
- “Low-battery” light to warn the user when the internal, sealed lead-acid battery requires charging. A battery charger is included to provide for full battery charge with no danger of overcharging. Indicator lights monitor battery charge rate.
- Convenient storage space for cables, battery charger and instruction manual



### GENERAL SPECIFICATIONS

#### OVERALL SIZE

9 L x 9 W x 9-3/4 H in [230 x 230 x 250 mm]

#### WEIGHT

21 lb [9.5 kg]

#### POWER FOR RECHARGING

115 VAC or 230 VAC, 50-60 Hz. Uses external AC transformer (provided)

#### OPERATING AND STORAGE TEMPERATURE RANGE

0°F to +120°F [-20°C to +50°C]

### WELDING SPECIFICATIONS

#### WELD ENERGY RANGE

3 to 50 joules, continuously adjustable by front-panel control

Maximum open-circuit voltage less than 25 VDC

#### MAXIMUM WELD REPETITION RATE

20 per minute at 30 joules, typical

#### NUMBER OF WELDS PER BATTERY CHARGE

Approximately 2000 at weld energy setting of 30 joules. This is equivalent to 40 Micro-Measurements weldable gage installations.

#### BATTERY CHARGE TIME: (FROM FULL DISCHARGE)

12 hours to 75% full charge; 18 hours to full charge

#### BATTERY

One sealed, rechargeable lead-acid (non-liquid) type, 12 volt, 5 ampere-hour

#### WELDING PROBE

Manually fired with trigger control and “steady-rest”

#### WELDING CABLES

Two 5 ft [1.5m], fully flexible

#### WELD ENERGY MONITOR

Calibrated front-panel control with READY and WAIT indicators; audible indication selectable



Portable Strain Gage Welding and Soldering Unit

**SOLDERING SPECIFICATIONS**

**TEMPERATURE CONTROL**

Continuously variable with bands indicating melting range of solders

**SOLDERING PENCIL**

1.1 oz [31 gm], rated at 25 watts, 12 volt operation. Tip temperature adjustable from +200°F to +900°F [+90°C to +480°C].

**SOLDERING DURATION**

4 hours using +361°F [+183°C] melting point solders (with initial full charge)

**ACCESSORY**

**Model 700-A103 Spot Welding Probe Set:**

Recommended for spot welding instrument leadwires to ZC Series high-temperature gage ribbons

All specifications are nominal or typical at +23°C unless noted.

**PANEL CONTROL FEATURES**

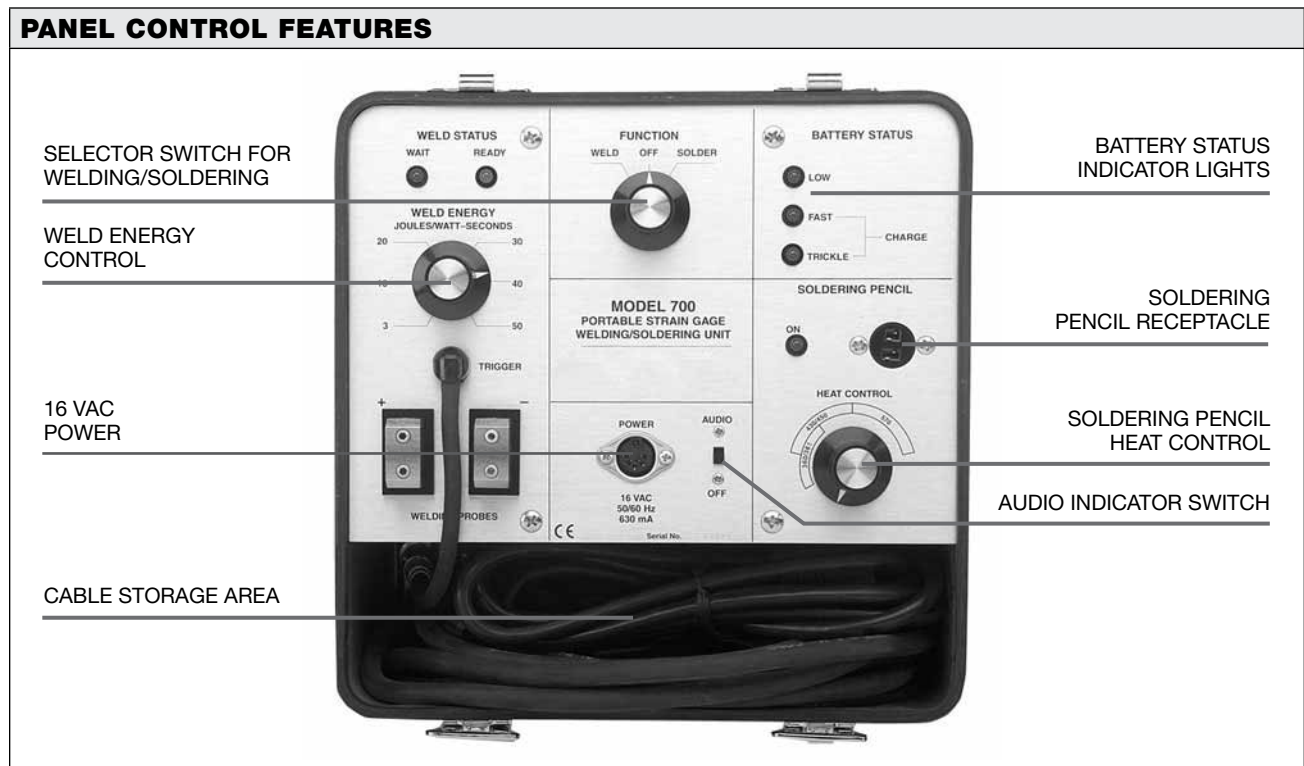

## Milling Guide for Residual Stress Measurements

### INTRODUCTION

A predominant factor contributing to the structural failure of machine parts, pressure vessels, framed structures, etc., may be the residual “locked-in” stresses that exist in the object prior to its being put into service. These residual stresses are usually introduced during manufacturing, and are caused by processes such as casting, welding, machining, heat treating, molding, etc.

Residual stress cannot be detected or evaluated by conventional surface measurement techniques, since the strain sensor (strain gage, photoelastic coating, etc.) can only respond to strain changes that occur after the sensor is installed.

The most widely used practical technique for measuring residual stresses is the hole-drilling strain gage method described in ASTM Standard E837. With this method, a specially configured electrical resistance strain gage rosette is bonded to the surface of the test object, and a small shallow hole is drilled through the center of the rosette. The local changes in strain due to introduction of the hole are measured, and the relaxed residual stresses are computed from these measurements. Micro-Measurements Tech Note TN-503, *Measurement of Residual Stresses By The Hole-Drilling Strain Gage Method*, presents a detailed discussion of the theory and application of this technique.

The hole-drilling method is generally considered semi-destructive, since the drilled hole may not noticeably impair the structural integrity of the part being tested. Depending on the type of rosette gage used, the drilled hole is typically 0.062 or 0.125 in (about 1.5 or 3.0 mm), both in diameter and depth. In many instances, the hole can also be plugged, if necessary, to return the part to service after the residual stresses have been determined.

The practicality and accuracy of this method is directly related to the precision with which the hole is drilled through the center of the strain gage rosette. The Micro-Measurements RS-200 milling guide provides a practical means to accomplish this task.

### RS-200 MILLING GUIDE

The RS-200 Milling Guide is a precision fixture for accurate positioning and drilling of a hole through the center of a special strain gage rosette. Principal features and components of the milling guide assembly are shown in the photos herein. When installed on the workpiece, the guide is supported by three leveling screws footed with swivel mounting pads to facilitate attachment to uneven surfaces.

Alignment of the milling guide relative to the strain gage rosette is accomplished by inserting a special-purpose microscope into the guide’s centering journal, and then positioning the guide precisely over the center of the rosette by means of four X-Y adjusting screws. The microscope assembly, consisting of a polished

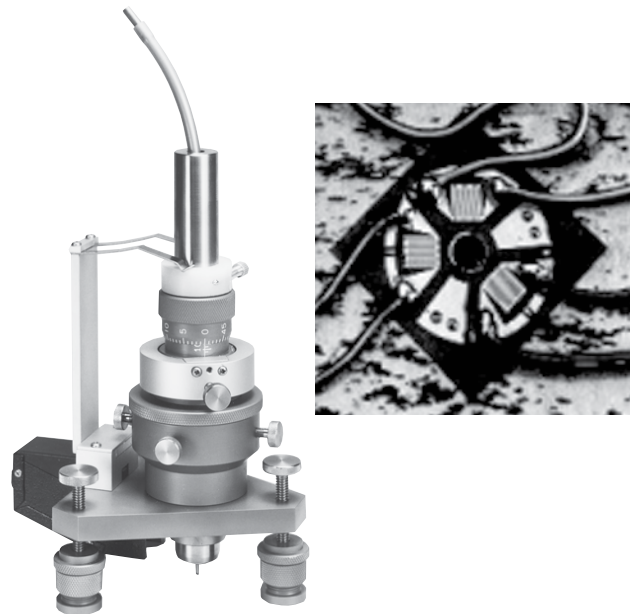

steel housing with eyepiece, reticle, and objective lens, permits alignment to within 0.0015 in (0.038 mm) of the gage center. The microscope is also used to measure the diameter of the hole after it is drilled. An illuminator attaches to the base of the guide to aid in the optical alignment procedure.

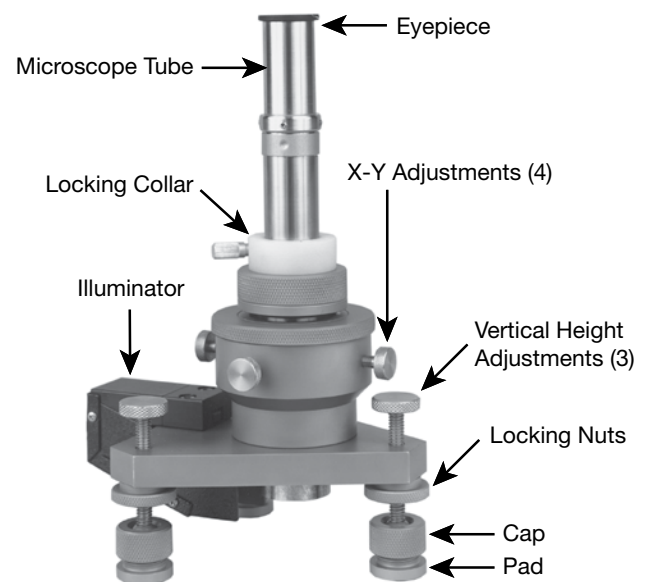

### Milling Guide for Residual Stress Measurements

After alignment, the microscope is removed from the guide, and the milling bar or high-speed air turbine is inserted in its place. The milling bar is used for slow-speed drilling of the hole. Two standard milling cutters are supplied: 0.062 and 0.125 in (1.6 and 3.2 mm) diameter. The milling bar is equipped with a universal joint for flexible connection to a drill motor.

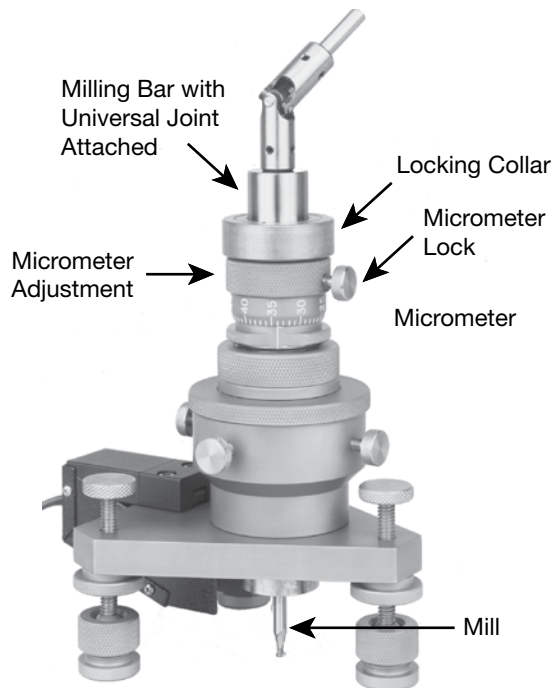

Conventional slow-speed milling may be satisfactory on some mild steels and aluminum alloys. But high-speed drilling is generally the most convenient and practical method for introducing the hole in all test materials. (When residual stresses are to be measured on materials such as stainless steels, nickel-based alloys, etc., ultra high-speed drilling techniques are preferred.) For this purpose, a high-speed air-turbine assembly, along with a supply of tungsten carbide-tipped cutters [ten

each 0.031 in (0.8 mm) diameter and 0.062 in (1.6 mm) diameter], is supplied with the milling guide. A foot pedal control is included for operating the air turbine.

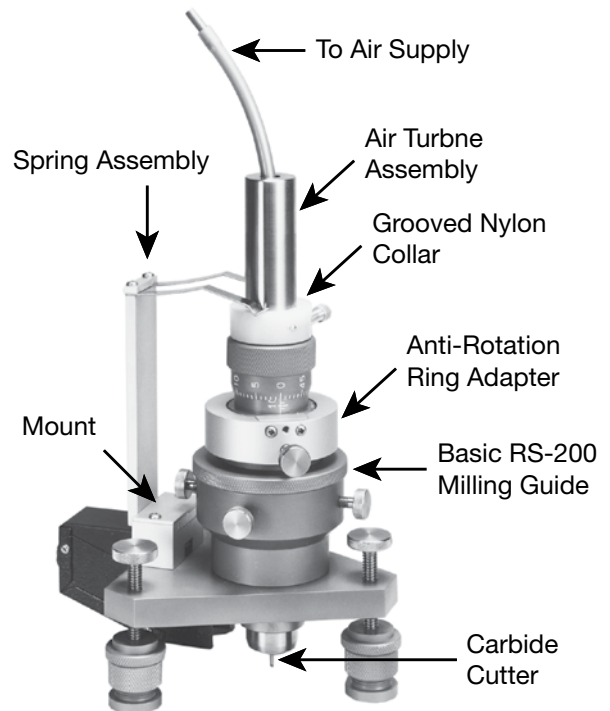

A micrometer depth set attachment, available in English or metric units, is provided with each milling guide assembly. This device is used for incremental drilling when information on the variation of residual-stress-with-depth is desired.

Other items supplied include a plastic template for the proper location of the milling guide foot pads on the test part and a special break-off tool used to remove the foot pads from the part after the test is completed. All components are housed in a sturdy carrying case. The guide is approximately 9 in (230 mm) high, and 4.5 in (114 mm) wide at the base.

A fast-setting-cement kit, used to firmly attach the guide to the test part, is available as an accessory item.

[www.vishaypg.com](http://www.vishaypg.com)



**VISHAY**  
**PRECISION**  
**GROUP**

Data Book

## Strain Gage Instrumentation

### Micro-Measurements

[www.micro-measurements.com](http://www.micro-measurements.com)

VMM-DB0107-1106

Where the World Goes  
for Precision Measurement and Control

© Copyright 2011 Vishay Precision Group. ® Registered trademarks of Vishay Precision Group.  
All rights reserved. Printed in USA. Specifications subject to change without notice.