

Advanced Sensors

Databook

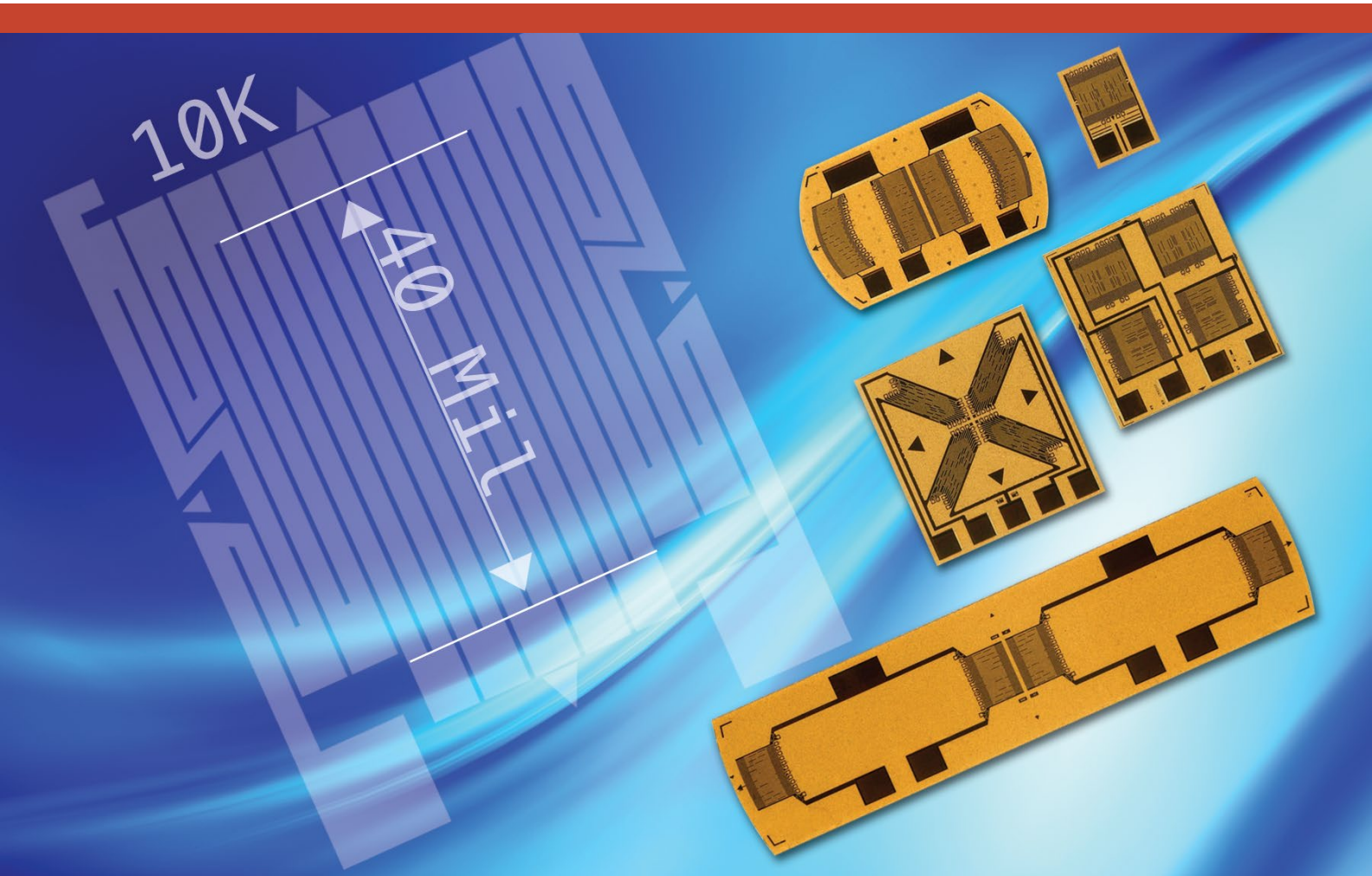

Strain Gage Sensors
Bondable Resistors

Advanced Sensors and Bondable Resistors

Micro-Measurements

P.O. Box 27777

Raleigh, NC 27611

U.S.A.

Phone: +1-919-365-3800

Fax: +1-919-365-3945

www.micro-measurements.com

Disclaimer

ALL PRODUCTS, PRODUCT SPECIFICATIONS AND DATA ARE SUBJECT TO CHANGE WITHOUT NOTICE.

Vishay Precision Group, Inc., its affiliates, agents, and employees, and all persons acting on its or their behalf (collectively, "VPG"), disclaim any and all liability for any errors, inaccuracies or incompleteness contained herein or in any other disclosure relating to any product.

The product specifications do not expand or otherwise modify VPG's terms and conditions of purchase, including but not limited to, the warranty expressed therein.

VPG makes no warranty, representation or guarantee other than as set forth in the terms and conditions of purchase. **To the maximum extent permitted by applicable law, VPG disclaims (i) any and all liability arising out of the application or use of any product, (ii) any and all liability, including without limitation special, consequential or incidental damages, and (iii) any and all implied warranties, including warranties of fitness for particular purpose, non-infringement and merchantability.**

Information provided in datasheets and/or specifications may vary from actual results in different applications and performance may vary over time. Statements regarding the suitability of products for certain types of applications are based on VPG's knowledge of typical requirements that are often placed on VPG products. It is the customer's responsibility to validate that a particular product with the properties described in the product specification is suitable for use in a particular application. You should ensure you have the current version of the relevant information by contacting VPG prior to performing installation or use of the product, such as on our website at vpgsensors.com.

No license, express, implied, or otherwise, to any intellectual property rights is granted by this document, or by any conduct of VPG.

The products shown herein are not designed for use in life-saving or life-sustaining applications unless otherwise expressly indicated. Customers using or selling VPG products not expressly indicated for use in such applications do so entirely at their own risk and agree to fully indemnify VPG for any damages arising or resulting from such use or sale. Please contact authorized VPG personnel to obtain written terms and conditions regarding products designed for such applications.

Product names and markings noted herein may be trademarks of their respective owners.

Gage Series	5
Creep and Modulus Compensation	6
Designation System	7
Linear Patterns—Single Grid.....	9
Linear Patterns—Dual Grid	22
90° Patterns.....	28
Shear Patterns—Single Grid	33
Shear Patterns—Dual Grid.....	36
Linear Patterns – High Resistance	43
Full Bridge Patterns.....	50
Linear Diaphragm Patterns.....	59
Bondable Resistor Patterns	67

Advanced Sensors

N2A SERIES

N2A gages are constantan-alloy patterns constructed on a thin, laminated, polyimide-film backing. This series is capable of low and repeatable creep performance. Construction is very rugged, which will help prevent gage handling damage. Advanced Sensors N2A gages are offered with epoxy encapsulation as standard. An open-faced version can be supplied upon request.

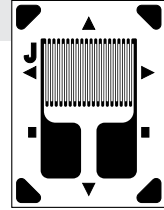

J2A SERIES

J2A gages are encapsulated constantan-alloy patterns. Both the encapsulation and backing are thin, laminated polyimide film. Gage soldering tabs are exposed for simplified lead connections. Creep performance is equal to the N2A Series, although the presence of an encapsulating layer will require a change in creep code selection to maintain the same performance.

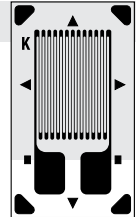

N2K SERIES

N2K gages are modified-Karma-alloy patterns constructed on a thin, laminated, polyimide-film backing. All N2K gages are supplied with gold soldering pads (DG) for ease of leadwire attachment. Copper soldering pads are also available. Most gages in the N2K Series can also be modulus compensated. Advanced Sensors N2K gages are offered with epoxy encapsulation as standard. An open-faced version can be supplied upon request.

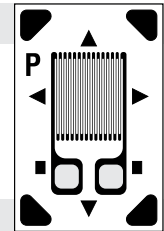

N5K SERIES

N5K gages are modified-Karma-alloy patterns constructed on a thin, laminated, polyimide-film backing constructed to improve gage performance at elevated temperatures. All N5K gages are supplied with gold soldering pads (DG) for ease of leadwire attachment. Copper soldering pads are also available. Most gages in the N5K Series can also be modulus compensated. Advanced Sensors N5K gages are offered with epoxy encapsulation as standard.

J5K SERIES

J5K gages are encapsulated, modified-Karma-alloy patterns specially constructed to improve gage performance at elevated temperatures. Because of the laminated polyimide-film backing and encapsulation, all J5K patterns are fully flexible without being brittle. Gold soldering pads (DG) as well as copper soldering pads (DP) are exposed for simplified lead connections. Some J5K gages can be supplied with modulus-compensation (EMC) options. For best high-temperature performance, J5K-Series gages should be installed with M-Bond 450 high-temperature adhesive.

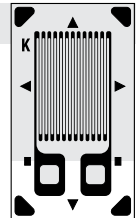

GAGE SERIES	TEMPERATURE RANGE		GAGE FACTOR (SEE NOTE)	FATIGUE LIFE	
	STATIC	DYNAMIC		STRAIN LEVEL IN $\mu\epsilon$	NUMBER OF CYCLES
N2A	-100° to +200°F (-75° to +95°C)	Same as Static	2.05 nom.	± 1500 1500	10^7 10^8 ⁽²⁾
J2A	-100° to +200°F (-75° to +95°C)	Same as Static	2.05 nom.	± 1700 1700	10^6 10^7 ⁽²⁾
N2K	-100° to +200°F (-75° to +95°C)	Same as Static	2.1 nom. ⁽¹⁾	± 1800	10^7
N5K	-100° to +400°F (-75° to +205°C)	-320° to +500°F (-195° to +260°C)	2.1 nom. ⁽¹⁾	± 1800	10^7
J5K	-100° to +400°F (-75° to +205°C)	-320° to +500°F (-195° to +260°C)	2.1 nom. ⁽¹⁾	± 2000 1800	10^7 10^8 ⁽²⁾

Notes:

Advanced Sensors gages are supplied with nominal gage factor values that will vary slightly with pattern. They are not suitable for strain measurement in stress analysis applications. Request our Precision Strain Gages databook, or contact our Applications Engineering Department, for a complete listing of gages for precision strain measurement applications.

⁽¹⁾ Nominal gage factor is 2.2 for EMC options.

⁽²⁾ Unidirectional strain.

Advanced Sensors

CREEP COMPENSATION

Commercial transducers regularly achieve a creep specification of less than $\pm 0.02\%$ of full scale (FS) for a 20-minute test. To attain this level on a high production basis, it is usually necessary to match the strain gage's creep characteristic to the spring element creep.

Most *Transducer-Class* gages can be adjusted in design to exhibit either a positive or negative creep under load. Spring element materials exhibit only positive creep under load. (See figure below.)

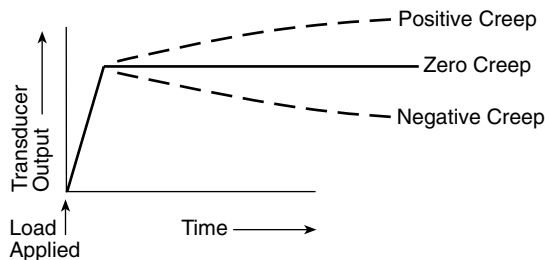

Since transducer creep depends on several variables such as spring element material, heat treatment, strain field, adhesive type and test temperature, it is not possible to predict the proper gage compensation necessary to achieve the best creep result.

Most of the gages in this catalog list one available creep compensation code. Since it is not possible to predetermine the creep characteristics of a particular transducer, it is suggested that the standard creep code be ordered in quantities sufficient to evaluate three or four transducers. Where creep levels are high enough to warrant correction, a different creep compensation, either more negative or more positive, depending on test results, can often be recommended.

A complicating factor in creep code selection is that while different gage patterns may list the same creep code, they do not necessarily exhibit the same creep behavior. This is because the gage backing selection, gridline width and gage length also influence creep characteristics.

It should also be noted that this type of creep correction is generally limited to transducers exhibiting less than $\pm 0.1\%$ FS creep. Higher creep levels in the positive direction are often the result of poor spring element material selection. Negative creep values in excess of 0.1% FS generally are the result of a faulty gage installation.

MODULUS COMPENSATION (EMC) OPTION

Many of the K-alloy gages in this catalog are available in a special form which permits the gage factor change with temperature to be adjusted over a wide range during gage manufacture.

Properly matched to the transducer spring element, these EMC (Effective Modulus Compensation) gages can provide very good self-correction of changes in transducer span versus temperature. A compensation better than $\pm 0.0008\%/^{\circ}\text{F}$ ($\pm 0.0014\%/^{\circ}\text{C}$) can readily be achieved in many cases.

While this may at first appear to be the "ideal" strain gage for transducers, there are certain factors that should be considered prior to selecting EMC gages for a given application:

1. EMC gages cost more than other gages. In most cases the difference is great enough to offset the additional cost of span/temperature resistors.
2. EMC gages must be "matched" to the transducer spring material. Depending on the degree of compensation accuracy desired, the standard EMC options may not yield the "best fit" compensation on the spring material in use. In these cases, a special foil lot which possesses the desired compensation would be required. There is normally a minimum order requirement and set-up charge for special foil lots.
3. Transducer spring materials may not have batch-to-batch repeatability sufficient to maintain specifications when using the same EMC gages. New material lot testing is therefore necessary for high precision units.

Despite these limitations, EMC gages can often be advantageous for transducer manufacturers.

The following standard EMC options are available:

OPTION M1

Gage factor slope is -1.50% per 100°F (-2.70% per 100°C). Provides span-versus-temperature compensation for many stainless steels.

OPTION M2

Gage factor slope is -2.35% per 100°F (-4.23% per 100°C). Provides span-versus-temperature compensation for most aluminum alloys.

OPTION M3

Gage factor slope is -1.25% per 100°F (-2.25% per 100°C). Provides span-versus-temperature compensation for many tool steels.

OPTION M4

Gage factor slope is -1.35% per 100°F (-2.43% per 100°C). Provides "mid-range" compensation between M1 and M3.

Advanced Sensors

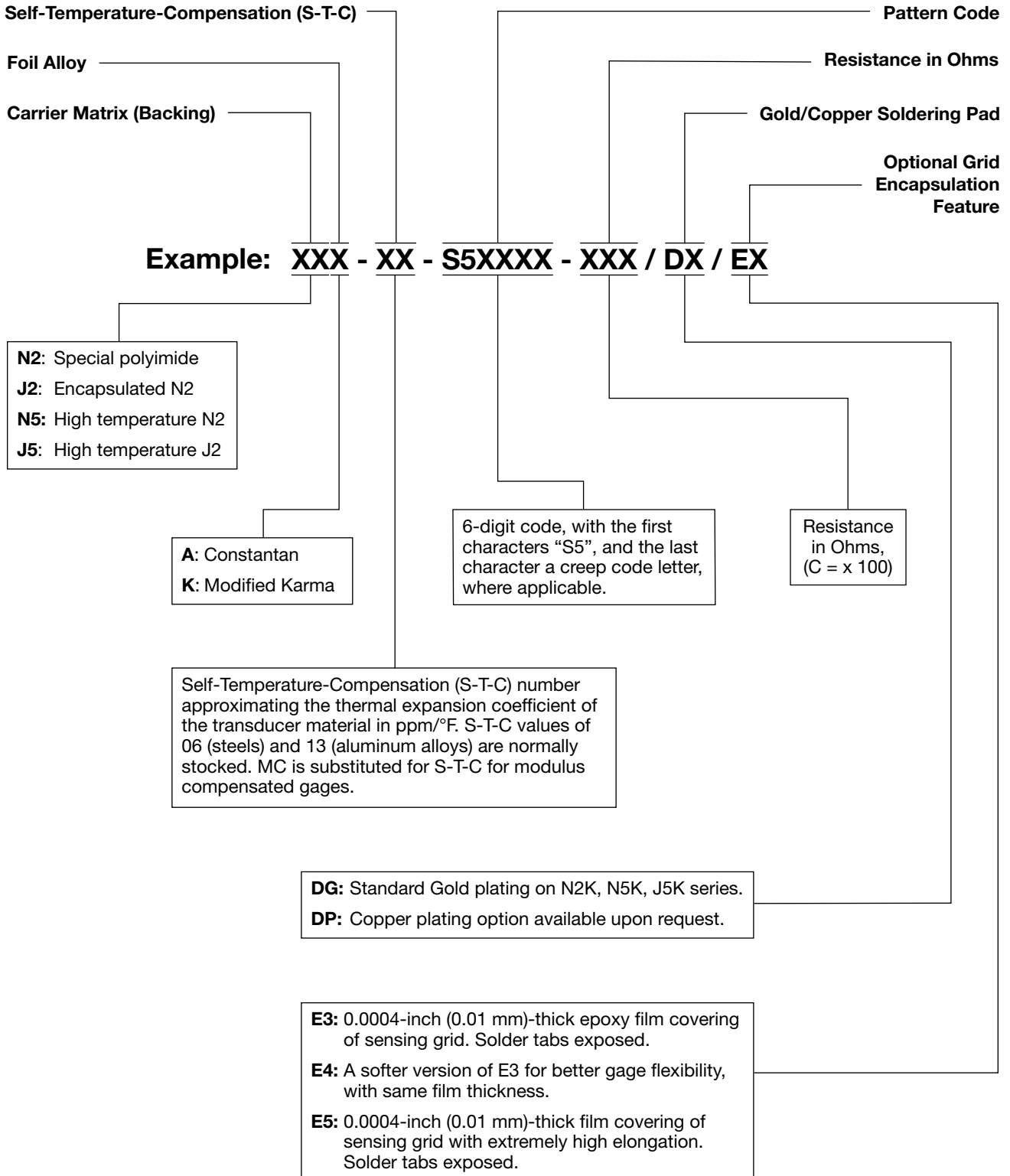

Advanced Sensors

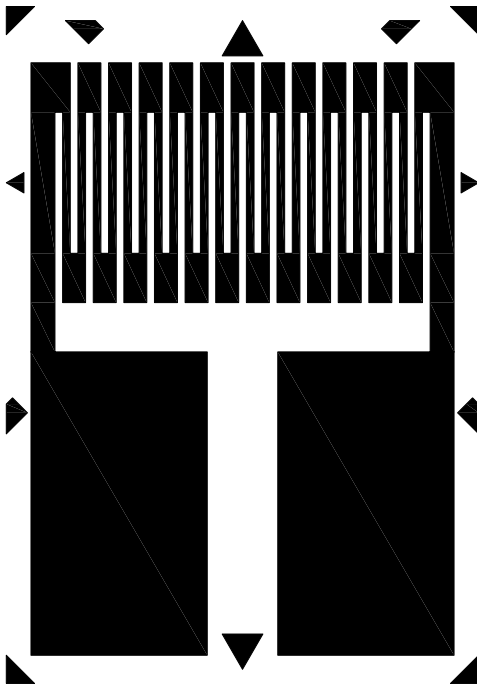
S5077 GAGE PATTERN DATA			
 <p>actual size</p>	GAGE DESIGNATION	RESISTANCE IN OHMS	STD. CREEP CODE
	N2K-XX-S5077M-350/DG/E3	350 ±0.2%	M
	N5K-XX-S5077M-350/DG/E3	350 ±0.2%	M
<p>DESCRIPTION</p> <p>General-purpose miniature pattern 350Ω. RoHS-compliant.</p>			

GAGE DIMENSIONS							
<table border="1"> <tr> <td>inch</td> </tr> <tr> <td>millimeter</td> </tr> </table>						inch	millimeter
inch							
millimeter							
Gage Length	Overall Length	Grid Width	Overall Width	Matrix Length	Matrix Width		
0.020	0.084	0.060	0.060	0.10	0.06		
0.51	2.13	1.52	1.52	2.5	1.5		

Copper plating for tabs is available.

Advanced Sensors

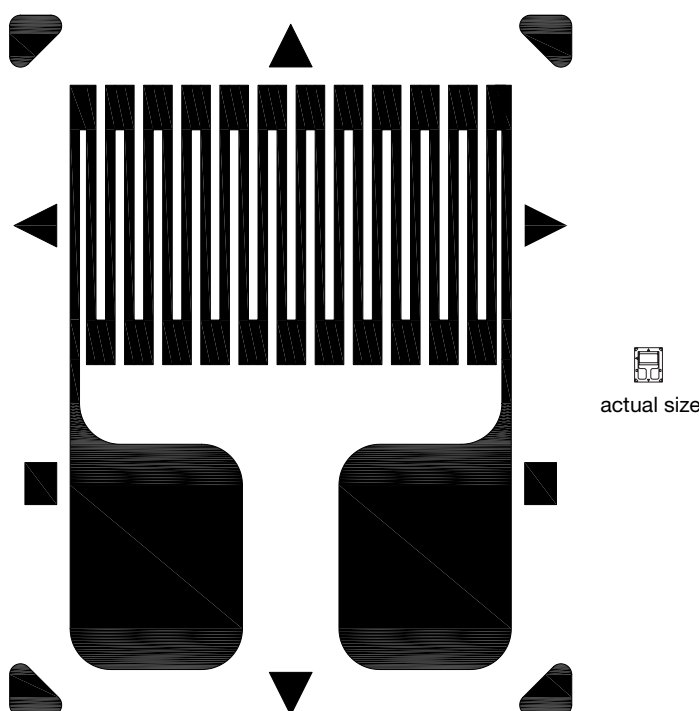
S5063 GAGE PATTERN DATA			
 <p>actual size</p>	GAGE DESIGNATION	RESISTANCE IN OHMS	STD. CREEP CODE
	N2K-XX-S5063G-350/DG/E3	350 ±0.15%	G
	N5K-XX-S5063G-350/DG/E3	350 ±0.15%	G
<p>DESCRIPTION</p> <p>One of the most popular gage sizes. RoHS-compliant.</p>			

GAGE DIMENSIONS							
<table border="1"> <tr> <td>inch</td> </tr> <tr> <td>millimeter</td> </tr> </table>						inch	millimeter
inch							
millimeter							
Gage Length	Overall Length	Grid Width	Overall Width	Matrix Length	Matrix Width		
0.047	0.137	0.100	0.108	0.18	0.14		
1.19	3.48	2.55	2.75	4.5	3.7		

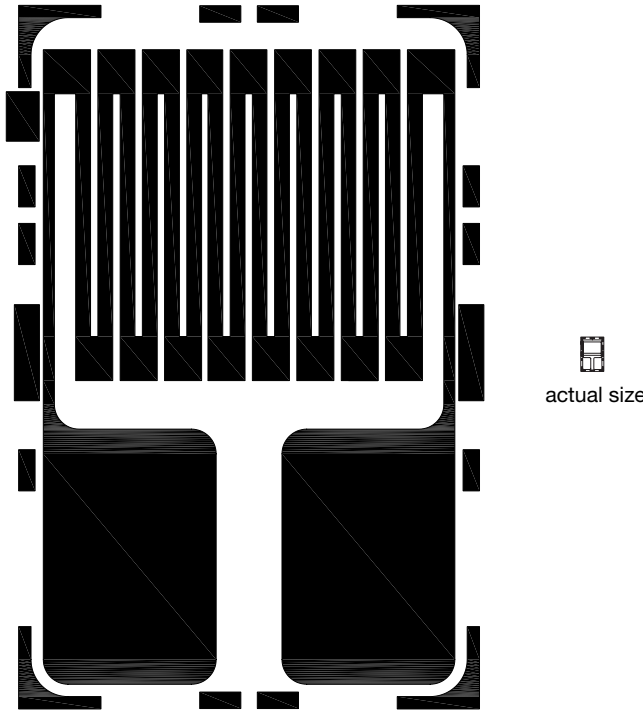

Copper plating for tabs is available.

Advanced Sensors

S5091 GAGE PATTERN DATA			
 <p>actual size</p>	GAGE DESIGNATION	RESISTANCE IN OHMS	STD. CREEP CODE
	N2A-XX-S5091R-350/E3	350 ±0.2%	R
<p>DESCRIPTION</p> <p>The most popular small gage pattern. RoHS-compliant.</p>			

GAGE DIMENSIONS					
				inch	
				millimeter	
Gage Length	Overall Length	Grid Width	Overall Width	Matrix Length	Matrix Width
0.059	0.154	0.100	0.100	0.18	0.12
1.50	3.81	2.54	2.54	4.5	3.0

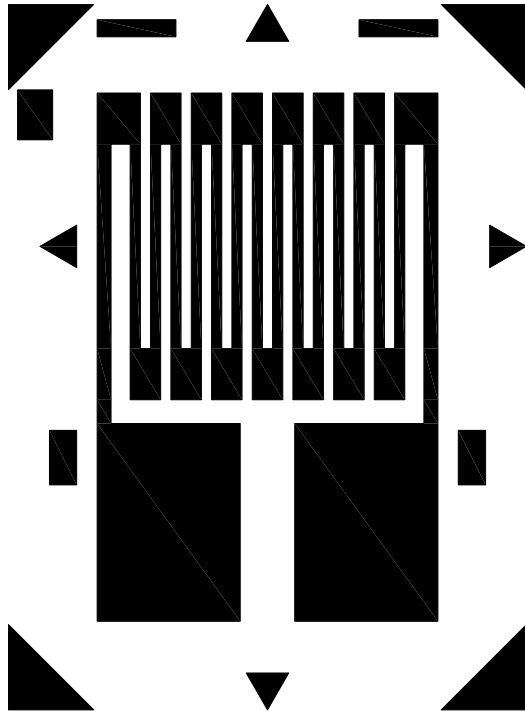
Advanced Sensors

S5114 GAGE PATTERN DATA			
 <p style="text-align: center;">  actual size </p>	GAGE DESIGNATION	RESISTANCE IN OHMS	STD. CREEP CODE
	N2K-XX-S5114Q-350/DG/E3	350 ±0.2%	Q
	N5K-XX-S5114Q-350/DG/E3	350 ±0.2%	Q
<p>DESCRIPTION</p> <p>The most popular small gage pattern. RoHS-compliant.</p>			

GAGE DIMENSIONS							
<table border="1" style="display: inline-table; vertical-align: middle;"> <tr><td style="text-align: center;">inch</td></tr> <tr><td style="text-align: center;">millimeter</td></tr> </table>						inch	millimeter
inch							
millimeter							
Gage Length	Overall Length	Grid Width	Overall Width	Matrix Length	Matrix Width		
0.059	0.140	0.100	0.100	0.21	0.16		
1.52	3.55	2.54	2.54	5.5	4.1		

Copper plating for tabs is available.

Advanced Sensors

S5126 GAGE PATTERN DATA			
 <p>actual size</p>	GAGE DESIGNATION	RESISTANCE IN OHMS	STD. CREEP CODE
	N2K-XX-S5126S-350/DG/E3	350 ±0.2%	S*
	N5K-XX-S5126S-350/DG/E3	350 ±0.2%	S*
<p>DESCRIPTION</p> <p>General-purpose miniature pattern. RoHS-compliant.</p>			

GAGE DIMENSIONS							
<table border="1"> <tr> <td>inch</td> </tr> <tr> <td>millimeter</td> </tr> </table>						inch	millimeter
inch							
millimeter							
Gage Length	Overall Length	Grid Width	Overall Width	Matrix Length	Matrix Width		
0.050	0.120	0.065	0.065	0.14	0.075		
1.27	3.04	1.65	1.65	3.5	1.9		

* Only creep code available for this gage.
Copper plating for tabs is available.

Advanced Sensors

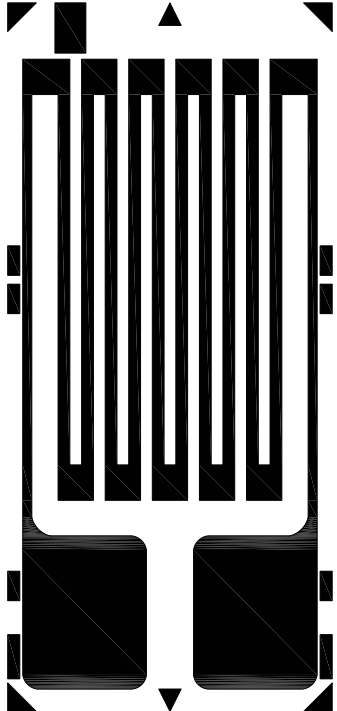
S5105 GAGE PATTERN DATA			
 <p>The diagram shows a vertical gage pattern with a central grid of five vertical bars. The grid is flanked by two larger vertical bars. At the bottom, there are two square-shaped components. A small icon of the gage is shown to the right of the main diagram, labeled 'actual size'.</p>	GAGE DESIGNATION	RESISTANCE IN OHMS	STD. CREEP CODE
	N2A-XX-S5105R-350/E3	350 ±0.2%	R
<p>DESCRIPTION</p> <p>One of the most popular gage sizes. RoHS-compliant.</p>			

GAGE DIMENSIONS					
					<input type="checkbox"/> inch <input checked="" type="checkbox"/> millimeter
Gage Length	Overall Length	Grid Width	Overall Width	Matrix Length	Matrix Width
0.126	0.214	0.100	0.100	0.25	0.12
3.20	5.43	2.54	2.54	6.3	3.0

Advanced Sensors

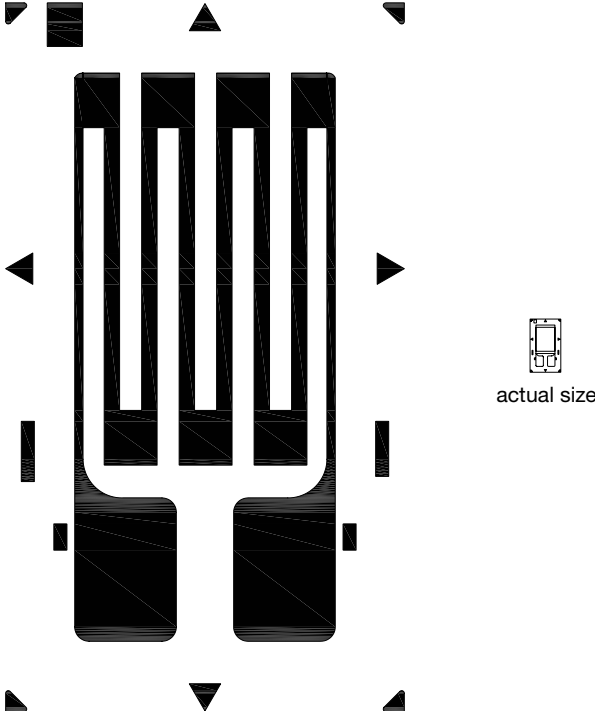
S5122 GAGE PATTERN DATA			
	GAGE DESIGNATION	RESISTANCE IN OHMS	STD. CREEP CODE
	N2A-XX-S5122V-350/E4	350 ±0.15%	V
<p>DESCRIPTION</p> <p>One of the most popular gage sizes. RoHS-compliant.</p>			

GAGE DIMENSIONS							
<table border="1"> <tr> <td>inch</td> </tr> <tr> <td>millimeter</td> </tr> </table>						inch	millimeter
inch							
millimeter							
Gage Length	Overall Length	Grid Width	Overall Width	Matrix Length	Matrix Width		
0.125	0.205	0.100	0.100	0.28	0.16		
3.18	5.20	2.54	2.54	7.1	4.1		

Advanced Sensors

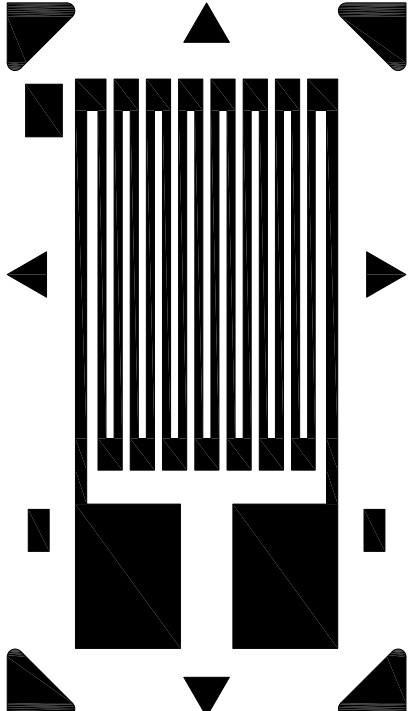
S5109 GAGE PATTERN DATA			
 <p style="text-align: center;">actual size</p>	GAGE DESIGNATION	RESISTANCE IN OHMS	STD. CREEP CODE
	N2K-XX-S5109Q-350/DG/E3 N5K-XX-S5109Q-350/DG/E3	350 ±0.2% 350 ±0.2%	Q Q
<p>DESCRIPTION</p> <p>One of the most popular gage sizes. RoHS-compliant.</p>			

GAGE DIMENSIONS					
					inch
					millimeter
Gage Length	Overall Length	Grid Width	Overall Width	Matrix Length	Matrix Width
0.125	0.217	0.100	0.100	0.28	0.16
3.18	5.51	2.54	2.54	7.1	4.1

Copper plating for tabs is available.

Advanced Sensors

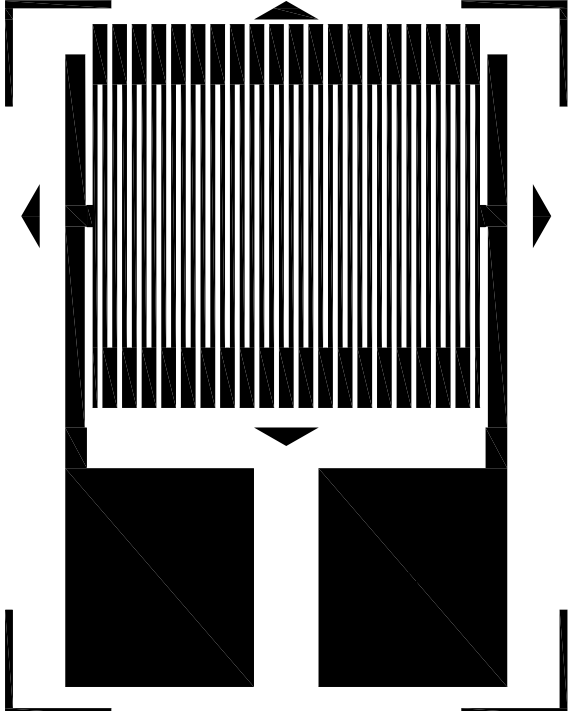
S5037 GAGE PATTERN DATA			
 <p>actual size</p>	GAGE DESIGNATION	RESISTANCE IN OHMS	STD. CREEP CODE
	N2K-XX-S5037Q-10C/DG/E3	1000 ±0.2%	Q*
	N5K-XX-S5037Q-10C/DG/E3	1000 ±0.2%	Q*
<p>DESCRIPTION</p> <p>Miniature high resistance pattern. RoHS-compliant.</p>			

GAGE DIMENSIONS							
<table border="1"> <tr> <td>inch</td> </tr> <tr> <td>millimeter</td> </tr> </table>						inch	millimeter
inch							
millimeter							
Gage Length	Overall Length	Grid Width	Overall Width	Matrix Length	Matrix Width		
0.034	0.086	0.051	0.056	0.09	0.08		
0.86	2.17	1.30	1.42	2.4	1.9		

* Only creep code available for this gage.
Copper plating for tabs is available.

Advanced Sensors

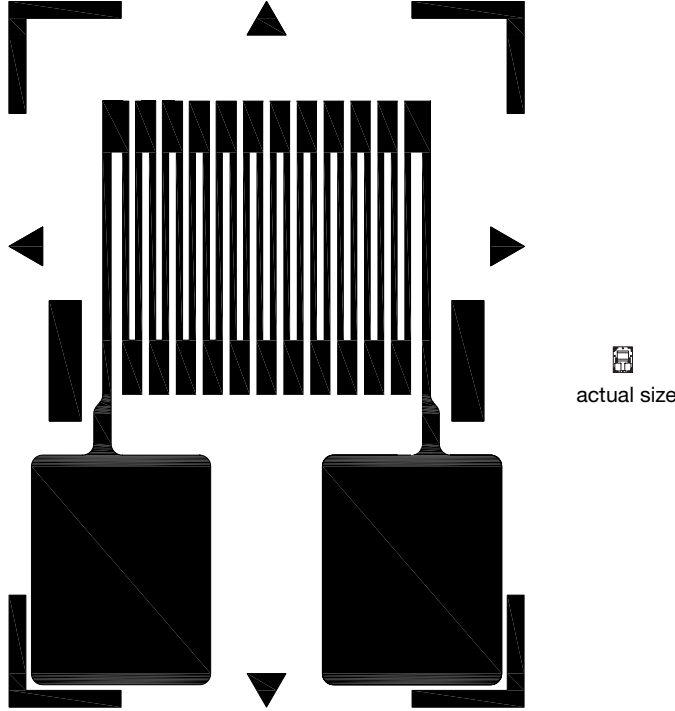
S5094 GAGE PATTERN DATA			
 <p>actual size</p>	GAGE DESIGNATION	RESISTANCE IN OHMS	STD. CREEP CODE
	N2K-XX-S5094Q-10C/DG/E3	1000 ±0.2%	Q*
	N5K-XX-S5094Q-10C/DG/E3	1000 ±0.2%	Q*
<p>DESCRIPTION</p> <p>Same grid size as the S5037, with larger solder tabs. RoHS-compliant.</p>			

GAGE DIMENSIONS							
<table border="1"> <tr> <td>inch</td> </tr> <tr> <td>millimeter</td> </tr> </table>						inch	millimeter
inch							
millimeter							
Gage Length	Overall Length	Grid Width	Overall Width	Matrix Length	Matrix Width		
0.033	0.104	0.054	0.084	0.13	0.10		
0.85	2.64	1.38	2.13	3.4	2.5		

* Only creep code available for this gage.
Copper plating for tabs is available.

Advanced Sensors

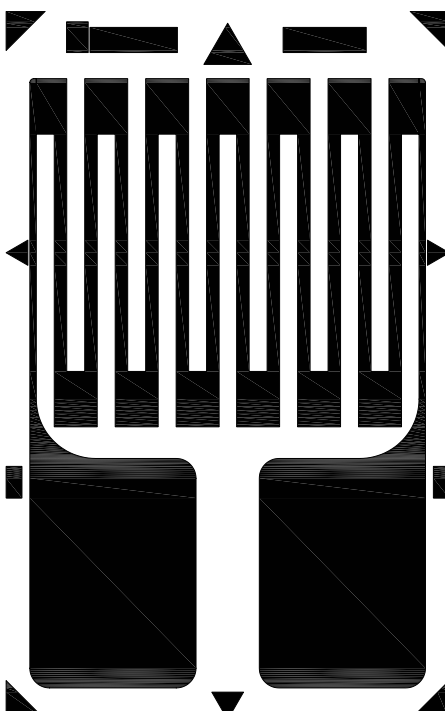
S5128 GAGE PATTERN DATA			
 <p>actual size</p>	GAGE DESIGNATION	RESISTANCE IN OHMS	STD. CREEP CODE
	N2A-XX-S5128P-10C/E4	1000 ±0.2%	P
<p>DESCRIPTION</p> <p>The most popular small gage pattern. RoHS-compliant.</p>			

GAGE DIMENSIONS							
<table border="1"> <tr><td>inch</td></tr> <tr><td>millimeter</td></tr> </table>						inch	millimeter
inch							
millimeter							
Gage Length	Overall Length	Grid Width	Overall Width	Matrix Length	Matrix Width		
0.060	0.140	0.100	0.100	0.19	0.12		
1.52	3.55	2.54	2.54	4.7	3.0		

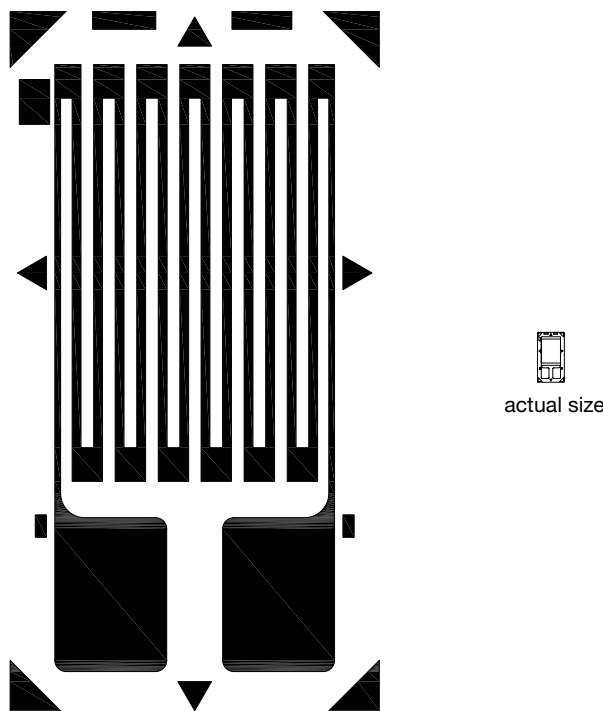

Advanced Sensors

S5150 GAGE PATTERN DATA			
	GAGE DESIGNATION	RESISTANCE IN OHMS	STD. CREEP CODE
	N2A-XX-S5150R-10C/E4	1000 ±0.2%	R*
<p>DESCRIPTION</p> <p>One of the most popular gage sizes. RoHS-compliant.</p>			

GAGE DIMENSIONS							
<table border="1"> <tr> <td>inch</td> </tr> <tr> <td>millimeter</td> </tr> </table>						inch	millimeter
inch							
millimeter							
Gage Length	Overall Length	Grid Width	Overall Width	Matrix Length	Matrix Width		
0.125	0.205	0.100	0.100	0.26	0.14		
3.18	5.20	2.54	2.54	6.6	3.5		

* Only creep code available for this gage.

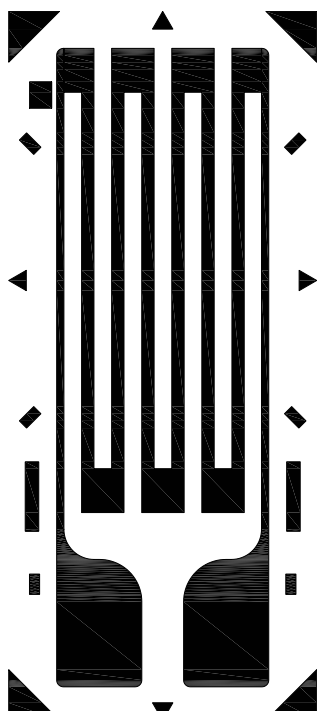
Advanced Sensors

S5117 GAGE PATTERN DATA			
	GAGE DESIGNATION	RESISTANCE IN OHMS	STD. CREEP CODE
	N2K-XX-S5117T-10C/DG/E4 N5K-XX-S5117T-10C/DG/E4	1000 ±0.2% 1000 ±0.2%	T* T*
 actual size	DESCRIPTION		
Large grid and high resistance permit higher-than-normal excitation voltage. RoHS-compliant.			

GAGE DIMENSIONS					
					<input type="checkbox"/> inch <input checked="" type="checkbox"/> millimeter
Gage Length	Overall Length	Grid Width	Overall Width	Matrix Length	Matrix Width
0.250	0.365	0.125	0.125	0.42	0.19
6.35	9.27	3.18	3.18	10.6	4.8

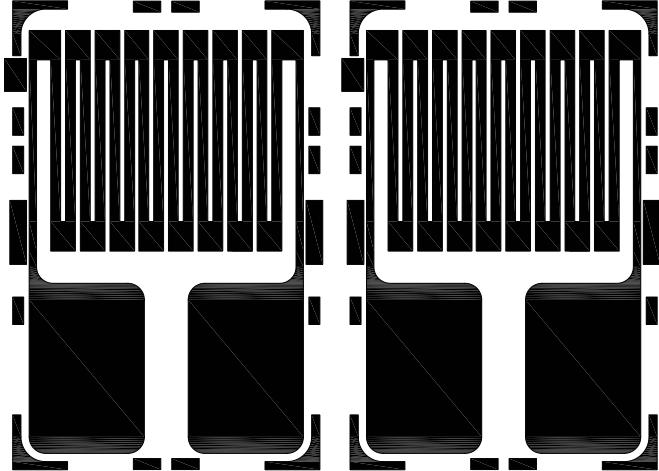

* Only creep code available for this gage.
Copper plating for tabs is available.

Advanced Sensors

S5092 GAGE PATTERN DATA			
 <p style="text-align: center;">actual size</p>	GAGE DESIGNATION	RESISTANCE IN OHMS	STD. CREEP CODE
	N2A-XX-S5092R-350/E3	350 ±0.2%	R
<p>DESCRIPTION</p> <p>The most popular small gage pattern. RoHS-compliant.</p>			

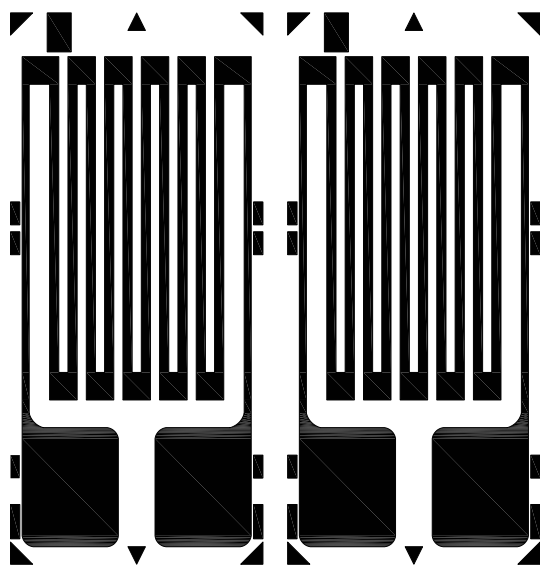

GAGE DIMENSIONS							
<table border="1" style="display: inline-table;"> <tr> <td>inch</td> </tr> <tr> <td>millimeter</td> </tr> </table>						inch	millimeter
inch							
millimeter							
Gage Length	Overall Length	Grid Width	Overall Width	Matrix Length	Matrix Width		
0.059	0.154	0.100	0.223	0.18	0.24		
1.50	3.81	2.54	5.66	4.5	6.2		

Advanced Sensors

S5119 GAGE PATTERN DATA			
  actual size	GAGE DESIGNATION	RESISTANCE IN OHMS	STD. CREEP CODE
	N2A-XX-S5119R-350/E3	350 ±0.2%	R
DESCRIPTION Dual-element gages widely used on bending-beam transducers. RoHS-compliant.			

GAGE DIMENSIONS							
<table border="1"> <tr> <td>inch</td> </tr> <tr> <td>millimeter</td> </tr> </table>						inch	millimeter
inch							
millimeter							
Gage Length	Overall Length	Grid Width	Overall Width	Matrix Length	Matrix Width		
0.126	0.214	0.100	0.221	0.25	0.24		
3.20	5.43	2.54	5.61	6.3	6.1		

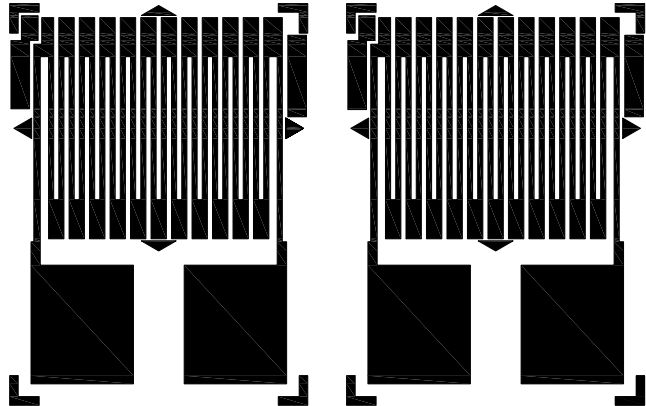
Advanced Sensors

S5100 GAGE PATTERN DATA			
 <p style="text-align: center;">  actual size </p>	GAGE DESIGNATION	RESISTANCE IN OHMS	STD. CREEP CODE
	N2K-XX-S5100Q-10C/DG/E3	1000 ±0.2%	Q*
	N5K-XX-S5100Q-10C/DG/E3	1000 ±0.2%	Q*
DESCRIPTION Small dual-element gage designed for bending beam transducers. RoHS-compliant.			

GAGE DIMENSIONS					
					<div style="border: 1px solid black; padding: 2px; display: inline-block;">inch</div> <div style="border: 1px solid black; padding: 2px; display: inline-block;">millimeter</div>
Gage Length	Overall Length	Grid Width	Overall Width	Matrix Length	Matrix Width
0.033	0.086	0.054	0.139	0.10	0.15
0.85	2.18	1.38	3.52	2.5	3.9

* Only creep code available for this gage.
 Copper plating for tabs is available.

Advanced Sensors

S5081 GAGE PATTERN DATA			
<p>actual size</p>	GAGE DESIGNATION	RESISTANCE IN OHMS	STD. CREEP CODE
	N2K-XX-S5081Q-10C/DG/E3	1000 ±0.2%	Q*
	N5K-XX-S5081Q-10C/DG/E3	1000 ±0.2%	Q*
<p>DESCRIPTION</p> <p>Small dual-element gage designed for bending beam transducers.</p> <p>RoHS-compliant.</p>			

GAGE DIMENSIONS							
					<table border="1"> <tr><td>inch</td></tr> <tr><td>millimeter</td></tr> </table>	inch	millimeter
inch							
millimeter							
Gage Length	Overall Length	Grid Width	Overall Width	Matrix Length	Matrix Width		
0.060	0.128	0.065	0.150	0.19	0.21		
1.52	3.25	1.65	3.81	4.9	5.3		

* Only creep code available for this gage.
Copper plating for tabs is available.

Advanced Sensors

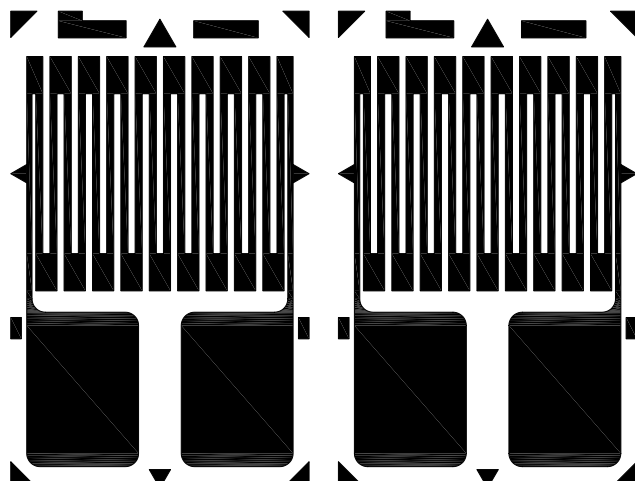
S5127 GAGE PATTERN DATA			
 <p style="text-align: center;">actual size</p>	GAGE DESIGNATION	RESISTANCE IN OHMS	STD. CREEP CODE
	N2A-XX-S5127P-10C/E4	1000 ±0.2%	P
<p>DESCRIPTION</p> <p>The most popular small gage pattern. RoHS-compliant.</p>			

GAGE DIMENSIONS					
					inch
					millimeter
Gage Length	Overall Length	Grid Width	Overall Width	Matrix Length	Matrix Width
0.060	0.140	0.100	0.223	0.187	0.243
1.52	3.55	2.54	5.66	4.7	6.2

Advanced Sensors

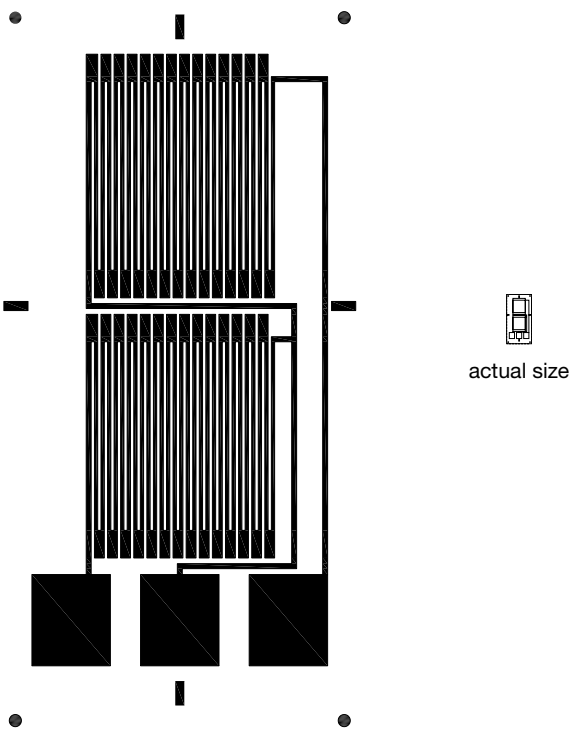
S5070 GAGE PATTERN DATA			
	GAGE DESIGNATION	RESISTANCE IN OHMS	STD. CREEP CODE
	N2K-XX-S5070Q-20C/DG/E3	2000 ±0.2%	Q*
	N5K-XX-S5070Q-20C/DG/E3	2000 ±0.2%	Q*
DESCRIPTION Half-bridge common-tab pattern. RoHS-compliant.			

GAGE DIMENSIONS							
<table border="1"> <tr> <td>inch</td> </tr> <tr> <td>millimeter</td> </tr> </table>						inch	millimeter
inch							
millimeter							
Gage Length	Overall Length	Grid Width	Overall Width	Matrix Length	Matrix Width		
0.062	0.256	0.062	0.098	0.25	0.13		
1.58	6.50	1.58	2.49	6.3	3.2		

* Only creep code available for this gage.
 Copper plating for tabs is available.

Advanced Sensors

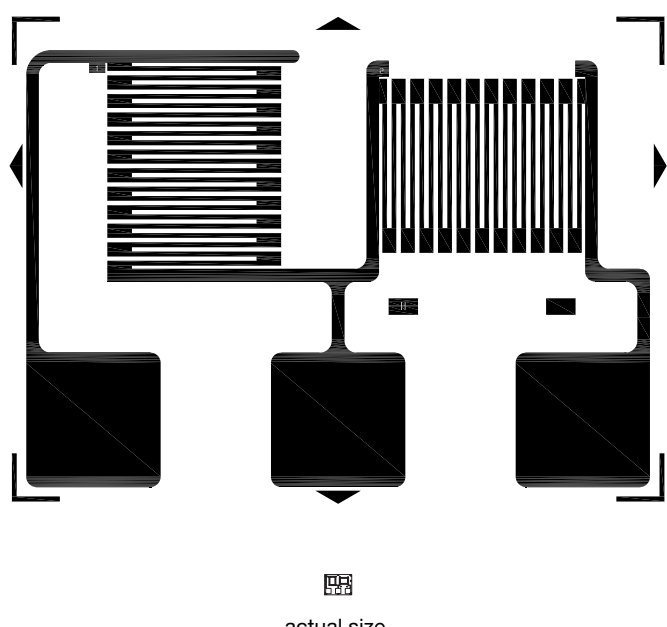
S5038 AND S5039 GAGE PATTERN DATA			
 <p style="text-align: center;">actual size</p>	GAGE DESIGNATION	RESISTANCE IN OHMS	STD. CREEP CODE
	N2K-XX-S5038P-10C/DG/E3	1000 ±0.2%	P
	N5K-XX-S5038P-10C/DG/E3	1000 ±0.2%	P
	N2K-XX-S5039H-50C/DG/E3	5000 ±0.2%	H*
	N5K-XX-S5039H-50C/DG/E3	5000 ±0.2%	H*
<p>DESCRIPTION</p> <p>Encapsulated 90° tee rosette. RoHS-compliant.</p>			

GAGE DIMENSIONS							
<table border="1"> <tr> <td>inch</td> </tr> <tr> <td>millimeter</td> </tr> </table>						inch	millimeter
inch							
millimeter							
Gage Length	Overall Length	Grid Width	Overall Width	Matrix Length	Matrix Width		
0.033	0.095	0.051	0.130	0.10	0.14		
0.83	2.41	1.30	3.30	2.7	3.6		

* Only creep code available for this gage.
Copper plating for tabs is available.

Advanced Sensors

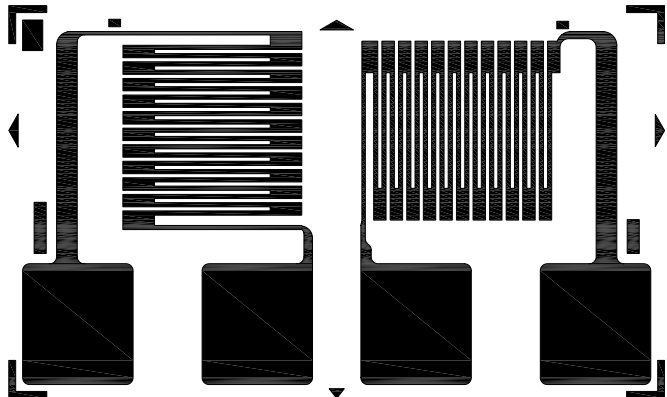
S5096 AND S5101 GAGE PATTERN DATA			
 <p style="text-align: center;">actual size</p>	GAGE DESIGNATION	RESISTANCE IN OHMS	STD. CREEP CODE
	N2K-XX-S5096Q-10C/DG/E3	1000 ±0.2%	Q*
	N5K-XX-S5096Q-10C/DG/E3	1000 ±0.2%	Q*
	N2K-XX-S5101N-50C/DG/E3	5000 ±0.2%	N*
	N5K-XX-S5101N-50C/DG/E3	5000 ±0.2%	N*
<p>DESCRIPTION</p> <p>General-purpose 90° tee rosette. RoHS-compliant.</p>			

GAGE DIMENSIONS					
					inch
					millimeter
Gage Length	Overall Length	Grid Width	Overall Width	Matrix Length	Matrix Width
0.034	0.102	0.055	0.172	0.12	0.20
0.85	2.59	1.41	4.36	3.1	5.0

* Only creep code available for this gage.
Copper plating for tabs is available.

Advanced Sensors

S5129 GAGE PATTERN DATA			
	GAGE DESIGNATION	RESISTANCE IN OHMS	STD. CREEP CODE
	N2A-XX-S5129N-350/E4	350 ±0.2%	N*
<p>DESCRIPTION</p> <p>Encapsulated 90° tee rosette. RoHS-compliant.</p>			

GAGE DIMENSIONS							
<table border="1"> <tr> <td>inch</td> </tr> <tr> <td>millimeter</td> </tr> </table>						inch	millimeter
inch							
millimeter							
Gage Length	Overall Length	Grid Width	Overall Width	Matrix Length	Matrix Width		
0.080	0.158	0.110	0.246	0.23	0.30		
2.03	4.03	2.79	6.25	5.8	7.6		

* Only creep code available for this gage.

Advanced Sensors

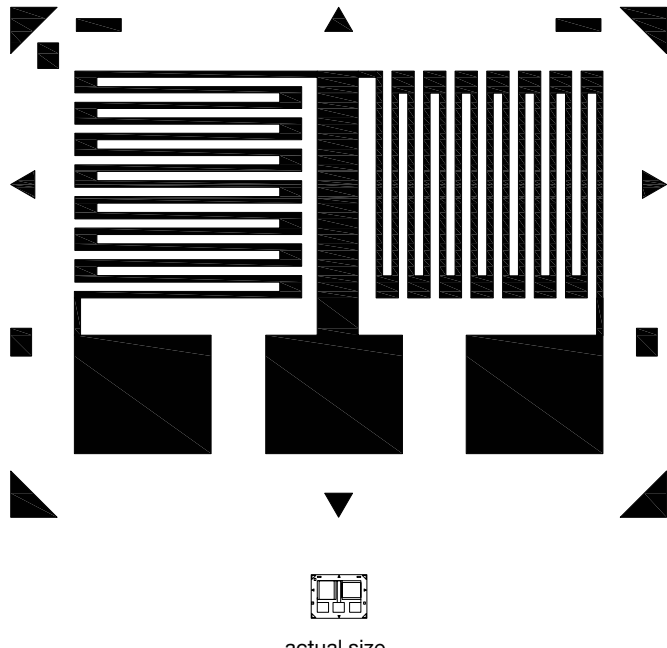
S5152 GAGE PATTERN DATA			
 <p style="text-align: center;">actual size</p>	GAGE DESIGNATION	RESISTANCE IN OHMS	STD. CREEP CODE
	N2A-XX-S5152P-10C/E4	1000 ±0.2%	P
<p>DESCRIPTION</p> <p>Encapsulated 90° tee rosette. RoHS-compliant.</p>			

GAGE DIMENSIONS					
					inch
					millimeter
Gage Length	Overall Length	Grid Width	Overall Width	Matrix Length	Matrix Width
0.079	0.165	0.098	0.228	0.23	0.29
2.01	4.20	2.50	5.80	5.8	7.4

Advanced Sensors

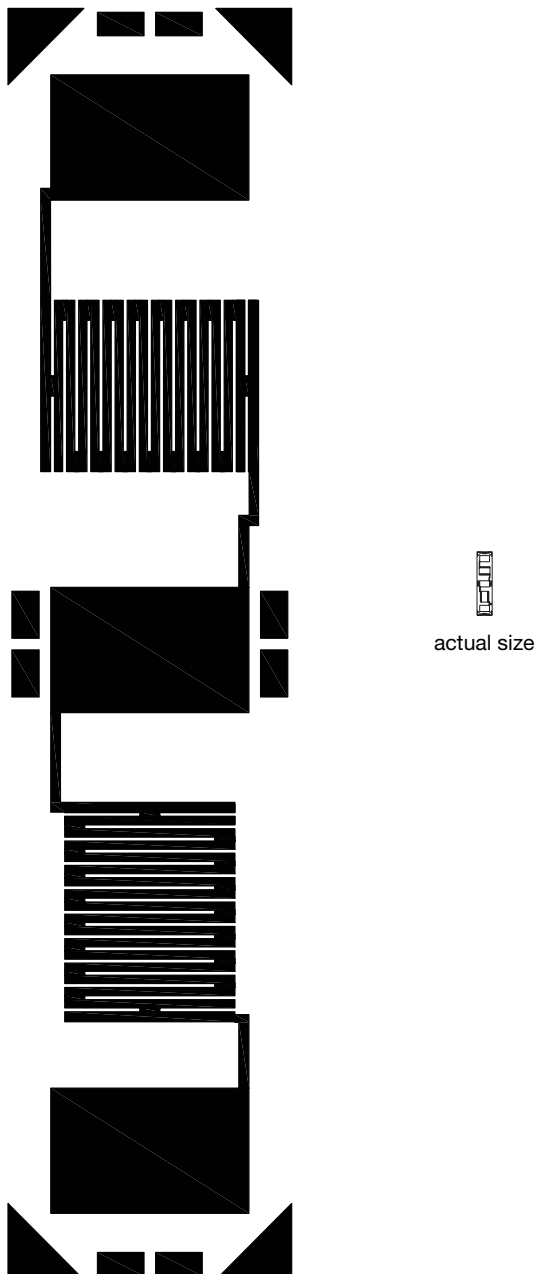
S5045 GAGE PATTERN DATA			
	GAGE DESIGNATION	RESISTANCE IN OHMS	STD. CREEP CODE
	N2K-XX-S5045H-10C/DG/E3 N5K-XX-S5045H-10C/DG/E3	1000 ±0.2% 1000 ±0.2%	H* H*
<p>DESCRIPTION</p> <p>Often used on small column transducers.</p> <p>RoHS-compliant.</p>			

GAGE DIMENSIONS					
					inch
					millimeter
Gage Length	Overall Length	Grid Width	Overall Width	Matrix Length	Matrix Width
0.033	0.291	0.056	0.056	0.33	0.08
0.80	7.40	1.40	1.40	8.4	2.0

* Only creep code available for this gage.
Copper plating for tabs is available.

Advanced Sensors

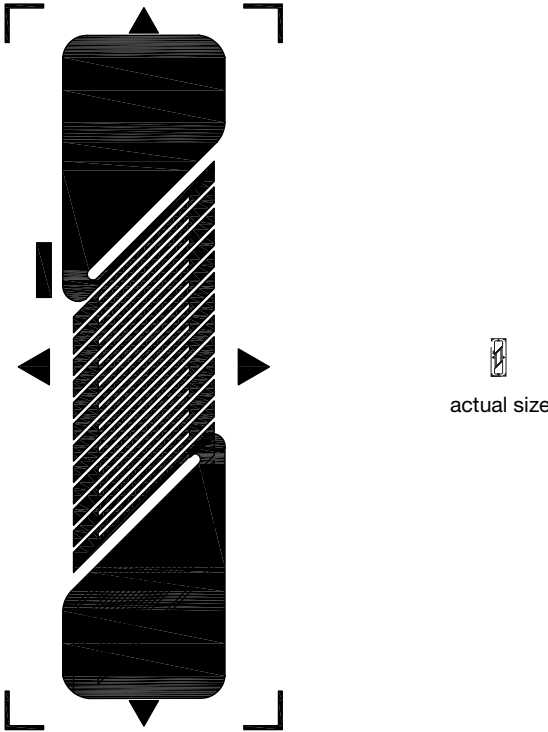
S5033 AND S5034 GAGE PATTERN DATA			
 <p>actual size</p>	GAGE DESIGNATION	RESISTANCE IN OHMS	STD. CREEP CODE
	N2K-XX-S5033Q-10C/DG/E3	1000 ±0.2%	Q
N5K-XX-S5033Q-10C/DG/E3	1000 ±0.2%	Q	
N2K-XX-S5034P-50C/DG/E3	5000 ±0.2%	P	
N5K-XX-S5034P-50C/DG/E3	5000 ±0.2%	P	
<p>DESCRIPTION</p> <p>Single element miniature shear pattern. RoHS-compliant.</p>			

GAGE DIMENSIONS					
					inch
					millimeter
Gage Length	Overall Length	Grid Width	Overall Width	Matrix Length	Matrix Width
0.034	0.173	0.050	0.042	0.19	0.08
0.86	4.39	1.27	1.07	4.9	1.9

Copper plating for tabs is available.

Advanced Sensors

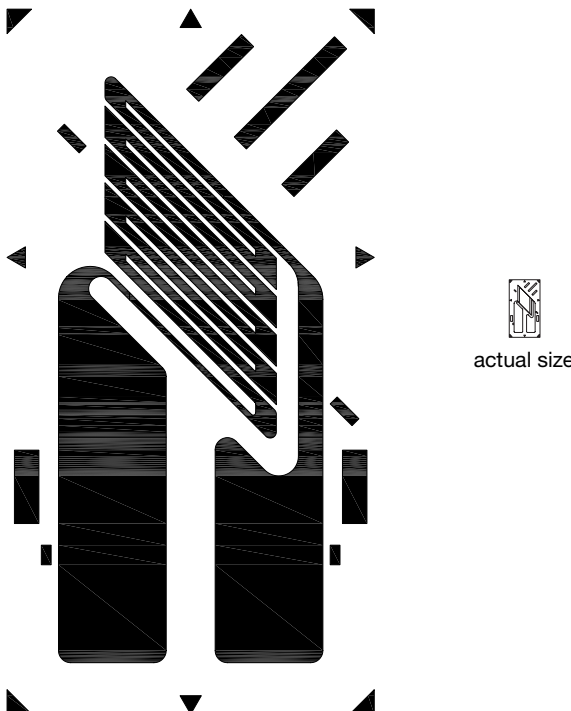
S5125 AND S5102 GAGE PATTERN DATA			
 <p>actual size</p>	GAGE DESIGNATION	RESISTANCE IN OHMS	STD. CREEP CODE
	N5K-XX-S5125T-350/DG/E3 N2K-XX-S5125T-350/DG/E3 N2K-XX-S5102T-10C/DG/E3 N5K-XX-S5102T-10C/DG/E3	350 ±0.2% 350 ±0.2% 1000 ±0.2% 1000 ±0.2%	T* T* T* T*
<p>DESCRIPTION</p> <p>Single-element shear pattern with tabs on one end.</p> <p>RoHS-compliant.</p>			

GAGE DIMENSIONS					
					inch
					millimeter
Gage Length	Overall Length	Grid Width	Overall Width	Matrix Length	Matrix Width
0.075	0.235	0.060	0.108	0.30	0.16
1.90	5.97	1.52	2.74	7.5	4.0

* Only creep code available for this gage.
Copper plating for tabs is available.

Advanced Sensors

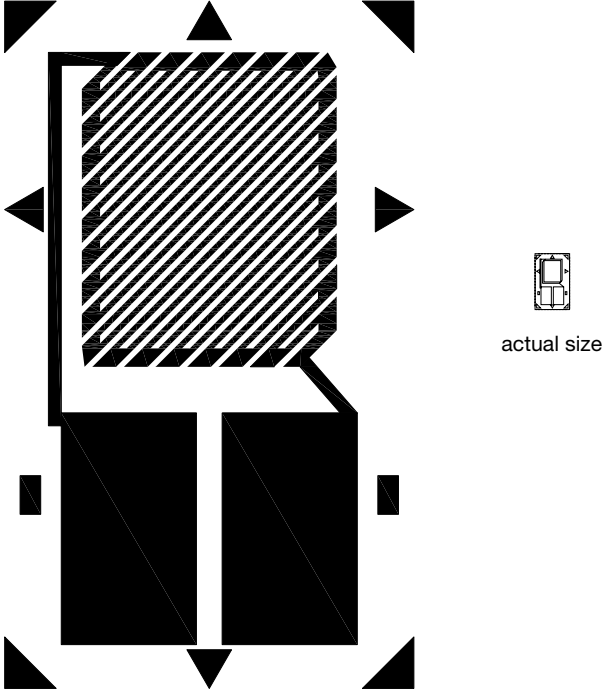
S5061 GAGE PATTERN DATA			
	GAGE DESIGNATION	RESISTANCE IN OHMS	STD. CREEP CODE
	N2K-XX-S5061Q-10C/DG/E3 N5K-XX-S5061Q-10C/DG/E3	5000 ±0.2% 5000 ±0.2%	Q* Q*
<p>DESCRIPTION</p> <p>High-resistance single-element shear pattern with tabs on one side.</p> <p>RoHS-compliant.</p>			

GAGE DIMENSIONS							
<table border="1"> <tr> <td>inch</td> </tr> <tr> <td>millimeter</td> </tr> </table>						inch	millimeter
inch							
millimeter							
Gage Length	Overall Length	Grid Width	Overall Width	Matrix Length	Matrix Width		
0.120	0.232	0.136	0.120	0.28	0.18		
3.05	5.89	3.45	3.05	7.2	4.4		

* Only creep code available for this gage.
Copper plating for tabs is available.

Advanced Sensors

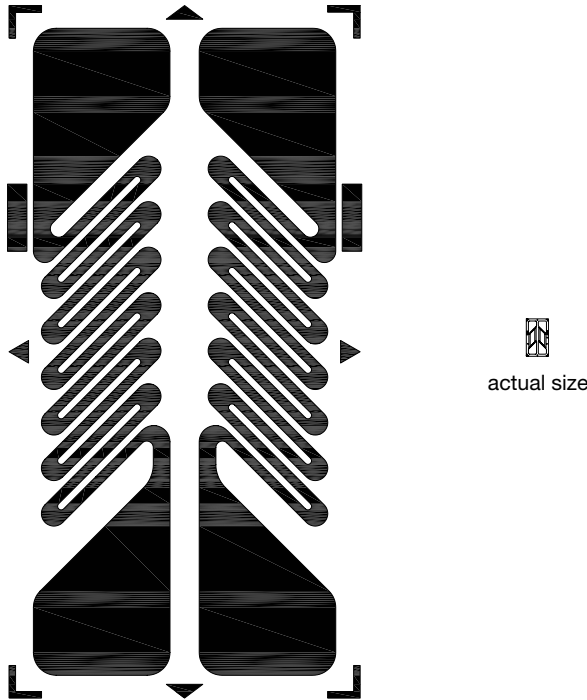

S5136, 5130, AND S5064 GAGE PATTERN DATA

	GAGE DESIGNATION	RESISTANCE IN OHMS	STD. CREEP CODE
	N5K-XX-S5136Q-175/DG/E4	175 ±0.2%	Q*
N2K-XX-S5136Q-175/DG/E4	175 ±0.2%	Q*	
N5K-XX-S5130Q-350/DG/E4	350 ±0.2%	Q*	
N2K-XX-S5130Q-350/DG/E4	350 ±0.2%	Q*	
N5K-XX-S5064Q-10C/DG/E3	1000 ±0.2%	Q*	
N2K-XX-S5064Q-10C/DG/E3	1000 ±0.2%	Q*	
<p>DESCRIPTION</p> <p>Dual-element pattern for shear or torque transducers. RoHS-compliant.</p>			

GAGE DIMENSIONS					
					inch
					millimeter
Gage Length	Overall Length	Grid Width	Overall Width	Matrix Length	Matrix Width
0.034	0.173	0.050	0.094	0.19	0.12
0.86	4.39	1.27	2.38	4.9	2.9

* Only creep code available for this gage.
Copper plating for tabs is available.

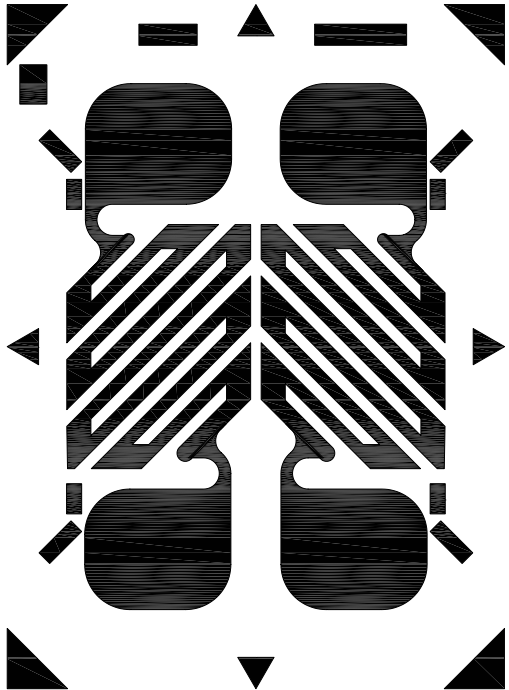
Advanced Sensors

S5135 GAGE PATTERN DATA			
  actual size	GAGE DESIGNATION	RESISTANCE IN OHMS	STD. CREEP CODE
	N2A-XX-S5135M-350/E4	350 ±0.2%	M*
DESCRIPTION Dual-element pattern for shear or torque transducers. RoHS-compliant.			

GAGE DIMENSIONS							
<table border="1"> <tr> <td>inch</td> </tr> <tr> <td>millimeter</td> </tr> </table>						inch	millimeter
inch							
millimeter							
Gage Length	Overall Length	Grid Width	Overall Width	Matrix Length	Matrix Width		
0.064	0.175	0.070	0.113	0.23	0.17		
1.61	4.44	1.78	2.87	6.0	4.4		

* Only creep code available for this gage.

Advanced Sensors

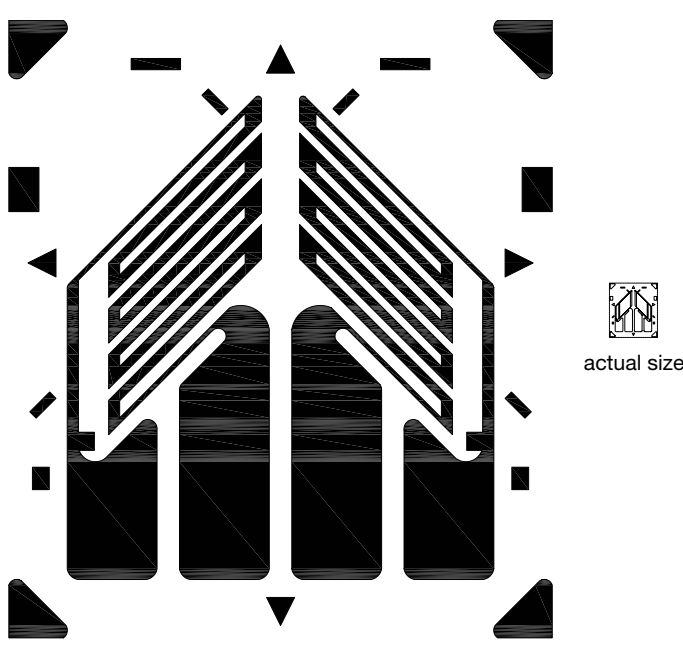
S5095 GAGE PATTERN DATA			
 <p>actual size</p>	GAGE DESIGNATION	RESISTANCE IN OHMS	STD. CREEP CODE
	N2A-XX-S5095N-350/E3	350 ±0.2%	N
<p>DESCRIPTION</p> <p>Dual-element pattern for shear or torque transducers. RoHS-compliant.</p>			

GAGE DIMENSIONS							
<table border="1"> <tr> <td>inch</td> </tr> <tr> <td>millimeter</td> </tr> </table>						inch	millimeter
inch							
millimeter							
Gage Length	Overall Length	Grid Width	Overall Width	Matrix Length	Matrix Width		
0.079	0.215	0.056	0.190	0.28	0.25		
2.00	5.46	1.43	4.83	7.2	6.4		

Advanced Sensors

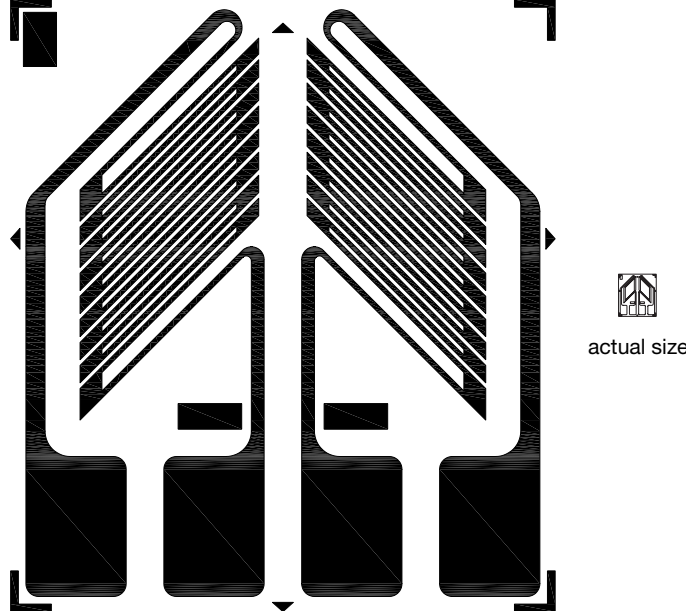
S5103 GAGE PATTERN DATA			
 <p>actual size</p>	GAGE DESIGNATION	RESISTANCE IN OHMS	STD. CREEP CODE
	N2K-XX-S5103R-350/DG/E3	350 ±0.2%	Q*
	N5K-XX-S5103R-350/DG/E3	350 ±0.2%	Q*
<p>DESCRIPTION</p> <p>Dual-element pattern for shear or torque transducers RoHS-compliant.</p>			

GAGE DIMENSIONS							
<table border="1"> <tr> <td>inch</td> </tr> <tr> <td>millimeter</td> </tr> </table>						inch	millimeter
inch							
millimeter							
Gage Length	Overall Length	Grid Width	Overall Width	Matrix Length	Matrix Width		
0.075	0.231	0.060	0.202	0.25	0.22		
1.91	5.86	1.52	5.13	6.3	5.6		

* Only creep code available for this gage.
Copper plating for tabs is available.

Advanced Sensors

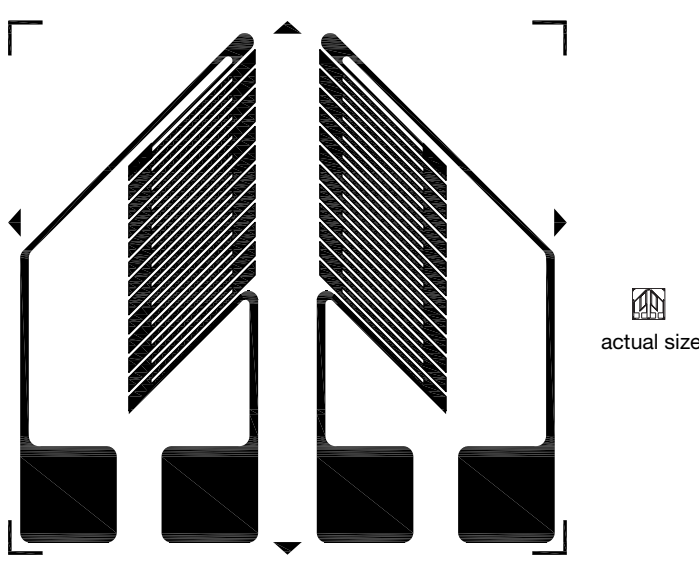
S5035 AND S5036 GAGE PATTERN DATA			
	GAGE DESIGNATION	RESISTANCE IN OHMS	STD. CREEP CODE
	N2K-XX-S5035Q-10C/DG/E3	1000 ±0.2%	Q*
	N5K-XX-S5035Q-10C/DG/E3	1000 ±0.2%	Q*
	N2K-XX-S5036Q-50C/DG/E3	5000 ±0.2%	Q*
	N5K-XX-S5036Q-50C/DG/E3	5000 ±0.2%	Q*
<p>DESCRIPTION</p> <p>Dual-element pattern for shear or torque transducers RoHS-compliant.</p>			

GAGE DIMENSIONS							
<table border="1"> <tr> <td>inch</td> </tr> <tr> <td>millimeter</td> </tr> </table>						inch	millimeter
inch							
millimeter							
Gage Length	Overall Length	Grid Width	Overall Width	Matrix Length	Matrix Width		
0.033	0.148	0.051	0.155	0.16	0.17		
0.84	3.76	1.29	3.94	4.1	4.3		

* Only creep code available for this gage.
Copper plating for tabs is available.

Advanced Sensors

S5113, S5116, S5089, S5040 GAGE PATTERN DATA

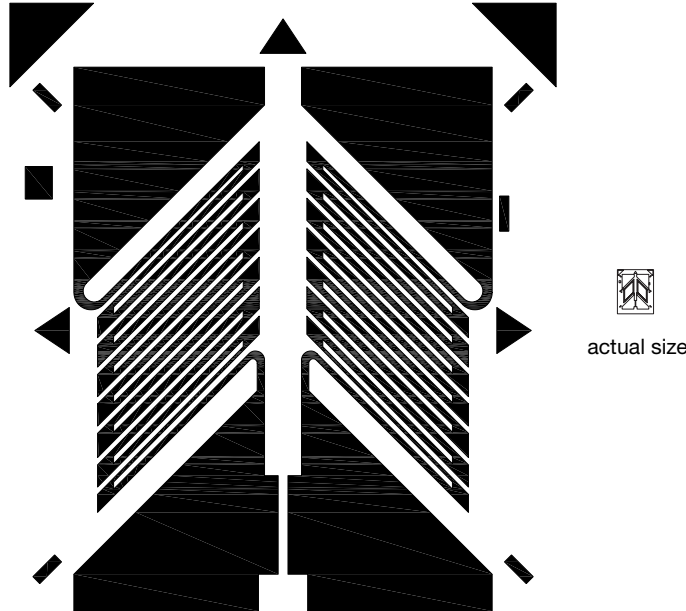
	GAGE DESIGNATION	RESISTANCE IN OHMS	STD. CREEP CODE
	N2K-XX-S5113R-350/DG/E3	350 ±0.2%	R
	N5K-XX-S5113R-350/DG/E3	350 ±0.2%	R
	N2K-XX-S5116Q-10C/DG/E3	1000 ±0.2%	Q*
	N5K-XX-S5116Q-10C/DG/E3	1000 ±0.2%	Q*
	N2K-XX-S5089Q-25C/DG/E3	2500 ±0.3%	Q*
	N5K-XX-S5089Q-25C/DG/E3	2500 ±0.3%	Q*
	N2K-XX-S5040Q-50C/DG/E3	5000 ±0.2%	Q*
	N5K-XX-S5040Q-50C/DG/E3	5000 ±0.2%	Q*
DESCRIPTION			
Dual-element pattern for shear or torque transducers. RoHS-compliant.			

GAGE DIMENSIONS**					
					inch
					millimeter
Gage Length	Overall Length	Grid Width	Overall Width	Matrix Length	Matrix Width
0.075	0.221	0.060	0.170	0.28	0.23
1.91	5.61	1.52	4.32	7.1	5.8

* Only creep code available for this gage.
** Grid dimensions may differ from pattern to pattern.
Copper plating for tabs is available.

Advanced Sensors

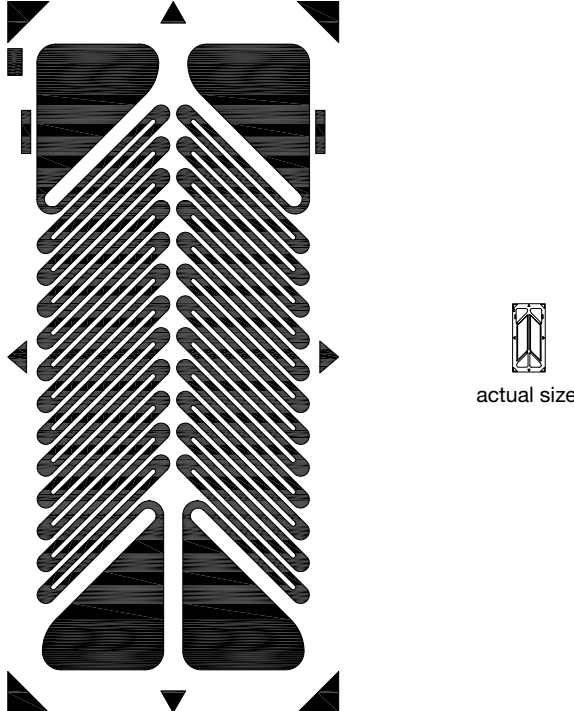
S5147 GAGE PATTERN DATA			
 <p>actual size</p>	GAGE DESIGNATION	RESISTANCE IN OHMS	STD. CREEP CODE
	N2K-XX-S5147P-10C/DG/E4 N5K-XX-S5147P-10C/DG/E4	1000 ±0.2% 1000 ±0.2%	P* P*
<p>DESCRIPTION</p> <p>Dual-element pattern for shear or torque transducers. RoHS-compliant.</p>			

GAGE DIMENSIONS					
					inch
					millimeter
Gage Length	Overall Length	Grid Width	Overall Width	Matrix Length	Matrix Width
0.071	0.307	0.130	0.126	0.35	0.17
1.80	7.79	3.30	3.20	9.0	4.3

* Only creep code available for this gage.
Copper plating for tabs is available.

Advanced Sensors

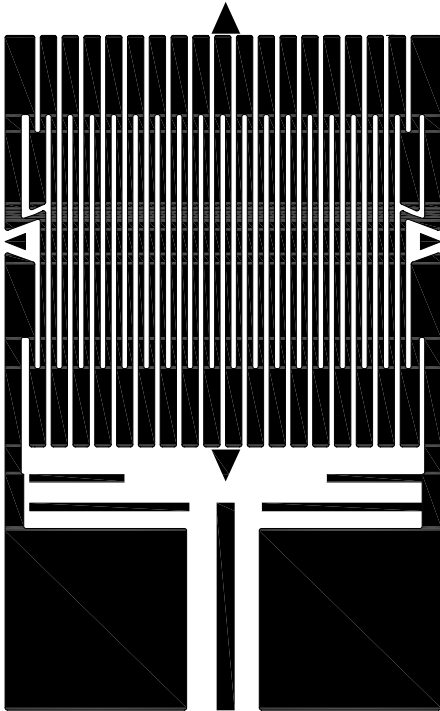
S5024 GAGE PATTERN DATA			
 <p style="text-align: center;">actual size</p>	GAGE DESIGNATION	RESISTANCE IN OHMS	STD. CREEP CODE
	N2K-XX-S5024G-50C/DG/E3	5000 ±0.2%	G
	N5K-XX-S5024G-50C/DG/E3	5000 ±0.2%	G
<p>DESCRIPTION</p> <p>Miniature 5000Ω linear gage. Can be used in 4 mA to 20 mA transmitters and battery-operated transducers. RoHS-compliant.</p>			

GAGE DIMENSIONS					
					inch
					millimeter
Gage Length	Overall Length	Grid Width	Overall Width	Matrix Length	Matrix Width
0.026	0.063	0.048	0.048	0.07	0.05
0.66	1.60	1.22	1.22	1.9	1.4

Copper plating for tabs is available.

Advanced Sensors

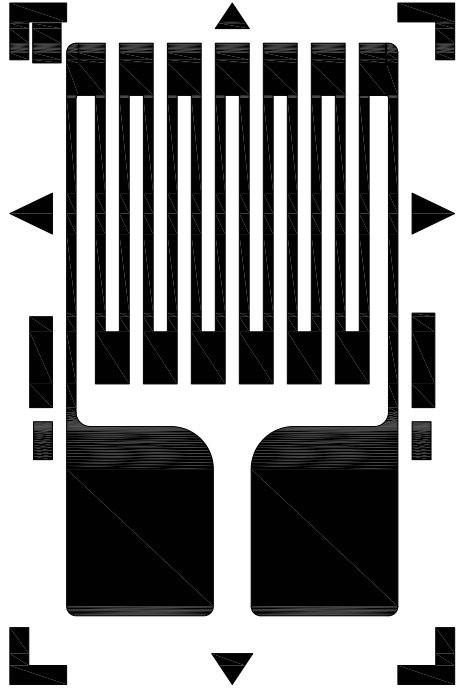
S5120 GAGE PATTERN DATA			
 <p style="text-align: center;">actual size</p>	GAGE DESIGNATION	RESISTANCE IN OHMS	STD. CREEP CODE
	N2K-XX-S5120S-25C/DG/E3	2500 ±0.2%	S*
	N5K-XX-S5120S-25C/DG/E3	2500 ±0.2%	S*
<p>DESCRIPTION</p> <p>Widely used in 4–20 mA transmitters and battery-operated transducers.</p> <p>RoHS-compliant.</p>			

GAGE DIMENSIONS							
<table border="1" style="display: inline-table;"> <tr><td>inch</td></tr> <tr><td>millimeter</td></tr> </table>						inch	millimeter
inch							
millimeter							
Gage Length	Overall Length	Grid Width	Overall Width	Matrix Length	Matrix Width		
0.050	0.110	0.065	0.070	0.15	0.10		
1.27	2.79	1.65	1.78	3.9	2.6		

* Only creep code available for this gage.
Copper plating for tabs is available.

Advanced Sensors

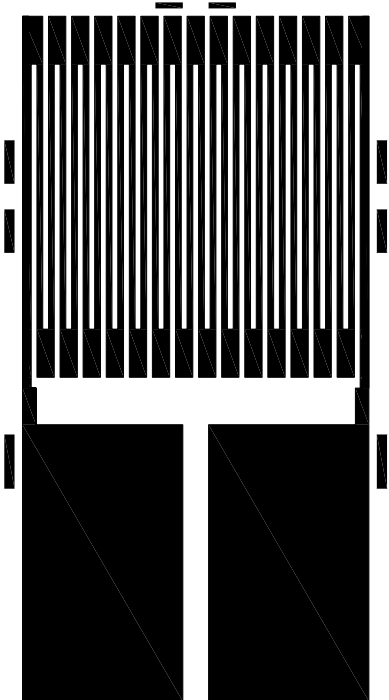
S5044 GAGE PATTERN DATA			
 <p>actual size</p>	GAGE DESIGNATION	RESISTANCE IN OHMS	STD. CREEP CODE
	N2K-XX-S5044Q-50C/DG/E3	5000 ±0.2%	Q*
	N5K-XX-S5044Q-50C/DG/E3	5000 ±0.2%	Q*
<p>DESCRIPTION</p> <p>Similar grid to S5030 with smaller matrix size. Widely used in 4-20mA transmitters and battery operated transducers.</p> <p>RoHS-compliant.</p>			

GAGE DIMENSIONS					
					inch
					millimeter
Gage Length	Overall Length	Grid Width	Overall Width	Matrix Length	Matrix Width
0.050	0.129	0.065	0.065	0.14	0.08
1.27	3.28	1.65	1.65	3.6	1.9

* Only creep code available for this gage.
Copper plating for tabs is available.

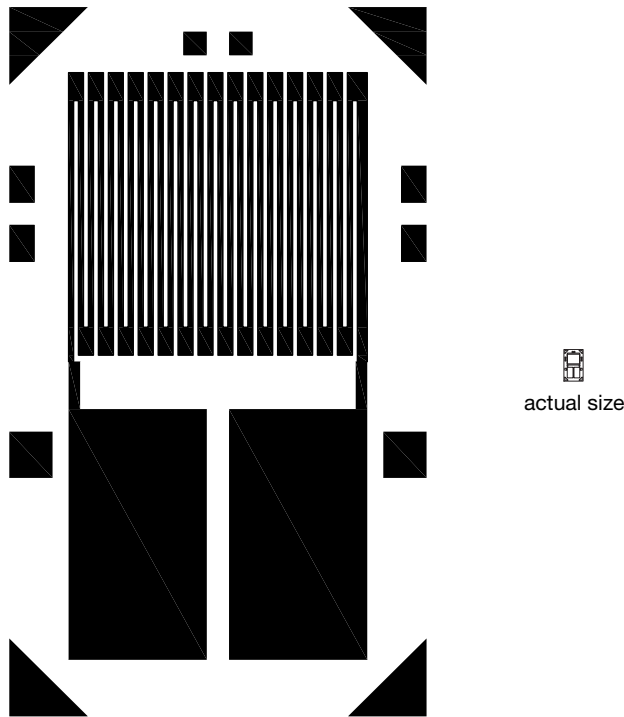

Advanced Sensors

S5030 GAGE PATTERN DATA			
 <p>actual size</p>	GAGE DESIGNATION	RESISTANCE IN OHMS	STD. CREEP CODE
	N2K-XX-S5030K-50C/DG/E3	5000 ±0.2%	K
	N5K-XX-S5030K-50C/DG/E3	5000 ±0.2%	K
<p>DESCRIPTION</p> <p>Widely used in 4 mA to 20 mA transmitters and battery operated transducers.</p> <p>N5K pattern has 0.125 in (3.2 mm) overall length and slightly longer matrix.</p> <p>RoHS-compliant.</p>			

GAGE DIMENSIONS							
<table border="1"> <tr> <td>inch</td> </tr> <tr> <td>millimeter</td> </tr> </table>						inch	millimeter
inch							
millimeter							
Gage Length	Overall Length	Grid Width	Overall Width	Matrix Length	Matrix Width		
0.050	0.129	0.065	0.065	0.16	0.10		
1.27	3.28	1.66	1.66	4.2	2.5		

Copper plating for tabs is available.

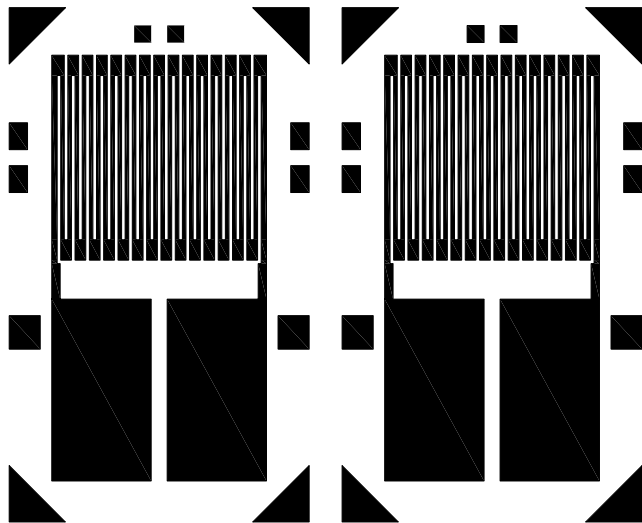
Advanced Sensors

S5054 GAGE PATTERN DATA			
 <p style="text-align: center;">  actual size </p>	GAGE DESIGNATION	RESISTANCE IN OHMS	STD. CREEP CODE
	N2K-XX-S5054K-50C/DG/E3	5000 ±0.2%	K*
	N5K-XX-S5054K-50C/DG/E3	5000 ±0.2%	K*
DESCRIPTION Dual linear S5030 gage side by side. RoHS-compliant.			

GAGE DIMENSIONS					
					inch
					millimeter
Gage Length	Overall Length	Grid Width	Overall Width	Matrix Length	Matrix Width
0.050	0.129	0.065	0.166	0.17	0.20
1.27	3.28	1.65	4.22	4.2	5.1

* Only creep code available for this gage.
 Copper plating for tabs is available.

Advanced Sensors

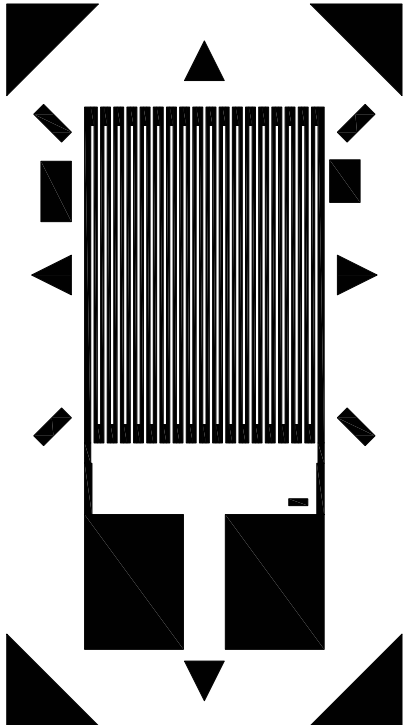
S5029 GAGE PATTERN DATA			
 <p style="text-align: center;">actual size</p>	GAGE DESIGNATION	RESISTANCE IN OHMS	STD. CREEP CODE
	N2K-XX-S5029L-45C/DG/E3 N5K-XX-S5029L-45C/DG/E3	4500 ±0.2% 4500 ±0.2%	L L
<p>DESCRIPTION</p> <p>Larger grid pattern than the S5030.</p> <p>RoHS-compliant.</p>			

GAGE DIMENSIONS							
<table border="1" style="display: inline-table; vertical-align: middle;"> <tr><td style="text-align: center;">inch</td></tr> <tr><td style="text-align: center;">millimeter</td></tr> </table>						inch	millimeter
inch							
millimeter							
Gage Length	Overall Length	Grid Width	Overall Width	Matrix Length	Matrix Width		
0.100	0.182	0.080	0.080	0.25	0.14		
2.54	4.61	2.03	2.03	6.3	3.5		

Copper plating for tabs is available.

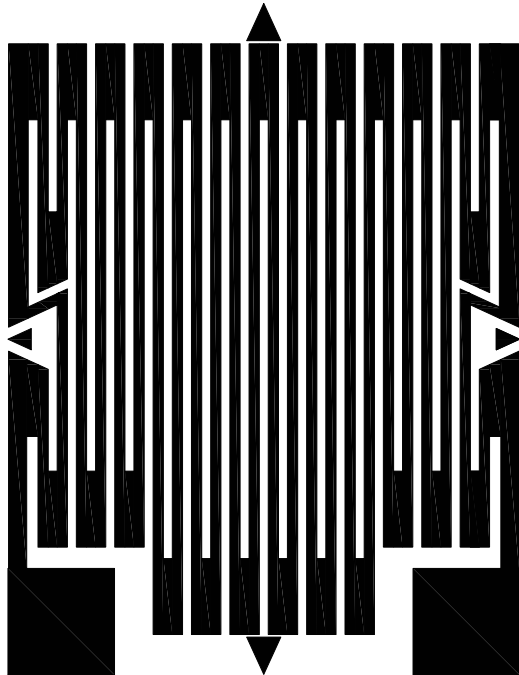

Advanced Sensors

S5032 GAGE PATTERN DATA			
 <p style="text-align: center;">actual size</p>	GAGE DESIGNATION	RESISTANCE IN OHMS	STD. CREEP CODE
	N2K-XX-S5032M-100C/DG/E3	10000 ±0.2%	M
	N5K-XX-S5032M-100C/DG/E3	10000 ±0.2%	M
<p>DESCRIPTION</p> <p>Miniature 10000Ω linear gage. Can be used in 4 mA to 20 mA transmitters and battery-operated transducers. RoHS-compliant.</p>			

GAGE DIMENSIONS					
					inch
					millimeter
Gage Length	Overall Length	Grid Width	Overall Width	Matrix Length	Matrix Width
0.040	0.061	0.048	0.048	0.07	0.06
1.02	1.55	1.22	1.22	1.8	1.4

Copper plating for tabs is available.

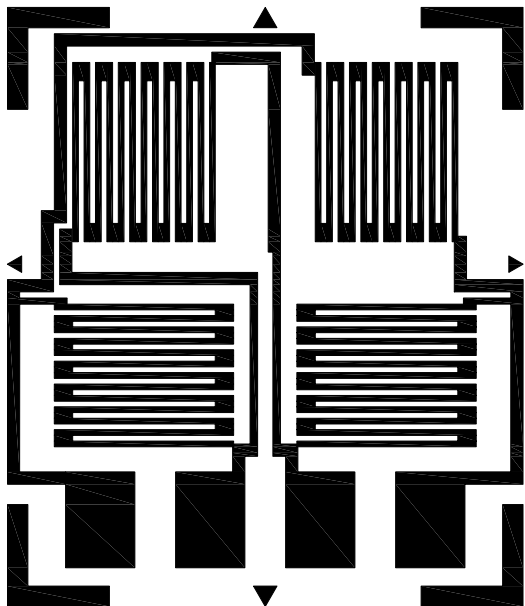
Advanced Sensors

S5056 GAGE PATTERN DATA			
	GAGE DESIGNATION	RESISTANCE IN OHMS	STD. CREEP CODE
	N2K-XX-S5056Q-10C/DG/E3 N5K-XX-S5056Q-10C/DG/E3	1000 ±0.2% 1000 ±0.2%	Q* Q*
 actual size	DESCRIPTION		
Full bridge for bending-beam transducers. Bridge is balanced to 0.4 mV/V, but RG is 1000Ω ±0.2%. RoHS-compliant.			

GAGE DIMENSIONS						inch millimeter
Gage Length	Overall Length	Grid Width	Overall Width	Matrix Length	Matrix Width	
0.070	0.262	0.070	0.253	0.31	0.27	
1.78	6.66	1.78	6.43	7.9	6.8	

* Only creep code available for this gage.
Copper plating for tabs is available.

Advanced Sensors

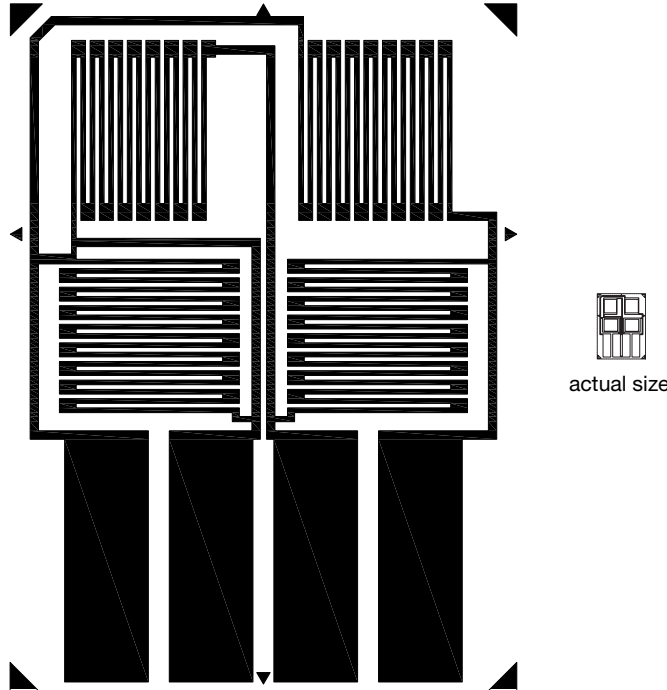
S5107 GAGE PATTERN DATA			
	GAGE DESIGNATION	RESISTANCE IN OHMS	STD. CREEP CODE
	N2K-XX-S5107Q-12C/DG/E3	1200 ±0.3%	Q*
	N5K-XX-S5107Q-12C/DG/E3	1200 ±0.3%	Q*
<p>DESCRIPTION</p> <p>Full-bridge gage for bending-beam transducers. Balanced to ± 0.4mV/V, but RG is 1200 ohms ±0.3%. RoHS-compliant.</p>			

GAGE DIMENSIONS							
<table border="1"> <tr> <td>inch</td> </tr> <tr> <td>millimeter</td> </tr> </table>						inch	millimeter
inch							
millimeter							
Gage Length	Overall Length	Grid Width	Overall Width	Matrix Length	Matrix Width		
0.070	0.302	0.070	0.190	0.34	0.25		
1.78	7.67	1.78	4.83	8.5	6.4		

* Only creep code available for this gage.
Copper plating for tabs is available.

Advanced Sensors

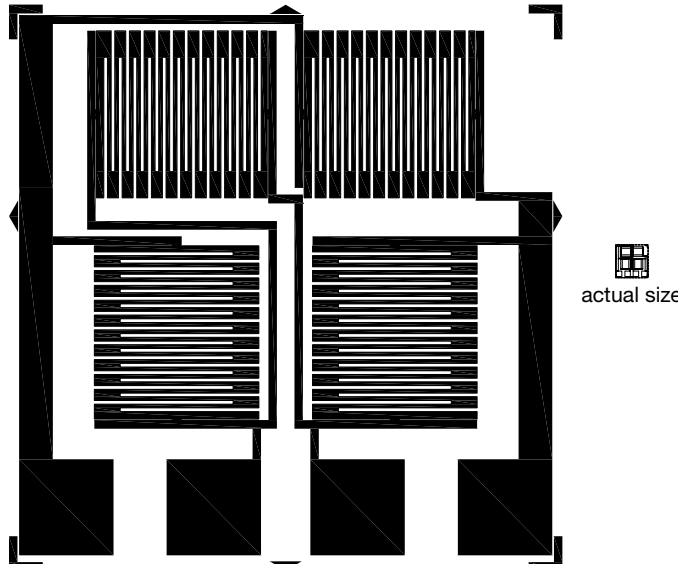
S5067 GAGE PATTERN DATA			
	GAGE DESIGNATION	RESISTANCE IN OHMS	STD. CREEP CODE
	N2K-XX-S5067P-10C/DG/E3 N5K-XX-S5067P-10C/DG/E3	1000 ±0.2% 1000 ±0.2%	P* P*
<p>DESCRIPTION</p> <p>1k Full-bridge gage. Bridge is balanced to ±0.4 mV/V, but RG is 1000 ohms ±0.2%. RoHS-compliant.</p>			

GAGE DIMENSIONS					
					<input type="checkbox"/> inch <input checked="" type="checkbox"/> millimeter
Gage Length	Overall Length	Grid Width	Overall Width	Matrix Length	Matrix Width
0.033	0.158	0.053	0.158	0.17	0.17
0.84	4.01	1.35	4.01	4.3	4.3

* Only creep code available for this gage.
Copper plating for tabs is available.

Advanced Sensors

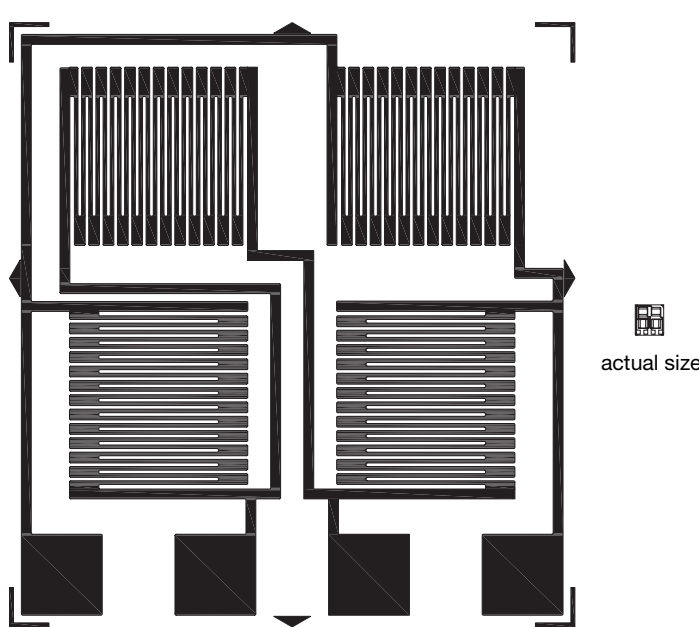
S5020 GAGE PATTERN DATA			
 <p>actual size</p>	GAGE DESIGNATION	RESISTANCE IN OHMS	STD. CREEP CODE
	N2K-XX-S5020Q-50C/DG/E3	5000 ±0.2%	Q
	N5K-XX-S5020Q-50C/DG/E3	5000 ±0.2%	Q
<p>DESCRIPTION</p> <p>Full bridge gage for bending beam transducers. Bridge is balanced to ±0.4 mV/V, but RG is 5000Ω ±0.2%. RoHS-compliant.</p>			

GAGE DIMENSIONS					
					<input type="checkbox"/> inch <input checked="" type="checkbox"/> millimeter
Gage Length	Overall Length	Grid Width	Overall Width	Matrix Length	Matrix Width
0.028	0.147	0.044	0.137	0.16	0.15
0.71	3.74	1.13	3.48	4.2	3.8

Copper plating for tabs is available.

Advanced Sensors

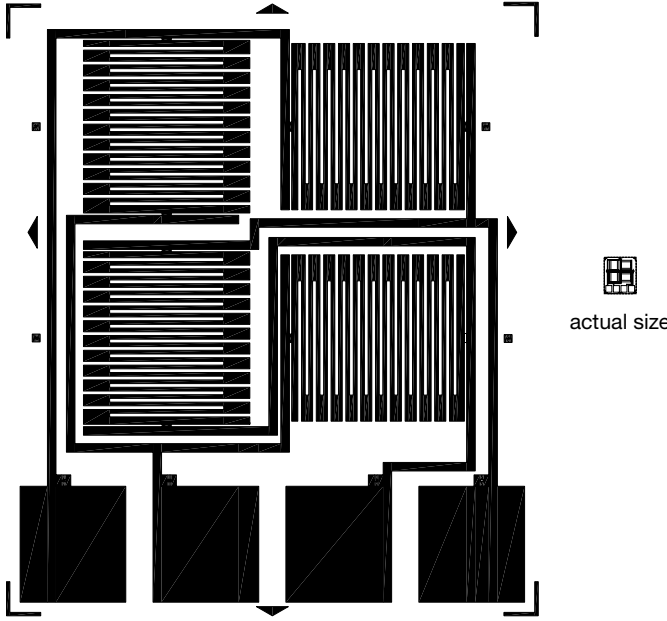
S5062 GAGE PATTERN DATA			
 <p>actual size</p>	GAGE DESIGNATION	RESISTANCE IN OHMS	STD. CREEP CODE
	N2K-XX-S5062Q-10C/DG/E3	1000 ±0.2%	Q*
	N5K-XX-S5062Q-10C/DG/E3	1000 ±0.2%	Q*
<p>DESCRIPTION</p> <p>1k Full-bridge gage. Bridge is balanced to ±0.4 mV/V, but RG is 1000 ohms ±0.2%. RoHS-compliant.</p>			

GAGE DIMENSIONS							
<table border="1"> <tr> <td>inch</td> </tr> <tr> <td>millimeter</td> </tr> </table>						inch	millimeter
inch							
millimeter							
Gage Length	Overall Length	Grid Width	Overall Width	Matrix Length	Matrix Width		
0.033	0.148	0.057	0.168	0.16	0.19		
0.84	3.76	1.45	4.27	4.2	4.8		

*Only creep code available for this gage.
 Copper plating for tabs is available.

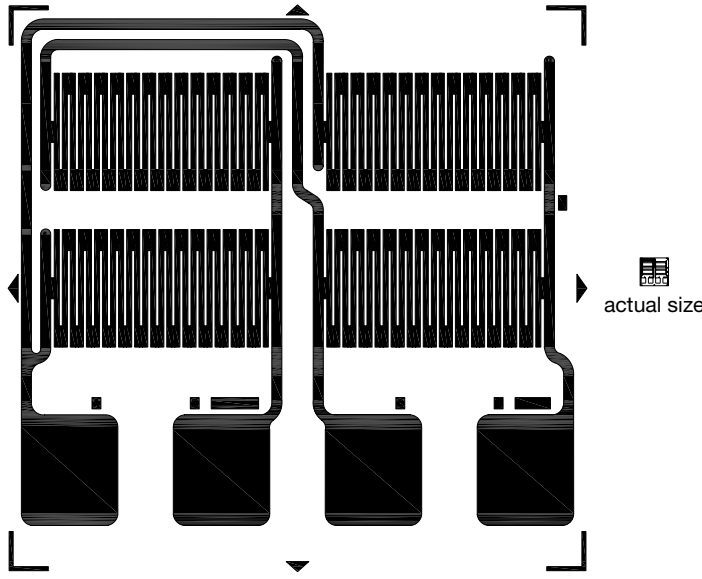

Advanced Sensors

S5047 GAGE PATTERN DATA			
	GAGE DESIGNATION	RESISTANCE IN OHMS	STD. CREEP CODE
	N2K-XX-S5047K-10C/DG/E3 N5K-XX-S5047K-10C/DG/E3	1000 ±0.2% 1000 ±0.2%	K* K*
<p>DESCRIPTION</p> <p>Compact full-bridge pattern for use on small, double-bending beams.</p> <p>Bridge is balanced to 0.4 mV/V, but RG is 1000Ω ±0.2%.</p> <p>RoHS-compliant.</p>			

GAGE DIMENSIONS							
<table border="1"> <tr> <td>inch</td> </tr> <tr> <td>millimeter</td> </tr> </table>						inch	millimeter
inch							
millimeter							
Gage Length	Overall Length	Grid Width	Overall Width	Matrix Length	Matrix Width		
0.017	0.126	0.060	0.137	0.14	0.15		
0.43	3.20	1.52	3.49	3.7	3.8		

* Only creep code available for this gage.
Copper plating for tabs is available.

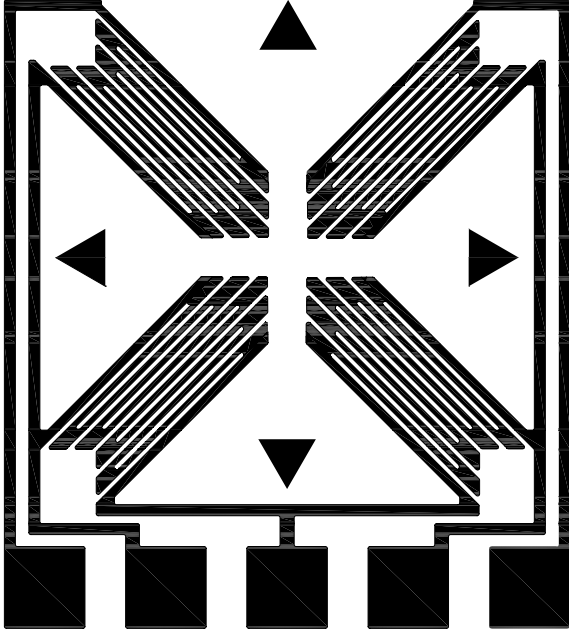
Advanced Sensors

S5023 GAGE PATTERN DATA			
	GAGE DESIGNATION	RESISTANCE IN OHMS	STD. CREEP CODE
	N2K-XX-S5023M-10C/DG/E3 N5K-XX-S5023M-10C/DG/E3	1000 ±0.2% 1000 ±0.2%	Q Q
<p style="text-align: center;">  actual size </p>			
<p>DESCRIPTION</p> <p>Full bridge pattern for shear or torque transducers. RoHS-compliant.</p>			

GAGE DIMENSIONS					
					inch
					millimeter
Gage Length	Overall Length	Grid Width	Overall Width	Matrix Length	Matrix Width
0.045	0.160	0.024	0.144	0.17	0.15
1.15	4.06	0.61	3.66	4.2	3.8

Copper plating for tabs is available.

Advanced Sensors

S5046 GAGE PATTERN DATA

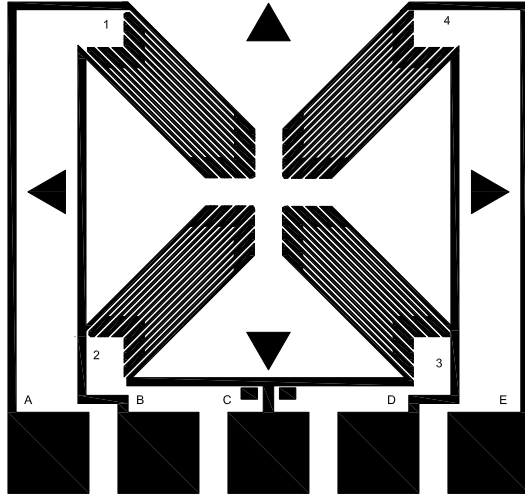

 actual size

GAGE DESIGNATION

**RESISTANCE
IN OHMS**

**STD.
CREEP
CODE**

N2K-XX-S5046M-50C/DG/E3
N5K-XX-S5046M-50C/DG/E3

5000 ±0.2%
5000 ±0.2%

M*
M*

DESCRIPTION

Full bridge pattern for shear or torque transducers
RoHS-compliant.



GAGE DIMENSIONS

inch
millimeter

Gage Length	Overall Length	Grid Width	Overall Width	Matrix Length	Matrix Width
0.044	0.170	0.024	0.180	0.18	0.19
1.12	4.31	0.61	4.57	4.5	4.8

* Only creep code available for this gage.
Copper plating for tabs is available.

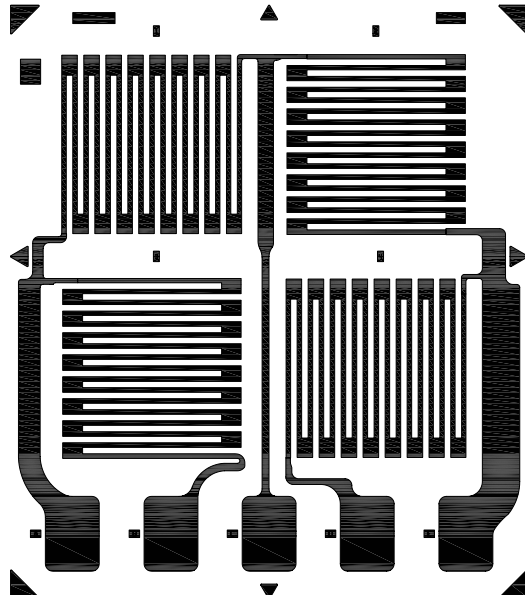
Advanced Sensors

S5139 GAGE PATTERN DATA			
  actual size	GAGE DESIGNATION	RESISTANCE IN OHMS	STD. CREEP CODE
	N2A-XX-S5139U-350/E4	350 ±0.2%	U*
DESCRIPTION Full-bridge pattern for single-surface gaging of transducers. RoHS-compliant.			

GAGE DIMENSIONS							
<table border="1"> <tr> <td>inch</td> </tr> <tr> <td>millimeter</td> </tr> </table>						inch	millimeter
inch							
millimeter							
Gage Length	Overall Length	Grid Width	Overall Width	Matrix Length	Matrix Width		
0.093	0.345	0.120	0.299	0.40	0.35		
2.36	8.76	3.04	7.59	10.3	9.0		

* Only creep code available for this gage.

Advanced Sensors

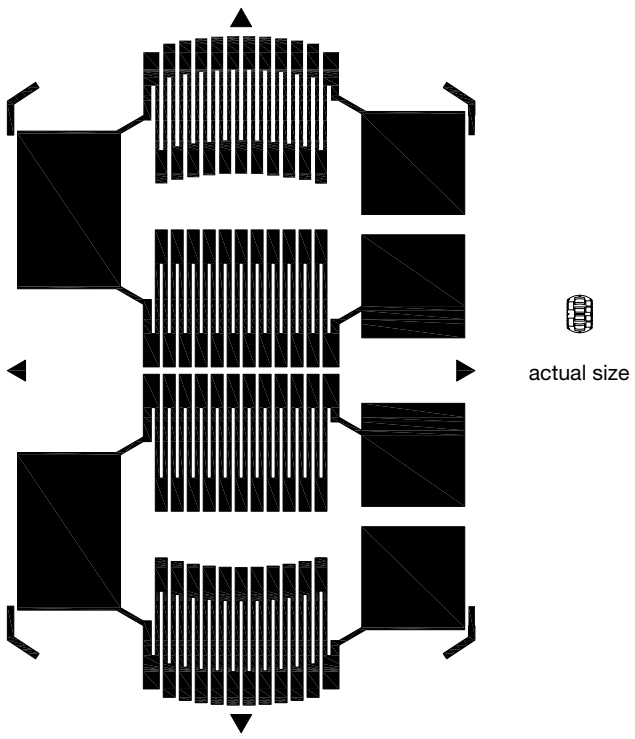
S5065 GAGE PATTERN DATA			
 <p>actual size</p>	GAGE DESIGNATION	RESISTANCE IN OHMS	STD. CREEP CODE
	N2K-XX-S5065M-350/DG/E3	350 ±0.3%	M*
	N5K-XX-S5065M-350/DG/E3	350 ±0.3%	M*
<p>DESCRIPTION</p> <p>Full-bridge gage for use on 0.200 in (5.08 mm) diameter diaphragm.</p> <p>RoHS-compliant.</p>			

GAGE DIMENSIONS							
					<table border="1"> <tr><td>inch</td></tr> <tr><td>millimeter</td></tr> </table>	inch	millimeter
inch							
millimeter							
Gage Length	Overall Length	Grid Width	Overall Width	Matrix Length	Matrix Width		
0.019	0.178	0.053	0.122	0.20	0.13		
0.48	4.52	1.35	3.10	5.1	3.4		

* Only creep code available for this gage.
Copper plating for tabs is available.

Advanced Sensors

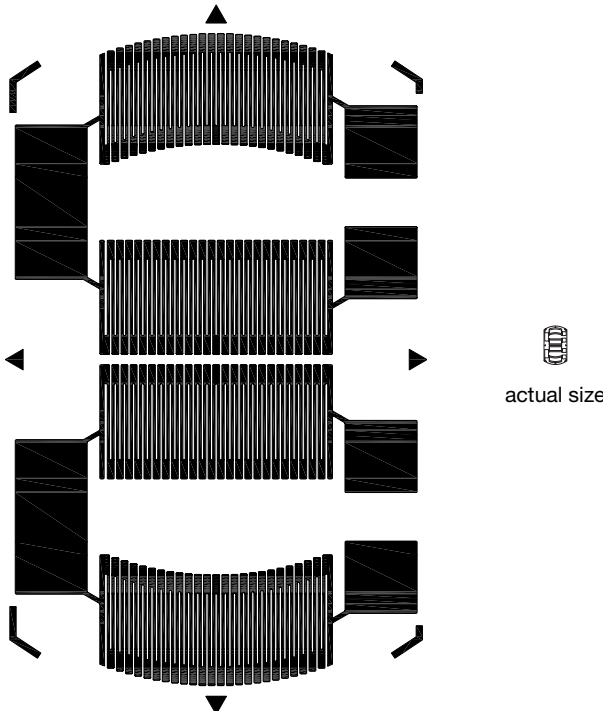
S5021 GAGE PATTERN DATA			
 <p>actual size</p>	GAGE DESIGNATION	RESISTANCE IN OHMS	STD. CREEP CODE
	N2K-XX-S5021M-50C/DG/E3	5000 ±0.3%	M*
	N5K-XX-S5021M-50C/DG/E3	5000 ±0.3%	M*
<p>DESCRIPTION</p> <p>Full bridge gage for use on 0.200 in (5.080 mm) diameter diaphragm.</p> <p>RoHS-compliant.</p>			

GAGE DIMENSIONS							
<table border="1"> <tr> <td>inch</td> </tr> <tr> <td>millimeter</td> </tr> </table>						inch	millimeter
inch							
millimeter							
Gage Length	Overall Length	Grid Width	Overall Width	Matrix Length	Matrix Width		
0.019	0.187	0.065	0.112	0.20	0.12		
0.49	4.74	1.64	2.83	5.1	3.1		

* Only creep code available for this gage.
Copper plating for tabs is available.

Advanced Sensors

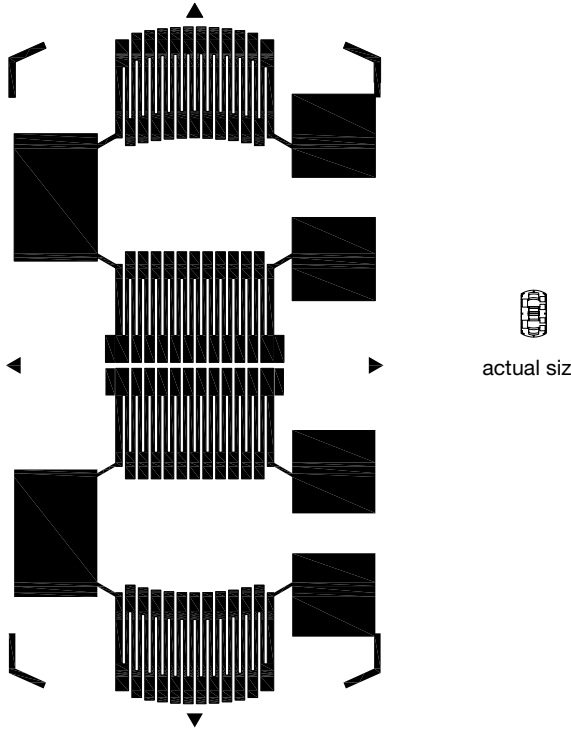
S5066 GAGE PATTERN DATA			
 <p>actual size</p>	GAGE DESIGNATION	RESISTANCE IN OHMS	STD. CREEP CODE
	N2K-XX-S5066M-350/DG/E3	350 ±0.3%	M*
	N5K-XX-S5066M-350/DG/E3	350 ±0.3%	M*
<p>DESCRIPTION</p> <p>Full-bridge gage for use on 0.250 in (6.35 mm) diameter diaphragm.</p> <p>RoHS-compliant.</p>			

GAGE DIMENSIONS							
<table border="1"> <tr> <td>inch</td> </tr> <tr> <td>millimeter</td> </tr> </table>						inch	millimeter
inch							
millimeter							
Gage Length	Overall Length	Grid Width	Overall Width	Matrix Length	Matrix Width		
0.019	0.224	0.053	0.122	0.25	0.13		
0.48	5.69	1.35	3.10	6.4	3.4		

* Only creep code available for this gage.
Copper plating for tabs is available.

Advanced Sensors

S5022 GAGE PATTERN DATA			
	GAGE DESIGNATION	RESISTANCE IN OHMS	STD. CREEP CODE
	N2K-XX-S5022M-50C/DG/E3	5000 ±0.3%	M*
	N5K-XX-S5022M-50C/DG/E3	5000 ±0.3%	M*
<p>DESCRIPTION</p> <p>Full bridge gage for use on 0.250 in (6.35 mm) diameter diaphragm.</p> <p>RoHS-compliant.</p>			

GAGE DIMENSIONS							
<table border="1"> <tr> <td>inch</td> </tr> <tr> <td>millimeter</td> </tr> </table>						inch	millimeter
inch							
millimeter							
Gage Length	Overall Length	Grid Width	Overall Width	Matrix Length	Matrix Width		
0.020	0.228	0.047	0.102	0.25	0.11		
0.52	5.78	1.19	2.59	6.4	2.8		

* Only creep code available for this gage.
Copper plating for tabs is available.



Advanced Sensors

S5026 GAGE PATTERN DATA			
	GAGE DESIGNATION	RESISTANCE IN OHMS	STD. CREEP CODE
	N2K-XX-S5026M-50C/DG/E3	5000 ±0.3%	M*
	N5K-XX-S5026M-50C/DG/E3	5000 ±0.3%	M*
<p>actual size</p>	<p>DESCRIPTION</p> <p>Full bridge pattern for use on 0.400 in (10.16 mm) diameter diaphragm. RoHS-compliant.</p>		

GAGE DIMENSIONS					
					inch
					millimeter
Gage Length	Overall Length	Grid Width	Overall Width	Matrix Length	Matrix Width
0.020	0.382	0.044	0.111	0.40	0.12
0.52	9.70	1.13	2.82	10.7	3.1

* Only creep code available for this gage.
Copper plating for tabs is available.

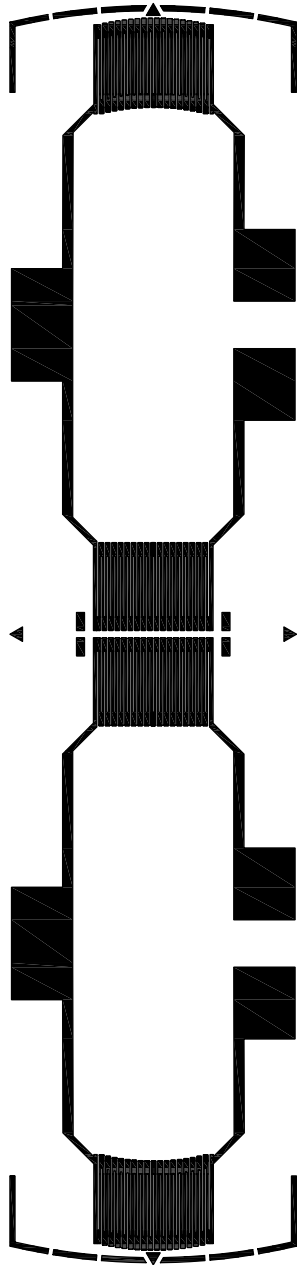
Advanced Sensors

S5025 GAGE PATTERN DATA			
	GAGE DESIGNATION	RESISTANCE IN OHMS	STD. CREEP CODE
	N2K-XX-S5025M-50C/DG/E3	5000 ±0.3%	M*
	N5K-XX-S5025M-50C/DG/E3	5000 ±0.3%	M*
 actual size	DESCRIPTION Full bridge pattern for use on 0.500 in (12.7 mm) diameter diaphragm. RoHS-compliant.		

GAGE DIMENSIONS					
					inch
					millimeter
Gage Length	Overall Length	Grid Width	Overall Width	Matrix Length	Matrix Width
0.020	0.482	0.044	0.111	0.50	0.12
0.52	12.24	1.13	2.82	12.7	3.1

* Only creep code available for this gage.
Copper plating for tabs is available.

Advanced Sensors

S5071 GAGE PATTERN DATA

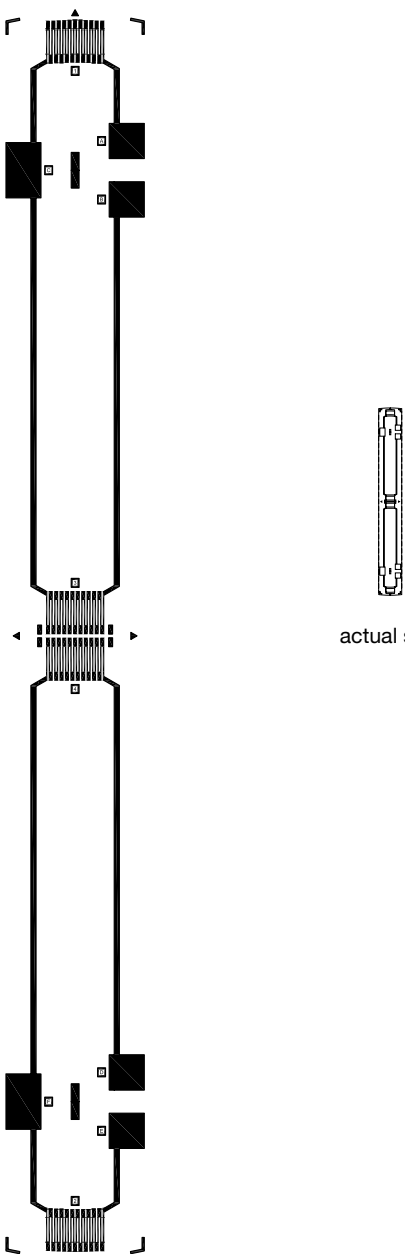
	GAGE DESIGNATION	RESISTANCE IN OHMS	STD. CREEP CODE
	N2K-XX-S5071M-50C/DG/E3 N5K-XX-S5071M-50C/DG/E3	5000 ±0.3% 5000 ±0.3%	M* M*
<p>DESCRIPTION</p> <p>Full-bridge pattern for use on 1.00 in (25.4 mm) diameter diaphragm. RoHS-compliant.</p>			

GAGE DIMENSIONS							
<table border="1" style="display: inline-table; vertical-align: middle;"> <tr><td>inch</td></tr> <tr><td>millimeter</td></tr> </table>						inch	millimeter
inch							
millimeter							
Gage Length	Overall Length	Grid Width	Overall Width	Matrix Length	Matrix Width		
0.020	0.982	0.047	0.111	1.00	0.12		
0.51	24.94	1.19	2.82	25.4	3.1		

* Only creep code available for this gage.
Copper plating for tabs is available.

Advanced Sensors

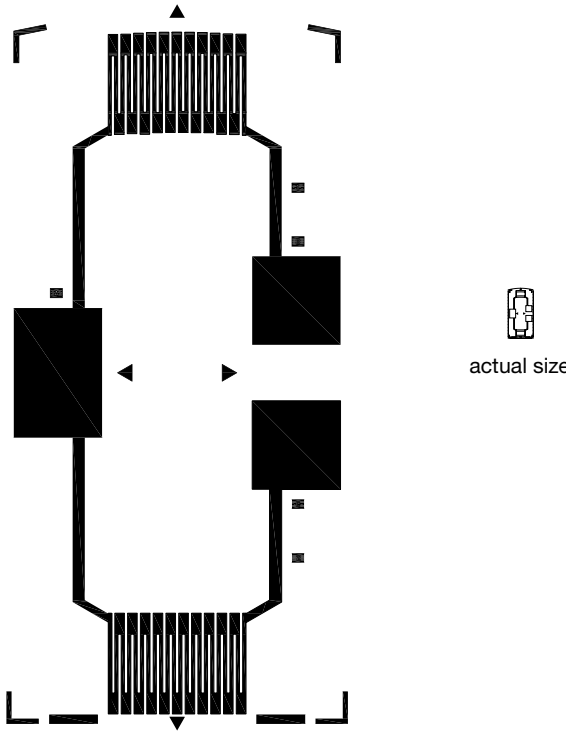
S5050 GAGE PATTERN DATA			
 <p>actual size</p>	GAGE DESIGNATION	RESISTANCE IN OHMS	STD. CREEP CODE
	N2K-XX-S5050M-30C/DG/E3 N5K-XX-S5050M-30C/DG/E3	3000 ±0.3% 3000 ±0.3%	M* M*
<p>DESCRIPTION</p> <p>Half diaphragm. RoHS-compliant.</p>			

GAGE DIMENSIONS							
<table border="1"> <tr> <td>inch</td> </tr> <tr> <td>millimeter</td> </tr> </table>						inch	millimeter
inch							
millimeter							
Gage Length	Overall Length	Grid Width	Overall Width	Matrix Length	Matrix Width		
0.020	0.231	0.047	0.111	0.25	0.13		
0.51	5.87	1.19	2.82	6.4	3.2		

* Only creep code available for this gage.
Copper plating for tabs is available.

Advanced Sensors

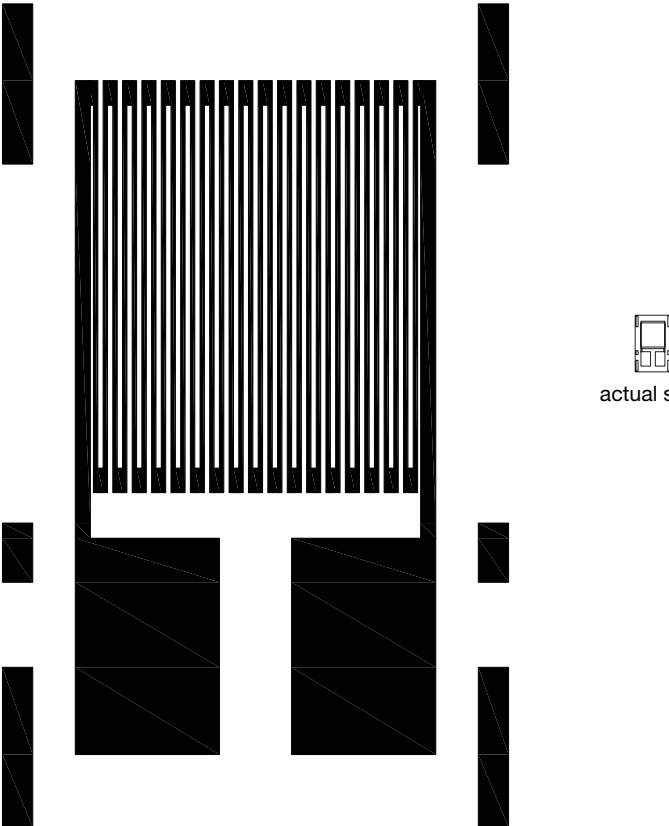
LT02 RESISTOR PATTERN DATA																													
	<table border="1"> <thead> <tr> <th>GAGE DESIGNATION</th> <th>RESISTANCE IN OHMS</th> </tr> </thead> <tbody> <tr><td>N2T-TR-LT02-00100/E3</td><td>10</td></tr> <tr><td>N2T-TR-LT02-00125/E3</td><td>12.5</td></tr> <tr><td>N2T-TR-LT02-00150/E3</td><td>15</td></tr> <tr><td>N2T-TR-LT02-00200/E3</td><td>20</td></tr> <tr><td>N2T-TR-LT02-00225/E3</td><td>22.5</td></tr> <tr><td>N2T-TR-LT02-00300/E3</td><td>30</td></tr> <tr><td>N2T-TR-LT02-00400/E3</td><td>40</td></tr> <tr><td>N2T-TR-LT02-00450/E3</td><td>45</td></tr> <tr><td>N2T-TR-LT02-00500/E3</td><td>50</td></tr> <tr><td>N2T-TR-LT02-00600/E3</td><td>60</td></tr> <tr><td>N2T-TR-LT02-00720/E3</td><td>72</td></tr> <tr><td>N2T-TR-LT02-00800/E3</td><td>80</td></tr> <tr><td>N2T-TR-LT02-00900/E3</td><td>90</td></tr> </tbody> </table>	GAGE DESIGNATION	RESISTANCE IN OHMS	N2T-TR-LT02-00100/E3	10	N2T-TR-LT02-00125/E3	12.5	N2T-TR-LT02-00150/E3	15	N2T-TR-LT02-00200/E3	20	N2T-TR-LT02-00225/E3	22.5	N2T-TR-LT02-00300/E3	30	N2T-TR-LT02-00400/E3	40	N2T-TR-LT02-00450/E3	45	N2T-TR-LT02-00500/E3	50	N2T-TR-LT02-00600/E3	60	N2T-TR-LT02-00720/E3	72	N2T-TR-LT02-00800/E3	80	N2T-TR-LT02-00900/E3	90
	GAGE DESIGNATION	RESISTANCE IN OHMS																											
	N2T-TR-LT02-00100/E3	10																											
	N2T-TR-LT02-00125/E3	12.5																											
	N2T-TR-LT02-00150/E3	15																											
	N2T-TR-LT02-00200/E3	20																											
	N2T-TR-LT02-00225/E3	22.5																											
	N2T-TR-LT02-00300/E3	30																											
	N2T-TR-LT02-00400/E3	40																											
	N2T-TR-LT02-00450/E3	45																											
	N2T-TR-LT02-00500/E3	50																											
	N2T-TR-LT02-00600/E3	60																											
	N2T-TR-LT02-00720/E3	72																											
N2T-TR-LT02-00800/E3	80																												
N2T-TR-LT02-00900/E3	90																												
<p>DESCRIPTION</p> <p>Fixed resistors are available in several standard resistance values as shown.</p> <p>Other values up to 150Ω can be made available upon request.</p> <p>RoHS-compliant.</p>																													

GAGE DIMENSIONS							
					<table border="1"> <tr><td>inch</td></tr> <tr><td>millimeter</td></tr> </table>	inch	millimeter
inch							
millimeter							
Gage Length	Overall Length	Grid Width	Overall Width	Matrix Length	Matrix Width		
0.125	0.233	0.125	0.125	0.29	0.18		
3.18	5.92	3.18	3.18	7.5	4.7		

Advanced Sensors

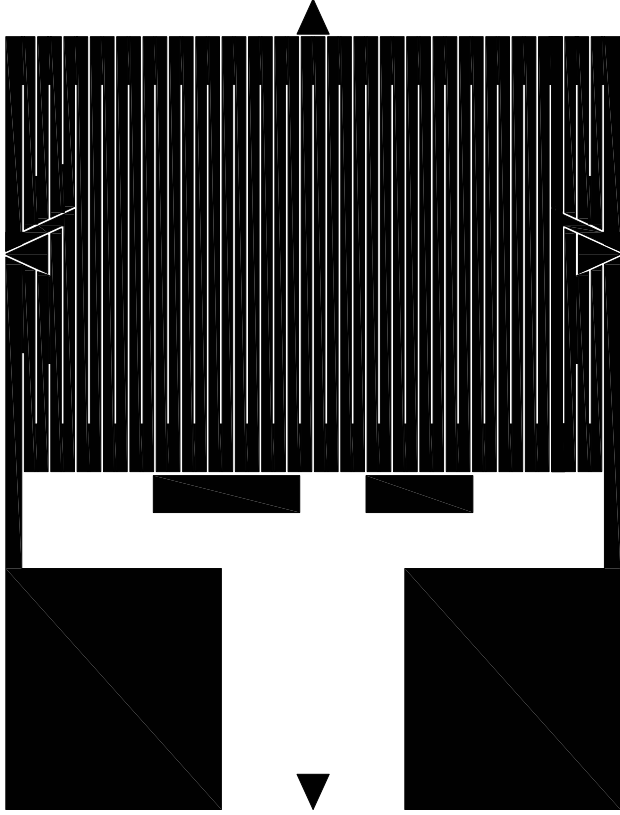
LT10 RESISTOR PATTERN DATA		
 <p style="text-align: center;">actual size</p>	GAGE DESIGNATION	RESISTANCE IN OHMS
	N2T-TR-LT10-00100/E3	10
	N2T-TR-LT10-00125/E3	12.5
	N2T-TR-LT10-00150/E3	15
	N2T-TR-LT10-00200/E3	20
	N2T-TR-LT10-00225/E3	22.5
	N2T-TR-LT10-00300/E3	30
	N2T-TR-LT10-00400/E3	40
	N2T-TR-LT10-00450/E3	45
	N2T-TR-LT10-00500/E3	50
	N2T-TR-LT10-00600/E3	60
	N2T-TR-LT10-00720/E3	72
	N2T-TR-LT10-00800/E3	80
N2T-TR-LT10-00900/E3	90	
<p>DESCRIPTION</p> <p>Fixed resistors are available in several standard resistance values as shown.</p> <p>Other values up to 150Ω can be made available upon request.</p> <p>RoHS-compliant.</p>		

GAGE DIMENSIONS					
					inch
					millimeter
Gage Length	Overall Length	Grid Width	Overall Width	Matrix Length	Matrix Width
0.031	0.083	0.069	0.069	0.09	0.07
0.79	2.11	1.75	1.75	2.5	1.9

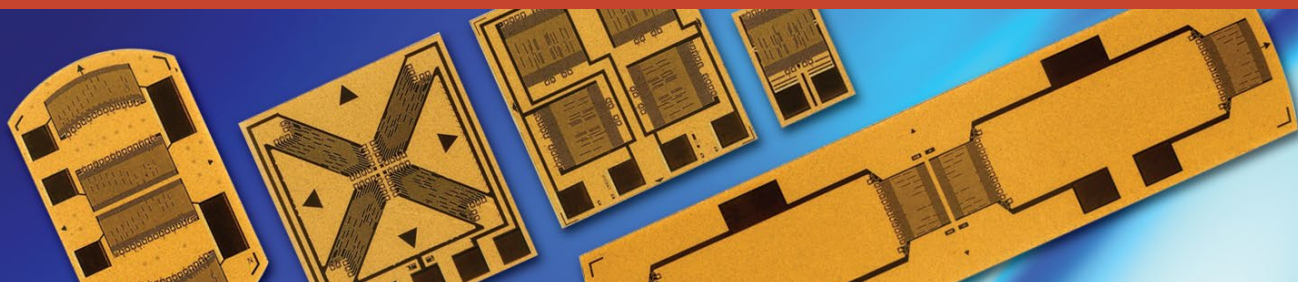

Contact

mm@vpgsensors.com

micro-measurements.com