

Multi-Zone Web Tension Transmitter

FEATURES

- Individually digitized transducer forces for 4 web tension transducers (1, 2, or 4 zone configuration)
- View left, right, and total; force, tension and angle values
- 100% digital calibration – no dead weight loading and no strapping required
- Internal diagnostics significantly reduce downtime
- Dynamic Digital Filtering for each tension zone
- Total, individual, and difference output control signals
- 4 inputs, 8 triac output relays, 8 TTL logic outputs
- Allen-Bradley Remote I/O, ModbusPlus/RTU, DeviceNet, and Profibus interface



HTU MODE FEATURES

- Visual display of horizontal and vertical web balance
- Auto-wrap maintains constant tension control as roll diameter increases
- Measure resultant force (F_r) and angle of inclination for any or all wrap angles

APPLICATIONS

- Pulp and paper machinery
- Roofing machines
- Converting equipment
- Mining conveyors
- Winders, rewinders, laminators, coaters, dryers, felts

DESCRIPTION

LCt-104 Tension Transmitters measure up to four independent web points, or zones, to ensure maximum operating speeds without belt, felt, or product breakage. Each zone is precisely measured with 750,000 count



resolution and produces a corresponding, high resolution, 4–20 mA output. Total, individual, and differential outputs from two HTU transducers permit a comparison of tension signals on either side of a sheet, strip, or web.

Digital calibration eliminates time consuming dead weight loading and machine “strapping”.

With four integral operating modes, LCt-104 transmitters offer wide operating flexibility and easy installation. Simply select the mode that matches your application, enter the transducer zero and span values, and begin system operation.

When combined with HTU transducers, units measure both horizontal and vertical tension vectors. Based upon both measurements, software algorithms calculate the precise, resultant force vector and exact linear tension component. Auto-wrapping maintains smooth, constant tension for winding zones as the roll diameters increase or decrease.

CONFIGURATION

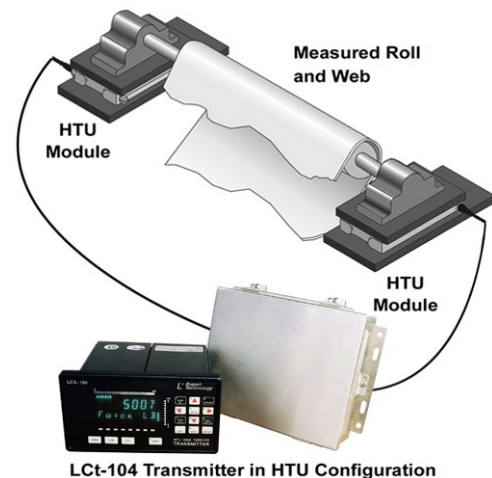
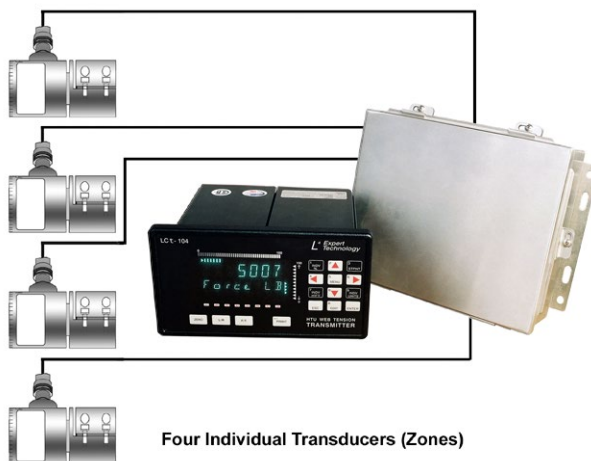

Multi-Zone Web Tension Transmitter

LCT-104 OPERATING MODES*

Mode “A” – High Resolution for Large Pillow Block Systems

Ultra-high resolution is achieved by mounting two transducers in line with a single pillow block bearing on each side of a roll. Data from both transducers on each side is summed, resulting in precision work and drive signals. This is the ideal configuration for FMU measurement units. Resultant tension outputs = Total (sum of all transducers), Drive (two left side), Work (two right side), and difference (Drive minus Work). Sum and difference analog outputs available.

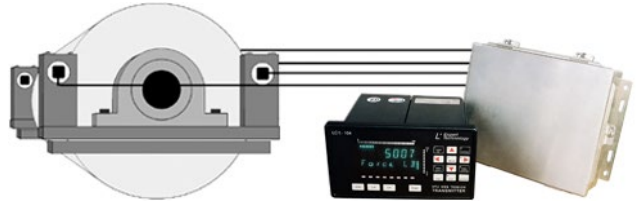

Mode “B” – Two Tension Zones (typically 2 rolls) with Dual Analog Outputs

Mode B usually measures two independent tension zones (rolls), each with dead shaft idler roll transducers (4 transducers total). These zones may be two independent points on the same web or any point on two different webs. Mode B analog outputs are roll 1 (transducers 1 and 2) total tension, roll 1 difference, roll two total (transducers 3 and 4), and roll two difference. Mode B also functions with only one, two-transducer tension zone. It is not necessary to use both zones.

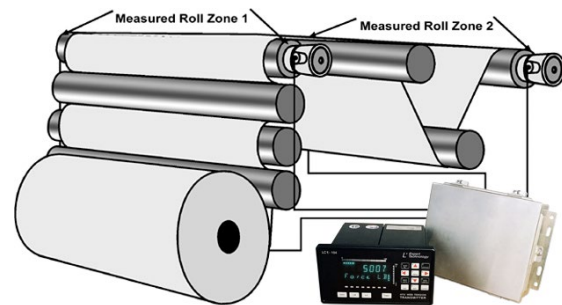

Mode “C” – Four Independent Narrow Web Tension Transducers

Mode C usually is used in conjunction with four separate and independent “cantilevered” type tension transducers used for narrow web, filament, and other continuous process applications. Cantilevered transducers are typically not used in pairs. They attach in-line to a pulley or small roll (not over 12 inches). With this configuration, measurements can be taken from four zones on a single machine, a single zone on four machines, etc. With Mode C configuration, each transducer has a total tension analog output.

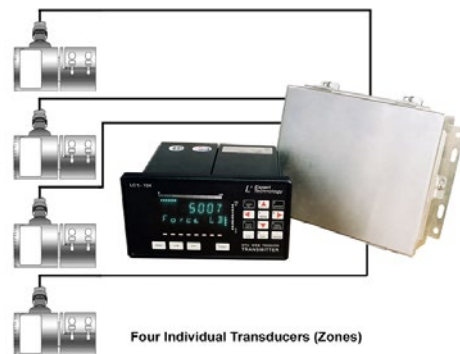

HTU Transducer Mode – Measure Resultant Force and Inclination Angle

HTU Web Tension Transducers combined with LCT-104 transmitters produce the ultimate in web tension accuracy. HTU transducers supply both horizontal and vertical tension force signals which are resolved by the LCT-104 into the precise resultant tension force and the exact inclination angle. Measurement remains consistent, even if wrap angles change dramatically during the production run. Analog outputs track total force or tension.

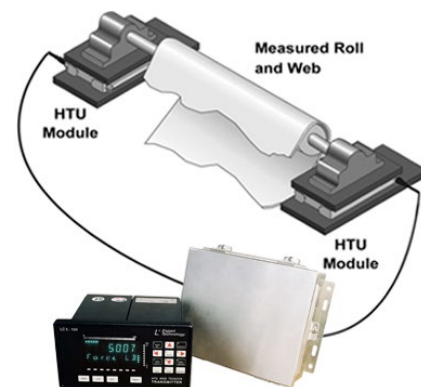

*In all modes, inputs can be turned on or off, or data can be complemented.

Multi-Zone Web Tension Transmitter

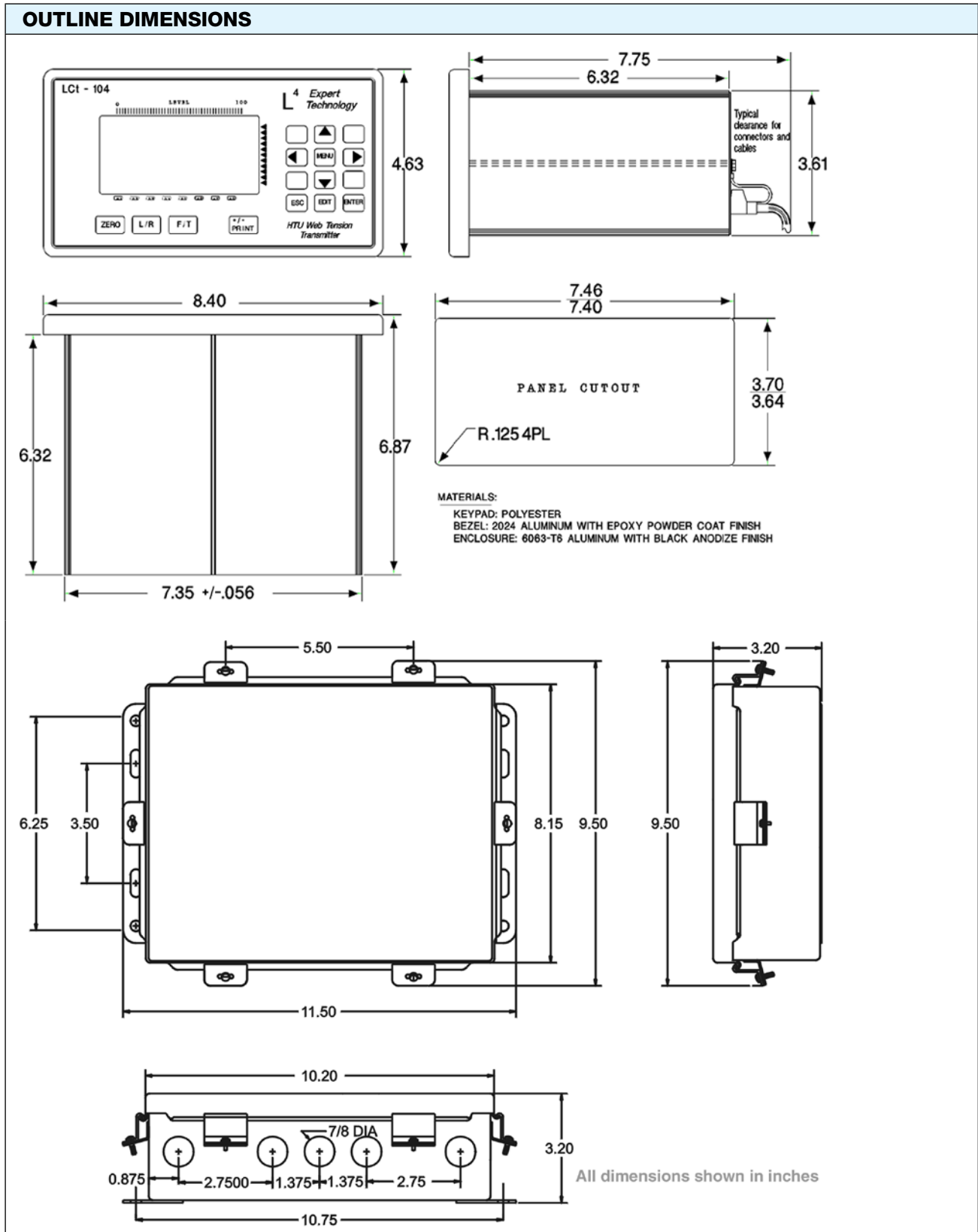

Multi-Zone Web Tension Transmitter

SPECIFICATIONS		PARAMETER	VALUE
PERFORMANCE		DC SETPOINT OUTPUTS – 8 (OPTIONAL) CONTD.	
Internal Resolution	4,194,304 total counts	OFF State Leakage	0.04 µA @ 40 VDC
Max. Display Resolution	3,000,000 total counts	Power	External supply required
Max. Res. Per Channel	750,000 counts	AC SETPOINT OUTPUTS – 8 (OPTIONAL)	
Conversion Speed	Selectable 7.5, 15, 30, and 60 conversions per second	Type	Triac
Sensitivity (Noise)	0.1 µV/count @ 30 updates/sec (max ±16 counts w/o filter)	Operating Voltage	12–240 VAC
Full Scale Range	±35 mV/channel	AC Frequency	20–500 Hz
Dead Load Range	100%	ON State Voltage Drop	1.2 V _{RMS}
Input Impedance	10 MΩ, min. per channel	Min–Max Load Current	5 mA–1 A
Load Cell Excitation	10 V (65 mA/channel max)	Leakage Current	1 mA @ full rated load voltage
Remote Sense	User configurable, each channel	Power	External supply required
Linearity	±0.0015% of full scale	DIGITAL INPUTS	
Calibration Repeatability	0.3 µV per count	Logic"0" (Low)	Less than 0.5 VDC, sink 3 mA (min)
TEMPERATURE COEFFICIENT		Logic"1" (High)	10 to 28 VDC (TTL open collector)
Span/Zero	±2 ppm/°C	Mechanical Relay"0"	Closed (one side = digital common, the other side = input)
ENVIRONMENT		Mechanical Relay"1"	Open (input internally pulled up)
Operating Temperature	–10 to 55°C (12 to 131°F)	NETWORK SERIAL COMMUNICATION (STD)	
Storage Temperature	–20 to 85°C (–4 to 185°F)	Type	RS-485 Half Duplex (Multi-Drop)
Humidity	5 to 90% rh, non-condensing	Baud	9,600, 28,800, and 56,700
Voltage (Console)	115/230 ±15% 50/60 Hz	SIMPLEX DATA OUTPUT (STANDARD)	
Voltage (Jbox)	16 VDC	Type	RS-485 (Simplex)
Power	12 watts max	Baud	1,200 or 9,600
DISPLAY/OPERATOR INTERFACE		Data Format (Selectable), ASCII	7 data bits, even parity, stop bit
Type	High intensity amber LED display	TERMINAL / COMPUTER INTERFACE (OPTIONAL)	
Active Digits	7 digit alpha numeric 0.59 in high for weight: 8 digit alphanumeric 0.39 in high for status	Interface Type	RS-485 half duplex (standard)
APPROVALS		Baud	1,200 or 9,600
FM/CSA	C22.2 (Class I, II, III; Div.2; Groups A-G)	Protocol	Duplex command/response format
ISOLATED ANALOG OUTPUT		ASCII	7 data bits, even parity, stop bit
Type	16 bit digital to analog	SPECIAL PROTOCOLS (OPTIONAL)	
Current	4–20 mA (600 ohm max load)	Modbus	RTU Protocol
DC SETPOINT OUTPUTS – 8 (OPTIONAL)		SPECIAL INTERFACE (OPTIONAL)	
Type	Open collector (current sinking)	Allen Bradley	Remote I/O – 1/4 logical rack
Operating Voltage	5–35 VDC	Modbus Plus	Peer-to-peer (with global data)
ON Voltage	12 VDC @ 40 mA 0.8 VDC @ 1 mA	DeviceNet	ODVA specified
		Profibus	Siemens protocol

NOTE: PLC and Allen-Bradley are trademarks of Allen-Bradley Co.,Inc. Modbus is a trademark of Schneider. DeviceNet is a trademark of ODVA Profibus is a trademark of Siemens

BLH Nobel is continually seeking to improve product quality and performance. Specifications may change accordingly.