



BLH

FSk-40
Field Service Kit
Operator's Manual

NOTICE

BLH makes no representation or warranties of any kind whatsoever with respect to the contents hereof and specifically disclaims any implied warranties or merchantability or fitness for any particular purpose. BLH shall not be held liable for errors contained herein or for incidental or consequential damages in connection with the furnishing, performance, or use of this publication or its contents.

BLH reserves the right to revise this manual at any time and to make changes in the contents hereof without obligation to notify any person of such revision or changes.

Call (781) 298-2216 for BLH Field Service

Table of Contents

SECTION 1.	General Information	1-1
1.1	INTRODUCTION.....	1-1
1.1.1	General Description	1-1
1.2	FSK-40 FEATURES	1-1
1.2.1	High Visibility Display	1-1
1.2.2	Embedded mV/V Calibration.....	1-1
1.2.3	Shim Mode Operation	1-1
1.2.4	Interconnecting Cables	1-1
1.2.5	On-Line Diagnostics	1-1
1.2.6	Dynamic Digital Filter	1-2
1.2.7	The Terminal Computer Interface.....	1-2
1.2.8	Modbus RTU Protocol.....	1-2
1.2.9	Integral 325 Precision Calibrator.....	1-2
1.3	FSK-40 SPECIFICATIONS.....	1-4
1.4	WARRANTY POLICY	1-4
1.5	FIELD ENGINEERING	1-5
SECTION 2.	Installation	2-1
2.1	INTRODUCTION.....	2-1
2.2	ELECTRICAL CONNECTIONS	2-1
2.2.1	Transducer Inputs	2-1
2.2.2	Serial Communication	2-2
2.2.3	Mains (AC) Power	2-2
2.2.4	325 Calibrator Connections.....	2-2
SECTION 3.	Operation.....	3-1
3.1	GENERAL	3-1
3.2	SHIM MODE.....	3-1
3.2.1	Display mV/V	3-1
3.2.2	Display Percent of Load	3-1
3.3	RUN MODE.....	3-1
3.3.1	Gross Weight/Tension Display.....	3-2
3.3.2	Zero Operation	3-3
3.3.3	Net Weight/Tension Display.....	3-3
3.3.4	Tare Operation	3-3
3.3.5	View Individual Cell Data	3-3

3.3.6	Error Detection and Correction	3-4
SECTION 4.	Calibration	4-1
4.1	GENERAL	4-1
4.2	SETUP PARAMETERS	4-1
4.2.1	Calibration Type	4-1
4.2.2	Number of Transducers	4-1
4.2.3	Display Units	4-1
4.2.4	Decimal Point Location	4-1
4.2.5	Capacity	4-1
4.2.6	Count By.....	4-1
4.2.7	Zero Band.....	4-1
4.3	DIGITAL CALIBRATION	4-6
4.3.1	Transducer Calibration Data	4-6
4.3.2	Entering mV/V Calibration Points.....	4-6
4.3.3	Acquire Deadload.....	4-6
4.4	DEADLOAD TYPE CALIBRATION	4-10
4.4.1	Perform Corner Test (Sensitivity Adjust).....	4-10
4.4.2	Acquire Zero.....	4-10
4.4.3	Span Point Entry	4-10
SECTION 5.	On-Line Transducer Diagnostics.....	5-1
5.1	GENERAL	5-1
5.2	DIAGNOSTIC TESTS	5-1
5.2.1	Load Shift	5-5
5.2.2	Zero Shift.....	5-6
5.2.3	Drift Test.....	5-6
5.2.4	Noise Test	5-7
5.2.5	Overload.....	5-8
5.2.6	Recall Values	5-9
5.2.7	Degrade Mode Function.....	5-11
SECTION 6.	Dynamic Digital Filter	6-1
6.1	GENERAL	6-1
6.2	FILTER PARAMETERS	6-1
6.3	DYNAMIC DIGITAL FILTER	6-4
6.3.1	Band Filter	6-4
6.3.2	Noise Band.....	6-4

6.3.3	Response Band.....	6-4
6.3.4	Default Parameters	6-5
6.4	MOTION DETECTION	6-5
SECTION 7.	Serial Communication	7-1
7.1	GENERAL	7-1
7.1.1	LCp-40 Digi System Network.....	7-1
7.1.2	Standard Simplex Output (Continuous Output).....	7-1
7.1.3	Computer/Terminal Interface.....	7-1
7.1.4	MODBUS Protocol	7-6

SECTION 1. General Information

1.1 INTRODUCTION

1.1.1 General Description

The FSk-40 is a portable field service kit designed for starting-up or troubleshooting process weighing, inventory weighing, and web tension measurement systems. The kit (Figure 1-1) consists of an FSk-40 instrument with a multi-line display panel, removable 325 precision calibrator, 4 quick-connect load cell cables, and a serial communication module. Use the FSk to set-up/check/troubleshoot transducer installation and the 325 calibrator to calibrate/verify system instrumentation. All components are packaged in a rugged, portable, suitcase with shock mounting.

In function, the FSk-40 operates in one of two modes. In shim mode, the multi-line display panel shows the percent of load/tension carried by each system transducer. This mode quickly identifies out-of balance or transducer overload conditions. In run mode, the unit performs as a system indicator/transmitter, displaying and transmitting live weight/tension measurements while performing background filtering and diagnostic operations. Calibration and configuration of all parameters is performed easily using the flow diagram presented in Figure 1-2.

1.2 FSk-40 FEATURES

Standard FSk-40 units provide four A/D converter channels, 10 volt excitation per channel, digital calibration, digital filtering, on-line diagnostic testing, and an RS 485 serial port with a terminal computer interface.

1.2.1 High Visibility Display

The FSk-40 multi-line display panel uses high visibility vacuum fluorescent segments to display all four transducer channels simultaneously. Transducer channels not selected are not displayed to avoid confusion.

1.2.2 Embedded mV/V Calibration

This calibration method uses a factory calibration curve embedded in firmware to establish a reference between weight (force) and mV/V. This allows an operator to set-up and calibrate a weigh system without the need for deadweights or other time consuming calibration methods. For systems with mechanical interactions, this calibration method can be modified to correct for system non-linearities.

1.2.3 Shim Mode Operation

In shim mode, the multi-line display panel shows the percent of load/tension or the actual mV/V signal output of each transducer. This mode quickly identifies out-of-balance or transducer overload conditions.



Figure 1-1. Field Service Kit Components.

1.2.4 Interconnecting Cables

FSk-40 Kits provide four quick-connect load cell cables, and a serial communication module/cable. All cables plug directly into the display panel module. The serial communication cable also serves as an RS-486 to RS-232 protocol converter. See SECTION II

1.2.5 On-Line Diagnostics

Weigh system diagnostics can be communicated from the FSk-40 serial port to a host computer. This real time information regarding system performance enables the host process computer to notify an operator and/or re-configure the system to go into degraded mode operation.

1.2.6 Dynamic Digital Filter

The dynamic digital filter uses statistical characterization of process noise to derive optimum filtering settings. Once the noise is characterized, the operator selects the combination of averaging and filter cutoff bands needed to maintain both display stability and fast response time.

1.2.7 The Terminal Computer Interface

The terminal/computer interface provides a simple mnemonic half-duplex ASCII communications protocol via a built-in macro language consisting of 1 to 3 character command strings (reference Table 7-3).

This powerful feature allows direct keyboard control (using easily remembered commands) of FSk-40 operation and recall of weight values (gross, net, tare, zero, balance, etc.) Easily learned macro language syntax greatly simplifies the writing of a host computer communication interface (customer supplied).

1.2.8 Modbus RTU Protocol

Modbus is often recognized as an industry standard method of digital communication protocol between a master or host computer and a slave device. This protocol was originally developed by Modicon to communicate discrete and analog information between PLCs. As implemented in the FSk-40, this protocol efficiently communicates weight and diagnostics information to a Modbus driver equipped host.

1.2.9 Integral 325 Precision Calibrator

Each kit includes a Model 325 Precision Calibrator for testing system instrumentation. While the FSk is used to check the transducers and mechanical system, the 325 calibrates or verifies the instrumentation portion of the system for overall integrity. See manual TM026 for 325 functions and operation.

FSk-40 Main Menu Flow Diagram (Run Mode)

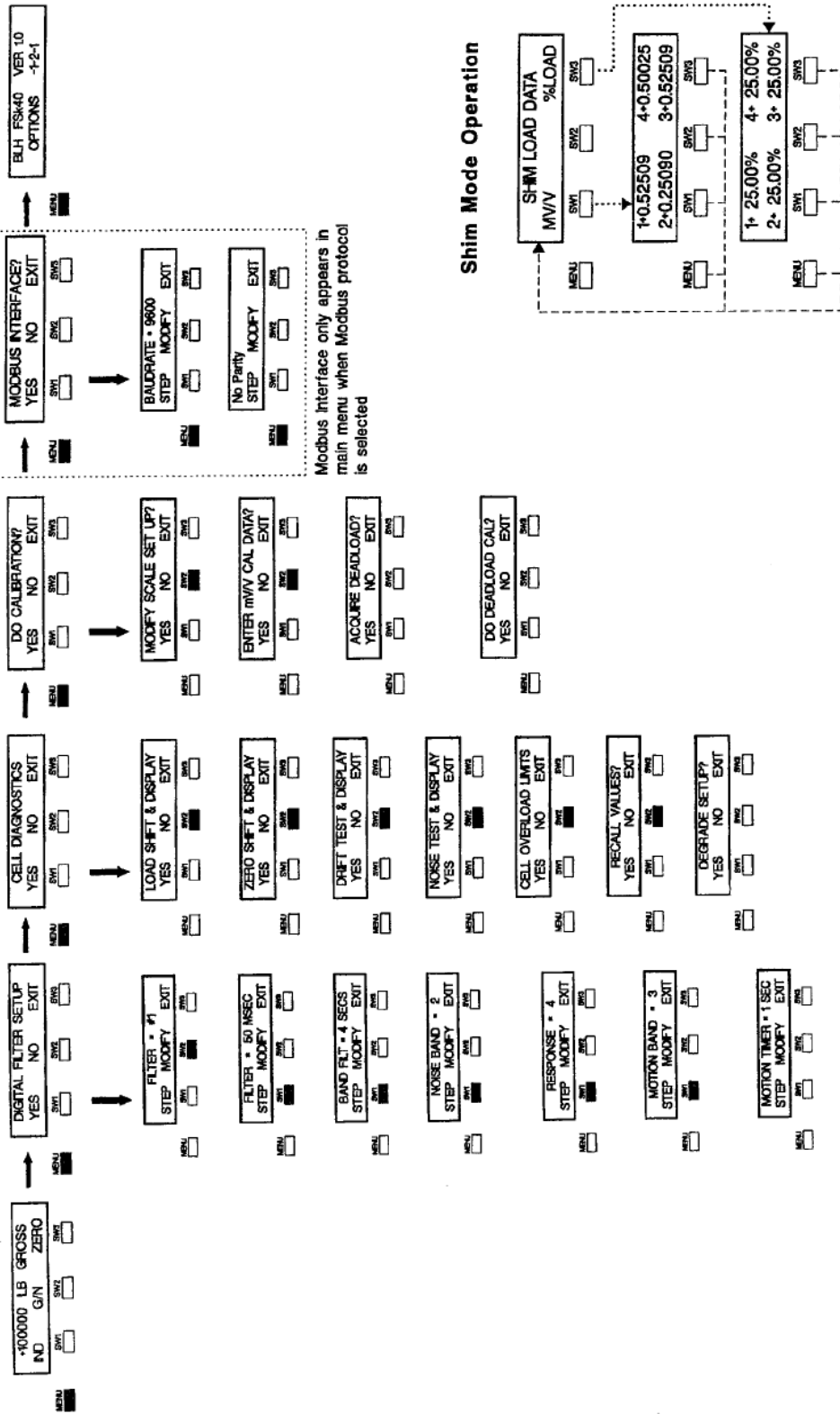

Shim Mode Operation

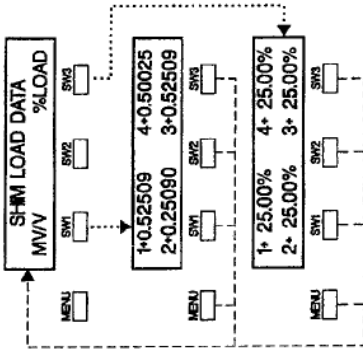

Figure 1-2. FSk-40 Calibration and Configuration.

1.3 FSK-40 SPECIFICATIONS

Performance

Internal Resolution	4,194,304 total counts
Max. Display Resolution	3,000,000 total counts
Max. Resolution per Channel	750,000 counts
Conversion Speed	50 msec (20 updates/sec)
Sensitivity (Noise)	0.0011% full scale (max ±16 counts w/o fitter)
Full Scale Range	35 mV/channel
Dead Load Range	100%
Input Impedance	10 M-ohms, min. per channel
Load Cell Excitation	10 V 2 x 350 ohm load cells, 65 mA/channel max
Remote Sense	user configurable on each channel
Linearity	± 0.0015% of full scale
Calibration Repeatability	0.3 µV per count
Software Filter (Std.)	50 to 6400 msec
Dynamic Digital Filter (Opt.)	multi-variable up to 64 seconds

Temperature Coefficient

Span/Zero	±2ppm/°C
Step Response	one conversion
Common Mode Rej.	100 dB @60 Hz
Normal Mode Rej.	100 dB above 35 Hz

Environment

Operating Temperature	-10 to 55°C (12 to 131°F)
Storage Temperature	-20 to 85°C (-4 to 185°F)
Humidity	5 to 90% rh, non-condensing
Voltage	1171230 ± 15% 50/60 Hz
Power	12 watts max
Parameter Storage	EEPROM
EMI/RFI	Shielded from typical industrial interference

Cable Lengths

Load cell Quick Connect	4 cables, 10 feet each
325 Calibrator Cable	1 cable, 10 feet
Serial Communication	1 cable, 6 feet

Enclosure

Dimensions	see outline dimensions - Figure 2-1
------------	--

Internal Display/Operator Interface

High-Contrast	2 columns 01 20
Vacuum Fluorescent	characters each
Interface	4 'soft buttons'
Rotary Switch	transducer selector switch
Reset	restart FSK-40 unit

BLH Digi-System Network

Type	RS-485* Half Duplex (Multi-Drop)
Baud	9.6K, 28.8K, and 56.7k
Data Format	proprietary

Standard Simplex Data Output (Transmit Only)

Type	RS-485* (Simplex)
Baud	1200 or 9600
	Data Format (Selectable)
ASCII	7 data bits even parity stop bit

Terminal/Computer Interface

Interface Type	RS 485* Half Duplex (Standard)
Baud	1200 or 9600
Protocol	Duplex Command/Response
Format	
ASCII	7 data bits even parity stop bit

Weight

Complete Case	Approx. 19 lb.
---------------	----------------

Calibration

	Indicator	Calibrator
Recalibration Interval	1 Year	1 Year
Stability	0.005% FS/year	
	0.02%/range/year	

*BLH supplied serial communication cable converts RS-485 to standard RS-232

Model 325 Calibrator

Output Accuracy	0.02% of selected range
Accuracy Stability	less than 0.01% in 24 hours
Zero Stability	less than 3 µV
Input Impedance (Excitation)	adjustable to ±0.05%
Output Impedance (Signal)	adjustable to ±0.08%
Output Ranges	8 steps: 0, 0.5, 1.0, 1.5, 2.0, 2.5, 3.0, and 3.5 mV/V
Input Voltage Level	25 VDC maximum
Operating Temperature	32 to 120°F (0 to 50°C)
Vernier Range	up to 106% of selected step
Impedance Adjustment	350, 700, or 1000 ohms
Dimensions (inches)	6 x 3.2 x 1 inches (LWH)
Unit Weight	15.7 ounces

1.4 WARRANTY POLICY

BLH warrants the products covered hereby to be free from defects in material and workmanship. BLH's liability under this guarantee shall be limited to repairing or furnishing parts to replace, f.o.b. point of manufacture, any parts which, within three (3) years from date of shipment of said product(s) from BLH's plant, fail because of defective workmanship or material performed or furnished by BLH. As a condition hereof, such defects must be brought to BLH's attention for verification when first discovered, and the material or parts alleged to be defective shall be returned to BLH if requested. BLH shall not be liable for transportation or installation charges, for expenses of Buyer for repairs or replacements or for any damages from delay or loss of use for other indirect or consequential damages of any kind. BLH may use improved

designs of the parts to be replaced. This guarantee shall not apply to any material which shall have been repaired or altered outside of BLH's plant in any way, so as in BLH's judgment, to affect its strength, performance, or reliability, or to any defect due in any part to misuse, negligence, accident or any cause other than normal and reasonable use, nor shall it apply beyond their normal span of life to any materials whose normal span of life is shorter than the applicable period stated herein. In consideration of the forgoing guarantees, all implied warranties are waived by the Buyer, BLH does not guarantee quality of material or parts specified or furnished by Buyer, or by other parties designated by buyer, if not manufactured by BLH. If any modifications or repairs are made to this equipment without prior factory approval, the above warranty can become null and void.

1.5 FIELD ENGINEERING

Improper FSk-40 installation or usage may result in system damage. Please follow instructions carefully. BLH will not accept any liability for faulty installation and/or misuse of this product. Authorized BLH Field Service Engineers are available around the world to install FSk-40 transmitters and/or train factory personnel to do so. The field service department at BLH is the most important tool to assure the best performance from your application. Field service phone numbers are listed below.

**Call (Factory Number)
(781) 298-2200
Ask for Field Service**

**In Canada, Call
(416) 251-2554
or
(800) 567-6098 Toll Free**

SECTION 2. Installation

2.1 INTRODUCTION

The SFx-40 is a portable kit and requires no mechanical installation instructions. Figure 2-1 provides case outline dimensions for reference

and storage considerations. This chapter will focus primarily on pre-operational electrical connections. NOTE: Do NOT use the FSk-40 kit in a classified hazardous area.

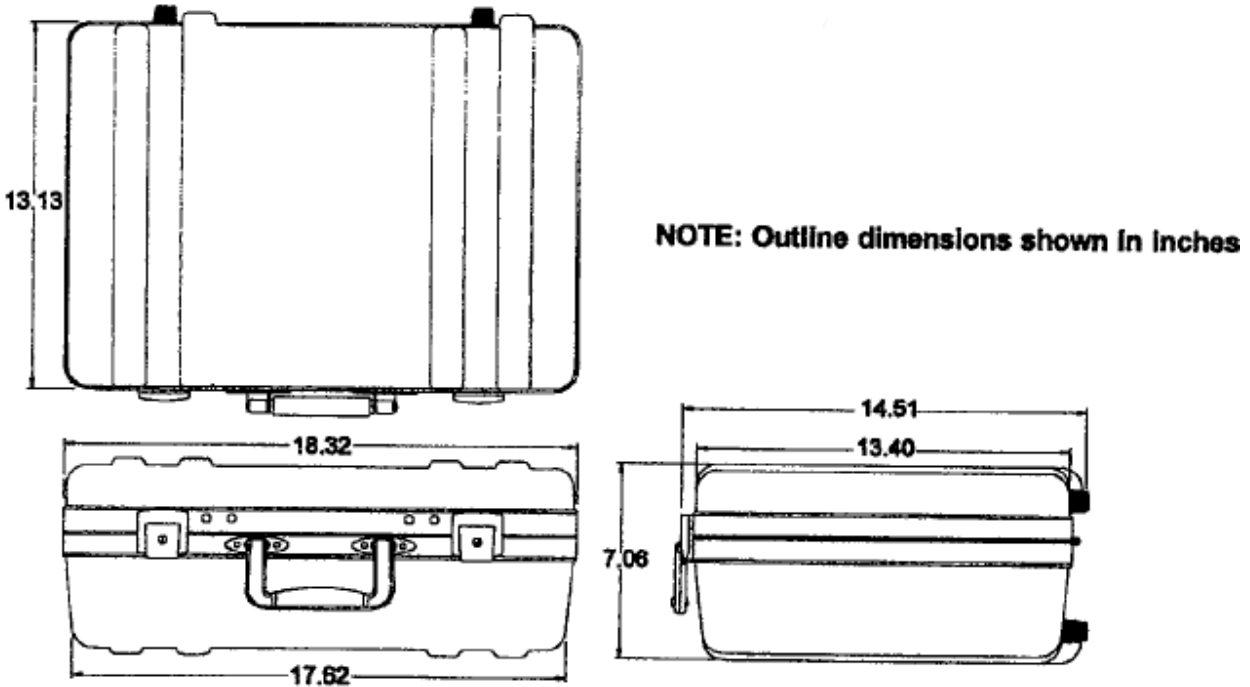

Figure 2-1. FSk-40 Carrying Case Outline Dimensions

2.2 ELECTRICAL CONNECTIONS

2.2.1 Transducer Inputs

Quickly connect load cells/tension transducers to the FSk display unit as follows:

- (1) Select the number of system transducers using the display panel rotary switch (Figure 2-2).

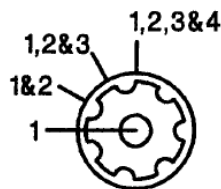

Figure 2-2. Transducer Selection Switch.

- (2) Plug one quick connect cable into the display unit for each system transducer Figure 2-3. Cables are numbered (1-4) for easy reference.

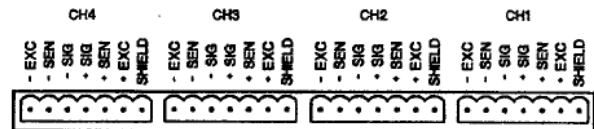

Figure 2-3. FSk-40 Quick Connect Cable Ports.

- (3) Connect the tinned transducer leads to the quick connect cable by pressing the spring loaded but-tons (Figure 2-4) and inserting leads. Consult transducer manual for correct lead designations.

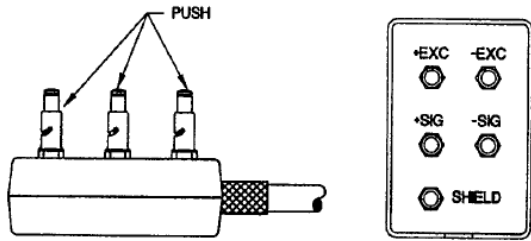

Figure 2-4. Transducer Lead Connection.

(4) Press red RESET button to re-initialize the display

NOTE: When tension or universal type load cells are used, it may be necessary to reverse the polarity of the signal leads to obtain a positive signal input to the FSk.

2.2.2 Serial Communication

An interconnect cable is provided for serial communication. The cable also serves as an RS-485/RS-232 protocol converter. Connect the two plastic terminators to the FSk-40 display unit

and the 25 pin "D" connector to a printer, PLC, PC, or DCS RS-232 port as shown in Figure 2-5.

RS232* D Connector Pin-Outs	
Pin	Function
2	TO
3	RD
7	Common

2.2.3 Mains (AC) Power

Units are shipped pre-configured for 117 VAC operation, just plug in the power cord. For 220 VAC operation, consult factory.

Do not use the FSk-40 kit in classified/hazardous areas.

2.2.4 325 Calibrator Connections

A single, 6-foot long cable is provided for connecting the 325 calibrator to system instrumentation (junction box, indicator, transmitter, etc.). Refer to Model 325Calibrator Operator's Manual, TM026, for complete installation instructions.

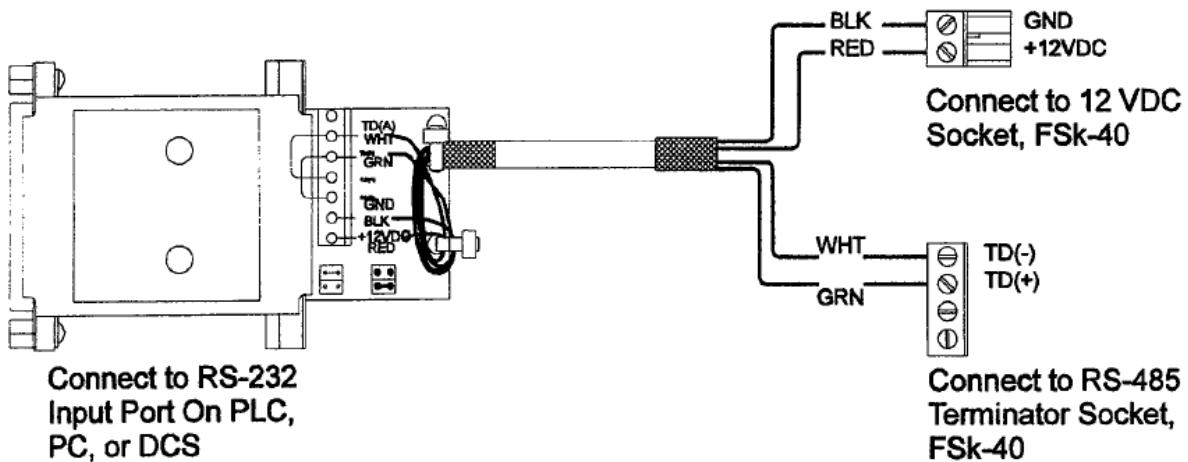

Figure 2-5. Serial Communication Cable Connections.

SECTION 3. Operation

3.1 GENERAL

NOTE: Before power up, select the number of system transducers using the display panel rotary switch (Figure 2-2). Selection changes after power-up will be ignored unless the reset button is pressed. The FSk-40 is pre-calibrated for immediate use in Shim Mode. Calibration (SECTION IV) should be performed before using Run Mode.

FSk-40 display units power up in either Shim or Run Mode, depending upon the mode selection switch (Figure 3-1). In Shim Mode, the display awaits selection of mV/V values (SW1) or percent values (SW3). In Run Mode, if no system errors are detected, the display shows the system gross weight/tension value. Both modes of FSk operation will be discussed in this chapter.

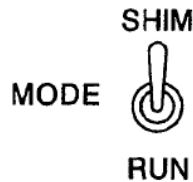

Figure 3-1. Display Panel Mode Selection Switch

3.2 SHIM MODE

Shim Mode is the primary mode of FSk-40 operation. In Shim Mode, the multi-display display panel shows the percent of load/tension or mV/V signal carried by each system transducer. This mode quickly identifies out-of-balance conditions and mechanical restriction problems. Shim Mode operation is presented in Figure 3-2.

3.2.1 Display mV/V

Millivolt-per-volt display shows live signals for each system transducer. Use this mode to observe transducer signal reactions to weight/tension application.

3.2.2 Display Percent of Load

This display shows the percent of total system weight/tension being carried by each transducer. This mode is useful for initial system balancing.

NOTE: Pre-Calibration is not required for Shim Mode operation.

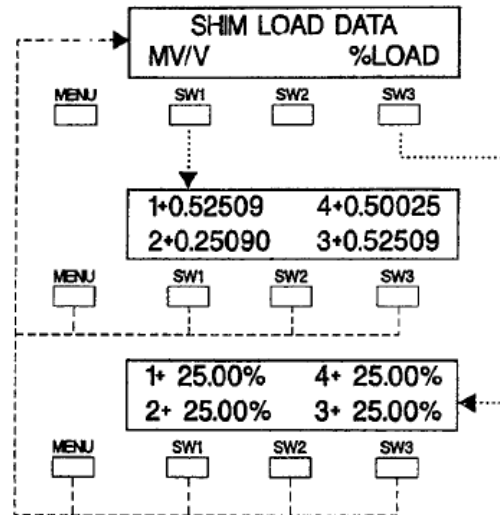

Figure 3-2. Shim Mode Flow Diagram.

3.3 RUN MODE

Run Mode typically is used only when system problems cannot be resolved in Shim Mode. Run Mode requires pre-operational set-up procedures including calibration and filter parameter selections. This mode provides extensive diagnostic test capability and serial communication with a host PC, PLC or DCS device.

Figure 3-3 (next page) presents the display panel button functions for Run Mode. Button 2 toggles operation from gross to net or net to gross display. Button 3 performs push to zero (gross mode) or tare (net mode). Use button 1 to view individual transducer data. If the FSk-40 is connected to a host terminal, computer, or PLC, gross, net, zero, and tare functions can be performed remotely.

3.3.1 Gross Weight/Tension Display

In the gross mode, all of the live weight/tension of the system is transmitted. Live weight does

not include the dead weight of a vessel or other mechanical equipment that is factored out during calibration.

FSk-40 Run Mode Switch Selections

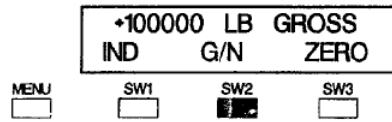

Live Weight Display, Gross Mode

MENU MENU ... Choose Main Menu - Figure 4-1
 SW1 IND ... Display Individual Load Cells
 SW2 NET ... Switch To Net Mode
 SW3 ZERO ... Push To Zero (no display if out of zero band range; MOTION if in motion)

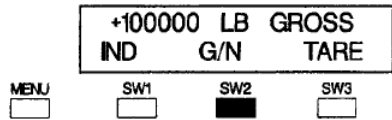

Live Weight Display, Net Mode

MENU MENU ... Choose Main Menu - Figure 4-1
 SW1 IND ... Display Individual Load Cells
 SW2 GROSS ... Switch To Gross Mode
 SW3 TARE ... Tare Net Weight (MOTION if in motion)

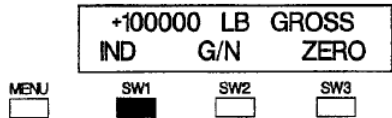

Look At Individual Cell Data

MENU MENU ... Choose Main Menu - Figure 4-1
 SW1 IND ... Display Individual Load Cells

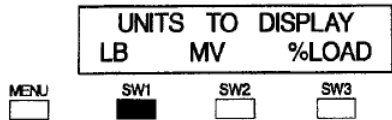

Select Load Cell Display Units

MENU MENU ... Go Back To Previous Display
 SW1 LB ... Display Weight Units
 SW2 MV ... Display Millivolt Signal
 SW3 %LOAD ... Display % Of Load Upon Cell

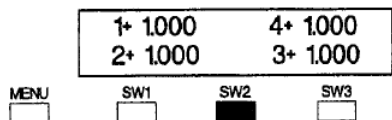

Individual Cell Display In Weight Units

MENU ... Units To Display
 SW1 ... Exit
 SW2 ... Millivolts
 SW3 ... Show % Of Load

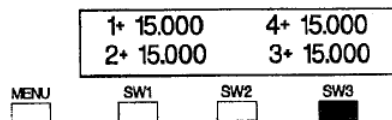

Individual Cell Display In Millivolts

MENU ... Units to display
 SW1 ... Units
 SW2 ... Exit
 SW3 ... Show % Of Load

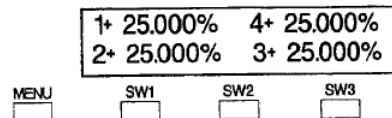

Individual Cell Display In % Of Load

MENU ... Units To Display
 SW1 ... Units
 SW2 ... Millivolts
 SW3 ... Exit

■ - Switch Pressed

Figure 3-3. Switch Functions in the Operating Mode.

Error Condition Encountered

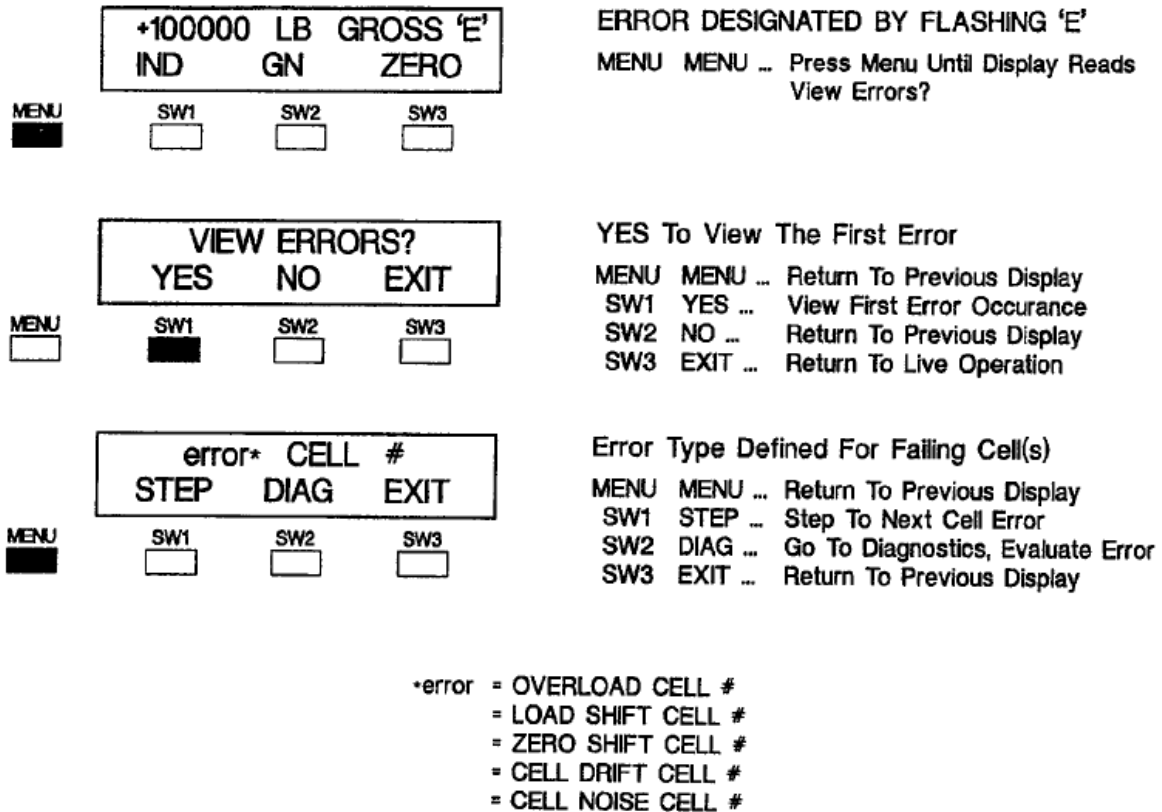

Figure 3-4. Error Detection & Correction Switch Selections.

3.3.2 Zero Operation

A new zero can be acquired to compensate for changes in the dead load of the system due to residual build-up etc. Acquiring a new zero reference value does not affect the slope of the calibration. The zero function in the FSk-40 can be configured for OFF, 2%, 20%, or 100% of system capacity (see Setup Parameters in SECTION III Calibration). Zero may be acquired only if the system is not in motion and the zero band limit has not been exceeded (when ZERO is visible on the display).

3.3.3 Net Weight/Tension Display

Net weight/tension measurement is used when the operator wants to reset zero to compensate for the addition of live weight, a container, or a known constant tension value before adding a

specific amount of material. Tare is used to establish a zero reference in net mode.

3.3.4 Tare Operation

With the FSk-40 in net weighing mode, the tare operation resets the output to zero. Taring allows the operator to achieve a new zero reference before addition of each ingredient in a batch process so that errors do not become cumulative.

3.3.5 View Individual Cell Data

Pressing button 1 'IND' (Figure 3-2) allows the operator to view individual transducer parameters in weight units, millivolt, or percent of total load. Note that Run Mode processing

(including serial data transactions) continues during individual transducer displays.

3.3.6 Error Detection and Correction

Should an error condition occur during Run Mode operation, a flashing capital 'E' will appear next to the weight/status information on the display (Figure 3-3). If the system is overloaded, (total or individual transducer capacity

exceeded) the word 'OVER' also will appear flashing beneath the flashing 'E'. Errors other than overload fall into 4 categories; load shift, zero shift, cell drift, and cell noise errors. To evaluate and correct system errors, enter the diagnostic mode as shown in Figure 3-3 and proceed to SECTION 6 (Transducer Diagnostics).

SECTION 4. Calibration

4.1 GENERAL

Routine troubleshooting is usually accomplished in the Shim Mode by observing mV/V signals or percent of load data (use of Shim Mode does not require calibration). Calibration is only necessary if higher level diagnostic testing is required/desired.

Calibration (Run Mode only) is the fourth step in the FSk-40 parameter entry menu (Figure 4-1). Setup and calibration is accomplished easily using the internal vacuum fluorescent display and its four function buttons.

Complete calibration is accomplished in two phases, scale setup and either millivolt per volt or deadload calibration as shown in Figure 4-2. Use the full calibration flow diagram insert on the following page for guidance throughout the calibration procedure.

4.2 SETUP PARAMETERS

Setup establishes scale operating parameters such as system capacity, decimal point location, display units (pounds, kilograms, tons), total number of transducers, and others. To enter or alter operating parameters, select YES for 'MODIFY SCALE SETUP?' in Figure 4-2 and proceed to Figure 4-3.

4.2.1 Calibration Type

FSk-40 transmitters offer two types of system calibration, digital or deadload. In the past, systems could only be deadload calibrated by placing known quantities of dead weight upon

the scale to establish voltage to weight equivalent points. In the FSk-40, however, since each transducer has its own ND converter, calibration can be accomplished simply by entering known mV/V weight values from a transducer calibration sheet. Choose the calibration type to be performed.

4.2.2 Number of Transducers

Enter the number of system transducers from 1 to 4.

4.2.3 Display Units

Designate the desired display unit type by entering LB (pounds), KG (kilograms), or TN (tons).

4.2.4 Decimal Point Location

Position the decimal point as desired for weight display and serial printouts.

4.2.5 Capacity

Enter the system total capacity value. A capacity of 10,000 will be 10.000, 100.00, 1000.0, or 10,000 relative to decimal point selection.









4.2.6 Count By

Define the count value of each display increment by selecting 1, 2, 5, or 10 (note that decimals apply).

4.2.7 Zero Band

Choose a zero bandwidth (gross weight zero function) of 2%, 20%, or 100% of system capacity. If OFF is selected, the gross weight ZERO function is not available.

Main Menu (Accessed from Operation Mode)

<p>MENU </p>	<p>+100000 LB GROSS ND G/N ZERO</p> <p>SW1 SW2 SW3</p> <p><input type="checkbox"/> <input type="checkbox"/> <input type="checkbox"/></p>	<p>LIVE WEIGHT DISPLAY, GROSS MODE</p> <p>MENU MENU _ Advance To Digital Filter Setup Unless Error</p> <p>SW1 ND ... Display Individual Load Cells</p> <p>SW2 NET ... Switch To Net Mode</p> <p>SW3 ZERO ... Push To Zero</p>
<p>MENU </p>	<p>DIGITAL FILTER SETUP YES NO EXIT</p> <p>SW1 SW2 SW3</p> <p><input type="checkbox"/> <input type="checkbox"/> <input type="checkbox"/></p>	<p>YES to enter/alter Digital Filtering Parameters</p> <p>MENU MENU _ Advance To 'Cell Diagnostics'</p> <p>SW1 YES _ Enter Or Alter Filter Parameters</p> <p>SW2 NO _ Go To Cell Diagnostics</p> <p>SW3 EXIT _ Return To Live Operation</p>
<p>MENU </p>	<p>CELL DIAGNOSTICS YES NO EXIT</p> <p>SW1 SW2 SW3</p> <p><input type="checkbox"/> <input type="checkbox"/> <input type="checkbox"/></p>	<p>CHECK: Load Shift, Zero Shift, Drift, Noise, Raw Data</p> <p>MENU MENU _ Advance To 'Do Calibration'</p> <p>SW1 YES _ Perform Diagnostic Evaluation</p> <p>SW2 NO _ Go To Do Calibration</p> <p>SW3 EXIT _ Return To Live Operation</p>
<p>MENU </p>	<p>DO CALIBRATION? YES NO EXIT</p> <p>SW1 SW2 SW3</p> <p><input type="checkbox"/> <input type="checkbox"/> <input type="checkbox"/></p>	<p>YES to Perform System Calibration</p> <p>MENU MENU _ Return To Live Operation</p> <p>SW1 YES ... Enter Or Alter Calibration Settings</p> <p>SW2 NO ... Return To Live Operation</p> <p>SW3 EXIT _ Return To Live Operation</p>
<p>MENU </p>	<p>ANALOG OUTPUT SETUP? YES NO EXIT</p> <p>SW1 SW2 SW3</p> <p><input type="checkbox"/> <input type="checkbox"/> <input type="checkbox"/></p>	<p>YES To Enter/Alter Analog Output Parameters</p> <p>MENU MENU _ Advance To 'Setpoints?'</p> <p>SW1 YES _ Enter/Alter Analog Output Parameters</p> <p>SW2 NO _ Go To Setpoints?</p> <p>SW3 EXIT ... Return To Live Operation</p>
<p>MENU </p>	<p>SETPOINTS ? YES NO EXIT</p> <p>SW1 SW2 SW3</p> <p><input type="checkbox"/> <input type="checkbox"/> <input type="checkbox"/></p>	<p>YES To Configure Relay Output Functions</p> <p>MENU MENU _ Advance To MODBUS interface?</p> <p>SW1 YES _ Configure Set Point Relay Outputs</p> <p>SW2 NO _ Go To MODBUS interface?</p> <p>SW3 EXIT _ Return To Live Operation</p>
<p>MENU </p>	<p>MODBUS INTERFACE? YES NO EXIT</p> <p>SW1 SW2 SW3</p> <p><input type="checkbox"/> <input type="checkbox"/> <input type="checkbox"/></p>	<p>YES To Configure MODBUS Communication Parameters</p> <p>MENU MENU _ Advance To 'DXP40 Version Information'</p> <p>SW1 YES _ Configure MODBUS Interface</p> <p>SW2 NO _ Go To 'DXP40 Version Information'</p> <p>SW3 EXIT _ Return To Live Operation</p>
<p>MENU </p>	<p>BLH DXP40 VER 10 OPTIONS -1-2-1</p>	<p>View Software Version# and Option Status</p> <p>MENU MENU _ Return To Live Operation</p>

 = Switch Pressed

Figure 4-1. FSk-40 Main Menu Showing Calibration Display.



YES to Perform System Calibration

- MENU MENU .. Return to Live Operation
- SW1 YES .. Enter or Alter Calibration Parameters
- SW2 NO .. Return to Live Operation
- SW3 EXIT .. Return to Live Operation

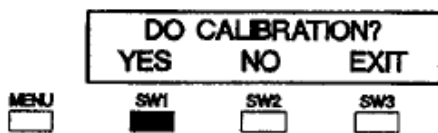
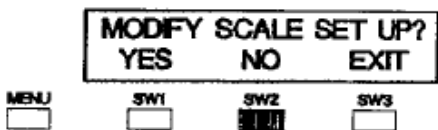

YES To Enter/Alter Capacity, Decimal Point, Country, Zero Band, mV/V or Deadload Cal, # of Cells, Units

- MENU MENU .. Back Up To Previous Display
- SW1 YES .. Enter System Parameters - Figure 3-3
- SW2 NO .. Step To mV/V or Deadload Cal
- SW3 EXIT .. Return To Do Calibration?

If mV/V Type Calibration is Selected (Optional)

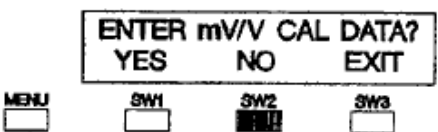

YES To Perform mV/V Calibration

- MENU MENU .. Back Up To Previous Display
- SW1 YES .. Perform mV/V Calibration - Figure 3-5
- SW2 NO .. Step To Acquire Deadload?
- SW3 EXIT .. Return To Do Calibration?

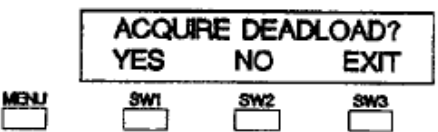

YES To Acquire System Dead Weight Value

- MENU MENU .. Back Up To Previous Display
- SW1 YES .. Acquire Dead Load - Figure 3-6
- SW2 NO .. Return To Do Calibration?
- SW3 EXIT .. Return To Do Calibration?

If Deadload Type Calibration is Selected

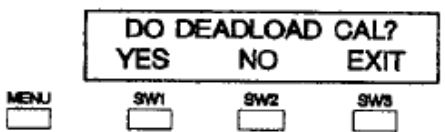

YES to Perform Deadload Type Calibration

- MENU MENU .. Back Up To Previous Display
- SW1 YES .. Perform Deadload Calibration - Figure 3-7
- SW2 NO .. Return To Do Calibration?
- SW3 EXIT .. Return To Do Calibration?

= Switch Pressed

Figure 4-2. FSk-40 Calibration Menu.

Modify Scale Set Up

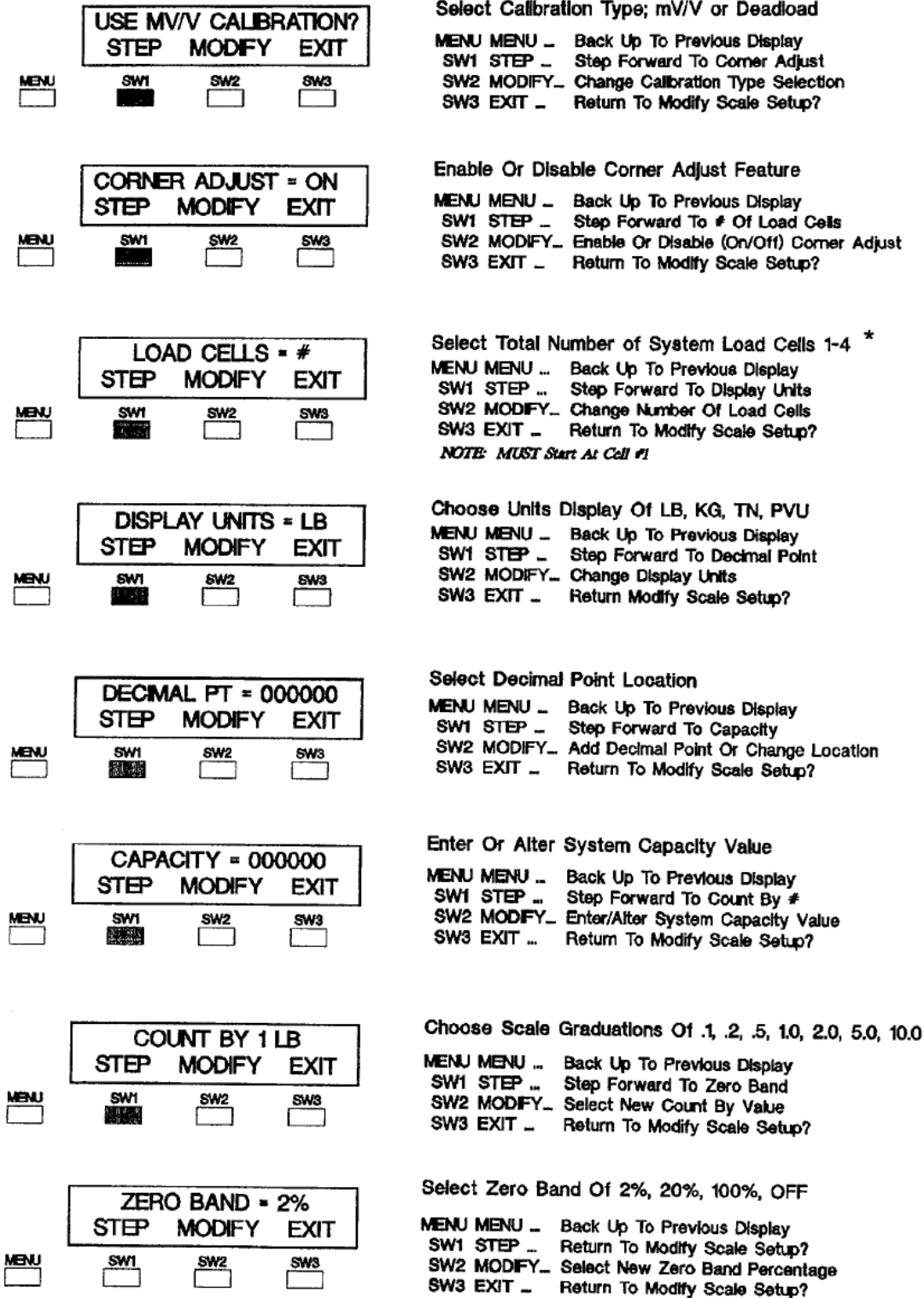

Figure 4-3. System Parameter Entry Flow Diagram.

4.3 DIGITAL CALIBRATION

4.3.1 Transducer Calibration Data

Embedded mV/V calibration technology makes it possible to calibrate the FSk-40 by simply entering mV/V equivalent weight points form a transducer calibration sheet (Figure 4-4). A cal sheet presents the transducer mV/V output reading for either 3 or 10 known weight values. The highest weight value recorded should match the rated capacity of the transducer. Note that there is also a 0 or no load mV/V output recorded. Each transducer must have its own cal sheet (match serial number on sheet to serial number on cell) in order to perform mV/V calibration. If cal sheets are not available, use deadload type calibration.

4.3.2 Entering mV/V Calibration Points

Following Figure 4-5 instructions, select a transducer and enter the zero balance (no load)

mV/V value. After zero balance is established, enter the load point pound and load point mV/V value for each test point on the calibration certificate. Repeat this procedure for each transducer before advancing to 'Acquire Deadload?' (next paragraph). Note that transducers are numbered according to their channel connection position (Figure 2-3).

4.3.3 Acquire Deadload

After all mV/V load points are entered, a scale zero reference must be acquired. Deadload zero determines the weight or signal output at which the scale/system is in no load condition. Addition of any weight/tension will be referenced from this point to produce accurate live force readings. Following Figure 4-6 instructions, acquire the deadload value by either entering a known weight value for all scale/system components (manual) or letting the FSk-40 read and store the no load signal (live). When all cal sheet span points are entered and deadload acquired, mV/V calibration is complete.



Calibration Chart

Customer: ABC Co. P.O : 123456
 Capacity 100,000 lb Type KDH-1A Serial No. 97123
 Mode Compression Bridge A Test Report No. CXX-XXXX
 Date Of Calibration 6/12/1997 Temperature : 70 F
 Calibrated By: M. Houston Humidity : 55 %

Applied Load lbf	Response Run 1 mv/V	Response Run 2 mv/V	Response Run 3 mv/V
0	0.0000	0.0000	0.0000
10,000	0.2000	0.2000	0.2000
20,000	0.4000	0.4000	0.4000
30,000	0.6001	0.6001	0.6000
40,000	0.8001	0.8002	0.8001
50,000	1.0002	1.0001	1.0001
60,000	1.2002	1.2002	1.2001
70,000	1.4002	1.4002	1.4002
80,000	1.6002	1.6002	1.6003
90,000	1.8003	1.8003	1.8004
100,000	2.0003	2.0003	2.0003
50,000	1.0001	1.0002	1.0000
0	0.0000	0.0000	0.0000

John E. Bailey 6/12/97
 Q.C. Manager

Applied Load [lb]	Output Average mv/V	Ideal Output mv/V	Output Error mv/V	Output Error % FS	Hysteresis Error % FS
0	0.0000	0.0000	0.0000	.000%	
10,000	0.2000	0.2000	0.0000	-.001%	
20,000	0.4000	0.4001	-0.0001	-.003%	
30,000	0.6001	0.6001	0.0000	-.001%	
40,000	0.8001	0.8001	0.0000	.001%	
50,000	1.0001	1.0002	0.0000	-.001%	
60,000	1.2002	1.2002	0.0000	-.001%	
70,000	1.4002	1.4002	0.0000	.000%	
80,000	1.6002	1.6002	0.0000	.000%	
90,000	1.8003	1.8003	0.0001	.003%	
100,000	2.0003	2.0003	0.0000		
50,000	1.0001	1.0002	0.0000	-.002%	-.001%
0	0.0000	0.0000	0.0000	.000%	.000%

Figure 4-4. Typical Load Cell Calibration Sheet.

Digital Calibration

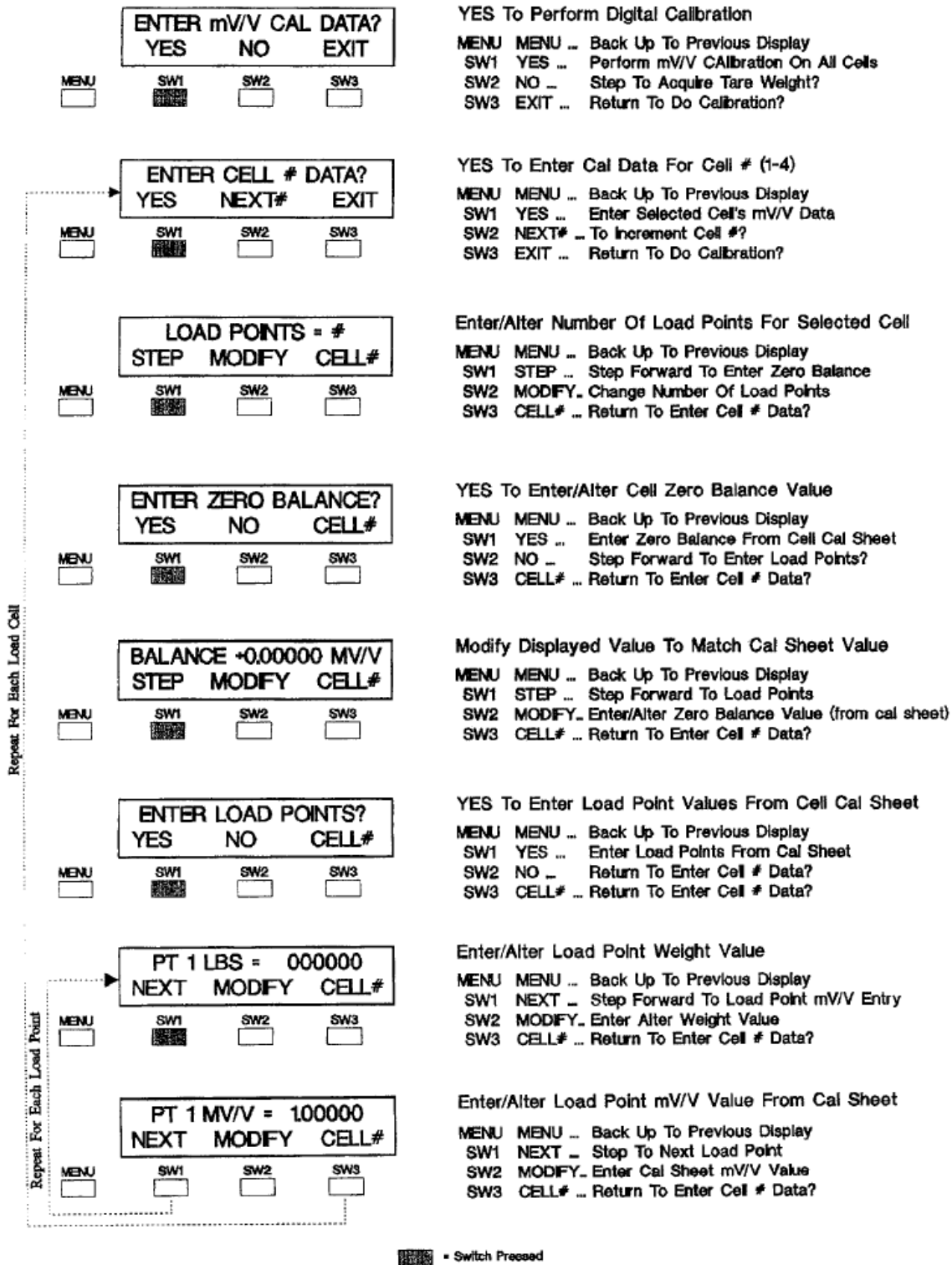
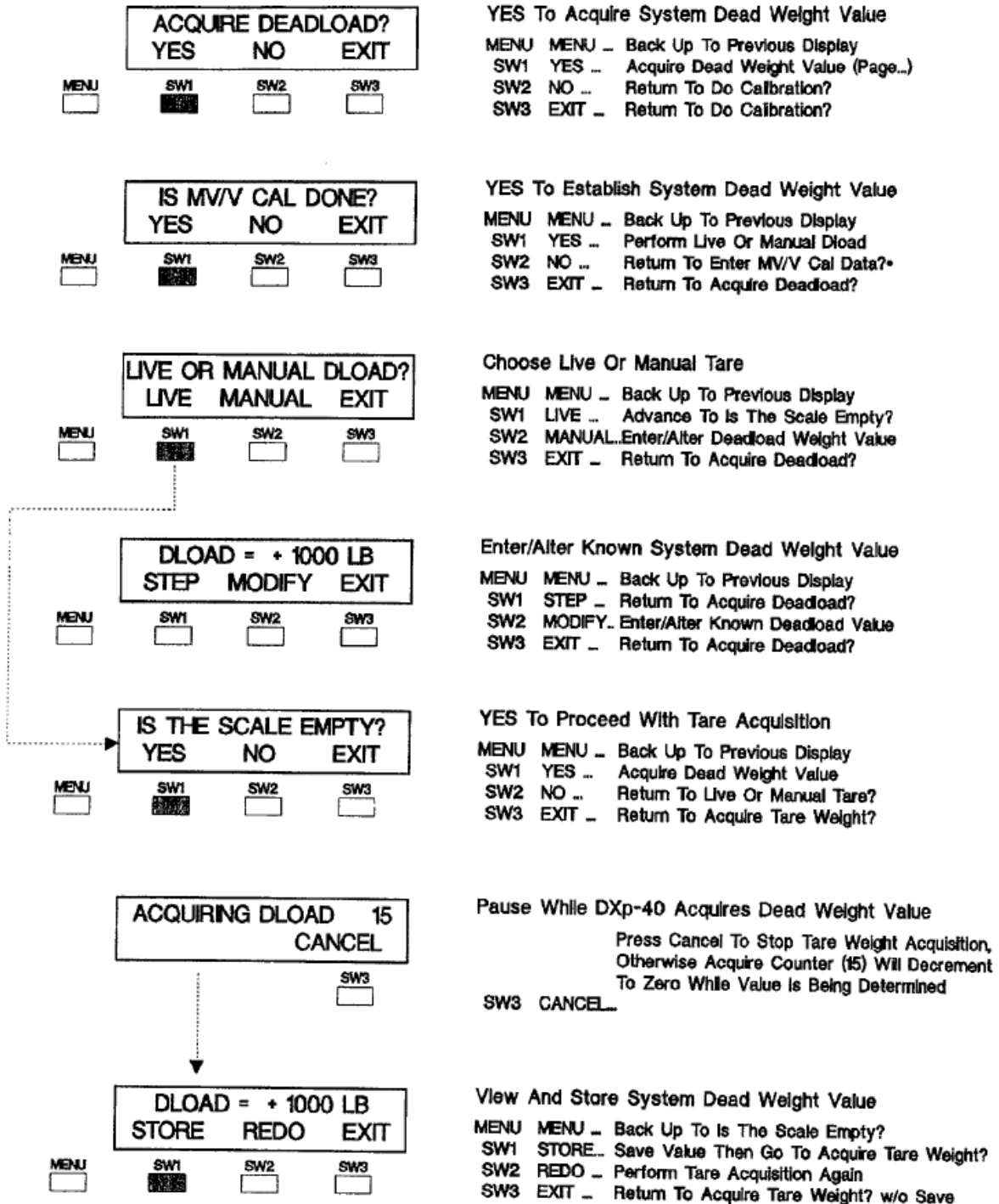

Figure 4-5. Millivolt per Volt Calibration Guide.

Acquire Deadload* (Establish Zero Weight Reference)



* Digital Type Calibration Must Be Performed Before Attempting Tare

Figure 4-6. Acquire Deadload (Used with mV/V Cal Only).

4.4 DEADLOAD TYPE CALIBRATION

Deadload calibration (Figure 4-7) uses known value 'true' weights to establish calibration span points. Often, only one true weight value is needed since water or other material can be substituted incrementally for that value.

4.4.1 Perform Corner Test (Sensitivity Adjust)

NOTE: Corner adjusting requires that dead weight equaling 15% (minimum) of scale capacity be loaded at each corner. Since applying/shifting this much dead weight is not practical for most tank based weigh systems, corner adjustment is usually performed only on platform scales.

NOTE: Corner testing is not required on systems using transducers with matched outputs or systems where the load distribution is not likely to change.

With multiple simultaneous ND conversion technology it is possible to balance or corner adjust the system transducers. Corner adjustment ensures accurate weight readings even when the scale is loaded off center. Choose YES if corner adjustment is desired. Systems that do not experience load distribution changes typically do not require corner adjustment.

Corner testing optimizes scale performance by learning and compensating for the actual relationship between each transducer's output based upon varying load distribution. Perform corner testing by placing a known value weight

on the scale/system directly above or as close as possible to each transducer as instructed in Figure 4-7. Position the weight above transducer #1 (channel 1) and acquire. Repeat the process for each subsequent transducer. After each transducer has 'felt' the weight, the FSk-40 will store the reaction pattern. This pattern becomes a reference for balancing live weight readings. Corner testing is ideal for systems/scales where ingredients may shift or loads move.

4.4.2 Acquire Zero

Acquire zero is the first step in deadload calibrating a weigh system. Acquire zero removes the weight value of system equipment (tank, platform, mixers, motors, etc.) and establishes a zero reference point. All live weight transactions will be referenced to this point. Remove any unessential equipment from the scale/system and follow instructions presented in Figure 4-7 (second page).

4.4.3 Span Point Entry

Once zero is established a span point (or points) must be entered to complete calibration (Figure 4-7 second page). The simplest form of deadload calibration consists of acquiring zero and entering one span point, preferably the full scale capacity value. To accommodate more sophisticated systems, the FSk-40 provides up to 10 span point entries. Weigh systems can be fully linearized, or tuned, by entering known live weight span points between zero and capacity. Enter span points from the lowest to the highest weight value; do not attempt to enter a point value lower than the previous entry. When deadloading to full capacity is impractical, the FSk-40 accurately interpolates all weight values between the last span point and capacity.

Deadload Type Calibration Flow Diagram

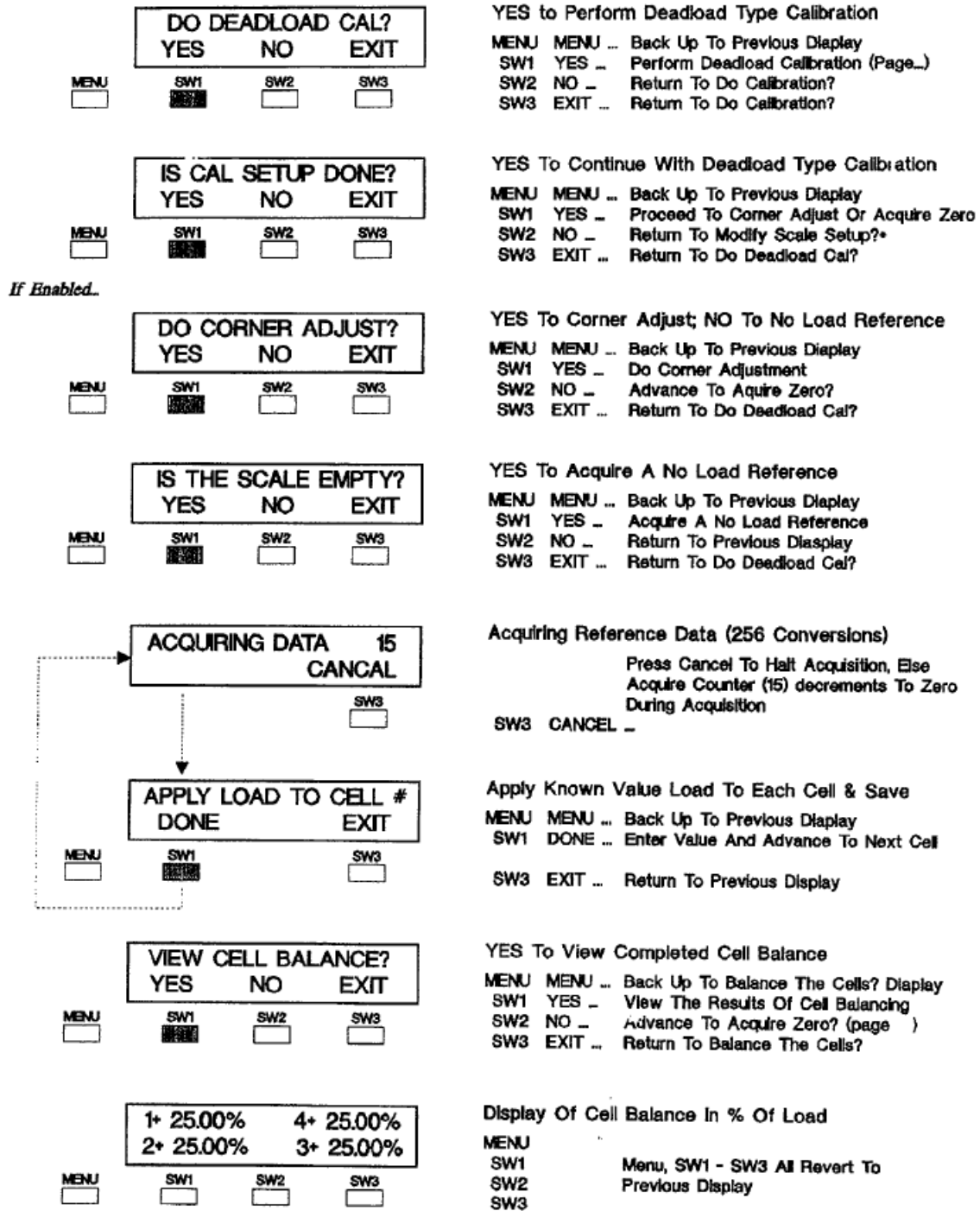

* Cal Setup Must Be Performed Before Attempting Deadload Calibration

NOTE: Point values should be within 20% of each other. Slight load cells to correct, if necessary.

= Switch Pressed

Figure 4-7. Deadload Calibration Entry Guide.

Deadload Type Calibration Flow Diagram (cont.)

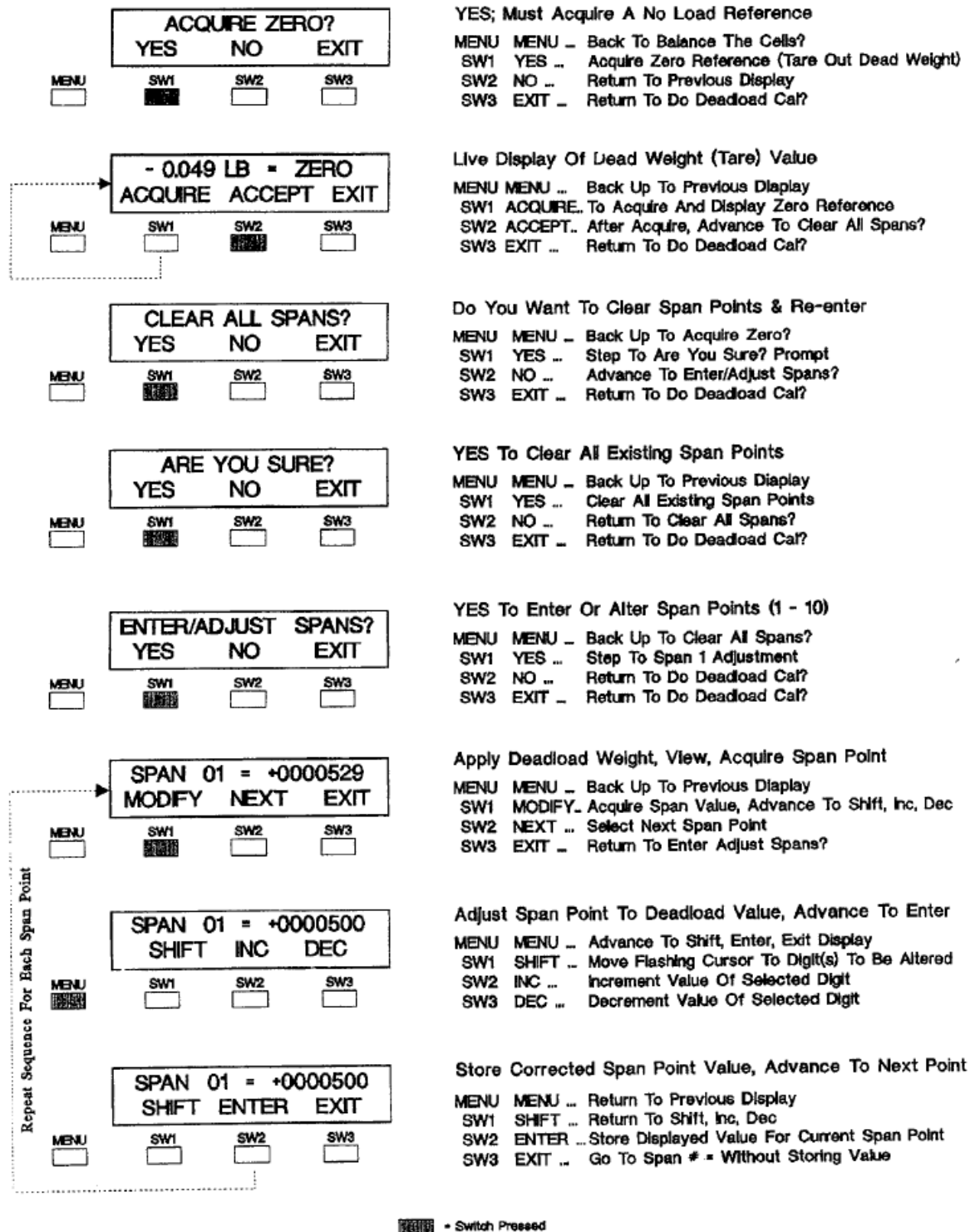

Figure 4-7 con't. Deadload Calibration Entry Guide.

SECTION 5. On-Line Transducer Diagnostics

5.1 GENERAL

NOTE: Calibration must be performed before using diagnostics.

The next step in the FSk-40 main menu is diagnostic error analysis and parameter entry (Figure 5-1). The unique quad AID converter design makes it possible to diagnose system errors down to the exact transducer. Each transducer is continually checked for open circuit/wiring, zero shifts, drift, and overload. FSk-40 diagnostics also detect system malfunctions, such as structure shifts, impact shock loads, and in-gradient build up (heel) problems.

Figure 5-2 provides an overall flow diagram for all diagnostic functions. Once an error is









detected, the display shows a flashing 'E' while the serial output transmits the error code to the host computer. Flow diagrams (Figure 5-3) show how to pinpoint the faulty transducer(s) and change error condition parameters, if desired.

5.2 DIAGNOSTIC TESTS

Four of the five tests, load shift, zero shift, drift (when activated), and noise test, are evaluated and updated every 256 conversions (12 seconds). Overload is checked and updated every conversion (50 msec).

Flow diagrams (Figure 5-3) provided for each test show how to distinguish the transducer/system fault and change parameters if desired.

Main Menu (Accessed from Operation Mode)

<p>MENU </p>	<p>+100000 LB GROSS ND G/N ZERO</p> <p>SW1 SW2 SW3</p> <p><input type="checkbox"/> <input type="checkbox"/> <input type="checkbox"/></p>	<p>LIVE WEIGHT DISPLAY, GROSS MODE</p> <p>MENU MENU ... Advance To Digital Filter Setup Unless Error</p> <p>SW1 ND ... Display Individual Load Cells</p> <p>SW2 NET ... Switch To Net Mode</p> <p>SW3 ZERO ... Push To Zero</p>
<p>MENU </p>	<p>DIGITAL FILTER SETUP YES NO EXIT</p> <p>SW1 SW2 SW3</p> <p><input type="checkbox"/> <input type="checkbox"/> <input type="checkbox"/></p>	<p>YES to enter/alter Digital Filtering Parameters</p> <p>MENU MENU ... Advance To 'Cell Diagnostics'</p> <p>SW1 YES ... Enter Or Alter Filter Parameters</p> <p>SW2 NO ... Go To Cell Diagnostics</p> <p>SW3 EXIT ... Return To Live Operation</p>
<p>MENU </p>	<p>CELL DIAGNOSTICS YES NO EXIT</p> <p>SW1 SW2 SW3</p> <p><input type="checkbox"/> <input type="checkbox"/> <input type="checkbox"/></p>	<p>CHECK: Load Shift, Zero Shift, Drift, Noise, Raw Data</p> <p>MENU MENU ... Advance To 'Do Calibration'</p> <p>SW1 YES ... Perform Diagnostic Evaluation</p> <p>SW2 NO ... Go To Do Calibration</p> <p>SW3 EXIT ... Return To Live Operation</p>
<p>MENU </p>	<p>DO CALIBRATION? YES NO EXIT</p> <p>SW1 SW2 SW3</p> <p><input type="checkbox"/> <input type="checkbox"/> <input type="checkbox"/></p>	<p>YES to Perform System Calibration</p> <p>MENU MENU ... Return To Live Operation</p> <p>SW1 YES ... Enter Or Alter Calibration Settings</p> <p>SW2 NO ... Return To Live Operation</p> <p>SW3 EXIT ... Return To Live Operation</p>
<p>MENU </p>	<p>ANALOG OUTPUT SETUP? YES NO EXIT</p> <p>SW1 SW2 SW3</p> <p><input type="checkbox"/> <input type="checkbox"/> <input type="checkbox"/></p>	<p>YES To Enter/Alter Analog Output Parameters</p> <p>MENU MENU ... Advance To 'Setpoints'</p> <p>SW1 YES ... Enter/Alter Analog Output Parameters</p> <p>SW2 NO ... Go To Setpoints?</p> <p>SW3 EXIT ... Return To Live Operation</p>
<p>MENU </p>	<p>SETPONTS ? YES NO EXIT</p> <p>SW1 SW2 SW3</p> <p><input type="checkbox"/> <input type="checkbox"/> <input type="checkbox"/></p>	<p>YES To Configure Relay Output Functions</p> <p>MENU MENU ... Advance To MODBUS Interface?</p> <p>SW1 YES ... Configure Set Point Relay Outputs</p> <p>SW2 NO ... Go To MODBUS Interface?</p> <p>SW3 EXIT ... Return To Live Operation</p>
<p>MENU </p>	<p>MODBUS INTERFACE? YES NO EXIT</p> <p>SW1 SW2 SW3</p> <p><input type="checkbox"/> <input type="checkbox"/> <input type="checkbox"/></p>	<p>YES To Configure MODBUS Communication Parameters</p> <p>MENU MENU ... Advance To 'DXP40 Version Information'</p> <p>SW1 YES ... Configure MODBUS Interface</p> <p>SW2 NO ... Go To 'DXP40 Version Information'</p> <p>SW3 EXIT ... Return To Live Operation</p>
<p>MENU </p>	<p>BLH DXP40 VER 10 OPTIONS -1-2-1</p>	<p>View Software Version® and Option Status</p> <p>MENU MENU ... Return To Live Operation</p>

 * Switch Pressed

Figure 5-1. Diagnostic Error Evaluation Main Menu.

Transducer Diagnostics Main Menu

<p>MENU <input type="checkbox"/></p>	<p>CELL DIAGNOSTICS</p> <p>YES NO EXIT</p> <p>SW1 SW2 SW3</p> <p><input type="checkbox"/> <input checked="" type="checkbox"/> <input type="checkbox"/></p>	<p>CHECK: Load Shift, Zero Shift, Drift, Noise, Overload</p> <p>MENU MENU ... Advance To 'Do Calibration'</p> <p>SW1 YES ... Perform Diagnostic Evaluation</p> <p>SW2 NO ... Go To Do Calibration</p> <p>SW3 EXIT ... Return To Live Operation</p>
<p>MENU <input type="checkbox"/></p>	<p>LOAD SHIFT & DISPLAY</p> <p>YES NO EXIT</p> <p>SW1 SW2 SW3</p> <p><input type="checkbox"/> <input checked="" type="checkbox"/> <input type="checkbox"/></p>	<p>YES To Evaluate Load Shift Error</p> <p>MENU MENU ... Return To Previous Display</p> <p>SW1 YES ... Figure 6-3 - Evaluate Shift Error(s)</p> <p>SW2 NO ... Step To Zero Shift & Display</p> <p>SW3 EXIT ... Return To Cell Diagnostics</p>
<p>MENU <input type="checkbox"/></p>	<p>ZERO SHIFT & DISPLAY</p> <p>YES NO EXIT</p> <p>SW1 SW2 SW3</p> <p><input type="checkbox"/> <input checked="" type="checkbox"/> <input type="checkbox"/></p>	<p>YES To Evaluate Zero Shift Error</p> <p>MENU MENU ... Return To Previous Display</p> <p>SW1 YES ... Figure 6-4 - Evaluate Zero Shift Error(s)</p> <p>SW2 NO ... Step To Drift Test & Display</p> <p>SW3 EXIT ... Return To Cell Diagnostics</p>
<p>MENU <input type="checkbox"/></p>	<p>DRIFT TEST & DISPLAY</p> <p>YES NO EXIT</p> <p>SW1 SW2 SW3</p> <p><input type="checkbox"/> <input checked="" type="checkbox"/> <input type="checkbox"/></p>	<p>YES To Evaluate Drift Error</p> <p>MENU MENU ... Return To Previous Display</p> <p>SW1 YES ... Figure 6-5 - Evaluate Drift Error(s)</p> <p>SW2 NO ... Step To Noise Test & Display</p> <p>SW3 EXIT ... Return To Cell Diagnostics</p>
<p>MENU <input type="checkbox"/></p>	<p>NOISE TEST & DISPLAY</p> <p>YES NO EXIT</p> <p>SW1 SW2 SW3</p> <p><input type="checkbox"/> <input checked="" type="checkbox"/> <input type="checkbox"/></p>	<p>YES To Evaluate Noise Error</p> <p>MENU MENU ... Return To Previous Display</p> <p>SW1 YES ... Figure 6-6 - Evaluate Noise Error(s)</p> <p>SW2 NO ... Step To Cell Overload Limits</p> <p>SW3 EXIT ... Return To Cell Diagnostics</p>
<p>MENU <input type="checkbox"/></p>	<p>CELL OVERLOAD LIMITS</p> <p>YES NO EXIT</p> <p>SW1 SW2 SW3</p> <p><input type="checkbox"/> <input checked="" type="checkbox"/> <input type="checkbox"/></p>	<p>YES To Check Load Cell(s) Overload Condition</p> <p>MENU MENU ... Return To Previous Display</p> <p>SW1 YES ... Figure 6-7 - Evaluate Overload Error(s)</p> <p>SW2 NO ... Step To Recall Values</p> <p>SW3 EXIT ... Return To Cell Diagnostics</p>
<p>MENU <input type="checkbox"/></p>	<p>RECALL VALUES?</p> <p>YES NO EXIT</p> <p>SW1 SW2 SW3</p> <p><input type="checkbox"/> <input type="checkbox"/> <input type="checkbox"/></p>	<p>YES To View Zero, Tare, Deadload, Or Cell Balance</p> <p>MENU MENU ... Return To Previous Display</p> <p>SW1 YES ... Figure 6-8 - Zero, Tare, Deadload, Balance</p> <p>SW2 NO ... Go To Degrad Setup?</p> <p>SW3 EXIT ... Return To Cell Diagnostics</p>
<p>MENU <input type="checkbox"/></p>	<p>DEGRADE SETUP?</p> <p>YES NO EXIT</p> <p>SW1 SW2 SW3</p> <p><input type="checkbox"/> <input type="checkbox"/> <input type="checkbox"/></p>	<p>YES To Acquire Reference or Modify Cell Enable</p> <p>MENU MENU ... Return To Previous Display</p> <p>SW1 YES ... Figure 6-9 - Perform Degrad Setup</p> <p>SW2 NO ... Go To Cell Diagnostics</p> <p>SW3 EXIT ... Return To Cell Diagnostics</p>

= Switch Pressed

Figure 5-3. Diagnostic Error Evaluation Main Menu.

5.2.1 Load Shift

A load shift error indicates that system equipment or vessel contents have shifted so as to place a disproportional amount of weight on a single transducer. This test does not apply to initial load alterations during installation and calibration. Load shift testing detects significant load changes in an operational system. Follow guidelines in Figure 5-4 to determine which transducer(s) is experiencing the shift error.

Load shifts can be caused by many things, among a few are: heel build up on one side of a tank, support structure changes introducing more force from connected pipes or process equipment, excessive deflection of a support leg, or faulty signal from the transducer.

Check the system structure above that transducer for evidence of weight shift. If physical evidence does not point to a structural or content error, see if the transducer has failed any of the other diagnostic tests.

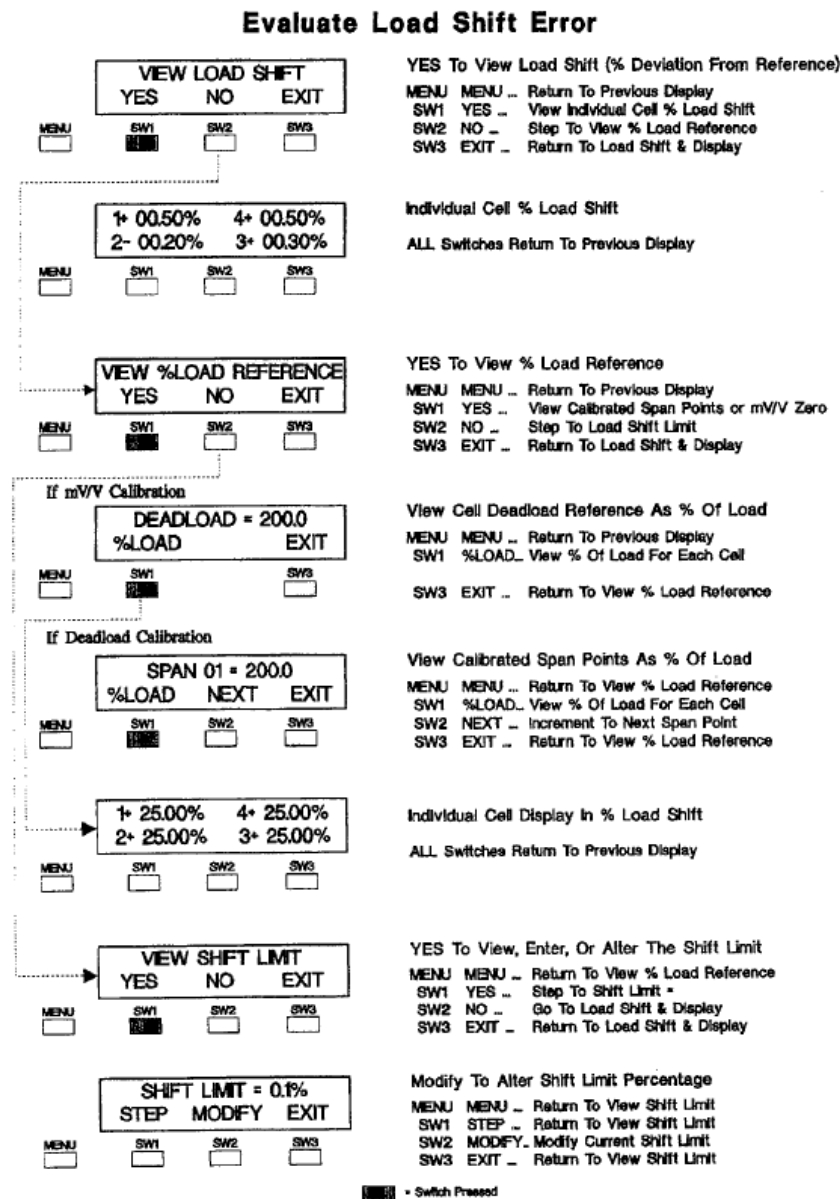

Figure 5-4. Load Shift Error Evaluation Instructions.

5.2.2 Zero Shift

Zero shift testing identifies a transducer(s) that has shifted from its original calibration zero reference point. The diagnostic zero shift limit entry is DIFFER-ENT from the 2%, 20%, 100%, or OFF calibration ZERO band entry. Zero shift testing is applied to each transducer, whereas the zero band concerns only the total system weight. Follow the flow diagram in Figure 5-5 to view the zero shift value for each transducer and/or alter the zero shift limit.

Zero shift test failures typically appear in transducers that have been damaged by overloading or electrical leakage. Either of these factors can cause a permanent shift in a transducer's zero reference. If a transducer fails the zero shift test, check to see if the overload peak has exceeded acceptable tolerance levels. Note that the zero shift test is performed only when the 'zero' function is activated.

Evaluate Zero Shift Error

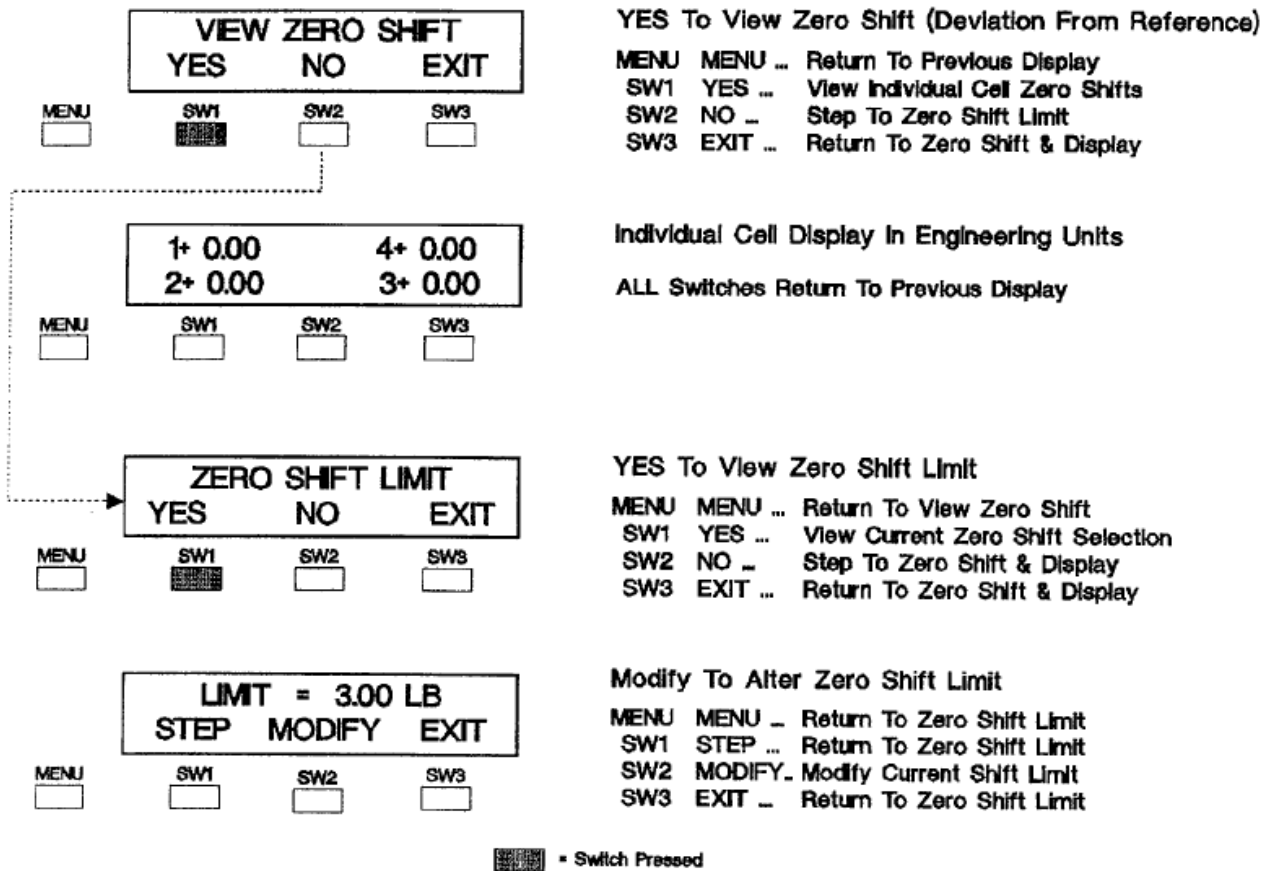

Figure 5-5. Zero Shift Error Evaluation Instructions.

5.2.3 Drift Test

The drift test detects a transducer output that is changing beyond acceptable tolerance levels. When the system stabilizes, after a period of

weight activity, the processor waits one minute and then stores a reference value for each transducer. Successive values, averaged every 256 conversions, are compared to the stored value and checked for compliance with the drift

band selection. Drift testing is abandoned when the system is active. Use Figure 5-6 to evaluate drift errors and/or change the drift band.

Long term transducer drift problems may be caused by electrical leakage or system structural

problems. Since many systems experience inactive periods of 8 or more hours, this test is highly effective at catching long term drift problems. Long term drift testing provides 'early warning detection' for transducers that may fail completely at a later date.

Evaluate Drift Error

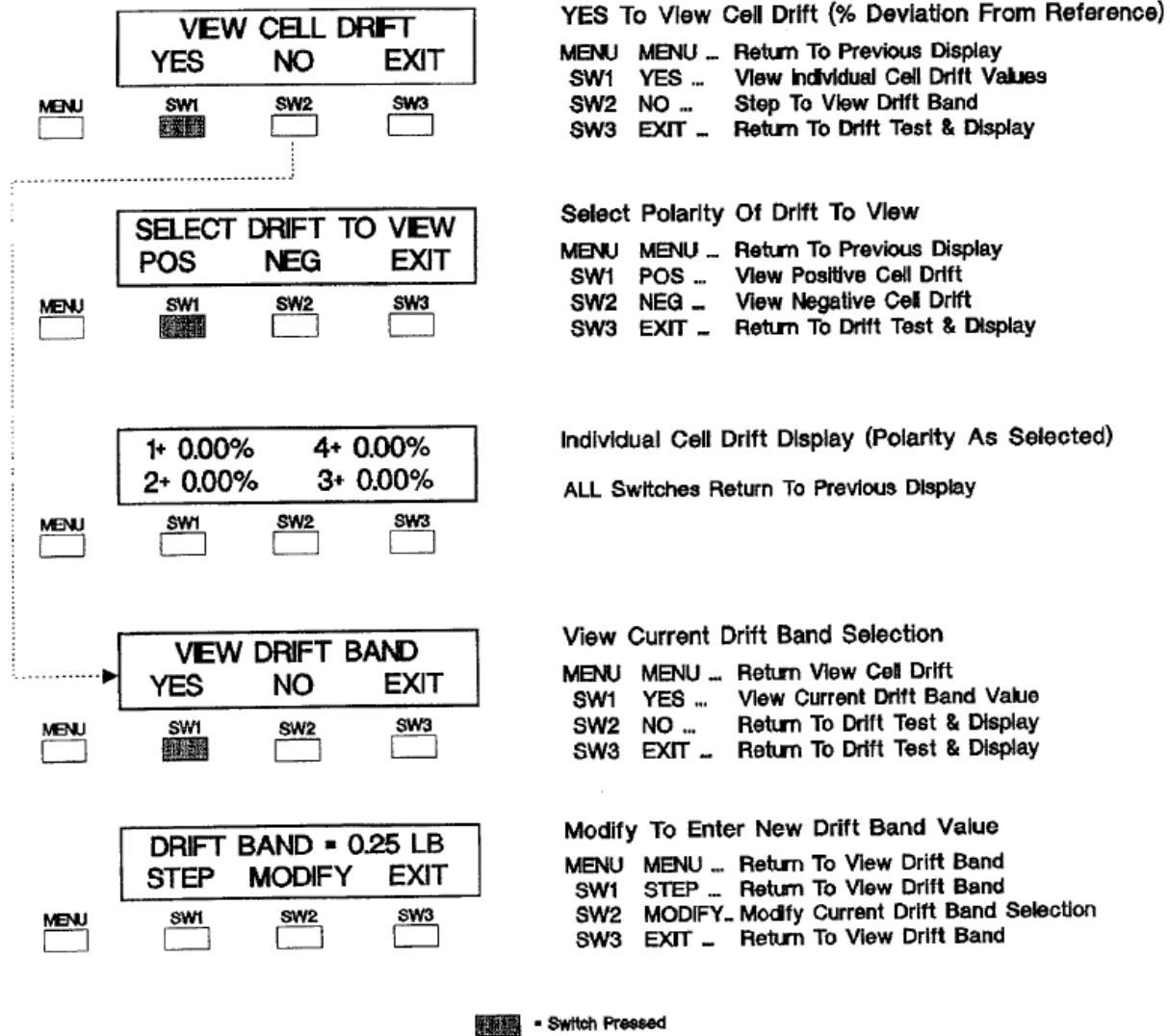

Figure 5-6. Drift Error Evaluation Instructions.

5.2.4 Noise Test

Noise testing identifies a transducer(s) that is experiencing unusual amounts of static state signal fluctuation. The standard deviation for each transducer output is computed every 256

AID conversions (12 seconds). The standard deviation values of all transducers are then compared to one another. If the value of any one transducer exceeds the values of all other transducers by an amount greater than the imbalance band, an error is issued against that

transducer. Use Figure 5-7 to view the standard deviation for each transducer and/or change the imbalance band value.

Excessive noise may be introduced into a transducer through structural vibration or installation location (fork lift traffic, etc.). Another factor could be a loose or corroded transducer connection. If a transducer checks out 'good' for all other diagnostic tests but fails the noise test, carefully check the mounting location and electrical connections.

NOTE: Noise testing also provides a good way to set the FSK-40 filter. Try the following:

- 1). Turn the filter off (select 50 msec filter, Figure 6-2).
- 2). View the standard deviation for each transducer (during non-error condition).
- 3). Enter the highest value standard deviation as the noise band value.

Evaluate Noise Error

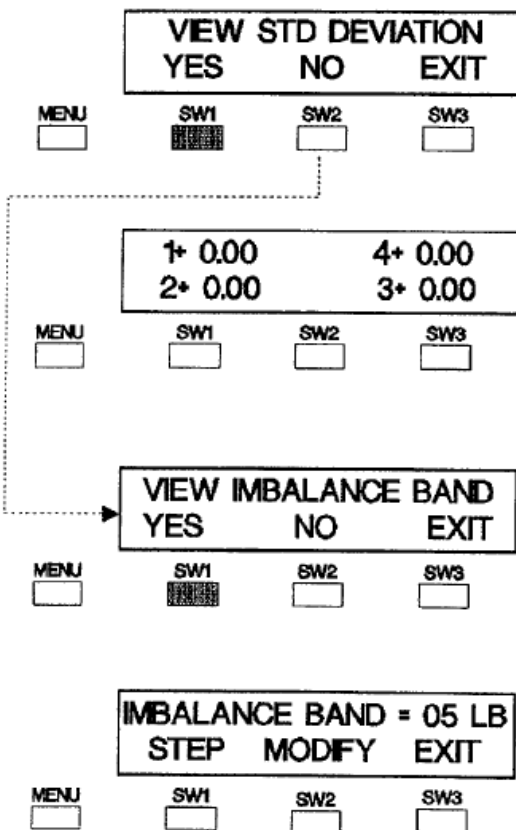

YES To View Standard Deviation

MENU MENU ... Return To Previous Display
 SW1 YES ... View Individual Load Cell Noise
 SW2 NO ... Step To View Imbalance Band
 SW3 EXIT ... Return To Noise Test & Display

Individual Cell Values In Display Units

ALL Switches Return To Previous Display

YES To View Imbalance Band

MENU MENU ... Return To View STD Deviation
 SW1 YES ... View Current Imbalance Band Selection
 SW2 NO ... Return To Noise Test & Display
 SW3 EXIT ... Return To Noise Test & Display

Modify To Alter Imbalance Band Selection

MENU MENU ... Return To View Imbalance Band
 SW1 STEP ... Return To View Imbalance Band
 SW2 MODIFY.. Modify Imbalance Band Percentage
 SW3 EXIT ... Return To View Imbalance Band

Figure 5-7. Noise Error Evaluation Instructions.

5.2.5 Overload

Since overload is critical to system safety and transducer integrity, it is checked every 50 msec. Cell overload limits are typically set at the

transducer's rated capacity. A running peak value for each transducer is recorded and may be checked (or cleared) at any time. In older weigh systems, overload typically signaled a

total system overload (system capacity exceeded).

The FSk-40, however, can alert an operator to a single transducer overload, even though total system capacity has not been exceeded. Single

transducer overloads can be caused by heel buildup, shock loads (mixers/blenders, ingredient free fall force, etc.) and poor system design. Figure 5-8 provides a flow diagram for transducer overload evaluation.

Load Cell Overload Limit Selection

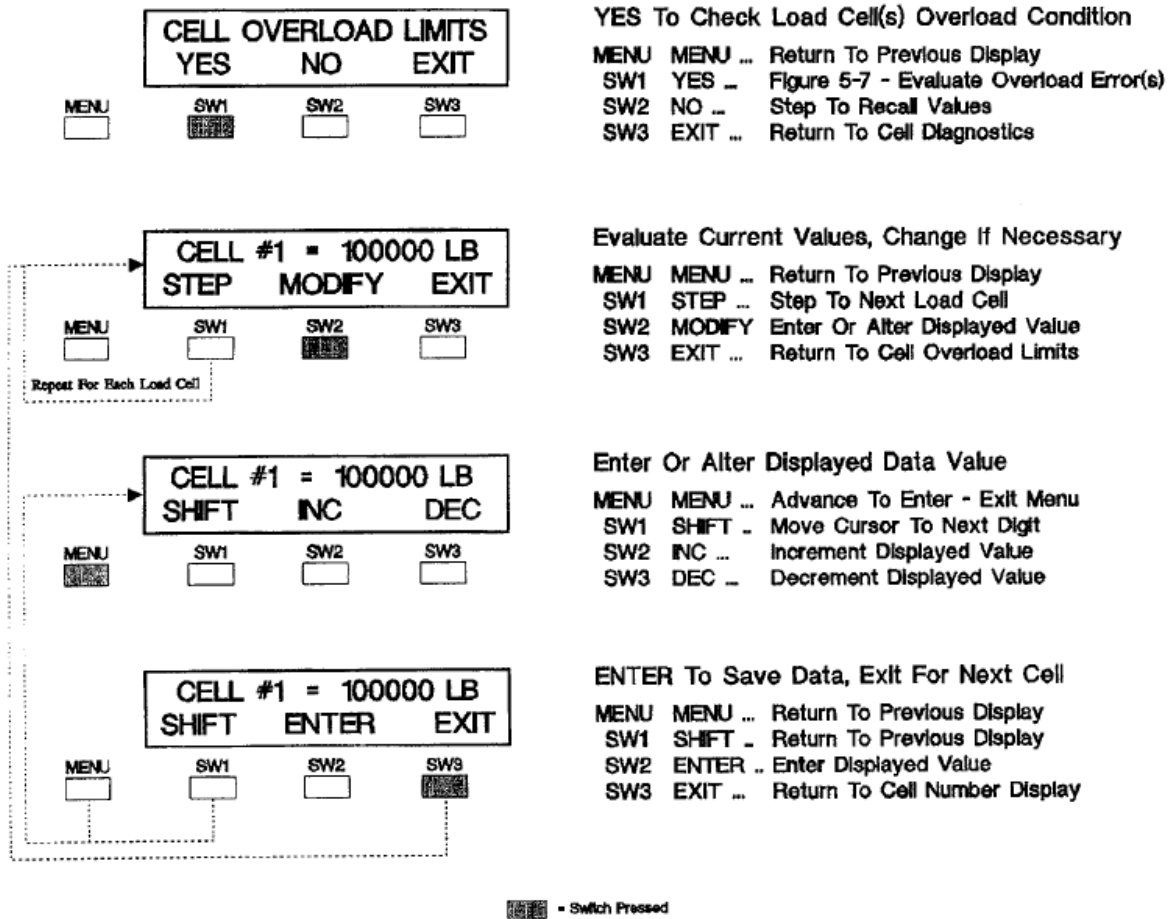

Figure 5-8. Overload Error Evaluation Instructions.

5.2.6 Recall Values

Recall values allows an operator to view the current TARE, ZERO, Balance, and Deadload

values. Figure 5-9 shows how to recall any or all values.

Recall Values (Zero, Tare, Balance or Deadload)

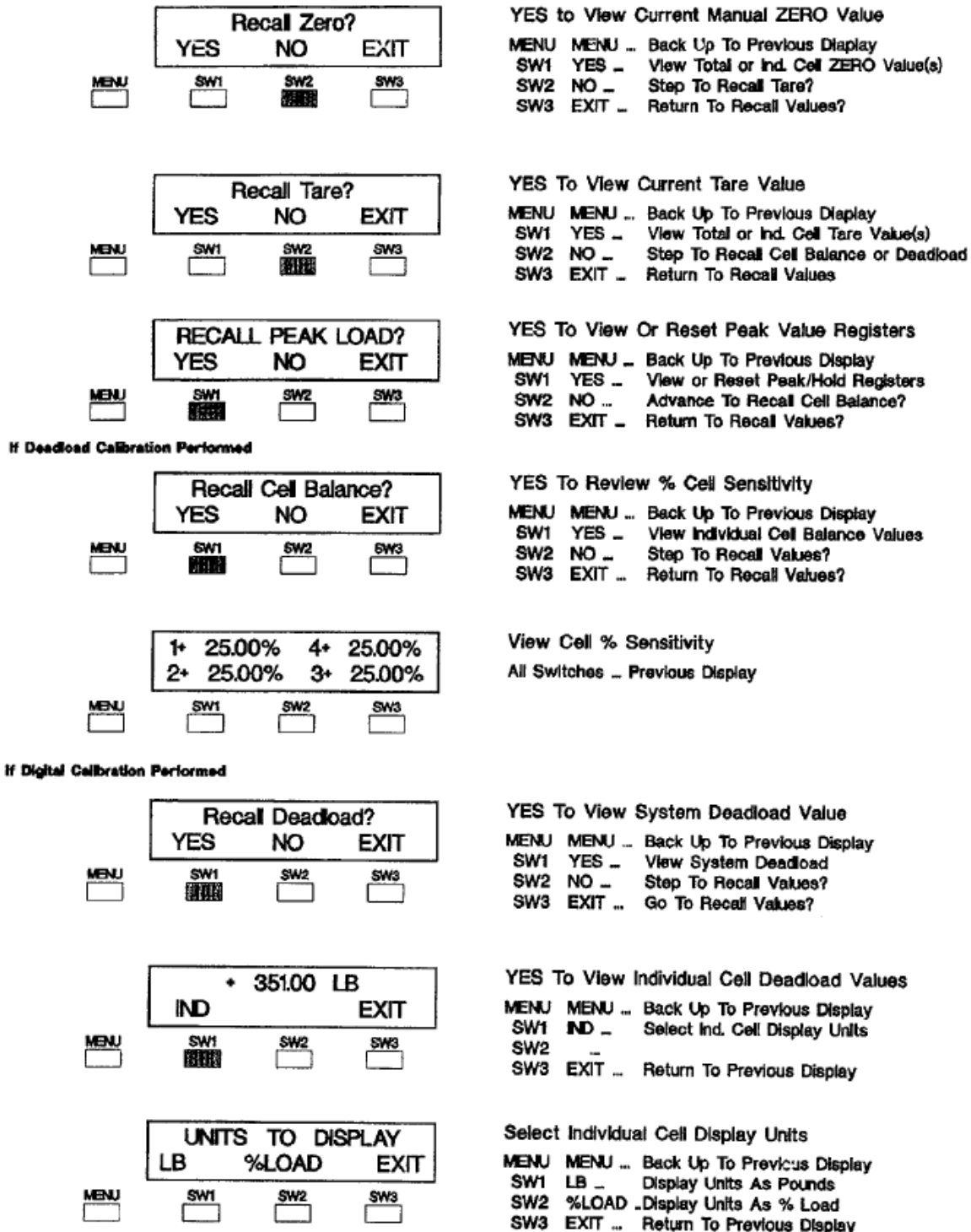

= Switch Pressed

Figure 5-9. Recall Values Flow Diagram.

5.2.7 Degrade Mode Function

If a diagnostic test identifies one or more transducers in the system as providing faulty data, it is possible using degrade mode operation to eliminate the erroneous data from the transducer(s) contributing to the system weight measurement. Since the FSk-40 measures each channel independently and digitally sums the weight information, degraded mode operation shuts off the actual measurement from the suspect channel(s) and uses a calculated digital substitute value, corrected for system balance and channel sensitivity. The resulting system performance will be reduced somewhat, but will still be compensated for load imbalance. This mode of operation makes it possible to continue weigh system operation with minimal interruption.

To activate degraded mode operation it is necessary to shut-off the suspect channel using the Cell Enable menu (Figure 5-10) accessed via the keypad. It is not possible to automatically activate this mode internally or remotely through the serial port.

Prior to degrade mode operation, a degrade mode reference must be established. This reference establishes individual transducer characteristics for use in future degrade mode operation. To enter the reference point, perform the following:

- [1] Calibrate the system and acquire a system deadload zero (mV/V calibration also must acquire deadload zero).
- [2] Load system to at least 20% of full scale capacity.
- [3] Proceed to the Degrade Setup Menu (Figure 5-10) and make sure all transducers are 'On'.
- [4] With a display of ACQUIRE REFERENCE choose YES to advance to IS SCALE LOADED. Choose YES again to enter reference value.

When degrade mode is operational, a capital 'D' will appear on the right side of the LCD display. A capital 'D' also will be transmitted in the status portion of the terminal and continuous serial outputs.

For Modbus communication, status 1 (registers 40003, 40203, and 40403) bit 11 and input 12 (function 02) will be set to a '1'.

NOTE: Degrade mode cannot be implemented remotely using the serial interface or digital inputs.

NOTE: For proper degrade mode function, the system center of gravity must remain the same.

NOTE: To enter a degrade mode reference point, all transducers must be functional, turned 'On', and the system must be loaded to at least 20% of total capacity.

Degrade Setup Menu

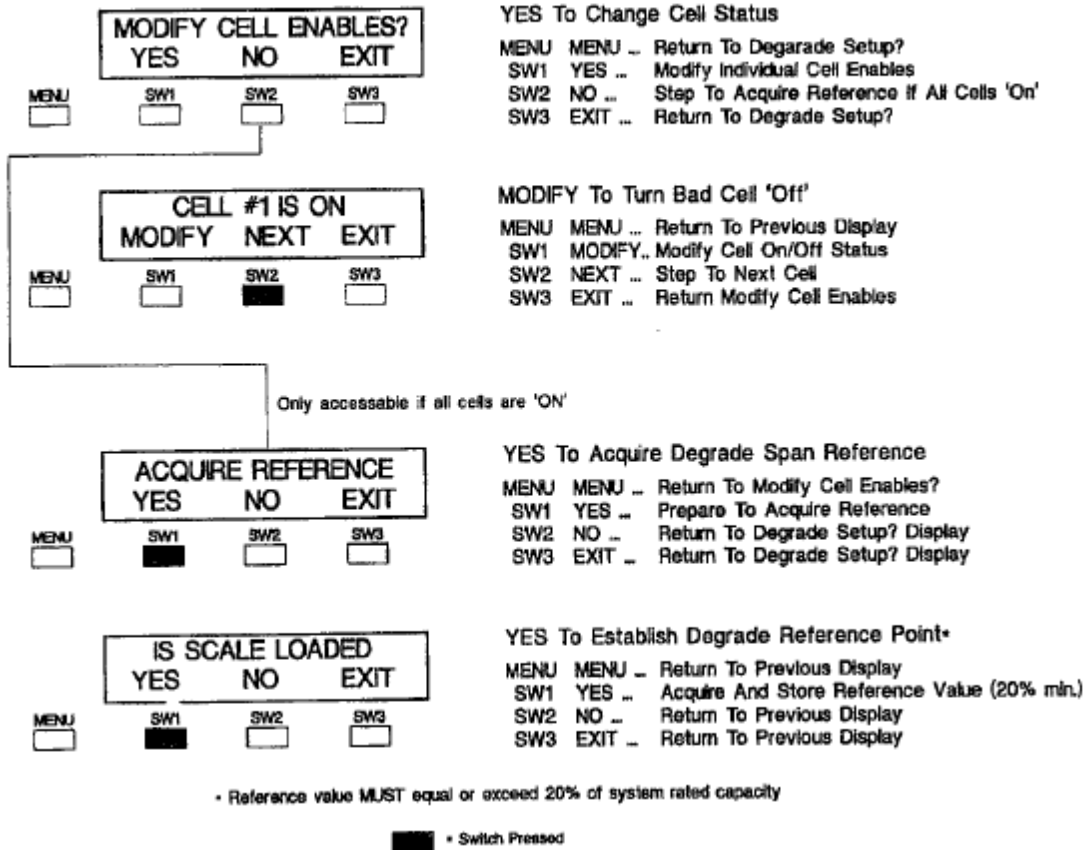

Figure 5-10. Degrade Mode Cell Selection and Reference.

SECTION 6. Dynamic Digital Filter

6.1 GENERAL

Dynamic Digital Filtering (including motion) constitutes the first set of parameter entries in the main menu (Figure 6-1). Digital filtering combines moving averaging (filter) with response and noise bands to eliminate vibration and agitation noise from dynamic process weighing/tension measurement systems. Filtering removes unwanted, mechanically induced fluctuations from the transducer signal while maintaining rapid response to genuine live weight/tension transactions.

6.2 FILTER PARAMETERS

Each filter component has adjustable parameters (Figure 6-2) so that every weigh/tension system can be 'tuned' to its own unique environment.

NOTE: It is recommended that the statistically calculated noise characteristic parameters such as standard deviation, etc., be used as a basis for initial filter set-up.

Main Menu (Accessed from Operation Mode)

<p>MENU</p> <div style="border: 1px solid black; padding: 5px; width: fit-content; margin: 10px auto;"> <p>+100000 LB GROSS ND G/N ZERO</p> <p>SW1 SW2 SW3</p> <p><input type="checkbox"/> <input type="checkbox"/> <input type="checkbox"/></p> </div>	<p>LIVE WEIGHT DISPLAY, GROSS MODE</p> <p>MENU MENU _ Advance To Digital Filter Setup Unless Error</p> <p>SW1 ND _ Display Individual Load Cells</p> <p>SW2 NET _ Switch To Net Mode</p> <p>SW3 ZERO _ Push To Zero</p>
<p>MENU</p> <div style="border: 1px solid black; padding: 5px; width: fit-content; margin: 10px auto;"> <p>DIGITAL FILTER SETUP YES NO EXIT</p> <p>SW1 SW2 SW3</p> <p><input type="checkbox"/> <input type="checkbox"/> <input type="checkbox"/></p> </div>	<p>YES to enter/alter Digital Filtering Parameters</p> <p>MENU MENU _ Advance To 'Cell Diagnostics'</p> <p>SW1 YES _ Enter Or Alter Filter Parameters</p> <p>SW2 NO _ Go To Cell Diagnostics</p> <p>SW3 EXIT _ Return To Live Operation</p>
<p>MENU</p> <div style="border: 1px solid black; padding: 5px; width: fit-content; margin: 10px auto;"> <p>CELL DIAGNOSTICS YES NO EXIT</p> <p>SW1 SW2 SW3</p> <p><input type="checkbox"/> <input type="checkbox"/> <input type="checkbox"/></p> </div>	<p>CHECK: Load Shift, Zero Shift, Drift, Noise, Raw Data</p> <p>MENU MENU _ Advance To 'Do Calibration'</p> <p>SW1 YES _ Perform Diagnostic Evaluation</p> <p>SW2 NO _ Go To Do Calibration</p> <p>SW3 EXIT _ Return To Live Operation</p>
<p>MENU</p> <div style="border: 1px solid black; padding: 5px; width: fit-content; margin: 10px auto;"> <p>DO CALIBRATION? YES NO EXIT</p> <p>SW1 SW2 SW3</p> <p><input type="checkbox"/> <input type="checkbox"/> <input type="checkbox"/></p> </div>	<p>YES to Perform System Calibration</p> <p>MENU MENU _ Return To Live Operation</p> <p>SW1 YES _ Enter Or Alter Calibration Settings</p> <p>SW2 NO _ Return To Live Operation</p> <p>SW3 EXIT _ Return To Live Operation</p>
<p>MENU</p> <div style="border: 1px solid black; padding: 5px; width: fit-content; margin: 10px auto;"> <p>ANALOG OUTPUT SETUP? YES NO EXIT</p> <p>SW1 SW2 SW3</p> <p><input type="checkbox"/> <input type="checkbox"/> <input type="checkbox"/></p> </div>	<p>YES To Enter/Alter Analog Output Parameters</p> <p>MENU MENU _ Advance To 'Setpoints?'</p> <p>SW1 YES _ Enter/Alter Analog Output Parameters</p> <p>SW2 NO _ Go To Setpoints?</p> <p>SW3 EXIT _ Return To Live Operation</p>
<p>MENU</p> <div style="border: 1px solid black; padding: 5px; width: fit-content; margin: 10px auto;"> <p>SETPOINTS ? YES NO EXIT</p> <p>SW1 SW2 SW3</p> <p><input type="checkbox"/> <input type="checkbox"/> <input type="checkbox"/></p> </div>	<p>YES To Configure Relay Output Functions</p> <p>MENU MENU _ Advance To MODBUS Interface?</p> <p>SW1 YES _ Configure Set Point Relay Outputs</p> <p>SW2 NO _ Go To MODBUS Interface?</p> <p>SW3 EXIT _ Return To Live Operation</p>
<p>MENU</p> <div style="border: 1px solid black; padding: 5px; width: fit-content; margin: 10px auto;"> <p>MODBUS INTERFACE? YES NO EXIT</p> <p>SW1 SW2 SW3</p> <p><input type="checkbox"/> <input type="checkbox"/> <input type="checkbox"/></p> </div>	<p>YES To Configure MODBUS Communication Parameters</p> <p>MENU MENU _ Advance To 'DXP40 Version Information'</p> <p>SW1 YES _ Configure MODBUS Interface</p> <p>SW2 NO _ Go To 'DXP40 Version Information'</p> <p>SW3 EXIT _ Return To Live Operation</p>
<p>MENU</p> <div style="border: 1px solid black; padding: 5px; width: fit-content; margin: 10px auto;"> <p>BLH DXP40 VER 10 OPTIONS -1-2-1</p> </div>	<p>View Software Version# and Option Status</p> <p>MENU MENU _ Return To Live Operation</p>

Figure 6-1. Main Menu Digital Filter Selection.

Digital Filtering Setup

FILTER = #1			
STEP MODIFY EXIT			
MENU	SW1	SW2	SW3
<input type="checkbox"/>	<input type="checkbox"/>	<input checked="" type="checkbox"/>	<input type="checkbox"/>

View Or Modify Filters *

MENU MENU ... Return To Digital Filter Setup
 SW1 STEP ... Step To Next Filter
 SW2 MODIFY.. Modify Selected Filter Parameters
 SW3 EXIT ... Return To Digital Filter Setup

FILTER = 50 MSEC			
STEP MODIFY EXIT			
MENU	SW1	SW2	SW3
<input type="checkbox"/>	<input checked="" type="checkbox"/>	<input type="checkbox"/>	<input type="checkbox"/>

View/Modify Filter Length Selection (msec)

Choose: 50, 100, 200, 400, 800, 1600, 3200, 6400

MENU MENU ... Back Up To Previous Display
 SW1 STEP ... Advance To Band Filter Selection
 SW2 MODIFY.. Modify Filter Time Length
 SW3 EXIT ... Return To Filter # Selection

BAND FILT = 4 SECS			
STEP MODIFY EXIT			
MENU	SW1	SW2	SW3
<input type="checkbox"/>	<input checked="" type="checkbox"/>	<input type="checkbox"/>	<input type="checkbox"/>

View/Modify Band Averaging Selection

Choose 0.5, 1, 2, 4, 8, 16, 32, Or 64 Seconds

MENU MENU ... Back Up To Previous Display
 SW1 STEP ... Advance To Noise Band Setup
 SW2 MODIFY.. Change Band Averaging Selection
 SW3 EXIT ... Return To Filter # Selection?

NOISE BAND = 2			
STEP MODIFY EXIT			
MENU	SW1	SW2	SW3
<input type="checkbox"/>	<input checked="" type="checkbox"/>	<input type="checkbox"/>	<input type="checkbox"/>

View/Modify Noise Band Selection (Counts)

Choose: 0 - 250 Display Counts

MENU MENU ... Back Up To Previous Display
 SW1 STEP ... Advance To Response Setup
 SW2 MODIFY.. Select New Noise Band Count Range
 SW3 EXIT ... Return To Filter # Selection

RESPONSE = 4			
STEP MODIFY EXIT			
MENU	SW1	SW2	SW3
<input type="checkbox"/>	<input checked="" type="checkbox"/>	<input type="checkbox"/>	<input type="checkbox"/>

View/Modify Response Band Selection (counts)

Choose: 0 - 250 Display Counts

MENU MENU ... Back Up To Previous Display
 SW1 STEP ... Advance To Motion Band Setup
 SW2 MODIFY.. Modify Response Time Length
 SW3 EXIT ... Return To Filter # Selection

MOTION BAND = 3			
STEP MODIFY EXIT			
MENU	SW1	SW2	SW3
<input type="checkbox"/>	<input checked="" type="checkbox"/>	<input type="checkbox"/>	<input type="checkbox"/>

View/Modify Motion Detection Band Selection

Choose: OFF, 1, 2, 3, 5, 10, 20, Or 50 Display Counts

MENU MENU ... Back Up To Previous Display
 SW1 STEP ... Advance To Noise Band Setup
 SW2 MODIFY.. Modify Filter Time Length
 SW3 EXIT ... Return To Filter # Selection

MOTION TIMER = 1 SEC			
STEP MODIFY EXIT			
MENU	SW1	SW2	SW3
<input type="checkbox"/>	<input type="checkbox"/>	<input type="checkbox"/>	<input type="checkbox"/>

View/Modify Motion Time Selection (sec)

Choose: Time 'Window' Of .5, 1, 2, 3 Seconds

MENU MENU ... Back Up To Previous Display
 SW1 STEP ... Return To Digital Filter Setup?
 SW2 MODIFY.. Modify Motion Detection Time Period
 SW3 EXIT ... Return To Filter # Selection

Figure 6-2. Digital Filter and Motion Setup.

6.3 DYNAMIC DIGITAL FILTER

Dynamic Filter software is an advanced series of filtering algorithms for attenuating random weight/tension signal noise. Using the pre-filtered signal from the standard filter, the Dynamic Filter applies a two step approach (Noise Band and Response Band) to adaptively reduce the noise components of the signal without adversely affecting system dynamics (Figure 6-3). The resulting real time signal provides stable information for high resolution indication and precise control over a broad spectrum of mechanical and electrical disturbances.

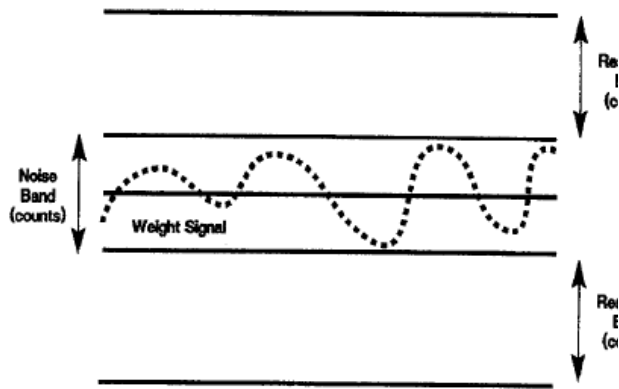

Figure 6-3. Graphical Operation Example.

6.3.1 Band Filter

Band Filter is an exponential software filter which is applied only to signal fluctuations which fall within the Noise and Response band limits. The Band Filter is fully applied to signal fluctuations which fall within the Noise Band. For signal changes which fall outside the Noise Band but within the Response Band, proprietary statistical analysis algorithms are applied to the Band Filter resulting in progressively lower dampening proportional to time within the Response Band and direction of signal change. For signal changes which fall outside both Noise and Response bands, the Band Filter is canceled. This allows heavy dampening of system noise while maintaining quick response to changes in weight signals. The Band Filter length* is selectable at 0.5, 1, 2, 4, 8, 16, 32,

and 64 seconds. The equivalent frequency attenuation is as follows:

Filter length (sec)	Frequency attenuation (Hz)
0.5	10
1	5
2	2.5
4	1.25
8	0.63
16	0.31
32	0.16
64	0.08

*Filter length is the time for an instant change to be fully reflected at the output.

6.3.2 Noise Band

Noise band is the + and - limit of the amplitude fluctuations in weigh signal due to external electrical or mechanical influences. For changes in signal amplitude equal to or less than the Noise Band limit, the Band Filter is fully applied for maximum dampening. In many applications, the standard deviation, determined by the Noise Test (paragraph 6.2.4), can be used to establish the value of the Noise Band. Under the Noise Test menu, view the standard deviation without any filtering applied. For 68% attenuation (1 sigma filter), select the largest value and round it up to an enterable value for the Noise Band. For 99% attenuation (3 sigma filter), multiply the largest standard deviation value by 3 and round it up to an enterable value for the Noise Band. Noise Band amplitude selections are from 0 (off) to 250 display counts (display resolution).

6.3.3 Response Band

Response band is the + and - limit in terms of the amplitude of changes in weight signal outside the Noise Band limit. Response allows quick response to small changes in weigh signals outside the Noise Band but within the Response Band. For changes in signal amplitude equal to or less than the Response Band limit, the Band Filter is applied with progressively lower dampening effect to allow responsive changes in signal. Response Band amplitude selections are from 0 (off) to 250 display counts (display resolution). It is

recommended that the Noise Band setting be multiplied by 1, 2, 3, or 4 to get the Response Band setting. With the vessel in a steady state, set the Noise Band according to the standard deviation value. With the Response Band set to zero any spikes that fall outside the Noise Band will cause the displayed or transmitted weight to jitter. Increase the Response Band setting until the jitter disappears.

The two bands work together to separate system noise from true change in signal achieving higher accuracy and more dependable data for control purposes.

6.3.4 Default Parameters

All FSk-40 units are shipped with these default Response parameters: band filter = 32 seconds, noise Blind band = 1, and response band = 4.

6.4 MOTION DETECTION

Motion detection parameters are entered along with filtering parameters (Figure 6-2). Motion simply determines when the system is active and when it is not. Tare and push to zero functions should not (and cannot if motion is selected) be implemented when the system is in motion. Motion can be configured for bandwidth of 1, 2, 3, 5, 10, 20, or 50 counts, or turned OFF. Once a band is selected, a time length (window) also must be established for the band. Motion must occur for the designated time interval before the system acknowledges an 'in motion' condition.

The motion timer is the time the system remains in an "in motion" condition after returning to a "not in motion" condition.

SECTION 7. Serial Communication

7.1 GENERAL

The FSk-40 is equipped with a variety of serial output formats that are selected using a series of DIP switches (Figure 7-1). DIP switch positions 1, 2, and 3 (Table 7-1) allow four format choices; Digi-System Network, continuous output, terminal/computer interface, and MODBUS RTU. All types of FSk interfacing will be discussed in the following paragraphs. Positions 4-7 designate transmitter address for applications requiring more than one FSk unit (Table 7-2). Switch position 8 is unused and should be left in the '0' (ON) position.

7.1.1 LCp-40 Digi System Network.

Up to 16 FSk-40 transmitters can be networked to the LCp-40 Network Controller. The half duplex format used to run the network is designed to provide remote operation of gross, net, tare, zero, calibration/set-up, and diagnostics, at high speed. This format is not intended for direct interface with a terminal or computer. The baud rate is selectable to accommodate systems with very long (low baud) or short (high baud) distances between FSk units.

7.1.2 Standard Simplex Output (Continuous Output).

The simplex output format is designed to transmit gross weight data (ASCII coded) to a remote terminal or computer. The accuracy of this point to point, digital communication interface is much greater than simple analog current or voltage approximates. Simplex outputs are transmitted in the format on page 7-2, top left-hand column.

Table 7-1. Serial Interface and Baud Rate Selections

Switch Positions 1 2 3	Baud Rate	Interface
0 0 0	9600	Digi-System Network
1 0 0	28800	Digi-System Network
0 1 0	57600	Digi-System Network
1 1 0	1200	Continuous Output
0 0 1	9600	Continuous Output
1 0 1	1200	Terminal Interface
0 1 1	9600	Terminal Interface
1 1 1	*	Modbus RTU

Table 7-2. FSk-40 Transmitter Address Selections.

Switch Position 4 5 6 7	Address
0 0 0 0	16
1 0 0 0	1
0 1 0 0	2
1 1 0 0	3
0 0 1 0	4
1 0 1 0	5
0 1 1 0	6
1 1 1 0	7
0 0 0 1	8
1 0 0 1	9
0 1 0 1	10
1 1 0 1	11
0 0 1 1	12
1 0 1 1	13
0 1 1 1	14
1 1 1 1	15

7.1.3 Computer/Terminal Interface.

This half duplex (transmit and receive) format is de-signed for two way communication between a single FSk-40, or a network of FSk-40 units, and a computer/terminal. Protocol accommodates all operations such as gross, net, tare, zero, as well as remote filter selection. Use of this format requires customer developed, device specific software to run the various network operations. Table 7-3 defines the terminal interface protocol.

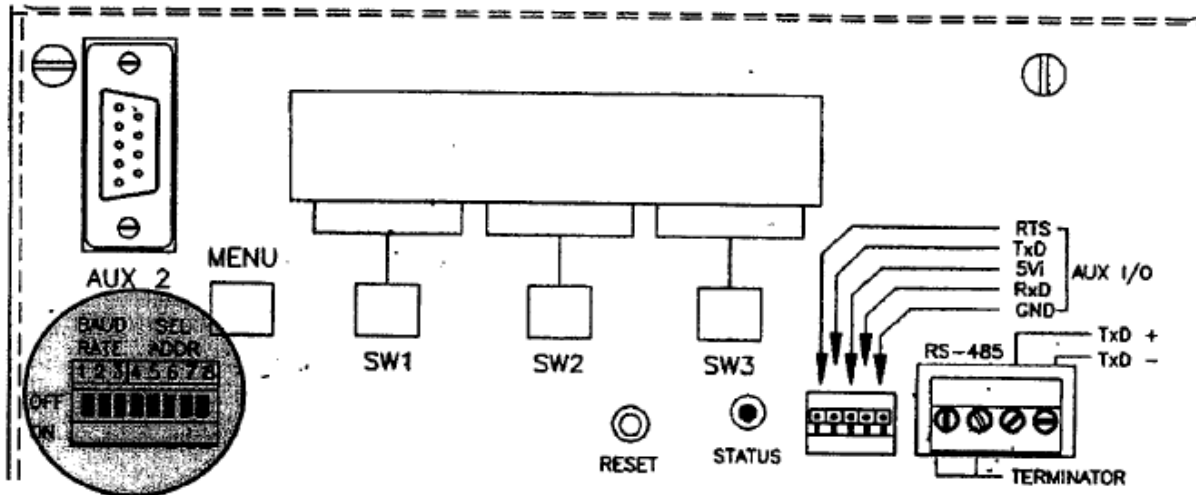

Figure 7-1. Serial Communication Parameter Selection Switch.

STX/ADR/POLJDATA/SP/UNITS/MODE/STATUS/CR/LF

Where:

- STX= 1char. Start of Text (02H)
- ADR= FSk-40 unit address, 3 ASCII characters
- POL= Polarity sign; space for positive data, minus (-) for negative data
- DATA= 7 char; six digits with decimal point or leading space, leading zeros = spaces
- UNITS= 2 char; in demand mode 'LB' or 'KG'
- MODE= 1 char; in continuous mode 'L' or 'K'
- MODE= 2 char; in demand mode, GR (gross), NT (net) TR (tare), or ZR (zero0)
- MODE= 1 char; in continuous mode, G (gross), N (net) T (tare), or Z (zero)
- STATUS= 1char; M (motion), O (overload), or E (Error)
- CR/LF= 2 char; carriage return, line feed (0DH/0AH)
- SP= 1 char; ASCII space (20H)

Total bits per character = 1 start, 1 even parity, 7 data, and one stop.

Table 7-3. Computer/Terminal Interface Protocol.

ASCII Command	Description	Action	Response
'G'	GROSS	Switch to Gross mode	'01 0 LG' [adr/pol/data/sp/units/'G'/stat/CRLF]
'N'	Net	Switch to Net mode	'01 0 LN' [adr/pol/data/sp/units/'N'/stat/CRLF]
'T'	Tare	Switch to Net mode & Tare	'01 0 LN' [adr/pol/data/sp/units/'N'/stat/CRLF]
'Z'	Zero	Switch to gross mode and Zero	'01 0 LG' [adr/pol/data/sp/units/'G'/stat/CRLF]
'W'	Weight	Send Current Weight	'01 0 LG/N' [adr/pol/data/sp/units/mode/stat/CRLF]
'RT'	Recall Tare	Send Current Tare Value	'01 0 LT' [adr/pol/data/sp/units/'T'/stat/CRLF]
'RZ'	Recall Zero	Send Current Zero Value	'01 0 LZ' [adr/pol/data/sp/units/'Z'/stat/CRLF]
'QT'	Quad Tare	Send Individual Tare Values	'01 + 0 + 0 + 0 + 0 LT' [adr/pol/data/sp(for cells 1-4)/units/'T'/stat/CRLF]
'QZ'	Quad Zero	Send Individual Zero Values	'01 + 0 + 0 + 0 + 0 LZ' [adr/pol/data/sp(for cells 1-4)/units/'Z'/stat/CRLF]
'QG'	Quad Gross	Send Individual Gross Values	'01 + 0 + 0 + 0 + 0 LG' [adr/pol/data/sp(for cells 1-4)/units/'G'/stat/CRLF]
'QN'	Quad Net	Send Individual Net Values	'01 + 0 + 0 + 0 + 0 LN' [adr/pol/data/sp(for cells 1-4)/units/'N'/stat/CRLF]
'QV'	Quad mV/V	Send Individual mV/V Values	'01 + 0 + 0 + 0 + 0 0 MV' [adr/pol/data/sp(for cells 1-4)/units/'MV'/stat/CRLF]
'Q%'	Quad Percent	Send Individual %Load Values	'01 + 0 + 0 + 0 + 0 0 %L' [adr/pol/data/sp(for cells 1-4)/units/'%L'/stat/CRLF]

Table 7-3 con't. Computer/Terminal Interface Protocol.

ASCII Command	Description	Action	Response
'Sax'	Set Band Filter: where x=1: 0.5 seconds x=2: 1 second x=3: 2 seconds x=4: 4 seconds x=5: 8 seconds x=6: 16 seconds x=7: 32 seconds x=8: 64 seconds	Set New Band Filter: notes 1 & 2	
'SSnx'/CR	Set Setpoint 'n' Value n=setpoint #, x=value (up to 7 ASCII chrs followed by CRLF)		
'RF'	Recall Serial Format		'01 RFxxxxx'/CRLF
'RL'	Recall Filter Length		'01 RLx'/CRLF
'RB'	Recall Filter Band		'01 RBxxx'/CRLF
'RR'	Recall Filter Response		'01 RRxxx'/CRLF
'RA'	Recall Band Averaging		'01 RAx'/CRLF
'RSn'	Recall Setpoint # Value		'01 RSxxxxxxxx'/CRLF
'R0'	Recall Set Point Outputs(xxxx=setpts 4-1) x='0' if setpoint off x='1' if setpoint on		'01 R0xxxx'/CRLF
'Axx'	Address '01' - '16'	Enable Addressed FSK-40 To Communicate All Others, Disabled	

Note 1 Remote filter settings are not stored in EEPROM and will revert to EEPROM settings upon power down.

Note 2 Remote filter length is averaging applied to raw data before band or response is applied. Remote filter band has its own variable filter (band filt) which is applied to delta data that remains within the +/- band. Data remains within the band if the difference between the current data and the last averaged data is less than or equal to the band setting.

Remote filter response setting is added to the noise band setting. If the change in value from one conversion to the next exceeds the noise band and falls within the response band, the following takes place: the first time data falls within the response band, the full noise band filter is applied. If, on subsequent conversions, the change in value still falls within the response band, the noise band filter is progressively reduced until it reaches a length of 50 msec, at which point the noise band filter is restarted at the current weight value.

When changing data is outside both the noise and response bands, the noise band filter is reset and restarted.

Abbreviations:

- adr address, 3 ASCII chrs: first two are '01' - '16' followed by an ASCII space
- pol polarity: ascii plus or minus sign
- data weight data: 7/8 characters, 6/7 digits w/decimal point or leading space
- sp ascii space (20H)
- units one character: L=pounds, K=kilograms
- mode one character: G=gross, N=net
- stat weigh status: M=motion, O=overload, E=diagnostic error, space=normal
- CRLF carriage return line feed: two characters 0DH 0AH
- '' single quotes: ASCII character string

Table 7-3 con't. Computer/Terminal Interface Protocol.

ASCII Command	Description	Action	Response
'QB'	Quad Balance	Send Individual %Balance Values	'01 + 0 + 0 + 0 + 0 0 %B' [adr/pol/data/sp(for cells 1-4)/units/'%B'/stat/CRLF]
'D%'	Diag. % Load Shift	Send Current % Load Shift	'01 +0.00 +0.00 +0.00 +0.00 D%' [adr/pol/data/sp(for cells 1-4)/units/'D%'/stat/CRLF]
'DZ'	Diag. Zero Shift	Send Current Zero Shift	'01 + 0 + 0 + 0 + 0 0 DZ' [adr/pol/data/sp(for cells 1-4)/units/'DZ'/stat/CRLF]
'D+'	Diag. + Drift	Send Positive Cell Drift	'01 + 0 + 0 + 0 + 0 0 D+ ' [adr/pol/data/sp(for cells 1-4)/units/'D+ '/stat/CRLF]
'D-'	Diag. - Drift	Send Negative Cell Drift	'01 - 0 + 0 + 0 + 0 0 D- ' [adr/pol/data/sp(for cells 1-4)/units/'D- '/stat/CRLF]
'DN'	Diag. Noise Imbalance	Send Current Std. Dev. (adding 2 decimal places)	'01 + 0 + 0 + 0 + 0 0 Dn ' [adr/pol/data/sp(for cells 1-4)/units/'DN'/stat/CRLF]
'DE'	Diag. Errors	Send Current Diagnostic Errors	'01 LZDNO LZDNO LZDNO LZDNO', CRLFw Error for cells 1 - 4 L = Load Shift Z = Zero Shift D = Cell Drift N = Noise Imbalance O = Overload _ = No Error
'SC'	Set Continuous	Send Constant Weight Data Transmission	[adr/pol/data/sp/units/mode/stat/CRLF]
'SD'	Set Demand	Weight Data Upon Request	
'SFxxxxx'	Set Serial Format: where Xxxxxx 0= 6 digits data 1= 7 digits data xXxxxx 0= leading spaces 1= leading zeros xxXxxx 0= decimal point 1= no decimal point xxxXxx 0= units (L/K) 1= no units xxxxXx 0= mode (G/N) 1= no mode xxxxxX 0= status 1= no status	Changes To Serial Data Format	
'SLx'	Set Filter Length x=1: filter 50 ms x=2: filter 100 ms x=3: filter 200 ms x=4: filter 400 ms x=5: filter 800 ms x=6: filter 1600 ms x=7: filter 3200 ms x=8: filter 6400 ms	Enter or Alter Filter Length	
'SBxxx'	Set NoiseBand xxx= 000 to 250 display counts	Enter/Alter Noise Band	
'SRxxx'	Set Response Band xxx= 000 to 250 x 50 ms (0 to 12,500 ms max)	Enter/Alter Response Band	

7.1.4 MODBUS Protocol

This interface method is applicable to virtually any PLC or other process control computer with MODBUS communication capability. The interface provides weight and diagnostics information and allows for remote computer control of tare, zero, and gross/net functions as well as the ability to download new calibration data and set point values. Information is transmitted in blocks of data thereby minimizing polling and response delays. The interface operates with the FSk-40 configured as the slave device and the host computer as the master. Table 7-4 presents a complete overview of register and bit allocations for each MODBUS format. Figure 7-2 (page 7-9) presents the interface baud rate and parity selections.

MODBUS Functions Supported:

- 02 Read Input Status
- 03 Read Holding Registers
- 06 Preset Single Register
- 16 (10 Hex) Preset Multiple Registers

FSk-40 Data Formats Provided:

- FORMAT #1: One 16 bit signed integer - 32768 to 32767 for all weight data mv/v data is divided by 10
- FORMAT #2: Two 16 bit signed integers for most weight data (the two integers must be added together to get -65536 to 65534) One 16 bit signed integer for diagnostic & %data One 16 bit signed integer for mv/v data (divided by 10)
- FORMAT #3: Two 16 bit signed integers for all weight data (the high word, 1st integer, must be multiplied by 32768.0 then added to the low word, 2nd integer)

Table 7-4 FSk-40 Read/Write Register Allocations

DXP40 READ ONLY REGISTERS

(Function 03) READ ONLY ITEM	FORMAT #1 ADR #REG	FORMAT #2 ADR #REG	FORMAT #3 ADR #REG
1 - STATUS 3	40001 1	40201 1	40401 1
2 - STATUS 2	40002 1	40202 1	40402 1
3 - STATUS 1	40003 1	40203 1	40403 1
4- GROSS	40004 1	40204 2	40404 2
5 - NET	40005 1	40206 2	40406 2
6 - GROSS CELL 1	40006 1	40208 2	40408 2
7 - GROSS CELL 2	40007 1	40210 2	40410 2
8 - GROSS CELL 3	40008 1	40212 2	40412 2
9 - GROSS CELL 4	40009 1	40214 2	40414 2
10 - NET CELL 1	40010 1	40216 2	40416 2
11 - NET CELL 2	40011 1	40218 2	40418 2
12- NET CELL 3	40012 1	40220 2	40420 2
13 - NET CELL 4	40013 1	40222 2	40422 2
14- MV/V/10 CELL 1	40014 1	40224	40424 2
15 - MV/V/10 CELL 2	40015 1	40225	40426 2
16- MV/V/10 CELL 3	40016 1	40226	40428 2
17 - MV/V/10 CELL 4	40017 1	40227	40430 2
18- % LOAD CELL 1	40018 1	40228	40432 1
19 - % LOAD CELL 2	40019 1	40229	40433 1
20- % LOAD CELL 3	40020 1	40230	40434 1
21 - % LOAD CELL 4	40021 1	40231	40435 1
22- PEAK TOTAL	40022 1	40232 2	40436 2
23 - PEAK CELL 1	40023 1	40234 2	40438 2
24 - PEAK CELL 2	40024 1	40236 2	40440 2
25 - PEAK CELL 3	40025 1	40238 2	40442 2
26 - PEAK CELL 4	40026 1	40240 2	40444 2
27- TARE	40027 1	40242 2	40446 2

28 - TARE CELL 1	40028	1	40244	2	40448	2
29 - TARE CELL 2	40029	1	40245	2	40450	2
30 - TARE CELL 3	40030	1	40246	2	40452	2
31 - TARE CELL 4	40031	1	40250	2	40454	2
32 - ZERO	40032	1	40252	2	40456	2
33 - ZERO CELL 1	40033	1	40254	2	40458	2
34- ZERO CELL 2	40034	1	40256	2	40460	2
35 - ZERO CELL 3	40035	1	40258	2	40462	2
36- ZERO CELL 4	40036	1	40260	2	40464	2
37- % SENSITIVITY CELL 1	40037	1	40262	1	40466	1
38- % SENSITIVITY CELL 2	40038	1	40263	1	40467	1
39- % SENSITIVITY CELL 3	40039	1	40264	1	40468	1
40 - % SENSITIVITY CELL 4	40040	1	40265	1	40469	1
41 - % LOAD SHIFT CELL 1	40041	1	40266	1	40470	1
42 - % LOAD SHIFT CELL 2	40042	1	40267	1	40471	1
43 - % LOAD SHIFT CELL 3	40043	1	40268	1	40472	1
44- % LOAD SHIFT CELL 4	40044	z	40269	1	40473	1
45 - POS DRIFT CELL 1	40045	1	40270	1	40474	1
46 - POS DRIFT CELL 2	40046	1	40271	1	40475	1
47- POS DRIFT CELL 3	40047	1	40272	1	40476	1
48 - POS DRIFT CELL 4	40048	1	40273	1	40477	1
49- NEG DRIFT CELL 1	40049	1	40274	1	40478	1
50 - NEG DRIFT CELL 2	40050	1	40275	1	40479	1
51 - NEG DRIFT CELL 3	40051	1	40276	1	40480	1
52 - NEG DRIFT CELL 4	40052	1	40277	1	40481	1
53 - NOISE CELL 1	40053	1	40278	1	40482	1
54 - NOISE CELL 2	40054	1	40279	1	40483	1
55 - NOISE CELL 3	40055	1	40280	1	40484	1

Table 7-4 con't. Status Register Bit Definitions.

STATUS REGISTER DEFINITIONS (Function, 03)

STATUS 1 (GENERAL STATUS)

- BIT 0- ACTIVE FILTER, (0) = FILTER 1, (1) = FILTER 2
- BIT 1 - MOTION
- BIT 2 - UNABLE TO TARE/ZERO BECAUSE OF MOTION
- BIT 3 - UNABLE TO ZERO BECAUSE OF LIMIT
- BIT 4 - IN CAL
- BIT 5- DIAG ERROR
- BIT 6- LIMIT OVERLOAD
- BIT 7- A/D OVERLOAD
- BIT 8 - LOST TARE BIT
- 9- LOST ZERO
- BIT 10- POWERUP
- BIT 11 - SPARE (0)
- BIT 12 - SPARE (0)
- BIT 13 - SPARE (0)
- BIT 14 - SPARE (0)
- BIT 15 - SPARE (0)

STATUS 2

- BIT 0 - NA
- BIT 1 - NA
- BIT 2- NA
- BIT 3 - NA
- BIT 4 - OVERLOAD LIMIT CELL 1
- BIT 5 - OVERLOAD LIMIT CELL 2

- BIT 6- OVERLOAD LIMIT CELL 3
- BIT 7- OVERLOAD LIMIT CELL 4
- BIT 8- A/D UNDERLOAD CELL 1
- BIT 9- A/D OVERLOAD CELL 1
- BIT 10- A/D UNDERLOAD CELL 2
- BIT 11 - A/D OVERLOAD CELL 2
- BIT 12- A/D UNDERLOAD CELL 3
- BIT 13- A/D OVERLOAD CELL 3
- BIT 14- A/D UNDERLOAD CELL 4
- BIT 15 - A/D OVERLOAD CELL 4

STATUS 3 (DIAGNOSTIC ERRORS)

- BIT 0- LOAD SHIFT CELL 1
- BIT 1 - LOAD SHIFT CELL 2
- BIT 2 - LOAD SHIFT CELL 3
- BIT 3 - LOAD SHIFT CELL 4
- BIT 4 - ZERO SHIFT CELL 1
- BIT 5 - ZERO SHIFT CELL 2
- BIT 6- ZERO SHIFT CELL 3
- BIT 7 - ZERO SHIFT CELL 4
- BIT 8 - DRIFT CELL 1
- BIT 9 - DRIFT CELL 2
- BIT 10- DRIFT CELL 3
- BIT 11 - DRIFT CELL 4
- BIT 12- NOISE CELL 1
- BIT 13 - NOISE CELL 2
- BIT 14 - NOISE CELL 3
- BIT 15 - NOISE CELL 4

Table 7-4 (cont.) FSk-40 Read/Write Register Allocations

Read/Write Command*	Format #1 ADR #REG	Format #2 ADR #REG	Format #3 ADR itREG
SETPOINT 1	40101	40301 1	40501 1
SETPOINT 2	40102 1	40302 2	40502 2
SETPOINT 3	40103 1	40304 2	40504 2
SETPOINT 4	40104 1	40306 2	40506 2
FILTER 1 LENGTH	40105 1	40308 2	40508 2
FILTER 1 BAND	40106 1	40310 1	40510 1
FILTER 1 RESPONSE	40107 1	40311 1	40511 1
FILTER 1 BAND AVERAGE	40108 1	40312 1	40512 1
FILTER 1 MOTION	40109 1	40313 1	40513 1
FILTER 1 MOTION TIMER	40110 1	40314 1	40514 1
FILTER 2 LENGTH	40111 1	40315 1	40515 1
FILTER 2 BAND	Reserved for possible future		
FILTER 2 RESPONSE	Reserved for possible future		
FILTER 2 BAND AVERAGE	Reserved for possible future		
FILTER 2 MOTION	Reserved for possible future		
FILTER 2 MOTION TIMER	Reserved for possible future		
DIAG SHIFT LIMIT	40118 1	40322 1	40522 1
DIAG ZERO SHIFT LIMIT	40119 1	40323 2	40523 2
DIAG DRIFT LIMIT	40120 1	40325 1	40525 1
DIAG NOISE LIMIT	40121 1	40326 1	40526 1
OVERLOAD CELL	40122 1	40327 2	40527 2
OVERLOAD CELL 2	40123 1	40329 2	40529 2
OVERLOAD CELL 3	40124 1	40331 2	40531 2
OVERLOAD CELL 4	40125 1	40333 2	40533 2

COMMAND

01 = TARE net weight
02 = ZERO gross weight

SETPOINT

any pos weight value

DIAG SHIFT

0 - 99 (0% -

DIAG ZERO SHIFT LIMIT

DIAG DRIFT LIMIT

DIAG NOISE LIMIT

any pos weight value

0 - 99 counts

0 - 99 counts

FILTER LENGTH

00 = 50ms
01 = 100ms
02 = 200ms
03 = 400ms
04 = 800ms
05 = 1600ms
06 = 3200ms
07 = 6400ms

NOISE BAND

0 - 250 counts
ie. if counting
by 2 lbs:
02 = 4 lbs

BAND FILTER

00 = 0.5 seconds
01 = 1 second
02 = 2 seconds
03 = 4 seconds
04 = 8 seconds
05 = 16 seconds
06 = 32 seconds
07 = 64 seconds

MOTION

00 = OFF
01 = 1 count
02 = 2 counts
03 = 3 counts
04 = 5 counts
05 = 10 counts
06 = 20 counts
07 = 50 counts

MOTION TIMER

00 = 1/2 SEC
01 = 1 SEC

OVERLOAD

any pos weight value

02 = 2 SEC
03 = 3 SEC

Table 7-4 (cont.) Input Status Bit Designations

INPUT STATUS DEFINITIONS (Function, 02)

INPUT 1 - ACTIVE FILTER, (0) = FILTER 1, (1) = FILTER 2
INPUT 2- MOTION
INPUT 3 • UNABLE TO TARE/ZERO BECAUSE OF MOTION
INPUT 4- UNABLE TO ZERO BECAUSE OF LIMIT
INPUT 5 - IN CAL
INPUT 6- DIAG ERROR
INPUT 7- LIMIT OVERLOAD
INPUT 8- A/D OVERLOAD
INPUT 9- LOST TARE
INPUT 10- LOST ZERO
INPUT 11- POWERUP
INPUT 12- SPARE
INPUT 13 - SPARE
INPUT 14- SPARE
INPUT 15- SPARE
INPUT 16 - SPARE
INPUT 17- NA
INPUT 18- NA
INPUT 19 - NA
INPUT 20- NA
INPUT 21 - OVERLOAD LIMIT CELL 1
INPUT 22- OVERLOAD LIMIT CELL 2
INPUT 23- OVERLOAD LIMIT CELL 3
INPUT 24- OVERLOAD LIMIT CELL 4

INPUT 25- AID UNDERLOAD CELL 1
INPUT 26- A/D OVERLOAD CELL 1
INPUT 27- A/D UNDERLOAD CELL 2
INPUT 28- A/D OVERLOAD CELL 2
INPUT 29- A/D UNDERLOAD CELL 3
INPUT 30- A/D OVERLOAD CELL 3
INPUT 31 - A/D UNDERLOAD CELL 4
INPUT 32- AID OVERLOAD CELL 4
INPUT 33 - LOAD SHIFT CELL 1
INPUT 34 - LOAD SHIFT CELL 2
INPUT 35 - LOAD SHIFT CELL 3
INPUT 36- LOAD SHIFT CELL 4
INPUT 37- ZERO SHIFT CELL 1
INPUT 38- ZERO SHIFT CELL 2
INPUT 39- ZERO SHIFT CELL 3
INPUT 40- ZERO SHIFT CELL 4
INPUT 41 - DRIFT CELL 1
INPUT 42- DRIFT CELL 2
INPUT 43 - DRIFT CELL 3
INPUT 44- DRIFT CELL 4
INPUT 45- NOISE CELL 1
INPUT 46- NOISE CELL 2
INPUT 47- NOISE CELL 3
INPUT 48 - NOISE CELL 4

MODBUS Configuration Parameters

<p>MENU ■</p>	<p>MODBUS INTERFACE? YES NO EXIT</p> <p>SW1 SW2 SW3</p> <p><input type="checkbox"/> <input type="checkbox"/> <input type="checkbox"/></p>	<p>YES To Configure MODBUS Parameters</p> <p>MENU MENU ... Advance To 'DXP40 Version Information'</p> <p>SW1 YES ... Configure MODBUS Interface</p> <p>SW2 NO ... Go To 'DXP40 Version Information'</p> <p>SW3 EXIT ... Return To Live Operation</p>
<p>MENU ■</p>	<p>BAUDRATE = 9600 STEP MODIFY EXIT</p> <p>SW1 SW2 SW3</p> <p><input type="checkbox"/> <input type="checkbox"/> <input type="checkbox"/></p>	<p>Modify To Select 2400, 4800, 9600, or 19200 Baud</p> <p>MENU MENU ... Return To Previous Display</p> <p>SW1 STEP ... Advance To Parity Selection</p> <p>SW2 MODIFY.. Select Desired Baud Rate</p> <p>SW3 EXIT ... Return MODBUS Interface?</p>
<p>MENU ■</p>	<p>NO PARITY STEP MODIFY EXIT</p> <p>SW1 SW2 SW3</p> <p><input type="checkbox"/> <input type="checkbox"/> <input type="checkbox"/></p>	<p>Modify To Select Parity - NO, ODD, EVEN</p> <p>MENU MENU ... Return To Previous Display</p> <p>SW1 STEP ... Return To MODBUS Interface?</p> <p>SW2 MODIFY.. Select Desired Parity Option</p> <p>SW3 EXIT ... Return To MODBUS Interface?</p>

Figure 7-2. MODBUS Baud Rate and Parity Selections (accessed from main menu).



BLH

**3 Edgewater Drive
Norwood, MA 02062 U.S.A
Phone (781) 298-2200
Fax (781) 762-3988**

www.weighingsolutions.com