

# Weight Indicator TAD 3

From prog. name T002L210



Operating instructions,  
Quick installation



# Contents

## Introduction

General .....	1
Power supply .....	2
Start-up .....	2

## Front panel

General .....	3
Display alternatives .....	4

## Operation

Zero indication and zero setting .....	5
Gross weight .....	5
Net weight .....	5
Taring .....	6
Print function .....	7
Clock set-up .....	7
Instrument name .....	8
Accumulated weight .....	9
Edit levels .....	10
Batching (program option) .....	11
Flow rate (program option) .....	17

## Installation

Mechanical installation .....	19
Electrical installation .....	19
Set-up programme deltaCOM .....	20

## Quick set-up

General .....	21
Common parameters .....	21
Data sheet calibration .....	23
Deadweight calibration .....	27
Zeroing of gross weight .....	30
Parameter survey .....	32

## Appendices

Appendix 1.	Quick set-up list
Appendix 2.	Printout examples



# Introduction

## General

TAD 3 is a high performance weight indicator intended for industrial systems. Its basic function is to convert the signals from strain gauge transducers to useful weight information. Several types of communication interfaces are supported by TAD 3 which makes it easy to integrate the instrument into industrial processes.

The front panel of TAD 3 is flat, dustproof, and waterproof and has a back lighted LCD-display for weight information, set-up information and error messages. It also has function keys and a set of keys for entry of digits and letters.

The basic configuration of Weight indicator TAD 3 performs weighing, printout, and accumulation of weight values. Software options for flow rate measurement and batching can be activated.

'Operating instructions, Quick installation' for TAD 3 includes basic installation and set-up, required for correct measuring with the instrument.

### **This description deals with the following points:**

- Weighing with TAD 3.
- Batching with TAD 3.
- Flow rate measurement.
- Quick installation.
- Installation of deltaCOM.
- Data sheet calibration.
- Deadweight calibration in two points.

Additional installation and set-up of more instrument functions, not covered by this description, can also be performed, for example:

- Complete installation, optional units.
- Complete set-up.
- Setting of communication parameters.
- Shunt calibration, table calibration.
- Level supervision.
- Troubleshooting.

For a complete instrument description, refer to:

**TAD 3      Technical Manual**

## Power supply

Power supply to the weight indicator should not be turned off during week-ends and over-night. Continuous power supply to electronics and transducers prevents moisture condensation in the units.

## Start-up

As soon as power is connected to the instrument, start-up is performed. The text 'TAD 3', the programme name and the unit's serial number will be displayed for some seconds.

Then TAD 3 automatically switches to normal measuring operation.

(If the instrument is set for operator start-up, the text 'Press ENTER to start operation!' will be shown.)

If a warm up time has been set, the text 'Warming up Please wait!' will be displayed before the instrument switches to measuring operation.

If any error is detected, the start-up stops and an error message will be displayed. See section 10. Troubleshooting in 'TAD 3 Technical Manual' for information.

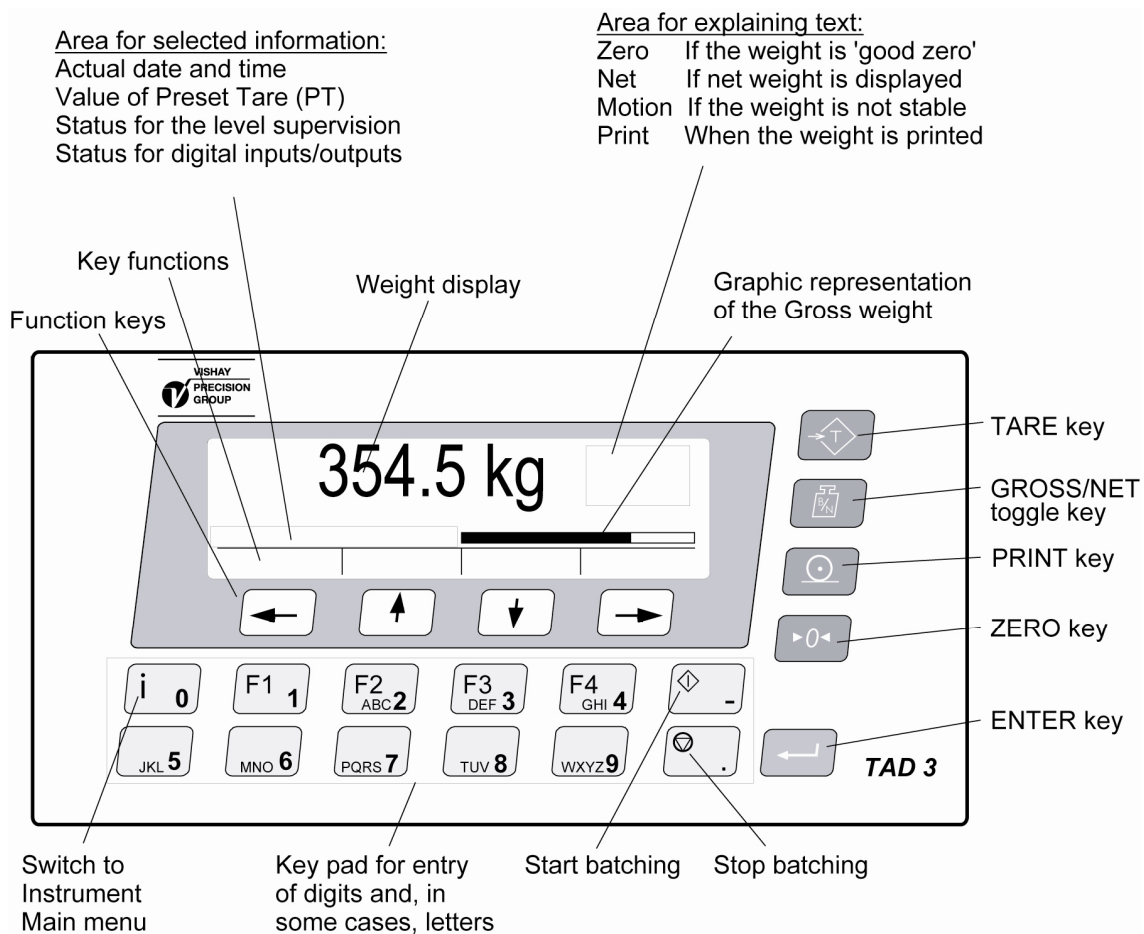

# Front panel

## General

TAD 3 has a flat, dustproof, and waterproof front panel with a back lighted LCD display and all necessary keys to perform weighing, batching, and set-up operations.

## Display

TAD 3 normally displays either gross weight or net weight digitally, and in some cases also gives a graphic representation of the gross weight.

Actual status information for the weight value will also be shown at the display.

Presentation of date and time, Preset tare value, status for digital I/O's or status for the level supervision can also be selected.

If an error occurs this will be indicated by an error code at the display.

## Function keys





Just below the display there are four function keys, marked with arrows. Actual key functions, if any, are indicated at the lower line of the display.

A set of keys for entry of digits and letters is provided, key - (minus) and key . (point) are also used to start and to stop the batching operation.

An ENTER key (  ) to finish the entry of a value etc. is also provided.

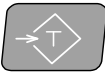
## Symbol keys

To the right of the display four keys are provided, marked with weighing symbols for tare, gross/net, print, and zero.

Key	Name	Function
	TARE	Taring, i.e. entry of the gross weight as auto tare value and display of net weight zero. Depending on actual setting taring may be prevented if 'Motion' is displayed.
	GROSS/NET	Toggling between display of gross weight and net weight. Net weight can be displayed only if a tare value other than zero has been entered.
	PRINT	Printing of the displayed weight value on a connected printer (according to parameter settings in TAD 3) and adding the weight value to accumulated weight 'Printed'.
	ZERO	Setting the gross weight value to zero (provided the value is in the zeroing range: -1 % to +3 % of the capacity) and setting the auto tare value to zero.

## Display alternatives

TAD 3 can be set for continuous presentation of other information together with the weight value.

### 'Level status'

Status of the level supervision can be presented in up to eight boxes below the weight value. The boxes have fixed positions, starting with Level 1 to the left. When a box is shown, corresponding Level is in use.

The Level number will be displayed in the box when the supervised signal level is above the set 'Level' value.

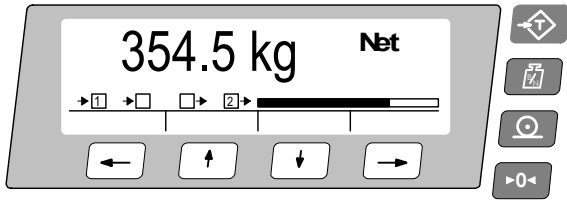

Example: Levels 1, 2, 6, 7, and 8 in use, signal at 1, 6, and 7 above 'Level'.

### 'Preset tare'

The value of Preset Tare (PT) can be presented below the weight value. In that case the graphic representation of the gross weight is not shown.

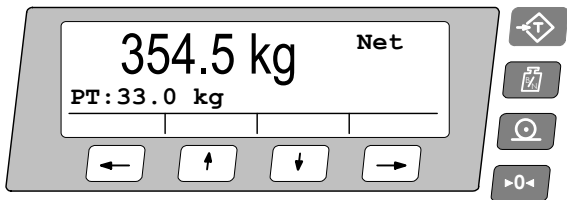

Example: The value of Preset Tare (PT) is 33.0 kg.

### 'Date/Time'

Actual date and time can be presented below the weight value.

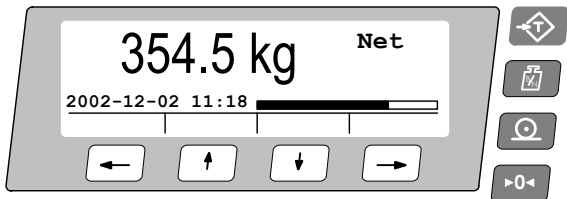

Example: Measurement on December 2, 2002.

### 'I/O status'

Status of the internal digital inputs and outputs can be presented in four boxes below the weight value. For active input/output a digit is shown in the box.

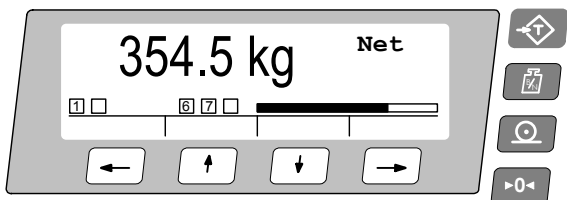

Example: Input 1 and output 2 are active.



# Operation

## Zero indication and zero setting

At installation the instrument has been set to display gross weight zero ('0') when the scale is unloaded. When a 'good zero' is displayed, the text 'Zero' is shown to the right in the display.

If, for unloaded scale, the text 'Zero' is not shown, but the gross weight is close to zero, a fast zero setting can be performed.

## Zero setting

A gross weight close to zero must be displayed, 'Motion' must not be shown, and the key ZERO must be enabled.

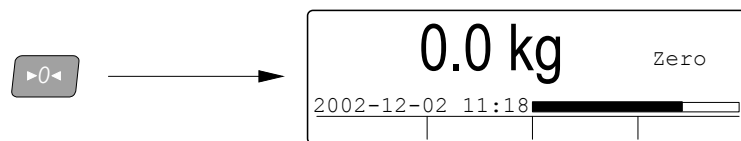

Zero setting can only be performed if the accumulated deviation from the zero setting in the last calibration is within -1 % to +3 % of the 'Capacity'.

In other cases a new zero setting must be executed. See page 30.

## Gross weight

The gross weight is the total weight loaded on the scale after zero setting.

Gross weight is displayed when the text 'Net' is not shown to the right.

When net weight is displayed, the GROSS/NET key can be pressed to change to display of gross weight, provided the GROSS/NET key is enabled.

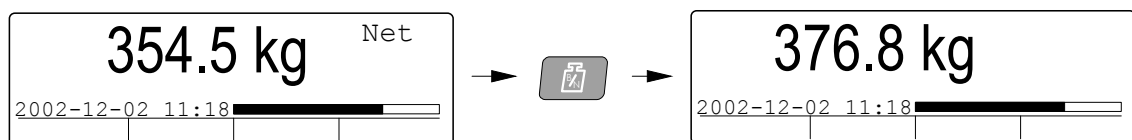

In some cases, gross weight is shown as a graphic bar at the display. Maximum length of the bar corresponds to 'Capacity' of the instrument.

## Net weight

The net weight is the difference between the gross weight and a tare value. If the tare value is zero, net weight can not be displayed.

Net weight is displayed when the text 'Net' is shown to the right.

When gross weight is displayed, the GROSS/NET key can be pressed to change to display of net weight, provided the GROSS/NET key is enabled.

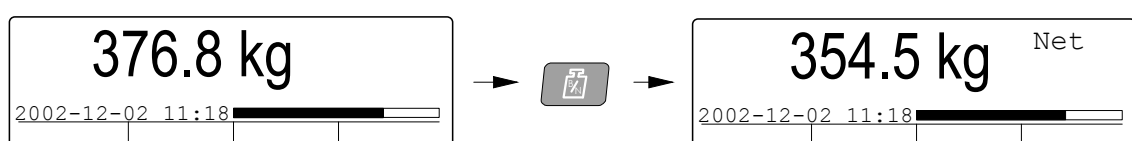

## Taring

Taring means storing in the instrument of a tare value. Net weight will be calculated as the difference between gross weight and this tare value.

In TAD 3 two tare values can be stored, Auto tare and Preset tare.

### Auto tare

By auto taring the actual gross weight is stored as Auto tare value, and TAD 3 will switch to display of net weight 'zero'.

At default setting, auto taring can always be performed, provided the key TARE is enabled. But the instrument can also be set to allow taring only at stable weight (when the text 'Motion' not shown).

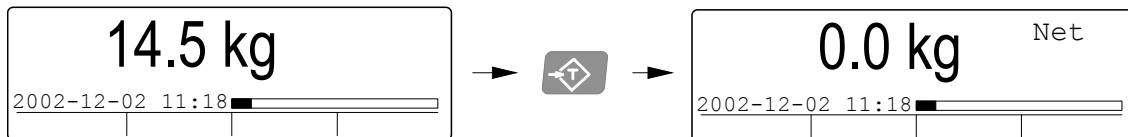

### Preset tare

If TAD 3 is set to use 'Preset tare' for net weight calculation, the 'Preset tare' value can be entered as a numerical value in 'Preset tare', a sub menu to the instrument Main menu (or it can be sent by serial communication from a computer/PLC).

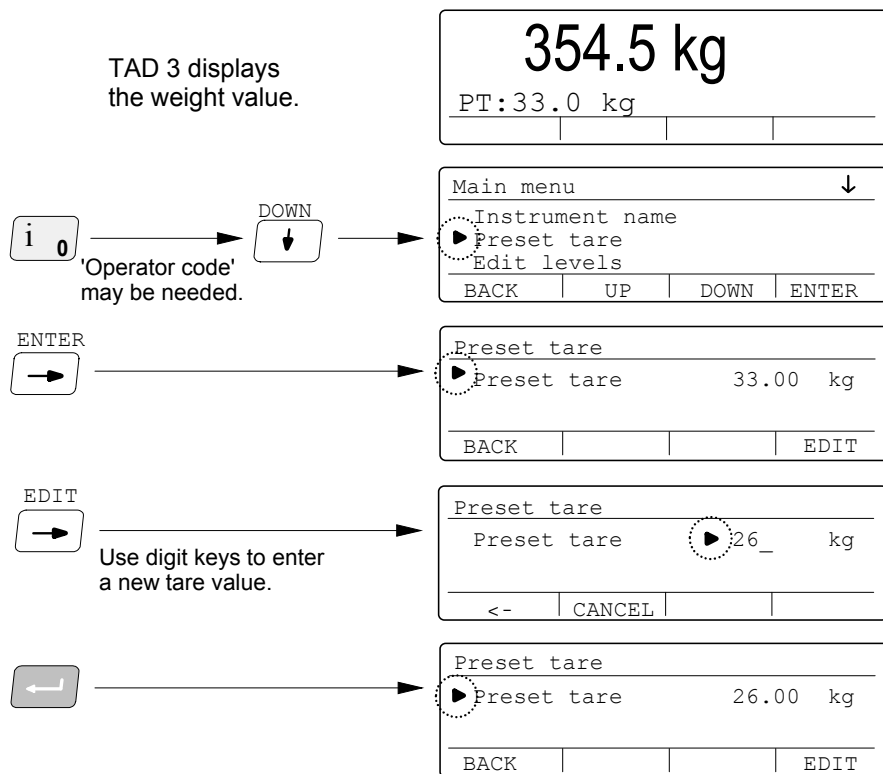

To print the Preset tare value, press the key PRINT (  ) when menu 'Preset tare' is open and editing is not performed.

Press function key BACK to switch TAD 3 back to the instrument Main menu, and then BACK again to switch to display of weight value.

## Print function

To enable the print function, a communication port must be set to 'Printer' or 'Printer 850'. (See TAD 3 Technical Manual.)

When a weight value is displayed, that value can be printed out on a connected printer if the key PRINT is pressed (provided the key PRINT is enabled).

During printout the text 'Print' will be shown.

The printed weight value will also be added to the accumulated weight 'Printed'.

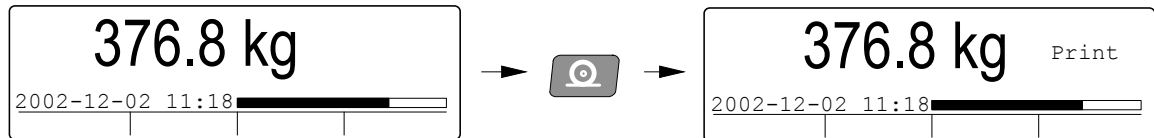

TAD 3 may be set to refuse printing of weight values below a defined level.

It may also be set to refuse printing if the weight is not stable ('Motion' shown). In that case the text 'Print' will be flashing until the weight becomes stable, and then the printing will be performed.

Actual date/time, instrument name, and preset tare may be included in printouts.

## Clock set-up

Date/time information can be presented at the TAD 3 display and added in printouts from the instrument. Setting of correct date and time is performed in 'Clock set-up', a sub menu to the instrument Main menu. 'Clock set-up' can be opened and data edited without interrupting normal weighing operation.

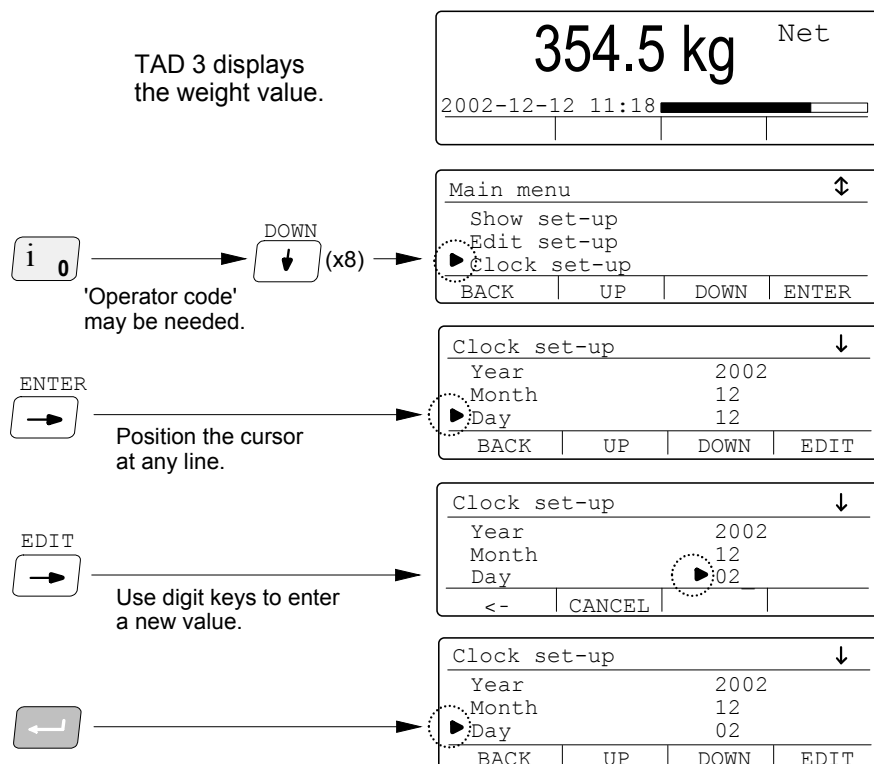

Press function key BACK to switch TAD 3 back to the instrument Main menu, and then BACK again to switch to display of weight value.

## Instrument name

For identification of the instrument, an instrument name can be included in the printouts. Editing of the name is performed in 'Instrument name', a sub menu to the instrument Main menu. 'Instrument name' can be opened and the name edited while TAD 3 performs normal weighing operation.

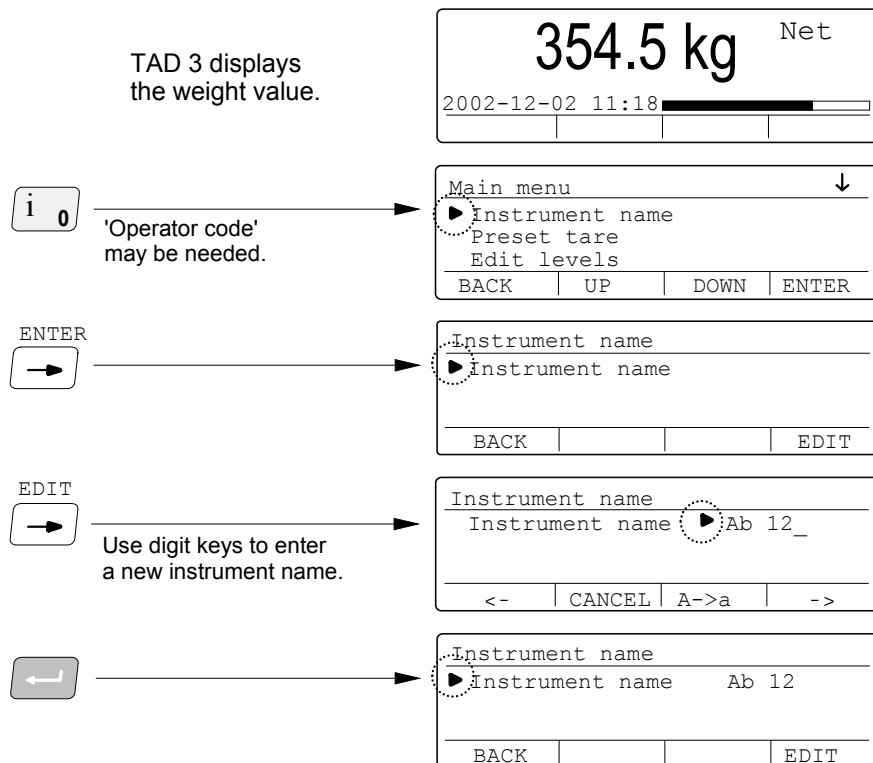

In menu 'Instrument name' both digits, upper-case letters, and lower-case-letters can be entered by the digit keys:

Pressing the same key several times will display the digit and letters of that key, one after the other, at the underscore line.

About one second after the key is pressed for the last time, the displayed character will be entered, a new underscore line is shown, and next character can be entered in the same way.

Use function key 'A -> a' ( 'a -> A' ) to toggle between upper-case letters and lower-case letters.

Press function key ' < - ' to delete the last character.

Press function key ' - > ' to enter a space in the instrument name.

Press function key CANCEL to cancel an editing in progress.

Press key to finish the entry of a new instrument name and make it active.

Press function key BACK to switch TAD 3 back to the instrument Main menu, and then BACK again to switch to display of weight value.

## Accumulated weight

In TAD 3 accumulation of weight values can be performed in accordance with parameter settings in the instrument. All accumulated weights will be presented in 'Accumulated weight', a sub menu to the instrument Main menu. This menu can be opened, and the values printed out or edited, without interrupting normal instrument operation.

### Menu 'Accumulated weight'

By default, only the value 'Printed' is shown in sub menu 'Accumulated weight'. Every time the key PRINT is pressed and the text Print is shown, the actual displayed weight value will be added to the accumulated weight 'Printed'.

When certain optional functions, for example Batching, are activated other accumulated weight values may also be shown.

Here accumulated weight values can be edited (normally set to zero) without interrupting normal weighing operation.

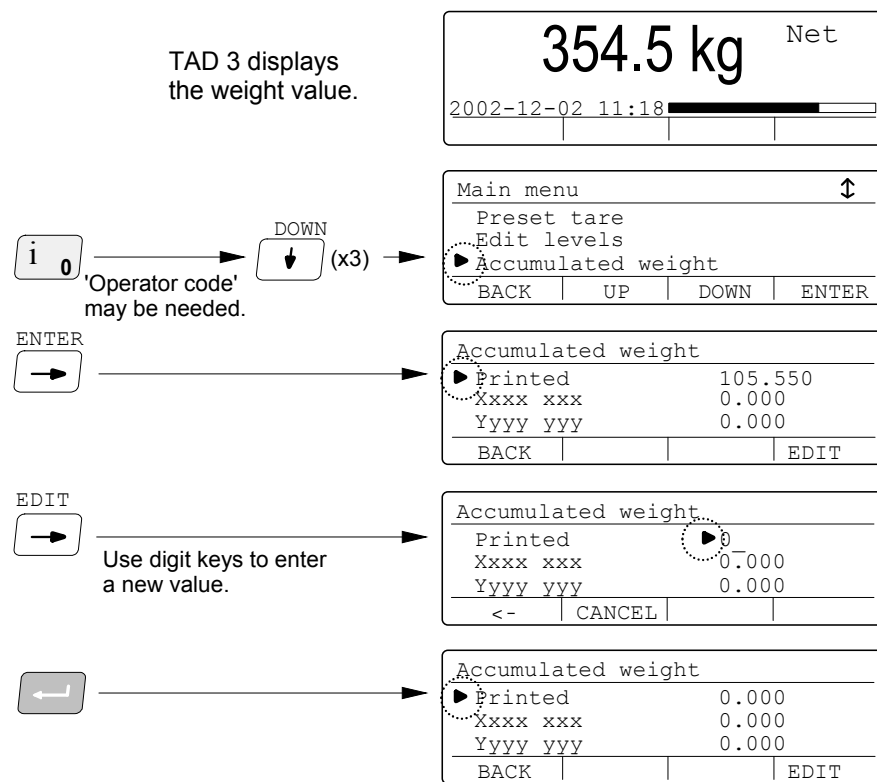

Press function key BACK to switch TAD 3 back to the instrument Main menu, and then BACK again to switch to display of weight value.

### Printout of accumulated weight

All accumulated weight values can be printed out, together with date/time and instrument name, on a connected printer:

Press the key PRINT (  ) when menu 'Accumulated weight' is open and editing is not performed.

See Appendix 2 for printout examples.

## Edit levels

With TAD 3 it is possible to supervise instrument signals at defined levels. In 'Edit levels', a sub menu to the instrument Main menu, the supervision levels and setpoint levels in use, are shown.

Editing of the supervision levels can be performed in this sub menu without interrupting normal weighing operation.

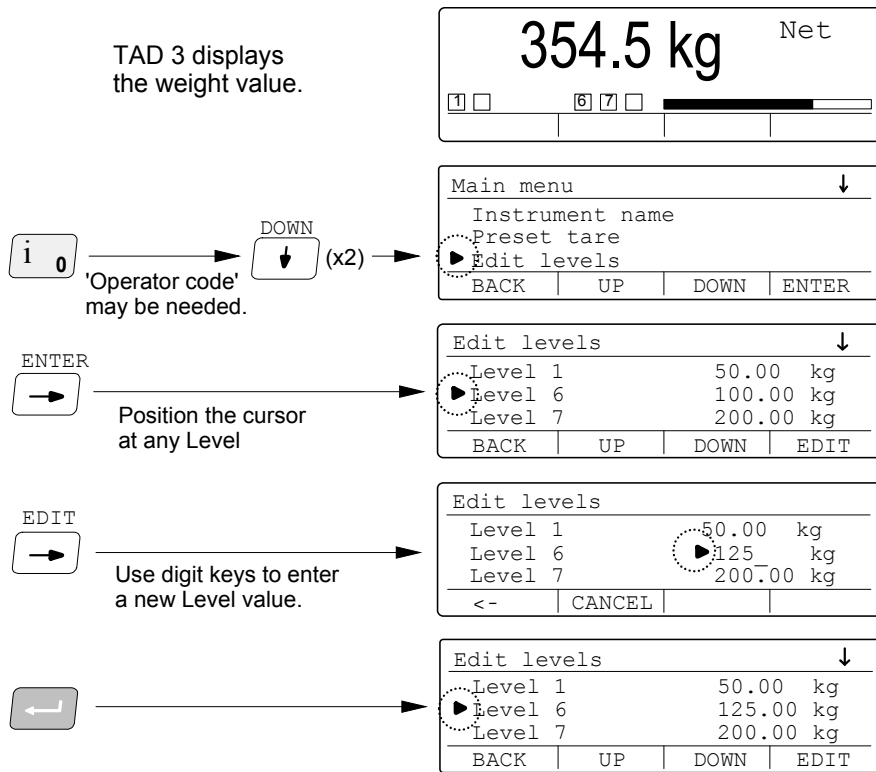

Press function key BACK to switch TAD 3 back to the instrument Main menu, and then BACK again to switch to display of weight value.

### Printout of menu 'Edit levels'

A list of the values for all Levels and Setpoints in use can be printed out, together with date/time and instrument name, on a connected printer:

Press the key PRINT (  ) when menu 'Edit levels' is open and editing is not performed.

See Appendix 2 for printout examples.

## Batching (program option)

Weight indicators TAD 3 from programme name T001A120 have software for option 'Batching' installed. 'Batching' can be activated by a program option code, available from Nobel Weighing Systems. Entry of the code is performed in menu 'Program options' in Edit set-up under the instrument Main menu.

When option Batching is activated, a function key named BATCH is displayed during normal weighing operation.

Print-out and accumulation of the batch weight is performed automatically, in accordance with actual set-up.

Basic batch data, like batched weights (setpoints) and number of batches, can be set by the operator from the front panel.

## Menu Batching

In menu Batching the activities for one batch (A1: to max. A6:) are listed with actual setpoint values. The number of batches (if more than one) and the batch size can also be shown, depending on actual set-up.

Open 'Batching' by pressing function key BATCH,

or by pressing  when the cursor points at line Batching in the instrument Main menu.

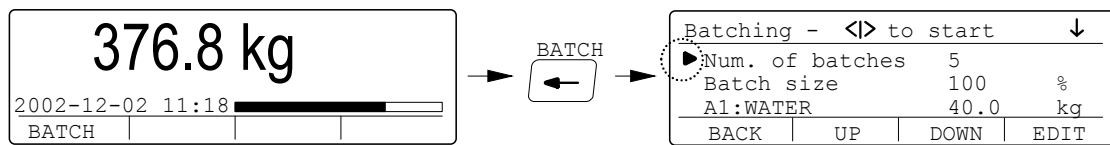

All parameters in menu Batching are numerical and editing should be performed like in the example below.

### Example: Edit the setpoint for activity 1 (A1:).

When menu Batching is displayed, position the cursor (by UP and DOWN) at line 'A1:' and then press function key EDIT.

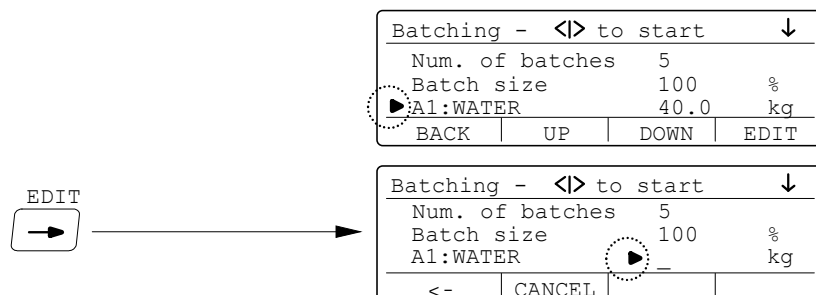

The cursor moves to an underscore line, replacing the parameter value.

Use the digit keys to enter a new setpoint value for activity A1, (the last entered digit can be removed by function key <-).

Press key  to finish the entry and make the new setpoint value active.

## Operation

When the batching operation has been started, TAD 3 will automatically go through the activities for one batch in numerical order. After that weight accumulation and possible printing will be performed. If several batches are ordered, TAD 3 continues the batching operation until all batches are done.

Operation may be interrupted by alarms, by a stop command, or by an activity that demands manual operation.

### Start batching

When menu Batching is displayed, the batching operation can be started

by pressing key **-** (minus), also marked with a green start symbol, .

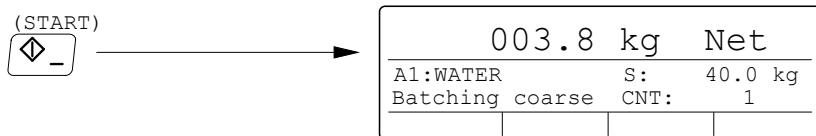

TAD 3 will continuously display the weight (flow) value, while performing the activities.

### Reset alarm

If an alarm occurs the batching operation will be halted and an alarm message will be displayed.

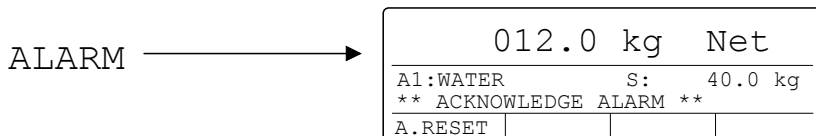

When the cause of the alarm has been cured, function key A.RESET should be pressed to reset the alarm. Then the batching operation can be restarted, or it can be ended in different ways. See next page.

### Restart batching

As batching is halted (and a possible alarm has been reset) the batching operation can be restarted from where it was stopped by function key RESTART at the instrument front panel.

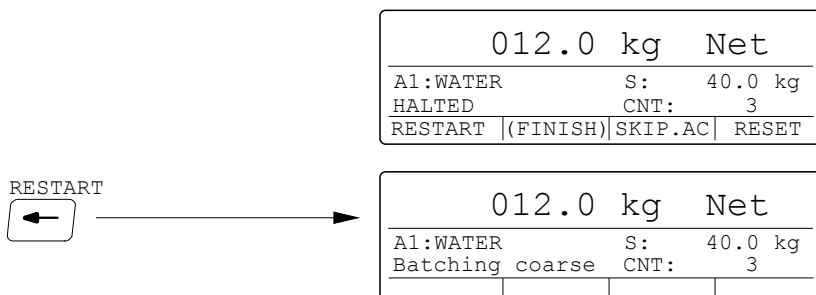



### Stop batching

At any time, the batching operation can be halted from the instrument panel, by pressing key . (point), also marked with a red stop symbol, .



When the batching operation is halted it can be restarted, see previous page. It can also be ended in different ways. See below.

### Finish batching

When a batching operation with several batches is halted (and a possible alarm has been reset) function key FINISH will be available.

If FINISH is pressed TAD 3 will regard the actual batch as the last one and only the remaining activities of the actual batch will be performed before the batching operation is ended.

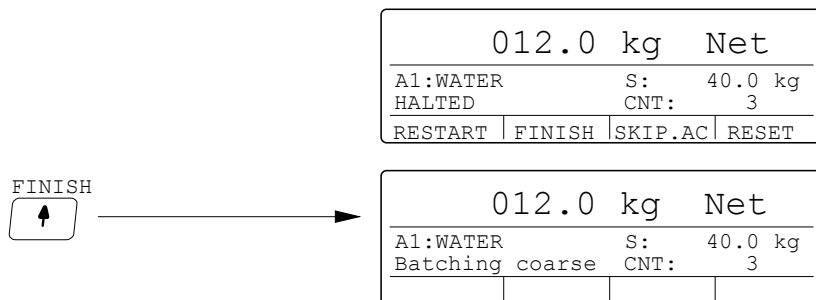

### Skip activity

When a batching operation is halted (and a possible alarm has been reset) function key SKIP.AC will be available. If SKIP.AC is pressed TAD 3 will consider the actual activity as ended, the batched weight value will be accumulated and possibly a report will be printed.

After that the batching operation will continue with the remaining activities of the batch, and the remaining number of batches.

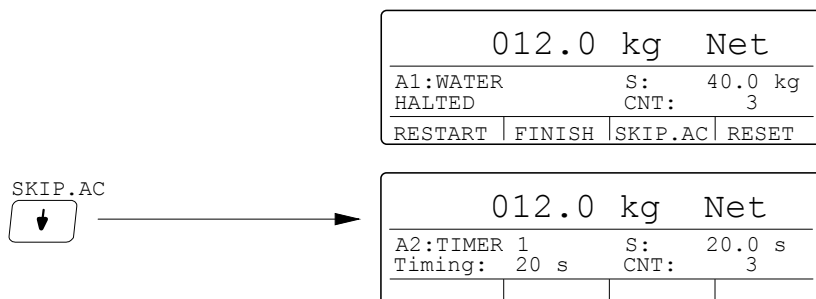

### Terminate batching

When a batching operation is halted (and a possible alarm has been reset) function key RESET can be pressed to end the batching operation.

The weight of material that may have been batched will be accumulated and possibly printed. This will end the batching operation.

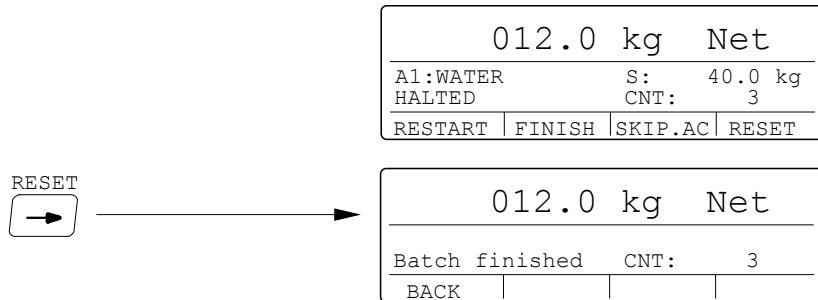

### Manual operation

As the batching sequence comes to a Manual activity it automatically halts to allow manual operation, for example adding of a small quantity of material. Auto taring will be performed so net weight zero will be displayed.

The instrument can be set for weighing of the manually added material.

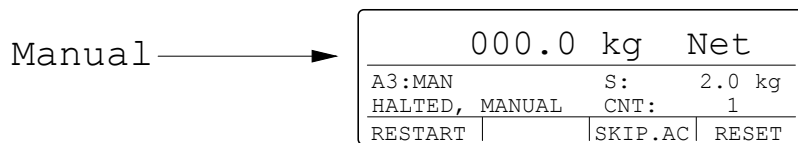

Manually add material to make the displayed weight equal the Setpoint value. Then press function key RESTART to continue the batching operation.

Alternatively the instrument can be set to allow manual entry of the weight value for the added material by the digit keys.

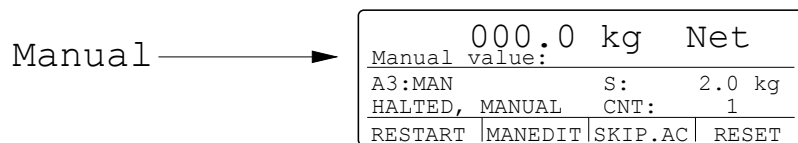

Manually add the amount of material, given as Setpoint value.

Press function key MANEDIT, then use the digit keys to enter the weight value for the added material at 'Manual value: ' and finish the entry by key .  
(If no weight value is entered, the weight value from the scale will be used.)

Finally press function key RESTART to continue the batching.

## Printing

Printing of batch reports will be performed automatically, according to the setting in menu 'Batching parameters'.

For printing of accumulated weight values, see page 9.

Printing of actual batch data (setpoints etc.) can be performed. Press the PRINT key as menu 'Batching' is displayed.

## Batching alarms

When an alarm has been obtained, it must be reset before the batching can be restarted or ended.

### **\*\* SETPOINT ALARM \*\***

**Weigh in:** The vessel, being batched to, does not have sufficient volume to contain the desired quantity of material (the gross weight will exceed Capacity).

**Weigh out:** The contents of the vessel (gross weight) is not sufficient to batch out the desired quantity of material.

### **\*\* ACKNOWLEDGE ALARM \*\***

The alarm is caused by absence of acknowledgement signal.

Instrument behaviour depends on the selected acknowledgement type (**Ack. type**):

**No test:** An alarm is never obtained in this case.

**At start:** An acknowledgement signal was not present at start of activity.

**Wait:** An alarm is never obtained in this case.

**NOTE!** If an acknowledgement signal is not present, the instrument waits for an acknowledgement signal for any length of time, displaying the text 'Checking ack.'

**Continuous:** The acknowledgement signal was cancelled during the activity or was not present at starting.

**Wait+contin.:** Identical to **Wait** until start of activity, after that identical to **Continuous**.

### **\*\* TIMEOUT ALARM \*\***

The activity was not completed within the specified maximum time, set by parameter (**Timeout value**).

### **\*\* MINUS TOLERANCE ALARM \*\***

Batched weight below minus tolerance limit.

### **\*\* PLUS TOLERANCE ALARM \*\***

Batched weight exceeds plus tolerance limit.

### **\*\* UNSTABLE WEIGHT ALARM \*\***

Weight not stable after Wait time (obtained only if **Motion check** is On).

### **\*\* WEIGHT ERROR ALARM \*\***

Incorrect weight (e.g. transducer or weight converter fault).



## Flow rate (program option)

Weight indicators TAD 3 from programme name T002A200 have software installed for the program option 'Flow rate'.

'Flow rate' can be activated by a program option code, available from Nobel Weighing Systems. Entry of the code is performed in menu 'Program options' in

Edit set-up under the instrument Main menu.

When option Flow rate is activated the function key to the right, under the text 'F/W', (or digit key 4, marked F4) can be used to switch between display of weight value and flow rate value.

The instrument can be set to present the weight value at the information line as the flow rate value is displayed, and vice versa. See example below.

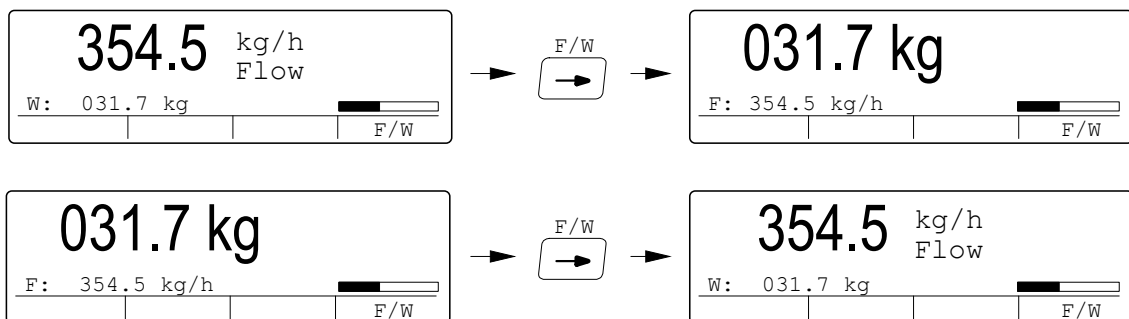

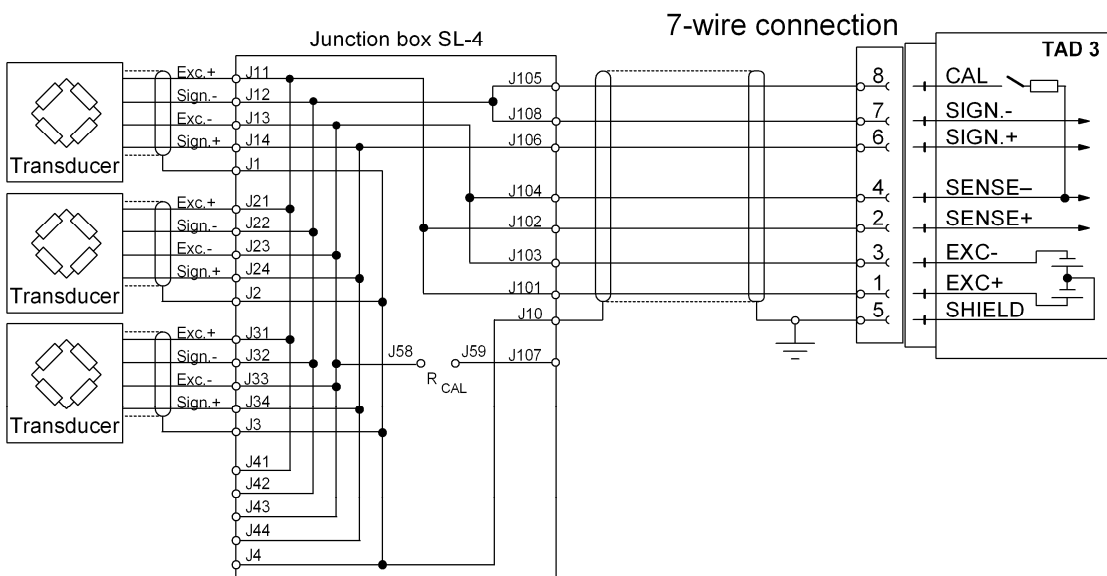
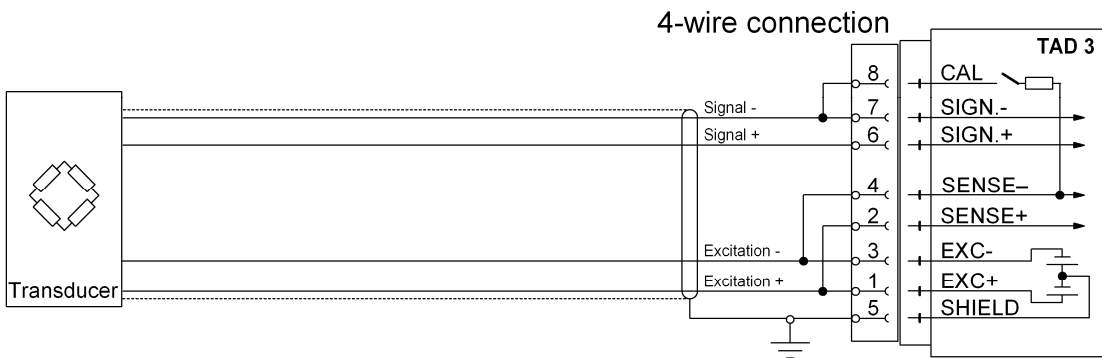
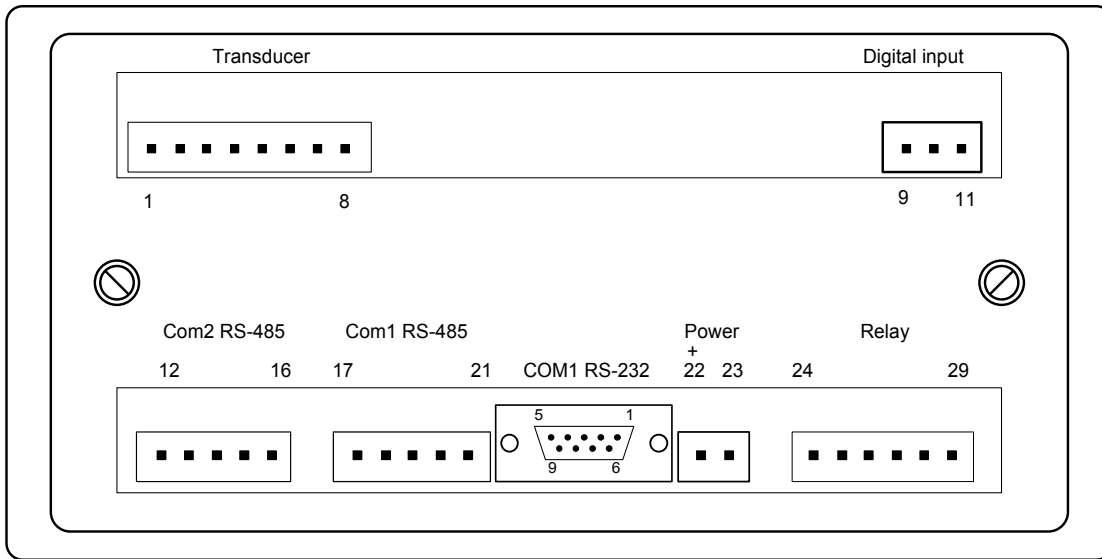

# Installation

## Mechanical installation

Weight Indicator TAD 3 is designed with a smooth housing, mainly for panel mounting. It fits into the same panel cut-out as Weight Indicator E-1-TAD and E-2-TAD. An integrated gasket at the instrument front gives sealed attachment to mounting panels, up to 10 mm thick.

## Electrical installation

All electrical connections to TAD 3, including possible connection to ground, are made via plug-in terminal blocks and D-sub connectors. The installation must be carried out with shielded cables, routed to avoid electromagnetic interference from power cables.

## Transducer input

Terminals 1 – 8.

Transducer connection should be handled with great care to achieve good measuring data. Integrated transducer cables may not be shortened.

### NOTE!

Transducer cables must be routed at least 200 mm away from 230/380 V, 50/60 Hz power cables. By cables with other frequencies or high power, an even wider distance is preferable.

4-wire connection should be used if the integrated transducer cable can be connected directly at TAD 3. By 4-wire connection, some terminals at TAD 3 must be interconnected, see diagram on opposite page.

The cable shield and terminal 5 must be connected to earth in one point.

7-wire connection should be used if the integrated cable must be lengthened or if several transducers should be connected to one TAD 3 unit.

The cable shields and terminal 5 must be connected to earth in one point.

## Power connection

Terminals 22, 23.

Weight indicator TAD 3 should be powered by 20 – 28 V DC, connected to terminal 22 (positive) and terminal 23 (0 V). Nobel Weighing Systems provides a range of rail mounted, mains operated power supplies, intended for various numbers of TAD 3 units.

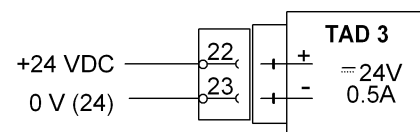

## Serial communication, Com 1

Communication port Com 1 can be used for serial communication with: computer/PLC (Modbus), printer, or external display unit.

Connection alternatives:

Terminals 17 to 21.

Serial communication interface:

RS-485/RS-422 for 2-wire or 4-wire with common earth (COM).

The communication lines must have 120 ohm termination at both ends.

or

9-pole D-sub (socket at TAD 3).

Serial communication interface:

RS-232.

Point to point, only one TAD 3 connected to the computer/PLC, printer, or external display unit.

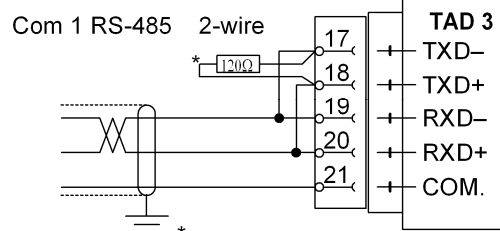
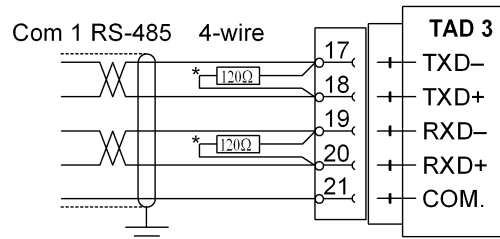

\* Terminating resistor at the last unit on the line.

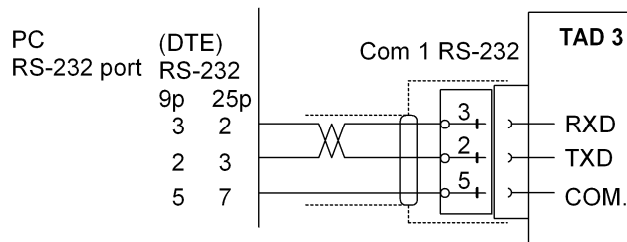

## Serial communication, Com 2

Terminals 12 to 16.

Serial communication interface:

RS-485/RS-422 for 2-wire or 4-wire with common earth (COM).

The communication lines must have 120 ohm termination at both ends.

Communication port Com 2 should be used for serial communication with: computer/PLC (Modbus), printer, external display unit, or optional I/O units.

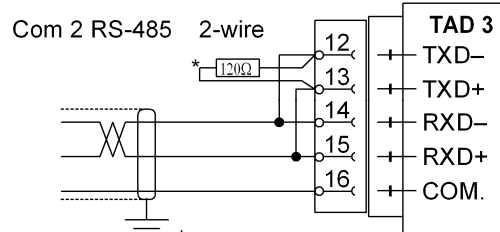
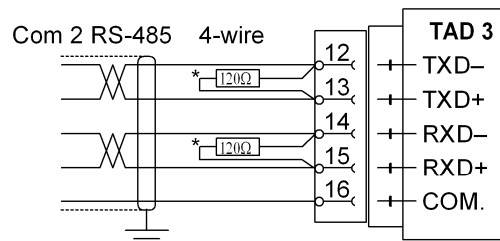

\* Terminating resistor at the last unit on the line.

## Set-up programme deltaCOM

Set-up of operating functions in TAD 3 can be performed from a connected PC with Windows95/98/2000/XP/NT4.0 installed. DeltaCOM comes on a diskette with the TAD 3 delivery. This diskette also contains instructions for connection and set-up of the serial communication between the instrument and the PC.

To install the programme, insert the diskette in the computer, press the 'Start' button and select 'Run...' from the menu, type [drive letter]:\setup in the dialogue box and then follow instructions on the screen.

If nothing else is stated, the programme deltaCOM and a ReadMe file will be found in Start > Program > deltaCOM.

Installing deltaCOM makes it possible to use the PC and serial communication line to show and edit all set-up parameters for the TAD 3 module.



# Quick set-up

## General

All operating functions in TAD 3 are controlled by parameters, stored in the instrument memory. Some settings can be edited in the instrument Main menu during normal weighing operation.

But for the set-up parameters, editing can be performed only in menu 'Edit set-up' when the normal weighing operation is interrupted.

Depending on actual set-up, an 'Operator code' may be needed for entry in the instrument Main menu, and possibly a 'Set-up code' may be needed for parameter editing in menu 'Edit set-up'.

In menu 'Edit set-up', the sub menu 'Quick set-up' is available for a fast adaptation of TAD 3 to the weighing equipment. It contains parameters for data sheet calibration, deadweight calibration in two points, and some parameters common for the two calibration methods.

All parameter values should be noted in the 'Quick set-up list', appendix 1. They may be useful if the instrument must be replaced.

## Common parameters

The parameters in TAD 3 can be protected from editing by security locks at two levels. Four-digit codes that open the locks can be defined by the customer. By default setting the codes for both security locks are: 1 9 3 7 .

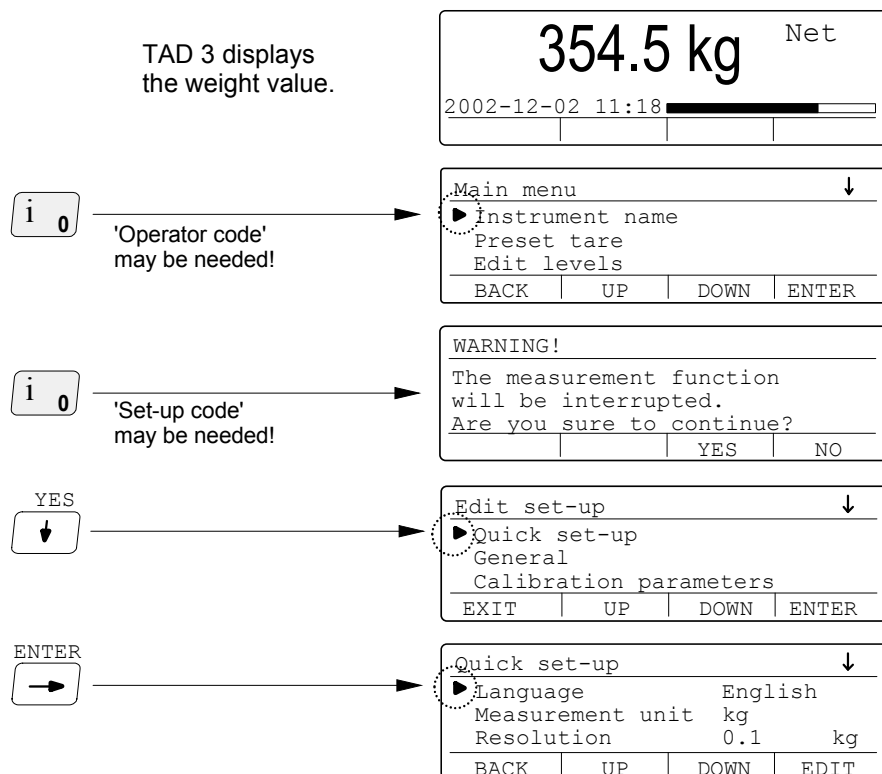

In this menu all 'Quick set-up' parameters can be shown and edited. See illustration on page 32.

**Define the language.**

This parameter defines which language that will be used in the display window. Position the cursor at 'Language'.

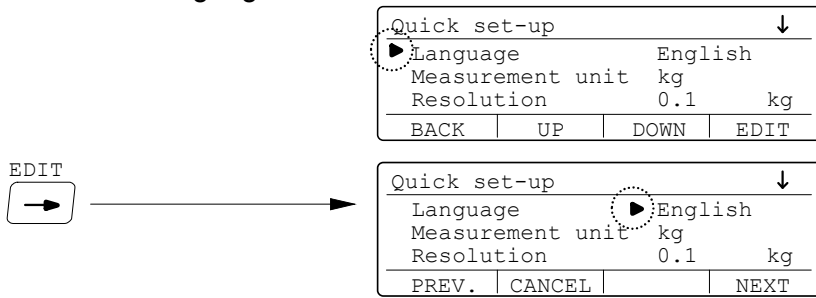

Use NEXT and PREV. to see the alternatives.

Press key to select the displayed alternative and make it active.

**Define the measurement unit.**

This parameter defines the unit that will be used for measurement values and associated parameters.

Position the cursor at 'Measurement unit'.

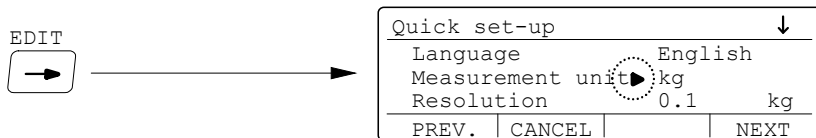

Use NEXT and PREV. to see the alternatives.

Press key to select the displayed alternative and make it active.

**Define the resolution for the scale.**

This parameter defines the smallest change in weight value that will be shown, and the decimal point position for the instrument.

Position the cursor at 'Resolution'.

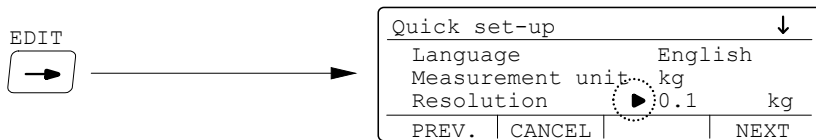

Use NEXT and PREV. to see the alternatives.

Press key to select the displayed alternative and make it active.

**Define the capacity for the scale.**

This parameter defines the biggest weight value that should be displayed by the instrument. The value of 'Capacity' is shown with measurement unit and decimal point position according to the setting above.

Position the cursor at 'Capacity'.

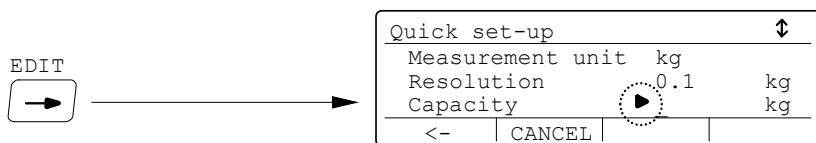

Use the digit keys to enter the new value. Function key <- will delete the last digit.

Press key to finish the entry of capacity and to make it active.

**Select calibration type.**

This parameter defines which calibration type to perform.

Two calibration types are available in the Quick set-up:

‘Data sheet’ calibration for fast calibration when transducer data is available and the installation is free from mechanical disturbances.

‘Deadweight’ calibration, the most accurate calibration type, where known weights are used to give well defined load on the scale.

The calibration type that was used last time is shown in the menu. To perform a new calibration, parameter ‘Calibration type’ must be edited and selected, also if the same calibration type is used again. Position the cursor at ‘Calibration type’.

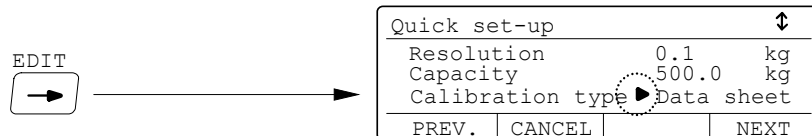

Use NEXT and PREV. to see the alternatives.

Press key to select the displayed alternative.

A question will be displayed: "Do you want to start a new calibration?  
(Current calib. will be lost!)"

and it must be answered by YES or NO.

The choice of calibration type determines which parameters that will appear in the menu.

**Data sheet calibration**

This calibration method can be used when data sheets for the transducers are available, the load is evenly distributed on all supports, and no external forces influence the weighing installation.

Data sheet calibration can be performed without any transducers connected, but the automatic filter time calculation will be correct only if all transducers of the weighing equipment are connected to the instrument.

A data sheet calibration should start with the common parameters, described on previous pages. If calibration type ‘Data sheet’ is selected the following parameters will appear in the menu.

**Define the conversion factor.**

This parameter defines the relationship between a weight value expressed in transducer data sheet unit and the same weight value expressed in measurement unit. The default value, 9.80665, can be used when transducers in N (Newton) are used for weighing in kg.

Position the cursor at ‘Conv. factor’.

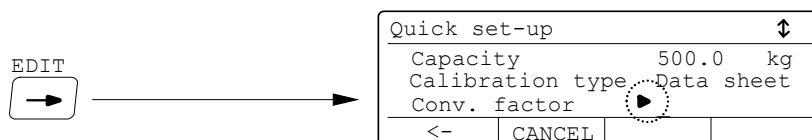

Use the digit keys to enter the new conversion factor, function key <- will delete the last digit.

Press key to finish the entry of a conversion factor and to make it active.

### Define the number of transducers.

This parameter value should be set to the number of support points for the load, including all transducers and fixed support points.

Position the cursor at 'Number of transd'.

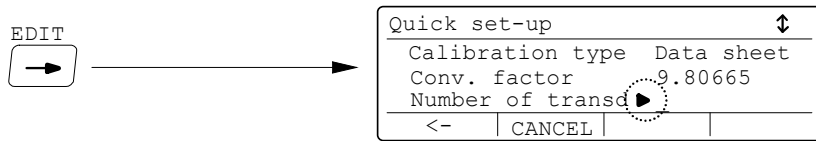

Use the digit keys to enter the number, function key <- will delete the last digit.

Press key  to finish the entry of the number of supports points.

### Define the rated load for a transducer.

Rated load for the transducer is a value, given in the data sheet. All the transducers in the scale must have the same impedance and rated load. The rated load value, expressed in the unit of the data sheet, should be entered for this parameter.

Position the cursor at 'Rated load'.

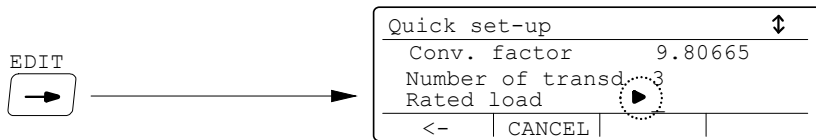

Use the digit keys to enter the value, function key <- will delete the last digit.

Press key  to finish the entry of rated load value and to make it active.

### Define the rated output for the transducers.

This parameter value should be the output signal, in mV/V, for transducer 1.

The value is given in the data sheet. For a fixed support point the rated output should be set to 0.00000 mV/V.

Position the cursor at 'Rated output 1'.

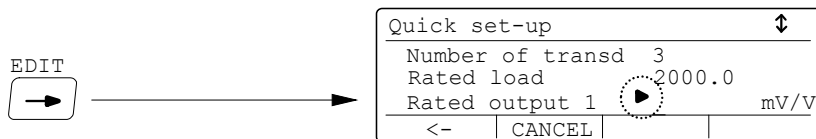

Use the digit keys to enter the value, function key <- will delete the last digit.

Press key  to finish the entry of the rated output signal for transducer 1.

The menu contains 'Rated output' parameters for the defined 'Number of transd'.

Enter the rated output signal value in a similar way for all transducers and fixed support points.

**Store the shunt transducer signal.**

Make sure the scale is unloaded. The shunt transducer signal can be stored in TAD 3, and should be recorded in the 'Quick set-up list', appendix 1.

It can be used later for a calibration check in menu 'Diagnostics'.

Position the cursor at 'Shunt transd.sig'.

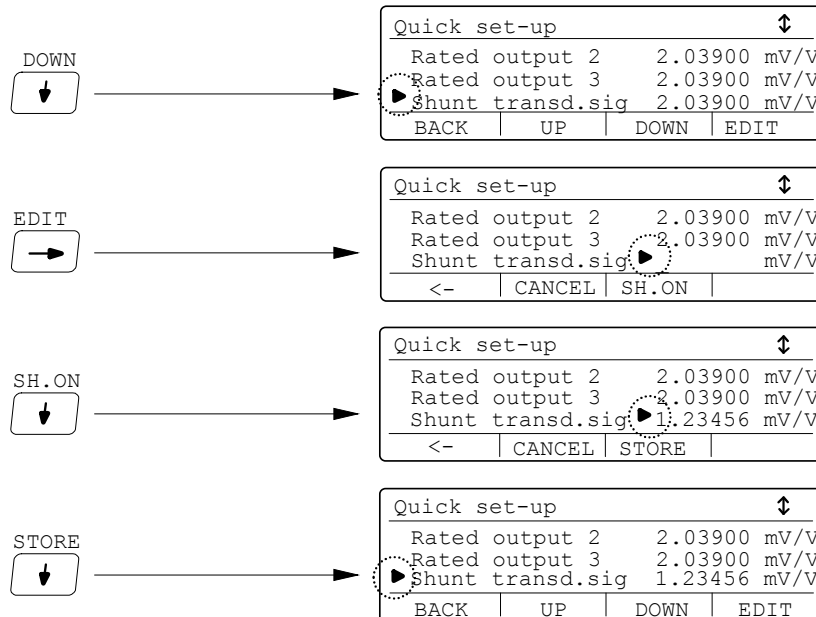

**Setting the gross weight to zero.**

This parameter is used to make the instrument display gross weight zero when the scale is unloaded. Make sure the scale is completely unloaded before this setting is performed.

The parameter value for 'Set zero' is a live weight value for actual zeroing.

Position the cursor at 'Set zero'.

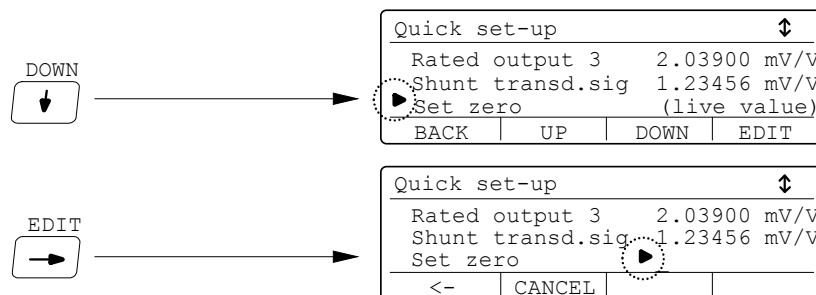

Use the digit keys to enter the zero value (normally 0).

Press key  to finish the zero setting and make it active.

**Read the zero offset.**

The total, accumulated zero offset value for the installation is shown at parameter 'Zero offset', and should be recorded in the 'Quick set-up list', appendix 1.

It will be useful if the instrument must be replaced.

Position the cursor at 'Zero offset'.

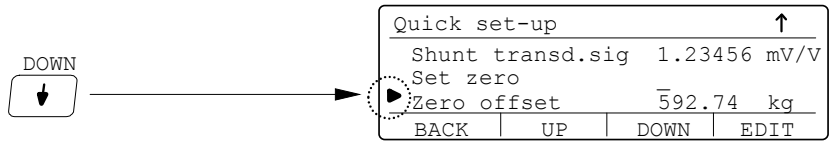

**Terminate the data sheet calibration.**

When the calibration is finished, all edited parameter values can be saved as the operation is terminated. It is also possible to terminate the calibration without saving the new values. In that case all changes during the calibration will be rejected.

Calibration can always be interrupted.

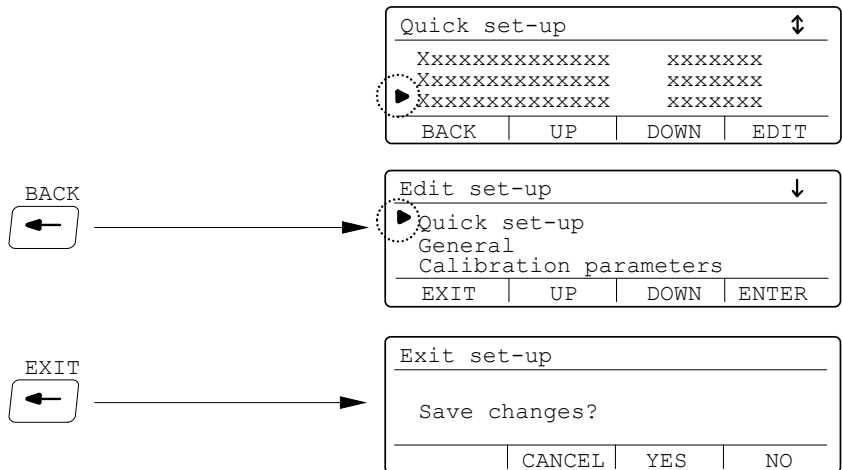

Answer by CANCEL to stay in 'Edit set-up'.

Answer by YES to save the new values in the TAD 3 memory, or by NO to reject the new parameter values.

In both cases TAD 3 switches over to display of weight value.

The scale is now ready for use.

## Deadweight calibration

This is the most accurate calibration method. It requires that known weights to at least two-thirds of the scale capacity are available.

A deadweight calibration should start with the common parameters, described on pages 21 to 23. If calibration type 'Deadweight' is selected the following parameters will appear in the menu.

An asterisk will be shown in the top line as a reminder that new values for the calibration points must be stored. Asterisks will also be shown at the values for the calibration points that has not yet been stored.

### Perform calibration for point 1.

In this calibration point the scale should be unloaded, but prepared for loading with known weights, i.e. hooks, clamping straps etc. should be mounted on the scale.

Position the cursor at 'Value cal. p.1'.

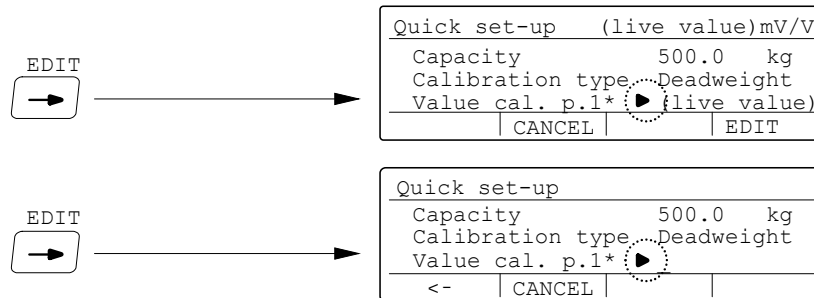

Use the digit keys to enter the actual weight value (= 0 for unloaded scale).

Press key  to finish the entry of weight value for calibration point 1. The asterisk for point 1 disappears.

### Perform calibration for point 2.

In this calibration point the scale should be loaded with known weights to at least two-thirds of its capacity. Any needed hooks, straps etc. must have been mounted on the scale already in calibration point 1, see above.

Position the cursor at 'Value cal. p.2'.

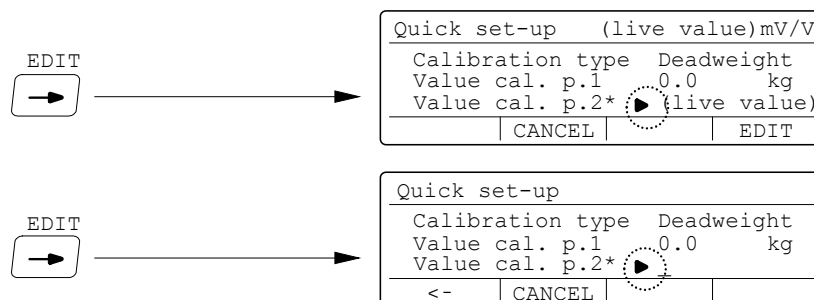

Use the digit keys to enter the amount of known weight, loaded on the scale.

Press key  to finish the entry of the weight value for calibration point 2. The asterisk for point 2, and the asterisk in the top line, disappears.

**Read the transducer signal for calibration point 1.**

This parameter value shows the transducer signal for point 1, a value that should be recorded in the 'Quick set-up list', appendix 1.

It will be useful if the instrument must be replaced.

The parameter value can not be edited.

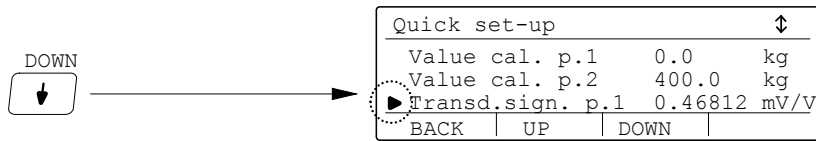

**Read the transducer signal for calibration point 2.**

This parameter value shows the transducer signal for point 2, a value that should be recorded in the 'Quick set-up list', appendix 1.

It will be useful if the instrument must be replaced.

The parameter value can not be edited.

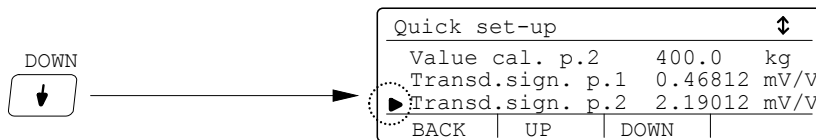

**Store the shunt transducer signal.**

Make sure the scale is unloaded. The shunt transducer signal can be stored in TAD 3, and should be recorded in the 'Quick set-up list', appendix 1.

It can be used later for a calibration check in menu 'Diagnostics'.

Position the cursor at 'Shunt transd.sig'.

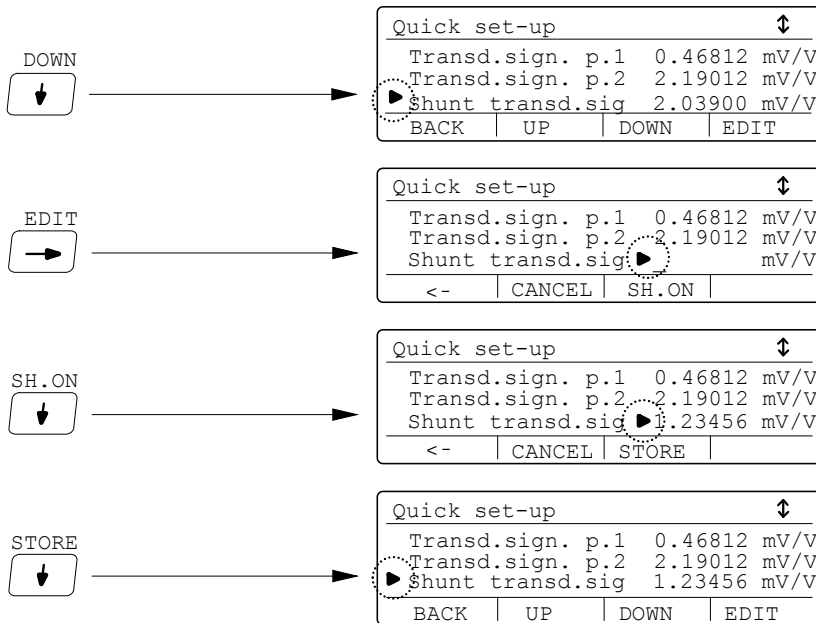



**Setting the gross weight to zero.**

This parameter is used to make the instrument display gross weight zero when the scale is unloaded. Make sure the scale is completely unloaded before this setting is performed.

The parameter value for 'Set zero' is a live weight value for actual zeroing. Position the cursor at 'Set zero'.

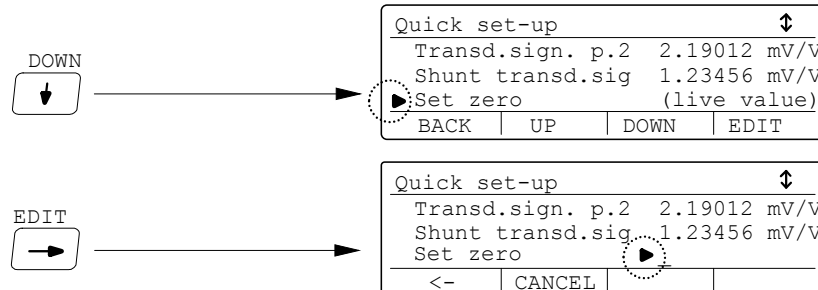

Use the digit keys to enter the zero value (normally 0).

Press key to finish the zero setting and make it active.

**Read the zero offset.**

The total, accumulated zero offset value for the installation is shown at parameter 'Zero offset', and should be recorded in the 'Quick set-up list', appendix 1.

It will be useful if the instrument must be replaced.

Position the cursor at 'Zero offset'.

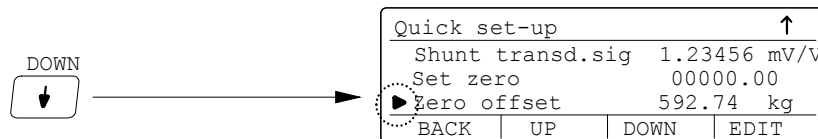

**Terminate the deadweight calibration.**

When the calibration is finished, all edited parameter values can be saved as the operation is terminated. It is also possible to terminate the calibration without saving the new values. In that case all changes during the calibration will be rejected.

Calibration can always be interrupted.

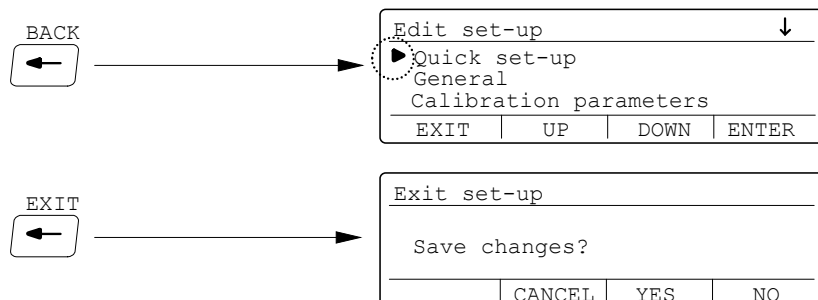

Answer by CANCEL to stay in 'Edit set-up'.

Answer by YES to save the new values in the TAD 3 memory, or by NO to reject the new parameter values. In both cases TAD 3 switches over to display of weight value.

The scale is now ready for use.

## Zeroing of gross weight

When the scale installation is calibrated, a zeroing is performed in order to make the gross weight zero when the scale is unloaded. If mechanical equipment is added later, this will affect the weight display for the scale, and a new zeroing of the gross weight becomes necessary.

**NOTE!** The scale must be unloaded when zeroing is performed.

### Access 'Quick set-up' in Edit set-up.

The parameters in TAD 3 can be protected from editing by security locks at two levels. Four-digit codes that open the locks can be defined by the customer. By default setting both codes are: 1 9 3 7 .

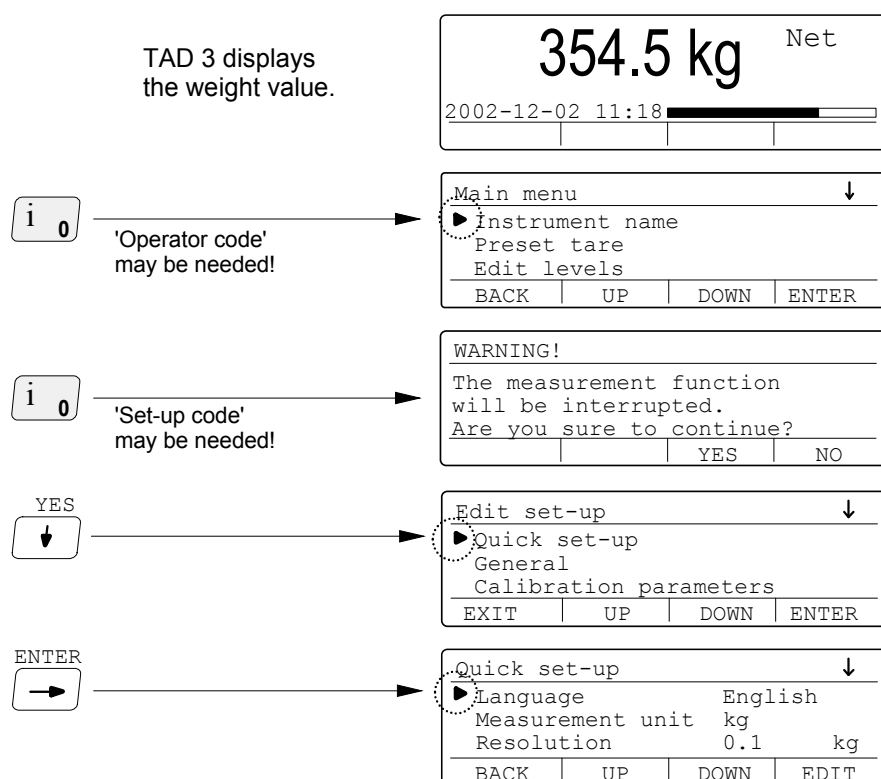

**Setting the gross weight to zero.**

Parameter 'Set zero' displays the actual gross weight, so that value should be zero when the scale is unloaded.

Make sure the scale is completely unloaded before this setting is performed.

Press DOWN several times to position the cursor at 'Set zero'.

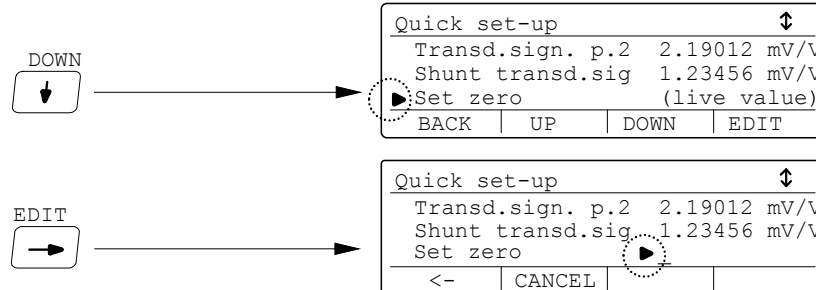

Use digit key 0 to enter the zero value.

Press key  to finish the zero setting.

'Set zero' becomes 0 and the value of 'Zero offset' changes correspondingly.

**Read the zero offset.**

The total, accumulated zero offset value for the installation is shown at parameter 'Zero offset', and should be recorded in the 'Quick set-up list', appendix 1.

It will be useful if the instrument must be replaced.

Position the cursor at 'Zero offset'.

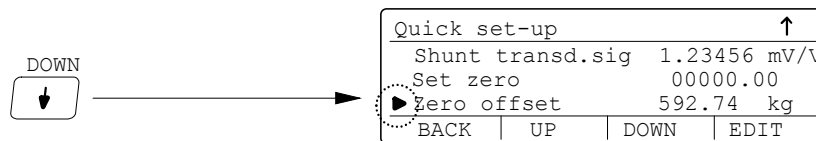

**Terminate the zeroing and switch to weight display.**

When the zeroing is finished, the new values should be saved. It is also possible to terminate without saving. In that case the new zero setting will be rejected.

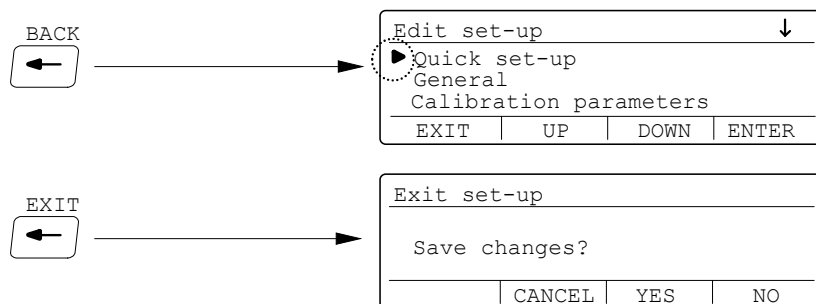

Answer by CANCEL to stay in 'Edit set-up'.

Answer by YES to save the new zero setting in the TAD 3 memory, or by NO to reject the new zero setting.

In both cases TAD 3 switches over to display of weight value.

# Parameter survey

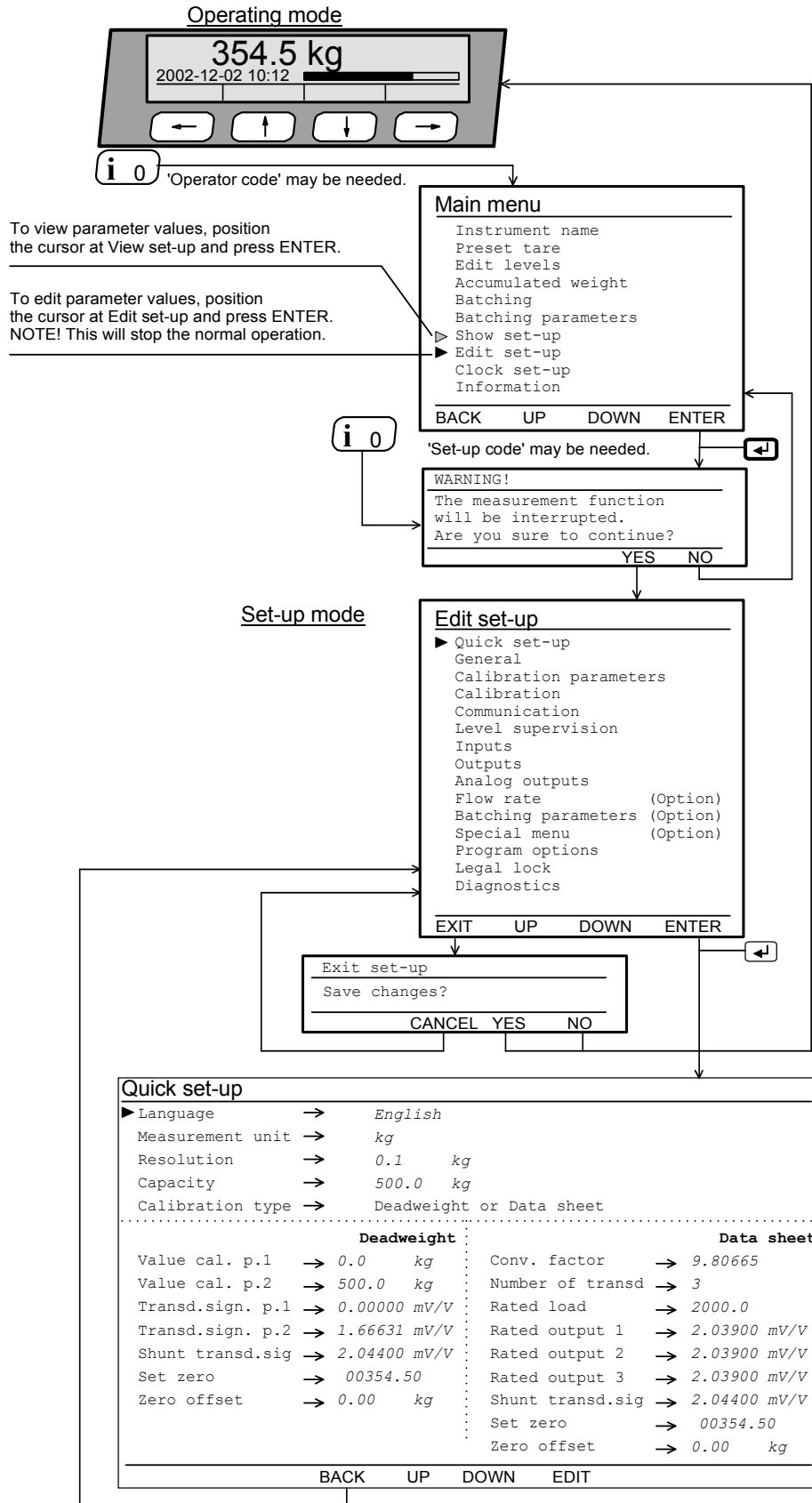

Menus and parameters in Quick set-up.

# Quick set-up list for TAD 3

Address: .....

Location/Notes: .....

Programme name: ..... Ser. no.: ..... Date: .....

Parameter name	Default value	Set-up value	
Language	English	.....	.....
Measurement unit	kg	.....	.....
Resolution	0.1	.....	.....
Capacity	500.0	.....	.....
Calibration type	Data sheet	.....	.....
Conv. factor	9.80665	.....	.....
Number of transd	3	.....	.....
Rated load	2000.0	.....	.....
Rated output 1	2.03900	.....	.....
Rated output 2	2.03900	.....	.....
Rated output 3	2.03900	.....	.....
Rated output 4	2.03900	.....	.....
Value cal. p.1	0.0	.....	.....
Value cal. p.2	500.0	.....	.....
Transd.sign. p.1	0.00000	.....	.....
Transd.sign. p.2	1.66631	.....	.....
Shunt transd.sig	2.03900	.....	.....
Zero offset	0.00	.....	.....



WATER				
2002-12-02 10:23	G	150.0	kg	
WATER				
2002-12-02 10:23	G	300.1	kg	
WATER				
2002-12-02 10:23	G	138.0	kg	
WATER				
2002-12-02 10:47	N	109.4	kg	
WATER				
2002-12-02 10:48	N	086.0	kg	

Printout from instrument 'WATER'  
of gross weight (G) and net weight (N).

2002-12-02 11:46	WATER	
Accumulated weight		
Printed	3886.300	kg

Printout from instrument 'WATER'  
of the accumulated printed weight value.

2002-12-02 12:19	WATER		
Level 2	65.0	kg	
Level 6	125.0	kg	
Level 7	200.0	kg	
Setpoint 1	5.0	kg	
Setpoint 2	10.0	kg	

Printout from instrument 'WATER'  
of actual values for all used Levels and Setpoints.







Document no. 35187  
Article no. 600 326 R8  
© Vishay Nobel AB, 2011-05-11  
*Subject to changes without notice.*

**Vishay Nobel AB**  
Box 423, SE-691 27 Karlskoga, Sweden  
Phone +46 586 63000 · Fax +46 586 63099  
pw.se@vishaypg.com [www.weighingsolutions.com](http://www.weighingsolutions.com)