

# Transmitter WST 3

From prog. name W001A100



## Technical Manual



# Contents

## 1. Introduction

Functions .....	1-2
Technical data .....	1-4

## 2. Installation

General .....	2-1
Electrical installation .....	2-1
Front panel .....	2-4

## 3. Set-up

General .....	3-1
Quick set-up .....	3-3
Normal set-up .....	3-7
Parameters .....	3-9

## 4. Calibration

General .....	4-1
Common calibration parameters ...	4-2
Data sheet calibration .....	4-3
Dead weight calibration .....	4-4
Table calibration .....	4-4

## 5. Operation

General .....	5-1
Power supply .....	5-1
Power-up sequence .....	5-1
Display views in Operating mode ..	5-2
Taring .....	5-3
Display of Gross/Net .....	5-3
Zero setting .....	5-3
Analogue output .....	5-4
Supervision, output relays .....	5-4

## 6. Modbus communication

Communication interface .....	6-1
Line termination .....	6-1
Transmission principles .....	6-1
Modbus .....	6-2
Register description .....	6-2
Set-up registers .....	6-9
I/O-bit (coil) description .....	6-10
Data representation .....	6-11
Exception responses .....	6-13
Supported Modbus functions .....	6-14
External display .....	6-15

## 7. Profibus communication

General .....	7-1
Slave address .....	7-1
Profibus weight format .....	7-1
Mappings .....	7-2
'6 B Standard' mapping .....	7-3
'20 B Standard' mapping .....	7-5
'86 B Integer' mapping .....	7-6
'86 B Float' mapping .....	7-8
Common data, 20 and 86 byte ....	7-10
Commands, 20 and 86 byte .....	7-10
Repr. of weight, 20 and 86 byte ....	7-13
Bus diagnostics .....	7-14

## 8. Troubleshooting

General .....	8-1
Error codes .....	8-1
Profibus status .....	8-6

## Appendices

Set-up list for WST 3.....	App. 1
Declaration of Conformity .....	App. 2



# 1. Introduction

WST 3 is a high performance transmitter, designed for industrial weighing and force measuring by means of strain gauge transducers. At the front panel the instrument has function keys and a display window with backlight.

By normal operation the actual measurement value and the status of the relays is displayed in the window, but display of for example operation status and set level values can also be selected.

WST 3 supplies the transducer with excitation voltage and converts the analogue transducer signal to a digital measurement signal with very high resolution.

By parameter controlled calculations it produces internal measurement values, which can be presented at the display and used to control the current or voltage signal at the analogue output.

Functions are included for supervision of the input signal or some internal measurement values. The supervision status can be used to control the two output relays.

WST 3 can be incorporated as a slave unit in different types of networks.

Communication with the control unit/PLC can be performed via Profibus and Modbus. As an alternative the Modbus output can be used to transmit measurement values to external display units.

The network can be used for set-up of parameter values, but set-up can also be performed from the instrument front panel.

WST 3 is built into a compact enclosure, which is easily installed on a DIN-rail or a flat surface. The instrument inputs and outputs are galvanically isolated from each other.

## Functions

**Measurement with strain gauge transducers.** Excitation power to the transducer, from WST 3 or from an external DC-power supply, is made via two conductors. The output signal and the sense voltage (representing the excitation voltage at the transducer) are measured via four conductors to avoid influence from voltage drop in the connection cable. Thus a 6-wire cable must be used to connect a distant transducer to WST 3.

**A/D conversion.** The analogue signal-to-sense ratio from the transducer is converted to a digital value and filtered to produce an internal transducer signal with high resolution, representing the load on the transducer.

**Calculation.** Influenced by calibration data, the internal transducer signal is converted to a digital measurement value. Taring can be performed via activation of one digital input. The other digital input controls the display of net weight or gross weight at the local display window and at a connected control unit.

**Analogue output.** The digital measurement value is also converted into an analogue output signal, e.g. for presentation on an external display. Current or voltage output can be selected. The analogue output can also be forced to produce a selected, fixed current or voltage signal.

**Error supervision.** The error supervision is checking for electrical errors, invalid parameter values, and signals out of valid limits. As long as no error is detected, the signal 'In process' is present. If an error is detected an error message will be displayed and the signal 'In process' will be off, the relays will be deactivated and the analogue output signal will be set to 0V / 0mA.

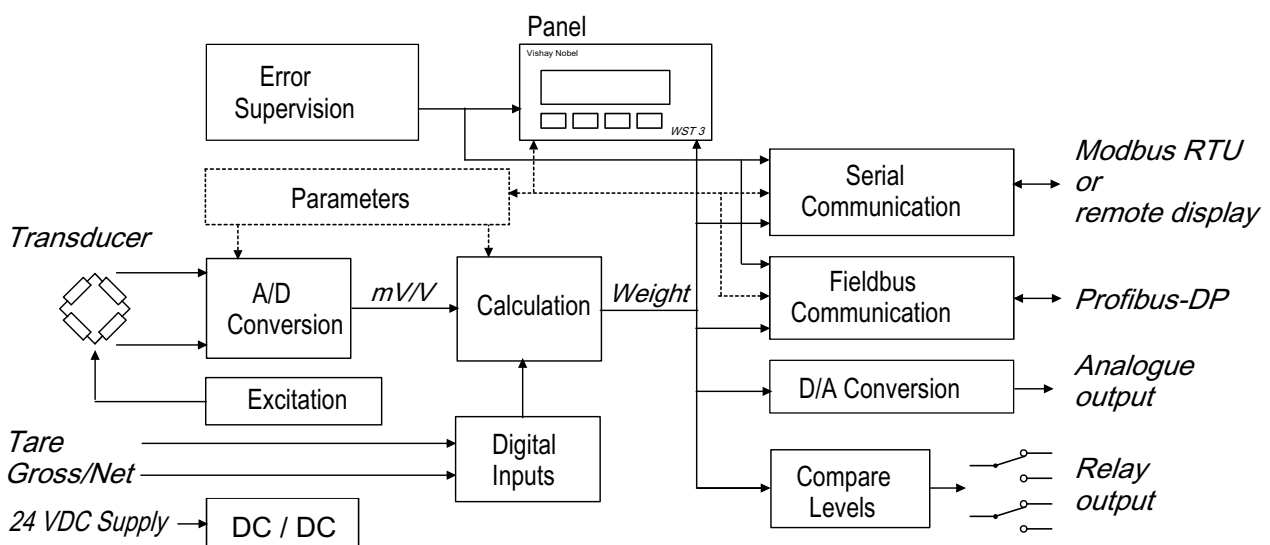

Figure 1. The transmitter WST 3 converts analogue transducer signals into precise measurement values for use in industrial processes.

**Levels.** WST 3 has two level comparators, controlled by set-up parameters. Input signal can be selected and the output signals can be presented at the display, be transmitted to the control unit, and control the relays in WST 3. The relays can also be used to indicate the status of the signal 'In process'.

**Serial communication.** WST 3 has one serial interface for RS-485 on 2-wires or 4-wires, which can be used for connection to a control unit. The Modbus protocol is used to transmit set-up and calibration parameters, measurement values, instrument status, error codes etc. If the serial interface is not used for control unit communication, it can be used to transmit measurement values to other digital equipment.

#### **Profibus-DP.**

WST 3 can be connected as a slave unit in a fieldbus of type Profibus-DP. For example measurement values, instrument status, error codes, set-up parameters, and calibration parameters can be transmitted on the fieldbus.

**Instrument modes.** At power-on the instrument enters the Start-up state, displaying its identity while internal tests are performed. Then it may enter the Wait for start state (selected by a parameter), waiting for a start command from the operator. After completed start-up, the WST 3 unit normally enters into operating mode (Normal state), continuously presenting the weight value (or other selected information). For parameter set-up WST 3 must be switched over to Set-up state.

As the module is in Set-up state or if a correct weight value cannot be presented, due to an error, the normal instrument operation is disabled, the relays are deactivated, and the analogue output is set to zero.

**Parameter setting.** In WST 3 set-up parameters are used to control all operating functions. Using the instrument function keys and display, parameter values can be entered as numerical values or values selected from a list of alternatives. Setting of parameter values can also be performed from a connected control unit.

**Presentation.** WST 3 can present parameter values and measurement values at the display window and at a connected control unit. The measurement value can also be presented at an instrument, connected to the analogue output.

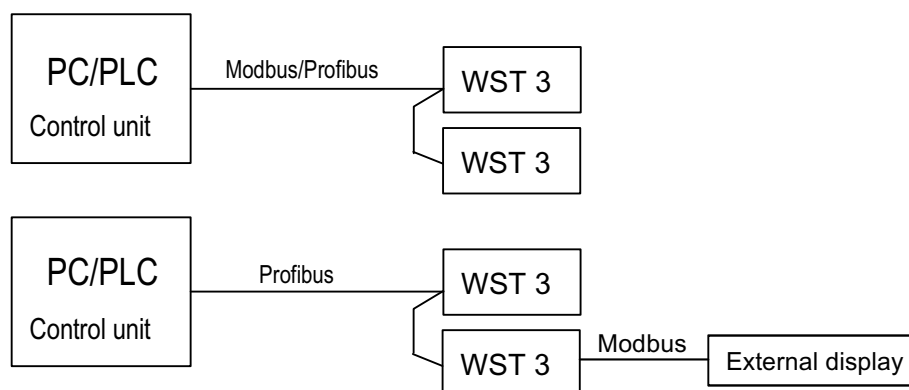

*Figure 2. WST 3 has two different types of communication channels that can be used for different operational tasks.*

## Technical data

### Transducer input

Transducers	Max 8, 350 ohms each. Total load >45 ohms.	
Excitation	Depending on the number of transducers connected:	
	8.8 VDC $\pm$ 5 % with 1 transd.	8.7 VDC $\pm$ 5 % with 2 transd.
	8.5 VDC $\pm$ 5 % with 3 transd.	7.7 VDC $\pm$ 5 % with 4 transd.
	6.5 VDC $\pm$ 5 % with 6 transd.	5.5 VDC $\pm$ 5 % with 8 transd.
Signal input	$\pm$ 3.3 mV/V.	
Sense input	1.5 – 10 VDC.	
A/D conversion	23 bits (8 300 000 counts). Patented design.	

### Analogue output

Bipolar voltage or current.

Voltage	0–10 VDC or +/-10 VDC over >500 ohms.
Current	0–20 mA, +/-20 mA, 4–20 mA, -12–20 mA in <500 ohms.
Filter	0.05 to 75 Hz, selectable bandwidth.
Resolution	16 bits (65 000 counts).
Non-linearity	<0.01 % of range.
Zero drift	<0.005 % of range/°C.
Gain drift	<0.003 % of actual value/°C.

### Digital inputs

Number of inputs	2
High voltage range	19 – 29 VDC.
Low voltage range	0 – 6 VDC.
Input current	6 mA at 24 V in.

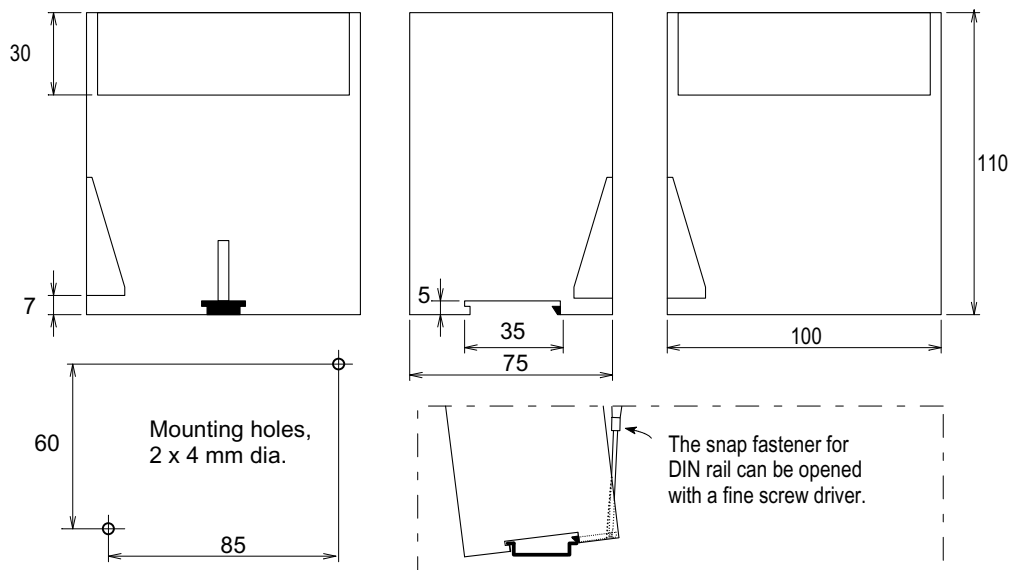

Figure 3. Mechanical dimensions for WST 3 without electrical connections.



## Modbus communication

Can be used for communication with control unit or external display.

Interface	RS-485, 2-wires or 4-wires.
Baud rate	Up to 115.2 kbaud.
Data format	Modbus RTU protocol for control unit communication.
Filter	0.05 to 75 Hz, selectable bandwidth.
Non-linearity	<0.005 % of range.
Zero drift	<0.0002 % of 3.3 mV/V /°C.
Gain drift	<0.0015 % of actual value/°C.

## Fieldbus communication

Type of fieldbus	Profibus-DP, modular slave.
Max. fieldbus data	86 byte.
Baud rate	Automatic, 9.6 kbaud – 12 Mbaud.
Address	0 – 125, by set-up parameter.
Connector	9-pole D-sub, female with housing max. 16 x 36 mm.

## Calibration

Methods	Data sheet, Dead weight or Table calibration.
---------	---

## Power supply

Supply voltage	24 VDC $\pm$ 20 %.
Consumption	8 W.

## Environmental

Temperature range	-10 to +50 °C.
CE conformity	EMC, industrial for process control.

## Relay output

Number of relays	2 (each with 1 switching group).
Relay load	Max 1 A, 30 V AC or DC.

Spark suppression required at inductive load.



Figure 4. WST 3 and a rail mounted power supply in a protecting box from Nobel Weighing Systems.

## Mechanical data

Dimensions	75 x 100 x 110 mm. (Without connectors and cables.) At least 20 mm air gap between units.
Rail mount	DIN 46 277/3 and DIN EN 50022 (35 mm).
Protection	IP 20.

## Front panel

Display	2 x 16 character LCD display with backlight.
Keys	4 keys for menu control and data entry.



Figure 5. The transmitter WST 3.

## 2. Installation

### General

Each transmitter module WST 3 contains several circuit boards, built into a protective plastic housing. The module can be snap-mounted on a 35 mm wide DIN rail or attached on a flat surface by two 4 mm screws. The Profibus-DP cable connects to a D-sub connector, all other cables connect to plug-in terminal blocks.

### Electrical installation

All electrical connections to the WST 3 module, including possible connection to ground, are made via connector or plug-in terminal blocks. Shielded cables are needed, except for the power supply, and the installation should be made so that electromagnetic interference from power cables is avoided.

Inputs and outputs of WST 3 are galvanically isolated from each other to facilitate connection to various external equipment.

Cable connection is shown in the diagrams below.

#### Power supply

Terminals 17, 18.

The WST 3 unit is powered by 24 VDC, see requirements in Technical data.

Nobel Weighing Systems provides rail mounted power supplies, intended for operation of WST 3 units.

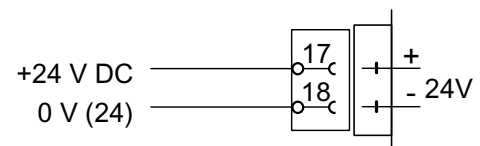

#### Digital inputs

Terminals 15, 16.

Connection of +24 VDC to the digital inputs will perform Taring and Gross/Net switching respectively.

Connect the cable shield to ground, preferably to a ground terminal at the mounting rail.

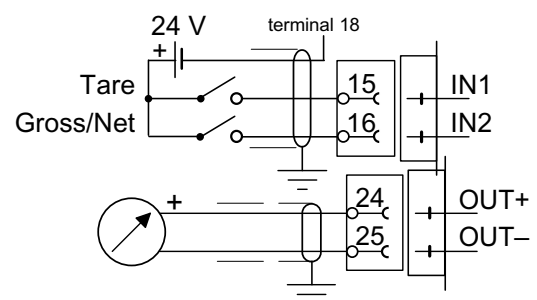

#### Analogue output

Terminals 24, 25.

Current output or voltage output for presentation of the measured value at the process control or at an external analogue instrument.

Connect the cable shield to ground, preferably to a ground terminal at the mounting rail.

## Serial communication

Terminals 19 – 23.

A serial port for RS-485, on 2-wire or 4-wire with common signal ground (COM), is used to connect WST 3 to a control unit, or to transmit values to an external display unit. At both ends, the transmission line must have terminating resistors of 120 ohms. For WST 3 they should be mounted on separate terminals, connected according to the diagrams.

For a control unit or external display, refer to manufacturer instructions concerning line termination.

Shielded cable with twisted pairs should be used, with the cable shield connected to ground, preferably by a ground terminal on the mounting rail.

When connecting several units to a transmission line, wires from two cables must be connected to the terminals at WST 3.

To facilitate that connection, use cable ferrules crimped on the two wires.

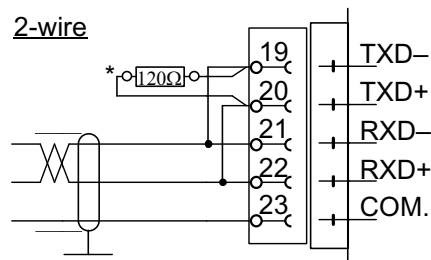

\* Terminating resistor on separate terminals at the last unit on the line.

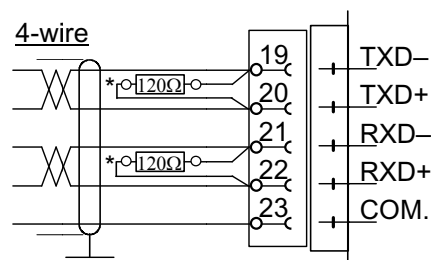

\* Terminating resistor on separate terminals at the last unit on the line.

## Fieldbus communication, Profibus-DP

9 pole D-SUB (female)

In the fieldbus Profibus-DP standard cable and 9 pole connectors for Profibus are used. The fieldbus should have line termination at both end points.

For a WST 3 unit at the end of the cable, connection with line termination should be used.

### Connection with line termination

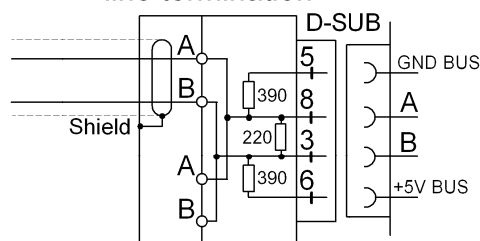

### Connection without line termination

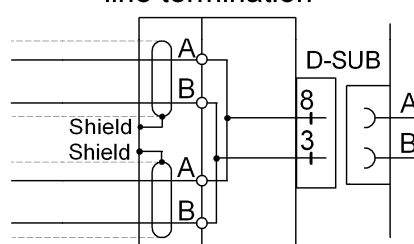

For all other WST 3 units in the fieldbus system, connection without line termination should be used.

## Relay outputs

Terminals 9 – 11 and 12 – 14.

Observe the contact rating given in Technical data. Use shielded cable with the shield connected to ground, preferably by a ground terminal on the mounting rail.

When the relays are used, the operator has to observe the requirements of interference emission for electrical and electronic devices (EN 50081) on the contact side and take appropriate measures, if necessary.

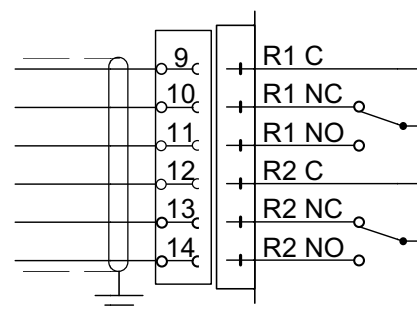

## Transducer input

Terminals 1 – 7 (8).

Connection of transducers should be handled with great care to achieve good measuring data. For transducers delivered with integrated connection cable, this cable must not be shortened.

**NOTE!**

Transducer cables must be routed at least 200 mm away from 230/380 V, 50/60 Hz power cables. By cables with other frequencies or high power, an even wider distance is preferable.

WST 3 is designed for 4-wire connection or 6-wire connection of transducers.

4-wire connection should be used if the cable, delivered with the transducer, can be connected directly to the WST 3 terminals. By 4-wire connection, excitation and sense must be interconnected as shown in the diagram below.

Connect the cable shield and terminal 5 to ground via the mounting rail.

6-wire connection should be used if the cable, delivered with the transducer must be lengthened, or if several transducers should be connected to one WST 3 unit.

Connect the transducer cable(s) to a junction box, and use 6-wire connection between the junction box and WST 3. Connect the cable shield and terminal 5 to ground via the mounting rail. In the diagram below connections are shown for the junction box SL-4 from Nobel Weighing Systems.

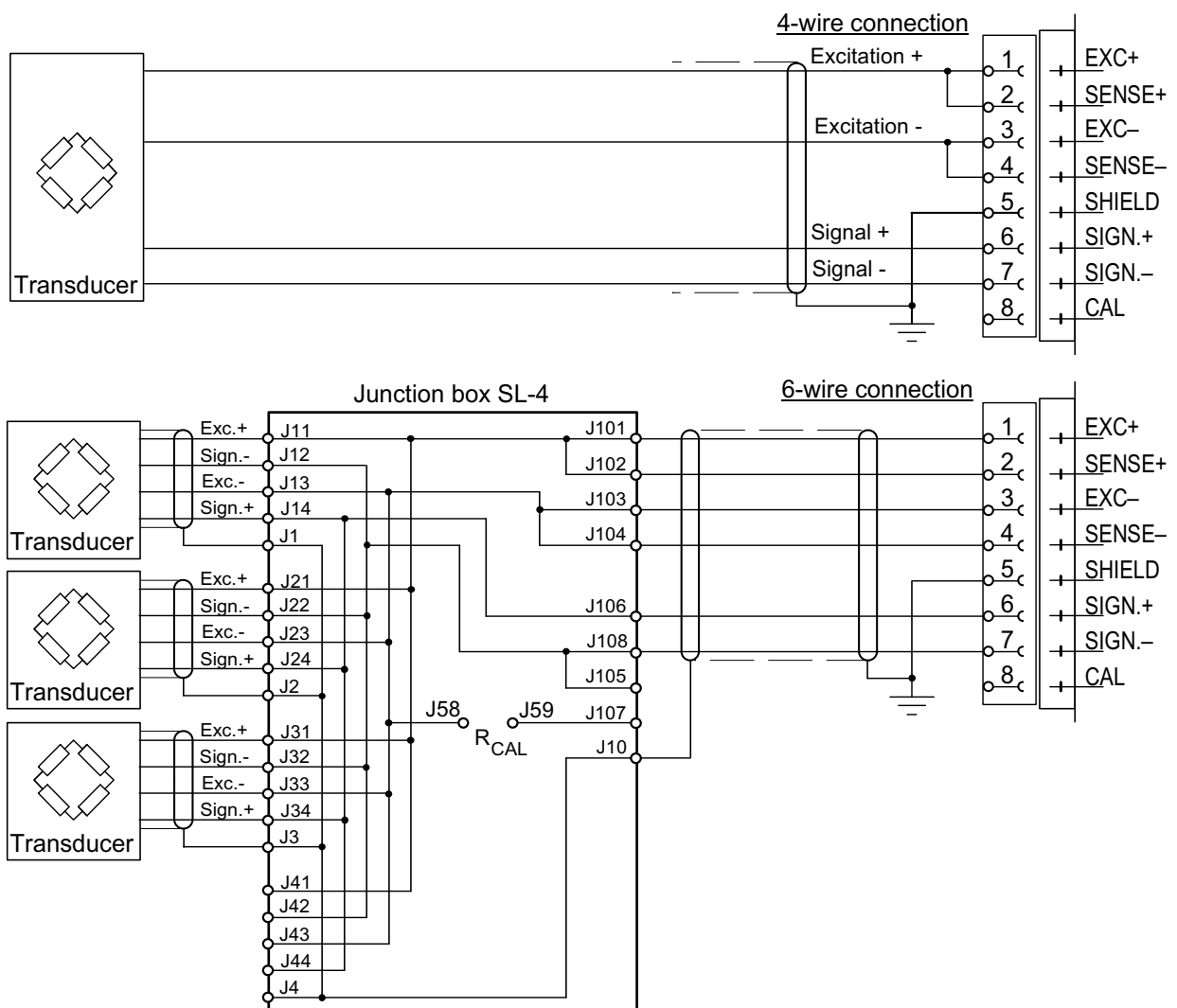

## Front panel

The front panel of WST 3 has four function keys and a backlit 2x16 character LCD display. In operating mode the weight value is presented in one view, but other views may also be selected.





Set-up can be performed in two ways: the 'Quick set-up' with only a few vital parameters or the 'Normal set-up' where all the parameters are available.

Error messages or parameter explanations can also be displayed.

The function keys are used to select a parameter, to edit the parameter value, and to save the new value in the memory or to exit without saving the new value.























The key functions in the different states are explained in the table below.

### Key explanation

	Name	Function	
		In Normal state:	In Set-up state:
	ENTER	<p>In view Zero setting: Set Gross weight to zero.</p> <p>In view Profibus status, if pressed for 2 seconds: Go to 'Profibus diagnostics'.</p> <p>In all other views: No function.</p>	<p>In a 'Main menu': Go to the first parameter.</p> <p>Parameter viewing, <i>without</i> cursor: Make editing possible.</p> <p>Parameter editing, <i>with</i> cursor: Accept the digit at the cursor and go to next digit. <u>If ENTER is pressed for 2 seconds:</u> The displayed parameter value is activated. The cursor disappears.</p>
	plus	<p>Go to next view. See Figure 12.</p> <p>Together with ↑ for 2 sec.: Go to 'Normal set-up'. (Password may be required.)</p>	<p>In a 'Main menu': Go to next main menu.</p> <p>Parameter viewing, <i>without</i> cursor: Go to next parameter.</p> <p>Parameter editing, <i>with</i> cursor: Increment the digit at the cursor or Go to next alternative.</p>
	minus	<p>Go to previous view. See Figure 12.</p>	<p>In a 'Main menu': Go to previous main menu.</p> <p>Parameter viewing, <i>without</i> cursor: Go to previous parameter.</p> <p>Parameter editing, <i>with</i> cursor: Decrement the digit at the cursor or Go to previous alternative.</p>
	ESCAPE	<p>Go to view 'Weight value' See Figure 12.</p> <p>If pressed for 2 seconds: Go to 'Quick set-up'. (Password may be required.)</p> <p>Together with + for 2 sec.: Go to 'Normal set-up'. (Password may be required.)</p>	<p>In a 'Main menu': No function.</p> <p>Parameter viewing, <i>without</i> cursor: Go to the main menu.</p> <p>Parameter editing, <i>with</i> cursor: Interrupt the editing.</p>

Example for how to use the keys:

As an WST 3 is started for the first time it enters the operating mode, displaying the Weight value. This example describes how to change 'Measurement unit' to pounds (lb) and Capacity to 1000 (lb), using the 'Quick set-up'. See figure 7.

- \* To leave Operating mode and enter 'Quick set-up', press  for 2 seconds.
- \* 'Main menu Quick set-up' is displayed. Press  to get to the first parameter in the 'Quick set-up'.
- \* The first parameter, 'Language', is displayed. Press  to get to 'Measurement unit'.
- \* For parameter 'Measurement unit', the default value 'kg' is displayed. Press  to start editing. A cursor makes the first letter on the lower line blinking.
- \* With a cursor on the lower line  or  are used to step forwards or backwards through the list of alternatives. Press  or  until 'lb' is displayed.
- \* To accept the displayed alternative, press  for 2 seconds. The cursor disappears.
- \* Now, without cursor on the lower line, use  to get to parameter 'Capacity'. The default value on the lower line, 500.0 lb, should be changed to 1000.0 lb.
- \* Press  to start editing. The lower line will display '00500.0 lb' with a cursor at the first digit.
- \* The parameter value should be changed to '01000.0 lb'. Press  once to accept the first digit and move to the second digit. Press  or  to change the digit to '1'. Press  to accept the value '1' and move to next digit. Press  or  to change the digit from '5' to '0'. Now the value is correct. Press  for 2 seconds, the cursor disappears and '1000.0 lb' is displayed.
- \* As the editing is ready, press  to get to 'Main menu Exit set-up'.
- \* Press . The sub menu 'Save changes? No Esc. Yes' will be displayed. (Press  if you do not wish to exit from the Set-up state.)
- \* Answer by  (Yes) to save the new edited values. Answer by  (No) to cancel the new values and return to previously saved values.

In both cases the set-up is finished and the module switches to operating mode, displaying the Weight value.





## 3. Set-up

### General

All operating functions in WST 3 are controlled by permanently stored parameters, so the information will not be lost if the module is switched off. At delivery the parameters are factory-set to default values, giving the module an initial standard function.

For WST 3 modules connected to Profibus-DP parameter editing can be performed from the fieldbus master.

For WST 3 modules connected to a Modbus network, the parameter values can be edited from the network master via serial communication. If a computer with Windows 95/98/ME/NT4.0/2000/XP is used, editing of parameter values can be facilitated by using the set-up program deltaCOM from Nobel Weighing Systems. All parameter values for the module can also be edited from the front panel function keys, see below.

When set-up from a master via the communication is in progress, local set-up from the front panel is prevented and the following message is displayed:

```
Remote set-up
Please wait!
```

When WST 3 is first taken into service, only a few parameters need to be edited to adapt the transmitter to the transducer and to obtain basic measuring function and correct values. These parameters are gathered in the 'Quick set-up' sequence, easily accessible by activation of a single key at the front panel.

See figure 7 on next page.

When parameter values, not accessible in the 'Quick set-up', need to be edited it is necessary to use the 'Normal set-up' sequences. These sequences contain all set-up parameters, divided into groups under a number of main menus. The 'Normal set-up' is started by activation of two keys simultaneously, see figure 8.

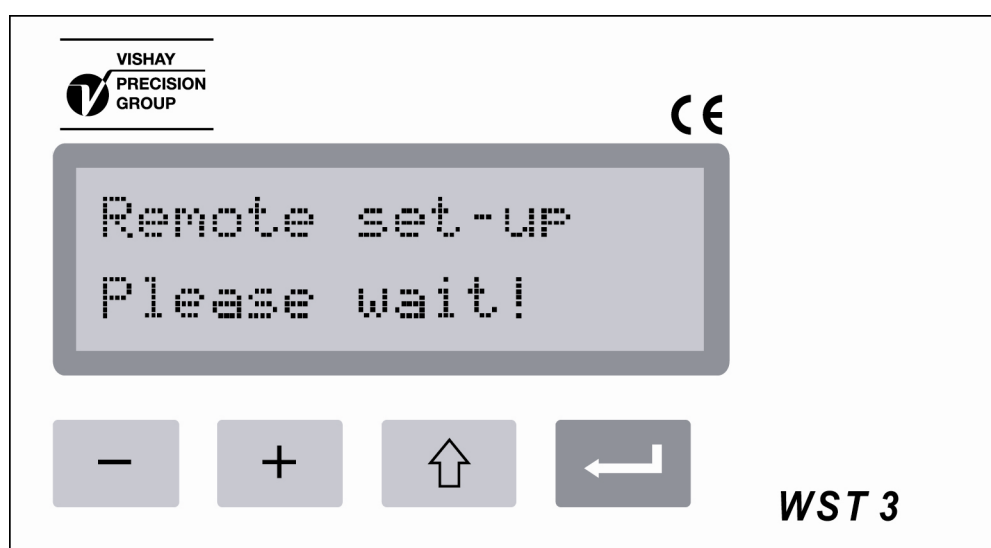

Figure 6. During set-up from a control computer, a message is given and the panel keys can not be used.

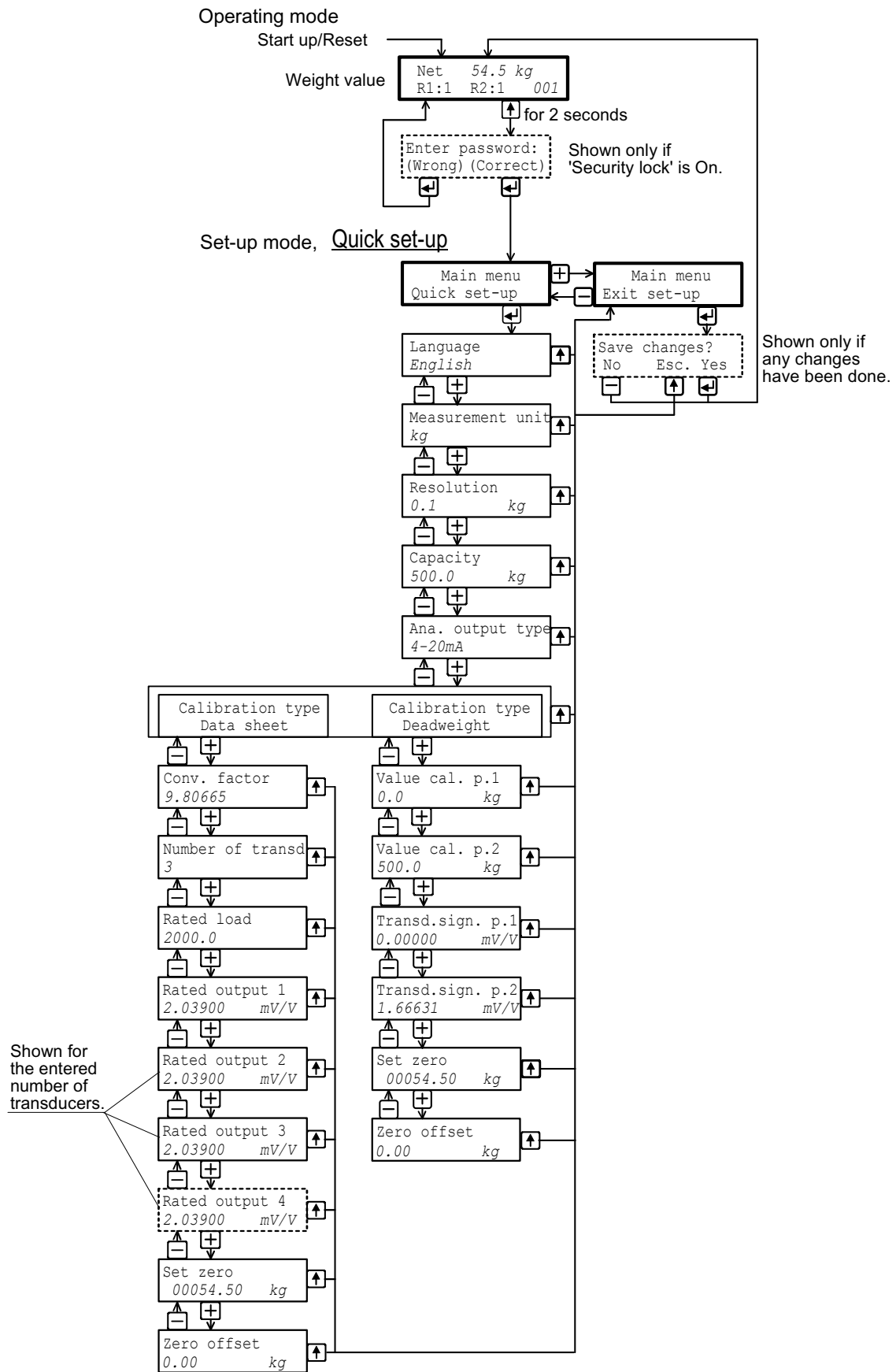



Figure 7. In the 'Quick set-up' some basic parameters can be edited.

## Quick set-up



In 'Quick set-up' for WST 3 a few basic parameters can be edited. A separate publication, "WST 3 Operating instructions, Quick installation", gives a step-by step instruction for the set-up operation. A brief instruction is given below. Parameter explanations are found on pages 3-4, 3-5 or in the complete parameter list on pages 3-10 to 3-24.

### Enter 'Quick set-up'

**Note!** In Set-up state all normal measuring operations are stopped!

Press  for 2 seconds. 'Main menu Quick set-up' will be displayed, possibly after entry of a correct password.



### Show the parameters



When 'Main menu Quick set-up' is displayed, press  to attain the sequence of parameters. Parameter name and the actual parameter value are displayed together. Press the  key or the  key to step backwards or forwards in the parameter sequence, see figure 7.

### Select a parameter to edit

Press  as the parameter is displayed. A blinking cursor appears to the left on the second line, and numerical parameter values get leading zeros. The cursor indicates that editing can be performed.

### Edit a parameter value

For choice parameters the value is selected from a list of alternatives. As a cursor is blinking on the lower line, press the  (or ) key to find the correct alternative, then press  for 2 seconds to accept it, and the cursor disappears.

For numerical parameters each digit is edited separately. The digit at the cursor can be edited by the  or  key. The value of that digit is accepted by , and the cursor moves to next digit.

Repeat this procedure until a correct value with leading zeros is displayed, then press  for 2 seconds to accept it, and the cursor disappears.

If the accepted value is out of range an error message will start flashing.



Any key can be pressed to remove the message, cancel the incorrect value, and make continued editing possible.

Press  to cancel the editing in progress and remove the cursor.

### Calibration

Two calibration types are supported by 'Quick set-up': data sheet calibration and dead weight calibration. See section Calibration for more information about calibration types and parameters.

### Exit 'Quick set-up'

See figure 7. First press  to get to 'Main menu Exit set-up', and then press . If nothing was edited, 'Quick set-up' is finished and view 'Weight value' is displayed. If any parameter has been edited, 'Save changes? No Esc. Yes' is displayed.

(Press  if you do not wish to exit from the Set-up state.)

If  (Yes) is pressed, all edited parameter values will be saved.

The new values should also be recorded in a set-up list. See appendix 1.

If  (No) is pressed, all edited parameter values will be cancelled.

All parameters resume the values they had before 'Quick set-up' was started.

This finishes the 'Quick set-up' and the view 'Weight value' will be displayed.

## Parameters in 'Quick set-up'

'Quick set-up' for WST 3 includes parameters for setting of basic instrument properties and for calibration of the measuring equipment.

For each parameter a short explanation and the range for the parameter value are given. The parameters are also explained on pages 3-10 to 3-24.

### 'Language'

Defines the language, used for parameters and messages.

List of alternatives: Svenska, English, Deutsch, Français.

Default value: English.

### 'Measurement unit'

Selection of engineering unit for the measurement value.

List of alternatives:

NONE, g, kg, t, lb, N, kN, oz, psi, kPa, MPa, bar, l, lbf, kgf, PLI, N/m, kN/m, Nm, daN, mV/V.

Default value: kg.

### 'Resolution'

Selection of decimal point position and resolution format for the measurement value.

All set-up parameters using the selected measurement unit will be displayed with the resolution selected here.

List of alternatives: 0.001, 0.002, 0.005, 0.01, 0.02, 0.05, 0.1, 0.2, 0.5, 1, 2, 5, 10, 20, 50.

Default value: 0.1.

### 'Capacity'

Nominal range of the analogue output, expressed in 'Measurement unit'.

An asterisk (\*) on the upper line indicates that the range for the analogue output has been changed by parameters in 'Normal set-up'.

Possible values: from 0.5 to 999999.

Default value: 500.

### 'Ana. output type'

For the analogue output, several signal types can be selected: bipolar or monopolar current, bipolar or monopolar voltage.

List of alternatives: +/-20mA, -12-20mA, 0-20mA, 4-20mA, +/-10V, 0-10V.

Default value: 4-20mA.

### 'Calibration type'

Data sheet calibration is recommended as a preliminary calibration. With simple means it gives fairly good accuracy, so the equipment can be tested. Settings from an earlier dead weight calibration are lost if data sheet calibration is selected.

Dead weight calibration is the most accurate calibration type. Known weights are used as load on the equipment.

See section Calibration for further information on calibration types.

List of alternatives: Data sheet, Deadweight, Table.

Default value: Data sheet.

**'Conv. factor'**

This parameter defines the factor by which a value expressed in 'measurement unit' must be multiplied to be expressed in the transducer data sheet unit.

Consequently the factor is =1 if measurement unit and data sheet unit are equal.

Default value can be used if measurement unit is 'kg' and data sheet unit is 'Newton'.

Possible values: from 0.01 to 99.

Default value: 9.80665.

**'Number of transd'**

This parameter defines the total number of transducers and fixed support points for the load. If the number of support points is over 4, set the parameter value to 1.

Possible values: 1 to 4.

Default value: 3.

**'Rated load'**

This parameter defines the rated load for the used transducer type, expressed in the unit of the transducer data sheet.

NOTE! If the data sheet value is 5 kN, this parameter should be set to 5 000 (N).

If the number of support points is over 4, the value of this parameter should be: rated load multiplied by that number.

Possible values: from 1 to 999999.

Default value: 2000.00.

**'Rated output 1' (2, 3, 4)**

These parameters define the rated output for transducers and fixed support points.

For transducers the rated output, in mV/V, is given in the data sheet. For fixed support points the rated output should be set to 0.00000 (mV/V).

If the number of support points is over 4 the parameter value should be: the sum of all rated output values, divided by the number of transducers.

Possible values: from 0 to +9.99999.

Default value: 2.03900.

**'Value cal. p.1' (p.2)**

These parameters define the known load on the scale for the two calibration points.

Calibration point 1 is the lower point, normally unloaded scale.

Calibration point 2 is the higher point, at least 2/3 of the nominal capacity.

Possible values: from -999999 to +999999.

Default values: Value cal. p.1: 0

Value cal. p.2: 500

**'Transd.sign. p.1' (p.2)**

These parameters give the transducer signals for the two calibration points.

The values cannot be edited, make a note of them in the 'Set-up list' (Appendix 1) for possible use in a table set-up of a replacement instrument.

Possible values: from -9.99999 to +9.99999.

Default values: Transd.sign. p.1: 0.00000 mV/V

Transd.sign. p.2: 1.66631 mV/V

**'Set zero'**

Used in both calibration types for zeroing of the instrument.

The actual weight is displayed. Press , the weight value is set to zero.

Press  for 2 sec., the zeroing is accepted.

**'Zero offset'**

Displayed after zeroing for both calibration types.

Make a note of the parameter value in the 'Set-up list' (Appendix 1) for possible use in set-up of a replacement instrument.

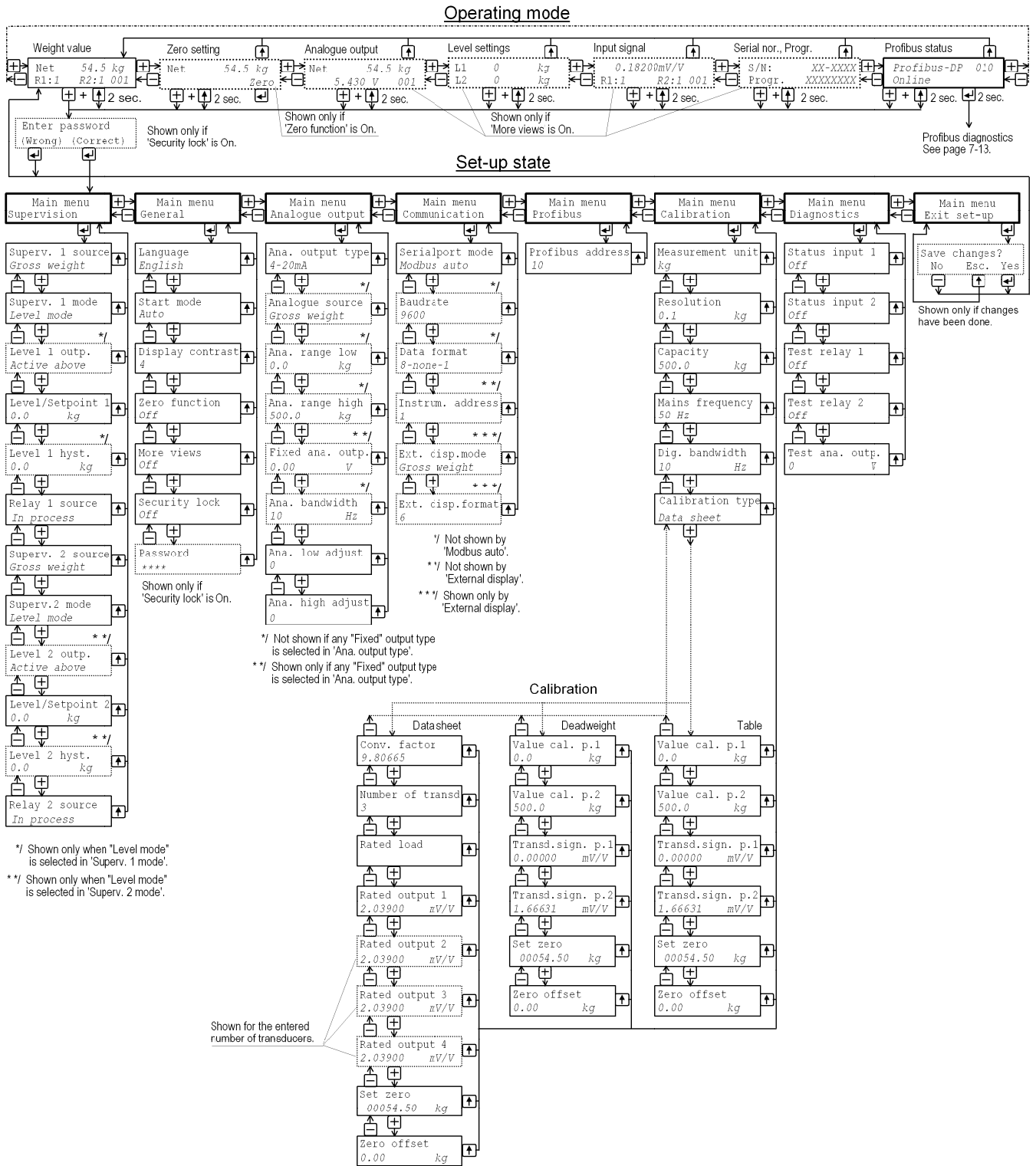

Figure 8. In 'Normal set-up' all adequate parameters are available for editing. Display of some parameters, indicated by intersected frames, depends on the setting for other parameters. The number of views available in operating mode also depends on parameter settings. In this figure the parameter values are only examples.

## Normal set-up

At delivery, the WST 3 parameters have default values. During the set-up operation the parameters are set to appropriate values for the actual installation. These values are saved in the WST 3 memory, and should also be recorded manually, for example in a set-up list, like the one in Appendix 1.

Set-up can be performed locally by the keys and the display on the front panel of WST 3. Set-up can also be performed from the Profibus-DP master or from a connected control unit. If the control unit is a PC with Windows 95/98/ME/NT4.0/2000/XP, the deltaCOM program from Nobel Weighing Systems can be used to facilitate the set-up.

### Enter 'Normal set-up'

**When WST 3 is in Set-up mode,  
all normal measuring is stopped.**

From any of the views in the operating mode, switch-over to 'Normal set-up' takes place when the keys  $\uparrow$  and  $+$  are activated simultaneously for 2 seconds. (Possibly after entry of a correct password).

### Menu survey

All parameters in WST 3 are accessible for editing by 'Normal set-up'. The parameters are divided in groups under the main menus, see figure 8 and 9. Each main menu with its parameters is also presented later in this section.

As shown in the figures, the keys  $-$  and  $+$  are used to step backwards and forwards in the sequence of main menus.

As a main menu is displayed, press  $\leftarrow$  to enter in the group of parameters.

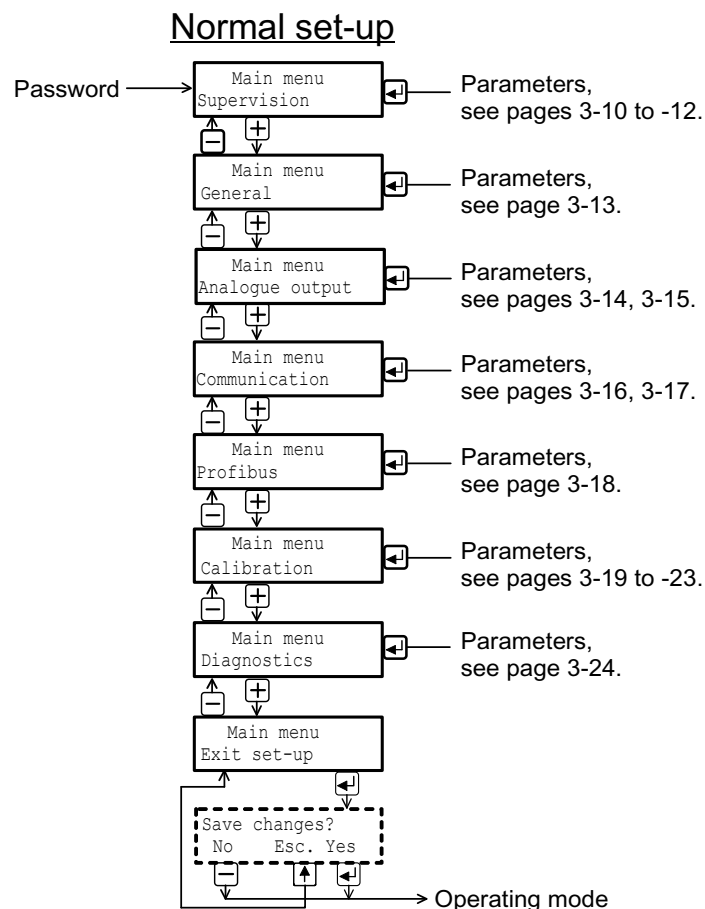

Figure 9. The set-up parameters are grouped under a number of main menus.

## Main menus

### 'Supervision'

WST 3 has two supervision channels, Superv. 1 and Superv. 2 that are set individually by parameters. The channels can operate in Level mode or Setpoint mode, supervising the transducer input signal or some of the internal weight values.

In Level mode the level value and the hysteresis (the difference in switch level for increasing and decreasing signal) can be set to negative or positive values in a wide range.

In Setpoint mode an activating command must be transmitted from the control unit to activate the function.

WST 3 has two internal relays that can be controlled by the supervision channels or can be used to indicate when WST 3 is 'In process'.

### 'General'

This main menu contains parameters for general use, like setting of a security lock for entry in Set up state, and a password for the lock, setting the type of instrument start up after power-on or reset, automatically or on operator command.

Selection of the language, the number of available views, and the character contrast in the display window is also set by parameters under 'General'.

### 'Analogue output'

The analogue output can present the measurement value as current or voltage.

Several formats can be selected here. Scaling and adjustment of the output can also be done. Parameters are included to set the analogue output to a fixed current or voltage level, independent of the internal weight value.

### 'Communication'

The instrument has a serial port for communication purposes. By parameters it can be set for control unit communication with suitable baud rate, data format, and instrument address, or for transmission of the measurement value to an external display unit.

### 'Profibus'

The instrument can be connected to a fieldbus Profibus-DP. A parameter is available for setting of the address.

### 'Calibration'

'Calibration' contains parameters for selection of engineering unit and resolution for the measurement value, setting of capacity for the instrument, and setting of filters to reduce mains frequency interference and to give a suitable bandwidth for the internal signal conversion.

Three calibration types are available:

**Data sheet**, where information about the used transducers and values from the data sheets are entered.

**Dead weight**, where the scale is loaded with known weights and the instrument is set to display corresponding weight values.

**Table**, where recorded values from a previous dead weight calibration of the installation is entered in a replacement instrument.

The calibration types also include parameters for zero setting and indication of the zero offset value.

### 'Diagnostics'

Parameters are available to test the digital inputs, the internal relays, and the analogue output.



### 'Exit set-up'

A sub menu gives the opportunity to save, or to cancel, all edited values before leaving the 'Normal set-up'.







## Editing procedure

To perform editing of a parameter in 'Normal set-up', first go to the main menu, containing the parameter and press ENTER (the  key).

Then use the key  or  to step forwards or backwards in the sequence to find the wanted parameter.

As the wanted set-up parameter is displayed, start the editing operation by . This will place a blinking cursor to the left on the lower line, and a numerical parameter value will get leading zeros. The cursor indicates that editing can be performed and that the panel keys have the functions explained below.

See also the table on page 2-4.

Key	Function by parameter editing (with cursor)
	Increment the cursor digit, or Go to next alternative.
	Decrement the cursor digit, or Go to previous alternative.
 (short)	Accept the value of the cursor digit and go to next digit.
 (2 sec.)	Accept the actual parameter value and finish editing. If a value outside the range for a numeric parameter is entered, an error message is displayed. Then press any key to remove the message, cancel the value, and make continued editing possible.
	Cancel the edited value, and interrupt the editing.

As the parameter editing is finished, WST 3 must exit from Set-up state to make normal operation possible.

To exit from Set-up state,

press  to get to the main menu,

press  several times until 'Main menu Exit set-up' is displayed,

press , sub menu 'Save changes? No Esc. Yes' will be displayed.

(Press Esc. (  ) if you do not wish to exit from Set-up state.)

Answer No (  ) All edited values are cancelled and the parameters will resume their previous values. WST 3 switches over to the operating mode, displaying the weight value.

Answer Yes (  ) All edited values are saved in the module memory. WST 3 switches over to the operating mode, displaying the weight value.

## Parameters

On the following pages all set-up parameters, grouped under the main menus they belong to, are presented in the order they appear in the set-up sequences.

The first line indicates the parameter name and the Modbus registers, used for set-up from a control unit (Modbus or Profibus). The parameters are saved in two different float formats and can therefore be read and written in two different registers. For choice parameters an index in [ ] is given for each alternative. (These indices are used by set-up via Modbus or Profibus.)

For numerical parameters a value range is given.

At the end of the table, the default value is given in < >.

To the right there is a short parameter explanation and, *in italic*, the results for the different alternatives.

[index]	Range/Alternative <default value>	Explanation and result of alternatives.
---------	--------------------------------------	--

## 'Main menu Supervision.'

See page 5-4.

### Superv. 1 source Modbus: 41000 (46000)

[0]	Input sign. mV/V	Defines supervision of transducer input signal
[1]	Net weight	or internal weight value for Superv. 1.
[2]	Gross weight	<b>Input sign. mV/V:</b> <i>The transducer input is supervised.</i>
[3]	Disp. weight	<b>Net weight:</b> <i>The net weight is supervised.</i>
[4]	Abs.net w.	<b>Gross weight:</b> <i>The gross weight is supervised.</i>
[5]	Abs.gross w.	<b>Disp. weight:</b> <i>The displayed weight is supervised.</i>
[6]	Abs.disp.w. <Gross weight>	<b>Abs.:</b> <i>Means 'Absolute', supervision of the absolute value of net weight, gross weight, or displayed weight.</i>

### Superv. 1 mode Modbus: 41002 (46002)

[0]	Level mode	Defines the operating mode for Superv. 1.
[1]	Setpoint mode <Level mode>	<b>Level mode:</b> <i>Supervision of Level 1 value.</i> <b>Setpoint mode:</b> <i>Setpoint mode selected.</i>

### Level 1 outp. Modbus: 41004 (46004)

[0]	Active above	This parameter defines the conditions for control of a possible relay output for Superv. 1.
[1]	Active below <Active above>	

**Active above:** *The relay output will be active as the value of the supervised signal is above Level 1 value.*  
**Active below:** *The relay output will be active as the value of the supervised signal is below Level 1 value.*  
 This parameter is shown only if 'Level mode' is selected in 'Superv. 1 mode'.

### Level/Setpoint 1 Modbus: 41006 (46006)

Range:	Defines the switch level for Level 1 or Setpoint 1.
+/-999999 or +/-4.0000	This parameter is automatically set to zero as the alternative for 'Superv. 1 source' is changed.
Unit:	A suitable engineering unit, depending on the supervised signal, is automatically added.
Measurem. unit or mV/V <0>	

### Level 1 hyst. Modbus: 41008 (46008)

Range:	Defines the hysteresis range for Level 1.
+/-999999 or +/-4.0000	Positive value gives a hysteresis range above the switch level, negative value gives a hysteresis range below the switch level.
Unit:	This parameter is automatically set to zero as the alternative for 'Superv. 1 source' is changed.
Measurem. unit or mV/V <0>	A suitable engineering unit, depending on the supervised signal, is automatically added. This parameter is shown only if 'Level mode' is selected in 'Superv. 1 mode'.

[index]	Range/Alternative <default value>	Explanation and result of alternatives.
---------	--------------------------------------	--

**Relay 1 source Modbus: 41010 (46010)**  
 [0] Not in use Defines the conditions for activation of Relay 1.  
 [1] In process  
 [2] Level/Setpoint <In process> **Not in use:** Relay 1 is not in use and is deactivated.  
**In process:** Relay 1 active as WST 3 is in operation.  
**Level/Setpoint:** Relay 1 is controlled by the output from Superv. 1.

**Superv. 2 source Modbus: 41012 (46012)**  
 [0] Input sign. mV/V Defines supervision of transducer input signal or  
 [1] Net weight internal weight value for Superv. 2.  
 [2] Gross weight **Input sign. mV/V:** The transducer input is supervised.  
 [3] Disp. weight **Net weight:** The net weight is supervised.  
 [4] Abs.net w. **Gross weight:** The gross weight is supervised.  
 [5] Abs.gross w. **Disp. weight:** The displayed weight is supervised.  
 [6] Abs.disp.w. **Abs.:** Means 'Absolute', supervision of the absolute value of net weight, gross weight, or displayed weight.  
 <Gross weight>

**Superv. 2 mode Modbus: 41014 (46014)**  
 [0] Level mode Defines the operating mode for Superv. 2.  
 [1] Setpoint mode <Level mode> **Level mode:** Supervision of Level 2 value.  
**Setpoint mode:** Setpoint mode selected.

**Level 2 outp. Modbus: 41016 (46016)**  
 [0] Active above This parameter defines the conditions for control of a possible relay output for Superv. 2.  
 [1] Active below <Active above> **Active above:** The relay output will be active as the value of the supervised signal is above Level 2 value.  
**Active below:** The relay output will be active as the value of the supervised signal is below Level 2 value.  
 This parameter is shown only if 'Level mode' is selected in 'Superv. 2 mode'.

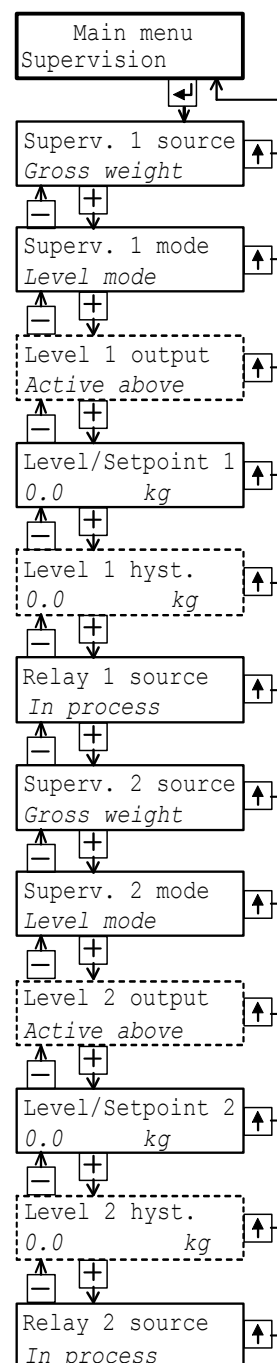

[index]	Range/Alternative <default value>	Explanation and result of alternatives.
<b>Level/Setpoint 2      Modbus: 41018 (46018)</b>		
	Range: +/-999999 or +/-4.0000	Defines the switch level for Level 2 or Setpoint 2. This parameter is automatically set to zero as the alternative for 'Superv. 2 source' is changed.
	Unit: Measurem. unit or mV/V <0>	A suitable engineering unit, depending on the supervised signal, is automatically added.
<b>Level 2 hyst.              Modbus: 41020 (46020)</b>		
	Range: +/-999999 or +/-4.0000	Defines the hysteresis range for Level 2. Positive value gives a hysteresis range above the switch level, negative value gives a hysteresis range below the switch level.
	Unit: Measurem. unit or mV/V <0>	This parameter is automatically set to zero as the alternative for 'Superv. 2 source' is changed. A suitable engineering unit, depending on the supervised signal, is automatically added. This parameter is shown only if 'Level mode' is selected in 'Superv. 2 mode'.
<b>Relay 2 source            Modbus: 41022 (46022)</b>		
[0]	Not in use	Defines the conditions for activation of Relay 2.
[1]	In process	<b>Not in use:</b> Relay 2 is not in use and is deactivated.
[2]	Level/Setpoint <In process>	<b>In process:</b> Relay 2 active as WST 3 is in operation. <b>Level/Setpoint:</b> Relay 2 is controlled by the output from Superv. 2.

[index]	Range/Alternative <default value>	Explanation and result of alternatives.
---------	--------------------------------------	--

### 'Main menu General'

#### Language

- [0] Svenska
- [1] English
- [2] Deutsch
- [3] Français
- <English>

#### Modbus: 41024 (46024)

Defines the language to be used in parameters and messages.

#### Start mode

- [0] Command
- [1] Auto
- <Auto>

#### Modbus: 41026 (46026)

Defines the start mode after power-on or reset.  
**Command:** A 'start operation' command from control computer or panel key is required for start up.  
**Auto:** Automatic start up.

#### Display contrast

- [0] 0
- [1] 1
- [2] 2
- [3] 3
- [4] 4
- [5] 5
- [6] 6
- [7] 7
- <4>

#### Modbus: 41028 (46028)

Defines the contrast for the text in the display window.  
**Low values** giving paler characters but better readability at slanted display.  
**High values** giving sharper characters but reduced readability at slanted display.

#### Zero function

- [0] Off
- [1] On
- <Off>

#### Modbus: 41030 (46030)

**Off:** The view 'Zero setting' is not displayed in the operating mode.  
**On:** 'Zero setting' is displayed in the operating mode.

#### More views

- [0] Off
- [1] On
- <Off>

#### Modbus: 41032 (46032)

**Off:** The views 'Analogue output signal', 'Level settings', 'Input signal', and 'Serial no., Progr.' are not displayed in the operating mode.  
**On:** These views are displayed in the operating mode.

#### Security lock

- [0] Off
- [1] On
- <Off>

#### Modbus: 41034 (46034)

**Off:** No security lock is activated.  
**On:** A security lock is activated, preventing unauthorised entry in Set-up state.

#### Password

- Range:
- 0001 – 9999
- <1937>

#### Modbus: 41036 (46036)

Defines the valid password for the security lock. The code is represented by four asterisks, until editing of the code is started.

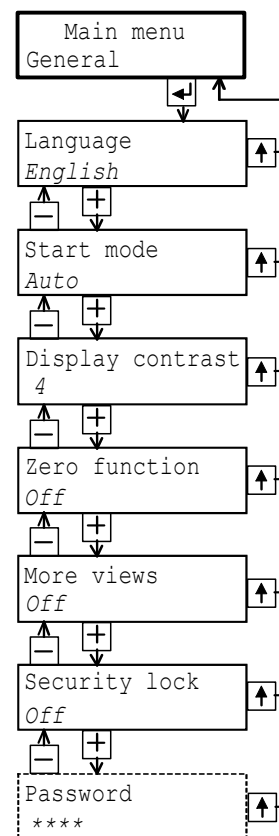

[index]	Range/Alternative <default value>	Explanation and result of alternatives.
---------	--------------------------------------	--

## 'Main menu Analogue output'

### Ana. output type

#### Modbus: 41038 (46038)

[0]	+/-20mA	Defines what type of signal that is used to represent the weight value at the analogue output. <b>+/-20mA, -12-20mA:</b> bipolar current output, <b>0-20mA, 4-20mA:</b> monopolar current output, <b>+/-10V:</b> bipolar voltage output, <b>0-10V:</b> monopolar voltage output. A fix output signal, independent of the weight value, can also be selected. <b>Fixed+/-20mA:</b> fixed current output, <b>Fixed+/-10V:</b> fixed voltage output.
[1]	-12-20mA	
[2]	0-20mA	
[3]	4-20mA	
[4]	+/-10V	
[5]	0-10V	
[6]	Fixed +/-20mA	
[7]	Fixed +/-10V <4-20mA>	

### Analogue source

#### Modbus: 41040 (46040)

[0]	Gross weight	Defines which weight value that should be presented at the analogue output. <b>Gross weight:</b> Gross weight is presented at the analogue output. <b>Net weight:</b> Net weight is presented at the analogue output. <b>Disp. weight:</b> Displayed weight is presented at the analogue output. This parameter is not shown if any "Fixed" output type is selected in 'Ana. output type'.
[1]	Net weight	
[2]	Disp. weight <Gross weight>	

### Ana. range low

#### Modbus: 41042 (46042)

Range:	+/-999999	Defines the weight value that should give the lowest value (0 mA, 4 mA or 0 V) at the analogue output. The value automatically changes to 0 if parameter 'Capacity' in 'Quick set-up' is edited. This parameter is not shown if any "Fixed" output type is selected in 'Ana. output type'.
Unit:		
Measurem. unit	<0>	

### Ana. range high

#### Modbus: 41044 (46044)

Range:	+/-999999	Defines the weight value that should give the highest value at the analogue output. The value changes to the capacity value if parameter 'Capacity' in 'Quick set-up' is edited. This parameter is not shown if any "Fixed" output type is selected in 'Ana. output type'.
Unit:		
Measurem. unit	<500>	

[index]	Range/Alternative <default value>	Explanation and result of alternatives.
---------	--------------------------------------	--

**Fixed ana. outp.**

Range:  
+/-22.00 or  
+/-11.00  
Unit: mA or V  
<0>

**Modbus: 41046 (46046)**

Defines the fixed signal value at the analogue output. The range and unit depends on the alternative for 'Ana. output type', and the value automatically changes to zero each time 'Ana. output type' is changed. This parameter is shown only if a "Fixed" output type is selected in 'Ana. output type'.

**Ana. bandwidth**

[0]	0.05	Hz
[1]	0.1	Hz
[2]	0.2	Hz
[3]	0.5	Hz
[4]	1	Hz
[5]	2	Hz
[6]	5	Hz
[7]	10	Hz
[8]	20	Hz
[9]	50	Hz
[10]	75	Hz
	<10	Hz>

**Modbus: 41048 (46048)**

Defines the bandwidth for the analogue output. **Low bandwidth value improves suppression of unstable transducer signal, but also delays the response to fast transducer signal changes. High bandwidth value gives fast response to transducer signal changes, but reduces the accuracy of the analogue output.** This parameter is not shown if any "Fixed" output type is selected in 'Ana. output type'.

**Ana. low adjust**

Range:  
+/-999  
<0>

**Modbus: 41050 (46050)**

As this parameter is edited, the analogue output is activated with the lowest output signal (0 mA, 4 mA or 0 V). The signal level can be adjusted to give wanted reading at the analogue instrument. The adjustment range corresponds to about ±2 % of maximum analogue output. The parameter value will be set to zero each time 'Ana. output type' is changed.

**Ana. high adjust**

Range:  
+/-999  
<0>

**Modbus: 41052 (46052)**

As this parameter is edited, the analogue output is activated with the highest output signal (20 mA or 10 V). The signal level can be adjusted to give wanted reading at the analogue instrument. The adjustment range corresponds to about ±2 % of maximum analogue output. The parameter value will be set to zero each time 'Ana. output type' is changed.

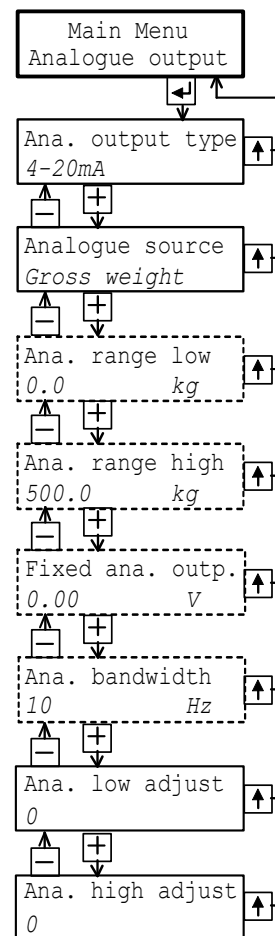

---

[index]	Range/Alternative <default value>	Explanation and result of alternatives.
---------	--------------------------------------	--

---

## 'Main menu Communication'

See section 6.

### Serialport mode

#### Modbus: 41054 (46054)

[0]	Not in use	Defines the serial port use.
[1]	Modbus	<b>Not in use:</b> <i>The serial port is not used.</i>
[2]	Modbus auto	<b>Modbus:</b> <i>Control unit communication.</i>
[3]	External display <Modbus auto>	<b>Modbus auto:</b> <i>The control unit baud rate (from 9600) and bit configuration (8-none-1, 8-even-1 or 8-odd-1) is auto detected and used by WST 3.</i> <b>External display:</b> <i>The serial port is used for transmission of the measurement value to an external display unit.</i>

### Baudrate

#### Modbus: 41056 (46056)

[0]	300	Defines the baud rate for the Modbus communication.
[1]	600	The parameter must be set to the baud rate of
[2]	1200	the Modbus master, or to a baud rate suitable for
[3]	2400	the external display unit.
[4]	4800	This menu is not shown if 'Modbus auto'
[5]	9600	is selected in 'Serialport mode'.
[6]	19200	
[7]	38400	
[8]	57600	
[9]	115200	
	<9600>	

### Data format

#### Modbus: 41058 (46058)

[0]	7-none-2	Defines the bit configuration for the Modbus communication.
[1]	7-even-1	This parameter must be set to the configuration of
[2]	7-even-2	the Modbus master, or to a configuration suitable
[3]	7-odd-1	for the external display unit.
[4]	7-odd-2	This menu is not shown if 'Modbus auto'
[5]	8-none-1	is selected in 'Serialport mode'.
[6]	8-none-2	
[7]	8-even-1	
[8]	8-odd-1	
	<8-none-1>	

### Instrum. address

#### Modbus: 41060 (46060)

Range:	Defines the Modbus address for the WST 3 unit.
1 to 247	Shown only if 'Modbus' or 'Modbus auto' is selected
<1>	in 'Serialport mode'.



[index]	Range/Alternative <default value>	Explanation and result of alternatives.
---------	--------------------------------------	--

<b>Ext. disp.mode</b>		<b>Modbus: 41062 (46062)</b>
[0]	Gross weight	Defines which weight value that should be presented at the external display unit. <b>Gross weight:</b> <i>The gross weight is always presented.</i> <b>Net weight:</b> <i>The net weight is always presented.</i> <b>Disp. weight:</b> <i>The gross weight or net weight is presented.</i> See section 6, Modbus-communication, for further information. This parameter is shown only if 'External display' is selected in 'Serialport mode'.
[1]	Net weight	
[2]	Disp. weight	
	<Gross weight>	

<b>Ext. disp.format</b>		<b>Modbus: 41064 (46064)</b>
[0]	4	Defines the number of digits for the external display unit. See section 6, Modbus-communication, for further information. This parameter is shown only if 'External display' is selected in 'Serialport mode'.
[1]	5	
[2]	6	
[3]	7	
[4]	32 <6 >	

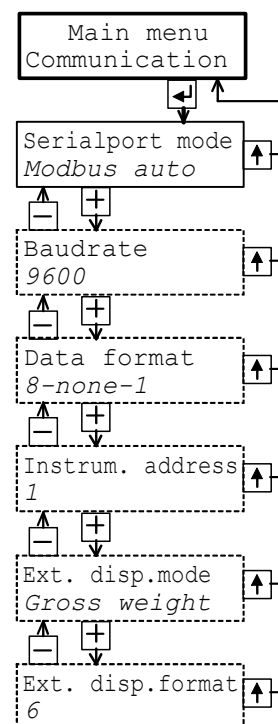

---

[index]	Range/Alternative <default value>	Explanation and result of alternatives.
---------	--------------------------------------	--

---

### 'Main menu Profibus'

See section 7.

#### Profibus address

Range:  
0 to 125  
<126>

#### Modbus: 41066 (46066)

Defines the Profibus address for  
the WST 3 unit.

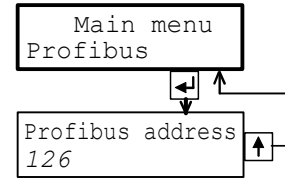

[index] Range/Alternative Explanation and  
<default value> result of alternatives.

### 'Main menu Calibration'

See section 4.

#### Measurement unit

- [0] NONE
- [1] g
- [2] kg
- [3] t
- [4] lb
- [5] N
- [6] kN
- [7] oz
- [8] psi
- [9] kPa
- [10] MPa
- [11] bar
- [12] l
- [13] lbf
- [14] kgf
- [15] PLI
- [16] N/m
- [17] kN/m
- [18] Nm
- [19] daN
- [20] mV/V
- <kg>

#### Modbus: 41068 (46068)

Defines the engineering unit that should be used for the measurement value and for related set-up parameters.

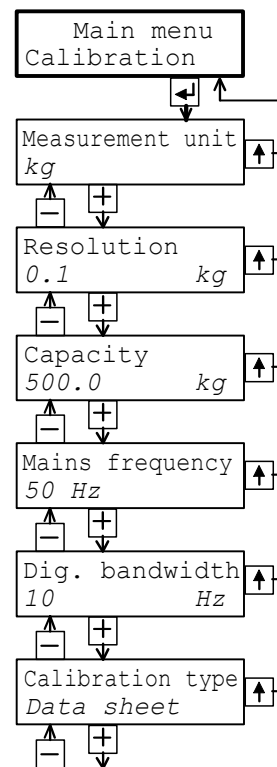

#### Resolution

- [0] 0.001
- [1] 0.002
- [2] 0.005
- [3] 0.01
- [4] 0.02
- [5] 0.05
- [6] 0.1
- [7] 0.2
- [8] 0.5
- [9] 1
- [10] 2
- [11] 5
- [12] 10
- [13] 20
- [14] 50
- <0.1>

#### Modbus: 41070 (46070)

Defines the decimal point position and resolution format for the displayed value. All set-up parameters using the measurement unit will be displayed with the decimal point position selected here. If the last digits of the weight value are not stable, a more coarse resolution can be selected get a stable reading.

[index]	Range/Alternative <default value>	Explanation and result of alternatives.
<b>Capacity</b>		
		<b>Modbus: 41072 (46072)</b>
	Range: 0.5 to 999999 <500>	Defines the nominal range for the analogue output.
<b>Mains frequency</b>		
		<b>Modbus: 41074 (46074)</b>
[0]	50 Hz	Defines a filter for suppression of mains frequency noise. <b>50 Hz:</b> 50 Hz filter activated. <b>60 Hz:</b> 60 Hz filter activated.
[1]	60 Hz	
	<50 Hz>	
<b>Dig. bandwidth</b>		
		<b>Modbus: 41076 (46076)</b>
[0]	0.05 Hz	Defines the bandwidth of a filter for the internal weight value that is displayed at the front panel and can be sent to a connected control unit. <b>Low value:</b> Improves suppression of unstable transducer signal, but delays the response to fast changes in the transducer signal. <b>High value:</b> Gives fast response to changes in the transducer signal, but reduces the accuracy of the value.
[1]	0.1 Hz	
[2]	0.2 Hz	
[3]	0.5 Hz	
[4]	1 Hz	
[5]	2 Hz	
[6]	5 Hz	
[7]	10 Hz	
[8]	20 Hz	
[9]	50 Hz	
[10]	75 Hz	
	<10 Hz>	
<b>Calibration type</b>		
		<b>Modbus: 41078 (46078)</b>
[0]	Data sheet	Defines the type of calibration to be performed. <b>Data sheet:</b> Data sheet calibration is easy to use and doesn't demand any reference equipment, except data from the transducer data sheet. <b>Deadweight:</b> Dead weight calibration is normally the most accurate calibration type. It requires known weights to at least 2/3 of the wanted measuring range. <b>Table:</b> Table calibration is used to enter recorded values from a previous calibration of the measuring equipment to a replacement instrument.
[1]	Deadweight	
[2]	Table <Data sheet>	

[index]	Range/Alternative <default value>	Explanation and result of alternatives.
---------	--------------------------------------	--

**'Data sheet'**

**Conv. factor**

Range:  
0.01 to 99  
<9.80665>

**Modbus: 41080 (46080)**

Defines the relationship between a measurement value expressed in data sheet unit and expressed in the selected measurement unit.

**Number of transd**

Range:  
1 to 4  
<3>

**Modbus: 41082 (46082)**

Defines the total number of transducers and fixed support points in the scale installation. All transducers must have equal rated load.  
If the total number is over 4: enter 1 here.

**Rated load**

Range:  
1 to 999999  
Unit:  
Data sheet unit  
<2000.0>

**Modbus: 41084 (46084)**

Defines the rated load for one transducer, expressed in the unit of the transducer data sheet.  
NOTE! If the data sheet value is 5 kN, the parameter should be set to 5 000 (N).  
If the total number of transducers and fixed supports is over 4: multiply that number with the rated load for one transducer and enter the result here.

**Rated output 1**

Range:  
0 – +9.99999  
Unit: mV/V  
<2.03900>

**Modbus: 41086 (46086)**

Defines rated output for transducer 1, specified in the data sheet.  
If the total number of transducers and fixed supports is over 4: add up all rated output values, divide by the number of transducers, and enter the result here.

**Rated output 2**

Range:  
0 – +9.99999  
Unit: mV/V  
<2.03900>

**Modbus: 41088 (46088)**

Defines the rated output signal for transducer 2.  
The value is specified in the transducer data sheet.

**Rated output 3**

Range:  
0 – +9.99999  
Unit: mV/V  
<2.03900>

**Modbus: 41090 (46090)**

Defines the rated output signal for transducer 3.  
The value is specified in the transducer data sheet.

**Rated output 4**

Range:  
0 – +9.99999  
Unit: mV/V  
<2.03900>

**Modbus: 41092 (46092)**

Defines the rated output signal for transducer 4.  
The value is specified in the transducer data sheet.

**Set zero  
Zero offset**

See under 'Deadweight' on page 3-22

**Modbus: 41102 (46102) and  
Modbus: 41104 (46104)**

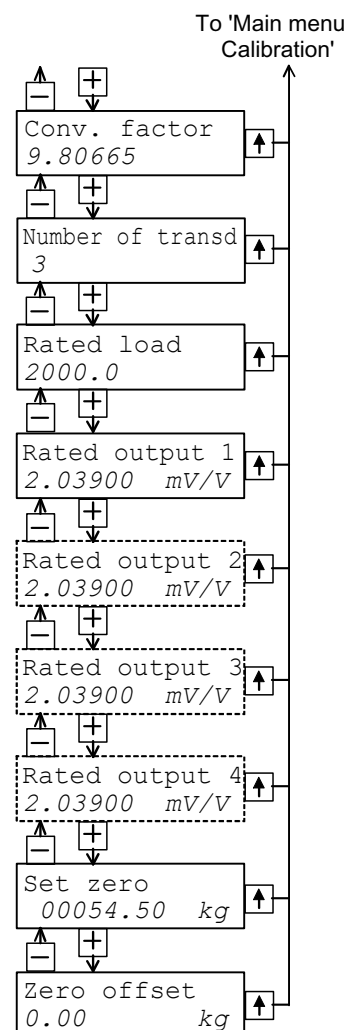

[index]	Range/Alternative <default value>	Explanation and result of alternatives.
---------	--------------------------------------	--

**'Deadweight'**

**Value cal. p.1**

**Modbus: 41094 (46094)**

Range: +/-999999  
 Unit: Measurem. unit  
 <0>

The scale is calibrated in two points, normally unloaded and loaded to at least 2/3 of the wanted range.  
 This parameter defines the load on the scale in the lower calibration point, normally 0.

**Value cal. p.2**

**Modbus: 41096 (46096)**

Range: +/-999999  
 Unit: Measurem. unit  
 <500>

This parameter defines the load on the scale in the higher calibration point, at least 2/3 of the desired range.

**Transd.sign. p.1**

**Modbus: 41098 (46098)**

Range: +/-9.99999  
 Unit: mV/V  
 <0.00000>

This parameter indicates the transducer signal in the lower calibration point.  
 The value cannot be edited.

**Transd.sign. p.2**

**Modbus: 41100 (46100)**

Range: +/-9.99999  
 Unit: mV/V  
 <1.66631>

This parameter indicates the transducer signal in the higher calibration point.  
 The value cannot be edited.

**Set zero**

**Modbus: 41102 (46102)**

Range: +/-999999  
 Unit: Measurem. unit  
 <'Live'>

The actual weight value is displayed.  
 Enter the wanted value for the actual load, usually '0', i.e. unloaded scale.  
**NOTE! This parameter should be used for zeroing of the instrument.**

**Zero offset**

**Modbus: 41104 (46104)**

Range: +/-999999  
 Unit: Measurem. unit  
 <0>

This parameter indicates the offset value acquired by zeroing in 'Set zero'.  
 If this parameter is edited, the zeroing will be influenced.

To 'Main menu  
 Calibration'

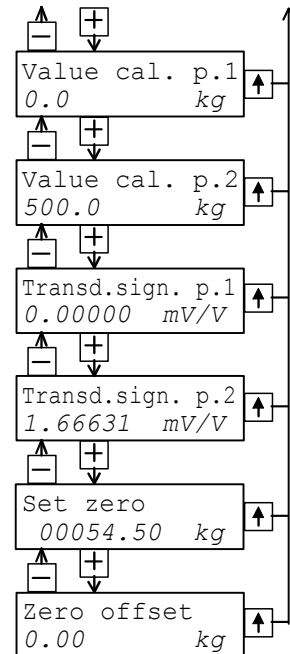

[index]	Range/Alternative <default value>	Explanation and result of alternatives.
---------	--------------------------------------	--

**'Table'**

**Value cal. p.1**                      **Modbus: 41094 (46094)**  
 Range:                                  Calibration with recorded  
 +/-999999                              values from a previous dead  
 Unit:                                      weight calibration.  
 Measur. unit                          This parameter should be set  
 <0>    to the recorded value for  
     the load on the scale in  
     the lower calibration point.

**Value cal. p.2**                      **Modbus: 41096 (46096)**  
 Range:                                  This parameter should be set  
 +/-999999                              to the recorded value for  
 Unit:                                      the load on the scale in  
 Measur. unit                          the higher calibration point.  
 <500>

**Transd.sign. p.1**                    **Modbus: 41098 (46098)**  
 Range:                                  This parameter should be set  
 +/-9.99999                              to the recorded value of  
 Unit: mV/V                              the transducer signal in  
 <0.00000>                              the lower calibration point.

**Transd.sign. p.2**                    **Modbus: 41100 (46100)**  
 Range:                                  This parameter should be set  
 +/-9.99999                              to the recorded value of  
 Unit: mV/V                              the transducer signal in  
 <1.66631>                              the higher calibration point.

**Set zero**                              **Modbus: 41102 (46102) and**  
**Zero offset**                        **Modbus: 41104 (46104)**

See under 'Deadweight' on page 3-22

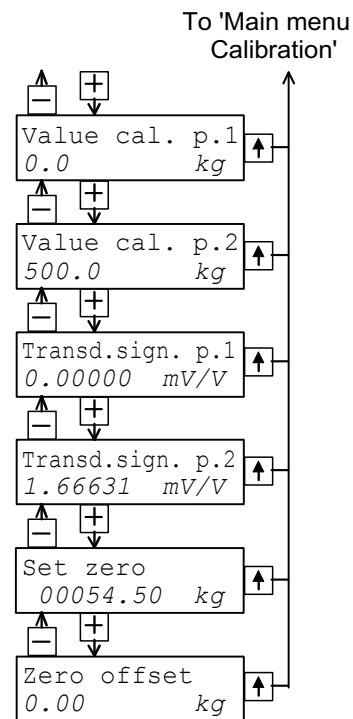

[index]	Range/Alternative <default value>	Explanation and result of alternatives.
---------	--------------------------------------	--

## 'Main menu Diagnostics'

<b>Status input 1</b>	<b>Modbus: 41360 (46360)</b>	
[0]	Off	Displays the status of digital input 1.
[1]	On	No changes can be made.
<b>Status input 2</b>	<b>Modbus: 41362 (46362)</b>	
[0]	Off	Displays the status of digital input 2.
[1]	On	No changes can be made.
<b>Test relay 1</b>	<b>Modbus: 41364 (46364)</b>	
[0]	Off	This parameter controls the status for relay 1.
[1]	On	<b>Off:</b> Relay 1 is deactivated.
	<Off>	<b>On:</b> Relay 1 is activated.
<b>Test relay 2</b>	<b>Modbus: 41366 (46366)</b>	
[0]	Off	This parameter controls the status for relay 2.
[1]	On	<b>Off:</b> Relay 2 is deactivated.
	<Off>	<b>On:</b> Relay 2 is activated.
<b>Test ana. outp.</b>	<b>Modbus: 41368 (46368)</b>	
Range:		Setting of a fixed value at the analogue output.
+/-11 or +/-22		A suitable unit is added automatically.
Unit: mA or V		
<0>		

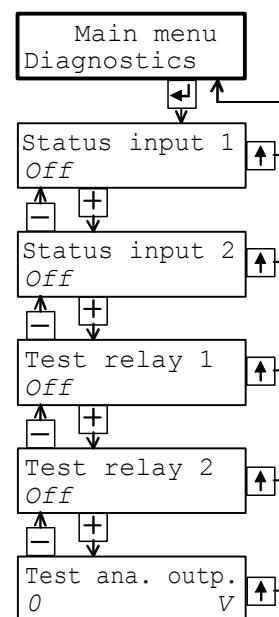

## 'Main menu Exit set-up'

### Save changes?

Range: To exit from Set-up state, press **←** in 'Main menu Exit set-up'.  
 No, Esc. If any parameter values have been changed 'Save changes? No Esc. Yes' is displayed.  
 Yes (Press **↑** if you do not wish to exit from the Set-up state.)

Press **←** (Yes) to exit from Set-up state and save the new parameter values.  
 Press **—** (No) to exit from Set-up state and cancel the new parameter values.

This finishes the set-up operation, WST 3 will switch over to the operating mode, displaying the 'Weight value'.

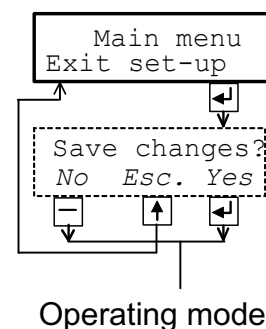



# 4. Calibration

## General

When measuring with WST 3, the transducer output signal, corresponding to the transducer load, is converted to weight value and presented at the analogue output, at the WST 3 panel or at a connected control unit. The conversion is controlled by several parameter values, defined in the calibration.

Three calibration types are supported in WST 3:

- **Data sheet calibration** - entry of values from the transducer data sheet.
- **Dead weight calibration** - entry of values at certain known loads.
- **Table calibration** - entry of recorded values from a previous calibration.

It is recommended to start with a data sheet calibration, which is easy to accomplish and will give a fairly good accuracy.

To get the best accuracy a dead weight calibration, with known loads to at least 2/3 of the measuring capacity, must be performed.

After calibration the parameter values should be recorded. See appendix 1.

If the transmitter module must be replaced, the recorded values can be used to make a table calibration for the new module.

All calibration parameters are gathered under 'Main menu Calibration'.

See section 3 Set-up, Parameters and figure 8.

In weighing applications it is essential for correct results that fixed mechanical connections to the scale are avoided. Necessary connections must be flexible and perpendicular to the measuring direction. If the scale has several transducers connected in parallel, they must have the same rated load and impedance.

If fixed supports and transducers are combined, the load must be evenly distributed on all the support points.

DATA AND CALIBRATION SHEET				ArtNo: 1130480
LOAD CELL	KIS-3		S/N 322471	
RATED LOAD (R.L.)	10	kN	EXCITATION VOLTAGE, RECOMMENDED	10 V AC OR DC
			EXCITATION VOLTAGE, MAXIMUM	18 V AC OR DC
OVERLOAD, SAFE	100	% R.L.		
OVERLOAD, ULTIMATE	200	% R.L.	INPUT RESISTANCE 350 +/- 3 OHMS INCL. STANDARD CABLE	
			OUTPUT RESISTANCE 350.1 OHMS INCL. STANDARD CABLE	
SIDE LOAD, SAFE	100	% R.L.	TEMPERATURE RANGE	-40 TO +80 DEGREES C
SIDE LOAD, ULTIMATE	200	% R.L.		
ELECTRICAL CONNECTION	SHIELDED 4-CONDUCTOR CABLE		TEMPERATURE EFFECT (-10 TO +50 DEGREES C)	
EXCITATION POSITIVE:	RED			
EXCITATION NEGATIVE:	BLACK		ON OUTPUT	0.001 % OF OUTPUT PER DEG. C
SIGNAL POSITIVE:	GREEN			
SIGNAL NEGATIVE:	WHITE		ON ZERO BALANCE	0.001 % OF R.O. PER DEG. C
-----				
RATED OUTPUT (R.O.) (TOLERANCE 0.1 %)			2.0394 mV/V	
NONLINEARITY (BEST FIT THROUGH ZERO)	+/-		0.010 % R.O.	
ZERO BALANCE			+0.0 % R.O.	
CREEP 5 MINUTES			+0.001 % R.O.	
CALIBRATION VALUES (TOLERANCE 0.1 %) SHUNT RESISTOR CONNECTED BETWEEN 'EXCITATION NEGATIVE' AND 'SIGNAL NEGATIVE'				
40 KOHMS CORRESPOND TO			9.9111 kN	
80 KOHMS CORRESPOND TO			4.9683 kN	
THE VALUES INDICATED FOR OUTPUT VOLTAGE AND CALIBRATION VALUES ARE APPLICABLE AT OPEN CIRCUIT WITHOUT EXTERNAL BALANCING RESISTORS AND WITH A CONNECTING CABLE OF STANDARD LENGTH.				
Vishay Nobel AB S-691 27 KARLSKOGA			KARLSKOGA 03-04-30	

Figure 10. Each transducer from Nobel Weighing Systems is delivered with a detailed data and calibration sheet.

## Common calibration parameters

For all the calibration types, measurement unit and resolution for the weight value and some other characteristics must be specified. The sequence of these parameters, common for all calibration types is given on pages 3-19 and 3-20.

The parameter 'Measurement unit' defines the engineering unit used for the weight value. This engineering unit will also be used for the Resolution and Capacity, for the Supervision function and for set-up of the analogue output.

The 'Resolution' parameter defines the number of decimals and the resolution for the weight value, displayed at WST 3 or transmitted to external equipment. If the weight value is unstable, reduced resolution will give a more stable reading with reduced accuracy.

'Capacity' is a parameter, defining which weight value that will give full range signal at the analogue output.

(The weight values corresponding to the highest and the lowest analogue output signals are also set by parameters under 'Main menu Analogue output'.)

The parameter 'Mains frequency' controls filters for suppression of induced low frequency noise. It should be set to the surrounding mains frequency.

The parameter 'Dig. bandwidth' controls the filtering of the internal measurement signal. Low digital bandwidth gives a suppression of oscillations in the signal, making the reading more stable. High digital bandwidth makes it possible to detect fast changes in the measurement value.

In the following parameters under 'Calibration', calibration type and parameter values for the latest performed calibration are displayed.





If 'Calibration type' is not edited, the values from previous calibration, including the zero offset value, will be displayed for the parameters.

If 'Calibration type' is edited, even if it is not changed, the zero offset value will be set to zero, so at least a new zeroing is required.

Editing of parameter values, including the type of calibration, should be performed according to instructions on page 3-9.

Example:

Select a different type of calibration in 'Calibration type'

1. As menu 'Calibration type' is displayed, press  and a cursor will make the first character on the lower line blinking.
2. Find the wanted calibration type, using the key  or  until the correct alternative is displayed.
3. Accept the displayed calibration type by pressing  for 2 seconds. The cursor disappears and the selected calibration type will be displayed.

## Data sheet calibration

Data sheet calibration is the default value for 'Calibration type' because it is recommended as first-time calibration for WST 3. An accuracy of 0.1 % can be obtained without use of known loads etc. By data sheet calibration in weighing applications it is essential that no external forces influence the scale installation. In data sheet calibration, values from the transducer data sheets should be entered as parameter values.

### Conv. factor

The transducer is often calibrated in an engineering unit, which differs from the unit of the displayed measurement value. This parameter defines a constant by which a weight value, expressed in the measurement unit, should be multiplied to be expressed in the data sheet unit.

When using a transducer, calibrated in Newton, in a scale displaying weight values in kg, the 'Conv. factor' shall be the local gravitation constant in  $m/s^2$ .

The default value, 9.80665, is an international mean value for the gravitation constant (world-wide range 9.78 – 9.83).

If the data sheet unit is the same as the measurement unit, the conversion factor parameter value should be set to 1.0000.

### Number of transd

In weighing applications the load on the scale may be supported by several transducers and fixed supports. This parameter value defines the total number, up to four, of transducers and fixed support points.

If the scale has more than four support points this parameter should be set to '1' and the parameter value for 'Rated load' and 'Rated output 1' should be calculated.

### Rated load

Rated load for the used transducer type, expressed in the data sheet unit used to calculate the conversion factor, should be entered as parameter value.

NOTE! If the data sheet value is 5 kN, this parameter should be set to 5 000 (N).

If several transducers are used in a scale, they must all have the same rated load.

If the scale has more than four support points, 'Number of transd' should be set to '1' and the value of this parameter should be calculated as:

rated load for one transducer, multiplied by the total number of support points.

### Rated output 1



Rated output is given in the data sheet for every transducer and should be entered here. Similar parameters follow for the number of support points indicated in 'Number of transd'. For fixed supports, the rated output value is 0.00000 (mV/V).

If the scale has more than four support points, 'Number of transd' should be set to '1' and the parameter value for 'Rated output 1' should be calculated as: the mean value of rated output for all active transducers.

### Set zero

After the data sheet values have been entered as parameter values, the instrument will perform necessary calculations, and a weight value corresponding to the actual load on the transducer will be displayed here.

The parameter value is set to zero as  (enter) is pressed.

This zero value can be accepted, if  is pressed for 2 seconds, or edited (numerical value) and then accepted, if  is pressed for 2 seconds.

### Zero offset

This parameter indicates the zero offset value needed to get the 'zero' value, selected for the parameter 'Set zero'.

## Dead weight calibration

This is normally the most accurate calibration type. The transducer signal is measured and stored together with the entered value of the known load (expressed in the selected measurement unit) for two calibration points. It is essential for good accuracy to utilise calibration points in both ends of the measuring range, for example at zero load and at least 2/3 of rated load. Make a manual record of all values, see appendix 1!

### **Value cal. p.1,**

Apply a well-defined low load on the scale, normally 0 (zero), and enter the value of the load as parameter value. The entered load value and corresponding transducer signal value are saved in the instrument.

### **Value cal. p.2**

Apply a well-defined high load on the scale, at least 2/3 of the rated load, and enter the value of the load as parameter value. The entered load value and corresponding transducer signal value are saved in the instrument.

### **Transd.sign. p.1,**

This parameter indicates the stored transducer signal value for the low calibration point. The parameter value cannot be edited.

### **Transd.sign. p.2**

This parameter indicates the stored transducer signal value for the high calibration point. The parameter value cannot be edited.

### **Set zero**

See Data sheet calibration on page 4-3.

### **Zero offset**

See Data sheet calibration on page 4-3.

## Table calibration

The table calibration can be used to copy values from a dead weight calibration for WST 3 to a replacement instrument. It is necessary to have access to recorded values from a dead weight calibration in two points.

As Table calibration is selected, the 'zero offset' value is not set to zero.

### **Value cal. p.1, Value cal. p.2**

These parameter values should be set to the recorded weight values from a previous calibration for the low calibration point (p.1) and the high calibration point (p.2).

### **Transd.sign. p.1, Transd.sign. p.2**

These parameter values should be set to the recorded transducer signal values from a previous calibration for the corresponding calibration points.

### **Set zero**

See Data sheet calibration on page 4-3.

### **Zero offset**

See Data sheet calibration on page 4-3.

## 5. Operation

### General

Operation control and parameter set-up of WST 3 can be performed locally from the function keys and display window at the front panel, via serial communication from a control unit, or via the fieldbus Profibus-DP.

### Power supply

The transmitter is powered from 24 VDC and the power should not be turned off during weekends and over-night. Continuous power supply to electronics and transducer prevents moisture condensation in the units.

### Power-up sequence

When WST 3 is powered up it displays 'WST 3', the programme name, and the serial number of the module for about five seconds while a number of internal tests are performed.

If any error is detected the power-up sequence stops and an error code is displayed. See section Troubleshooting for further information.

If no errors are detected the module enters the operating mode (by automatic start-up), displaying the weight value and relay status, or the module enters the 'Wait for start' state (by operator start-up), displaying the text 'Press ENTER to start operation!'. Automatic or operator start-up is selected with the set-up parameter 'Start mode' under 'Main menu General'.

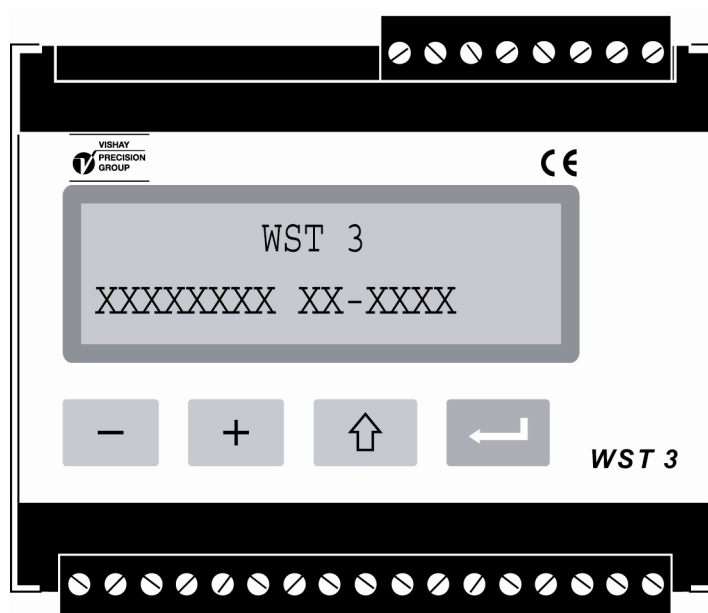

Figure 11. The front panel of WST 3 during the power-up sequence.

## Display views in Operating mode

Figure 12.

For WST 3 in the operating mode, two of the display views, Weight value and Profibus status, are always available. The other views can be set On or Off by parameters under 'Main menu General'.

The panel keys **-** and **+** are used to select among the available views.

WST 3 can always be switched over to Weight value with a quick activation of key **↑**.

From any of the above display views, WST 3 can be switched over to Set-up state:

- to 'Quick set-up' if the key **↑** is pressed for 2 seconds. See figure 7.
- to 'Normal set-up' if **↑** and **+** are pressed for 2 seconds. See figure 8.

In 'Weight value', and in some other views, an area to the right on the bottom line displays the Modbus-address or information about the serial communication:

That the Modbus-address is displayed indicates communication with the control unit.

That 'EXT' is displayed indicates communication to an external display unit.

No indication in the area means that the serial communication is not in use.

### Weight value

This is the first view displayed after power-up, reset or set-up operations.

The upper line displays the actual measurement value as net weight or gross weight:

Net weight if 'Net' is displayed to the left on the line, in other case gross weight.

The lower line displays the status for the used relays, R1:/R2: '1' = On or '0' = Off, followed by the area with the Modbus address or information about the serial communication.

### Zero setting

This view can be set On or Off by parameter 'Zero function'.

The view displays the actual weight value as net weight ('Net') or gross weight.

As the gross weight value is displayed, it can be set to zero by ENTER (the key **↵**).

By zero setting of the gross weight, the actual tare value is also set to zero.

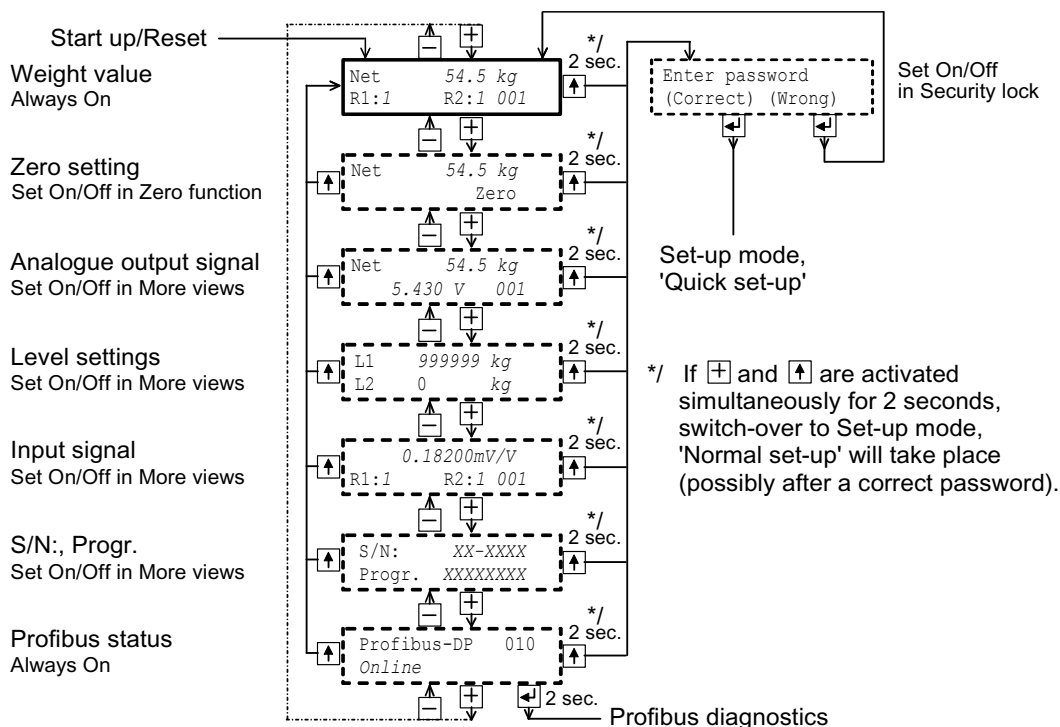

Figure 12. The number of views available in the operating mode depends on several parameter settings.

**Analogue output signal**

This view can be set On or Off by parameter 'More views'.

The upper line displays the actual weight value as net weight ('Net') or gross weight.

The lower line displays the signal at the analogue output, a value in V or mA depending on the choice for parameter 'Ana. output type', followed by the area with the Modbus address or information about the serial communication.

**Level settings**

This view can be set On or Off by parameter 'More views'.

At the upper line the switching level for 'Level/Setpoint 1' is displayed.

At the lower line the switching level for 'Level/Setpoint 2' is displayed.

**Input signal**

This view can be set On or Off by parameter 'More views'.

The upper line displays the actual transducer input signal in mV/V.

The lower line displays the status for the used relays, R1:/R2: '1' = On or '0' = Off, and an area with the Modbus address or information about the serial communication.

**S/N:, Progr.**

This view can be set On or Off by parameter 'More views'.

The upper line displays the serial number for the WST 3 module and

the lower line displays the name of the installed programme.

**Profibus status**

This view is always available. The upper line displays the Profibus address for the module and the lower line contains status information for the Profibus communication.

See page 8-6 for an explanation of the status information.

## Taring

Taring is performed as digital input IN1 (terminal 15) is activated with 24 VDC. It means that the actual gross weight is stored as tare value and that WST 3 is switched over to display of net weight. The net weight is the difference between the gross weight and the stored tare value.

Taring of WST 3 can always be performed by a valid weight.

The tare value is automatically set to zero by zero setting of the WST 3.

## Display of Gross/Net

By weight display, a field to the left on the same line displays 'Net' when a net weight is displayed. If the field is empty, a gross weight is displayed.

Switching between display of net weight and gross weight takes place as digital input IN2 (terminal 16) is activated with 24 VDC.

## Zero setting

A basic zero setting of the gross weight is normally performed during calibration of the weighing equipment. If the weighing equipment is changed later another calibration, or at least the zero setting of the calibration, should be performed.

Minor correction of the zero setting may be needed. It can be performed rapidly from the view Zero setting as a gross weight is displayed. The view Zero setting can be activated by parameter 'Zero function' in Main menu 'General'.

By zero setting of the gross weight, the actual tare value is also set to zero.

## Analogue output

WST 3 has an analogue output with several voltage and current ranges.

The range limits are very precise, but minor adjustment can be done to adapt the output to the external equipment.

A separate analogue output filter with a wide span of variable bandwidth can be set to reduce oscillation of the output signal, or to enable registration of fast changes by the analogue output.

If an error occurs, the analogue output signal will be set to 0 V / 0 mA.

One way to select the range for the measurement value, presented at the analogue output, is by parameter 'Capacity' in 'Quick set-up'.

Another way is to select any measurement value for the lowest and for the highest output signal respectively under 'Main menu Analogue output'.

The analogue output can also be set to precise, fixed voltage or current output levels, independent of the internal weight value.

## Supervision, output relays

The supervision function has two separate channels. For each channel parameters are used to select a signal to supervise, to select level mode or setpoint mode, and to set the desired operation. The set-up parameters for the supervision are described in detail on pages 3-10 to 3-12.

To give fast response WST 3 uses the bandwidth of the analogue or digital filter, whichever is the highest, for the supervision channels.

WST 3 has two relays with switching contact that can be used to indicate the status of the supervision channels, or to indicate the status of the signal 'In process'.

If an instrument error occurs both relays will be deactivated.

The status of the supervision channels is also available on the Profibus/Modbus communication.

### **Superv. 1 mode, Superv. 2 mode**

With these parameters the supervision can be set to Level mode or Setpoint mode.

The choice determines which more parameters that will be available.

### **Level mode**

As the supervision mode for a channel is set to 'Level mode', the following parameters under 'Main menu Supervision' can be used to select a signal source and to set the level value, the desired hysteresis range, the output function, and which relay to possibly control.

Actual status for the Level mode (signal above or below Level and status of a possible relay) can be read from a connected control unit (Modbus or Profibus).



At power-up, after reset or after set-up the Level value for each channel is fetched from the set-up parameters stored in the instrument. During operation this Level value can be altered temporarily from a connected control unit ('Level/Setpoint 1' (register 40031-33, 40234-35, 45234-35) and 'Level/Setpoint 2' (register 40034-36, 40236-37, 45236-37) respectively). During normal operation the set Level value is continuously supervised.

#### **Superv. 1 source, Superv. 2 source**

Several signals can be selected as signal source for the supervision channels: Input signal mV/V, Net weight, Gross weight, Displayed weight, and the absolute weight values, i.e. weight values without regard to their polarity.

#### **Superv. 1 mode, Superv. 2 mode**

This parameter has been used to select Level mode for the channel.

#### **Level 1 output, Level 2 output**

With these parameters the function of a possible relay output for the supervision function can be selected as active for signal levels above or below the set level value.

#### **Level/Setpoint 1, Level/Setpoint 2**

With these parameters the level value for each channel can be set to negative or positive values within a wide range. A suitable measurement unit is automatically added, depending on the supervised signal source.

During operation these Level values can be altered temporarily from a connected control unit (Modbus or Profibus).

#### **Level 1 hyst., Level 2 hyst.**

These parameters define the width of the hysteresis ranges for the Levels.

The definition of a negative hysteresis range starts with a minus sign (-).

Hysteresis is an intentional difference between the switch levels for increasing and decreasing signal value. One switch level is always at the defined Level. The other switch level is at a higher level by positive hysteresis, at a lower level by negative hysteresis. See figure 13.

#### **Relay 1 source, Relay 2 source**

WST 3 has two internal relays. When they are used they can be controlled by the signal 'In process' or by the supervision channels.

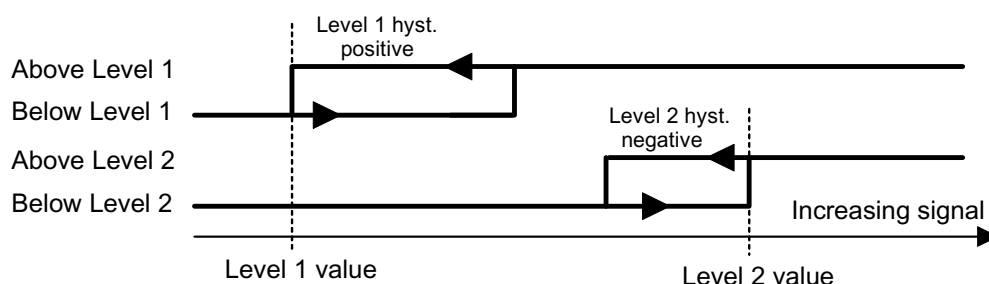

Figure 13. Example of hysteresis influence on the Level supervision function. Level 1 having positive hysteresis and Level 2 having negative hysteresis.

## Setpoint mode

The two Setpoints can be used for fast, accurate and reliable supervision of weight values. The Setpoint function is of a one shot type, the function is activated by a command from the master computer/PLC and deactivated when the weight has reached the Setpoint value.

The status of the Setpoints can be found in modbus register "Status 2".

The Setpoints can only be controlled from the system master computer/PLC via Modbus or Profibus communication. The Setpoints are written to modbus registers and commands can be sent to the instrument by loading the command number into the "Command register". By Modbus communication it is also possible to set the corresponding "Coil", using modbus function 15.

At power-up, after reset or after set-up the Setpoint value for each channel is fetched from the set-up parameters stored in the instrument. During operation this Setpoint value can be altered temporarily from a connected control unit (Modbus or Profibus).

### Superv. 1 source, Superv. 2 source

Several signals can be selected as signal source for the supervision channels: Input signal mV/V, Net weight, Gross weight, Displayed weight and the absolute value of these weight values. Absolute value supervision means supervision of a value without regard to its polarity.

### Superv. 1 mode, Superv. 2 mode

This parameter has been used to select Setpoint mode for the channel.

### Level/Setpoint 1, Level/Setpoint 2

With these parameters the Setpoint for each channel can be set to negative or positive values within a wide range. A suitable measurement unit is automatically added, depending on the supervised signal source. During operation these values can then be altered temporarily from a connected control unit (Modbus or Profibus).

### Relay 1 source, Relay 2 source

WST 3 has two internal relays. When they are used they can be controlled by the signal "In process" or by the supervision channels.

## Using the setpoint function

The wanted setpoints (weight levels) must be loaded into the modbus registers 'Level/Setpoint 1' (register 40031-33, 40234-35, 45234-35) and 'Level/Setpoint 2' (register 40034-36, 40236-37, 45236-37) respectively.

The setpoint(s) are activated by sending command "Activate setpoint 1", "Activate setpoint 2" or "Activate setpoint 1 and 2" to the instrument (command 1, 3 and 5).

If a setpoint is connected to a relay output, that output is then activated.

When the selected weight value becomes higher than the setpoint value, the setpoint function is deactivated and the corresponding "Setpoint X cycle done" bit is set.

A possible connected relay output is also deactivated at the same time.

The setpoint function, and possible connected relay outputs, can also be deactivated by sending command "Deactivate setpoint 1", "Deactivate setpoint 2" or "Deactivate setpoint 1 and 2" (command 2, 4 or 6).

NOTE The "Setpoint X cycle done" bit for a setpoint is reset when the setpoint value is loaded and when the setpoint is activated.

## 6. Modbus communication

The transmitter WST 3 has one serial communications port, primarily used for communication by Modbus with a control unit. Alternatively it can be used for data transmission to an external display unit.

### Communication interface

The serial communication utilises RS-485 for 2-wire or 4-wire. RS-485 is an interface working with differential voltages, giving a noise resistant transmission in a network with several units and long distances. The control unit (master) must have an asynchronous communication port for RS-485, or use a converter, e.g. Westermo MA-45 for RS-232 to RS-485 conversion.

If 2-wire transmission is used, the control unit must be capable of data flow direction control or utilise a converter for automatic data flow direction control e.g. Westermo MA-45.

When 4-wire transmission is used, no data flow direction control is needed.

### Line termination

To ensure good communication, the RS-485 transmission line requires correct termination at both ends. In the WST 3 unit, fail-safe resistors are always included, but at the last unit on the transmission line, terminating resistor(s) must be connected, see section Installation.

If the control unit is connected at one end of the transmission line, refer to the computer manual for line termination.

### Transmission principles

All the WST 3 units connected to the network can listen to what is transmitted in the network, but only one unit at a time can transmit. A time-sharing principle is needed to allow communication in both directions (half duplex).

All communication in the network must be initiated by the control unit (master). When WST 3 is working together with a master the WST 3 units are all slaves, only allowed to reply to master commands. As the master has addressed a command message to a specific slave unit, it listens for the reply during a specified time, before sending next command message.

If the reply from a slave unit fails it may be due to:

- Mismatch in communication parameters. (baud rate, address, . . .)
- More than one slave unit has been transmitting at the same time. This can distort the reply message and make it impossible to decode.

# Modbus

## General

The Modbus protocol is a standard protocol, used for master/slave communication in the industry. The WST 3 implementation works with the Modbus RTU (the ASCII format is not supported).

Information is transmitted in blocks of data to minimise polling and response time delays. For example the error register, status register and weight register could be read with one command to the WST 3.

When a command that cannot be performed is sent, the WST 3 responds with an exception code. For a better explanation of the error, a special error register could be read.

Depending on the type of the communicating equipment (the master) used, the commands in the application programme (PLC programme, or PC programme) may be different from type to type. However, if the master is not a Modicon PLC system, then the Modbus implementation in the master must have some cross-reference function to transfer the Modbus register and I/O bit numbering to the masters own register and I/O bit numbering. All registers and coils described in this manual use the standard Modbus (Modicon) register and I/O numbering. See the masters own Modbus driver documentation for how the commands should be activated in the masters application programme.

Many manufacturers of PLC systems and HMI or SCADA programmes can deliver drivers for Modbus. Several Modbus drivers for Windows applications are also available.

For detailed information about the Modbus protocol see:  
Modicon Modbus Protocol Reference Guide PI-MBUS-300 Rev.D.

## Setup of Modbus communication

- Set parameter 'Serialport mode' (in 'Main menu Communication') to 'Modbus auto'. The baud rate and bit settings will be auto detected. As an alternative the parameters can be set manually.
- As default the WST 3 will have the Modbus address 001. If more than one WST 3 is used in a network, each WST 3 must be given a unique address in parameter 'Instrum. address'. (In some views the address is shown in the lower right corner of the WST 3 display, and when a correct message is received, it flashes.)

## Register description

WST 3 simulates a number of Modicon 'Holding Registers' (registers 4XXXX ... ). The Modbus function 03 'Read Holding Registers' should be used to read these registers and the Modbus function 05 'Preset Single Register' or 16 'Preset Multiple Registers' should be used to write to the registers. See section **Data representation** for a description of the data formats used.

The following table is a summary of the Modbus registers in the WST 3.

The leftmost column holds the registers that should be used when float numbers can't be read, and the next two columns hold the register numbers for parameters in float format.

A good way to find out which of the float formats that should be used is to read the 'Instrument type' register (40200/45200) which should equal '2004' for WST 3.

## General registers

Register area Integer	Register area Float (2 reg./value)	Register area Modicon float (2 reg./value)	Explanation	R/W
40001 (1 reg)	40200	45200	Instrument type	R
40002 (1 reg)	40202	45202	Program number	R
40003 (1 reg)	40204	45204	Program version	R
40004 (3 reg)	40208	45208	Serial number	R
40007 (1 reg)	40210	45210	Command error	R
40008 (1 reg)	40212	45212	Instrument state	R
40009 (1 reg)	40214	45214	Instrument error	R
40010 (1 reg)	40216	45216	Status 1	R
40011 (1 reg)	40218	45218	Status 2	R
40012 (3 reg)	40220	45220	Gross weight	R
40015 (3 reg)	40222	45222	Net weight	R
40024 (3 reg)	40228	45228	Analogue output value	R
40027 (3 reg)	40230	45230	Input signal (mV/V)	R
40030 (1 reg)	40232	45232	Command register	R/W */
40031 (3 reg)	40234	45234	Level/Setpoint 1	R/W
40034 (3 reg)	40236	45236	Level/Setpoint 2	R/W
40037 (3 reg)	40238	45238	Analogue fixed value	R/W

**Important: The registers 'Gross weight' and 'Net weight' are valid only when register 'Instrument error' equals 'zero'. Therefore it is wise to read them together with register 'Instrument error'.**

\*/ The read value is always 'zero'.

### Instrument type

This register holds the type of the instrument. For WST 3 this value is 2004.

### Program number

This register holds the program number of the WST 3. Normal programs have a value below 100 and special programs a value above 100.

### Program version

This register holds the program version of the WST 3. The value 100 means 1.00.

### Serial number

This register holds the instrument serial number. The value 991000 means 99-1000. This can be used by the master to make sure an instrument with a specific serial number is used for a special process.

### Command error

This register holds the error code when a command has been sent to the WST 3. A command that gives 'exception response' 03 or 07 will generate an error code in this register, giving a better description of the problem. For an explanation of the error codes see chapter 8 Troubleshooting. Normally this register should contain '00' which means no error. Error codes 100 to 65535 are valid in this register.

## Instrument state

This register contains the state of the WST 3 unit.

Code	Description
00	<b>'Starting up' state.</b> The instrument is starting up after a reset or power on.
01	<b>'Wait for start' state.</b> The WST 3 is waiting for a start command to go in process.
02	<b>'Normal' state.</b> There are no parameter errors in the system. <b>Note:</b> 'Normal state' is still indicated by weight errors.
03	<b>'Local Set-up' state.</b> Someone is modifying the set-up parameters from the WST 3 front. It's not possible to enter Remote Set-up or Remote Restore state from here.
04	<b>'Remote Set-up' state.</b> A master computer is modifying the set-up parameters in the WST 3. It's not possible to enter Local Set-up state from here.
05	<b>'Remote Restore' state.</b> A master computer is restoring a full set-up to the WST 3. It's not possible to enter Local Set-up state from here.
06	<b>'Error' state.</b> An error has been detected during start up of the instrument.
07	<b>'Fatal error' state.</b> An error has been detected during start up of the instrument. It's not possible to enter any other state from here.
08	<b>'Test' state.</b> WST 3 is running in a special mode used for service and production test.
99	<b>'Boot' state.</b> The WST 3 is ready to receive a new program version.

## Instrument error

This register holds the error code in the WST 3, for example weight, RAM, Flash, EEPROM errors. For an explanation of the error codes, see chapter 8 Troubleshooting. Normally this register should contain '00' which means no error. Error codes 000 to 099 are valid in this register.

**Status 1**

Status bits set to 1 in this register have the following meaning:

Bit no	Function	Comment
0	Net weight > INT size	Net weight value in 'scaled integer' format occupies more than one register. (See description of data representation.)
1	Gross weight > INT size	Gross weight value in 'scaled integer' format occupies more than one register. (See description of data representation.)
2	–	
3	–	
4	–	
5	–	
6	Net mode	'1' = Net mode, '0' = Gross mode.
7	–	
8	–	
9	–	
10	–	
11	–	
12	Net weight > 6 digits	The net weight value is out of precision and should normally not be used.
13	Gross weight > 6 digits	The gross weight value is out of precision and should normally not be used.
14	–	
15	–	

**Note:** When the bits of this register are read as a float value, see description of Data representation.

## Status 2

Status bits set to 1 in this register have the following meaning:

Bit no	Function	Comment
0	Output 01 activated	Internal relay 1 activated
1	Output 02 activated	Internal relay 2 activated
2	–	
3	–	
4	Programme reset	The bit is set each time the programme starts, and it indicates that volatile data is lost. The bit is deleted as Status 2 is read for the first time after reset/power-up, but the reply contains the set bit if it was set.
5	–	
6	Fixed analogue output	'1' = Fixed analogue '0' = Normal analogue
7	Digital input 1 activated	There is a 24V signal on digital input 01.
8	Digital input 2 activated	There is a 24V signal on digital input 02.
9	Above Level 1	The weight is above Level 1.
10	Above Level 2	The weight is above Level 2.
11	Analogue output voltage/current	'1' = voltage '0' = current
12	Setpoint 1 activated	See description of the setpoint function
13	Setpoint 2 activated	-"-
14	Setpoint 1 cycle finished	-"-
15	Setpoint 2 cycle finished	-"-

**Note: When the bits of this register are read as a float value, see description of Data representation.**



## Gross weight

This register holds the gross weight. The weight should **not** be read alone because the status and error codes are stored in other registers. The weight is only valid when the register 'Instrument error' equals 00.

A good choice is to read at least the registers 40009 – 40014 (integer)  
or the registers 40214 – 40221 (45214 – 45221) (float).

## Net weight

This register holds the net weight. The weight should **not** be read alone because the status and error codes are stored in other registers. The weight is only valid when the register 'Instrument error' equals 00.

A good choice is to read at least the registers 40009 – 40017 (integer)  
or the registers 40214 – 40223 (45214 – 45223) (float).

## Analogue output value

This register holds the current output signal on the analogue output. This register could be used for fault finding in the system.

**Note:** The value is rounded to two decimals.

## Input signal (mV/V)

This register holds the current input signal in mV/V. This register could be used for fault finding in the system.

## Command register

As this register is read, the answer will always contain only zeros.

There are a number of actions that can be activated in the WST 3. The value of this register (when different from zero) will activate one of these actions, as described in 'Command description' on next page.

When an action cannot be performed for some reason (wrong state etc.) an 'exception response' is given as reply. When 'exception response' 03 or 07 is received, the command error register could be read to get a better error explanation.

**Description of commands**

<b>Comm.</b>	<b>Action activated in WST 3</b>	<b>Description</b>
<b>0</b>	No action starts	
<b>1</b>	Activate setpoint 1	See description of setpoint function.
<b>2</b>	Deactivate setpoint 1	-"
<b>3</b>	Activate setpoint 2	-"
<b>4</b>	Deactivate setpoint 2	-"
<b>5</b>	Activate setpoint 1 and 2	-"
<b>6</b>	Deactivate setpoint 1 and 2	-"
<b>7</b>	Perform taring	
<b>8</b>	Set to zero	Used to set the gross weight to zero.
<b>9</b>	Select gross mode	
<b>10</b>	Select net mode	
<b>16</b>	Start operation	When the WST 3 is in 'Wait for start state', this command can be used to start up the instrument.
<b>100</b>	*/ Enter Remote Set-up	This command is used to enable change of the WST 3 set-up via serial communication.
<b>101</b>	*/ Enter Remote Restore	This command is used to enable restoring of a saved set-up to WST 3 via serial communication.
<b>102</b>	*/ Exit Remote Set-up/Restore and save changes	This command is used when parameters have been changed via serial communication and should be saved in WST 3.
<b>103</b>	*/ Exit Set-up without saving changes	This command is used to enable discarding of changes to the set-up parameters, before leaving the set-up mode.
<b>104</b>	*/ Do Reset	This command is used to reset the instrument.
<b>105</b>	Check set-up data	This command checks that the set-up is correct.

**\*/ WARNING! The command will stop the normal weighing operation.**

## Level/Setpoint 1, Level/Setpoint 2

The registers are used to read and write Level and Setpoint values.

See section 5, Supervision, output relays.

At start up these values are fetched from corresponding set-up parameters (saved in the memory), which means that values written to these registers are only valid up to reset or power failure.

## Analogue fixed value

The register is used to set new temporary values for the analogue output when it is configured as 'Fixed+/-20mA' or 'Fixed+/-10V' in the set-up.

At start up the value is fetched from corresponding set-up parameter (saved in the memory), which means that a value written to this register is only valid up to reset or power failure.

## Set-up registers

**Note:** Normally the Windows programme deltaCOM, supplied by Nobel Weighing Systems, is used to edit parameters from the control unit, and therefore this information is only useful if you are writing your own set-up program.

Type of data: Float (2 reg./value)	Type of data: Modicon float (2 reg./value)	Description	R/W
40380	45380	First normal set-up register (normally 41000). If 'Modicon float' is used, add 5000 to this value.	R
40382	45382	Number of normal set-up registers.	R
40384	45384	First application programme specific set-up register. If 'Modicon float' is used, add 5000 to this value.	R
40386	45386	Number of application specific set-up registers (normally 0).	R
40388	45388	First special set-up registers (used for diagnostic purposes).	R
40390	45390	Number of special set-up registers (used for diagnostic purposes).	R
40394	45394	Set-up version.	R
40396	45396	Set-up data version.	R
41000 – 41399	46000 – 46399	Set-up registers. Registers containing set-up parameters. See chapter 3.	R/W */

\*/ Writing possible only in 'Remote set-up' state.

## How to edit set-up registers

Example: Change resolution to 0.2.

- Start by setting coil 100 (or command 100) 'Enter Remote Set-up'.
- Locate the resolution parameter in chapter 3. This gives Modbus register 41074.
- Set resolution to '0.2' by sending '7' to Modbus register '41074'.
- Proceed with changes of all the parameters that are to be changed.
- Finish by setting coil 102 (or command 102) 'Exit Remote Set-up/Restore and save changes'.
- The WST 3 makes a reset and the changes go into action.

See chapter 3 and other parts describing set-up to get more information.

## I/O bit (coil) description

WST 3 simulates a number of I/O bits that the master can write to, using Modbus function 05 or 15.

Each of these I/O bits is linked to an action in the WST 3, as described earlier in this manual under 'Command register' on pages 6-7 and 6-8.

Set the I/O bit with the same number as the command to perform.

The action is activated if the master sets the I/O bit to 'ON'.

If the master sets the I/O bit to 'OFF', this is accepted, but the corresponding action is not activated.

All I/O bits are WRITE ONLY.

That means that the master cannot read the I/O bits but only write to them.

**Note:** If the master tries to write to more than one I/O bit (Modbus function 15) the WST 3 will act on the lowest I/O bit number only.

## Data representation

Data values to and from the WST 3 uses 16 bit holding registers (40XXX) and can use different formats to give flexibility.

### Integer area

#### Unsigned integer (1 modbus register)

Values are saved in one modbus register as an unsigned integer (16 bit number without decimals).

#### Scaled integer (2 modbus registers + 1 modbus register = 3 modbus registers)

Values are saved in a special 3-register format. The first two registers are used as a 32 bit long integer value (with sign) and the third register is holding the number of decimals for the value.

Example: 12345678 (32 bit number) in the two first registers and 3 in the third register give the value: 12345.678.

Register	Hex	Decimal	Description
1	00BC	188	The 16 most significant bits in the value.
2	614E	24910	The 16 least significant bits in the value.
3	0003	3	The number of decimals.

Calculations in decimal numbers:

First multiply the most significant register with  $2^{16}$  (65536) and add the least significant register to the value.

$$188 * 2^{16} + 24910 = 12345678$$

Now divide the number to get the right number of decimals.

The decimal register was set to 3 in this example, which gives the value  $10^3 = 1000$  to divide with.

$$12345678 / 1000 = 12345.678$$

**Note:** If your PLC system can't handle 32 bit values, the second register can be used as a 16 bit register with the number of decimals that is indicated in the third register. This will limit the value range to between -32768 and +32767.

This must be regarded in the calibration of the instrument. Flags in Status register 1 indicate when the weights are bigger than 16 bit integers. These flags can be checked to make sure that the weight values fit in just one register.

## Float area, Modicon float area

The values are stored as standard IEEE 32 bit float values. Each value has two registers assigned to it. To read/write a float value an even number of Modbus registers, starting at an even address, must be read/written each time.

The float values are stored in two different float formats. Some devices may transfer the values with the high order bits in the first register and the low order bits in the second register. Other devices may invert the register order.

**Modicon float:** For true Modicon PLC's, use these register areas.

**Float:** Many third party controllers that support Modicon protocol use the float format where all bytes are written out in succession to one 32 bit register (as opposed to Modicon float values which use 2 consecutive 16 bit registers).

Use these register areas for these types of controllers.

*When reading float value registers representing bits, the set bits are returned as a float value.*

*Example: If bit 4 is set, the value 16.0 is returned as a float value, and if bit 0 and bit 4 are set the value 17.0 is returned as a float value. To use the value it's wise to convert it to an unsigned integer value where the bits can be compared.*

## Exception responses

When the master sends a query to a slave it expects a normal response (as described earlier). One of the following three events occurs after a query from the master.

### 1. Normal response.

The slave has received the query without communication error and can handle the query normally. The slave returns a normal response.

### 2. Communication error.

If the slave does not receive the query due to a communication error, or detects some communication error (parity error or checksum error), **no** response is returned. The master should process a time-out for the query.

### 3. Command error.

If the slave receives the query without any communication error, but cannot handle the query, e.g. if the command was not valid, the requested register number was not valid or WST 3 in a mode where the command was not allowed, then the slave will return an exception response informing the master of the nature of the error.

The following exception codes are possible.

Code	Name	Description
01	Illegal function	Not a valid function code. Valid function codes are 01, 02, 03, 05, 06, 08, 15, 16.
02	Illegal data address	Not a valid data address. See 'Register description' for a list of allowed registers.
03	Illegal data value	Value in data query field not valid. To get a better explanation of the error, the 'command error' register could be read.
07	Negative acknowledge	WST 3 has received the query but cannot perform it. To get a better explanation of the error, the 'command error' register could be read.

## Supported Modbus functions

Function	Description
01 Read Coil Status	Reads the ON/OFF state of discrete outputs (0X references, coils). This function is implemented because some 'masters' use it to initialise communication. Coil range: 1 – 16 (Max number of points to read: 16). Response: Zero (OFF) for all requested points.
02 Read Input Status	Reads the ON/OFF state of discrete inputs (1X references). This function is implemented because some 'masters' use it to initialise communication. Input range: 1 – 16 (Max number of points to read: 16). Response: Zero (OFF) for all requested points.
03 Read Holding Reg.	Reads the binary content of holding registers (4X references). Max number of registers to read: 100
05 Force Single Coil	Forces a single coil (0X references) to either ON or OFF. This function is used to activate actions in the WST 3.
06 Preset Single Reg.	Stores a value into a single holding register (4X references).
08 Diagnostics	This function can provide a series of different communication tests, depending on a sub function code. WST 3 only supports sub function code 00, which is a 'loop-back' test. The same data as received will be sent back to the master. Max number of data bytes: 64
15 Force Multiple Coils	Forces a sequence of coils (0X references) to either ON or OFF. This function is used to activate actions in the WST 3. Max. number of points: 16 (only the first one is used).
16 Preset Multiple Reg.	Stores values into a sequence of holding registers (4X references). Max number of registers for storing: 100

**Note: Broadcast messages are not allowed.**

It is possible to send or fetch any number of registers (max 100) or I/O bits (max. 16).

If the master tries to read more registers than those that are available, the WST 3 module will send dummy values for those registers not available.



## External display

### General

The transmitted value is adapted for Newport/London remote displays with 4, 5, 6 or 7 digits and for Intrinsic safety indicator MTL 643/644 with 32 characters.

### Set-up of external display

- Serialport mode:** External display.
- Baudrate:** The same setting as for the external display.
- Data format:** The same setting as for the external display.
- Ext. disp. mode:** The weight value to present at the external display.  
(Gross weight, Net weight or Disp. weight.)
- Ext. disp.format:** According to the table below, depending on the type of external display.

Type	Description
4 (digits)	Four-digit indicator. Display: -999 – 9999 (plus possible decimal point).
5 (digits)	Five-digit indicator. Display: -9999 – 99999 (plus possible decimal point).
6 (digits)	Six-digit indicator. Display: -99999 – 999999 (plus possible decimal point). Possible gross/net indicators will be activated.
7 (digits)	Seven-digit indicator. Display: -999999 – 9999999 (plus possible decimal point).
32 (characters)	MTL 643 Intrinsic safety indicator. Display: -999999 – 9999999 (plus possible decimal point).

### Remote display with 4 to 7 digits

The remote display normally presents the current weight, but under the following conditions only 'dashes' (----) are displayed:

- the number of digits in the transmitted weight value is outside the indicators range.
- the instrument is not in normal state or there is a weight error.

Definition of weight value to remote display with 4, 5, or 7 digits:

Character No.	Value alphanumeric.	Value Hex	Function
1		02	Start character (STX).
2 to 5 – 9	0 – 9, ., -	30 – 39, 2E, 2D	* / Weight value: 4, 5 or 7 digits and a possible decimal point. (The first digit may be a minus sign).
Last		0D	End character (CR).

Definition of weight value to remote display with 6 digits:

Character No.	Value alphanumeric.	Value Hex	Function
1		02	Start character (STX).
2	H, M, blank	48, 4D, 20	This character is present only if 6 (digits) is selected in 'Ext. disp.format'. H = gross weight transmitted M = net weight transmitted blank = no valid weight transmitted.
3 to 8 or 9	0 – 9, ., -	30 – 39, 2E, 2D	*/ Weight value: 6 digits and one possible decimal point. (The first digit may be a minus sign).
Last		0D	End character (CR).

**Note:** \*/ The number of digits in the weight value (including a minus sign, if present) will equal the number of digits selected in 'Ext. disp.format'. Leading zeros will be added to fill up to the selected number of digits. The decimal point does not occupy any digit position.

### Remote display MTL 643/644

This remote display can handle both digits and characters and has therefore some special extra features. The weight is always shown with the chosen unit and when there is an error, the display indicates 'error' instead of just '----'. The error message is shown when there is an internal error in the WST 3 or when the number of digits in the transmitted weight value is outside the indicators range.

A time-out in the MTL 643/644 is set to 10 seconds, which means that if there is a communication error etc. 'TIMEOUT' will flash on the MTL 643/644 when the time-out has passed.

Example on a weight value, presented at MTL 643/644.

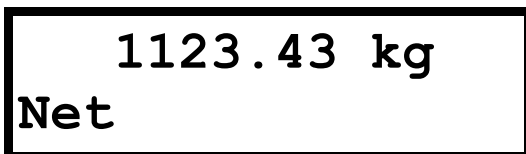

'Gross' and 'Net' will replace each other.

Key 1 at MTL is used for: TARE

Key 2 at MTL is used for: Gross/Net

# 7. Profibus communication

## General

WST 3 has a fieldbus connection of the type Profibus-DP (modular slave).

Data transmission is performed through messages, exchanged via a memory area in WST 3. Between a Profibus master and WST 3 data is exchanged by writing and reading of registers in WST 3, except for the displayed weight with status and error indications. These registers are described in section 6, Modbus communication.

It is also possible to activate a number of actions in WST 3 by writing to the byte 'Command'. Allowed commands are described in this section and in section 6, Modbus communication.

For configuration of a Profibus master a configuration file, GSD-file, is needed and delivered together with WST 3 (NOBL075F.GSD).

For error checking of the Profibus communication WST 3 has a diagnostic function, showing data received from or sent to the Profibus master at the WST 3 display.

## Slave address

The unit (Profibus) address is set at WST 3 from the front panel or by serial communication (Modbus), see section 3, 'Main menu Profibus'.

## Profibus weight format

The data format of the displayed weight, which is found in all memory mappings, can be selected by parameters as the Profibus master is configured. For this purpose byte 3 is used, value 0 giving integer format and value 1 giving float format (other parameter data: byte 0 through 2 must have the value 0).

For more information concerning the data format of the displayed weight, see '6 B Standard' mapping and Representation of displayed weight by 20 and 86 byte mapping respectively.

## Mappings

The different memory mappings are defined in the configuration file (GSD file) and are selected at configuration of the Profibus master. Consequently no settings for the mapping need to be done in WST 3.

### **It is possible to use four different standard mappings in WST 3.**

**6 B standard:** The smallest mapping, only the displayed weight together with one single status byte and one error code is transmitted to the master. Actions in WST 3 can be initiated but no acknowledgement is received when the action is performed. This mapping is compatible with the 6 byte mapping for 'Generation 3' in GATE 3/GATE 3S.

**20 B standard:** A more advanced mapping where the master can read the displayed weight with corresponding status and error indications, and also selected registers in WST 3 (by a 6 byte reading window). The Profibus master can also write data into WST 3 registers (maximum 8 registers at a time). Actions in WST 3 can be initiated and an acknowledgement is received as the action is performed. This mapping is compatible with the 20 byte mapping for 'Generation 3' in GATE 3/GATE 3S.

**86 B integer:** This mapping is based on the 20 byte mapping but is enhanced to make it easy to read more data (integer data related to registers in WST 3) without selecting a reading window. The error indication is also enhanced to allow reading of the reason why a commanded action is not performed.

**86 B float value:** The function of this mapping is identical to '86 B integer', but the data is sent as float values instead of integer values.

Except these four mappings, four more special mappings are defined in the GDS file. They are based on the 6 byte and 20 byte mappings respectively but with the possibility to transmit some more data to the master. These mappings should be used together with special programmes in WST 3 and they are described in detail along with the special programme.

For more information, see the description of the mapping in question later in this section.

## '6 B Standard' mapping

This mapping is obtained by selection of the module '6 B Standard' from the GDS file as the slave is configured in the Profibus master (6 bytes out/6 bytes in).

### Data from the fieldbus (Outputs in the master)

Byte	
00	Command */
01	-
02	-
03	-
04	-
05	-

### Data to the fieldbus (Inputs in the master)

The first byte to the fieldbus (00) is used as a status report.

The meaning of each status bit is explained in the table to the right.

Byte		Status	
00	Status	Bit	Meaning of bit = 1
01	Instr. error **/	0	Always 0
02	Displayed weight <sup>MSB</sup>	1	Net mode
03	-"-	2	Always 0
04	-"-	3	Relay 1 activated
05	-"-	4	Relay 2 activated
		5	Program reset ***/
		6	Above level 1
		7	Above level 2

\*/ See section 6, Modbus communication, Command register.

\*\*/ See section 8, Troubleshooting.

\*\*\*/ The bit is set each time the programme starts, indicating that volatile data is lost.

As **Command 202** is sent to the unit, the bit is reset to 0.

**NOTE!** An action is activated only as the Command value is changed. Thus, activation of a certain action one more time must be preceded by a different command, for example 00, 'No action starts'.

**Representation of displayed weight, '6 B Standard' mapping**

The weight value (byte 02 - 05) from WST 3 can be either an integer or a float value depending on the setting of parameter byte 'Profi.V.format' (byte 3 in parameter data from the master).

- Integer value The first data word (byte 02 - 03) contains the integer part of the value and the second data word (byte 04 – 05) contains the decimal part, multiplied by 1000 to make it an integer value.  
The data words are integer values with a sign, so they can describe positive and negative values.
- Float value The weight value is saved as a 32 bit float value according to IEEE standard.

**NOTE:** If the fieldbus master uses 'Intel' format the two bytes of each register must change places.

Example with integer values:

Byte	Value	Displayed weight
02 03	00 7B (123)	
04 05	01 F4 (500)	$123 + 500/1000 = 123.5$
02 03	00 7B (123)	
04 05	01 C8 (456)	$123 + 456/1000 = 123.456$
02 03	30 39 (12345)	
04 05	02 58 (600)	$12345 + 600/1000 = 12345.6$
02 03	FF 85 (-123)	
04 05	FE 70 (-400)	$-123 + (-400/1000) = -123.4$

A complete value is calculated in the master by dividing the second data word (byte 04 – 05) by 1000, and adding it to the first data word (byte 02 – 03).

In this case the value range for the displayed weight is from -32768.999 to +32767.999.

Example with float value:

Byte	Value	Displayed weight
02 03 04 05	42 F7 00 00	123.5

## '20 B Standard' mapping

This mapping is obtained by selection of the module '20 B Standard' from the GDS file as the slave is configured in the Profibus master (20 bytes out/20 bytes in).

For more information about commands and data representation, see pages 7-10 to 7-13.

### Data from the fieldbus (Outputs in the master)

Byte	
00	Command */
01	Number of registers to write
02	Start address, Read/Write MSB
03	Start address, Read/Write
04	Write register 1 MSB
05	Write register 1
06	Write register 2 MSB
07	Write register 2
08	Write register 3 MSB
09	Write register 3

Byte	
10	Write register 4 MSB
11	Write register 4
12	Write register 5 MSB
13	Write register 5
14	Write register 6 MSB
15	Write register 6
16	Write register 7 MSB
17	Write register 7
18	Write register 8 MSB
19	Write register 8

### Data to the fieldbus (Inputs in the master)

Byte	
00	Command acknowledge */
01	Instrument error ***/
02	Displayed weight, 32 bit MSB **/
03	-"-
04	-"-
05	-"-
06	Number of decimals MSB
07	-"-
08	Status register 1 MSB ****/
09	Status register 1
10	Status register 2 MSB ****/
11	Status register 2

Byte	
12	Start address, Read MSB
13	Start address, Read
14	Read register 1 MSB
15	Read register 1
16	Read register 2 MSB
17	Read register 2
18	Read register 3 MSB
19	Read register 3

\*/ See 'Commands for 20 and 86 byte mappings'.

\*\*/ See 'Representation of displayed weight for 20 and 86 byte mappings'.

\*\*\*/ See section 8, Troubleshooting.

\*\*\*\*/ See section 6, Modbus communication, Status register 1 and 2.

## '86 B Integer' mapping

This mapping is obtained by selection of the module '86 B Integer' from the GDS file as the slave is configured in the Profibus master (20 bytes out/86 bytes in).

The data in byte 22 - 85 to the fieldbus is in integer format and the register numbers in brackets refer to the register description in section 6, 'Modbus communication'.

For more information about commands and data representation, see pages 7-10 to 7-13.

### Data from the fieldbus (Outputs in the master)

Byte	
00	Command */
01	Number of registers to write
02	Start address, Read/Write MSB
03	Start address, Read/Write
04	Write register 1 MSB
05	Write register 1
06	Write register 2 MSB
07	Write register 2
08	Write register 3 MSB
09	Write register 3

Byte	
10	Write register 4 MSB
11	Write register 4
12	Write register 5 MSB
13	Write register 5
14	Write register 6 MSB
15	Write register 6
16	Write register 7 MSB
17	Write register 7
18	Write register 8 MSB
19	Write register 8

### Data to the fieldbus (Inputs in the master)

Byte	
00	Command acknowledge */
01	Instrument error ***/
02	Displayed weight, 32 bit MSB **/
03	"-"
04	"-"
05	"-"
06	Number of decimals MSB
07	"-"
08	Status register 1 MSB ****/
09	Status register 1
10	Status register 2 MSB ****/
11	Status register 2

Byte	
12	Start address, Read MSB
13	Start address, Read
14	Read register 1 MSB
15	Read register 1
16	Read register 2 MSB
17	Read register 2
18	Read register 3 MSB
19	Read register 3
20	Read register 4 MSB
21	Read register 4

Continued on next page.

- \*/ See 'Commands for 20 and 86 byte mappings'.
- \*\*/ See 'Representation of displayed weight for 20 and 86 byte mappings'.
- \*\*\*/ See section 8, Troubleshooting.
- \*\*\*\*/ See section 6, Modbus communication, Status register 1 and 2.



## Data to the field bus (Inputs in the master) cont.

Byte	
22	Profibus command error <sup>MSB */</sup>
23	Profibus command error
24	Instrument type (40001) <sup>MSB</sup>
25	Instrument type (40001)
26	Program no. (40002) <sup>MSB</sup>
27	Program no. (40002)
28	Program ver. (40003) <sup>MSB</sup>
29	Program ver. (40003)
30	Serial number (40004) <sup>MSB</sup>
31	Serial number (40004)
32	Serial number (40005)
33	Serial number (40005)
34	Serial number (40006) <sup>MSB</sup>
35	Serial number (40006)
36	Instrum. state (40008) <sup>MSB</sup>
37	Instrum. state (40008)
38	Instrum. error (40009) <sup>MSB</sup>
39	Instrum. error (40009)
40	Status 1 (40010) <sup>MSB</sup>
41	Status 1 (40010)
42	Status 2 (40011) <sup>MSB</sup>
43	Status 2 (40011)
44	Gross weight (40012) <sup>MSB</sup>
45	Gross weight (40012)
46	Gross weight (40013)
47	Gross weight (40013)
48	Gross weight (40014) <sup>MSB</sup>
49	Gross weight (40014)
50	Net weight (40015) <sup>MSB</sup>
51	Net weight (40015)
52	Net weight (40016)
53	Net weight (40016)
54	Net weight (40017) <sup>MSB</sup>
55	Net weight (40017)

Byte	
56	Analogue output v. (40024) <sup>MSB</sup>
57	Analogue output v. (40024)
58	Analogue output v. (40025)
59	Analogue output v. (40025)
60	Analogue output v. (40026) <sup>MSB</sup>
61	Analogue output v. (40026)
62	Input sign. (mV/V) (40027) <sup>MSB</sup>
63	Input sign. (mV/V) (40027)
64	Input sign. (mV/V) (40028)
65	Input sign. (mV/V) (40028)
66	Input sign. (mV/V) (40029) <sup>MSB</sup>
67	Input sign. (mV/V) (40029)
68	Level/Setpoint 1 (40031) <sup>MSB</sup>
69	Level/Setpoint 1 (40031)
70	Level/Setpoint 1 (40032)
71	Level/Setpoint 1 (40032)
72	Level/Setpoint 1 (40033) <sup>MSB</sup>
73	Level/Setpoint 1 (40033)
74	Level/Setpoint 2 (40034) <sup>MSB</sup>
75	Level/Setpoint 2 (40034)
76	Level/Setpoint 2 (40035)
77	Level/Setpoint 2 (40035)
78	Level/Setpoint 2 (40036) <sup>MSB</sup>
79	Level/Setpoint 2 (40036)
80	Ana. fixed value (40037) <sup>MSB</sup>
81	Ana. fixed value (40037)
82	Ana. fixed value (40038)
83	Ana. fixed value (40038)
84	Ana. fixed value (40039) <sup>MSB</sup>
85	Ana. fixed value (40039)

\*/ See 'Commands for 20 and 86 byte mappings'.

## '86 B Float' mapping

This mapping is obtained by selection of the module '86 B Float' from the GDS file as the slave is configured in the Profibus master (20 bytes out/86 bytes in).

The data in byte 22 - 85 to the fieldbus is in floating point format and the register numbers in brackets refer to the register description in section 6, 'Modbus communication'.

For more information about commands and data representation, see pages 7-10 to 7-13.

### Data from the field bus (Outputs in the master)

Byte	
00	Command */
01	Number of registers to write
02	Start address, Read/Write MSB
03	Start address, Read/Write
04	Write register 1 MSB
05	Write register 1
06	Write register 2 MSB
07	Write register 2
08	Write register 3 MSB
09	Write register 3

Byte	
10	Write register 4 MSB
11	Write register 4
12	Write register 5 MSB
13	Write register 5
14	Write register 6 MSB
15	Write register 6
16	Write register 7 MSB
17	Write register 7
18	Write register 8 MSB
19	Write register 8

### Data to fieldbus (Inputs in the master)

Byte	
00	Command acknowledge */
01	Instrument error ***/
02	Displayed weight, 32 bit MSB **/
03	-"-
04	-"-
05	-"-
06	Number of decimals MSB
07	-"-
08	Status register 1 MSB ****/
09	Status register 1
10	Status register 2 MSB ****/
11	Status register 2

Byte	
12	Start address, Read MSB
13	Start address, Read
14	Read register 1 MSB
15	Read register 1
16	Read register 2 MSB
17	Read register 2
18	Read register 3 MSB
19	Read register 3
20	Read register 4 MSB
21	Read register 4

Continued on next page.

- \*/ See 'Commands for 20 and 86 byte mappings'.
- \*\*/ See 'Representation of displayed weight for 20 and 86 byte mappings'.
- \*\*\*/ See section 8, Troubleshooting.
- \*\*\*\*/ See section 6, Modbus communication, Status register 1 and 2.

## Data to the field bus (Inputs in the master) cont.

Byte	
22	Profibus command error <sup>MSB */</sup>
23	Profibus command error
24	Profibus command error
25	Profibus command error
26	Instrument type (40200) <sup>MSB</sup>
27	Instrument type (40200)
28	Instrument type (40201)
29	Instrument type (40201)
30	Program no. (40202) <sup>MSB</sup>
31	Program no. (40202)
32	Program no. (40203)
33	Program no. (40203)
34	Program ver. (40204) <sup>MSB</sup>
35	Program ver. (40204)
36	Program ver. (40205)
37	Program ver. (40205)
38	Serial number (40208) <sup>MSB</sup>
39	Serial number (40208)
40	Serial number (40209)
41	Serial number (40209)
42	Instrum. state (40212) <sup>MSB</sup>
43	Instrum. state (40212)
44	Instrum. state (40213)
45	Instrum. state (40213)
46	Instrum. error (40214) <sup>MSB</sup>
47	Instrum. error (40214)
48	Instrum. error (40215)
49	Instrum. error (40215)
50	Status 1 (40216) <sup>MSB</sup>
51	Status 1 (40216)
52	Status 1 (40217)
53	Status 1 (40217)

Byte	
54	Status 2 (40218) <sup>MSB</sup>
55	Status 2 (40218)
56	Status 2 (40219)
57	Status 2 (40219)
58	Gross weight (40220) <sup>MSB</sup>
59	Gross weight (40220)
60	Gross weight (40221)
61	Gross weight (40221)
62	Net weight (40222) <sup>MSB</sup>
63	Net weight (40222)
64	Net weight (40223)
65	Net weight (40223)
66	Analogue output v. (40228) <sup>MSB</sup>
67	Analogue output v. (40228)
68	Analogue output v. (40229)
69	Analogue output v. (40229)
70	Input sign. (mV/V) (40230) <sup>MSB</sup>
71	Input sign. (mV/V) (40230)
72	Input sign. (mV/V) (40231)
73	Input sign. (mV/V) (40231)
74	Level/Setpoint 1 (40234) <sup>MSB</sup>
75	Level/Setpoint 1 (40234)
76	Level/Setpoint 1 (40235)
77	Level/Setpoint 1 (40235)
78	Level/Setpoint 2 (40236) <sup>MSB</sup>
79	Level/Setpoint 2 (40236)
80	Level/Setpoint 2 (40237)
81	Level/Setpoint 2 (40237)
82	Ana. fixed value (40238) <sup>MSB</sup>
83	Ana. fixed value (40238)
84	Ana. fixed value (40239)
85	Ana. fixed value (40239)

\*/ See 'Commands for 20 and 86 byte mappings'.

## Common data for 20 and 86 byte mappings

In messages to the fieldbus (inputs in the fieldbus master):

- the first byte (00) contains a command acknowledgement, either the number of the performed command or an error code, 254 or 255, if the command is not performed.
- byte number two (01) contains an explanation of a possible error in WST 3, using error codes, see section 8 'Troubleshooting'.
- bytes number three through eight (02 through 07) contain the weight value (displayed weight).
- the following four bytes (08 through 11) contain Status register 1 and Status register 2.
- the remaining eight bytes (ten bytes by 86 byte mappings) contain the start address for the read window and three (four) registers, read from WST 3.

## Commands for 20 and 86 byte mappings

In messages from the fieldbus (outputs in the fieldbus master) the first byte is a command to WST3. This byte is used to initiate different normal actions in WST3 and certain actions that are unique for Profibus (command 200, 201, and 202).

How the remaining bytes from the fieldbus are used is explained in the following examples.

**NOTE!** An action is activated only as the Command value is changed. Thus, activation of a certain action one more time, must be preceded by a different command, for example 00, 'No action starts'.

The **Command acknowledge** (byte 00 to the fieldbus) is made up of the number of the performed command, or of an error code if the command has not been performed.

Possible error codes:

254	The address not valid by writing of data.
255	<p>The command could not be performed, or the message contains data that is not valid.</p> <p>If any 86 byte mapping is selected, it is in this case possible to get a better explanation of the error by reading the bytes 'Profibus comm. error'.</p> <p>For an explanation of possible error codes in 'Profibus comm. error', see section 8, Troubleshooting, Error codes.</p>

**Command 200** is used to write data to WST 3. The following bytes should contain the number of registers to write, the address where the writing should start and finally data for up to eight registers to write to WST 3.

NOTE! Data writing to the normal 'Command register' (registers 40030, 40232–33 or 45232–33) will not start any action (the writing is ignored).

Make sure the previous command was not '200'.

Start by creating the message and finish by setting byte 00 to '200'.

Example 1: Setting 'Level/Setpoint 1' to 123.5 (Float value)

1. Make sure the previous command was NOT 200 (byte 00).
2. Use byte 01 to define the number of registers to write (2).
3. Use bytes 02 and 03 to define the start address for the writing, 40234.  
See section 6, Modbus communication, Register description.
4. Use the following four bytes to set the value to 123.5.
5. Finally, enter the command number, 200, in byte 00.

Byte	Description	Dec	Hex
00	Command	200	C8
01	Number of registers to write	2	02
02 03	Start address	40234	9D 2A
04 05 06 07	Write registers 1 and 2	123.5	42 F7 00 00

Example 2: Setting 'Level/Setpoint 1' to 20.0 (Integer)

1. Make sure the previous command was NOT 200 (byte 00).
2. Use byte 01 to define the number of registers to write (3).
3. Use bytes 02 and 03 to define the start address for the writing, 40031.  
See section 6, Modbus communication, Register description.
4. Use the following six bytes to define the value 20.0, i.e. 200 and one decimal.
5. Finally, enter the command number, 200, in byte 00.

Byte	Description	Dec	Hex
00	Command	200	C8
01	Number of registers to write	3	03
02 03	Start address	40031	9C 5F
04 05 06 07	Write registers 1 and 2	200	00 00 00 C8
08 09	Write register 3	1	00 01

**Command 201** is used to select a 'read window', three registers wide (four registers wide by 86 byte mapping) that will be contained in all messages from WST 3.

Make sure the previous command was not '201'.

Start by defining the start address and finish by setting byte 00 to '201'.

Example: Set the read window to begin at Modbus register 40031.

1. Make sure the previous command was NOT 201 (byte 00).
2. Use bytes 02 and 03 to define the start address for the reading, 40031.  
See section 6, Modbus communication, Register description.
3. Finally enter the command number, 201, in byte 00.

Byte	Description	Dec	Hex
00	Command	201	C9
01	(Number of registers to read)	–	–
02 03	Start address	40031	9C 5F

**Command 202** is used to reset the bit 'Program reset' (bit 4) in register 'Status 2' to zero (see section 6, Modbus communication, Register description).

1. Make sure the previous command was NOT 202 (byte 00).
2. Enter the command number, 202, in byte 00.

Byte	Description	Dec	Hex
00	Command	202	CA

**Other commands** are used to start different actions in WST 3.

See section 6, Modbus communication, Command description for available commands.

1. Make sure the previous command was NOT the desired command (byte 00).
2. Enter the desired command number in byte 00.

Byte	Description	Dec	Hex
00	Command	XXX	XX

## Representation of displayed weight for 20 and 86 byte mappings

The weight value (bytes 02 – 07) from WST 3 can be either an integer or a float value, depending on the setting of parameter byte 'Profi.V.format' (byte 3 in parameter data from the master).

- **Integer value** Bytes 02 - 05 are used as an integer value of 4 bytes (with sign), and bytes 06 - 07 define the number of decimals in the value.
- **Float value** The weight value (bytes 02 - 05) is saved as a 32 bit float value according to IEEE standard. Bytes 06 - 07 define the number of significant decimals.

**NOTE:** If the fieldbus master uses 'Intel' format the two bytes in each register must change places.

Example with integer value:

Byte	Value	Displayed weight
02 03 04 05	00 BC 61 4E (12345678)	
06 07	00 03 (3, number of decimals)	12345678/10 <sup>3</sup> = 12345.678

Calculations of displayed weight:

First multiply the most significant register (bytes 02 - 03) by 2<sup>16</sup> (65536) and then add the value of the least significant register (bytes 04 - 05).

$$188 (00 BC) * 2^{16} + 24910 (61 4E) = 12345678$$

Divide the result by 1000 because the number of decimals is 3.

$$12345678 / 1000 = 12345.678$$

Example with float value:

Byte	Value	Displayed weight
02 03 04 05	42 F7 00 00	123.500
06 07	00 03 (3)	(number of significant decimals)

## Different formats for data representation

All data values are transmitted with the most significant byte at the lower memory address (Motorola format).

If the fieldbus master handles data with the most significant byte at the higher memory address (Intel format), all bytes must change places in the master.

**Example:**

Value	Used in WST 3 Byte (Motorola)	Byte (Intel)
1234.9 (float value)	44 9A 5C CD	CD 5C 9A 44
123456789 (32 bit)	07 5B CD 15	15 CD 5B 07
12345 (16 bit)	30 39	39 30

As you can see, the byte location is changed for the two formats.

'Bus diagnostics' can be used to study the byte location.

## Bus diagnostics

Bus diagnostics gives the possibility to study, during normal operation, the contents in selected parts of the WST 3 memory (data to and from the fieldbus master). The function is very useful for advanced fault finding in case of problems with the fieldbus communication.

As the view "Profibus status" is selected, Bus diagnostics can be activated by pressing key ↵ for 2 seconds.

The contents of the output memory (data **to** the fieldbus master) are displayed in hexadecimal form at the two lines of the display. On each line four byte values are displayed, preceded by 'o' for output and the address of the first byte.

Keys + and - are used to step forwards and backwards in the memory.

Press key ↵ to study the input memory.

The contents of the input memory (data **from** the fieldbus master) are displayed in hexadecimal form at the two lines of the display. On each line four byte values are displayed, preceded by 'i' for input and the address of the first byte.

Keys + and - are used to step forwards and backwards in the memory.

Use key ↵ to change between display of output memory and input memory.

Press ↑ to return to the menu "Profibus status".

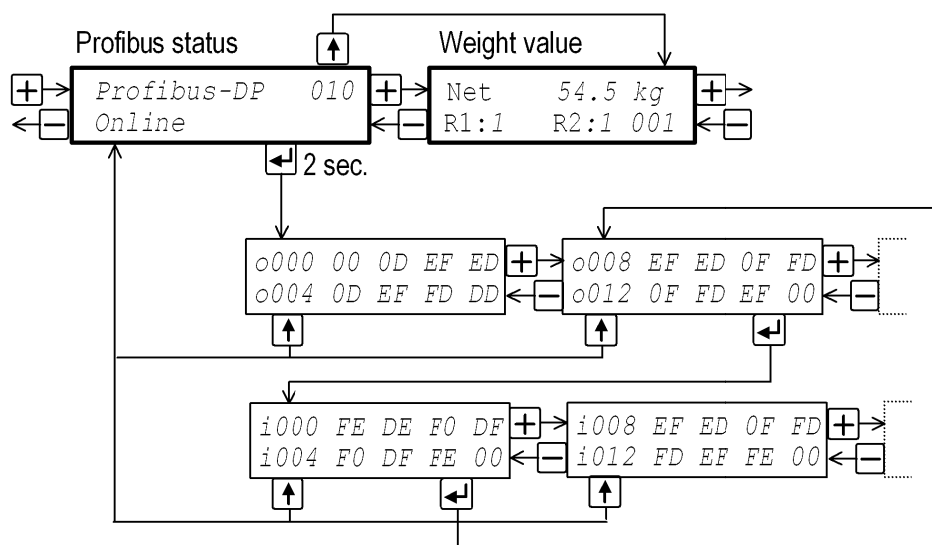

Figure 14. Example showing how 'Bus diagnostics' is used to study memory areas in WST 3 where data to and from the Profibus master is saved.



# 8. Troubleshooting

## General

WST 3 has an automatic error checking facility. This serves to facilitate troubleshooting and to ensure that the instrument will always function in the best possible manner. The error checking provides guidance on how to deal with faults and errors.

When an error occurs the signal 'In process' will be off, the relays will be deactivated, the analogue output will be set to 0V / 0mA, and an error code will be displayed. This error code can be fetched by a connected control unit via Modbus or Profibus communication. At the control unit the programme may present an error description corresponding to the error code.

For a WST 3 instrument, some error codes will cause messages to be displayed, containing the kind of error, the error code, and hints on how to correct the error.

## Error codes

The error codes are divided in four groups, depending on their origin:

- **Weight errors,** occur when transducer signals or output values go out of given ranges.
- **Start-up errors,** occur only during start-up.
- **General errors,** usually occur due to faulty entries from the front panel, alternatively invalid data or invalid commands from the control unit.
- **Set-up errors,** can only occur during instrument set-up (from the front panel or by communication).

On the following pages a summary of all error codes is given (note that code 000 always means 'no error').

### Weight errors

The indication is either temporary or remains until the cause is cured.  
 At WST 3 the text within " " is scrolled while the error code is displayed.

Error code	Explanation
<b>000</b>	<b>No error.</b> The instrument is in operating state and no error is detected.
<b>001</b>	<b>Instrument in Remote set-up state.</b> The weight is not valid.
<b>003</b>	<b>Instrument not in normal state.</b> The weight is not valid.
<b>005</b>	<b>Overrange error.</b> Overrange means that the input signal from the transducer exceeds the operating range.
<b>007</b>	<b>Underrange error.</b> Underrange means that the input signal from the transducer is below the operation range.
<b>010</b>	<b>Excitation short-circuit. " Check connections "</b> Either a short-circuit in the excitation circuit or too many transducers connected. (A fault in a transducer or inside the transmitter is also possible.) Check the transducer connections. See section, 2 Installation.
<b>011</b>	<b>Sense voltage error. " Check connections "</b> The sense voltage is too low, unbalanced or has a reversed polarity. (A fault in a transducer or inside the transmitter also possible.) Check the transducer connections. See section, 2 Installation.
<b>012</b>	<b>Transducer sign. error. " Check connections "</b> The input signal is too high, for example due to a faulty or missing transducer connection. (A fault in a transducer or inside the transmitter is also possible.) Check the transducer connections. See section, 2 Installation.
<b>013</b>	<b>Transducer sign. out of range.</b> The input signal is too high. (A similar fault as for Error 012 above is also possible.)
<b>015</b>	<b>Transducer sign. out of range.</b> The input signal is too low. (A similar fault as for Error 012 above is also possible.)

**Start-up errors**

These error codes can only appear during start-up.

Error code	Explanation
080	<p><b>Invalid set-up version.</b>            This error usually occurs at first start-up after a programme upgrade. The actual settings have been replaced by default values. Enter set-up mode, perform the necessary editing and save the new parameter settings.</p>
081	<p><b>Invalid set-up data.</b>            Indicates faulty parameter checksum. The actual settings have been replaced by default values. Enter set-up mode, perform the necessary editing and save the new parameter settings.</p>
082	<p><b>Invalid weight data.</b>            This error code can occur at restart after a power failure, etc. It indicates one or several faults among the stored data for auto tare, zero setting, and gross/net mode. It also indicates that the instrument is using default values (0 for auto tare and zero setting, gross/net set to gross).            To get back into normal operation, the operator has to send a reset command from the control unit or switch the power OFF and ON.</p>
083-085, 088	<p><b>Invalid factory calibration.</b>            Invalid factory calibration is a fatal error. It indicates that some calibration-constant or other value stored in the unit during manufacture has been corrupted.            Specially trained service personnel are required.            Contact your distributor!</p>
097	<p><b>RAM error.</b>            RAM memory error is a fatal error. It indicates equipment failure, which requires trained service personnel.            Contact your distributor!</p>
098	<p><b>FLASH error.</b>            Flash memory error is a fatal error. It indicates equipment failure, which requires trained service personnel.            Contact your distributor!</p>
099	<p><b>Watchdog error.</b>            If a watchdog error appears the system will be reinitialised. The operator must then send a reset command from the control computer, or switch the power OFF and ON, to achieve normal operation.            The program regularly sends impulses to a special watchdog circuit to ensure that the circuits and the programme operate correctly. However, if these impulses for any reason are omitted the watchdog error indication will result.</p>

### General errors

These errors generally occur due to faulty entries from the front panel, alternatively invalid data or invalid commands from the control unit.

Error code	Explanation
100	<b>Instrument in wrong state.</b> The transmitted command is not applicable to the present WST 3 mode.
101	<b>Overrange entry.</b> Value over allowed range. Compare with restrictions for the parameter.
102	<b>Underrange entry.</b> Value under allowed range. Compare with restrictions for the parameter.
103	<b>Illegal start address.</b> When writing float values or set-up values the start address of the written data must be even.
104	<b>Illegal number of registers.</b> When writing float values the number of registers of the written data must be even. This error can also occur when writing scaled integer values.
105	<b>Illegal value error.</b> Illegal data in Modbus registers when writing data to WST 3.
106	<b>Choice not available.</b> The choice is not valid in this program release of the WST 3 software.
122	<b>Instrument in net mode.</b> Zero setting requires that the instrument is in gross mode. However, if you try to transmit a zero setting command while the instrument is in net mode you'll receive this error code.
124	<b>Setpoint(s) not in use.</b> Activation/Deactivation of Setpoint(s) cannot be done, as at least one of the setpoint sources 'Superv. X mode' is not 'Setpoint mode'.
130	<b>Remote set-up/restore not allowed.</b> The sent command cannot be executed with WST 3 in the actual mode.
131	<b>Exit set-up/restore not allowed.</b> The exit set-up command is only allowed when the instrument mode is "Remote set-up state" or "Remote restore state".

**Set-up errors**

These errors occur only during instrument set-up, from the front panel or by serial communication.

Certain errors depend on more than one set-up parameter and it is the operator's responsibility to locate and correct all faulty set-up parameters.

Error codes 179 – 192 occur when it is not allowed to exit remote set-up or remote restore because of faulty parameter values.

Error code	Explanation
160	<b>Calibration weight error.</b> Weight error during calibration.
162	<b>Calibration timeout error.</b> Transducer signal does not get stable within 10 seconds during calibration.
163	<b>Saving of set-up value not allowed.</b> Certain set-up parameters depend on other parameters and are saved automatically when a new value for the related parameter is saved. Then only certain automatically saved parameters can be browsed. If you try to save a new value for one of these parameters, this error code will occur.
164	<b>Illegal set-up register.</b> Requested set-up parameter does not exist or is not defined.
165	<b>Too many digits.</b> The Capacity value has more than the permitted 6 digits. Select a combination of Resolution and Capacity that will result in max. 6 digits plus decimal point.
166	<b>Some parameters set to default values.</b> Some parameters that were restored use certain choices that are not allowed in this instrument. These parameters are set to default values.
179	<b>Bandwidth mismatch.</b> The bandwidth is not accepted. The analogue and digital bandwidth ratio must not exceed 100. Example: 0.1 Hz ↔ 10 Hz.
188	<b>Too many digits.</b> The Capacity value has more than the permitted 6 digits. Select a combination of Resolution and Capacity that will result in max. 6 digits plus decimal point.
189	<b>Too high transducer signal in cal. point 2.</b> The mV/V signal in calibration point 2 is too high (often due to a previous, strange data sheet calibration).
190	<b>Too high transducer signal in cal. point 2.</b> The mV/V signal in calibration point 2 is too high, due to strange data sheet calibration. The conversion factor, rated load etc. does not correspond to each other.
191	<b>Illegal calibration direction.</b> Increasing transducer signal must correspond to increasing weight value.
192	<b>Illegal analogue range high/low.</b> Parameter value 'Ana. range high' / 'Ana. range low' out of allowed range.
41000 - 41900	Exit Remote Set-up/Restore not allowed. There is an error in the parameter pointed out by this error code. The parameter value is out of range.

## Profibus status

The view 'Profibus status' continuously describes the operating status of the fieldbus by different texts, shown to the left in the second line at the display.

The following texts can be shown:

Text	Explanation
<b>Online</b>	WST 3 is online. Data exchange with the Profibus master is possible.
<b>Offline</b>	WST 3 is offline. Data exchange with the Profibus master is NOT possible.
<b>Parameter error</b>	Erroneous parameter data from the Profibus master.
<b>Config.error</b>	Erroneous configuration data from the Profibus master.
<b>No communication</b>	No communication with the Profibus master.
<b>ASIC not init.</b>	Error at Profibus circuit initiation (Software or hardware error).

**Set-up list for WST 3 ... Address: .....**

Location/Notes: .....

Progr. name: ..... Ser. no.: ..... Date: .....

Modbus number	Parameter name	Default value	Set-up value	
41000	Superv. 1 source	Gross weight [2]	.....	.....
41002	Superv. 1 mode	Level mode [0]	.....	.....
41004	Level 1 outp.	Active above [0]	.....	.....
41006	Level/Setpoint 1	0.0	.....	.....
41008	Level 1 hyst.	0.0	.....	.....
41010	Relay 1 source	In process [1]	.....	.....
41012	Superv. 2 source	Gross weight [2]	.....	.....
41014	Superv. 2 mode	Level mode [0]	.....	.....
41016	Level 2 outp.	Active above [0]	.....	.....
41018	Level/Setpoint 2	0.0	.....	.....
41020	Level 2 hyst.	0.0	.....	.....
41022	Relay 2 source	In process [1]	.....	.....
41024	Language	English [1]	.....	.....
41026	Start mode	Auto [1]	.....	.....
41028	Display contrast	4 [4]	.....	.....
41030	Zero function	Off [0]	.....	.....
41032	More views	Off [0]	.....	.....
41034	Security lock	Off [0]	.....	.....
41036	Password	1937	.....	.....
41038	Ana. output type	4–20mA [3]	.....	.....
41040	Analogue source	Gross weight [0]	.....	.....
41042	Ana. range low	0.0	.....	.....
41044	Ana. range high	500.0	.....	.....
41046	Fixed ana. outp.	0.00	.....	.....
41048	Ana. bandwidth	10 Hz [7]	.....	.....
41050	Ana. low adjust	0	.....	.....
41052	Ana. high adjust	0	.....	.....
41054	Serialport mode	Modbus auto [2]	.....	.....
41056	Baudrate	9600 [5]	.....	.....
41058	Data format	8-none-1 [5]	.....	.....
41060	Instrum. address	1	.....	.....
41062	Ext. disp.mode	Gross weight [0]	.....	.....
41064	Ext. disp.format	6 [2]	.....	.....
41066	Profibus address	126	.....	.....
41068	Measurement unit	kg [2]	.....	.....
41070	Resolution	0.1 [6]	.....	.....
41072	Capacity	500.0	.....	.....
41074	Mains frequency	50 Hz [0]	.....	.....
41076	Dig. bandwidth	10 Hz [7]	.....	.....
41078	Calibration type	Data sheet [0]	.....	.....

## Set-up list for WST 3.... Address: .....

Location/Notes: .....

Progr. name: ..... Ser. no.: ..... Date: .....

Modbus number	Parameter name	Default value	Set-up value	
41080	Conv. factor	9.80665	.....	.....
41082	Number of transd	3	.....	.....
41084	Rated load	2000.0	.....	.....
41086	Rated output 1	2.03900	.....	.....
41088	Rated output 2	2.03900	.....	.....
41090	Rated output 3	2.03900	.....	.....
41092	Rated output 4	2.03900	.....	.....
41094	Value cal. p.1	0.0	.....	.....
41096	Value cal. p.2	500.0	.....	.....
41098	Transd.sign. p.1	0.00000	.....	.....
41100	Transd.sign. p.2	1.66631	.....	.....
41102	Set zero		.....	.....
41104	Zero offset	0.00	.....	.....
41360	Status input 1			
41362	Status input 2			
41364	Test relay 1			
41366	Test relay 2			
41368	Test ana. outp.			

### Appendix 1.

Set-up list.



## Declaration of Conformity

We Vishay Nobel AB  
Box 423, S-691 27 KARLSKOGA  
SWEDEN

declare under our sole responsibility that the product

### Transmitter WST 3

to which this declaration relates is in conformity with the  
following standards or other normative documents.

The essential requirements in the EMC Directive 89/336/EEC  
with amend. 92/31/EEC and 93/68/EEC.

EN 61 326:1997, EN 61 326 A2:2001

The product is supplied by 24 VDC and is therefore not covered by  
the requirements in the Low Voltage Directive 73/23/EEC.

KARLSKOGA Feb 10 2003.....

  
Bengt Schultz, Managing Director





Document no. 35192  
Article no. 600 630 R5  
© Vishay Nobel AB, 2011-05-11  
*Subject to changes without notice.*

**Vishay Nobel AB**  
Box 423, SE-691 27 Karlskoga, Sweden  
Phone +46 586 63000 · Fax +46 586 63099  
[pw.se@vishaypg.com](mailto:pw.se@vishaypg.com)  
[www.weighingsolutions.com](http://www.weighingsolutions.com)