

G5 Weighing Instrument

Program version 1.0.X



Technical Manual
PM and RM types

CONTENTS

1. Introduction	1	Setpoint function	12
General.....	1	Digital inputs and outputs.....	12
Maintenance.....	2	Analog output	12
Safety information	2	Filter function.....	13
Technical data.....	3		
Ordering information	6	6. Communication	1
		General	1
2. Installation	1	Serial interface	1
Mechanical installation	1	Modbus RTU Slave.....	1
Electrical installation.....	3	Modbus TCP Slave	2
Connection of cable shields	3	Ftp Server	3
Profibus-DP Fieldbus Adaptor.....	8	Modbus protocol.....	3
DeviceNet Fieldbus Adaptor	10	Fieldbus interface.....	18
ControlNet Fieldbus Adaptor.....	12	Fieldbus Data Definitions	19
Front panel	13		
		7. Remote Access	1
3. Set-up	1	General	1
General.....	1	Browser requirements.....	1
How to connect a PC to the instrument .	2	Using the Remote Access.....	2
Menu system.....	2	Security	2
Menu structure	4	Remote Access Login and Logout.....	3
Parameters.....	6	Remote / Local Access	5
4. Calibration	1	8. Maintenance.....	1
General.....	1	General	1
Common parameters	2	File Handling	1
Data sheet calibration	4	Create Backup	1
Table calibration.....	5	Restore Backup.....	1
Deadweight calibration.....	5	Set Default	1
		Instrument Restart.....	1
		Program upgrade	2
5. Operation	1	9. Troubleshooting.....	1
General.....	1	General	1
Power-up sequence	1	Error codes.....	1
Status LEDs	1		
Display at normal operation	2		
Security locks	3		
Taring.....	4		
Gross/Net operation	5		
Zero setting	5		
Zero-tracking/Automatic zero setting	6		
Motion.....	6		
Weight printing	7		
Alibi Memory	9		
Main Menu.....	9		
Level supervision	11		

PRECAUTIONS

READ this manual BEFORE operating or servicing this instrument. FOLLOW these instructions carefully. SAVE this manual for future reference.



WARNING

Only permit qualified personnel to install and service this instrument. Exercise care when making checks, tests and adjustments that must be made with power on. Failing to observe these precautions can result in bodily harm.

DO NOT allow untrained personnel to operate, clean, inspect, maintain, service, or tamper with this instrument.

INTENDED USE

The G5 Instrument family are measuring and control devices intended for industrial systems. Its basic function is to convert the signals from transducers to useful information. Transducer excitation is included as well as parameter controlled signal processing, indication of output levels, error supervision and operation of optional external equipment. The instrument supports several types of communication interfaces.

INSTRUMENT INSULATION AND GROUNDING

The cable connector for mains power supply should include protective grounding for safety. The cable for 24VDC power supply (screw terminal connector) should include a ground connected to terminal GND.

The input groups of the instrument are insulated from each other by functional insulation. The mains connection of AC-powered instruments has reinforced insulation according to IEC 61010. Terminals intended for connection of cable shields are connected to the protective ground of the mains or GND terminal of 24VDC input but must not be considered as protective grounding. Shield connection of load cell input is not connected to mains protective ground or 24VDC GND terminal.

Change description

Revision 0: First release of this document.

1. Introduction

General

The G5 Instruments are high performance single-channel weight indicators (PM model, panel mounted) or weight transmitters (RM model, DIN rail mounted) intended for industrial systems.

The basic function is to convert the signals from strain gauge transducers to useful weight information. Transducer excitation is included as well as parameter controlled signal processing, indication of output levels, error supervision and operation of optional external equipment.

As long as the error supervision detects no error, a signal called 'In process' is then present but if an error is detected, 'In process' will be off and a specific error message will be displayed. 'In process' can be set to control any digital output. Note that there are weighing channel specific and instrument specific error detection.

All functions in the G5 Instrument are controlled by set-up parameters. Setting of parameter values can be done from the PM front panel. Set-up of a RM model must be done with a web browser in a PC that is connected to the instrument via Ethernet. Maintenance functions can be accessed locally (PM) or remotely (PM and RM).

It is possible to load new software into the instrument using a SD-Card.

The instrument has 4 level supervising functions and 4 set-point functions.

Power supply

The G5-PM (panel mount indicator) is available as 24 VDC model or 110/230 VAC model. The G5-RM (rail mount transmitter) is available as 24 VDC model. All input and output signals are galvanically isolated from the power supply.

Strain gauge input

Both excitation voltage and the output signal from the transducer are measured at the transducer to avoid influence from voltage drop in the connection cable. Excitation to the transducer, from the G5 Instrument is provided over separate wires.

A shielded 6-wire cable must be used to connect a distant transducer to the instrument. The analog signals from the transducer are converted to digital form and filtered to give an internal transducer signal with high resolution.

The transducer excitation and signal values are combined to form an internal transducer signal, representing the load on the transducer. Influenced by calibration data, this signal is converted to a digital measurement value, the weight value, which can be presented at the local display window and at external equipment.

Communication

The instrument utilizes the serial interface, Ethernet and a fieldbus interface for communication with control system or computer. The serial interface consists of a RS-485/RS-422 connection that can be used with 2- or 4-wire connection.

Weight values, level status, error status etc. can be collected and commands given through the communication interfaces. G5 Instruments can be controlled from a master computer or PLC using the serial interface, Ethernet interface, field bus interface or digital I/O.

Modbus RTU protocol is used for the serial interfaces, Modbus TCP and EtherNet/IP for the Ethernet connection. Optional fieldbus interface for Profibus, DeviceNet or ControlNet can be used.

The serial port can also be used to connect a printer for printing of weight or for showing weight on an external display unit.

Maintenance

The G5 instrument needs no maintenance, performed by the end-user. Any service or repair work must be performed by qualified personnel.

Contact your supplier.

Cleaning

Before cleaning the G5, disconnect the power connection to the instrument. Use a soft cloth to clean the exterior of the instrument. For cleaning the instrument front panel, a soft, damp, cloth may be used.

Safety information

Utilization.

The instrument may only be utilized for the measurement and control functions, described in this Technical Manual. It is especially important to adhere to the load limits of the input/output connectors. We accept no responsibility for any damage arising from improper operation.

Any changes to the instrument, which causes any function changes, may only be carried out by the manufacturer or after discussion with and permission by the manufacturer.

If G5 is used in a manner not specified, the protection provided may be impaired.

Meaning of symbols used in this manual



Direct current.





Alternating current.



Caution, risk of danger. Documentation needs to be consulted.



Technical data

Enclosure types	PM - Panel mount	RM – DIN-rail mount
		
Enclosure design	Plastic, PC	Plastic, PC
Dimensions	WxHxD 226x126x100 mm (8.9"x5.0"x3.9") Depth behind front 100 mm (3.9") Front panel depth 14 mm (0.55") Depth not including connectors, screw terminals or cables	WxHxD 95x130x93 mm (3.7"x5.1"x3.7") Depth above DIN-rail 93 mm (3.7") Depth not including connectors, screw terminals or cables
Panel cut out	WxH 186 ±1 x 91 ±1 mm	N/A
Display	Color TFT LCD screen with backlighting, 4.3" 480x272 pixels	N/A
Keyboard	31 membrane keys	N/A
Temperature range	Rated performance: -10 to +55 °C Storage: -25 to +85 °C	Rated performance: -10 to +55 °C Storage: -25 to +85 °C
Relative humidity	Max. 85% up to 40°C, decreasing linear to 50% at 55°C. Non-condensing	Max. 85% up to 40°C, decreasing linear to 50% at 55°C. Non-condensing
Rated pollution	Pollution degree 2	Pollution degree 2
Protection	IP65 (panel), indoor use	IP20, indoor use.
Altitude	Up to 2000 m	Up to 2000 m
EMC, RF	CE (Industrial)	CE (Industrial)

Serial interface RS485	For process data and control or printout data to a connected printer. Isolated by operational insulation
Protocol	Modbus RTU, ASCII serial printer
Baud rate	Up to 115 kbaud
Cable ratings	Cable rated min 80°C when ambient temperature > 45°C Cable rated min 70°C when ambient temp. < 45°C and > 35°C

Fieldbus	For process data and control (optional)
Types	Profibus, DeviceNet or ControlNet
USB	Version 2.0
USB Memory	USB type for PC For backup and restore of set-up parameters. Operational insulation, max 500mA output.
SD-Card	Micro SD, Micro SDHC types.
Ethernet	10/100BASE-T. For process data, control, file transfer and remote access.
Protocols	Modbus TCP, ftp, http.
RJ45 Indications	Orange LED: 100 Mbit/s. Yellow LED: Receiving/Transmitting.
Power supply DC PM DC model, RM model	24 V \pm 15% including fluctuations, 15W Impulse withstand (overvoltage) category I of IEC 60364-4-443.
Cable ratings	Cable rated min 80°C when ambient temperature > 45°C. Cable rated min 70°C when ambient temp. < 45°C and > 35°C.
Power supply AC PM AC model only	110-240 V \sim +10% -15% including fluctuations, 50/60 Hz, 15W Impulse withstand (overvoltage) category II of IEC 60364-4-443
Cable ratings	Mains supply cord must be adequately rated. Cable rated min 70°C when ambient temperature > 45°C.
Load cell input	Operational insulation
Excitation voltage:	Nominal 10 V. Below is actual excitation shown with 350 ohm load cells. 1 LC => 9.72V, 2 LC => 9.46V, 3 LC => 9.21V, 4 LC => 8.97V, 5 LC => 8.75V, 6 LC => 8.54V, 7 LC => 8.33V, 8 LC => 8.14V,
Sense voltage	Min 1.2V, max 10V. Sense common mode must be within +0.5V relative terminal 26 in the load cell input connector.
Max load	Maximum 8 (350 ohm)
A/D conversion:	2.4 kHz, 16 000000 units (24 bits)
Input range	+/- 3 mV/V
Update rate:	300 weight updates per second
Sensitivity:	0.1 μ V
Zero drift:	<10 nV/V/K
Span drift:	<2 ppm/K
Digital I/O	
4 inputs	24 V \pm 15%, 5 mA from external power supply, isolated by operational insulation and with common return
4 outputs	24 V \pm 15%, max 100 mA from external power supply, isolated by operational insulation and with common return
Cable ratings	Cable rated min 80°C when ambient temperature > 45°C Cable rated min 70°C when ambient temp. < 45°C and > 35°C

Analog output	
Resolution	65000 units, 16 bits
Voltage output	0 – 10 V, -10 – 10 V, > 1 kohm load
Current output	4 – 20 mA, 0 – 20 mA, -12 – 20 mA, -20 – 20 mA, < 500 ohm load. Current source, i.e. no external power supply needed.
Update rate	300 Hz
Filter	Weight filter + extra smoothing filter (on/off via set-up)

Fieldbus	ProfibusDP, DeviceNet and ControlNet.		
Fieldbus data	16 bytes from fieldbus to instrument. 80 bytes from instrument to fieldbus. See chapter 'Communication' section 'Fieldbus communication interface' for details on fieldbus data mapping.		
Settings	All fieldbus settings are done with setup parameters in the instrument. No settings are done on the module itself.		
Mounting	The fieldbus adaptor is mounted in the fieldbus slot with LED's and connector accessible. Remove the plastic cover from the fieldbus slot. Insert the adaptor very carefully and make absolutely sure that the adaptor slides correctly into the guides in the connector on the PCB. Tighten the two fastening screws at the adaptor front and check that the two securing hooks locks into the PCB.		
Module type	Profibus-DP	DeviceNet	ControlNet
			
Connector	Profibus 9-pin, female D-sub (DB9F)	5 pin male connector.	BNC.
Baud rate	9.6 kbps – 12 Mbps or Auto set by parameter	125, 250, 500 kbps or Auto set by parameter.	Fixed 5 Mbit/s.
Address	1 – 125, set by parameter	0 – 63, set by parameter	1 – 99, set by parameter
Bus Supply Voltage		According to DeviceNet (Node) specification: nominal 24 VDC, range 11 – 25 VDC.	

Ordering information

PM model, single channel weighing, 24VDC supply

Denomination: G5-PM-S-DC-W

P/N: 110767 (ordering number).

PM model, single channel weighing, 110/230VAC supply

Denomination: G5-PM-S-AC-W

P/N: 110768 (ordering number).

RM model, single channel weighing, 24VDC supply

Denomination: G5-RM-S-DC-W

P/N: 110771 (ordering number).

If an (optional) fieldbus module is needed it must be ordered together with the instrument. Ordering numbers are shown below. If multiple instruments and/or fieldbus modules are purchased in the same order it must be clearly specified which module should be mounted in which instrument.

Optional ProfibusDP fieldbus module

P/N: 110559 (ordering number).

Optional DeviceNet fieldbus module

P/N: 110560 (ordering number).

Optional ControlNet fieldbus module

P/N: 110838 (ordering number).

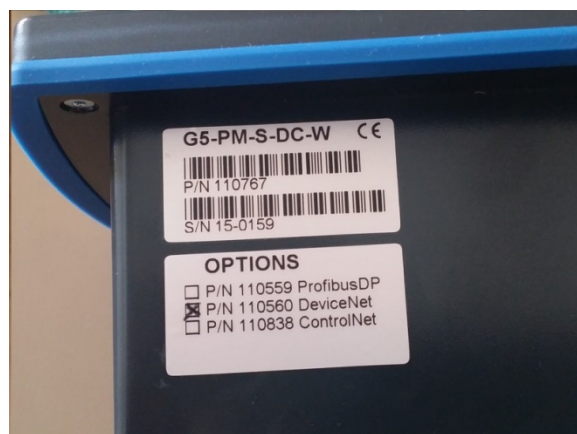

Example showing product information and installed option(s).

2. Installation

Mechanical installation

See chapter **Introduction – Technical data** for references to PM and RM mechanical measures: outer extents and body extents.

The safety of any system incorporating the equipment is the responsibility of the integrator of the system.

Allow at least 20 mm free space around the instrument for ventilation.

PM type instrument:

In an enclosed plastic bag there are four M5x30 hexagon socket head screws and four fastening brackets.

1. Insert the instrument in the panel cutout.

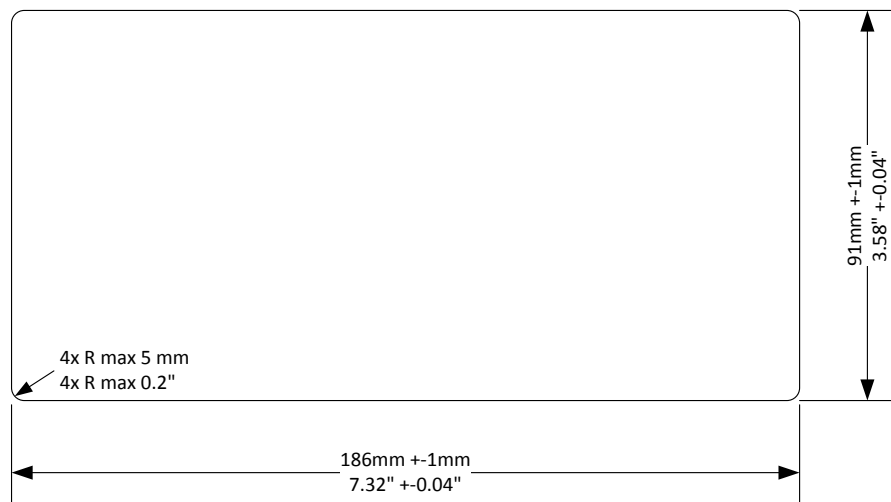

2. Place a bracket in the corner recession of the rear of the instrument and use the M5 screw to secure it without tightening it.
3. Place the remaining three brackets and secure each with M5 screws. Tighten the screws until the brackets start to press against the inside of the panel.
4. Make sure the tip of the brackets is resting against the panel on which the instrument is mounted and not on the instrument plastic front. This might happen if the cutout is large.
5. Check that the instrument is positioned so that the blue front sealing is not visible through the cutout which might compromise the sealing properties.
6. When the instrument is properly positioned tighten the screws 2 – 3 turns. Do not overtighten. Note that the brackets are flexible.
7. Provide support for the cables to avoid that strain is applied to the connectors.



Mounting bracket on the panel mount model

RM type instrument:

The unit snaps on to a DIN-rail. Place the unit with the front slightly tilted upwards on to the DIN-rail. Make sure the hooks at the rear of the instrument enclosure are gripping over the upper edge of the DIN rail. Push the unit down and towards the DIN-rail until it snaps into locked position. If needed use a screwdriver to help open the latch to make it snap on.

Use a screwdriver to open the latch if the unit is to be removed from the DIN-rail.



Electrical installation

The field wiring of the instrument shall be suitable to the environment (e.g. chemically) in the end-user application.

Mains cables shall be separated and routed away from SELV or SELV-E field wiring.



Field wiring installation shall comply with any national regulations, hereunder National Electrical Code (NEC) for US and/or Canadian Electrical Code for Canada.

- A switch or circuit-breaker shall be included in the building installation.
- The switch shall be in close proximity to the equipment and within easy reach of the operator
- The switch shall be marked as the disconnecting device for the equipment.
- The equipment switch or circuit-breaker employed as disconnecting device shall comply with relevant requirements of IEC 60947-1 and IEC 60947-3.

The power supply for the instruments can be an external DC source for G5-PM-S-DC-W and G5-RM-S-DC-W units or external AC mains for G5-PM-S-AC-W units.

For electrical installation with DC supply, see section **DC Supply**.

For electrical installation with AC supply unit, see section **AC Supply**.

WARNING

Make sure that the power to the instrument is turned off before any connections are connected to or disconnected from the instrument.

Remove connector from instrument when tightening or loosening screw terminal screws.



The voltage levels on connectors shall not exceed hazardous voltage levels of 30 Vrms, 42.4 Vpeak or 60 Vdc under normal conditions. In wet locations these voltage levels shall not exceed 16 Vrms, 22.6 Vpeak or 35 Vdc. This applies to all accessible parts.



Connection of cable shields

Shielded cables should be used to avoid EMI on the measurement signals or from entering the instrument. Shields should be grounded in one point of the cable. Avoid grounding via long and thin leads which will impair the shielding ability of the cable. The preferable point of grounding is when the cable enters the metal cabinet housing the instrument. There are a few ways of grounding the cable shield:

1. The absolutely best way of grounding the shield is by using EMI cable glands that will provide a seamless protection against EMI.
2. Connect the shield to a ground strip inside the cabinet close to the entry point.
3. Connect the shield to a ground terminal inside the cabinet. Always keep the shield all the way to the instrument.

The following applies to HW version 2 or later. See the **System Information** menu to find out the actual HW version of the instrument. The shield of the load cell cable can also be connected at terminal 26 to achieve best possible noise immunity of the LC input. Note that terminal 26 is not the grounding point of the load cell cable but it will extend the shield into the ground plane of the input circuit. Terminal 26 is not connected to the ground of the instrument.

Communication

External computing devices connected to the communication interfaces of the instrument have to comply with the standard, UL 60950.



RS422/RS485

The serial communication is made for 2-wire or 4-wire with common 0 V. This is a SELV/SELV-E circuit.

It can be used for serial communication to computer/PLC (Modbus RTU) or a printer. Connections are made to terminals 1 – 5. Shielded cable must be used. Shield can be connected to terminal 6 unless grounded in other point.

The communication lines must be terminated in both ends. Termination switches are set as shown in the table below:

DIP switch settings

	2wire DIP-switches	T DIP-switches	R DIP-switches
2-wire with termination	ON (x2)	ON (x2)	OFF (x2)
4-wire with termination	OFF (x2)	ON (x2)	ON (x2)
2-wire without termination	ON (x2)	OFF (x2)	OFF (x2)
4-wire without termination	OFF (x2)	OFF (x2)	OFF (x2)

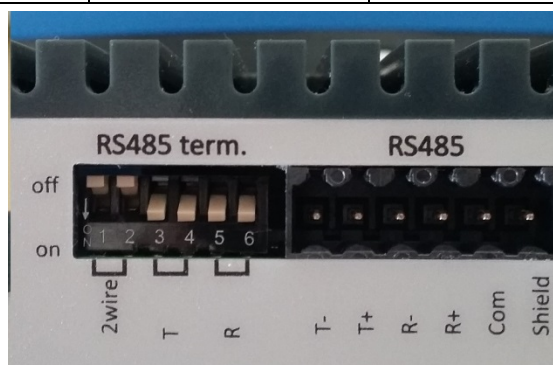

*Example of DIP-switch settings.
4-wire with termination*

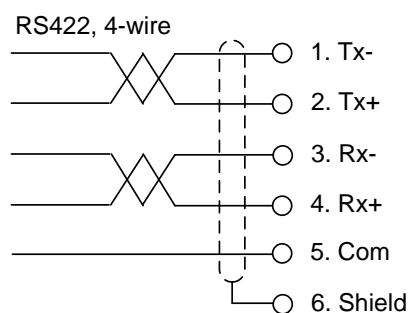
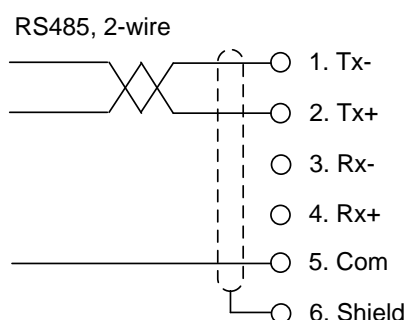

Field Bus

Slot for optional Fieldbus interface. Profibus DP-V1, DeviceNet and ControlNet are available. See section Profibus-DP Fieldbus Adaptor or DeviceNet Fieldbus Adaptor or ControlNet Fieldbus Adaptor later in this chapter for details.

USB

The USB connector is intended for USB memory only. This port has operational insulation (from HW version 2). It should be considered as a SELV/SELV-E circuit. USB Hub is not supported.

Ethernet

This is a SELV circuit. Use a category 5 cable to connect to a PC (point to point connection) or to connect to other equipment through a switch, hub or router. Use an electrically isolating network device if the instrument is being connected to the public network.

DC supply

The output of the external DC source must be rated 24 V $\overline{=}$, $\pm 15\%$ including fluctuations, min. 15 W. The DC source must provide Double Insulation between Mains parts and 24 V SELV or SELV-E Circuit, and a limited-energy circuit (maximum available current of 8 A). For the US market this energy limit can be achieved with an ANSI/UL248-14 fuse rated 5A. For other markets an IEC 60127 T type fuse rated 4A may also be used.



24 VDC power is connected to terminals 19, 20 and 21. The G5 instrument should be powered by 24 V $\overline{=}$, connected according to the diagram below. To achieve functional grounding, terminal 21 should be connected to ground.

See Technical data for input voltage ratings.

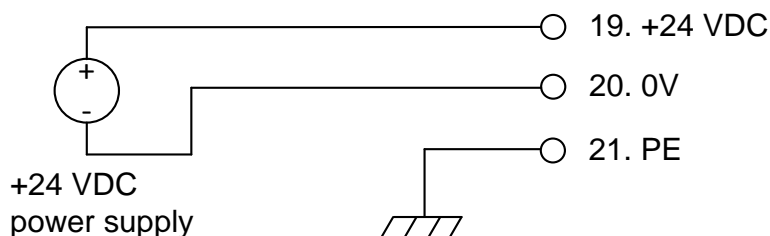

AC supply

Mains supply cable shall be separated and routed away from SELV or SELV-E field wiring.

The branch circuit protection in the building installation must be rated maximum 20 A. To achieve protective grounding, the PE conductor shall be connected to protective earth.

Power inlet type C-14 according to IEC60939.

Use cable connector type C-13 according to IEC60320.

See Technical data for input voltage ratings.



Load cell connection

Terminals 22 – 29, transducer connection and cabling should be handled with great care to achieve good measurement of data. Transducer integrated cables may not be shortened.

NOTE! Transducer cables must be routed at least 200 mm away from 230/400 V, 50/60 Hz power cables. By cables with other frequencies or high power, an even wider distance is preferable.

4-wire connection can be used if the transducer integrated cable is long enough to be connected directly to a transducer input. With a 4-wire connection Sense+ must be connected to Exc+ and Sense- must be connected to Exc-.

6-wire connection should be used if the integrated cable must be lengthened or if several transducers should be connected to one transducer input.

The transducer input is insulated by operational insulation and the shield should be connected to the most convenient ground/earth point. This can be the junction box when using multiple transducers, at the cable entry to the enclosure where the G5 is mounted or at the barrier ground when using Ex zener barriers.

Shield can be connected to terminal 26 if the instrument is of HW version 2 or later.

In the junction box SL-4 from BLH Nobel all necessary terminals and interconnections are provided.

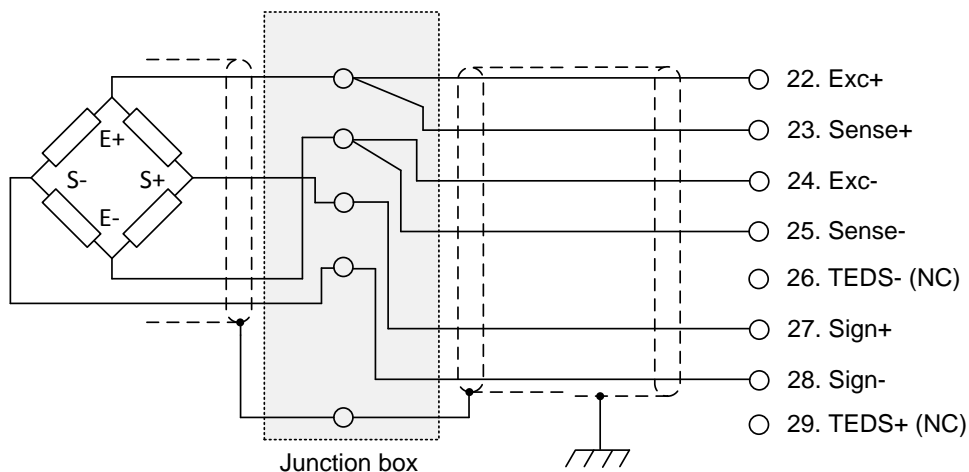

Connection of transducer(s)

Solid state relay outputs

Digital outputs use terminals 7 to 10 with terminal 11 (OCom) as the common connection. Four digital outputs are provided with contact rating given in Technical data. External 24 VDC power supply must be used. Note that either the positive or the negative pole of the voltage source (24 V \equiv) can be connected to OCom (11).

Shielded cable/cables should be used and the shield can be connected to terminal 12 if it's not possible to ground it in another point.

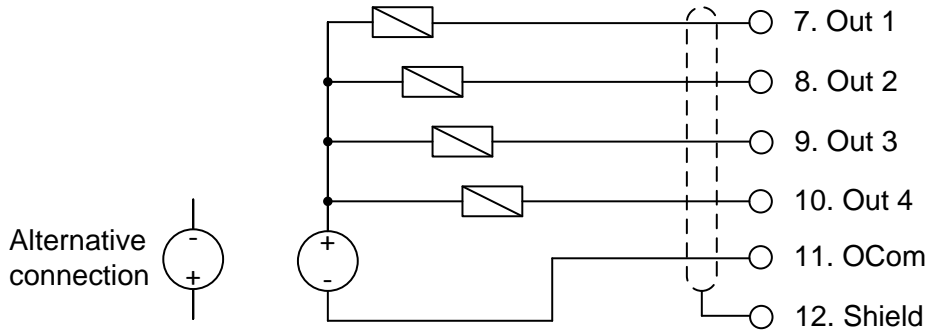

Digital inputs

Digital inputs use terminals 13 to 16 with terminal 17 (ICom) as the common connection. Four digital inputs are provided, with functions that can be set in the G5 set-up. External 24 VDC power supply must be used. Note that either the positive or the negative pole of the voltage source (24 V \equiv) can be connected to ICom (17).

Shielded cable/cables should be used and the shield can be connected to terminal 18 if it's not possible to ground it in another point.

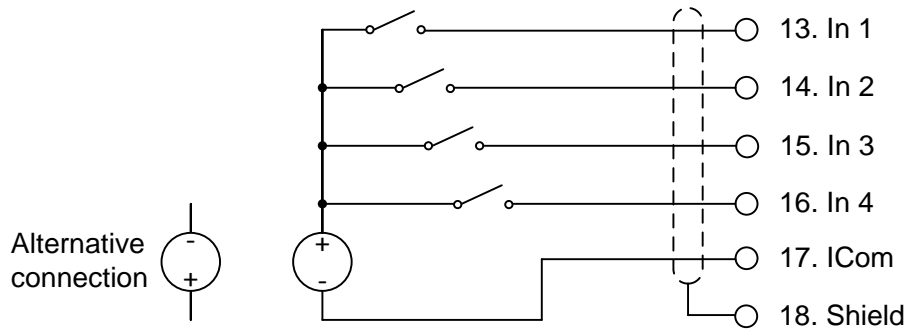

Analog input and analog output

Terminals 38 (Vi) and 39 (Comi) are used for the +-10V auxiliary analog input of the instrument. The analog output is connected to terminals 41 (Como) and output signal to terminal 42 (Vo1/Io1). The analog output is either voltage or current loop. Como and Comi are internally connected.

Shielded cable/cables should be used and the shield can be connected to the shield terminal 40 if it's not possible to ground it in another point.

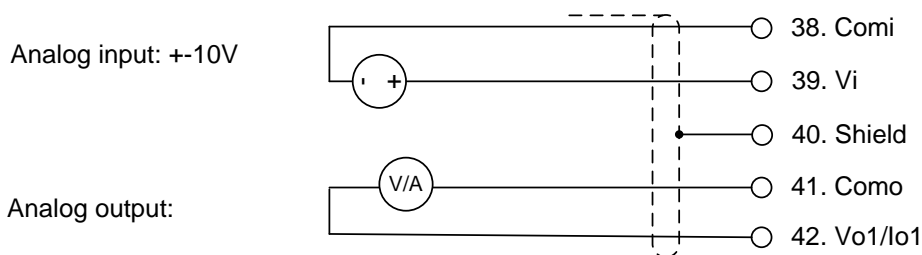

Profibus-DP Fieldbus Adaptor

Profibus module front view

- (1) Operation mode LED.
- (2) Status LED.
- (3) Profibus connector.

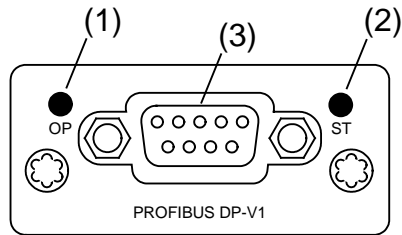

Operation mode LED

State	Indication
Off	Not online / No power
Green	On-line, data exchange
Flashing Green	On-line, clear
Flashing Red (1 flash)	Parameterization error
Flashing Red (2 flashes)	Profibus configuration error

Status LED

State	Indication
Off	No power or not initialised
Green	Initialised
Flashing Green	Initialised, diagnostic event(s) present
Red	Exception error

Profibus connector (DB9F)

Pin	Signal	Description
1	-	-
2	-	-
3	B line	Positive RxD/TxD, RS485 level
4	RTS	Request to send
5	GND Bus	Ground (isolated)
6	+ 5V Bus Output	+5V termination power (isolated)
7	-	-
8	A line	Negative RxD/TxD, RS485 level
9	-	-
Housing	Cable shield	Functional ground internally connected to the module protective ground via cable shield filters according to the Profibus standard.

For connection of the adaptor to the Profibus master, use a Profibus standard cable and connector according to the diagram below.

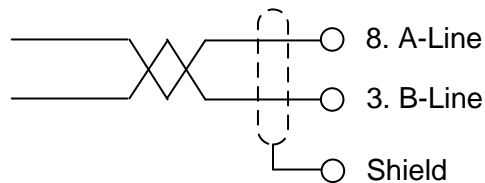

For reliable fieldbus function, line termination must be arranged in both ends of the transmission line. For a G5 instrument, at the end of the cable, a connector with line termination should be used. For all other G5 Instruments, connection without line termination should be used.

For configuration of the adaptor, a GSD file (VISH0F83.GSD) is available and should be installed in the master.

Select the 8 words output module + 2 x 16 words input modules + one 8 words input module. This will give 16 bytes of output data and 80 bytes of input data. The PLC set-up should match this exactly including the order of the input modules.

DeviceNet Fieldbus Adaptor

DeviceNet module front view

- (1) Network Status LED.
- (2) Module Status LED.
- (3) DeviceNet connector.

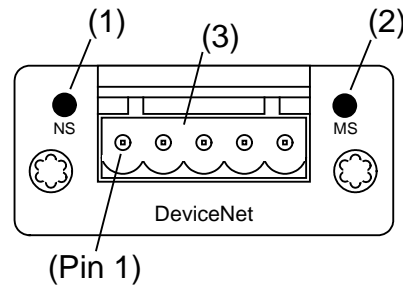

Network Status LED

State	Indication
Off	Not online / No power
Green	On-line, one or more connections are established
Flashing Green (1 Hz)	On-line, no connections established
Red	Critical link failure
Flashing Red (1 Hz)	One or more connections time out
Alternating Red/Green	Self-test

Module Status LED

State	Indication
Off	No power
Green	Operating in normal condition
Flashing Green (1 Hz)	Missing or incomplete configuration
Red	Unrecoverable fault(s)
Flashing Red (1 Hz)	Recoverable fault(s)
Alternating Red/Green	Self-test

DeviceNet connector

Pin	Signal	Description
1	V-	Negative bus supply voltage
2	CAN L	CAN low bus line
3	Shield	Cable shield, functional ground.
4	CAN H	CAN high bus line
5	V+	Positive bus supply voltage

For connection of the adaptor to the DeviceNet master, use a standard cable for DeviceNet or similar shielded cable with twisted pairs and a connector according to the diagram below. The bus supply voltage shall be 11 – 25 VDC.

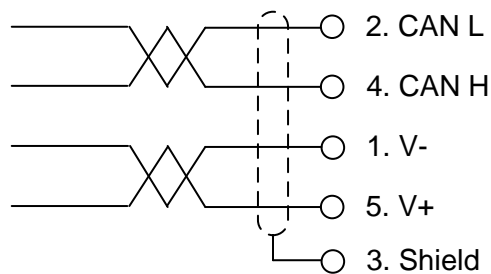

For reliable fieldbus function, line termination must be arranged in both ends of the transmission line. For a G5 Instrument placed at the end of the line, terminate line by placing a 121-ohm resistor between CAN L (pin 2) and CAN H (pin 4).

For configuration of the adaptor an EDS file is supplied with the instrument that should be installed in the master. Note that the EDS file is a generic type supplied by the module manufacturer. The file doesn't contain any reference to the G5 Instrument or to BLH Nobel.

ControlNet Fieldbus Adaptor

ControlNet module front view

- (1) Network Status LED A.
- (2) Module Status LED.
- (3) Network Status LED B.
- (4) ControlNet connector A.
- (5) ControlNet connector B.

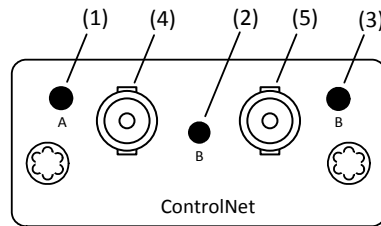

Network Status LED A/B

LED	State	Indication
LED A and B	Off	Not online / No power
	Flashing Red (1 Hz)	Incorrect node configuration, duplicate MAC ID etc.
	Alternating Red/Green	Self-test of bus controller
	Red	Fatal event or faulty unit
LED A or B	Off	Channel is disabled
	Alternating Red/Green	Invalid link configuration
	Flashing Green (1 Hz)	Temporary errors (node will self-correct) or node is not configured to go online
	Green	Normal operation
	Flashing Red (1 Hz)	Media fault or no other nodes on the network

Module Status LED

State	Indication
Off	No power
Green	Operating in normal condition, controlled by a Scanner in run state
Flashing Green (1 Hz)	The module has not been configuration or Scanner in idle state
Red	Unrecoverable fault(s), EXCEPTION, fatal event
Flashing Red (1 Hz)	Recoverable fault(s), MAC ID has been changed after initialization etc.

ControlNet connectors

These connectors provide ControlNet connectivity. If redundancy is wanted both connectors should be used. Otherwise either connector can be used.

Front panel

Display

At normal operation the instrument displays weight value(s) and, in some cases, the gross weight as a graphic bar. Together with the weight value additional information such as preset tare, status for the level supervision can also be displayed. This is configured with parameters.

If an instrument error occurs, the weighing function is stopped and the instrument switches over to Error mode, indicating a code for the error at the display window.

If there is a scale error this is indicated with error information that replaces the weight information on the screen. The instrument can also display a Main menu with sub menus for display of actual data and entry of new data.

Function keys

Just below the display there are four function keys, F1 to F4, and with the actual key functions indicated at the lower line of the display. When there is a text above a key, that key has the corresponding function. To select a function, press the membrane panel button (F1 to F4) below the display.



Symbol keys

At the bottom of the front panel there are four keys, marked with the weighing symbols for Zero, Tare, Gross/Net, Print plus keys marked Start and Stop. A brief description of these keys is given in the table below.

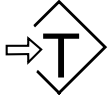

Front panel of the G5 instrument with color display, four function keys below the display, six application specific keys, numerical keypad, joystick keypad (arrow keys), Esc, Backspace, Delete, Tab and ENTER keys.

In addition there is an Info key that is used to access the instruments menu system.

Key	Name	Function
	ZERO	Setting the gross weight value to zero (provided the value is in the zeroing range: -1 % to +3 % of the capacity) and setting the auto tare value to zero.
	TARE	Taring, i.e. entry of the gross weight as auto tare value and display of net weight zero. Depending on actual setting taring may be prevented if 'Motion' is displayed.
	GROSS/NET	Toggling between display of gross weight and net weight. Net weight can be displayed only if a tare weight has been entered or acquired.
	PRINT	Printing of the displayed weight value on a connected printer according to parameter settings.
	START	Not used in this program version.
	STOP	Not used in this program version.

Numerical keys

The digit keys, including keys with minus sign and decimal point, are used for entry and editing of numerical parameter values.

Miscellaneous keys

An ENTER key on the panel is used to open a selected menu, finish the entry of a value, etc.

The four arrow keys are used to navigate in the menu system and to toggle between selections.

The Esc, Del, Backspace and Tab keys are used for editing values, toggling between selections and so on.

The 'Info' key is used to enter the instrument menu system. Note that this key can only be used when the weight display is shown.

3. Set-up

General

All operating functions in the G5 Instrument are controlled by parameters. The parameter values are permanently stored in the instrument and will not be lost when the unit is switched off. At delivery the parameters are factory-set to default values, giving the instrument an initial standard function.

The actual setting of the parameter values can be read and edited during normal measuring operation in sub menu 'Parameter Set-up'. Editing of parameter values can be performed using the color display and keys on the front panel of the instrument or by using a Web Browser on a PC connected on the same network as the instrument. After editing hardware parameters the instrument will be restarted.

In the instrument there are two levels of security locks provided to protect from unauthorized access to instrument functions and editing of parameters and values. The locks are opened by four-digit codes.

Warning: *Changes done during editing of set-up parameters will affect the behavior of the instrument immediately. The user must take all necessary precautions to prevent any undesired effects in the process monitored or controlled by the G5 instrument or a connected control system.*



It is strongly recommended to activate the set-up lock in the instrument to prevent any unauthorized changes of set-up parameters.

It's a good practice to make a backup of the set-up after changes have been done. See chapter 'Maintenance' for more information on backup and restore.

The 'Parameter Set-up' menu contains the following sub menus:

General: This parameter group controls the general functionality of the instrument. Such as display language, display mode, security, key functions and so on.

Hardware Configuration: Parameters used for selecting fieldbus module. Note that when the instrument is starting up it will check that the installed hardware is compatible with the settings. If the wrong fieldbus module is used an alarm will be issued.

Calibration Parameters and Calibration: Two menus with parameters that affect the behavior of the instrument. There are parameters for calibration type, calibration values, no of transducers, filter settings, motion detection, zero handling and so on.

Communication: Sub menus are Serial Com, Ethernet and Fieldbus.

Serial Com sub menu content are parameters used to set-up RS485. Parameters are among others: com. port mode, baud rate and data format. Ethernet sub menu content is parameters for Modbus TCP Slave. Fieldbus sub menu content is configuration parameters related to fieldbus communication such as address, baud rate and transmitted data setup.

Level Supervision: The instrument has 4 level supervisors that are configured from this sub menu. Settings for each level are which signal that shall be monitored. Signals that can be monitored are gross weight, net weight. The output function e.g. if the output shall be active above or below the set level is configured here. The fourth parameter for each level is the hysteresis setting.

Setpoints: The G4 instrument contains 4 setpoints that are individually configurable regarding which signal it shall monitor.

Inputs: The use of the instruments digital inputs is set in this menu. Possible usage for an input is tare command, zero command, gross/net toggling and so on.

Outputs: The outputs menu contains the settings controlling the function of each output. Each output can be assigned an output function: Level output status, setpoint output status, net mode, good zero, stable weight displayed or In Process status.

Analog Output: This menu controls the behavior of the Analog output. The output signal source (signal type) can be selected. Also output type and range is settable.

How to connect a PC to the instrument

Both Panel Mount (PM) and DIN rail (RM) models can be accessed from a PC with a Web Browser. To access the instrument requires both instrument and PC to be connected to the same network or to have a direct connection using only an Ethernet cable. If the instrument is connected to a network it should be set-up to fit the network configuration.

Default network configuration (at delivery) is static ip-address 192.168.99.150 and Subnet mask 255.255.255.0. This ip address is selected to avoid collision if the instrument is connected without being configured. Use this default setting or change it using the method described below to access the instrument to make a final network configuration. A PM model can be configured directly using the front panel keyboard and display.

If the PC and the instrument are directly connected the PC should be configured to use a static ip-address e.g. 192.168.99.10 and subnet mask 255.255.255.0. Start the Web Browser and enter the instrument ip-address in the address field of the browser.

An instrument can be temporarily forced to a specific ip-address by placing a text file on a USB memory, inserting it in the USB connector of the instrument and turn on the power. This is useful if the instrument is connected to a network before it's configured or if the actual network settings are unknown (lost). The text file shall be named "G5_STAT.IP". The file shall contain the following information where # denotes comments which can be omitted. Note that this is only an example.

```
# Settings for temporary use of static IP address  
192.168.59.243 # IP address  
255.255.255.0 # Subnet mask  
192.168.59.1 # Default gateway
```

When the desired network configuration is done remove the USB memory and power up the instrument and the new network configuration is in operation. It is possible to use this way to access the instrument also for other set-up of than just network configuration.

Menu system

To reach the main menu, press the 'Info' button (when the weight display is shown) on the instrument front panel.

If a Web Browser is used enter the ip address of the instrument and enter the login name "G5User" together with the pin code (default 1937). The pin code can be changed in the Network Configuration menu (Server Configuration sub menu).

Navigating in a menu is done with arrow keys. To open a sub menu, e.g. Parameter Set-up, select the desired line with arrow keys (selected sub menu is highlighted) and press 'Enter'. In the same way a parameter is selected and opened for editing.

If a Web Browser is used to access the instrument click the desired line to open a sub menu or edit a parameter.

Main Menu	10/02/2015 01:28 PM
Levels Setpoints Preset Tare Accumulated Weights Batched Weights Clock Set-up Parameter Set-up System Information Maintenance Network Configuration	
Enter	Escape

Main menu

Parameter editing

When editing a choice parameter e.g. language as in the figure, a list of available choices is show on screen with the current selection highlighted. To change the selection the up/down arrow keys can be used.

To confirm the new selection press the 'Enter' key.

To abort editing and keep the previous setting, press the 'Esc' key.

Edit: Language			
<table border="1"> <tr> <td>English</td> </tr> <tr> <td>Svenska</td> </tr> </table>		English	Svenska
English			
Svenska			
Select	Escape		

Editing a choice parameter. Note that the languages mentioned are examples, not the actual implementation.

If a Web Browser is used simply click the desired choice on the screen. Click Escape button on screen to abort.

When editing a numerical parameter e.g. a level hysteresis setting as in the figure, the new value should be typed with the numerical keys.

To confirm the new value press the 'Enter' key.

To abort editing and keep the previous setting, press the 'Esc' key.

Edit: Level 1 Hystereses	
Value:	<input type="text" value="23.200"/> kg
Maximum value:	999999 kg
Minimum value:	-999999 kg
Select	Escape

Editing a value parameter.

If a Web Browser is used enter the desired value with the PC keyboard and click Select button on screen. Click Escape button on screen to abort.

Menu structure

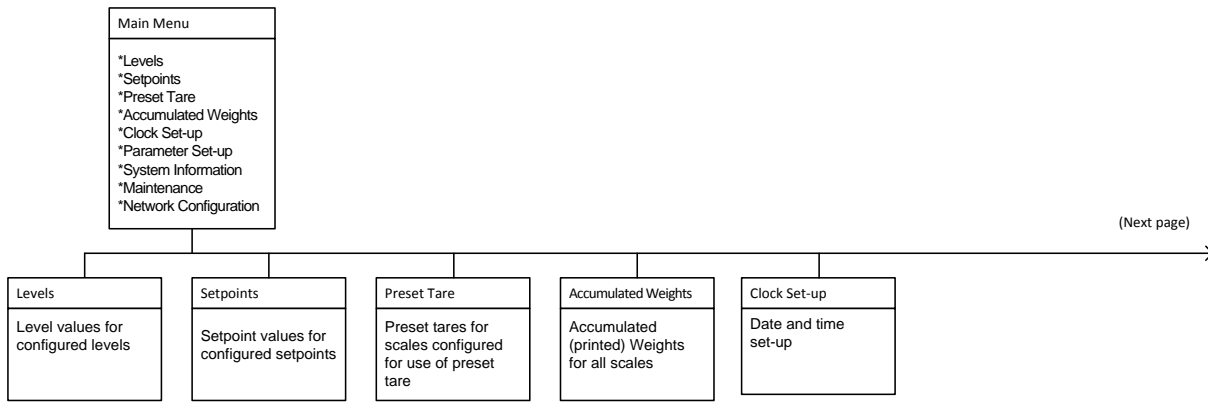

(Next page)

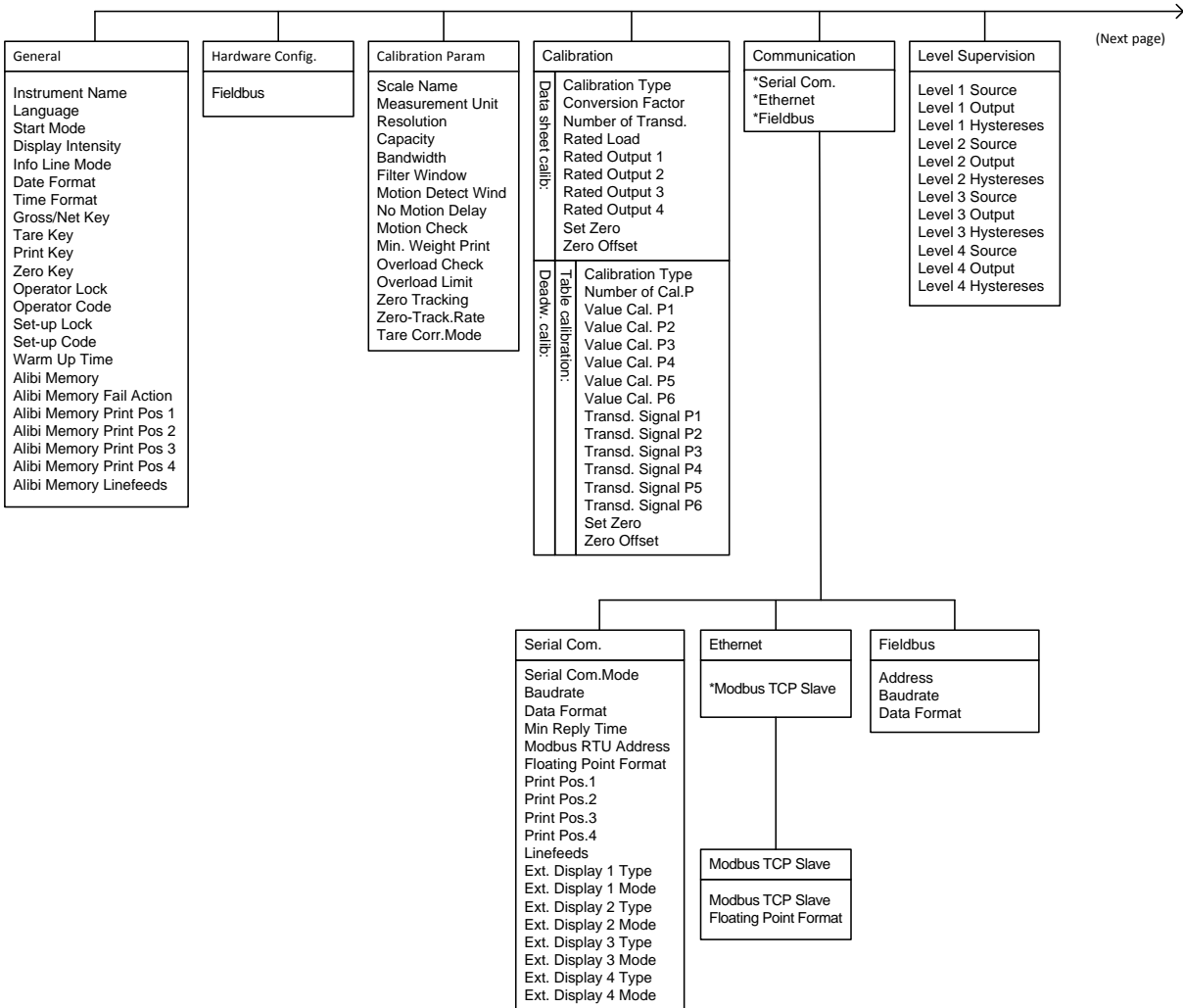

(Next page)

Menu structure (continued)

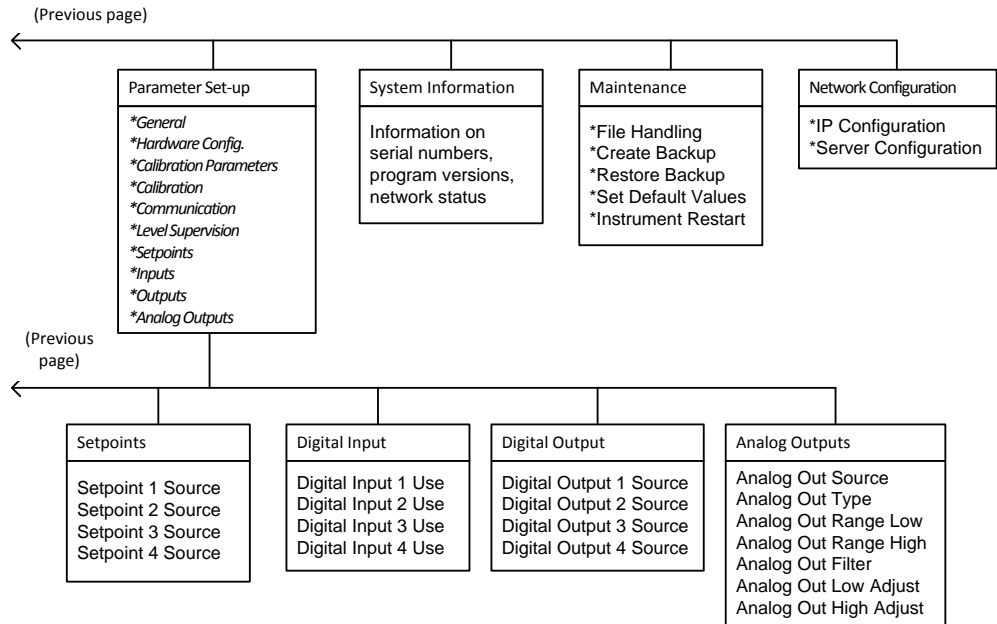

Menu structure (continued)

Parameters

On the following pages a survey of all parameters is presented. The parameters are divided in groups following the menu they belong to. For choice parameters the available choices are given. For numerical parameters, a value range is given.

At the end of the table, the default value is given in < >.

To the right there is a short parameter explanation and, *in italic*, the results for the different alternatives.

Range/Alternatives <default value>	Explanation and result of alternatives.
---------------------------------------	--

Menu General

Instrument Name

<>	A 15-character string that is used at printing in reports and so on.
----	--

Language

English Svenska <English>	Defines the language to be used in menus and messages.
---------------------------------	--

Start Mode

Command Auto <Auto>	Defines the start mode after power-on or reset. Command: A 'start operation' command from control computer or panel key is required for start up. Auto: Automatic start up.
---------------------------	---

Display Intensity

10 % 20 % 30 % 40 % 50 % 60 % 70 % 80 % 90 % 100 % <50 %>	Defines intensity of the graphical display backlight.
---	---

Info Line Mode

Not in use Acc. Weight Preset Tare < Not In Use >	Defines the mode of the first information line on the 1 scale screen on the graphical display. Not in use: Info line 1 is not used. Acc. Weight: The accumulated weight for the shown scale is presented on the first info. line. Preset Tare: The preset tare of the shown scale is presented on the first info. line.
--	---

Range/Alternatives <default value>	Explanation and result of alternatives.
Date Format	
YYYY-MM-DD	Defines the date format. YYYY: = year. MM: = month. DD: = day.
YYYY-DD-MM	
DD-MM-YYYY	
MM/DD/YYYY	
<YYYY-MM-DD>	
Time Format	
12 h	Defines the time format. 12 h: 12 hour time format. 24 h: 24 hour time format.
24 h	
<24h>	
Gross/Net key	
Off	Disables/enables front panel key Gross/Net Off: The Gross/Net key is disabled. On: The Gross/Net key is enabled
On	
<On>	
Tare key	
Off	Disables/enables front panel key Tare Off: The Tare key is disabled. On: The Tare key is enabled.
On	
<On>	
Print key	
Off	Disables/enables front panel key Print Off: The Print key is disabled. On: The Print key is enabled.
On	
<On>	
Zero key	
Off	Disables/enables front panel key Zero Off: The Zero key is disabled. On: The Zero key is enabled.
On	
<On>	
Operator Lock	
Off	Off: Operator lock is not activated. On: Operator lock is activated, preventing unauthorized access to the instrument. See chapter 'Operation – Security locks'.
On	
<Off>	
Operator Code	
Range: 1 - 9999 <1937>	Defines the valid code for Operator lock. If 'Set-up lock' (see below) is 'On' this code will not give access to 'Parameter Set-up'. Note: this parameter is only shown if 'Operator Lock' is set to 'On'
Set-up Lock	
Off	Off: Set-up lock is not activated. On: Set-up lock is activated, preventing unauthorized access to the instrument. See chapter 'Operation – Security locks'.
On	
<Off>	

Range/Alternatives <default value>	Explanation and result of alternatives.
---------------------------------------	--

Set-up Code

Range: 1 - 9999 <1937>	Defines the valid code for Set-up lock. If 'Operator lock' (see above) is 'On' this code will still give access to all menus in the Main menu. Note: this parameter is only shown if 'Set-up Lock' is set to 'On'
------------------------------	--

Warm Up Time

Range: 0 - 200 Unit: min <0>	Defines the delay time in minutes from power up until the weight presentation has full accuracy. Indicated in the display with the text 'Warming up!'.
---------------------------------------	--

Alibi Memory

Off On <Off>	On: Enables saving of print results to the Alibi file that is stored on the internal file system. Off: Disables saving to the Alibi file.
--------------------	--

Alibi Memory Fail Action

Ignore Warning Fatal, stop processing < Fatal, stop processing >	Ignore: Any error in queuing or saving to the Alibi file is ignored. Warning: An error queuing or saving to the Alibi memory will have a warning showed on the display of a PM instrument. Fatal, stop processing: An error queuing or saving to the Alibi memory will cause a fatal error in the instrument. This mode is used if it's absolutely necessary to have the print result stored.
---	--

Alibi Memory Print Pos 1

Not in use Display Weight Preset Tare Date/Time Scale Name Instrument Name < Date/Time >	Specifies the information that should be stored in printer position 1 (upper left field). This parameter controls storing in Alibi file. Not in use: Printer position 1 is left empty. If both 'Print Position 1' and 'Print Position 2' are set to 'Not in use' the upper line is not stored. Displayed Weight: The displayed weight is stored including the text Gross/Net and the unit. Preset Tare: The value of the preset tare is stored. Date/Time: The date and time is stored. Scale Name: The scale name is stored. Instrument Name: The instrument name is stored. Note: This parameter is only shown if Alibi Memory is On .
--	---

Range/Alternatives <default value>	Explanation and result of alternatives.
---------------------------------------	--

Alibi Memory Print Pos 2

Not in use	Specifies the information that should be stored in printer position 2 (upper right field). This parameter controls storing in Alibi file.
Displayed Weight	
Preset Tare	Not in use: Printer position 2 is left empty. If both 'Print Position 1' and 'Print Position 2' are set to 'Not in use' the upper line is not stored.
Date/Time	
Scale Name	
Instrument Name	Displayed Weight: The displayed weight is stored including the text Gross/Net and the unit.
< Scale Name >	Preset Tare: The value of the preset tare is stored. Date/Time: The date and time is stored. Scale Name: The scale name is stored. Instrument Name: The instrument name is stored.
	Note: This parameter is only shown if Alibi Memory is On .

Alibi Memory Print Pos 3

Not in use	Specifies the information that should be stored in printer position 3 (lower left field). This parameter controls storing in Alibi file.
Displayed Weight	
Preset Tare	Not in use: Printer position 3 is left empty. If both 'Print Position 3' and 'Print Position 4' are set to 'Not in use' the lower line is not stored.
Date/Time	
Scale Name	
Instrument Name	Display Weighted: The displayed weight is stored including the text Gross/Net and the unit.
< Displayed Weight >	Preset Tare: The value of the preset tare is stored. Date/Time: The date and time is stored. Scale Name: The scale name is stored. Instrument Name: The instrument name is stored.
>	Note: This parameter is only shown if Alibi Memory is On .

Alibi Memory Print Pos 4

Not in use	Specifies the information that should be stored in printer position 4 (lower right field). This parameter controls storing in Alibi file.
Displayed Weight	
Preset Tare	Not in use: Printer position 4 is left empty. If both 'Print Position 3' and 'Print Position 4' are set to 'Not in use' the lower line is not stored.
Date/Time	
Scale Name	
Instrument Name	Display Weight: The displayed weight is stored including the text Gross/Net and the unit.
< Not in use >	Preset Tare: The value of the preset tare is stored. Date/Time: The date and time is stored. Scale Name: The scale name is stored. Instrument Name: The instrument name is stored.
	Note: This parameter is only shown if Alibi Memory is On .

Range/Alternatives <default value>	Explanation and result of alternatives.
---------------------------------------	--

Alibi Memory Linefeeds

0	Specifies the number of linefeeds (empty lines) that should be stored after each data printout.
1	
2	
3	Note that if all four print positions above are set to 'Not in use' no data is stored and no linefeeds will be stored.
4	
5	Note: This parameter is only shown if Alibi Memory is On .
6	
7	
8	
9	
10	
<0>	

Range/Alternatives <default value>	Explanation and result of alternatives.
---------------------------------------	--

Menu Hardware config.

Fieldbus

Not In Use	This parameter defines what type of fieldbus that will be used in the CPU.
Profibus	
DeviceNet	Not In Use: The fieldbus is not used regardless of any installed module.
ControlNet	
<Not In Use>	Profibus: A ProfibusDP type of fieldbus module is used. DeviceNet: A DeviceNet type of fieldbus module is used. ControlNet: A ControlNet module is used.

Menu Calibration Parameters

Scale Name

<>	A 15-character string that is used at printing in reports and so on.
----	--

Measurement Unit

NONE	Defines the engineering unit that should be used for the measured value and for related set-up parameters.
g	
kg	
t	
lb	
oz	
N	
daN	
kN	
psi	
kPa	
MPa	
bar	
lbf	
kgf	
Nm	
N/m	
kN/m	
PLI	
l	
mV/V	
pls	
<kg>	

Range/Alternatives <default value>	Explanation and result of alternatives.
Resolution	
0.001	<p>Defines the decimal point position and resolution format for the displayed value. All set-up parameters using the measurement unit will be written with the decimal point position selected in this menu.</p> <p>If the last digits of the weight value are not stable, a more coarse resolution can be selected to get a stable reading.</p>
0.002	
0.005	
0.01	
0.02	
0.05	
0.1	
0.2	
0.5	
1	
2	
5	
10	
20	
50	
<0.1>	
Capacity	
Range:	Nominal range of scale.
0.5 to 999999	Capacity / Resolution = Number of divisions.
Unit:	
Measurem. unit	
<500>	
Bandwidth	
0.125 Hz	<p>Defines the low pass bandwidth (-3 dB point) for the scale.</p>
0.25 Hz	
0.50 Hz	
1 Hz	
2 Hz	
4 Hz	
8 Hz	
15 Hz	
30 Hz	
50 Hz	
<50 Hz>	
Filter Window	
Range:	The instrument produces unfiltered and filtered weight internally.
0 to 999999	If the difference between the filtered an unfiltered weight is less than 'Filter window' the filtered weight is used.
Unit:	
Measurem. unit	This parameter value has one decimal more than parameter
<10 * Resolution>	Resolution, to allow 'Filter window' to be smaller than the resolution.

Range/Alternatives <default value>	Explanation and result of alternatives.
Motion Detect Window	
Range: 0 to 999999	Motion status is 'on' when the weight value is not stable. It goes off when the weight has been stable for the 'No motion delay time'.
Unit:	
Measurem. unit <1 * Resolution>	
No Motion Delay	
Range: 0 to 10.0	Delay in seconds from detection of stable weight until the Motion status goes off.
Unit: s	
<1.0>	
Motion Check	
Off	Off: Only zero adjustment is inhibited during motion. On: Inhibits zero adjustment, taring, and printing during motion.
On	
<Off>	
Min. Weight Print	
Range: 0 to 999999	Defines the smallest allowed weight value to be printed. 0 gives no restrictions.
Unit:	
Measurem. unit <0.0>	
Overload Check	
Off	Check of overload is performed according to this set-up. Off: No check is performed. Weight will be reported up to the limits of the AD converter. Unipolar: Overload status will be set if 'Overload limit' is exceeded. Underload status will be set if the gross weight is below minus (-) 9 * Resolution. Bipolar: Overload status will be set if Overload limit is exceeded. Underload status will be set if the gross weight is below minus (-) Overload limit.
Unipolar	
Bipolar	
<Off>	
Overload Limit	
Range: 0.5 to 999999	Should be set to the max gross weight that the weight indicator is allowed to report. This parameter is always set to default value when changing Resolution or Capacity. If 'Bipolar' overload check is selected the weight will be reported up to the Overload limit and down to the minus (-) Overload limit. Note: this parameter is only shown if parameter '1: Overload Check' is set to 'Unipolar' or 'Bipolar'.
Unit:	
Measurem. unit <Capacity + 9 * Resolution>	

Range/Alternatives <default value>	Explanation and result of alternatives.
Zero Tracking	
Off	With this parameter automatic zero-tracking can be selected, or a combination of automatic zero-tracking and automatic zero setting. Off: No zero tracking. On: Zero tracking active. On+AutoZero: Zero tracking and auto zeroing active.
On	
On+AutoZero	
<Off>	
Zero-Track.Rate	
Range: 0 to 1500	Maximum weight change speed for zero-tracking to be performed. 'Zero-track.rate' must be less than (30 * Resolution). Unit for the Zero-track rate is: Measurment. unit/min, expressed as ' /min' to save space. Note: this parameter is only shown if parameter '1: Zero tracking' is set to 'On' or 'On+AutoZero'.
Unit: /min	
<1>	
Tare Corr.Mode	
Auto	The tare value can be calculated in three different ways: Net weight = Gross weight – Tare value Auto: Auto tare value is used. Preset: Tare value is entered through the serial communication or keypad. Auto+preset: Tare value is the sum of the preset tare value and auto tare value.
Preset	
Auto+Preset	
<Auto>	

Range/Alternatives <default value>	Explanation and result of alternatives.
---------------------------------------	--

Menu Calibration

Calibration Type

Data Sheet	<p>Defines the type of calibration to be performed. A new calibration is initiated as a 'Calibration type' is selected.</p> <p>Data Sheet: <i>Data sheet calibration is easy to use and doesn't demand any reference equipment, except data from the transducer data sheets.</i></p> <p>Deadweight: <i>Deadweight calibration is normally the most accurate calibration type. It requires known weights to at least 2/3 of the wanted measuring range.</i></p> <p>Table: <i>Table calibration is used to enter recorded values from a previous calibration into a replacement instrument.</i></p>
Deadweight	
Table	
<Data Sheet>	

Data sheet calibration related parameters

Conversion Factor

Range: 0.01 to 100 <9.80665>	Defines the relationship between a measured value expressed in data sheet unit and expressed in the selected measurement unit.
------------------------------------	--

Number of Transducers

Range: 1 to 4 <3>	Defines the number of transducers and fixed support points in the scale installation. All transducers must have equal rated load. If the total number is over 4: enter 1 here!
-------------------------	--

Rated Load

Range: 1 to 999999	<p>Defines the rated load for one transducer, expressed in the data sheet unit. The value is specified in the transducer data sheet.</p> <p>NOTE! If the data sheet value is 5 kN, the parameter should be set to 5000 (N).</p> <p>If the total number of transducers and fixed supports is over 4: multiply that number with the rated load for one transducer and enter the result here!</p>
Unit: Data sheet unit	
<2000.00>	

Range/Alternatives <default value>	Explanation and result of alternatives.
Rated Output 1	
Range: 0 to 9.99999 Unit: mV/V <2.03900>	Defines the rated output signal for transducer 1. The value is specified in the transducer data sheet for transducer 1. If the total number of transducers and fixed supports is over 4: add up all rated output values, divide by the <u>number of transducers</u> , and enter the result here!
Rated Output 2	
Range: 0 to 9.99999 Unit: mV/V <2.03900>	Defines the rated output signal for transducer 2. The value is specified in the transducer data sheet for transducer 2.
Rated Output 3	
Range: 0 to 9.99999 Unit: mV/V <2.03900>	Defines the rated output signal for transducer 3. The value is specified in the transducer data sheet for transducer 3.
Rated Output 4	
Range: 0 to 9.99999 Unit: mV/V <2.03900>	Defines the rated output signal for transducer 4. The value is specified in the transducer data sheet for transducer 4.
Set Zero	
Range: +/-999999 Unit: Measurem. unit <'Live'>	Live weight is displayed at the bottom of the screen. Enter wanted value for the actual load, usually '0', i.e. unloaded scale. NOTE! This parameter should be used for zeroing of the instrument.
Zero Offset	
Range: +/-999999 Unit: Measurem. unit <0>	This menu shows the offset value acquired by zeroing in 'Set zero'. If this parameter is edited, the zeroing will be influenced.

Range/Alternatives <default value>	Explanation and result of alternatives.
---------------------------------------	--

Deadweight calibration related parameters

Used when the scale is calibrated with weights. The instrument automatically reads the corresponding transducer signals.

No of Calibration Points

Range: Number of calibration points.
2 to 6
<2>

Value Cal. P1

Range: +/-999999 This parameter defines the load on the scale in the lowest
Unit: calibration point, normally 0.
Measurem. unit
<0>

Value Cal. P2

Range: +/-999999 This parameter defines the load on the scale in the second
Unit: calibration point.
Measurem. unit
<500>

Value Cal. P3

Range: +/-999999 This parameter defines the load on the scale in the third
Unit: calibration point.
Measurem. unit
<0>

Value Cal. P4

Range: +/-999999 This parameter defines the load on the scale in the fourth
Unit: calibration point.
Measurem. unit
<0>

Value Cal. P5

Range: +/-999999 This parameter defines the load on the scale in the fifth
Unit: calibration point.
Measurem. unit
<0>

Value Cal. P6

Range: +/-999999 This parameter defines the load on the scale in the sixth
Unit: calibration point.
Measurem. unit
<0>

Range/Alternatives <default value>	Explanation and result of alternatives.
---------------------------------------	--

Transd. Signal P1

Range: +/-9.99999
Unit: mV/V
<0.00000>

In this parameter, the transducer signal in the lowest calibration point is displayed, but the value cannot be edited.

Transd. Signal P2

Range: +/-9.99999
Unit: mV/V
<1.66631>

In this parameter, the transducer signal in the second calibration point is displayed, but the value cannot be edited.

Transd. Signal P3

Range: +/-9.99999
Unit: mV/V
<2.03900>

In this parameter, the transducer signal in the third calibration point is displayed, but the value cannot be edited.

Transd. Signal P4

Range: +/-9.99999
Unit: mV/V
<2.03900>

In this parameter, the transducer signal in the fourth calibration point is displayed, but the value cannot be edited.

Transd. Signal P5

Range: +/-9.99999
Unit: mV/V
<2.03900>

In this parameter, the transducer signal in the fifth calibration point is displayed, but the value cannot be edited.

Transd. Signal P6

Range: +/-9.99999
Unit: mV/V
<2.03900>

In this parameter, the transducer signal in the sixth calibration point is displayed, but the value cannot be edited.

Set Zero

See 'Set zero' in section 'Data sheet calibration related parameters' for explanation of the parameter.

Zero Offset

See 'Zero offset' in section 'Data sheet calibration related parameters' for explanation of the parameter.

Range/Alternatives <default value>	Explanation and result of alternatives.
---------------------------------------	--

Table calibration related parameters

Used when the scale is calibrated with recorded values from a previous calibration, normally a deadweight calibration.

No of Calibration Points

Range: Number of calibration points.
2 to 6
<2>

Value Cal. P1

Range: +/-999999 In this parameter, enter the recorded value for the load in the
Unit: first calibration point.
Measurem. unit
<0>

Value Cal. P2

Range: +/-999999 In this parameter, enter the recorded value for the load in the
Unit: second calibration point.
Measurem. unit
<500>

Value Cal. P3

Range: +/-999999 In this parameter, enter the recorded value for the load in the
Unit: third calibration point.
Measurem. unit
<0>

Value Cal. P4

Range: +/-999999 In this parameter, enter the recorded value for the load in the
Unit: fourth calibration point.
Measurem. unit
<0>

Value Cal. P5

Range: +/-999999 In this parameter, enter the recorded value for the load in the
Unit: fifth calibration point.
Measurem. unit
<0>

Value Cal. P6

Range: +/-999999 In this parameter, enter the recorded value for the load in the
Unit: sixth calibration point.
Measurem. unit
<0>

Range/Alternatives <default value>	Explanation and result of alternatives.
Transd. Signal P1 Range: +/-9.99999 Unit: mV/V <0.00000>	In this parameter, enter the recorded value for the transducer signal in the first calibration point.
Transd. Signal P2 Range: +/-9.99999 Unit: mV/V <1.66631>	In this parameter, enter the recorded value for the transducer signal in the second calibration point.
Transd. Signal P3 Range: +/-9.99999 Unit: mV/V <2.03900>	In this parameter, enter the recorded value for the transducer signal in the third calibration point.
Transd. Signal P4 Range: +/-9.99999 Unit: mV/V <2.03900>	In this parameter, enter the recorded value for the transducer signal in the fourth calibration point.
Transd. Signal P5 Range: +/-9.99999 Unit: mV/V <2.03900>	In this parameter, enter the recorded value for the transducer signal in the fifth calibration point.
Transd. Signal P6 Range: +/-9.99999 Unit: mV/V <2.03900>	In this parameter, enter the recorded value for the transducer signal in the sixth calibration point.
Set Zero	See 'Set zero' in section 'Data sheet calibration related parameters' for explanation of the parameter.
Zero Offset	See 'Zero offset ' in section 'Data sheet calibration related parameters' for explanation of the parameter.

Range/Alternatives <default value>	Explanation and result of alternatives.
---------------------------------------	--

Menu Serial Com

Serial Com. Mode

Not in use	Defines use of serial port.
Modbus Slave	Not in use: <i>The port is not used.</i>
Printer	Modbus Slave: <i>The port is used for control unit communication.</i>
External Display	Printer: <i>The port is used for a printer.</i>
<Not in use>	External Display: the serial port is used to handle an external display

Baudrate

300	Defines the baudrate for the serial communication.
600	The parameter must be set to the baudrate of
1200	the external equipment.
2400	Note: This parameter is not shown if 'Not in use' is selected in
4800	'Serial Com. Mode'.
9600	
19200	
38400	
57600	
115200	
<9600>	

Data Format

7-none-2	Defines the bit configuration for the serial communication.
7-even-1	The parameter must be set to the same configuration as for the
7-even-2	external equipment.
7-odd-1	Note: This parameter is not shown if 'Not in use' is selected in
7-odd-2	'Serial Com. Mode'.
8-none-1	
8-none-2	
8-even-1	
8-odd-1	
< 8-none-1 >	

Modbus RTU Address

Range: 1 to 247 <1>	Defines the instrument Modbus address.
------------------------	--

Min Reply Time

Range: 0 to 1000 Unit: ms <0>	Adds a delay before the response to a command is sent. Used if the instrument sends its response too fast for the master. Note: This parameter is only shown if 'Modbus Slave' is selected in 'Serial Com. Mode'.
-------------------------------------	--

Range/Alternatives <default value>	Explanation and result of alternatives.
---------------------------------------	--

Floating Point Format

Modicon Float Float < Modicon Float >	<p>Sets how the Modbus slave should handle floating point values. Modicon Float: <i>Modicon floating point format.</i> Float: <i>IEEE 32 bit floating point format</i></p> <p>See chapter 'Communication' for details on floating point values. Note: This parameter is only shown if 'Modbus Slave' is selected in 'Serial Com. Mode'.</p>
---	--

Print Position 1

Not in use Display Weight Preset Tare Date/Time Scale Name Instrument Name < Display Weight >	<p>Specifies the information that should be printed in printer position 1 (upper left field). This parameter controls weight printing but not batching printouts.</p> <p>Not in use: <i>Printer position 1 is left empty. If both 'Print Position 1' and 'Print Position 2' are set to 'Not in use' the upper line is not printed.</i></p> <p>Display Weight: <i>The displayed weight is printed including the text Gross/Net and the unit.</i></p> <p>Preset Tare: <i>The value of the preset tare is printed.</i></p> <p>Date/Time: <i>The date and time is printed.</i></p> <p>Scale Name: <i>The scale name is printed.</i></p> <p>Instrument Name: <i>The instrument name is printed.</i></p> <p>Note: This parameter is only shown if 'Printer' is selected in 'Serial Com. Mode'.</p>
---	--

Print Position 2

Not in use Display Weight Preset Tare Date/Time Scale Name Instrument Name < Not in use >	<p>Specifies the information that should be printed in printer position 2 (upper right field). This parameter controls weight printing but not batching printouts.</p> <p>Not in use: <i>Printer position 2 is left empty. If both 'Print Position 1' and 'Print Position 2' are set to 'Not in use' the upper line is not printed.</i></p> <p>Display Weight: <i>The displayed weight is printed including the text Gross/Net and the unit.</i></p> <p>Preset Tare: <i>The value of the preset tare is printed.</i></p> <p>Date/Time: <i>The date and time is printed.</i></p> <p>Scale Name: <i>The scale name is printed.</i></p> <p>Instrument Name: <i>The instrument name is printed.</i></p> <p>Note: This parameter is only shown if 'Printer' is selected in 'Serial Com. Mode'.</p>
---	---

Range/Alternatives <default value>	Explanation and result of alternatives.
Print Position 3	
Not in use Display Weight Preset Tare Date/Time Scale Name Instrument Name < Not in use >	<p>Specifies the information that should be printed in printer position 3 (lower left field). This parameter controls weight printing but not batching printouts.</p> <p>Not in use: <i>Printer position 3 is left empty. If both 'Print Position 3' and 'Print Position 4' are set to 'Not in use' the lower line is not printed.</i></p> <p>Display Weight: <i>The displayed weight is printed including the text Gross/Net and the unit.</i></p> <p>Preset Tare: <i>The value of the preset tare is printed.</i></p> <p>Date/Time: <i>The date and time is printed.</i></p> <p>Scale Name: <i>The scale name is printed.</i></p> <p>Instrument Name: <i>The instrument name is printed.</i></p> <p>Note: This parameter is only shown if 'Printer' is selected in 'Serial Com. Mode'.</p>
Print Position 4	
Not in use Display Weight Preset Tare Date/Time Scale Name Instrument Name < Not in use >	<p>Specifies the information that should be printed in printer position 4 (lower right field). This parameter controls weight printing but not batching printouts.</p> <p>Not in use: <i>Printer position 4 is left empty. If both 'Print Position 3' and 'Print Position 4' are set to 'Not in use' the lower line is not printed.</i></p> <p>Display Weight: <i>The displayed weight is printed including the text Gross/Net and the unit.</i></p> <p>Preset Tare: <i>The value of the preset tare is printed.</i></p> <p>Date/Time: <i>The date and time is printed.</i></p> <p>Scale Name: <i>The scale name is printed.</i></p> <p>Instrument Name: <i>The instrument name is printed.</i></p> <p>Note: This parameter is only shown if 'Printer' is selected in 'Serial Com. Mode'.</p>
Linefeeds	
0 1 2 3 4 5 6 7 8 9 10 <0>	<p>Specifies the number of linefeeds (empty lines) that should be output after each printout. This parameter controls weight printing but not batching printouts.</p> <p>Note that if all four print positions above are set to 'Not in use' no printout and no linefeeds will be printed.</p> <p>Note: This parameter is only shown if 'Printer' is selected in 'Serial Com. Mode'.</p>

Range/Alternatives <default value>	Explanation and result of alternatives.
---------------------------------------	--

No of Displays

1	Specifies the no of external displays that are used (connected to the serial port. Only addressable display types may be used if more than one is set.
2	
3	
4	Note: This parameter is only shown if External Display is selected in Serial Com. Mode .
< 1 >	

Ext. Display 1 Type

RD10	Specifies which type of external displays that is used as external display 1.
LONDON 4	<p>RD10: Not addressable type. Only one can be used</p> <p>LONDON 4: 4 digits addressable LONDON type display</p> <p>LONDON 5: 5 digits addressable LONDON type display</p> <p>LONDON 6: 6 digits addressable LONDON type display</p> <p>LONDON 7: 7 digits addressable LONDON type display</p> <p>Note: This parameter is only shown if External Display is selected in Serial Com. Mode.</p>
LONDON 5	
LONDON 6	
LONDON 7	
< RD10 >	

Ext. Display 1 Mode

Net Weight	Defines what data is shown on external display 1.
Gross Weight	Net Weight: The net weight is shown.
Displayed Weight	Gross Weight: The gross weight is shown.
<Displayed Weight>	Display Weight: The gross or net weight is shown.
	Note: This parameter is only shown if External Display is selected in Serial Com. Mode .

Ext. Display 2 Type

For details see **Ext. Display 1 Type**.

Specifies which type of external displays that is used as external display 2.

Note: This parameter is only shown if **External Display** is selected in **Serial Com. Mode** and **No of Displays** is 2 or larger.

Ext. Display 2 Mode

For details see **Ext. Display 1 Mode**.

Defines what data is shown on external display 2.

Note: This parameter is only shown if **External Display** is selected in **Serial Com. Mode** and **No of Displays** is 2 or larger.

Range/Alternatives <default value>	Explanation and result of alternatives.
---------------------------------------	--

Ext. Display 3 Type

For details see **Ext. Display 1 Type**.

Specifies which type of external displays that is used as external display 3.

Note: This parameter is only shown if **External Display** is selected in **Serial Com. Mode** and **No of Displays** is 3 or 4.

Ext. Display 3 Mode

For details see **Ext. Display 1 Mode**.

Defines what data is shown on external display 3.

Note: This parameter is only shown if **External Display** is selected in **Serial Com. Mode** and **No of Displays** is 3 or 4.

Ext. Display 4 Type

For details see **Ext. Display 1 Type**.

Specifies which type of external displays that is used as external display 4.

Note: This parameter is only shown if **External Display** is selected in **Serial Com. Mode** and **No of Displays** is 4.

Ext. Display 4 Mode

For details see **Ext. Display 1 Mode**.

Defines what data is shown on external display 4.

Note: This parameter is only shown if **External Display** is selected in **Serial Com. Mode** and **No of Displays** is 4.

Menu 'Modbus TCP Slave'**Modbus TCP Slave**

On	Enables/disables the Modbus TCP Slave.
Off	On: <i>Modbus TCP Slave enabled.</i>
<Off>	Off: <i>Modbus TCP Slave disabled.</i>

Floating Point Format

Modicon	Sets how the Modbus TCP Slave should handle floating point values.
IEEE	Modicon: <i>Modicon floating point format.</i>
< IEEE >	IEEE: <i>IEEE 32 bit floating point format.</i>

See chapter 'Communication' for details on floating point values.

Note: This parameter is not shown if parameter 'Modbus TCP Slave' is set to 'Off'.

Range/Alternatives <default value>	Explanation and result of alternatives.
---------------------------------------	--

Menu Fieldbus

Note: The Fieldbus menu is not shown if parameter **Fieldbus** (in **Hardware Config** menu) is set to **Not In Use**. See chapter **Communication – Fieldbus interface** for more details on fieldbus configuration and usage.

Profibus, Address

Range 1 - 125 < 126 >	Profibus address setting. Note: This parameter is only shown if parameter 'Fieldbus' (in Hardware Config menu) is set to 'Profibus'.
--------------------------	---

DeviceNet, Address

Range 0 - 63 < 63 >	DeviceNet address setting Note: This parameter is only shown if parameter 'Fieldbus' (in Hardware Config menu) is set to 'DeviceNet'.
------------------------	--

ControlNet, Address

Range 1 - 99 < 99 >	ControlNet address setting Note: This parameter is only shown if parameter 'Fieldbus' (in Hardware Config menu) is set to 'ControlNet'.
------------------------	--

DeviceNet, Baudrate

125 kbps 250 kbps 500 kbps Auto < Auto >	Sets the baudrate for a DeviceNet type of module. Must be selected to suite the master. 125 kbps: Fixed baudrate 125 kbits/s. 250 kbps: Fixed baudrate 250 kbits/s. 500 kbps: Fixed baudrate 500 kbits/s. Auto: Auto setting 125 – 500 kbits/s. Note: This parameter is only shown if parameter 'Fieldbus' (in Hardware Config menu) is set to 'DeviceNet'.
--	--

Floating Point Format

Floating Point Integer < Floating Point >	Sets how the Modbus TCP Slave should handle floating point values. Floating Point: IEEE 32 bit floating point format. Integer: 32 bit integer format. Note: This parameter is not shown if parameter 'Modbus TCP Slave' is set to 'Off'.
---	---

Range/Alternatives <default value>	Explanation and result of alternatives.
---------------------------------------	--

Menus Level Supervision

NOTE: There are 4 levels each with the following four parameters described below.

Level 1 Source (- Level 4 Source)

Not in use	Defines the signal to be supervised by the level.
Net Weight	Not in use: The level is not used, any outputs set to work with this level will be off.
Gross Weight	Net Weight: The level operates on the net weight.
Display Weight	Gross Weight: The level operates on the gross weight
Abs.Net Weight	Display Weight: The level operates on displayed weight.
Abs.Gross Weight	Abs.: Stands for Absolute, the level operates on the absolute
Abs.Disp.Weight	value of net weight, gross weight or displayed weight.
< Not in use >	

Level 1 Output (- Level 4 Output)

Active Above	This parameter defines the conditions for control of a possible
Active Below	used output.
< Active Above >	Active Above: The used output is activated as the supervised signal level is above the set level. Active Below: The used output is activated as the supervised signal level is below the set level.
	Note: This parameter is only shown if 'Level 1 Source' is not set to 'Not in use'.

Level 1 Hystereses (- Level 4 Hystereses)

Range:	Defines the hystereses range for the level.
+/-999999	Positive value gives a hystereses range above the switch level,
Unit:	negative value gives a range below the switch level.
Measur. unit	Note: This parameter is only shown if 'Level 1 Source' is not set
< 0.2 >	to 'Not in use'.

Menu 'Setpoints'

NOTE: There are 4 setpoints each with the source parameters described below.

Setpoint 1 Source (- Setpoint 4 Source)

Not in use	Defines the signal to be supervised by the setpoint.
Net Weight	Not in use: The setpoint is not used, any outputs set to work with this setpoint will be off.
Gross Weight	Net Weight: The Setpoint operates on the net weight.
Display Weight	Gross Weight: The Setpoint operates on the gross weight
Abs.Net Weight	Display Weight: The Setpoint operates on displayed weight.
Abs.Gross Weight	Abs.: Stands for Absolute, the Setpoint operates on
Abs.Disp.Weight	the absolute value of net weight, gross weight or displayed
< Not in use >	weight

Range/Alternatives <default value>	Explanation and result of alternatives.
---------------------------------------	--

Menus Digital Inputs

NOTE: There are 4 digital inputs each with the parameter described below.

Digital Input 1 Use (- Input 4 Use)

Not in use	Defines the use of the internal digital inputs in the instrument.
Tare	Not in use: The input is not used.
Gross/Net	Tare: Input used for taring command.
Gross	Gross/Net: Input used for gross/net toggling.
Net	Gross: Input used to switch to gross mode.
Zero	Net: Input used to switch to net mode.
Weight	Zero: Input used for zero command.
Print	Weight: Input used to switch to weight mode.
< Not in use >	Print: Input used for print command.

Menus Digital Outputs

NOTE: There are 4 digital outputs each with the parameter described below.

Output 1 Source (- Output 4 Source)

Not in use	Defines the use of the internal digital outputs in the instrument.
Remote	Not in use: The output is not used.
In Process	Remote: The output can be controlled via Modbus
Level 1	In Process: Active output means active 'In process'.
Level 2	Level 1 – Level 4: Output activated by the Level.
Level 3	Setpoint 1 – Setpoint 4: Output activated by the Setpoint.
Level 4	Net Mode: Output active in net mode.
Setpoint 1	Good Zero: Output active by 'good zero'.
Setpoint 2	Stable Weight: Output active by stable weight.
Setpoint 3	
Setpoint 4	
Net Mode	
Good Zero	
Stable Weight	
< Remote >	

Range/Alternatives <default value>	Explanation and result of alternatives.
---------------------------------------	--

Menu Analog Outputs

Analog Out Source

Not in use	Defines the value to represent on analog output.
Gross Weight	Not in use: <i>The analog output is not used.</i>
Net Weight	Gross Weight: <i>The output represents gross weight.</i>
Disp. Weight	Net Weight: <i>The output represents net weight.</i>
Remote	Disp. Weight: <i>The output represents displayed weight</i>
< Remote >	Remote: <i>The analog output value is controlled via Modbus.</i>

Analog Out Type

+/- 20 mA	Defines the type of signal, used to represent the weight at this Analog output.
-12 – 20 mA	
0-20 mA	+/-20mA, -12 - 20mA: <i>bipolar current output.</i>
4-20 mA	0-20mA, 4-20mA: <i>monopolar current output.</i>
+/-10 V	+/-10V: <i>bipolar voltage output.</i>
0-10 V	0-10V: <i>monopolar voltage output.</i>
<4-20 mA>	Note: this parameter is not shown if parameter Analog Out Source is Not in use . Note that in most cases some over range is available. +/-20 mA and -12 – 20 mA ranges are limited at -22 and +22 mA. 4 -20 mA range is limited at +4 and +22 mA. 0 -20 mA is limited at 0 and +22 mA. +/-10 V is limited at -11 and +11V. 0–10 V is limited at 0 and +11V.

Analog Out Range Low

Range:	Defines the weight that should give the lowest output (0 V / 0 mA / 4 mA) at this Analog output.
+/-999999	
Unit:	Note: this parameter is not shown if parameter Analog Out Source is Not in use or Remote .
Measur. unit or flow unit	
<0>	

Analog Out Range High

Range:	Defines the weight that should give the highest output (10 V / 20 mA) at this Analog output.
+/-999999	
Unit:	Note: this parameter is not shown if parameter Analog Out Source is Not in use or Remote .
Measur. unit or flow unit	
<500>	

Range/Alternatives <default value>	Explanation and result of alternatives.
---------------------------------------	--

Analog Out filter

On	Limits the analog output bandwidth to approximately 0.4 Hz if
Off	On. Analog output is always limited to the bandwidth set for the
<Off>	scale. This filter can be used in addition to the scale filter when extra filtration on the analog output is needed. Note: this parameter is not shown if parameter Analog Out Source is Not in use .

Analog Out Low Adjust

Range: +/-2.000	Gives a possibility to adjust the offset of the analog output. This
Unit: %	allows for the reading of an external instrument connected to the
<0.000>	analog output to be fine-tuned. Full adjustment range corresponds to approximately +/-2% of maximum analog output. The parameter value will be set to zero each time Analog Out Type is changed. Note: this parameter is not shown if parameter Analog Out Source is Not in use .

Analog Out High Adjust

Range: +/-2.000	Gives a possibility to adjust the gain of the analog output signal.
Unit: %	This allows for the reading of an external instrument connected
<0.000>	to the analog output to be fine-tuned. Full adjustment range corresponds to approximately +/-2% of maximum analog output. The parameter value will be set to zero each time Analog Out Type is changed. Note: this parameter is not shown if parameter Analog Out Source is Not in use .

4. Calibration

General

When measuring with G5 Instrument, the transducer output signal, corresponding to the transducer load, is converted to a weight value. The conversion is controlled by several parameters with values defined during calibration of the instrument.

Some calibration types for the instrument can be performed without any transducers connected.

The G5 Instrument supports three calibration types:

- **Data sheet calibration** - entry of values from transducer data sheet(s).
- **Table calibration** - entry of recorded values from a previous calibration.
- **Deadweight calibration** - storing of measured transducer signals for known weights.

Calibration can only be performed in menu:

'Parameter set-up/Calibration.'

A 'Set-up code' may be demanded. Note that the weighing result for the calibrated scale may be temporarily incorrect during calibration.

Calibration starts as one calibration type is selected.

To ensure the best possible weighing results, the mechanical installation must be carried out with great care. Fixed mechanical connections to the scale should be avoided, or made as flexible as possible and perpendicular to the measuring direction. If the scale has several transducers connected in parallel, they must have the same rated load and impedance. If transducers and fixed supports are combined, the load must be evenly distributed on all supports.

It is recommended to start with a data sheet calibration, which is easy to perform and gives a fairly good accuracy so the installation can be tested.

DATA AND CALIBRATION SHEET				ArtNo: 1130480	
LOAD CELL	KIS-3	S/N 322471			
RATED LOAD (R.L.)	10 kN	!	EXCITATION VOLTAGE, RECOMMENDED		10 V AC OR DC
		!	EXCITATION VOLTAGE, MAXIMUM		18 V AC OR DC
OVERLOAD, SAFE	100 % R.L.	!			
OVERLOAD, ULTIMATE	200 % R.L.	!	INPUT RESISTANCE 350 +/- 3 OHMS INCL. STANDARD CABLE		
		!	OUTPUT RESISTANCE 350.1 OHMS INCL. STANDARD CABLE		
SIDE LOAD, SAFE	100 % R.L.	!			
SIDE LOAD, ULTIMATE	200 % R.L.	!	TEMPERATURE RANGE		-40 TO +80 DEGREES C
ELECTRICAL CONNECTION	SHIELDED 4-CONDUCTOR CABLE	!	TEMPERATURE EFFECT (-10 TO +50 DEGREES C)		
EXCITATION POSITIVE:	RED	!			
EXCITATION NEGATIVE:	BLACK	!	ON OUTPUT	0.001	% OF OUTPUT PER DEG. C
SIGNAL POSITIVE:	GREEN	!			
SIGNAL NEGATIVE:	WHITE	!	ON ZERO BALANCE	0.001	% OF R.O. PER DEG. C

RATED OUTPUT (R.O.) (TOLERANCE 0.1 %)			2.0394 mV/V		
NONLINEARITY (BEST FIT THROUGH ZERO)		+/-	0.010 % R.O.		
ZERO BALANCE			+0.0 % R.O.		
CREEP 5 MINUTES			+0.001 % R.O.		
CALIBRATION VALUES (TOLERANCE 0.1 %) SHUNT RESISTOR CONNECTED BETWEEN 'EXCITATION NEGATIVE' AND 'SIGNAL NEGATIVE'					
40 KOHMS CORRESPOND TO			9.9111 kN		
80 KOHMS CORRESPOND TO			4.9683 kN		
THE VALUES INDICATED FOR OUTPUT VOLTAGE AND CALIBRATION VALUES ARE APPLICABLE AT OPEN CIRCUIT WITHOUT EXTERNAL BALANCING RESISTORS AND WITH A CONNECTING CABLE OF STANDARD LENGTH.					
Vishay Nobel AB S-691 27 KARLSKOGA			KARLSKOGA 03-04-30 		

Each transducer from BLH Nobel is delivered with a detailed data and calibration sheet.

If the weight indicator must be replaced, a table calibration of the replacement unit can be performed, with recorded values from an earlier calibration.

To get the best accuracy, a deadweight calibration with known weights to at least 2/3 of the measuring capacity, should be performed.

All calibration parameters are found in the menus under 'Calibration Parameters' and 'Calibration'. The parameters are described in chapter 'Set-up'.

Actual gross weight and transducer signal is displayed when in menu "Calibration Parameters' and 'Calibration'.

Common parameters

For all calibration types, measurement unit and resolution for the weight value, and the capacity for the scale must be specified. These parameters, among others, are found in menu 'Calibration Parameters', see chapter 'Set-up'. This section deals only with the calibration parameters.

Measurement unit

This parameter defines the engineering unit used for the weight value.

The same engineering unit will also be used for example in the parameter values 'Resolution', 'Capacity', 'Level', and 'Setpoint'.

Resolution

This parameter defines decimal point position and resolution in weight display.

The decimal point position selected here will be used in setting up, in the displayed weight value and in the weight value sent to a printer or computer.

Resolution is understood to mean the smallest weight change presented.

Capacity

This parameter defines the nominal range of the scale. This is the capacity of the scale and should be set to the maximum weight with which the scale is to be loaded. Even if the scale (transducers) have larger capacity, this value should nevertheless be set so that the weighing vessel does not become over full if the scale is loaded up to this value. This parameter is used to calculate certain default values in the set-up and in checking the maximum zero value (with ZERO key and zero-tracking).

Number of scale divisions

The number of scale divisions (div.) for a scale = 'Capacity' / 'Resolution'. To get correct and stable weight display, parameter 'Resolution' should be set so that the number of scale divisions with the selected 'Capacity' is less than 6 000 (10 000).

The number of scale divisions is also limited by the performance of the transducers and by how large a portion of the transducer capacity that is actually utilized.

To ensure a stable weight display, the input signal to the instrument should exceed 0.2 μV / scale division.

Example:

- Three transducers, each of 20 000 N (2 039 kg), are to support a tank which, without contents, weighs 3 500 kg. The amount of material in the tank varies from 0 – 600 kg.
 - Transducer capacity = 6 118 kg
(3 x 20 000 N / 9.80665).
 - Transducer sensitivity = 2.039 mV/V.
 - Supply voltage to transducers = 9.21 V. (Excitation with 3 x 350 ohm load cells)
 - Signal from transducers at full load (6 118 kg) = 18.78 mV
(2.039 mV/V x 9.21 V).
 - Signal change in response to an applied load of 600 kg = 1.84 mV
(18.78 mV x 600 / 6 118).
 - Set 'Capacity' to 600 kg.
 1. Set 'Resolution' to 0.1.
Number of scale divisions = 600 / 0.05 = 12 000
Signal/scale division = 1.84 mV / 12 000 div. = 0.15 $\mu\text{V}/\text{div}$.
 2. Set 'Resolution' to 0.2.
Number of scale divisions = 600 / 0.1 = 6 000
Signal/scale division = 1.84 mV / 6 000 div. = 0.31 $\mu\text{V}/\text{div}$.
- It is best to select Case 2, since both the number of scale divisions and signal/div. is on the borderline in Case 1. In some special cases the resolution may obviously be driven higher, but the transducer characteristics must always be observed.

The filter band width is always of importance to get good weighing results. Lower band width gives slower response but more stable readings.

Data sheet calibration

Data sheet calibration is recommended as first-time calibration for a new installation. In data sheet calibration, values from the transducer data sheets are entered as parameter values, the scale need not be loaded and an accuracy of 0.1 % can be obtained. The accuracy of the G5 Instrument itself is 0.005 % (1-2 years calibration period). It is essential that no external forces influence the scale installation. If fixed support points are included in the scale, the load must be evenly distributed on transducers and fixed supports.

Conversion factor

In transducer data sheets, loads are normally not expressed in the measurement unit, selected for the scale. This parameter defines a constant by which a weight value, expressed in the measurement unit, should be multiplied to be expressed in the data sheet unit.

When using a transducer, calibrated in Newton, in a scale displaying weight values in kg, the 'Conv. factor' shall be the local gravitation constant in m/s^2 .

The default value, 9.80665, is an international mean value for the gravitation constant (world-wide range 9.78 – 9.83).

If the data sheet unit is the same as the measurement unit, the conversion factor parameter should be set to 1.0000.

Number of transducers

In weighing applications the load on the scale may be supported by several transducers or fixed supports. This parameter defines the total number of transducers and fixed supports in the scale, up to maximum 4.

If the scale has more than 4 support points, this parameter should be set to '1' and the parameter value for 'Rated load' and 'Rated output' must be calculated.

Rated load

Rated load for a transducer is indicated in the data sheet and should be entered as a parameter value, expressed in the unit of the data sheet.

NOTE! If the data sheet value is 5 kN, this parameter should be set to 5000 (N).

If several transducers are used in a scale, they must all have the same rated load.

If the scale has more than 4 support points, 'Number of transd' should be set to '1' and the value of this parameter should be calculated as:

rated load for one transducer, multiplied by the total number of support points.

Rated Output 1 (2, 3, 4)

Rated output is given in the data sheet for every transducer. Parameters will be available for the number of support points specified in 'Number of transd'.

For fixed support points the rated output value is 0.00000 (mV/V).

If the scale has more than 4 support points, 'Number of transd' should be set to '1' and the parameter value for 'Rated output 1' should be calculated as:

the mean value of rated output for all active transducers.

Set zero

Set zero is useful only when the scale installation is finished. By the digit keys this value can be set to zero, for unloaded scale, or to the weight of the known load, for a scale that is loaded.

Zero offset

For an installed scale this parameter shows the zero offset after zeroing, a value that should not be edited.

For a scale that is not installed it is possible to enter the known weight of fixed equipment on the scale.

Table calibration

Table calibration can be used to copy recorded values from a previous deadweight calibration of the weighing equipment into a replacement instrument. This is performed by entry of recorded weight values and corresponding transducer signal values into the instrument. Calibration can be performed for up to 6 points.

The accuracy of the copying procedure is 0.005 %.

No of Calibration Points

Only parameters for the selected number of calibration points will be displayed in the menu. The number of calibration points can be changed during the calibration.

Value Cal. P1, Value Cal. P2 etc.

These parameters are used for entry of recorded weight values, expressed in the measurement unit, from a previous deadweight calibration.

Transd.Signal P1, Transd.Signal P2 etc.

These parameters are used for entry of recorded transducer signal values for corresponding calibration points.

Set Zero

Set zero is useful only when the scale installation is finished. By the digit keys this value can be set to zero, for unloaded scale, or to the weight of the known load, for a scale that is loaded.

Zero Offset

This parameter is used for entry of the recorded zero offset value from a previous deadweight calibration.

If a zeroing has been performed with parameter 'Set zero' above, the value of parameter 'Zero offset' need not be changed.

Deadweight calibration

This is normally the most accurate calibration type. The transducer signals are measured and automatically stored when the scale is loaded with known weights. Calibration can be performed in up to six calibration points, starting with the lowest, the highest point, or any other order.

Calibration of the lowest point is normally performed with the scale unloaded.

If calibration in two points is used, the second point should be placed as high as possible. The scale should be loaded with at least 2/3 of the 'Capacity'.

By calibration in more than two points, the highest calibration point should be placed at, or higher than, the highest load for which the scale is to be used, and the calibration points should be evenly distributed in the measuring range.

No of Calibration Points

This parameter defines the number of calibration points. Up to six points can be selected, and parameters for load value and transducer signal will be displayed only for the selected number of points.

It is possible to change the number of points during the calibration.

Value Cal. P1,

This parameter defines the load for the lowest calibration point. Normally the scale should be unloaded and the parameter value set to 0 (zero). This weight value and the corresponding transducer signal value are automatically stored in the instrument.

Value Cal. P2, Value Cal. P3 etc.

The scale should be loaded with known weights. These parameters show the load according to the previous calibration and the parameter values should be changed to the value of the known weights. As a parameter value is stored, the instrument will also store the corresponding transducer signal value for that calibration point.

Transd. Signal P1, Transd. Signal P2 etc.

These parameters contain the automatically stored transducer signal values for the calibration points. The values cannot be edited.

Set Zero

Set zero is useful only when the scale installation is finished. By the digit keys this value can be set to zero, for unloaded scale, or to the weight of the known load, for a scale that is loaded.

Zero Offset

For an installed scale this parameter shows the zero offset after zeroing, a value that should not be edited.

Calibration indication

When a new deadweight calibration is started dual arrows will be shown at the value of 'Value Cal. P1', 'Value Cal. P2' etc. This indicates that this value is not entered. The dual arrows will disappear when the user has entered a value. If the user leaves the calibration menu, i.e. calibration is interrupted. The remaining arrows will be removed. It will still be possible to continue the calibration later on but without any calibration indications (arrows).

Note that as long as there are arrows visible it will not be possible to edit the 'Set Zero' or 'Zero Offset' parameters. First must the deadweight calibration be finished (no arrows visible) then should the zero be set.

5. Operation

General

G5 instrument with strain gauge transducers is designed mainly for weighing and batching purposes. The measurement values are displayed at the front panel, and can also be transmitted to a master computer/PLC.

A measurement values can also be presented as an analog output signal.

Some functions in the instrument can be controlled by digital input signals, and digital outputs from the instrument can be used to indicate actual status of instrument, scale, levels and so on.

The instrument is powered by 24 VDC or 110/230 VAC.

Power-up sequence

As the G5 instrument is started it enters the Starting up state.

If any error is detected during power-up, the sequence stops and an error code will be displayed. If the error is not fatal it will be possible to enter the menu system to correct possible set-up errors.

If the detected error is fatal, it will only be possible to select restart. If the fatal error persists please contact your supplier.

If no errors are detected, the instrument can enter normal operation (automatic start-up), displaying actual weight values, possibly together with other instrument information.

If 'Manual start-up' is selected, the instrument enters the 'Wait for start' state, displaying a message 'Waiting for start command. Press START to continue!'. When the operator presses the 'START' button on the screen, the instrument will switch over to normal operation unless a warm up time is set and there is still a remaining warm up time. In this case the 'Warming up' message will be displayed. See below.

If a warm up time has been set the message 'Warming up.' will be displayed together with the remaining time. When the warm up time has expired the instrument will switch over to normal operation automatically.

Status LEDs

There are three LEDs indicating the status of the instrument.

	OFF	ON	FLASHING
GREEN	Power off	Power on	N/A
YELLOW	Normal state, no scale error	N/A	Scale error
RED	Normal state, no instrument error	Fatal instrument error such as corrupt parameters or HW failure.	Parameter set to a value not valid.

Display at normal operation

On the weight display scale weight information is shown.

Dedicated keys on the front panel are used to zero and tare the scale, to toggle between gross and net weight display and to print weighing results.

If a name has been entered in parameter 'Scale Name' it will be shown in the weight display screen. In the example screens below the parameter 'Scale Name' is set to "Baking powder". The display and keyboard only apply to PM models. Remote access using Web Browser is possible for both PM and RM models.

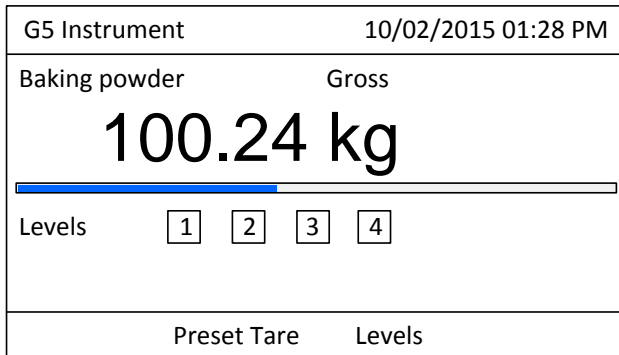

Weight display screen

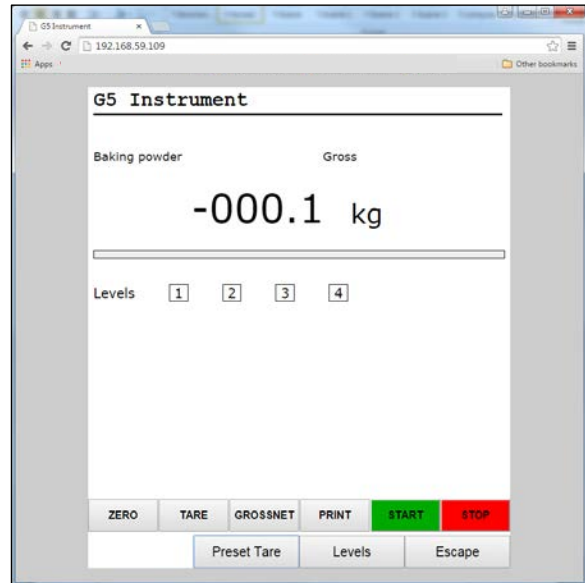

Weight screen on a Web Browser

Functions available using soft keys or clicking on the buttons on the Web Browser page are:

Preset Tare: Showing and setting the (manual) preset tare for the selected scale.

Levels: Setting the level of the level supervisors for the selected scale.

Note that the parameters for the level supervisors, such as source, hysteresis range, and so on are accessed through the 'Parameter Set-up' menu.

If the operator lock is on the user is required to enter the operator lock code before any changes of 'P. Tare' or 'Levels' values can be made.

Security locks

In the G4 instrument two security locks are included to prevent unauthorized access to the instrument via the panel keys. The locks can be activated by parameters in menu 'Main menu/Parameter set-up/General'.

The following requires a login password if the corresponding lock is on.

Changing instrument clock:	Operator lock.
Changing Preset Tare:	Operator lock.
Changing Levels:	Operator lock.
Changing Accumulated Weights	Operator lock.
Changing set-up parameters:	Set-up lock (Operator lock).
Entering/using Backup Menu:	Set-up lock (Operator lock).
Entering/using Restore Menu:	Set-up lock (Operator lock).
Entering/using Default Menu:	Set-up lock (Operator lock).
Entering/using File handling Menu:	Set-up lock (Operator lock).
Changing Network Config:	Set-up lock (Operator lock).

Entering set-up code gives access also to operator locked functions. If only operator lock is on, the operator code is required where set-up lock is specified above.

Unlocking of "P.Tare" and "Levels" editing from the main picture, is valid until you return to the main picture.

Unlocking of any function under the Main Menu is valid until you leave the Main Menu.

There is also a protection from local and remote users both changing parameters. See chapter 'Remote Access' section 'Remote / Local Access' for more information.

Codes for the security locks

When a security lock is activated the operator must enter a four digit code to get access to the protected area. By default the valid code for both locks is '1 9 3 7', but the locks are not activated.

In menu 'Parameter Set-up', sub menu 'General', parameters are available to activate the locks and to change the default code to any four-digit code.

The code for the Operator lock can only open the Operator lock.

The code for the Set-up lock will open both Set-up lock and Operator lock.

Taring

Taring means storing of a tare value and that the G5 instrument switches over to display of net weight. Net weight is equal to gross weight minus tare value.

In the instrument two tare values can be stored, Auto tare and Preset tare.

'Auto' tare value is the actual gross weight, stored as tare value when the TARE key is pressed.

'Preset' tare is a tare value that can be entered only if the instrument is set to use Preset tare. The value of Preset tare can be entered in sub menu 'Preset tare' under the instrument Main menu. Preset tare can also be set in sub menu 'Preset tare' reached with button F2 / 'Preset Tare' directly on the operations menu 'Preset tare' can also be entered from a master unit by communication.

Calibration parameter 'Tare Corr.Mode' defines the use of 'Auto', 'Preset', or the sum 'Auto+Preset' by taring.

- Auto: Only 'Auto tare' is used. 'Preset tare' value cannot be entered or edited.
- Preset: Only 'Preset tare' is used.
- Auto+Preset: The sum of the 'Auto tare' and 'Preset tare' values is used. When the TARE key is pressed, the actual gross weight is stored as Auto tare value and the instrument will display net weight = '– Preset tare'.

With default setting, taring can be performed, even if the weight is not stable. But if parameter 'Motion check' in 'Parameter Set-up / Calibration Parameters' for the scale is set to 'On', taring will be allowed only when the weight value is stable.

If Calibration parameter 'Overload Check' is set to 'Unipolar', taring is not allowed at negative gross weight.

Taring example:

A combination of Preset tare and Auto tare is useful in weighing operations when it is inconvenient or impossible to separate a packing and its contents.

- The packing must be weighed to establish a 'known weight' for it.
- Go to menu 'Calibration Parameters' and set parameter 'Tare Correction Mode' to Auto+Preset.
- Go to menu 'Preset tare' by pressing F2 / 'Preset Tare' button on the screen. Enter the packing weight as the Preset tare value.
- Press the TARE key when the scale is not loaded, or loaded with permanent help equipment only. The Preset tare value will be displayed as negative net weight.
- Put the packing with contents on the scale. The weight of the contents will be displayed as net weight.

Gross/Net operation

At normal operation the G5 instrument presents a numerical weight value at the display, either gross weight or net weight. When net weight is displayed the text 'Net' is shown on screen.

Toggling between display of gross weight and net weight can be performed by pressing the GROSS/NET key. Gross weight is continuously shown in form of a graphic bar on one and two scale displays. Maximum length of the bar corresponds to the set Capacity of the scale.

Net weight is the difference between gross weight and a tare value. For calculation of net weight, the instrument can use either 'Preset' tare, 'Auto' tare, or the sum of them. Net weight cannot be displayed if the tare value in use is zero (0).

Zero setting

A basic zero setting of the gross weight is performed as part of the calibration for the scale. If changes to the weighing equipment are made later a renewed calibration, or at least the zero setting of a calibration, should be performed.

Minor correction of the zero value may be needed and can rapidly be performed:

When a gross weight close to zero is displayed, pressing the ZERO key will make the gross weight zero.

Pressing the ZERO key will also set the value of 'Auto tare' to zero.

Zero setting with the ZERO key is permitted only if:

- The weight is stable (the text 'Motion' not shown), and
- The accumulated zero correction since last calibration is between -1 % and +3 % of the 'Capacity', over and above the zero offset obtained when the instrument was calibrated last time.

The text 'Zero' will be shown on the display when the displayed weight is a 'good zero', meaning that the weight deviates from zero with less than one quarter of the set 'Resolution'.

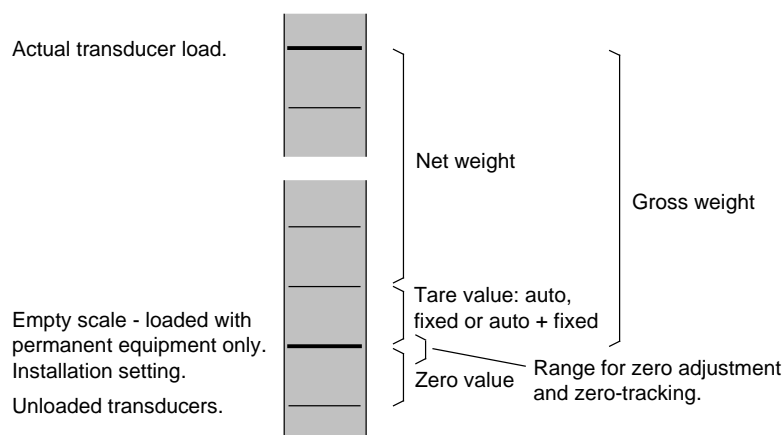

Correlation between gross weight, net weight, and tare value for a scale.

Zero-tracking/Automatic zero setting

In the instrument the functions zero-tracking and automatic zero setting can be enabled. Zero-tracking gives a continuous zero setting by slow changes in zero weight. The automatic zero setting performs zeroing of small negative gross weights. For both functions the following requirements should be met:

- The zero point stays within the permissible range, deviation from calibrated zero less than -1 % to +3 % of Capacity.
- No setpoint function is activated (armed).

Zero-tracking

Zero-tracking is active when, in addition to the common requirements above, the following requirements are met:

- Calibration parameter 'Zero-tracking' is set to On or On+AutoZero.
- The gross weight is 'good zero' (deviation from zero less than one quarter of Resolution).
- The weight is stable (the text Motion not shown).
- The rate of weight change is lower than the 'zero-track.rate', see below.

The set-up parameter 'Zero-track.rate' determines the maximum permissible weight change per minute for the zero-tracking. If parameter 'Resolution' is changed, the value of 'Zero-track rate' will change correspondingly.

Automatic zero setting

Automatic zero setting is active when, in addition to the common requirements above, the following requirements are met:

- Calibration parameter 'Zero-tracking' is set to On+AutoZero.
- The gross weight is negative.
- The scale is in gross mode.
- The weight has been stable (the text Motion not shown) for 5 seconds.

Motion

The text 'Motion' may be shown to the right in the display. Motion condition exists if the weight change during a certain measurement period is greater than the window 'Motion Detect Window'. The measuring period is 100 ms.

After the weight becomes stable, the text 'Motion' will still be shown for a short time, specified in parameter 'No-motion delay', instrument will regard the weight as unstable until the text 'Motion' has disappeared.

When the text 'Motion' is shown, the following activities are affected:

- Zero setting cannot be performed.
- Zero-tracking cannot be performed.
- Taring cannot be obtained (applies if 'Motion check' is 'On').
- Printout of weights is delayed until stable weight is obtained (applies if 'Motion check' is 'On').

Weight printing

General

A printer can be used to print the displayed weight. The printer must be connected to the G5 Instrument serial communication port and the communication parameters must be correctly set. For details on printing function and set-up see chapters 'Communication' and 'Set-up'.

Print command

Printing is commanded manually by pushing the print key on the front panel.

Note that pushing the front panel print button will make the displayed value of gross weight or net weight to be printed.

Print command can be given as a communication print command or by digital input. The digital input must be configured as a print command input.

Print indication

The print indication text 'Print' is shown where 'Zero' or 'Motion' indications normally appear.

The print indication will appear even if no printer is configured and indicates that the weight is accumulated.

10/02/2015 01:28 PM		
Baking powder	Gross	Print
100.24 kg		
<hr/>		
Levels	<input type="checkbox"/> 1	<input type="checkbox"/> 2 <input type="checkbox"/> 3 <input type="checkbox"/> 4
Preset Tare		Levels

Print indication

Print restrictions

The displayed weight value (gross or net weight) in the instrument can be printed out on a connected printer, but on certain conditions:

- The displayed weight must be higher than the value of 'Min. Weight Print' in sub menu 'Calibration Parameter'. No print out will be done if the weight is too low.
- If parameter 'Motion Check' in menu 'Calibration Parameter' is set to 'On', the displayed value must be stable ('Motion' not shown).
If the weight is not stable ('Motion' shown), printing will be delayed and the text 'Print' will be flashing. When the weight has become stable ('Motion' not shown) printing will be performed.

Weight accumulation

The print button and serial communication printing function is also used to accumulate the displayed weight. See also the description of accumulated weights below under Main menu. Accumulation is done even if no printer is set-up or connected.

Character set

The print function is designed to work best with a 40-character printer. Displayed weight can be printed.

The printing functionality in the G5 Instrument uses the multilingual character set known as Microsoft OEM code page 437 (US), MS-DOS code page 437, IBM character set No. 437, etc. Details on this character set can be found e.g. on the Internet.

Setup of printer

- 'Serial Com. Mode':** Set to 'Printer' to activate the printing function in the G5 Instrument.
- 'Baudrate':** As selected on the printer.
- 'Data Format':** As selected on the printer.
- 'Print Position 1':** A print out consists of up to 4 fields with configurable information. Each field is 20 characters long. The fields can be either: 'Not in use', 'Display Weight', 'Preset Tare',
- 'Print Position 2':**
- 'Print Position 3':** 'Date/Time', 'Scale Name' or 'Instrument Name'.
- 'Print Position 4':**

Print Pos. 1	Print Pos. 2
Print Pos. 3	Print Pos. 4

Printer field layout.

If both positions on a row are set to 'Not in use' the row is omitted.

- 'Linefeeds':** After each printout of displayed weight the number of linefeeds defined in this parameter is added.

Print examples

- Print Position 1 = Date/Time Print Position 2 = Scale Name
 Print Position 3 = Not in use Print Position 4 = Display Weight
 Linefeeds = 2
 Scale Name = Ice cream

2014-03-12 17:11	Ice cream	(Gross weight displayed)
	G 037.9 kg	
2014-03-12 19:33	Ice cream	(Net weight displayed)
	N 002.4 kg	

Alibi Memory

The Alibi memory is a complement to the weight printing. It will store configurable printouts similar to what is described above in **Weight printing** section when a print command is given either from the front panel of a PM instrument, via communication or a digital input. The Alibi memory is a file that is stored in the internal file system of the instrument. The file is named Alibi.log and it is read only and cannot be deleted. If this file becomes larger than approximately 1 MB it will be renamed Alibi2.log and a new Alibi.log will be created. An existing Alibi2.log file is overwritten. The user must ensure that the Alibi2.log is moved to an external storage if it has to be kept. The Alibi2.log file can be deleted by the user. Use **Maintenance – File Handling** or an ftp client to handle files in the instrument.

Main Menu

To reach the Main Menu, press the 'Info' button on the instrument front panel. Note that the 'Info' button is only functional from the weight display.

Navigating in a menu is done with arrow keys or by clicking on the desired line if a Web Browser is used.

Main Menu	10/02/2015 01:28 PM
Levels	
Setpoints	
Preset Tare	
Accumulated Weights	
Batched Weights	
Clock Set-up	
Parameter Set-up	
System Information	
Maintenance	
Network Configuration	
Enter	Escape

Main menu.

The instrument Main Menu is opened without interrupting the weighing.

In the Main Menu it is possible to select between the following sub menus:

Levels: Viewing and editing of level value for each configured Level Supervision function. Note that configuration of Level Supervision functionality is done in the 'Parameter Set-up' menu.

Setpoints: Viewing of configured setpoint values. Editing of setpoint value is not possible. Note that configuration of setpoint functionality is done in the 'Parameter Set-up' menu.

Preset Tare: Viewing and editing of preset tares values for scales with tare correction mode set to Preset or Auto + Preset. Set-up of Scale 'Tare Corr. Mode' parameter is done in the 'Parameter Set-up' menu.

Accumulated Weights: This menu shows the accumulated weights for all configured scales. Accumulation of displayed weight (net or gross) takes place when a print command is given either from front panel or via communication. Note that the displayed weight is accumulated.

In the Accumulated Weights menu there is a possibility to zero all values by using the soft key F2 (Zero) or to zero (or edit) one value at a time.

The instrument is capable of storing accumulated weight values up to 10 000 000 000 units with 3 decimals. When the limit is passed 10 000 000 000 will be subtracted from the value.

Clock Set-up: Used to set the instrument clock and date. Time and Date formats are set-up with parameters through 'Parameter set-up' menu.

Parameter Set-up: Access to the G5 instrument parameter set-up menu system. See chapter 'Set-up' for more details on setup.

System Information: Displaying system information for hardware and software in the instrument. Program versions, database version, serial numbers and software versions for all electronic modules can be read here. Info about the Ethernet connection is also available.

Maintenance: Includes a number of functions for maintenance purposes. The available functions are Diagnostics, File Handling, Create Backup, Restore Backup, Set Default Values and Program Upgrade.
See chapter 'Maintenance' for a detailed description of the functions.

Network Configuration: The Network Configuration menu consists of the IP Configuration and the Server Configuration menus. The IP Configuration menu is used to set, manual/auto IP address assignment, IP address etc. The Server Configuration menu is used to enable/disable the FTP Server and the WEB Server of the instrument. In this menu is also the password for the servers set.
Note that Ethernet configuration is not done with set-up parameters and is for that reason not saved with the instrument back-up function.

To return to the weight display, press the 'Esc' key or F4 (Escape) key.

Level supervision

The G5 instrument contains 4 supervision Levels that can be used to supervise defined signals in the instrument. The 4 digital outputs can be assigned as outputs for Levels. For each Level, supervised scale, hysteresis and operation mode for the digital output is controlled by set-up parameters.

Functions for Level supervision are defined in menu 'Parameter Set-up' by parameters in the sub menus 'Level Supervision' and 'Outputs'. See chapter 'Set-up'.

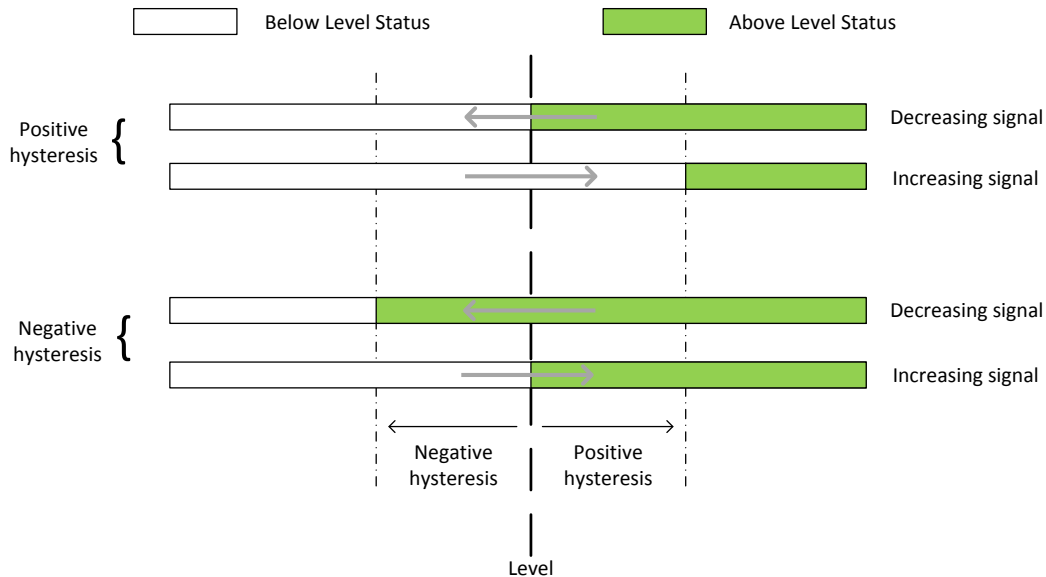

Influence on the level supervision from positive hystereses and negative hystereses.

'Level X Source'

Set to 'Not in use' will disable level X.

Select 'Net Weight' or 'Gross Weight' to supervise these weight values, independent of which weight that is actually displayed.

Select 'Display Weight' to supervise either gross weight or net weight, depending on which weight that is actually displayed.

Select 'Abs.Net Weight', 'Abs.Gross Weight', 'Abs.Disp.Weight' to act on the absolute value of these signals, i.e. the value independent of polarity.

'Level X Output':

Defines how a digital output, if connected to the Level, should operate.

The parameter can be set to make an output active when the signal is above the Level, or when it is below the Level.

'Level X Hystereses':

Defines the width of a hysteresis range for the Level. The definition of a negative hysteresis range starts with a minus sign (-).

Hysteresis is an intentional difference between the switch levels for increasing and decreasing signal level. One switch level is always at the defined Level.

The other switch level is at a higher level by positive hysteresis, at a lower level by negative hysteresis. See figure.

Level status

Actual status of the Levels (input signal above or below Level) can be read via communication and is shown at the display. The level status includes the influence from hysteresis, but it does not show the status of any digital outputs, connected to the Levels.

Setpoint function

General

The 4 Setpoints can be used for fast, accurate and reliable supervision of weight values. The Setpoint function is of a one shot type. The function is activated by a command from the master computer/PLC and deactivated when the weight has reached the Setpoint value.

The Setpoints can be connected to any digital output in the instrument.

The Setpoints can only be controlled by a master computer/PLC via serial communication.

NOTE: To ensure good operation during the time when a setpoint is activated, the zero-tracking function is not working.

Set-up

The set-up of the setpoint function is made with parameter **Setpoint X Source**. In this set-up you can select what signal (weight value) the setpoint shall act on. Assignment of an output to a setpoint is made in set-up menu **Outputs**.

Operation

The wanted setpoints (weight levels) must be loaded into the corresponding Modbus registers.

The setpoint(s) are activated by communication. If a setpoint is connected to an output, then corresponding digital output is activated.

When the selected weight becomes higher than the setpoint the setpoint function is deactivated and the corresponding **Setpoint X cycle done** bit is set. A connected digital output is also deactivated at the same time.

The setpoint function, and possible connected digital outputs, can also be deactivated by sending command **Deactivate setpoint X**.

NOTE the **Setpoint X cycle done** for a setpoint is reset when the setpoint value is loaded and when the setpoint is activated.

Digital inputs and outputs

The G5 instrument has 4 inputs and 4 outputs. All input and output functions are controlled by set-up parameters in the instrument. The digital inputs can be used for remote operation of the instrument. The digital outputs can be used for control of external equipment and for indication of instrument status.

Analog output

The G5 instrument has a one analog output that will represent a selected signal in the instrument in form of an analog current or voltage signal. All analog output functions are defined by parameters in sub menu **Analog outputs**, see chapter 'Set-up'.

Filter function

In the instrument the weight value is filtered to produce a stable measurement. To allow adaptation to the dynamic requirements of the specific installation it is possible to select the filter bandwidth within a broad range. The lowest bandwidth is 0.125 Hz and the highest is 50 Hz. The bandwidth is defined as the frequency where the output signal is 3dB lower than the input (attenuation = -3dB). For the 3 lowest bandwidths, 0.125 Hz, 0.25Hz and 0.5Hz the instrument have the possibility to change automatically to 1 Hz bandwidth during changing input, i.e. when the scale is loaded or unloaded. This will give a faster response to changes which is especially useful if the scale is manually handled e.g. manual filling. This function should be used if the bandwidth must be very low to achieve as high resolution as required and the response is then considered too slow.

Switching between filtered and unfiltered weight

The scale will switch to set bandwidth when the difference between samples is smaller than **Filter window**. Samples are compared with a time difference of 100 ms. If the difference is larger than **Filter window** the scale switches to 1 Hz bandwidth.

Note that the automatic switching only applies to bandwidth settings 0.125Hz, 0.25Hz and 0.5Hz.

Filter characteristics

Bandwidth	Attenuation at frequency	Rise time (to steady state)
50 Hz	-81 dB @ 215 Hz	30 ms
30 Hz	-73 dB @ 156 Hz	36 ms
15 Hz	-73 dB @ 77 Hz	66 ms
8 Hz	-76 dB @ 42 Hz	122 ms
4 Hz	-76 dB @ 21 Hz	233 ms
2 Hz	-76 dB @ 10.7 Hz	493 ms
1 Hz	-76 dB @ 5.3 Hz	993 ms
0.5 Hz	-76 dB @ 2.6 Hz	1993 ms
0.25 Hz	-76 dB @ 1.3 Hz	3994 ms
0.125 Hz	-76 dB @ 0.66 Hz	7993 ms

6. Communication

General

The G5 Instrument has one serial communication port, one Ethernet port and an optional fieldbus module.

The serial communication port can be used for communication with a control unit, for connecting a printer or for displaying the weight on an external display.

The Ethernet port can be used for communication with a control unit and for file transfer to and from an external computer, using ftp (File Transfer Protocol). These functions can be used simultaneously.

The optional fieldbus interface module is used for communication with a control unit.

Serial interface

The instrument is equipped with one RS-485 serial communication port. It can be used either for 2-wire or 4-wire. RS-485 is an interface working with differential voltages, giving a noise resistant transmission in a network with several units and long distances. The host computer (master) must have an asynchronous communication port for RS-485, or use a converter for RS-232 to RS-485 conversion or USB to RS-485.

If 2-wire transmission is used, the control unit must be capable of data flow direction control or utilize a converter for automatic data flow direction control. When 4-wire transmission is used, no data flow direction control is needed.

Modbus RTU Slave

General

All G5 units connected to the network can listen to what is transmitted in the network, but only one unit at a time may transmit. A time-sharing principle is needed to allow communication in both directions (half duplex).

All communication in the network must be initiated by the control unit (master).

When the instrument is working together with a master the instrument units are all slaves, only allowed to reply to master commands. As the master has addressed a command message to a specific slave unit, it listens for the reply during a specified time, before sending next command message.

If the reply from a slave unit fails it may be due to:

- Mismatch in communication parameters. (Baud rate, address, etc.).
- More than one slave unit has been transmitting at the same time.
This can distort the reply message and make it impossible to decode.

See chapter 'Communication – Modbus protocol' section for detailed information of register numbering, register content definition, commands etc.

More information about Modbus RTU can be found at 'www.modbus-ida.com' and many other places.

Setup of Modbus RTU communication

- The instrument will as default have the address 1. If more than one instrument is used in a network, each instrument must be given a unique address in parameter 'Modbus RTU address' (in 'Parameter set-up', menu 'Communication', sub menu 'Serial Communication').

- Set parameter 'Serial Com. Mode' to 'Modbus RTU Slave'.
- Select correct baud rate and data format in parameter 'Baudrate' and 'Data Format'.
- Select wanted type of float values in parameter 'Floating Point Format'.
- When longer response times are needed, set 'Min. Reply Time' to a suitable value.

Modbus TCP Slave

General

The Ethernet communication port can be used to communicate with the instrument using the Modbus TCP protocol. The instrument is a Modbus TCP slave and will only respond to incoming messages from a master.

See chapter 'Communication – Modbus protocol' section for detailed information of register numbering, register content definition, commands etc.

More information about Modbus TCP can be found at 'www.modbus-ida.com' and many other places.

Setup of Modbus TCP Slave communication

- Network configuration (IP address, Subnet Mask,...) is done from menu 'Network Configuration'.
- Enable the Modbus TCP Slave by setting parameter 'Modbus TCP Slave' to 'On' in menu 'Parameter Set-up / Communication / Ethernet / Modbus TCP Slave'.
- Select wanted type of float values in parameter 'Floating Point Format' (also in menu 'Modbus TCP Slave').

Ftp Server

The G5 instrument contains an ftp server that can be used to transfer files between the instrument and an external computer using an ftp client. To connect to the instrument the ftp client must login to the instrument with the user ID 'G5User' and the password '1937' (default password). Note that the password for the ftp server and the web server can be set in the menu 'Server Configuration'. In this menu there are also settings for turning on or off the ftp server and web server. By default both ftp server and web server are turned on.

The ftp handling can be automatic, e.g. to collect log files once every 24 hours or manual.

The ftp client (on an external computer) can access the user area of the instrument flash file system. The user area consists of (by default) the BACKUP folder. Installed SD-Card and USB memory can also be accessed with ftp.

Modbus protocol

For communication with a master computer (PLC) the Modbus protocol is used in the instrument. The Modbus protocol is a standard protocol, used for master/slave communication in the industry.

Information is transmitted in blocks of data to minimize polling and response time delays. For example the error register, status register and weight register could be read with one command to the instrument.

When a command that cannot be performed is sent, the instrument responds with an exception code. For a better explanation of the error, a special command error register could be read.

Depending on the type of the communicating equipment (the master), the commands in the application program (PLC program, or pc program) may be different from type to type. However, if the master is not a Modicon PLC system, then the Modbus implementation in the master must have some cross-reference function to transfer the Modbus register and I/O bit numbering to the masters own register and I/O bit numbering. All registers and coils described in this manual use the standard Modbus (Modicon) register and I/O numbering.

See the master's own Modbus driver documentation for how the commands should be activated in the master's application program.

Most manufacturers of PLC systems and HMI and SCADA software can provide Modbus drivers. Various Modbus drivers for development of Windows programs are also available on the market.

More information about Modbus protocol can be found at 'www.modbus-ida.com' and many other places.

General registers

The G5 instrument has a number of Modicon 'Holding Registers' (registers 4XXXX ...). The Modbus function 03 'Read Holding Registers' should be used to read these registers and the Modbus function 05 'Preset Single Register' or 16 'Preset Multiple Registers' should be used to write to the registers.

See section 'Data representation' for a description of the different data formats used.

Hint: To find out which of the float formats that should be used, read the 'Instrument type' register (44000), which equals '5001' for the instrument.

Data type: Integer	Data type: float (2 reg./value)	Explanation	R/W
40001 (1 reg)	44000	Instrument type	R
40002 (1 reg)	44002	Program number	R
40003 (1 reg)	44004	Program major version	R
40004 (1 reg)	44006	Program minor version	R
40006 (3 reg)	44010	Serial number	R
40009 (1 reg)	44012	Hardware version	R
40010 (1 reg)	44014	Hardware type	R
40020 (1 reg)	44020	Alibi memory error detected	R
40021 (1 reg)	44022	Alibi memory queue error count	R
40022 (1 reg)	44024	Alibi memory store error count	R
40030 (1 reg)	44030	Command error	R
40031 (1 reg)	44032	Instrument state	R
40032 (1 reg)	44034	Instrument error	R
40033 (1 reg)	44036	Instrument status	R
40034 (1 reg)	44038	Scale Error code	R
40035 (1 reg)	44040	Scale Status	R
40036 (3 reg)	44042	Gross weight	R
40039 (3 reg)	44044	Net weight	R
40042 (3 reg)	44046	Flow rate (not used in this version)	R
40045 (3 reg)	44048	Input signal (mV/V)	R
40070 (3 reg)	44070	Analog output value	R
40082 (1 reg)	44078	Status of digital inputs	R
40083 (1 reg)	44080	Status of digital outputs	R

Data type: Integer	Data type: float (2 reg./value)	Explanation	R/W
40084 (1 reg)	44082	Level status	R
40085 (1 reg)	44084	Setpoint status	R
40086 (3 reg)	44086	Analog input value	R
42000 (1 reg)	46000	Command register	R/W *
42002 (1 reg)	46002	Clock: Year	R/W
42003 (1 reg)	46004	Clock: Month	R/W
42004 (1 reg)	46006	Clock: Day	R/W
42005 (1 reg)	46008	Clock: Hour	R/W
42006 (1 reg)	46010	Clock: Minute	R/W
42007 (1 reg)	46012	Clock: Second	R/W
42010 (3 reg)	46020	Preset tare value	R/W
42016 (3 reg)	46024	Level 1 value	R/W
42019 (3 reg)	46026	Level 2 value	R/W
42022 (3 reg)	46028	Level 3 value	R/W
42025 (3 reg)	46030	Level 4 value	R/W
42028 (3 reg)	46032	Setpoint 1 value	R/W
42031 (3 reg)	46034	Setpoint 2 value	R/W
42034 (3 reg)	46036	Setpoint 3 value	R/W
42037 (3 reg)	46038	Setpoint 4 value	R/W
42040 (3 reg)	46040	Digital outputs remote ctrl	R/W
42043 (3 reg)	46042	Analog output remote ctrl	R/W
42055 (3 reg)	46050	Accumulated weight, low part	R/W
42058 (3 reg)	46052	Accumulated weight, high part	R/W

*/ The read value is always 'zero'.

Important:

'Net weight', 'Gross weight' and 'Flow rate' registers for a scale are only valid when 'Scale error code' register equals 0. Therefore it's recommended to read the 'Instrument error' register together with these registers.

Instrument type

This register holds the type of the instrument. For G5 Weighing Instrument this value is 5001.

Program number, major version and minor version

These registers hold the program number, major version and minor version for the program installed in the instrument.

Serial number

This register holds the serial number of the instrument. The value 991000 means 99-1000. First 2 digits is manufacturing year and the last 4 is the serial number. Together the 6 digits uniquely identify the unit. This can be used by the master to be sure that an instrument with a specific serial number is used for a special process.

Hardware version

A difference between instruments in HW version means that there is some difference in the instrument hardware such as the electronics or mechanics. If the differences are significant it will be outlined in the manual.

Hardware type

Allows a PLC system or similar control system to check which type of instrument it is. This data is bit oriented and new information may be added in newer models of the instrument.

Bit 0: 0 if it's a single load cell input model, 1 if it's a dual load cell inputs model.

Bit 1: 0 if it's a transmitter (RM) model, 1 if it's a panel mount (PM) model.

Bit 2: 0 if it's a DC power model, 1 if it's an AC power model.

Alibi memory registers

These 3 registers are used to provide information on the error status of the alibi memory handling. The alibi memory is a file where information on weight is stored when the print button is pressed or a print command is given.

Command error

This register holds the error code when a command has been sent to the instrument. A command that gives a 03 or 07 as exception will have an error code with a better description of the problem in this register. Normally this register should contain '00' which means no error. Error codes 0 to 255 are valid in this register.

Instrument state

This register contains the state of the G5 instrument.

Code	Description
00	'Starting up' state. The instrument is starting up after a reset or power on.
01	'Wait for start' state. The instrument is waiting for a start command to go in process.
02	'Warming up state' The parameter 'Warm up time' is set to a value other than zero, and the instrument is waiting for the warming up time to pass.
03	'Normal' state. There are no parameter errors in the system. Note: Weight errors still indicate normal state.
04	'Error' state. An error has been detected during startup of the instrument.
05	'Fatal error' state. An error has been detected during startup of the instrument. It's not possible to enter any other state from here.
06	'Power fail' state. A power fail has been detected and the instrument will respond to communication for a short moment until the power supply reserves are empty (this is normally just a few ms). Weight values should be regarded as invalid.

Instrument error

This register holds the overall error code for the instrument.

Normally this register should contain '00' which means no error.

Instrument status

This register holds the overall status for the instrument

Bits set to 1 in this register have the following meaning:

Bit no	Function	Comment
0	Remote operation	'1' = On '0' = Off
1	Program reset	<p>The bit is set each time the program starts, and it indicates that volatile data is lost.</p> <p>The bit is reset as Instrument status is read, over serial communication (Modbus RTU) or over Ethernet (Modbus TCP), for the first time after reset/power-up. Note that the reply contains the set bit if it was set.</p> <p>Reading Instrument Status via Fieldbus interface will <u>not</u> reset this bit. To reset this bit with fieldbus interface a specific reset command must be used.</p> <p>Care must be taken if more than one interface is used to communicate with the instrument and the Program reset bit is to be used.</p>
2-15	Not used	

Note: If this register (bits) is read as float value, see description of Data representation.

Scale Error code

This register holds the error code for the scale. Normally this register should contain '000' which means no error. Error codes 000 to 255 are valid in this register.

Scale Status

Bits set to 1 in this register have the following meaning:

Bit no	Function	Comment
0	Net weight > INT size	The net weight in 'scaled integer' format does not fit in one register. (See description of data representation.)
1	Gross weight > INT size	The gross weight in 'scaled integer' format does not fit in one register. (See description of data representation.)
2	Flow rate > INT size	The flow rate in 'scaled integer' format does not fit in one register. (See description of data representation.)
3	Good zero (disp. weight)	
4	Good zero Gross	
5	Good zero Net	
6	Net Mode	'1' = Net mode '0' = Gross mode
7	Motion	Unstable weight
8		
9		
10		
11	Flow rate display	Flow rate is shown in the display.
12	Net weight > 6 digits	The net weight value is out of precision and should normally not be used.
13	Gross weight > 6 digits	The gross weight value is out of precision and should normally not be used.
14		
15		

Note: If this register (bits) is read as float value, see description of Data representation.

Gross weight

This register holds the gross weight. The weight should **not** be read alone because the status and error codes are stored in other registers. The weight is only valid when the register 'Scale Error code' equals 00.

Net weight

This register holds the net weight. The weight should **not** be read alone because the status and error codes are stored in other registers. The weight is only valid when the register 'Scale Error code' equals 00.

Flow rate

No used in the current program version. Always 0.

Input signal (mV/V)

This register holds the current input signal in mV/V. This register could be used for fault finding in the system.

Analog output value

This register hold the value sent to the analog output. The registers can be used for fault finding in the system. The value is rounded to 3 decimals.

Status of digital inputs 1 - 4

Bits set to 1 in this register have the following meaning:

Bit no	Function
0	Digital input 1 activated.
1	Digital input 2 activated.
2	Digital input 3 activated.
3	Digital input 4 activated.

Note: If this register (bits) is read as float value, see description of Data representation.

Status of digital outputs 1 - 4

Bits set to 1 in this register have the following meaning:

Bit no	Function
0	Digital output 1 activated.
1	Digital output 2 activated.
2	Digital output 3 activated.
3	Digital output 4 activated.

Note: If this register (bits) is read as float value, see description of Data representation.

Level status 1-4

Bits set to 1 in this register have the following meaning:

Bit no	Function	Comment
0	Above level 1	The weight is above Level 1.
1	Above level 2	The weight is above Level 2.
2	Above level 3	The weight is above Level 3.
3	Above level 4	The weight is above Level 4.

Note: If this register (bits) is read as float value, see description of Data representation.

Setpoint status 1-4

Bits set to 1 in this register have the following meaning:

Bit no	Function	Comment
0	Setpoint 1 activated	See description for setpoint function.
1	Setpoint 1 cycle done	See description for setpoint function.
2	Setpoint 2 activated	See description for setpoint function.
3	Setpoint 2 cycle done	See description for setpoint function.
4	Setpoint 3 activated	See description for setpoint function.
5	Setpoint 3 cycle done	See description for setpoint function.
6	Setpoint 4 activated	See description for setpoint function.
7	Setpoint 4 cycle done	See description for setpoint function.

Note: If this register (bits) is read as float value, see description of Data representation.

Analog input

In this register it is possible to read the voltage on the analog input. The value is given in V with 3 decimals. The range of the input is about +-11V.

Command register

As this register is read, the answer will always contain only zeros.

There are a number of actions that can be activated in the instrument. The value of this register (when different from zero) will activate one of these actions, as described in below.

When an action cannot be performed for some reason (wrong state etc.) an exception is given as reply. When an exception with code 03 is received the command error register could be read to get a better error explanation.

Cmd	Action activated in instrument	Description
0	No action	
1	Start operation	When the instrument is in 'Wait for start state', this command can be used to start up the instrument.
2	Enter Remote operation	This command disables the keys on the instrument. This means that an external computer is controlling the instrument or the instrument is controlled using digital inputs.
3	Exit Remote operation	This command enables the keys and leaves the remote operation.
10	Auto tare	
11	Set to zero	Used to set the gross weight to zero.
12	Select gross mode	
13	Select net mode	
14	Weight display	Show weight on the display.
15	Flow rate display	Show flow rate on the display.
16	Print command	Initiate a weight printout
100	Activate setpoint 1	See description of setpoint function.
101	Deactivate setpoint 1	See description of setpoint function.
102	Activate setpoint 2	See description of setpoint function.
103	Deactivate setpoint 2	See description of setpoint function.
104	Activate setpoint 3	See description of setpoint function.
105	Deactivate setpoint 3	See description of setpoint function.
106	Activate setpoint 4	See description of setpoint function.
107	Deactivate setpoint 4	See description of setpoint function.
132	Activate setpoint 1-4	See description of setpoint function.
133	Deactivate setpoint 1-4	See description of setpoint function.

Clock

These registers are used to read the time and date from the instrument.

Scale Preset tare value

This registers is used to read and write a new preset tare.

Level 1 - 4 value

These registers are used to read and write levels that are supervised by the instrument.

Setpoint 1 - 4 value

The registers are used to read and write setpoints. See description of setpoint function.

Accumulated weight registers

Accumulated weights are updated when a print command is issued. The accumulated values can also be read in the 'Accumulated Weights' menu in the 'Main menu'. In this menu it is also possible to zero or set the values.

An accumulated weight is represented by two values (HIGH, LOW). To get the resulting value multiply value HIGH by 10000 and add value LOW. LOW is a value between ± 9999.999 with 3 decimals. HIGH is a value without decimals between ± 999999 . To zero accumulated weight, send 0 to both HIGH and LOW.

NOTE! Both HIGH and LOW must be written in ONE Modbus message on order to change the value.

I/O bits (Coils)

The instrument has a number of I/O bits that the master can write to using Modbus function 05 or 15.

Each of these I/O bits are linked to a command in the instrument, which is described previously in this manual.

Set the I/O bit with the same number as the command that should be executed.

The action is activated if the master sets the I/O bit to 'ON'.

If the master sets the I/O bit to 'OFF', this is accepted, but no action is activated.

All I/O bits are WRITE ONLY. This means the master cannot read the I/O bits but only write to them.

Note: If the master tries to write to more than one I/O bit (Modbus function 15) the instrument will act on the lowest I/O bit number only.

Data representation

Data sent to and from the instrument uses 16 bit holding registers (40XXX) and can use different formats for flexibility.

Integer

Unsigned integer (1 modbus register)

Values stored in one modbus register as an unsigned integer (16 bit number without decimals).

Scaled integer (2 modbus registers + 1 modbus register = 3 modbus registers)

Values stored in a special 3 register format. The first two registers are used as a 32 bit long integer value (with sign) and the third register is holding the number of decimals in the value.

Example: 12345678 (32 bit number) in the two first registers and 3 in the third register give the value: 12345.678.

Register	Hex	Decimal	Description
1	00BC	188	The 16 most significant bits in the value.
2	614E	24910	The 16 least significant bits in the value.
3	0003	3	The number of decimals.

Calculations in decimal numbers:

First multiply the most significant register with 2^{16} (65536) and add the least significant register to the value.

$$188 * 2^{16} + 24910 = 12345678$$

Now divide the number to get the right number of decimals. The decimal register was set to 3 in this example, which gives the value $10^3 = 1000$ to divide with.

$$12345678 / 1000 = 12345.678$$

Note: If you want to read weight or flow rate values and your PLC system can't handle 32 bit values, the second register can be used as a 16 bit register with the number of decimals that is indicated in the third register. This will limit the value range to -32768 to +32767. Flags in Status register for corresponding scale indicates when the weights are bigger than a 16 bit integer. These flags must be checked to be sure that the weight or flow value fits in just one register.

Float values

The type of float values used in the communication is selected in the set-up for the different communication interfaces.

Values stored as standard IEEE 32 bit float values. Each value has two registers assigned to it. To read/write a float value an even number of Modbus registers, starting at an even address, must be read/written each time. The float values are stored in two different register orders.

Some devices may transfer the values with the high order bits in the first register and the low order bits in the second register. Other devices may invert the register order.

Modicon float: For true Modicon PLC's.

Float: Many third party controllers that support Modicon protocol use the float format where all bytes are written out in order to one 32 bit register, as opposed to Modicon float which uses 2 consecutive 16 bit registers.

When float registers representing bits are read, the bits set are returned as a float value.

For example if bit 4 is set the value 16.0 is returned as a float value, and if both bit 0 and bit 4 are set the value 17.0 is returned as a float value.

To use the value it's a good choice to convert it to an unsigned integer where the bits can be compared.

Exception responses

When the master sends a query to a slave it expects a normal response (as described earlier). One of the following three events occurs after a query from the master.

1. Normal response.

The slave has received the query without communication error and can handle the query normally. The slave returns a normal response.

2. Communication error.

If the slave does not receive the query due to a communication error, or detects some communication error (parity error or checksum error), **no** response is returned. The master should process a time-out for the query.

3. Command error.

If the slave receives the query without any communication error, but cannot handle the query, e.g. if the command was not valid, the requested register number not valid or instrument in a mode where the command was not allowed, then the slave will return an exception response informing the master of the nature of the error.

The following exception codes are possible.

Code	Name	Description
01	Illegal function	Not a valid function code. Valid function codes are 01, 02, 03, 05, 06, 08, 15, 16.
02	Illegal data address	Not a valid data address. See 'Register description' for a list of allowed registers.
03	Illegal data value	Value in data query field not valid. To get a better explanation of the error, the 'command error' register could be read.

Supported Modbus functions

Function	Description
01 Read Coil Status	Reads the state of discrete outputs (0X references, coils). Only implemented because some 'masters' use this function to initiate communication. Coil range: 1 – 16 (Max number of points to read: 16). Response: Zero (OFF) for all requested points.
02 Read Input Status	Reads the state of discrete inputs (1X references). This function is implemented only because some 'masters' use this function to initiate communication. Input range: 1 – 16 (Max number of points to read: 16). Response: Zero (OFF) for all requested points.
03 Read Holding Reg.	Reads the binary contents of holding registers (4X references). Max number of registers to read: 125
05 Force Single Coil	Forces a single coil (0X references) to either ON or OFF. This function is used to activate commands in the instrument.
06 Preset Single Reg.	Presets a value into a single holding register (4X references).
08 Diagnostics	This function can provide a series of different communication tests, depending on a sub function code. The instrument supports only sub function code 00, which is a 'loop-back' test. The same data as received will be sent back to the master. Max number of data bytes: 64
15 Force Multiple Coils	Forces each coil (0X references) in a sequence of coils to either ON or OFF. This function is used to activate commands in the instrument. Max. number of points: 16 (only the first is used).
16 Preset Multiple reg.	Presets values into a sequence of holding registers (4X references). Max number of registers to preset: 125

Note: No broadcast messages are allowed.

It is possible to send or fetch any number of registers (max 125) or I/O bits (max. 16).
If the master tries to read more registers than there are available, the instrument will send dummy values for those registers not available.

Fieldbus interface

The optional fieldbus interface is based on a network communication module from HMS Industrial Networks. Available fieldbuses are Profibus, DeviceNet and ControlNet. With setup parameters the fieldbus interface is configured for the specific needs of an installation. It is possible to setup address, baud rate (if applicable to the actual fieldbus type) and if the weight values shall be in integer or floating point format.

The registers mentioned below are Modbus registers as defined in section Communication – Modbus Protocol. Each Modbus register is two bytes wide. This section also describes commands.

See table defining data mapping on the fieldbus. The mapping in the master and the instrument must always correspond.

Setup of fieldbus communication

- Complete the set-up of fieldbus communication before connecting it to the network to avoid possible network failure due to mismatch in configuration between network and instrument.
- Select the fieldbus type used in the 'Hardware Configuration' menu.
Note that the instrument will be restarted after changes in the hardware setup.
- Select the appropriate device address for the instrument. Address is setup in menu 'Communication – Fieldbus'.
Note that the address range is depending on type of fieldbus.
- Select baud rate, if applicable, according to the used baud rate in the network.
Some fieldbuses may support automatic baud rate setting. Use fixed baud rate setting if there are difficulties to connect to the network or if the network baud rate is known.
- Check that the configuration of the master is compatible with the actual configuration of the instrument.
- Connect to the network.

Fieldbus Data Definitions

Data from the network (Outputs in the master). 16 bytes mapped to the network in the instrument. Most significant byte is always first in multi byte values.

Byte	No of bytes	Contents
00	1	Command
01	1	Number of registers to write
02	2	Start address, Read/Write
04	2	Write register 1
06	2	Write register 2
08	2	Write register 3
10	2	Write register 4
12	2	Write register 5
14	2	Write register 6

Byte 0: The command byte is used when setting the read window starting address, writing data to the instrument and to issue various scale related commands such as taring, zeroing etc.

Commands:

0	No action
250 (hex FA)	Change read window
251 (hex FB)	Write data
252 (hex FC)	Clear the Program reset bit in the Instrument Status register.

Plus commands according to the manual, chapter 'Communication – Modbus protocol – Command register'.

Note that a new command is detected when the content of the command register is changed. If the same command is used more than once another command e.g. 0 must be used in between.

The response to a given command is the 'Command acknowledge' and the 'Command error' bytes that are described below in section 'Data to the network'.

Byte 1: Used to define the number of registers to write.

Bytes 2 and 3: Define from which register number to read or write.

Bytes 4 to 15: Contains the data when writing to the instrument.

Data to the network (Inputs in the master). Most significant byte is always first in multi byte values. The table below shows the mapping in **integer** format. The format of the data in the 12 read registers depend on which registers are read. Totally 80 bytes.

Byte	No of bytes	Contents
00	1	Instrument state
01	1	Instrument error
02	1	Instrument status
03	1	Not used
04	1	Command acknowledge
05	1	Command error
06	2	Start address, Read
08	2	Read register 1
10	2	Read register 2
12	2	Read register 3
14	2	Read register 4
16	2	Read register 5
18	2	Read register 6
20	2	Read register 7
22	2	Read register 8
24	2	Read register 9
26	2	Read register 10
28	2	Read register 11
30	2	Read register 12
32	1	Setpoint status
33	1	Level status
34	1	Digital input status
35	1	Digital output status
36	2	Scale error code
38	2	Scale status
40	4	Gross weight
44	4	Net weight
48	2	No of decimals in integer weight
50	4	Flow rate
54	2	No of decimals in integer flow rate
56	4	Input signal (mV/V), 5 decimals
60	4	Analog output value (V or mA), 3 decimals
63	16	16 bytes reserved for special programs

Data to the network (Inputs in the master). Most significant byte is always first in multi byte values. The table below shows the mapping in **floating point** format. See table which values that actually are in floating point format. The format of the data in the 12 read registers depend on which registers are read. Totally 80 bytes.

Byte	No of bytes	Contents
00	1	Instrument state
01	1	Instrument error
02	1	Instrument status
03	1	Not used
04	1	Command acknowledge
05	1	Command error
06	2	Start address, Read
08	2	Read register 1
10	2	Read register 2
12	2	Read register 3
14	2	Read register 4
16	2	Read register 5
18	2	Read register 6
20	2	Read register 7
22	2	Read register 8
24	2	Read register 9
26	2	Read register 10
28	2	Read register 11
30	2	Read register 12
32	1	Setpoint status
33	1	Level status
34	1	Digital input status
35	1	Digital output status
36	2	Scale error code
38	2	Scale status
40	4	Gross weight (floating point format)
44	4	Net weight (floating point format)
48	4	Flow rate (floating point format)
52	4	Input signal (mV/V) (floating point format)
56	4	Analog output value (V or mA) (floating point)
60	4	Four bytes with 0 value
63	16	16 bytes reserved for special programs

Bytes 0, 1 and 2:

See chapter 'Communication – Modbus protocol'.

Byte 4:

The 'Command acknowledge'. It will be equal to the command number if the command was successfully executed. If the command failed byte 4 will have the value 240 (hex F0).

Byte 5:

This byte will be zero if a command is correctly executed otherwise it hold the 'Command error' code. The error code is explained in chapter 'Troubleshooting – Error codes'.

Bytes 6 and 7:

These two bytes is the starting address of the reading area following in bytes 8 to 31. The address defines the address of the first of the 12 consecutive Modbus registers in the read area. See chapter 'Communication – Modbus protocol' for details on Modbus register address definitions.

Bytes 8 to 31:

These 24 bytes is the area used when the user wants to read any data that is accessible through Modbus registers. The address (number) of the first register is defined in bytes 6 and 7 and the instrument will keep the 24 bytes (12 registers) updated.

Bytes 32 - 64:

See chapter 'Communication – Modbus protocol for details

Bytes 65 – 79:

16 bytes reserved for use by special program versions.

Examples

Example 1: Setting 'Level 1 Value' to 123.5 (Writing to float value register).

1. Make sure that the previous command was not 251.
Set command byte (00) to 0 if previous command was 251.
2. Set number of registers (2) to write in byte 01.
3. Set start address (46026) in bytes 02 and 03.
See chapter 'Communication – Modbus protocol – General registers'.
4. Set the following four bytes (04 – 07) to the value to write (123.5).
5. Enter the command (251) in byte 00.

Byte	Description	Dec	Hex
00	Command	251	FB
01	Number of registers to write	2	02
02 – 03	Start address	46026	B3 CA
04 – 07	Value to write in register 1 and 2	123.5	42 F7 00 00
08 – 15	Write registers 3 – 6.	—	—

Example 2: Setting 'Setpoint 4 value' to 123.5 (Writing to integer value register).

1. Make sure that the previous command was not 251. Command byte (00) must be set to 0 if previous command was 251.
2. Set number of registers (3) to write in byte 01.
3. Set start address (42139) in bytes 02 and 03.
See chapter 'Communication – Modbus protocol – General registers'.
4. Set the following four bytes (04 – 07) to the value to write 123.50, i.e. 12350 and two decimals.
5. Set bytes 08 and 09 to number of decimals. In this example is 2 decimals used.
6. Enter the command (251) in byte 00.

Byte	Description	Dec	Hex
00	Command	251	FB
01	Number of registers to write	3	03
02 – 03	Start address	42139	A4 9B
04 – 07	Value to write in register 1 and 2	12350	00 00 30 3E
08 – 09	Value to write to register 3	2	00 02
10 – 15	Write registers 4 – 6.	—	—

Example 3: Set read window to read from Scale floating point data (registers 44038 to 44048). Note that the number of registers read is always 12.

1. Make sure that the previous command was not 250.
Set command byte (00) to 0 if previous command was 250.
2. Set start address (44038) in bytes 02 and 03.
See chapter 'Communication – Modbus protocol – General registers'.
3. Enter the command (250) in byte 00.

Byte	Description	Dec	Hex
00	Command	250	FA
01	Number of registers to write	—	—
02 – 03	Start address	44038	AC 06
04 – 15	Write registers 1 – 6.	—	—

Example 4: Reset the 'Program reset' bit in 'Instrument status'.

1. Make sure that the previous command was not 252.
2. Enter the command (252) in byte 00.

Byte	Description	Dec	Hex
00	Command	252	FC
01	Number of registers to write	—	—
02 – 03	Start address	—	—
04 – 15	Write registers 1 – 6.	—	—

Example 5: Other commands like Taring, Zeroing etc.

See chapter 'Communication – Modbus protocol – Command register' for a list of available commands.

1. Make sure that the previous command was not the desired command.
2. Enter the desired command in byte 00.

Byte	Description	Dec	Hex
00	Command	XXX	XX
01	Number of registers to write	—	—
02 – 03	Start address	—	—
04 – 15	Write registers 1 – 6.	—	—

Note that a dash in Dec. or Hex columns above indicates that the value is unimportant and not used for the function described.

7. Remote Access

General

Using a PC with a Web Browser, like MS Internet Explorer, it is possible to get access to the instrument set-up and maintenance functions. The PC can be connected to the same network as the instrument, or directly with an Ethernet cable.

Before connecting any instrument to an existing network it should be configured according to the network requirements. Note that the 'Network Configuration' menu is only available with the local user interface on the instrument and not via remote access. The 'Network Configuration' menu is found in 'Main Menu'. Under 'Network Configuration' menu is the 'Server Config' menu found where the Web Server can be enabled (default) or disabled. Also the password can be set here.

The remote access interface of the G5 instrument is intended to facilitate the set-up and maintenance work with the instrument. During e.g. commissioning it will make it possible to have the PC close to the equipment when the instrument is placed away from the equipment. It is possible to access several instruments that are connected to the same network from one location for set-up, diagnostics etc. It is also possible to access instruments over Internet for e.g. remote diagnostics provided that the network allows remote access e.g. using VPN (Virtual Private Network). This requires specific security measures that are the responsibility of the user/network administrator.

Note that the remote access is not primarily intended as an operator interface. If a remote operator interface is desired the Modbus TCP (Ethernet), Modbus RTU (serial com.) and the Fieldbus interfaces are recommended.

Browser requirements

The Remote Access interface has been tested primarily with MS Internet Explorer and Mozilla Firefox browsers. It will probably work with many other browsers but browsers tend to behave differently and some functionality may work or look differently in other browsers. If any problems are encountered please try Internet Explorer.

JavaScript must be enabled for the remote access to work. It is also required that the browser supports frames.

The web pages are designed to fulfill HTML 4.01 either Transitional or Frameset.

Using the Remote Access

To navigate in the menu system a mouse, touch pad, pointing stick etc. must be used. The keyboard cannot be used for navigation. Hovering with the mouse pointer over a selection in a menu will highlight the item and clicking will open the next menu level or allow for a parameter to be edited. The keyboard is only used when entering values like numbers or texts. The mouse is used to select between parameter choices during set-up.

When navigating back (up) in the menu system use the 'Escape' button on the screen and not the back button of the browser. This is because browsers commonly caches pages in the PC. Since the pages from the Instrument are dynamic i.e. have a content that is depending on the actual settings a cached page cannot be used. The instrument also keeps track of the currently displayed page (current state) of the menu system and does not allow for multiple pages being displayed simultaneously on different browsers or tabs. If there is any problem with a page or a page is suspected to be cached and not fresh from the instrument just refresh the page by clicking the refresh button or F5. This will refresh the entire page.

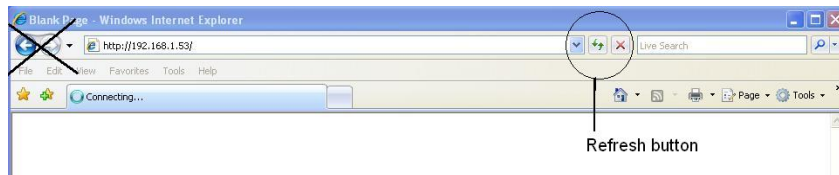

Refresh button, back and forward buttons not used

Security

The internal Web Server and Ftp Server use basic authentication that will keep the user ID and password hidden from the average computer user. It will however not provide a secure connection, no encryption etc. It is possible with some simple equipment and knowledge to find out the user ID and password. It is therefore strongly suggested that the set-up and operator locks, in the instrument, are used. It is also recommended to use the login protection on the used PC and also log out while not in use.

Using the instrument connected to the Internet will require specific security measures that are the responsibility of the user/network administrator.

Remote Access Login and Logout

Entering the IP Address of the desired instrument in the address field of the browser will have the instrument Web Server presenting the login form, see the picture below.

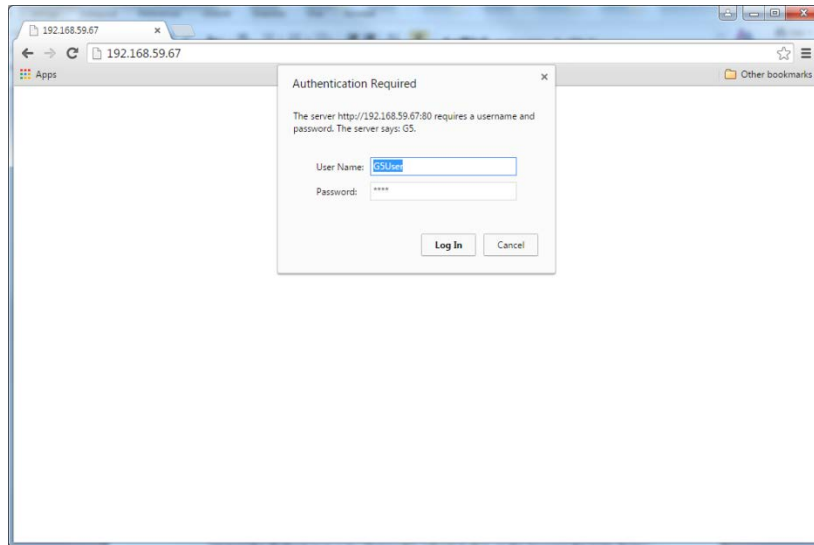

Login form

The user ID is always 'G5User' (case sensitive) and the password is by default '1937'. It is possible to change the password in the **Main Menu / Network Configuration / Server Configuration** menu. Note that the Ftp Server have its own password (default is 1937 also for the ftp server).

If the wrong password is entered the Access Denied page will displayed. Usually this will happen after three failed login attempts or if the Cancel button is clicked. By clicking the Refresh text or by clicking the refresh button on the browser the login form will be displayed again. Clicking the Close text will close the browser (not possible on every browser). See the picture below.

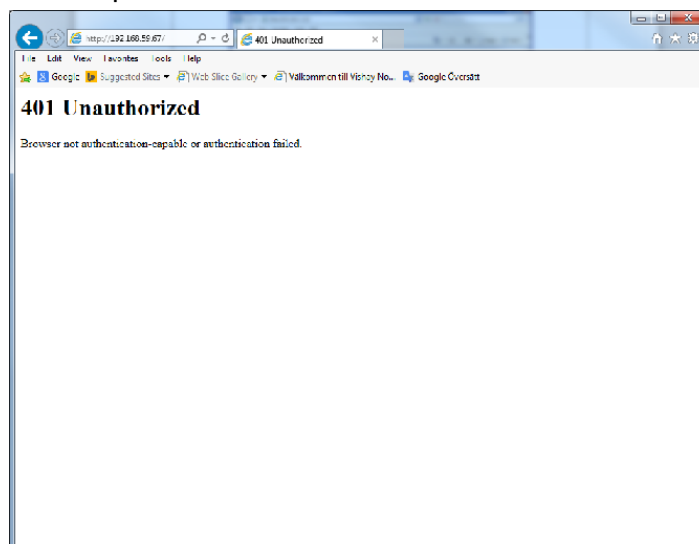

Access denied screen

When the correct login credentials are entered the entry screen will be displayed. This picture will show the Instrument Name (if set) or possible start up errors (serious and fatal errors). Any errors shown here must normally be corrected from the instrument and not through remote access. If the start mode of the instrument is 'Command' this will be shown on the entry screen. Note that the start command must be given from the

instrument front panel or by communication, not from the Remote Access. It is possible to access the menu system even if the instrument is waiting for a manual start command.

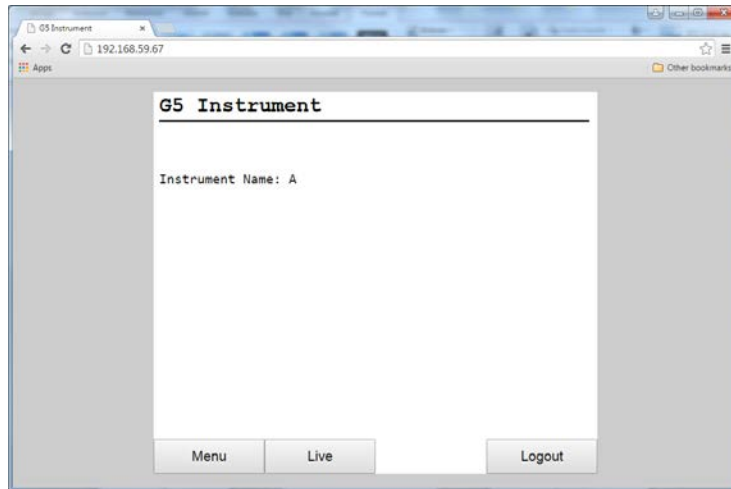

Entry screen

Two buttons are available on the Entry Screen. One is the 'Menu' button, which will give access to the menu system of the instrument. Clicking the 'Menu' button is equivalent to pressing the 'Info' button on the instrument front panel. The other button on the Entry Screen is the 'Logout' button. Clicking the 'Logout' button will logout the user and display the picture shown below.

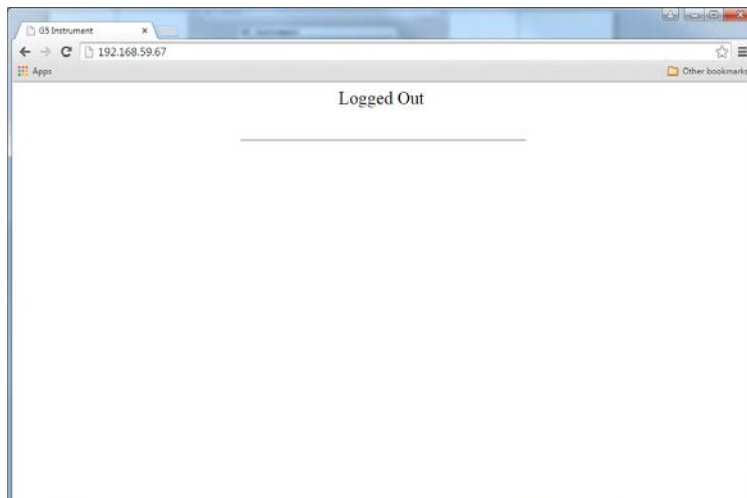

Logged out screen

Clicking the 'Close the Window' text will close the browser (if allowed by the browser). Note that the browser may save the login credentials which then are proposed as default next time the user tries to login to the same unit.

When a remote access session is finished the user should log out from the entry screen before closing the browser. Also see 'Remote / Local Access' below.

If one user is using the Remote Access when another user tries to login he will be presented an override picture provided login is accepted. To continue and logout the current user click the 'Yes' text (link). Click the 'No' text (link) to avoid overriding the current user and close the browser.

The overriding user will continue at the same position in the menu system as the old user was. The override function is intended to give a new user a warning not to

interfere with another Remote Access user unconscious. Note that if a user has been idle for 30 min he will be logged out automatically. Next user to log in will continue from the same position in the menu system.

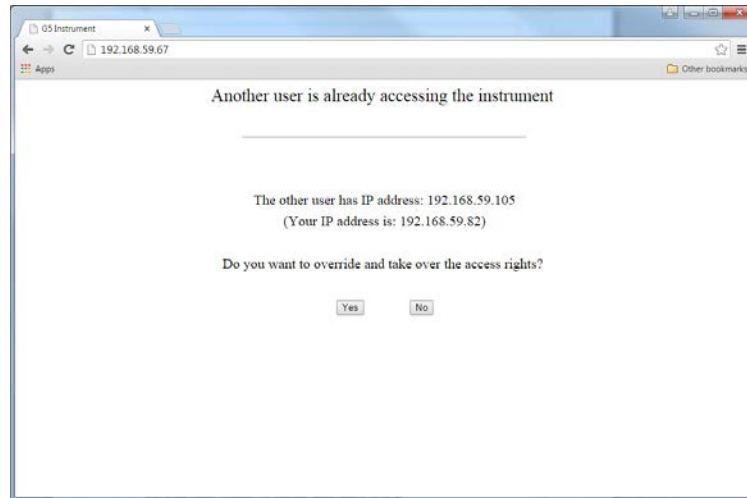

Override screen

Remote / Local Access

It is possible to access the menu system both locally and remotely simultaneously. It is however not possible to edit from more than one interface at a time. The first to start edit any parameter will get exclusive access to parameter editing. This also applies to e.g. maintenance functions. To release the exclusive access the user must navigate out of the menu system, i.e. exit the 'Main Menu' level.

When a remote access session is finished the user should log out from the entry screen before closing the browser, unless intending to continue, to avoid holding the exclusive access rights, which will block a local user from editing parameters or using some maintenance functions. Note that the blocking also will occur in the opposite direction.

To resolve such a blocking situation without being able to access the blocking interface it is possible to restart the instrument using the 'Instrument Restart' function that can be found in the 'Maintenance' menu. This function must be used with caution since it will interrupt all instrument functions while restarting the instrument. Also note that if the 'Start Mode' is set to 'Command' the instrument will wait at start-up for a start command from the instrument front panel or via communication.

There are a few differences between local and remote access. From the Remote Access Interface it is not possible to do Program Upgrade (Maintenance) or Network Configuration (Main Menu). All other functionality is available.

8. Maintenance

General

This chapter describes the maintenance functions when handled from the local display. The Maintenance menu includes a number functions used for diagnostics, maintenance and program upgrade purposes. The Maintenance menu is found under the Main menu.

File Handling

File handling is used for copying, moving (renaming) and deleting files.

Files can be copied and moved between folders in the instrument and between a USB memory and the instrument (both to and from the USB memory). File can be renamed while copying or moving.

It is possible to delete files stored in the instrument and on a USB memory.

The file handling has access to the 'user tree' directory structure in the instrument. The default folders are 'InstrBackup', 'LogFiles', 'Misc' and 'Recipes'. The folder 'InstrBackup' is used as default when creating or restoring backup and the folder 'LogFiles' is used to store various types of log files.

If there are problems with file copy or file move it might be because of insufficient memory. Try removing unnecessary files in the user tree.

Create Backup

Parameter values are stored in a file that can be used to restore to same or other instruments of the same type. The user can select to save the back-up file either in the instrument or on a connected USB memory. The file name can be edited. Note that additional information, which is saved in the backup file, can be given before the backup file is created.

Restore Backup

Restoring a previously stored parameter backup to the instrument. Any additional information in the backup file is displayed before a backup file is restored. Backup files can be fetched from internal memory or from a USB memory.

Set Default

Restore of the instrument settings to the default values that can be found in the Technical manual. Note that default values may differs from the setting that where in the instrument at delivery.

All Zero correction values, Levels, Setpoints, Accumulated weights, Batched weight etc. will be set to zero when executing a default set-up.

Instrument Restart

With the Instrument Restart function it is possible to force the instrument to make complete restart (corresponding to a power down – power up cycle). This must be used with great caution. The user must make sure that no hazardous situation will occur.

To use the Instrument Restart function requires either a Set-up Code or an Operator Code if a lock is activated.

Note that the Instrument Restart function can be used even if a remote user has exclusive access to parameter editing or maintenance functions. The purpose of this is to be able to resolve a blocking between local and remote user.

When the user have selected the Instrument Restart function and entered a possible Code he will be asked: "Restart the Instrument?" If pressing the Yes button a warning message is displayed. Clicking Yes will make the instrument restart.

After a short time the instrument will be in operation again.

Program upgrade

This section describes how to upgrade the software of the instrument. Software is the embedded program running on the G5 instrument. Software is sometimes also referred to as firmware. To verify which software version is installed in the instrument go to **Main Menu – System Information** and read the number after the header Software version. The software version consists of three numbers where the first is the program number i.e. the type of function the instrument has. A number 1 stands for the standard weighing functionality software. The second number is the major revision and the third is the minor revision.

A change in the major revision is means that there is a difference in functionality of the instrument that usually will affect the manual. A change in the minor revision is means that there is a no difference in functionality of the instrument, it will not affect the manual. A bug fix, an update of a text or similar would give only a minor revision change. Consult the change description in this manual to see what changes is done in the manual or the software.

System Information	10/02/2015 01:28 PM
CPU	
Serial Number:	15-0159
Hardware Version:	000001
Software Version:	1.0.0
Software Created:	Nov 1 2015 19:16:38
Bootloader Version:	1
Bootloader Date:	Jun 25 2015
Enter	Escape

System Information Screen

When it's verified that a software upgrade is needed place the G5Upgrd.fwp file on a micro SD-Card. The file is 1 – 2 Mbyte in size. Size depends on the actual software version to be installed. It's recommended that a backup is made before the software is upgraded.

Turn of the instrument and insert the SD-card. Make sure that the SD-card locks in position with a klick. It may be necessary to push the SD-card in using the finger nail or a small tool, preferably in plastic to have the card fully inserted.

Turn on instrument power and wait for the upgrade process to finish. This will take about 2 minutes. During the upgrade the LEDs will indicate the status and when a successful upgrade is finished the green LED will be lit. If the upgrade fails the red LED is lit. If the upgrade fails:

1. Try again by cycling the power.
2. Copy the file to the SD-Card and try upgrading.
3. Try a new SD-Card.
4. Contact your supplier.

After a successful upgrade, check that the correct software version is shown in **System Information**. If there are parameter errors correct them one by one or do a default set-up. Finally set-up the instrument as desired.

9. Troubleshooting

General

During installation and maintenance of the G5 Instrument, the sub menus **System Information** and **Maintenance / Diagnostics** can be useful for solving possible problems related to I/O modules, Ethernet, Serial Communication etc.

The instrument reports detected errors on the display. Error codes can also be read via communication.

When an error is detected for the scale, all digital outputs are set passive and the analog output is set to 0 V or 0 mA. The output signal 'In Process' is set passive if an error is detected. The optional fieldbus interface adapters have LED's for indication of status.

Error codes

This part provides explanations of the error codes.

Some errors are displayed on the instrument display, containing a description of the error and the error code.

Reading error codes is done by Modbus and by the optional Fieldbus. Error code registers are **Instrument error**, **Command error** and **Scale Error code** (see chapter **Communication**).

The error codes are divided in four groups, depending on their origin:

- **Weight errors** occur when transducer signals or weight values go out of given ranges.
- **Start-up errors** occur only during start-up.
- **General errors** usually occur due to faulty entries from the front panel, alternatively invalid data or not allowed commands from the control unit.
- **Set-up errors** can only occur during instrument set-up.

On the following pages a summary of all error codes is given (note that code 000 always means 'no error').

Note that there are some error codes of internal type not described below. If an error code is displayed that is not listed below try restarting the instrument and if the error persists please contact your supplier.

Weight errors

The indication is either temporary or stays on until the cause is cured.

Error code	Explanation
000	No error. The instrument is in 'normal state' and no error is detected.
003	Instrument not in normal state. Weight is not valid.
004	Overload Overload means that the weight exceeds the highest allowed limit that is specified in the set-up parameters Overload check and Overload limit .
005	Over range Over range means that the input signal from the transducer exceeds the operating range.
006	Underload Underload means that the weight is below the lowest allowed limit that is specified in the set-up parameters Overload check and Overload limit .
007	Under range Under range means that the input signal from the transducer is below the operation range.
010	Excitation short-circuit A short-circuit in the excitation circuit or too many transducers connected. (A fault in a transducer or inside the instrument is also possible.) Check transducer connections. See chapter Installation and Technical Data .
011	Sense voltage error The sense voltage is out of range. Check transducer connections. See chapter Technical Data .
012	Transducer signal error The input signal is out of range, for example due to a faulty or missing transducer connection. (A fault in a transducer or inside the instrument is also possible.) Check transducer connections. See chapter Technical Data .
014	Invalid input signal Invalid input signal is reported while the instrument is waiting for sufficient conversion data to calculate a valid weight value. This indication is reported during power-up and after changing the filter settings since input value might be momentarily unreliable.
015	AD Converter error There is a hardware failure in the ADC circuits. Try restarting instrument or return the instrument for service.
020, 191	Too many digits The actual weight value with the configured number of decimals is exceeding 6 digits.

Start-up errors

These error codes can only appear during start-up.

Error code	Explanation
080	<p>Set up version error</p> <p>The set-up parameters stored do not match the current program Contact your supplier.</p>
081	<p>Set-up data error</p> <p>Indicates faulty set-up. Enter set-up mode, perform the necessary editing and save the new parameter settings or use the Set Default Values function (Maintenance menu).</p>
082	<p>Production parameter error</p> <p>One or several production parameter is corrupt. Return the instrument for service. This is a fatal error.</p>
083	<p>Wrong type of Fieldbus Module</p> <p>The fieldbus module in the instrument doesn't correspond to the set-up. Correct the set-up or change module.</p>
084	<p>No Fieldbus Module</p> <p>There is no fieldbus module installed in the instrument but the set-up indicates there should be a fieldbus module. Correct the set-up or install the desired module.</p>
085	<p>Fieldbus Module Error</p> <p>There is some kind of error when configuring the fieldbus module. Check the status LED's on the module, check that the set-up corresponds to the network configuration, baud rate, addresses etc.</p>

General errors

These errors generally occur due to faulty entries from the front panel, alternatively invalid data or not allowed commands from the control unit.

Error code	Explanation
076	<p>Power Fail detected</p> <p>The instrument have detected that the supply voltage is too low and enters a power fail state. Weight values etc. are invalid in this state. Power fail state last a short moment until power is completely lost. If this state continues more than a moment it might be due to a low input voltage (below specifications).</p>
100	<p>Instrument in wrong state</p> <p>The transmitted command is not applicable to the present instrument mode.</p>
101	<p>Too high value!</p> <p>Value over allowed range. Compare with restrictions for the parameter.</p>
102	<p>Too low value!</p> <p>Value under allowed range. Compare with restrictions for the parameter.</p>
103	<p>Illegal start address.</p> <p>Illegal Modbus start address, when writing data to the G5 instrument.</p>
104	<p>Illegal number of registers.</p> <p>Illegal number of Modbus registers, when writing data to G5 instrument.</p>
105	<p>Faulty value</p> <p>The value not accepted when entering a parameter from front panel or illegal data in modbus registers, when writing data to the G5 instrument.</p>
106	<p>Previous command not ready</p> <p>The previous command is not finished. Wait until pending command is finished and send the command again. This error code will only be given via communication.</p>
110	<p>Unstable weight.</p> <p>Zero setting always requires a stable weight on the scale. If motion check is set to ON, also taring and printing of weight values require a stable weight on the scale. Consequently, if you try to transmit a command for zero setting, taring, or printing of weight value without awaiting a stable weight you will receive this error code.</p>
111	<p>Taring not allowed (negative gross weight).</p> <p>Taring is not allowed at negative gross weight if parameter 'Overload check' is set to Unipolar.</p>
112	<p>Instrument in net mode.</p> <p>Zero setting requires that the instrument is in gross mode. However, if you try to transmit a zero setting command while the scale is in net mode you'll receive this error code.</p>

Error code	Explanation
113	<p>Outside zero setting limits.</p> <p>Adjustment of the zero setting during operation is only possible if the accumulated correction required is within -1% to +3% of the capacity set-up.</p> <p>Consequently, if you transmit a zero setting command while the required adjustment is outside allowed range you will receive this error code.</p>
114	<p>Setpoint(s) not in use.</p> <p>Activation/Deactivation of setpoint(s) cannot be done, as at least one of setpoint source is set to 'not in use'.</p>
115	<p>Weight below min weight for printing</p> <p>The weight is below the lowest allowed for printing. The low limit is set by parameter 'Min. Weight Print'. See chapter Set-up.</p>
116	<p>Net mode not allowed.</p> <p>Net weight cannot be shown when the tare value equals 0.</p>
117	<p>Flow display not allowed.</p> <p>Flow rate is not enabled.</p>
118	<p>Zero setting not allowed.</p> <p>Zero setting is not allowed when the calibration menu is displayed for the actual scale.</p>
122	<p>Printer buffer overflow.</p> <p>Communication print command error response. Given when the printer buffer for a used port is full. The current communication set-up and possibly the printer cannot handle the amount of print commands that been issued (during a limited time) over communication, print button and digital inputs totally.</p>
123	<p>Printing error.</p> <p>Communication print command error response. There is an undefined internal error regarding printer handling. Try the command again or restart the instrument. Contact your supplier if the error persists.</p>
240	<p>Fieldbus command error.</p> <p>Command error response on fieldbus connection. Indicates that the command sent to the G5 instrument via the fieldbus connection could not be executed.</p>
249	<p>Internal Timeout</p> <p>A timeout occurred when the program tried to access some internal resources. If this error occurs when a command is sent to the instrument, try the command again.</p> <p>Restart the instrument or contact the supplier if the error persists.</p>

Set-up errors

These errors occur only during instrument set-up from the front panel.

Certain errors depend on more than one set-up parameter and it is the operator's responsibility to locate and correct all faulty set-up parameters.

Error code	Explanation
151	<p>Weight error</p> <p>The weight is not valid during calibration. Check the live weight and input signal at the bottom of the display in calibration menus.</p>
152	<p>Unstable transducer signal used</p> <p>This is not an error but only a warning. The weight was not stable during calibration which might reduce the accuracy of the calibration. Wait a little longer and try again. If the problem persists, check the mechanical and electrical stability of the installation, check the live weight and input signal at the bottom of the display in calibration menus.</p>
153	<p>Capacity/Resolution > 6 digits</p> <p>The Capacity value has more than the permitted 6 digits. Select a combination of Resolution and Capacity that will result in max. 6 digits plus decimal point.</p>
155	<p>Illegal calibration direction</p> <p>All weights with corresponding mV/V values must be increasing for increasing calibration point number.</p>
156	<p>Calibration not finished (all calibration points not stored)</p> <p>This warning is given if the user is leaving the calibration menu when a dead weight calibration is started but not all calibration points are stored. The user will have the possibility to continue calibration, leave the menu and discard all calibration changes or leave the calibration menu and keep the calibration changes done so far. Note that leaving an unfinished calibration might give a faulty calibration of the scale.</p>
157	<p>The flow rate derivation time is changed by the instrument</p> <p>This is a warning that the flow rate derivation time has been changed automatically. It can be changed if Filter bandwidth is changed or if Auto Derivation Time is On also when changing parameters Flow Rate Unit or Flow rate resolution.</p>
158	<p>Wrong program option code.</p> <p>The entered program option code is not valid. Check that the code is correctly entered, that the code is intended for the used S/N (See menu System Info) and that the used program version is correct (i.e. a program that includes the program option desired, see menu System Info).</p>
159	<p>Not allowed to turn the program option Off.</p> <p>It is not allowed to turn off the program option in the current situation.</p>
160	<p>Not allowed to change set-up parameter</p> <p>It is not allowed to change this parameter in the current situation. This may be due to e.g. that calibration is in progress, due to some settings etc. Check the description of the current parameter.</p>

Error code	Explanation
190	Zero track rate too high The zero-track rate is too high. Select a lower zero track rate.
192	Too high transducer signal in calibration point 2 The mV/V signal in calibration point two is too high (often due to a previous, strange data sheet calibration).
193	Too high transducer signal in calibration point 2 The mV/V signal in calibration point 2 is too high, due to strange data sheet calibration. The conversion factor, rated load etc. does not correspond to each other.
194	Illegal calibration direction All weights with corresponding mV/V values must be increasing for increasing calibration point number.

Document no. 35231
Publication no. 601 388 R0
© Vishay Nobel AB, 2015-12-22
Subject to changes without notice.

Vishay Nobel AB
Box 423, SE-691 27 Karlskoga, Sweden
Phone +46 586 63000 · Fax +46 586 63099
blhnobel.se@vpgsensors.com
www.blhnobel.com

BLH
3 Edgewater Drive, Norwood, MA 02062, USA
Phone: 781-298-2200 Fax: 781-762-3988
blhnobel.usa@vpgsensors.com
www.blhnobel.com