

# Strain Gage Accessories

Databook



Adhesives  
Protective Coatings  
Surface Cleaning  
Installation Tools

Bondable Terminals  
Wire and Cable  
Application Kits  
Solder and Flux



# Strain Gage Accessories

**Micro-Measurements**

P.O. Box 27777

Raleigh, NC 27611

U.S.A.

PH: +1-919-365-3800

FAX: +1-919-365-3945

**[www.micro-measurements.com](http://www.micro-measurements.com)**

## Disclaimer

ALL PRODUCTS, PRODUCT SPECIFICATIONS AND DATA ARE SUBJECT TO CHANGE WITHOUT NOTICE.

Vishay Precision Group, Inc., its affiliates, agents, and employees, and all persons acting on its or their behalf (collectively, "VPG"), disclaim any and all liability for any errors, inaccuracies or incompleteness contained herein or in any other disclosure relating to any product.

The product specifications do not expand or otherwise modify VPG's terms and conditions of purchase, including but not limited to, the warranty expressed therein.

VPG makes no warranty, representation or guarantee other than as set forth in the terms and conditions of purchase. **To the maximum extent permitted by applicable law, VPG disclaims (i) any and all liability arising out of the application or use of any product, (ii) any and all liability, including without limitation special, consequential or incidental damages, and (iii) any and all implied warranties, including warranties of fitness for particular purpose, non-infringement and merchantability.**

Information provided in datasheets and/or specifications may vary from actual results in different applications and performance may vary over time. Statements regarding the suitability of products for certain types of applications are based on VPG's knowledge of typical requirements that are often placed on VPG products. It is the customer's responsibility to validate that a particular product with the properties described in the product specification is suitable for use in a particular application. You should ensure you have the current version of the relevant information by contacting VPG prior to performing installation or use of the product, such as on our website at [vpgsensors.com](http://vpgsensors.com).

No license, express, implied, or otherwise, to any intellectual property rights is granted by this document, or by any conduct of VPG.

The products shown herein are not designed for use in life-saving or life-sustaining applications unless otherwise expressly indicated. Customers using or selling VPG products not expressly indicated for use in such applications do so entirely at their own risk and agree to fully indemnify VPG for any damages arising or resulting from such use or sale. Please contact authorized VPG personnel to obtain written terms and conditions regarding products designed for such applications.

Product names and markings noted herein may be trademarks of their respective owners.

**STRAIN GAGE ACCESSORIES**

Table of Contents ..... 3  
Alphanumeric Index ..... 7

**GENERAL INFORMATION AND SELECTION GUIDE** ..... 10

**SURFACE CLEANING SUPPLIES**

CSM-3 Degreaser..... 14  
GC-6 Isopropyl Alcohol ..... 14  
MCA-1 Conditioner A ..... 14  
MCA-2 Conditioner A (bulk) ..... 14  
MN5A-1 Neutralizer 5A ..... 14  
MN5A-2 Neutralizer 5A (bulk) ..... 14  
SCP-1 220-Grit Wet-or-Dry Silicon-Carbide Paper ..... 15  
SCP-2 320-Grit Wet-or-Dry Silicon-Carbide Paper ..... 15  
SCP-3 400-Grit Wet-or-Dry Silicon-Carbide Paper ..... 15  
GC-5 Pumice Powder ..... 15  
TEC-1 Tetra-Etch® Compound..... 15  
CSP-1 Cotton Tip Swabs ..... 15  
GSP-1 Gauze Sponges ..... 15

**STRAIN GAGE ADHESIVES AND CEMENTS**

General Information and Selection Chart ..... 18  
M-Bond 200 Cyanoacrylate ..... 20  
M-Bond AE-10 Two-Component, 100%-Solids Epoxy ..... 21  
M-Bond GA-2 Two-Component, Partially-Filled, 100%-Solids Epoxy..... 22  
RTC-2 Epoxy General-Purpose Epoxy..... 23  
M-Bond A-12 Two-Component, 100%-Solids Epoxy ..... 24  
M-Bond AE-15 Two-Component, 100%-Solids Epoxy ..... 25  
M-Bond GA-61 Two-Component, Partially-Filled, 100%-Solids Epoxy..... 26  
EpoxyLite 813 Two-Component, 100%-Solids Epoxy ..... 27  
EPY-500 Two-Component, Filled Epoxy, Bi-Pack ..... 28  
QA-500 Two-Component, Filled Epoxy, Bi-Pack ..... 29  
M-Bond 610 Two-Component, Solvent-Thinned, Epoxy-Phenolic ..... 30  
M-Bond 600 Two-Component, Solvent-Thinned, Epoxy-Phenolic..... 32  
M-Bond 43-B Single-Component, Solvent-Thinned Epoxy ..... 33  
M-Bond 450 Two-Component, Solvent-Thinned Epoxy..... 34  
Denex #3 Single-Component, Solvent-Thinned Epoxy ..... 35  
P Adhesive Two-Component, Solvent-Thinned, Polyimide ..... 36  
M-Bond 300 Two-Component, Polyester ..... 37  
NCC-3 Single-Component, Ceramic Cement ..... 38  
WC-16 Single-Component, Ceramic Cement..... 39  
HG-1 Single-Component, Ceramic Cement..... 40  
GC Single-Component, Ceramic Cement..... 41  
H Cement Single-Component, Ceramic Cement..... 42  
PBX Two-Component, Ceramic Cement ..... 43  
Sauereisen DKS-8 Single-Component, Inorganic, Zircon-Based Cement ..... 44

**INSTALLATION TOOLS AND ACCESSORIES**

SSH-1 Surgical Shears..... 46  
STW-1 Tweezers, Ground, Sharp Ends ..... 46  
BTW-1 Tweezers, Flat, Blunt Ends ..... 46  
DPR-1 Dental Probe ..... 46  
SSC-1 Surgical Scapel and Blades ..... 46  
SSC-2 Replacement Scapel Blades ..... 46  
SSS-1 Steel Scale (Inches) ..... 46  
SSS-2 Steel Scale (Inches and Millimeters) ..... 46  
DP-1 4-H Drafting Pencil..... 46  
DWC-1 Diagonal Cutters ..... 46  
NNP-1 Needle-Nosed Pliers ..... 46  
ATS-2 Gage Application Tool Set ..... 46  
GT-11 Camel's Hair Brush ..... 47  
SPT-1 Stainless Steel Mixing Spatula, Double Blade ..... 47  
SPT-2 Stainless Steel Mixing Spatula, Single Blade ..... 47  
MHG-1 Master Mite Heat Gun, 120 Vac ..... 47  
MHG-2 Master Mite Heat Gun, 240 Vac ..... 47  
PCT-2M Gage Installation Tape ..... 47

PDT-3	Paper Drafting Tape .....	47
PLY-001	Kapton® Film .....	47
MJG-2	Mylar® Tape .....	48
TFT-2	Thermosetting Fiberglass Tape .....	48
FGC-1	Woven Fiberglass Cloth .....	48
TFE-2	High-Modulus TFE Teflon® with Silicone Mastic .....	48
HSC-1	Spring Clamp .....	48
HSC-2	Spring Clamp .....	48
HSC-3	Spring Clamp .....	48
GT-12	Neg'ator Constant Force Extension Spring Clamp .....	48
TFE-1	Teflon Film .....	48
GT-14	Pressure Pads and Backup Plates .....	48
SGP-1	Silicone Rubber .....	48
SGP-2	Silicone Rubber .....	48
<b>BONDABLE TERMINALS</b>		
CEG-25C	Copper Foil, Epoxy-Glass Laminate Backing .....	50
CPF-25C	Copper Foil, Polyimide Film Backing .....	50
CEG-38C	Copper Foil, Epoxy-Glass Laminate Backing .....	50
CPF-38C	Copper Foil, Polyimide Film Backing .....	50
CEG-50C	Copper Foil, Epoxy-Glass Laminate Backing .....	50
CPF-50C	Copper Foil, Polyimide Film Backing .....	50
CEG-75C	Copper Foil, Epoxy-Glass Laminate Backing .....	50
CPF-75C	Copper Foil, Polyimide Film Backing .....	50
CEG-100C	Copper Foil, Epoxy-Glass Laminate Backing .....	50
CPF-100C	Copper Foil, Polyimide Film Backing .....	50
CEG-150C	Copper Foil, Epoxy-Glass Laminate Backing .....	50
CPF-150C	Copper Foil, Polyimide Film Backing .....	50
CEG-50D	Copper Foil, Epoxy-Glass Laminate Backing .....	51
CPF-50D	Copper Foil, Polyimide Film Backing .....	51
CEG-60D	Copper Foil, Epoxy-Glass Laminate Backing .....	51
CPF-60D	Copper Foil, Polyimide Film Backing .....	51
CEG-75D	Copper Foil, Epoxy-Glass Laminate Backing .....	51
CPF-75D	Copper Foil, Polyimide Film Backing .....	51
CEG-100D	Copper Foil, Epoxy-Glass Laminate Backing .....	51
CPF-100D	Copper Foil, Polyimide Film Backing .....	51
CPF-AST	Copper Foil, Polyimide Film Backing Assortment .....	51
CEG-21S	Copper Foil, Epoxy-Glass Laminate Backing .....	51
CEG-42S	Copper Foil, Epoxy-Glass Laminate Backing .....	51
CEG-63S	Copper Foil, Epoxy-Glass Laminate Backing .....	51
CEG-83S	Copper Foil, Epoxy-Glass Laminate Backing .....	51
<b>SOLDERS AND ACCESSORIES</b>		
361A-20R	Tin-Lead-Antimony Solder .....	54
361-40R	Tin-Lead Solder .....	54
430-20S	Tin-Silver Solder .....	54
450-20R	Tin-Antimony Solder .....	54
450-20S	Tin-Antimony Solder .....	54
570-28R	Lead-Tin-Silver Solder .....	54
1240-FPA	Silver-Zinc-Copper-Nickel Solder .....	54
FAR-2	Rosin Flux Kit .....	55
AR-2	Flux (Bulk) .....	55
RSK-1	Rosin Solvent Kit .....	55
RSK-2	Rosin Solvent (Bulk) .....	55
RSK-4	Rosin Solvent Kit .....	55
FSS-1	Flux Kit .....	55
M5S-1	Mark V Soldering Station, Soldering Pencil, and Type A Chisel Tip .....	55
M5S-2	Mark V Control Unit Only .....	55
M5S-4	Mark V Soldering Pencil and Type A Chisel Tip .....	55
M5S-4A	Mark V Type A Chisel Solder Tip .....	55
M5S-4B	Mark V Type B Conical Solder Tip .....	55
M5S-4C	Mark V Type C Chisel Solder Tip .....	55
M5S-4D	Mark V Type D Conical Solder Tip .....	55
M5S-4E	Mark V Type E Special Solder Tip .....	55
WRS-1	Resistance Soldering Unit, 110 VAC .....	56
WRS-2	Resistance Soldering Unit, 220 VAC .....	56
WRS-3	Replacement Electrodes .....	56

**WIRE, CABLE AND ACCESSORIES**

General Information and Selection .....	58
134-AWP Single-Conductor, Solid Wire .....	59
136-AWP Single-Conductor, Solid Wire .....	59
127-AWN Single-Conductor, Solid Wire .....	59
130-AWN Single-Conductor, Solid Wire .....	59
134-AWN Single-Conductor, Solid Wire .....	59
136-AWN Single-Conductor, Solid Wire .....	59
127-AWQ Single-Conductor, Solid Wire .....	59
130-AWQ Single-Conductor, Solid Wire .....	59
134-AWQ Single-Conductor, Solid Wire .....	59
126-GWF Single-Conductor, Solid Wire .....	59
137-HWN Single-Conductor, Solid Wire .....	59
142-JWN Single-Conductor, Solid Wire .....	59
126-DWV Single-Conductor, Stranded Wire .....	59
126-FWK Single-Conductor, Stranded Wire .....	59
130-FWT Single-Conductor, Stranded Wire .....	59
322-DJV Three-Conductor Cable .....	60
326-DFV Three-Conductor Cable .....	60
330-DFV Three-Conductor Cable .....	60
326-BSV Three-Conductor Cable .....	60
326-DTV Three-Conductor Cable .....	60
326-DSV Three-Conductor Cable .....	60
330-FFE Three-Conductor Cable .....	60
330-FJT Three-Conductor Cable .....	60
336-FTE Three-Conductor Cable .....	60
326-FTE Three-Conductor Cable .....	60
330-FTE Three-Conductor Cable .....	60
326-GJF Three-Conductor Cable .....	60
426-DFV Four-Conductor Cable .....	61
430-DFV Four-Conductor Cable .....	61
422-DSV Four-Conductor Cable .....	61
424-DSV Four-Conductor Cable .....	61
426-BSV Four-Conductor Cable .....	61
426-DTV Four-Conductor Cable .....	61
430-FST Four-Conductor Cable .....	61
426-FTE Four-Conductor Cable .....	61
436-FTT Four-Conductor Cable .....	61
426-FFT Four-Conductor Cable .....	61
1-GL-64-001 Flat Ribbon Lead (Uninsulated) .....	61
1-KL-16-002 Flat Ribbon Lead (Uninsulated) .....	61
1-KL-08-003 Flat Ribbon Lead (Uninsulated) .....	61
1-KL-08-005 Flat Ribbon Lead (Uninsulated) .....	61
HST-1 Heat-Shrinkable Wire Splice Sealant .....	62
WTS-1 Thermal Wire Stripper, 110 VAC .....	62
WTS-2 Thermal Wire Stripper, 220 VAC .....	62
WTS-A Replacement Elements .....	62

**PROTECTIVE COATINGS**

General Information .....	64
M-Coat A Solvent-Thinned (Xylene) Polyurethane .....	66
M-Coat B Solvent-Thinned (MEK) Nitrile Rubber .....	67
M-Coat C Solvent-Thinned (Naphtha) RTV Silicone Rubber .....	68
M-Coat D Solvent-Thinned (Toluene) Acrylic .....	69
M-Coat F Kit of Materials for Environmental and Mechanical Protection .....	70
M-Coat FBT Solvent-Thinned Butyl Rubber .....	71
M-Coat JA Two-Part Polysulfide .....	72
M-Coat W-1 Microcrystalline Wax .....	73
3140 RTV Single-Component RTV Silicone Rubber .....	74
3145 RTV Single-Component RTV Silicone Rubber .....	75
M-Bond AE-10 Two-Component, 100%-Solids Epoxy used as Protective Coating .....	76
M-Bond AE-15 Two-Component, 100%-Solids Epoxy used as Protective Coating .....	76
M-Bond 43-B Single-Component, Solvent-Thinned Epoxy used as Protective Coating .....	77
M-Bond GA-61 Two-Component, Partially Filled, 100%-Solids Epoxy used as Protective Coating .....	78
Barrier E Single-Component, Neoprene Patch .....	79
Barrier WD Single-Component, Paste Wax .....	80

Gagekote #5	Single-Component, 100%-Solids Modified Polysulfide Epoxy .....	81
Gagekote #8	Single-Component, Transparent, Acrylic .....	82
Gagekote #11	Single-Component, Clear .....	83
<b>STRAIN GAGE APPLICATION KITS</b>		
GAK-2-200	Complete, with M-Bond 200 .....	86
GAK-2-AE-10	Complete, with M-Bond AE-10 .....	86
GAK-2-610	Complete, with M-Bond 610 .....	86
BAK-200	Basic, with M-Bond 200 .....	87
CEA-200	Complete, CEA Strain Gages with M-Bond 200 .....	87
MAK-1	Master Kit, with M-Bond 200, AE-10, and M-Bond 610 .....	88
<b>PRECISION RESISTORS</b>		
Specifications	.....	90
W-599880-02	Shunt Calibration/120-Ohm Gage Circuit .....	91
W-119880-02	Shunt Calibration/120-Ohm Gage Circuit .....	91
S-59880-01	Shunt Calibration/120-Ohm Gage Circuit .....	91
S-29880-01	Shunt Calibration/120-Ohm Gage Circuit .....	91
S-19880-01	Shunt Calibration/120-Ohm Gage Circuit .....	91
S-14880-01	Shunt Calibration/120-Ohm Gage Circuit .....	91
S-11880-01	Shunt Calibration/120-Ohm Gage Circuit .....	91
S-5880-01	Shunt Calibration/120-Ohm Gage Circuit .....	91
W-349650-02	Shunt Calibration/350-Ohm Gage Circuit .....	91
W-174650-02	Shunt Calibration/350-Ohm Gage Circuit .....	91
S-87150-01	Shunt Calibration/350-Ohm Gage Circuit .....	91
S-57983-01	Shunt Calibration/350-Ohm Gage Circuit .....	91
S-43400-01	Shunt Calibration/350-Ohm Gage Circuit .....	91
S-34650-01	Shunt Calibration/350-Ohm Gage Circuit .....	91
S-17150-01	Shunt Calibration/350-Ohm Gage Circuit .....	91
W-999000-02	Shunt Calibration/1000-Ohm Gage Circuit .....	91
W-499000-02	Shunt Calibration/1000-Ohm Gage Circuit .....	91
W-249000-02	Shunt Calibration/1000-Ohm Gage Circuit .....	91
W-165666-02	Shunt Calibration/1000-Ohm Gage Circuit .....	91
W-124000-02	Shunt Calibration/1000-Ohm Gage Circuit .....	91
S-99000-01	Shunt Calibration/1000-Ohm Gage Circuit .....	91
S-49000-01	Shunt Calibration/1000-Ohm Gage Circuit .....	91
S-50-01	Bridge Completion .....	91
S-60-01	Bridge Completion .....	91
S-100-01	Bridge Completion .....	91
S-120-01	Bridge Completion .....	91
S-175-01	Bridge Completion .....	91
S-240-01	Bridge Completion .....	91
S-350-01	Bridge Completion .....	91
S-500-01	Bridge Completion .....	91
S-1000-01	Bridge Completion .....	91
S-2000-01	Bridge Completion .....	91
S-5000-01	Bridge Completion .....	91
H-100-01	Bridge Completion .....	91
H-120-01	Bridge Completion .....	91
H-350-01	Bridge Completion .....	91
H-1000-01	Bridge Completion .....	91
<b>BRIDGE COMPLETION MODULES</b>		
MR1-350-127	.....	94
MR1-10C-129	.....	94
MR1-350-130	.....	94
MR2-350-128	.....	94
MR1-120-133	.....	94
<b>SPECIAL-PURPOSE EQUIPMENT</b>		
Model 1300	Gage Installation Tester .....	96
Model 700	Portable Strain Gage Welding and Soldering Unit .....	98
<b>TECHNICAL SUPPORT</b>		
Technical Information, Applications Support, and Training Programs .....		102



<b>PRODUCT</b>	<b>PAGE NO.</b>	<b>PRODUCT</b>	<b>PAGE NO.</b>
1-GL-64-001.....	61	CEG-100D .....	51
1-KL-08-003.....	61	CEG-150C .....	50
1-KL-08-005.....	61	CEG-21S .....	51
1-KL-16-002.....	61	CEG-25C .....	50
1240-FPA.....	54	CEG-38C .....	50
126-DWV .....	59	CEG-42S .....	51
126-FWK .....	59	CEG-50C .....	50
126-GWF .....	59	CEG-50D .....	51
127-AWN .....	59	CEG-60D .....	51
127-AWQ .....	59	CEG-63S .....	51
130-AWN .....	59	CEG-75C .....	50
130-AWQ .....	59	CEG-75D .....	51
130-FWT .....	59	CEG-83S .....	51
134-AWN .....	59	CPF-100C.....	50
134-AWP .....	59	CPF-100D.....	51
134-AWQ .....	59	CPF-150C.....	50
136-AWN .....	59	CPF-25C.....	50
136-AWP .....	59	CPF-38C.....	50
137-HWN.....	59	CPF-50C.....	50
142-JWN.....	59	CPF-50D .....	51
3140 RTV .....	74	CPF-60D .....	51
3145 RTV .....	75	CPF-75C.....	50
322-DJV.....	60	CPF-75D.....	51
326-BSV .....	60	CPF-AST .....	51
326-DFV .....	60	CSM-3.....	14
326-DSV .....	60	CSP-1.....	15
326-DTV .....	60	Denex #3 .....	35
326-FTE.....	60	DP-1 .....	46
326-GJF .....	60	DPR-1.....	46
330-DFV .....	60	DWC-1.....	46
330-FFE.....	60	EpoxyLite 813.....	27
330-FJT .....	60	EPY-500.....	28
330-FTE.....	60	FAR-2 .....	55
336-FTE .....	60	FGC-1.....	48
361-40R.....	54	FSS-1 .....	55
361A-20R .....	54	Gagekote #11 .....	83
422-DSV .....	61	Gagekote #5 .....	81
424-DSV .....	61	Gagekote #8 .....	82
426-BSV .....	61	GAK-2-200 .....	86
426-DFV .....	61	GAK-2-610 .....	86
426-DTV .....	61	GAK-2-AE-10 .....	86
426-FFT.....	61	GC .....	41
426-FTE.....	61	GC-5.....	15
430-20S.....	54	GC-6.....	14
430-DFV .....	61	GSP-1.....	15
430-FST.....	61	GT-11.....	47
436-FTT.....	61	GT-12.....	48
450-20R.....	54	GT-14.....	48
450-20S.....	54	H-100-01 .....	91
570-28R.....	54	H-1000-01 .....	91
AR-2 .....	55	H-120-01 .....	91
ATS-2.....	46	H-350-01 .....	91
BAK-200 .....	87	H Cement .....	42
Barrier E .....	79	HG-1.....	40
Barrier WD .....	80	HSC-1.....	48
BTW-1 .....	46	HSC-2.....	48
CEA-200 .....	87	HSC-3.....	48
CEG-100C.....	50	HST-1.....	62

<b>PRODUCT</b>	<b>PAGE NO.</b>	<b>PRODUCT</b>	<b>PAGE NO.</b>
M-Bond 200 .....	20	S-100-01 .....	91
M-Bond 300 .....	37	S-1000-01 .....	91
M-Bond 43-B .....	33	S-11880-01 .....	91
M-Bond 43-B .....	77	S-120-01 .....	91
M-Bond 450 .....	34	S-14880-01 .....	91
M-Bond 600 .....	32	S-17150-01 .....	91
M-Bond 610 .....	30	S-175-01 .....	91
M-Bond A-12.....	24	S-19880-01 .....	91
M-Bond AE-10 .....	21	S-2000-01 .....	91
M-Bond AE-10 .....	76	S-240-01 .....	91
M-Bond AE-15 .....	25	S-29880-01 .....	91
M-Bond AE-15 .....	76	S-34650-01 .....	91
M-Bond GA-2 .....	22	S-350-01 .....	91
M-Bond GA-61 .....	26	S-43400-01 .....	91
M-Bond GA-61 .....	78	S-49000-01 .....	91
M-Coat A.....	66	S-50-01 .....	91
M-Coat B .....	67	S-500-01 .....	91
M-Coat C.....	68	S-5000-01 .....	91
M-Coat D.....	69	S-57983-01 .....	91
M-Coat F.....	70	S-5880-01 .....	91
M-Coat FBT.....	71	S-59880-01 .....	91
M-Coat JA .....	72	S-60-01 .....	91
M-Coat W-1.....	73	S-87150-01 .....	91
M5S-1 .....	55	S-99000-01 .....	91
M5S-2.....	55	Sauereisen DKS-8 .....	44
M5S-4.....	55	SCP-1.....	15
M5S-4A .....	55	SCP-2.....	15
M5S-4B .....	55	SCP-3.....	15
M5S-4C.....	55	SGP-1.....	48
M5S-4D.....	55	SGP-2.....	48
M5S-4E .....	55	SPT-1.....	47
MAK-1 .....	88	SPT-2.....	47
MCA-1 .....	14	SSC-1.....	46
MCA-2 .....	14	SSC-2.....	46
MHG-1 .....	47	SSH-1 .....	46
MHG-2.....	47	SSS-1 .....	46
MJG-2.....	48	SSS-2 .....	46
MN5A-1 .....	14	STW-1 .....	46
MN5A-2 .....	14	TEC-1 .....	15
Model 1300 .....	96	TFE-1.....	48
Model 700 .....	98	TFE-2.....	48
MR1-10C-129.....	94	TFT-2 .....	48
MR1-120-133 .....	94	W-119880-02 .....	91
MR1-350-127 .....	94	W-124000-02 .....	91
MR1-350-130 .....	94	W-165666-02 .....	91
MR2-350-128 .....	94	W-174650-02 .....	91
NCC-3 .....	38	W-249000-02 .....	91
NNP-1.....	46	W-349650-02 .....	91
P Adhesive .....	36	W-499000-02 .....	91
PBX.....	43	W-599880-02 .....	91
PCT-2M .....	47	W-999000-02 .....	91
PDT-3.....	47	WC-16 .....	39
PLY-001 .....	47	WRS-1 .....	56
QA-500.....	29	WRS-2 .....	56
RSK-1 .....	55	WRS-3 .....	56
RSK-2 .....	55	WTS-1 .....	62
RSK-4 .....	55	WTS-2 .....	62
RTC-2 Epoxy .....	23	WTS-A.....	62

General Information and  
Selection Guide ..... 10

# General Information and Selection Guide

## General Information and Selection Guide

This databook describes a wide range of accessories used for installation of electrical resistance strain gages. These accessories have been developed and selected specifically for their effectiveness and ease of use in making strain gage installations. They have also been carefully tested for their reliability and consistency of properties. The range of products offered in this catalog covers the full spectrum of typical gage installation requirements.

Making accurate and reliable strain gage measurements does not depend on the quality of the strain gage alone. The gage can perform to its fullest potential only if the installation is of comparable quality. To accomplish, this requires strict adherence to the recommended installation procedure, including use of the proper accessory tools and supplies.

As shown in the accompanying diagram, there are three principal components in every strain gage installation: 1) the strain gage, 2) the tools, materials, and supplies (accessories) used in installing the gage, and 3) the techniques employed in performing the installation. The well-documented formula for making consistently successful strain gage installations is simple—

- select high-quality, precision strain gages.
- select professional-caliber accessories, laboratory- and field-proven for effectiveness and compatibility with the strain gages.
- pay careful attention to the installation procedures recommended by the manufacturer of the gages and accessories.

There are, as indicated by the double-ended arrows in the diagram, three sets of interface reactions—between the gage and accessories, between the gage and application techniques, and between the accessories and installation procedures.

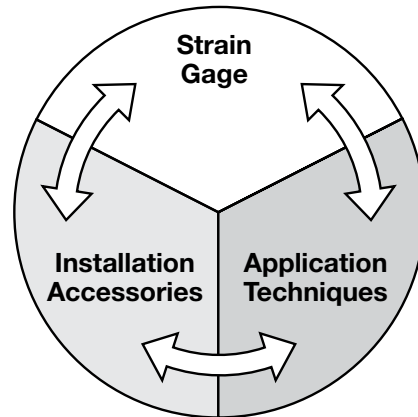

**COMPONENTS OF A  
STRAIN GAGE INSTALLATION**

Because technique is such an important ingredient in strain gage installation, Micro-Measurements accessories are accompanied by detailed instructions, where needed, for their proper use. The importance of attention to detail, and of precise adherence to the application instructions supplied, cannot be overemphasized when installing strain gages.

Additionally, to help ensure your success in installing strain gages, we maintain an experienced and highly trained Applications Engineering staff. Our Applications Engineers are as close as your telephone. We urge you to call them for recommendations in the strain gage/ accessory selection process, installation technique, or to discuss any problems you may encounter when using our products.



**General Information and Selection Guide**

When a decision is made to conduct a strain gage test, proper selection of the appropriate accessories is most important to achieve high-quality installation of the strain gage. The chart below can be used as a guide to help in the selection process.

For your convenience in quickly locating a particular accessory, this databook is divided into sections by type of accessory (i.e., adhesives, soldering supplies, wire, etc.). In addition, the order of the sections in the catalog corresponds generally to the order of accessory use in making a strain gage installation. Thus, the first section is devoted to surface cleaning materials, the second to adhesives, and so on. Also included is information on other Micro-Measurements products that are very useful

for strain gage installation and testing. These include precision resistors, a gage installation tester, and a portable welder for installing weldable strain gages.

Each product entry includes both the product description and its stock designation. Product selection guides and recommendations are also provided where applicable.

Remember, your success in making reliable strain gage installations is important to us. Whenever you encounter any difficulty in the installation process, or are unsure of selecting the proper accessories for a given application, call, fax, or email our Applications Engineering Department for assistance.

<b>PLANNING FOR RELIABLE STRAIN GAGE INSTALLATIONS</b>	
<b>SEQUENCE</b>	<b>RELEVANT QUESTIONS AND CONSIDERATIONS</b>
<b>DEFINE THE TEST CONDITIONS</b>	Static or dynamic? Operating temperature range? Environment? Test duration? Measurement accuracy? Material properties of test part? Type of stress field and strain gradient?
<b>SELECT THE STRAIN GAGE</b>	Consult Tech Note TN-505, "Strain Gage Selection—Criteria, Procedures, Recommendations" and Data Book DB0103, "Precision Strain Gages".
<b>SELECT THE SURFACE CLEANING SUPPLIES</b>	Type of material and surface conditions of test part? Preparation time? Mechanical tools required? Limitations on material removal?
<b>SELECT THE ADHESIVE</b>	Compatibility with gage backing and test part material? Temperature (installing and test)? Fatigue life? Elongation capabilities? Strain levels expected? Clamping accessibility?
<b>SELECT THE INSTALLATION TOOLS</b>	Room-temperature or elevated-temperature installation? Gage location accessibility? Protective coating requirements?
<b>SELECT THE TERMINALS</b>	Leadwire system to be employed? Backing material? Size?
<b>SELECT THE SOLDER AND LEADWIRE</b>	Temperature (installing and test)? Mechanical strength? Gage factor desensitization? Bridge configuration? Corrosion? Electrostatic/Electromagnetic fields?
<b>SELECT THE PROTECTIVE COATING</b>	Environmental survival: Temperature range, mechanical abrasion, chemical attack, pressure, etc., and ability to cure in installation environment? Reinforcement?
<b>PROCEED WITH THE INSTALLATION</b>	

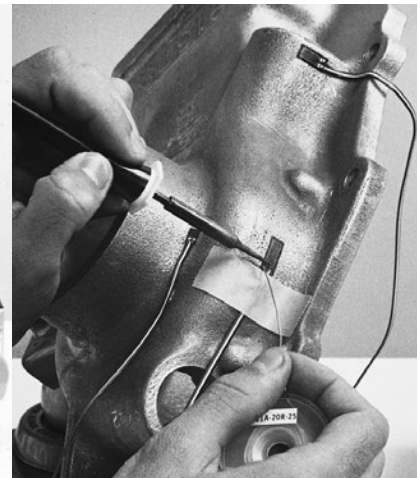



# Surface Cleaning Supplies

## CONTENTS

### Solvent Cleaners

CSM-3 .....	14
GC-6 .....	14

### Water-Based Cleaners

MCA-1 .....	14
MCA-2 (bulk) .....	14
MN5A-1 .....	14
MN5A-2 (bulk) .....	14

### Surface Abrasion Materials

SCP-1 .....	15
SCP-2 .....	15
SCP-3 .....	15
GC-5 .....	15

### Special-Purpose Materials

TEC-1 .....	15
CSP-1 .....	15
GSP-1 .....	15

## General Information and Selection

### MATERIALS LIST

- Solvent cleaners
- Water-based cleaners
- Surface-abrasion materials
- Special-purpose materials

### DESCRIPTION

For proper bonding of strain gages and temperature sensors, the workpiece surface must be chemically clean and totally free of contaminants before applying the adhesive. Recommended surface cleaning procedures for all common structural materials are described in Instruction Bulletin B-129, "Surface Preparation for Strain Gage Bonding".

In the case of steel and aluminum parts with finish-machined or formed surfaces, the surface cleaning procedure can be summarized briefly as follows:

1. Removal of oily contaminants with a solvent cleaner.  
Note: Immersion of the workpiece in a degreaser is, by itself, inadequate; and, if done as a preliminary step, must be followed by cleaning with an uncontaminated solvent (one which is never returned to the container or otherwise reapplied after contact with the workpiece).
2. Light abrasion in the presence of a mildly acidic wash, to dislodge and remove oxides and mechanically bound contaminants.



3. Thorough surface scrubbing with an alkaline solution, to finish the cleaning process and leave the surface at the appropriate pH level for optimum bonding.

When the cleaning procedure is performed strictly according to the instructions in Instruction Bulletin B-129, and when the proper high-quality cleaning agents are used, the surface will be left in a condition best suited for bonding.

Following is a complete assortment of cleaning supplies, selected specifically for surface preparation in the installation of strain gages and bondable temperature sensors.

SOLVENT CLEANERS	
MODEL/PART NO.	TYPE/DESCRIPTION
CSM-3	<b>Degreaser:</b> A powerful environmentally friendly degreaser. Readily attacks general-purpose lubricating and hydraulic oils. 20-oz (0.56-kg) pressured spray can. Dispensing solvents from "one way" containers prevents contamination buildup. Two-year shelf life.
GC-6	<b>Isopropyl Alcohol:</b> Frequently used as a solvent degreaser where other solutions are restricted, such as with most plastics. Flammable. 4-oz (120-ml) bottle.

WATER-BASED CLEANERS	
Final surface preparation for most materials is accomplished with M-Prep Conditioner A immediately followed by M-Prep Neutralizer 5A.	
MODEL/PART NO.	TYPE/DESCRIPTION
<b>CONDITIONER A:</b> A mild phosphoric-acid compound. Acts as a mild etchant and accelerates the cleaning process. Shelf Life: 1 year at +75°F (+24°C).	
MCA-1	2-oz* (60-ml) plastic squeeze bottle with on/off dispenser nozzle cap.
MCA-2	Same as MCA-1 except 16 oz (0.5 l).
MCA-3	Same as MCA-1 except 32 oz (0.95 l).
<b>NEUTRALIZER 5A:</b> An ammonia-based material. Neutralizes any chemical reaction introduced by Conditioner A, and produces optimum surface conditions for most strain gage adhesives. Shelf Life: 1 year at +75°F (+24°C).	
MN5A-1	2-oz* (60-ml) plastic squeeze bottle with on/off dispenser nozzle bottle cap.
MN5A-2	Same as MN5A-1 except 16 oz (0.5 l).
MN5A-3	Same as MN5A-1 except 32 oz (0.95 l).

\*Note: The 2-oz (60-ml) size is recommended for bench use and is easily refilled from the 16-oz (0.5-l) bottle.



General Information and Selection

<b>SURFACE-ABRASION MATERIALS</b>	
Abrading is often necessary to dislodge contaminants and to remove rust, scale, etc. When grit-blasting is necessary, use fine alumina powder and high-quality filters, and never recycle used grit. In general, wet-or-dry silicon-carbide paper is most suitable.	
MODEL/PART NO.	TYPE/DESCRIPTION
SCP-1	<b>220-grit Wet-or-Dry Silicon-Carbide Paper:</b> Suited to most steels. 1 in x 100 ft (25 mm x 30 m) roll.
SCP-2	<b>320-grit Wet-or-Dry Silicon-Carbide Paper:</b> Suited to most steels. Also suited to aluminum alloys and other soft metals. 1 in x 100 ft (25 mm x 30 m) roll.
SCP-3	<b>400-grit Wet-or-Dry Silicon-Carbide Paper:</b> Suited to aluminum alloys and other soft metals. 1 in x 100 ft (25 mm x 30 m) roll.
GC-5	<b>Pumice Powder:</b> Produces a dull, matte finish. Recommended for minimal removal of surface material. 1/2 oz (15 ml) bottle.

<b>SPECIAL-PURPOSE MATERIALS</b>	
MODEL/PART NO.	TYPE/DESCRIPTION
TEC-1	<b>Tetra-Etch® Compound:</b> Used for etching Teflon® to render the surface bondable. Shelf life 3 months at +32°F (0°C). 2 oz (60 ml) can.
CSP-1	<b>Cotton Tip Applicators:</b> 100 single-ended applicators per package [6 in (150 mm) long, wooden stick].
GSP-1	<b>Gauze Sponges:</b> 200 sponges [3 x 3 in (75 x 75 mm)] per package.

TetraEtch is a Registered Trademark of W. L. Gore.  
Teflon is a Registered Trademark of DuPont.



# Strain Gage Adhesives and Cements

## CONTENTS

General Information and Selection Chart.....	18
---	----

### Strain Gage Adhesives

M-Bond 200 .....	20
M-Bond AE-10 .....	21
M-Bond GA-2.....	22
RTC-2 Epoxy .....	23
M-Bond A-12.....	24
M-Bond AE-15 .....	25
M-Bond GA-61.....	26
EpoxyLite 813.....	27
EPY-500.....	28
QA-500 .....	29
M-Bond 610 .....	30
M-Bond 600 .....	32
M-Bond 43-B .....	33
M-Bond 450 .....	34
Denex #3 .....	35
P Adhesive .....	36
M-Bond 300 .....	37

### Free-Filament Strain Gage Cements

NCC-3 .....	38
WC-16 .....	39
HG-1 .....	40
GC .....	41
H.....	42
PBX .....	43
Sauereisen DKS-8 .....	44

## General Information and Selection Guide

Because a strain gage can perform no better than the adhesive with which it is bonded to the test member, the adhesive is a vitally important component in every strain gage installation. Although there is no single adhesive ideally suited to all applications, Micro-Measurements offers a wide selection of adhesives to cover the spectrum of stress analysis testing, and for use in transducer manufacturing. Micro-Measurements adhesives are specially formulated and selected for highest performance under the recommended environmental conditions, and are packaged to provide for ease of mixing and application.

Each adhesive is accompanied by specific instructions for its proper handling—storage, mixing, application, curing, and, if appropriate, post-curing. The adhesive containers are also dated to assure freshness of the contents.

**Note:** It is usually misguided economy to attempt installing strain gages with outdated adhesive, or adhesive that has not been stored as recommended. It should also be noted that conventional industrial and consumer adhesives are not generally suitable for bonding strain gages.

Since different adhesives are intended for different types of applications and different environmental conditions, it is obviously important to select the most appropriate adhesive for each strain measurement task. The table below lists all of the Micro-Measurements adhesives, while the table on the following page is provided as a guide for selecting the most appropriate adhesive for compatibility with a particular strain gage series and test environment.

<b>TYPES AND FEATURES</b>	
<b>M-BOND 200</b>	Most widely used general-purpose adhesive. Easiest to handle. Fast room-temperature curing.
<b>M-BOND AE-10</b>	General-purpose adhesive highly resistant to moisture and most chemicals. Room-temperature curing.
<b>M-BOND GA-2</b>	Special-purpose adhesive primarily used on very rough and irregular surfaces. Room-temperature curing.
<b>RTC-2 EPOXY</b>	General-purpose, room-temperature curing adhesive for lab and field applications with high-elongation strain gages. Also excellent for strain measurement at cryogenic temperatures.
<b>M-BOND A-12</b>	Special-purpose, very high-elongation adhesive. Used only when other adhesives cannot meet elongation requirements. Elevated-temperature curing.
<b>M-BOND AE-15</b>	Similar to AE-10. Recommended for more critical applications, including transducer gaging. Moderately elevated-temperature curing.
<b>M-BOND GA-61</b>	Special-purpose adhesive with a higher operating temperature range than GA-2, and more viscous. Also used to fill irregular surfaces and to anchor leadwires. Elevated-temperature curing.
<b>EPOXYLITE 813</b>	Used for long term, high temperature applications requiring a filled glueline. Wider temperature range than GA-61.
<b>EPY-500</b>	Two-part, heat-curing, filled epoxy system with a wide temperature range.
<b>QA-500</b>	Two-component, clear liquid and powder adhesive for use with strain gages. Has excellent moisture and chemical resistance.
<b>M-BOND 610</b>	Used primarily in stress analysis applications over a wide temperature range, and in precision transducers. Elevated-temperature curing.
<b>M-BOND 600</b>	Similar to 610, but faster reacting. Can be cured at somewhat lower temperatures than 610.
<b>M-BOND 43-B</b>	Normally used in precision transducers. Highly resistant to moisture and chemical attack. Elevated-temperature curing.
<b>M-BOND 450</b>	Special-purpose, high-performance epoxy for higher-temperature transducer applications.
<b>DENEX #3</b>	One-part epoxy for lab and transducer work requiring minimal creep. Elevated temperature curing.
<b>P</b>	Single-part solvent thinned polyimide adhesive. Excellent for long-term high temperature applications.
<b>M-BOND 300</b>	Special-purpose polyester adhesive used primarily when low-temperature curing is required. Sensitive to solvents. Not recommended as a general-purpose adhesive.
<b>NCC-3</b>	Ceramic cement for bonding free-filament strain gages. Has superior bond strength to super-alloy materials, stainless steel, and titanium. Not for use on mild steel.
<b>WC-16</b>	Ceramic cement for bonding free-filament strain gages to materials with low thermal expansion coefficients. Not for use on iron-based alloys.
<b>HG-1</b>	Ceramic cement for bonding free-filament strain gages to most metals. Thermal expansion coefficient closely matches that of steel.
<b>GC</b>	Single-part ceramic cement used for free-filament gages. Recommended for use on low TCE materials, such as carbon.
<b>H CEMENT</b>	One-part ceramic cement/coating used for free filament strain gages. Good adhesion to most metals.
<b>PBX</b>	Two-part ceramic cement/coating used for free-filament strain gages. Good adhesion to most metals.
<b>SAUEREISEN DKS-8</b>	Single-part chemical setting zircon-based cement used for free-filament strain gages. High electrical insulation and thermal conductivity.

**General Information and Selection Guide**

Because a strain gage can perform no better than the adhesive with which it is bonded to the test member, the adhesive is a vitally important component in every strain gage installation. Although there is no single adhesive ideally suited to all applications, Micro-Measurements offers a wide selection of adhesives to cover the spectrum of stress analysis testing, and for use in transducer manufacturing. Micro-Measurements adhesives are specially formulated and selected for highest performance under the recommended environmental conditions, and are packaged to provide for ease of mixing and application.

Each adhesive is accompanied by specific instructions for its proper handling—storage, mixing, application, curing, and, if appropriate, post-curing. The adhesive containers are also dated to assure freshness of the contents.

**Note:** It is usually misguided economy to attempt installing strain gages with outdated adhesive, or adhesive that has not been stored as recommended. It should also be noted that conventional industrial and consumer adhesives are not generally suitable for bonding strain gages.

Since different adhesives are intended for different types of applications and different environmental conditions, it is obviously important to select the most appropriate adhesive for each strain measurement task. The table below lists all of the Micro-Measurements adhesives, while the table on the following page is provided as a guide for selecting the most appropriate adhesive for compatibility with a particular strain gage series and test environment.

<b>RECOMMENDED ADHESIVES/STRAIN GAGE SERIES</b>			
<b>TYPE OF TEST OR APPLICATION</b>	<b>OPERATING TEMPERATURE RANGE</b>	<b>GAGE SERIES</b>	<b>M-BOND ADHESIVE</b>
<b>GENERAL STATIC OR STATIC-DYNAMIC STRESS ANALYSIS</b>	-50° to +150°F (-45° to +65°C)	CEA, EA, C2A, C2K	200 or AE-10 or AE-15 or RTC-2 Epoxy
		WA, SA, WK, SK	AE-15 or 610
	-50° to +400°F (-45° to +205°C)	WA, SA, WK, SK	600 or 610
	-452° to +450°F (-269° to +230°C)	WK, SK	610
	<600°F (<315°C)	WK	610
<b>HIGH ELONGATION (POST-YIELD)</b>	-50° to +150°F (-45° to +65°C)	CEA, EA	200 or AE-10 or RTC-2 Epoxy
		EP	AE-15 or A-12
<b>DYNAMIC (CYCLIC) STRESS ANALYSIS</b>	-100° to +150°F (-75° to +65°C)	ED	200 or AE-10
		WD	AE-10 or AE-15
	-320° to +500°F (-195° to +260°C)	WD	600 or 610
<b>TRANSDUCER GAGING</b>	-50° to +150°F (-45° to +65°C)	CEA, EA	AE-10 or AE-15
	-50° to +200°F (-45° to +95°C)	N2A, J2A	600 or 610 or 43-B
	-50° to +300°F (-45° to +150°C)	WA, SA, TA, TK, J5K	610 or 450 or P Adhesive or Denex #3
	-320° to +350°F (-195° to +175°C)	WK, SK, TK, J5K	610 or 450 or P Adhesive or Denex #3
<b>HIGH TEMPERATURE GAGING</b>	-452° to +700°F (-269° to +370°C)	WK, RK	P Adhesive
	-320° to +1600°F (-195° to +870°C)	ZC, ZWP, ZWN, ZWH	NCC-3 or WC-16 or HG-1 or GC or PBX or DKS-8 or H Cement

## Strain Gage Adhesive

### OTHER ACCESSORIES USED IN AN M-BOND 200 INSTALLATION:

- CSM Degreaser or GC-6 Isopropyl Alcohol
- Silicon Carbide Paper
- M-Prep Conditioner A
- M-Prep Neutralizer 5A
- GSP-1 Gauze Sponges
- CSP-1 Cotton Applicators
- PCT-2M Gage Installation Tape



**RoHS**  
COMPLIANT

### DESCRIPTION

For routine experimental stress analysis applications under temperate environmental conditions, M-Bond 200 adhesive is ordinarily the best choice. This adhesive is very easy to handle, and cures almost instantly to produce an essentially creep-free, fatigue-resistant bond, with elongation capability of five percent or more.

M-Bond 200 is a cyanoacrylate that has been pretested and certified for use in bonding strain gages. It is an excellent general-purpose adhesive for laboratory and short-term field applications. The procedure for making a strain gage installation with M-Bond 200 is illustrated and described in detail in Instruction Bulletin B-127 included in each kit of adhesive.

The user should note that the performance of the adhesive can be degraded by the effects of time, humidity conditions, elevated temperature, and moisture absorption. Because of the latter effect, strain gage installations should always be covered with a suitable protective coating. When necessitated by more rigorous test requirements and/or environmental conditions, consideration should be given to one of the M-Bond epoxy adhesives, using the "Recommended Adhesives/Strain Gage Series" chart.

CHARACTERISTICS	
PARAMETER	DETAILS
<b>CURE REQUIREMENTS*</b>	One-minute thumb pressure, followed by a minimum two-minute delay before tape removal. Bond strength increases rapidly during first five minutes. Cure time must be extended under conditions of low temperature [ $<70^{\circ}\text{F}$ ( $<21^{\circ}\text{C}$ )] or low humidity ( $<40\%$ RH).
<b>OPERATING TEMPERATURE RANGE</b>	<p><b>Short Term:</b> <math>-300^{\circ}</math> to <math>+200^{\circ}\text{F}</math> (<math>-185^{\circ}</math> to <math>+95^{\circ}\text{C}</math>).</p> <p><b>Long Term:</b> <math>-25^{\circ}</math> to <math>+150^{\circ}\text{F}</math> (<math>-32^{\circ}</math> to <math>+65^{\circ}\text{C}</math>).</p>
<b>ELONGATION CAPABILITIES</b>	$>5\%$ at $+75^{\circ}\text{F}$ ( $+24^{\circ}\text{C}$ ), $3\%$ at $+75^{\circ}\text{F}$ ( $+24^{\circ}\text{C}$ ) when used with CEA or EA/Option E strain gages.
<b>SHELF LIFE</b>	<p>Minimum 12 months when stored unopened at <math>+40^{\circ}\text{F}</math> (<math>+5^{\circ}\text{C}</math>) or minimum 9 months when stored unopened at <math>+75^{\circ}\text{F}</math> (<math>+24^{\circ}\text{C}</math>).</p> <p><i>Note:</i> To ensure a proper seal, wipe bottle spout clean and dry before replacing cap.</p> <p><i>Note:</i> Condensation rapidly degrades adhesive performance and shelf life; if refrigerated, allow adhesive to reach room-temperature before opening. Refrigeration after opening is not recommended.</p>
<b>POT LIFE</b>	Maximum 3 months at $+75^{\circ}\text{F}$ ( $+24^{\circ}\text{C}$ ) (not to exceed date of expiration) after opening. Replace the cap immediately after each use.

PACKAGING OPTIONS	
KIT	BULK
<p>1 bottle (1 oz/28 g) Adhesive 1 brush-cap bottle (30 ml) Catalyst</p>	<p>1 bottle (1 oz/28 g) Adhesive 5 tubes (2 g each) Adhesive 16 bottles (1 oz/28 g each) Adhesive 12 brush-cap bottles (30 ml each) Catalyst</p>

\*Reference: Instruction Bulletin B-127 for complete details.

## Strain Gage Adhesive

### OTHER ACCESSORIES USED IN AN M-BOND AE-10 INSTALLATION:

- CSM Degreaser or GC-6 Isopropyl Alcohol
- Silicon-Carbide Paper
- M-Prep Conditioner A
- M-Prep Neutralizer 5A
- GSP-1 Gauze Sponges
- CSP-1 Cotton Tip Applicators
- PCT-2M Gage Installation Tape
- HSC Spring Clamp
- GT-14 Pressure Pads and Backup Plates



### DESCRIPTION

Two-component, 100%-solids epoxy system for generalpurpose stress analysis. Transparent, medium viscosity. Cure time as low as six hours at +75°F (+24°C) may be used. Elevated-temperature postcure is recommended for maximum stability, and/or tests above room temperature.

Highly resistant to moisture and most chemicals, particularly when postcured. For maximum elongation, bonding surface must be roughened. Cryogenic applications require very thin gluelines.

CHARACTERISTICS	
PARAMETER	DETAILS
OPERATING TEMPERATURE RANGE	<b>Long Term:</b> -320° to +200°F (-195° to +95°C)
ELONGATION CAPABILITIES	1% at -320° (-195°C), 6% to 10% at +75°F (+24°C), 15% at +200°F (+95°C).
SHELF LIFE	Minimum 12 months at +75°F (+24°C); or 18 months at +40°F (+5°C). If crystals form in resin jar, heat to +120°F (+50°C) for 30 minutes. Cool before mixing. Refer to product label for most recent information.
POT LIFE	15 to 20 minutes at +75°F (+24°C). Can be extended by cooling jar or by spreading adhesive on clean aluminum plate.
CLAMPING PRESSURE	5 to 20 psi (35 to 140 kN/m <sup>2</sup> ).
CURE REQUIREMENTS*	<p><b>Preferred Room-Temperature Cure:</b> 24 to 48 hours at +75°F (+24°C).</p> <p><b>Recommended Postcure:</b> 2 hours at 25°F (15°C) above maximum operating temperature.</p>

PACKAGING	
KIT	BULK
6 mixing jars (10 g ea) Resin 1 bottle (15 ml) Curing Agent 10 6 calibrated pipettes 6 stirring rods	200 g Resin 40 g Curing Agent 10 3 calibrated pipettes

\* **Reference:** Instruction Bulletin B-137, "Strain Gage Applications with M-Bond AE-10, AE-15, and GA-2 Adhesive Systems", included in each kit.

## Strain Gage Adhesive

### OTHER ACCESSORIES USED IN AN M-BOND GA-2 INSTALLATION:

- CSM Degreaser or GC-6 Isopropyl Alcohol
- Silicon-Carbide Paper
- M-Prep Conditioner A
- M-Prep Neutralizer 5A
- GSP-1 Gauze Sponges
- CSP-1 Cotton Tip Applicators
- PCT-2M Gage Installation Tape
- HSC Spring Clamp
- GT-14 Pressure Pads and Backup Plates



**RoHS**  
COMPLIANT

### DESCRIPTION

Two-component, partially filled, 100%-solids epoxy system for general-purpose stress analysis. Higher viscosity than AE systems. Elevated-temperature cure recommended for best performance and resistance to

chemical attack. Often used to fill irregular surfaces. Uneven gluelines easily detectable by nonuniformity of bond color.

CHARACTERISTICS	
PARAMETER	DETAILS
OPERATING TEMPERATURE RANGE	<b>Long Term:</b> -320° to +200°F (-195° to +95°C)
ELONGATION CAPABILITIES	4% at -320°F (-195°C), 10% to 15% at +75°F (+24°C) after 40-hr RT cure or 6-hr RT cure with postcure.
SHELF LIFE	Minimum 12 months at +75°F (+24°C); or 18 months at +40°F (+5°C). Refer to product label for most recent information.
POT LIFE	15 minutes at +75°F [+24°C]. Can be extended by cooling jar or by spreading adhesive on clean aluminum plate.
CLAMPING PRESSURE	5 to 20 psi (35 to 140 kN/m <sup>2</sup> ). The black filler provides a visual indication of nonuniform bond areas caused by uneven clamping pressure.
CURE REQUIREMENTS*	<p><b>Preferred Room Temperature Cure:</b> 40 hours at +75°F (+24°C).</p> <p><b>Recommended Postcure:</b> 2 hours at 25°F (15°C) above maximum operating temperature.</p>

PACKAGING
<b>KIT</b>
6 mixing jars (15 g ea) Resin, 6 calibrated pipettes, 1 bottle (15 ml) Curing Agent 10-A, 6 stirring rods

\* **References:** Instruction Bulletin B-137, "Strain Gage Applications with M-Bond AE-10, AE-15, and GA-2 Adhesive Systems," included in each kit.



## Strain Gage Adhesive

### OTHER ACCESSORIES USED IN AN RTC-2 EPOXY INSTALLATION:

- CSM Degreaser or GC-6 Isopropyl Alcohol
- Silicon-Carbide Paper
- M-Prep Conditioner A
- M-Prep Neutralizer 5A
- CSP-1 Cotton Tip Swabs
- GSP-1 Gauze Sponges
- MJG-2 Mylar® Tape
- TFE-1 Teflon® Film
- HSC Spring Clamp
- GT-14 Pressure Pads and Backup Plates



### DESCRIPTION

General-purpose, two-component, adhesive for lab and field applications with post-yield, high-elongation strain gages. Also excellent for cryogenic strain measurement applications.

CHARACTERISTICS	
PARAMETER	DETAILS
OPERATING TEMPERATURE RANGE	-452° to +200°F (-269° to +95°C).
ELONGATION CAPABILITIES	15% at +75°F (+24°C).
SHELF LIFE	Minimum 1 year at +75°F (+24°C). Refer to product label for most recent information.
POT LIFE	30 minutes at +75°F (+24°C).
CLAMPING PRESSURE	5 to 20 psi (35 to 140 kN/m²).
CURE REQUIREMENTS*	6 hours at +75°F (+24°C), or 1 hour at +175°F (+80°C).  <b>Recommended Postcure (Unclamped):</b> 1 hour at +120°F (+50°C), or 25°F (15°C) above maximum operating temperature.

PACKAGING	
KITS	
1 jar Part A [2 oz (56 gm)] 1 jar Part B [1 oz (28 gm)]	1 jar Part A [11 oz (308 gm)] 1 jar Part B [5 oz (140 gm)]

\* **Reference:** Instruction Bulletin B-189 for complete details.

Mylar and Teflon are Registered Trademarks of DuPont.

## Strain Gage Adhesive

### OTHER ACCESSORIES USED IN AN M-BOND A-12 INSTALLATION:

- CSM Degreaser or GC-6 Isopropyl Alcohol
- Silicon-Carbide Paper
- M-Prep Conditioner A
- M-Prep Neutralizer 5A
- GSP-1 Gauze Sponges
- CSP-1 Cotton Tip Applicators
- PCT-2M Gage Installation Tape
- HSC Spring Clamp
- GT-14 Pressure Pads and Backup Plates

### DESCRIPTION

Two-component, 100%-solids epoxy system. Not intended as a general-purpose strain gage adhesive. Should be used only when maximum elongation requirements of a test exceed the capabilities of other M-Bond adhesive systems. Mixed adhesive gritty with large solid particles present; large particles must be removed prior to gage installation.



**RoHS**  
COMPLIANT

CHARACTERISTICS	
PARAMETER	DETAILS
OPERATING TEMPERATURE RANGE	<b>Long Term:</b> -50° to +180°F (-45° to +80°C)
ELONGATION CAPABILITIES	15% to 20% at +75°F (+24°C).
SHELF LIFE	Minimum 1 year at +75°F (+24°C). Refer to product label for most recent information.
POT LIFE	Approximately 1 hour.
CLAMPING PRESSURE	5 to 20 psi (35 to 140 kN/m <sup>2</sup> ).
CURE REQUIREMENTS*	2 hours at +165°F (+75°C), or 2 weeks at +75°F (+24°C).

PACKAGING
<b>KIT</b>
1 tube (55 grams) Part A component 1 tube (45 grams) Part B component 5 disposable mixing cups 5 wooden stirring sticks

\* **Reference:** Instruction Bulletin B-189 for complete details.

## Strain Gage Adhesive

### OTHER ACCESSORIES USED IN AN M-BOND AE-15 INSTALLATION:

- CSM Degreaser or GC-6 Isopropyl Alcohol
- Silicon-Carbide Paper
- M-Prep Conditioner A
- M-Prep Neutralizer 5A
- GSP-1 Gauze Sponges
- CSP-1 Cotton Tip Applicators
- PCT-2M Gage Installation Tape
- HSC Spring Clamp
- GT-14 Pressure Pads and Backup Plates



### DESCRIPTION

Two-component, 100%-solids epoxy system for generalpurpose stress analysis. Transparent, medium viscosity. Cure time as low as six hours at +125°F (+50°C). Recommended for more critical applications, including transducers. It has a longer pot life than M-Bond AE-10 which allows more time for multiple gage installations.

Elevated-temperature postcure is recommended for maximum stability, and/or tests above room temperature. Highly resistant to moisture and most chemicals, particularly when postcured. For maximum elongation, bonding surface must be roughened. Cryogenic applications require very thin gluelines.

CHARACTERISTICS		DETAILS
PARAMETER	DETAILS	
OPERATING TEMPERATURE RANGE	<b>Long Term:</b> -452° to +200°F (-269° to +95°C). <b>Transducers:</b> to +175°F (+80°C).	
ELONGATION CAPABILITIES	2% at -320° (-195°C), 10% to 15% at +75°F (+24°C), 15% at +200°F (+95°C).	
SHELF LIFE	Minimum 12 months at +75°F (+24°C); or 18 months at +40°F (+5°C). If crystals form in resin jar, heat to +120°F (+50°C) for 30 minutes. Cool before mixing. Refer to product label for most recent information.	
POT LIFE	1-1/2 hours at +75°F (+24°C).	
CLAMPING PRESSURE	5 to 20 psi (35 to 140 kN/m <sup>2</sup> ).	
CURE REQUIREMENTS*	<p><b>Recommended Postcure:</b> 2 hours at 25°F (15°C) above maximum operating temperature.</p> <p><b>Optimum Performance Transducer Postcure:</b> 1 hour at +200°F (+95°C).</p>	

PACKAGING	
KIT	BULK
6 mixing jars (10 g ea) Resin 1 bottle (15 ml) Curing Agent 15 6 calibrated pipettes 6 stirring rods	200 g Resin 25 g Curing Agent 10 3 calibrated pipettes

\* **References:** Instruction Bulletin B-137, "Strain Gage Applications with M-Bond AE-10, AE-15, and GA-2 Adhesive Systems", included in each kit.

**Strain Gage Adhesive**

**OTHER ACCESSORIES USED IN AN M-BOND GA-61 INSTALLATION:**

- CSM Degreaser or GC-6 Isopropyl Alcohol
- Silicon-Carbide Paper
- M-Prep Conditioner A
- M-Prep Neutralizer 5A
- GSP-1 Gauze Sponges
- CSP-1 Cotton Tip Applicators
- MJG-2 Mylar® Tape
- TFE-1 Teflon® Film
- HSC Spring Clamp
- GT-14 Pressure Pads and Backup Plates



**RoHS**  
COMPLIANT

**DESCRIPTION**

Two-component, partially filled, 100%-solids epoxy adhesive for general-purpose stress analysis. Very high viscosity. Widely used to fill irregular surfaces and to anchor leadwires. Forms a very hard, chemical-resistant material when fully cured. Glueline thickness is generally <0.002 in (0.05 mm).

CHARACTERISTICS	
PARAMETER	DETAILS
OPERATING TEMPERATURE RANGE	<p><b>Short Term:</b> -100° to +600°F (-75° to +315°C)</p> <p><b>Long Term:</b> -100° to +500°F (-75° to +260°C)</p>
ELONGATION CAPABILITIES	1% at -100°F (-75°C), 2% at +75°F (+24°C), 1% at +500°F (+260°C).
SHELF LIFE	6 months minimum at +75°F (+24°C); refrigeration recommended. Refer to product label for most recent information.
MIXED POT LIFE	10 hours at +75°F (+24°C); increased by refrigeration, indefinite by freezing.
CLAMPING PRESSURE	10 to 30 psi (70 to 200 kN/m <sup>2</sup> ).
CURE REQUIREMENTS*	<p><b>Elevated Temperature Cure Required.</b></p> <p><b>Recommended Postcure:</b> 1 hour at 50°F (30°C) above maximum operating temperature not to exceed +600°F (+315°C).</p> <div style="text-align: right;"> </div>

PACKAGING
<b>KIT</b>
3 jars (10 g ea) Resin, 3 jars (5 g ea) Hardener, 3 stirring rods

\* **References:** Instruction Bulletin B-128, “Strain Gage Applications with M-Bond GA-61 Adhesive”, included in each kit.

## Strain Gage Adhesive

### OTHER ACCESSORIES USED IN AN EPOXYLITE 813 INSTALLATION:

- CSM Degreaser or GC-6 Isopropyl Alcohol
- Silicon-Carbide Paper
- M-Prep Conditioner A
- M-Prep Neutralizer 5A
- GSP-1 Gauze Sponges
- MJG-2 Mylar® Tape
- TFE-1 Teflon® Film
- HSC Spring Clamp
- GT-14 Pressure Pads and Backup Plates



**RoHS**  
COMPLIANT

### DESCRIPTION

Two-part, 100%-solids, epoxy adhesive. Similar to GA-61, but serviceable to +600°F (+315°C). Excellent adhesion to metals, ceramics, and most composites.

CHARACTERISTICS	
PARAMETER	DETAILS
OPERATING TEMPERATURE RANGE	<b>Long Term:</b> -320° to +600°F (-195° to +315°C)
ELONGATION CAPABILITIES	1% at +75°F (+24°C).
SHELF LIFE	Minimum 6 months at +75°F (+24°C). Refer to product label for most recent information.
POT LIFE	6 to 8 hours at +75°F (+24°C).
CLAMPING PRESSURE	30 to 70 psi (200 to 350 kN/m <sup>2</sup> ).
CURE REQUIREMENTS*	4 hours at +350°F (+175°C). <b>Recommended Postcure (Unclamped):</b> 1 hour at 25°F (15°C) above maximum operating temperature.

PACKAGING
<b>KIT</b>
6 bottles Part A [0.5 oz (18 gm)] Resin 6 bottles Part B [0.25 oz (7 gm)] Powder

\* **Reference:** Instruction Bulletin B-174 for complete details.

Mylar and Teflon are Registered Trademarks of DuPont.

## Strain Gage Adhesive

### OTHER ACCESSORIES USED IN AN EPY-500 INSTALLATION:

- CSM Degreaser or GC-6 Isopropyl Alcohol
- Silicon-Carbide Paper
- M-Prep Conditioner A
- M-Prep Neutralizer 5A
- GSP-1 Gauze Sponges
- CSP-1 Cotton Tip Swabs
- MJG-2 Mylar® Tape
- TFE-1 Teflon® Film
- HSC Spring Clamp
- GT-14 Pressure Pads and Backup Plates



### DESCRIPTION

EPY-500 is a two-part, heat-curing, filled epoxy system that is specially formulated for Micro-Measurements. This adhesive has reduced particle size, allowing a much thinner glueline. The adhesive is compatible with all phenolic, epoxy-phenolic and polyimide strain gages.

CHARACTERISTICS	
PARAMETER	DETAILS
OPERATING TEMPERATURE RANGE	-452° to +500°F (-269° to +260°C).
SHELF LIFE	Minimum 9 months. Refer to product label for most recent information.
POT LIFE	24 hours.
STRAIN LIMIT—SINGLE CYCLE	5% at +75°F (+24°C); 1% at -320°F (-195°C).
CLAMPING PRESSURE	10 to 15 psi (70 to 105 kN/m <sup>2</sup> ).
CURE REQUIREMENTS*	26 hours at +200°F (+93°C); or 4 hours at +250°F (+121°C); or 1 hour at +350°F (+176°C); or 1/2 hour at +400°F (+204°C).  <b>Recommended Postcure:</b> 1 hour at +450°F (+232°C).

PACKAGING
KIT
5 (10 g ea) packages

\* **Reference:** Instruction Bulletin B-172 for complete details.

Mylar and Teflon are Registered Trademarks of DuPont.

## Strain Gage Adhesive

### OTHER ACCESSORIES USED IN A QA-500 INSTALLATION:

- CSM Degreaser or GC-6 Isopropyl Alcohol
- Silicon-Carbide Paper
- M-Prep Conditioner A
- M-Prep Neutralizer 5A
- GSP-1 Gauze Sponges
- CSP-1 Cotton Tip Swabs
- MJG-2 Mylar® Tape
- TFE-1 Teflon® Film
- HSC Spring Clamp
- GT-14 Pressure Pads and Backup Plates



### DESCRIPTION

QA-500 is a specially formulated two-component, clear liquid and powder adhesive for use with strain gages. QA-500 has excellent moisture and chemical resistance.

CHARACTERISTICS	
PARAMETER	DETAILS
OPERATING TEMPERATURE RANGE	-320° to +500°F (-195° to +260°C).
SHELF LIFE	Minimum 9 months. Refer to product label for most recent information.
POT LIFE	24 hours.
STRAIN LIMIT—SINGLE CYCLE	2%
CLAMPING PRESSURE	20 to 30 psi (140 to 210 kN/m <sup>2</sup> ).
CURE REQUIREMENTS*	Minimum 2 hours at +250°F (+121°C). <b>Postcure (Clamps Removed):</b> 4 hours at +50°F (+28°C) above maximum operating or curing temperature, whichever is higher.

PACKAGING
<b>SMALL KIT</b>
3 jars (7 g ea) resin 3 jars (3 g ea) hardener 3 stirring rods

\* **Reference:** Instruction Bulletin B-191 for complete details.

Mylar and Teflon are Registered Trademarks of DuPont.

**Strain Gage Adhesive for Stress Analysis and Transducer Applications**

**OTHER ACCESSORIES USED IN AN M-BOND 610 INSTALLATION:**

- CSM Degreaser or GC-6 Isopropyl Alcohol
- Silicon-Carbide Paper
- M-Prep Conditioner A
- M-Prep Neutralizer 5A
- GSP-1 Gauze Sponges
- CSP-1 Cotton Tip Applicators
- MJG-2 Mylar® Tape
- TFE-1 Teflon® Film
- HSC Spring Clamp
- GT-14 Pressure Pads and Backup Plates



**DESCRIPTION**

Two-component, solvent-thinned, epoxy-phenolic adhesive for high-performance applications, including high-precision transducers. Solids content 22%. Widest temperature range general-purpose adhesive available.

Low viscosity, capable of gluelines <0.0002 in (0.005 mm). Extremely thin, hard, void-free gluelines minimize creep, hysteresis, and linearity problems. Cure must begin within four hours of application.

CHARACTERISTICS	
PARAMETER	DETAILS
OPERATING TEMPERATURE RANGE	<p><b>Short Term:</b> -452° to +700°F (-269° to +370°C).</p> <p><b>Long Term:</b> -452° to +500°F (-269° to +260°C).</p> <p><b>Transducers:</b> to +450°F (+232°C).</p>
ELONGATION CAPABILITIES	1% at -452° (-269°C), 3% at +75°F (+24°C), 3% at +500°F (+260°C).
SHELF LIFE	Minimum 5 months after the date of manufacture on the label when stored at +75°F (+24°C); or minimum 7 months after the date of manufacture on the label when refrigerated upon receipt at +40°F (+5°C). Refrigerated storage recommended. Refer to product label for most recent information.
POT LIFE	6 weeks at +75°F (+24°C); 12 weeks at +40°F (+5°C).
CLAMPING PRESSURE	<p>10 to 70 psi (70 to 480 kN/m<sup>2</sup>)</p> <p><b>Optimum:</b> 30 to 40 psi (200 to 275 kN/m<sup>2</sup>)</p>
CURE REQUIREMENTS* FOR STRESS ANALYSIS	<div style="display: flex; align-items: center;"> <div style="flex: 1;"> </div> <div style="flex: 1; padding-left: 20px;"> <p><b>Recommended Postcure:</b> 2 hours at 50° to 75°F (30° to 40°C) above maximum operating temperature or cure temperature, whichever is higher.</p> </div> </div>
CURE REQUIREMENTS* FOR TRANSDUCERS	<p><b>Recommended Cure:</b> *1 hour at +350°F (+177°C).</p> <p><b>Transducer Postcure:</b> 2 hours at +400° to +450°F (+205° to +232°C) after wiring.</p> <p>*Altered for aluminum-alloy transducers. See Strain Gage Installation Procedures for Transducers.</p>

\* **Reference:** Instruction Bulletin B-130 for complete details.



**Strain Gage Adhesive for Stress Analysis and Transducer Applications**

<b>PACKAGING</b>	
<b>KIT</b>	<b>SINGLE MIX KIT</b>
4 bottles (11 g ea) Curing Agent 4 bottles (14 g ea) Resin 4 brush caps for dispensing mixed adhesive 4 disposable mixing funnels	1 bottle (11 g ea) Curing Agent 1 bottle (14 g ea) Resin 1 brush cap for dispensing mixed adhesive 1 disposable mixing funnel

**References:** Instruction Bulletin B-130, "Strain Gage Installations with M-Bond 43-B, 600 and 610 Adhesive Systems," included in each kit.

## Strain Gage Adhesive

### OTHER ACCESSORIES USED IN AN M-BOND 600 INSTALLATION:

- CSM Degreaser or GC-6 Isopropyl Alcohol
- Silicon-Carbide Paper
- M-Prep Conditioner A
- M-Prep Neutralizer 5A
- GSP-1 Gauze Sponges
- CSP-1 Cotton Tip Applicators
- MJG-2 Mylar® Tape
- TFE-1 Teflon® Film
- HSC Spring Clamp
- GT-14 Pressure Pads and Backup Plates



**RoHS**  
COMPLIANT

### DESCRIPTION

Similar to M-Bond 610 except with more reactive curing agent. Shorter shelf life, pot life, and working time than M-Bond 610, but has lower temperature cures and faster

reaction time. Cure must begin within 30 minutes of application (up to 4 hours for M-Bond 610).

CHARACTERISTICS																
PARAMETER	DETAILS															
OPERATING TEMPERATURE RANGE	<b>Short Term:</b> -452° to +700°F (-269° to +370°C). <b>Long Term:</b> -452° to +500°F (-269° to +260°C).															
ELONGATION CAPABILITIES	1% at -452° (-269°C), 3% at +75°F (+24°C), 3% at +500°F (+260°C).															
SHELF LIFE	Minimum 4 months after the date of manufacture on the label when stored at +75°F (+24°C); minimum 7 months after the date of manufacture on the label when refrigerated upon receipt at +40°F (+5°C). Refrigerated storage recommended. Refer to product label for most recent information.															
POT LIFE	2 weeks at +75°F (+24°C); 4 weeks at +40°F (+5°C).															
CLAMPING PRESSURE	10 to 70 psi (70 to 480 kN/m <sup>2</sup> ) <b>Optimum:</b> 30 to 40 psi (200 to 275 kN/m <sup>2</sup> )															
CURE REQUIREMENTS*	<p><b>Moderately Elevated-Temperature Cure Required. Recommended Postcure:</b> 1 to 2 hours at 50°F (30°C) above maximum operating temperature.</p> <table border="1"> <caption>Cure Time vs. Temperature</caption> <thead> <tr> <th>Glueline Temp (°F)</th> <th>Glueline Temp (°C)</th> <th>Time (Hours)</th> </tr> </thead> <tbody> <tr> <td>175</td> <td>80</td> <td>4 (Minimum)</td> </tr> <tr> <td>250</td> <td>125</td> <td>2 (Recommended)</td> </tr> <tr> <td>300</td> <td>150</td> <td>1.5</td> </tr> <tr> <td>350</td> <td>175</td> <td>1</td> </tr> </tbody> </table>	Glueline Temp (°F)	Glueline Temp (°C)	Time (Hours)	175	80	4 (Minimum)	250	125	2 (Recommended)	300	150	1.5	350	175	1
Glueline Temp (°F)	Glueline Temp (°C)	Time (Hours)														
175	80	4 (Minimum)														
250	125	2 (Recommended)														
300	150	1.5														
350	175	1														

PACKAGING	
KIT	SINGLE MIX KIT
4 bottles (11 g ea) Curing Agent 4 bottles (8 g ea) Resin 4 brush caps for dispensing mixed adhesive 4 disposable mixing funnels	1 bottle (11 g ea) Curing Agent 1 bottle (8 g ea) Resin 1 brush cap for dispensing mixed adhesive 1 disposable mixing funnel

\* **References:** Instruction Bulletin B-130, "Strain Gage Installations with M-Bond 43-B, 600 and 610 Adhesive Systems," included in each kit.

## Strain Gage Adhesive for Stress Analysis and Transducer Applications

### OTHER ACCESSORIES USED IN AN M-BOND 43-B INSTALLATION:

- CSM Degreaser or GC-6 Isopropyl Alcohol
- Silicon-Carbide Paper
- M-Prep Conditioner A
- M-Prep Neutralizer 5A
- GSP-1 Gauze Sponges
- CSP-1 Cotton Tip Applicators
- MJG-2 Mylar® Tape
- TFE-1 Teflon® Film
- HSC Spring Clamp
- GT-14 Pressure Pads and Backup Plates



**RoHS**  
COMPLIANT



### DESCRIPTION

Single-component, solvent-thinned, epoxy adhesive normally used in transducer applications; solids content 25%. May be used both as an adhesive and as a protective coating. Capable of forming very thin, hard, void-free gluelines similar to M-Bond 610. Highly resistant to moisture and chemical attack.

CHARACTERISTICS	
PARAMETER	DETAILS
OPERATING TEMPERATURE RANGE	<b>Short Term:</b> -452° to +350°F (-269° to +175°C) <b>Long Term:</b> -452° to +300°F (-269° to +150°C) <b>Transducers:</b> to +250°F (+120°C).
ELONGATION CAPABILITIES	1% at -452°F (-269°C), 4% at +75°F (+24°C), 2% at +300°F (+150°C).
SHELF LIFE	Minimum 9 months at +75°F (+24°C); or 18 months at +40°F (+5°C). Refer to product label for most recent information.
POT LIFE	Minimum 9 months at +75°F (+24°C); or 18 months at +40°F (+5°C).
CLAMPING PRESSURE	<b>For Stress Analysis:</b> 15 to 100 psi (100 to 700 kN/m <sup>2</sup> ). <b>Optimum:</b> 40 to 50 psi (275 to 350 kN/m <sup>2</sup> ). <b>For Transducers:</b> 45 to 60 psi (315 to 415 kN/m <sup>2</sup> ). <b>Optimum:</b> 50 psi (350 kN/m <sup>2</sup> ).
CURE REQUIREMENTS*	2 hours at +375°F (+190°C), or as an alternate cure for aluminum alloy transducers, 2-1/2 hours at +300°F (+150°C). <b>Recommended Postcure:</b> 2 hours at +400°F (+205°C), or as an alternate postcure for aluminum alloy transducer applications, 2-1/2 hours at +350°F (+175°C).

PACKAGING	
KIT	SINGLE BOTTLE
4 brush-cap bottles (30 ml ea) premixed adhesive	1 brush-cap bottle (30 ml ea) premixed adhesive

\* **Reference:** Instruction Bulletin B-130, "Strain Gage Installations with M-Bond 43-B, 600 and 610 Adhesive Systems", included in each kit.

Mylar and Teflon are Registered Trademarks of DuPont

## Strain Gage Adhesive for Stress Analysis and Transducer Applications

### OTHER ACCESSORIES USED IN AN M-BOND 450 INSTALLATION:

- CSM Degreaser or GC-6 Isopropyl Alcohol
- Silicon-Carbide Paper
- M-Prep Conditioner A
- M-Prep Neutralizer 5A
- GSP-1 Gauze Sponges
- CSP-1 Cotton Applicators
- MJG-2 Mylar® Tape
- TFE-1 Teflon® Film
- HSC Spring Clamp
- GT-14 Pressure Pads and Backup Plates



**RoHS**  
COMPLIANT

### DESCRIPTION

High-performance, two-component, solvent-thinned epoxy system specially formulated for high accuracy, elevated-temperature transducer applications.

CHARACTERISTICS	
PARAMETER	DETAILS
OPERATING TEMPERATURE RANGE	<b>Short Term:</b> -452° to +750°F (-269° to +400°C) <b>Long Term:</b> -452° to +500°F (-269° to +260°C)
ELONGATION CAPABILITIES	>5% at +75°F (+24°C).
SHELF LIFE	6 months at +75°F (+24°C)
POT LIFE	6 weeks at +75°F (+24°C)
CLAMPING PRESSURE	60 to 100 psi (4 to 6 bar)
CURE REQUIREMENTS*	<p><b>Step 1:</b> Air dry at +75°F (+24°C) 10 to 30 min</p> <p><b>B-Stage:</b> +225°F (+105°C) for 30 min</p> <p><b>Cure:</b> +350°F (+175°C) for 1 hour</p> <p><b>Recommended Postcure for Stress Analysis:</b> 1 hour at 50°F (30°C) above max operating temperature in 50°F (30°C) increments from +350°F (+175°C), dwelling 1 hour at each step.</p> <p><b>Recommended Postcure for Transducers:</b> 1 hour at 50°F (30°C) above max operating temperature or cure temperature, whichever is higher.</p>

PACKAGING
<p style="text-align: center;"><b>KIT</b></p> <p>4 bottles (12.7 g ea) Curing Agent                      4 bottles (11.9 g ea) Resin                      4 brush caps for applying adhesive                      4 disposable mixing funnels</p>

\* **Reference:** M-M Instruction Bulletin B-152, "Instructions for the Application of Micro-Measurements M-Bond 450 Adhesive", included in each kit.

**Reference:** M-M Strain Gage Accessories databook.

Mylar and Teflon are Registered Trademarks of DuPont.

## Strain Gage Adhesive

### OTHER ACCESSORIES USED IN A DENEX #3 INSTALLATION:

- CSM Degreaser or GC-6 Isopropyl Alcohol
- Silicon-Carbide Paper
- M-Prep Conditioner A
- M-Prep Neutralizer 5A
- MJG-2 Mylar® Tape
- TFE-1 Teflon® Film
- HSC Spring Clamp
- GT-14 Pressure Pads and Backup Plates



**RoHS**  
COMPLIANT

### DESCRIPTION

Single-component, solvent thinned epoxy adhesive used in laboratory and transducer applications where negligible creep can be tolerated. Can be solvent

thinned (acetone) for easy application. Lower creep at elevated temperatures. Can be B-staged or dried prior to clamped curing.

CHARACTERISTICS	
PARAMETER	DETAILS
OPERATING TEMPERATURE RANGE	-452° to +400°F (-269°C to +204°C)
ELONGATION CAPABILITY	1% at +75°F (+24°C)
SHELF LIFE	Minimum 3 months @ +75°F (+24°C); minimum 6 months @ +40°F (+5°C). Refer to produce label for most recent information.
CLAMPING PRESSURE	30 to 50 psi (200 to 350 kN/m <sup>2</sup> )
CURE REQUIREMENTS*	<p><b>Recommended Cure:</b></p> <p><b>Laboratory Use:</b> 1 hour at +250°F (+120°C), followed by 1 hr at +350°F (+175°C)</p> <p><b>Transducers:</b> 4 hours at +325°F (+163°C)</p> <p><b>Postcure (Unclamped):</b></p> <p><b>Laboratory Use:</b> 1 hour at 75°F (40°C) above maximum operating temperature</p> <p><b>Transducers:</b> 4 hours at +350°F (+175°C)</p>

PACKAGING
1 brush cap bottle (1/2 oz/15 ml) of premixed adhesive
1 brush cap bottle (1 oz/30 ml) of premixed adhesive
4 brush cap bottles (1 oz/30 ml each) premixed adhesive
1 bottle (32 oz/950 ml) premixed adhesive

\* **Reference:** Instruction Bulletin B-173 for complete details.

## Strain Gage Adhesive

### OTHER ACCESSORIES USED IN AN P ADHESIVE INSTALLATION:

- CSM Degreaser or GC-6 Isopropyl Alcohol
- Silicon-Carbide Paper
- M-Prep Conditioner A
- M-Prep Neutralizer 5A
- CSP-1 Cotton Tip Swabs
- GSP-1 Gauze Sponges
- MJG-2 Mylar® Tape
- TFE-1 Teflon® Film
- HSC Spring Clamp
- GT-14 Pressure Pads and Backup Plates



**RoHS**  
COMPLIANT

### DESCRIPTION

Single-part, solvent-thinned, polyimide adhesive. Results in a strong, thin, near-creep-free, adhesive layer.

CHARACTERISTICS	
PARAMETER	DETAILS
OPERATING TEMPERATURE RANGE	-452° to +700°F (-270° to +370°C). <b>Upper Limit:</b> +800°F (+427°C) for 1 to 2 hours.
ELONGATION CAPABILITIES	2% at +75°F (+24°C).
SHELF LIFE	Minimum 4 months at +75°F (+24°C). Refer to product label for most recent information.
POT LIFE	Minimum 4 months at +75°F (+24°C).
CLAMPING PRESSURE	20 to 40 psi (140 to 280 kN/m <sup>2</sup> ).
CURE REQUIREMENTS*	For two minutes, expose the adhesive on the strain gage and test article to an infrared lamp or other heat source until the materials are dry.  Monitor the temperature of the surface and do not allow materials to exceed +250°F (+120°C).  After clamping, cure 2 hours at +250°F (+120°C), increase temperature to +300°F (+150°C) for 2 hours, increase temperature to +340°F (+170°C) for 2 hours and finish cure with 4 hours at +380°F (+195°C).  <b>Recommended Postcure (Unclamped):</b> 1 hour at +300°F (+150°C), followed by 2 hours at +400°F (+205°C), and then 4 hours at +500°F (+260°C).

PACKAGING
<b>KIT</b>
1 brush-cap bottle [1 oz (30 ml)]

\* **Reference:** Instruction Bulletin B-181 for complete details.

Mylar and Teflon are Registered Trademarks of DuPont.

## Strain Gage Adhesive

### OTHER ACCESSORIES USED IN AN M-BOND 300 INSTALLATION:

- CSM Degreaser or GC-6 Isopropyl Alcohol
- Silicon-Carbide Paper
- M-Prep Conditioner A
- M-Prep Neutralizer 5A
- GSP-1 Gauze Sponges
- CSP-1 Cotton Tip Applicators
- PCT-2M Gage Installation Tape
- HSC Spring Clamp
- GT-14 Pressure Pads and Backup Plates



**RoHS**  
COMPLIANT



### DESCRIPTION

Special-purpose, two-component polyester adhesive. Not recommended as a general-purpose strain gage adhesive, but useful when a low-temperature-curing adhesive is required. While possessing the high shear strength required of a strain gage adhesive, peel strength and solvent sensitivity are relatively poor. Should not be used for impact strain measurements, or with solvent thinned protective coatings.

CHARACTERISTICS	
PARAMETER	DETAILS
OPERATING TEMPERATURE RANGE	<b>Long Term:</b> -40° to +300°F (-40° to +150°C)
ELONGATION CAPABILITIES	1% to 2% at +75°F (+24°C).
SHELF LIFE	Minimum 4 months at +75°F (+24°C). Refer to product label for most recent information.
POT LIFE	15 to 20 minutes at +40°F (+5°C); 5 to 8 minutes at +75°F (+24°C).
CLAMPING PRESSURE	5 to 20 psi (35 to 140 kN/m <sup>2</sup> ).
CURE REQUIREMENTS*	24 hours at +40°F (+5°C); 18 hours at +60°F (+15°C); 12 hours at +75°F (+24°C).

PACKAGING
<b>KIT</b>
6 mixing jars (10 g ea) Resin 6 calibrated pipettes 1 bottle (6 g) Catalyst 6 stirring rods

\* **Reference:** Instruction Bulletin B-133, "Strain Gage Installations with M-Bond 300 Adhesive", included in each kit.

## Strain Gage Cement

### OTHER ACCESSORIES USED IN AN NCC-3 CEMENT INSTALLATION:

- CSM Degreaser or GC-6 Isopropyl Alcohol
- Silicon-Carbide Paper
- M-Prep Conditioner A
- M-Prep Neutralizer 5A
- GSP-1 Gauze Sponges
- GT-11 Camel Hair Brush
- SPT-1 Double Blade Spatula



**RoHS**  
COMPLIANT

### DESCRIPTION

Single-part, silica-based ceramic cement for use with ZC-, ZWH-, and ZWN-Series high-temperature strain gages. Has superior bond strength to super-alloy materials, stainless steel, titanium, and other nonferrous alloys. **Not for use on mild steel.**

CHARACTERISTICS	
PARAMETER	DETAILS
OPERATING TEMPERATURE RANGE	-452°F to +1470°F (-269° to +800°C°).
ELONGATION CAPABILITIES	0.5% at +75°F (+24°C).
SHELF LIFE	12 months after date of manufacture. Store at +75°F (+24°C).
POT LIFE	2 weeks after opening. Refer to product label for most recent information.
TEMPERATURE COEFFICIENT OF EXPANSION	7 ppm/°F (12.6 ppm/°C).
CURE REQUIREMENTS	<p><b>Precoat:</b> Air-dry 30 minutes at +75°F (+24°C). Bake at +200°F (+93°C) for 30 minutes. Increase temperature to 400°F (204°C) for 30 minutes. Increase temperature to 600°F (315°C) for 30 minutes.</p> <p><b>Final Cure:</b> Air-dry 30 minutes at +75°F (+24°C). Bake at +200°F (+93°C) for 30 minutes. Increase temperature to 400°F (204°C) for 30 minutes. Increase temperature to 600°F (315°C) for 30 minutes.</p>

PACKAGING OPTION
1 bottle (1 oz/30 ml) cement



## Strain Gage Cement

### OTHER ACCESSORIES USED IN AN WC-16 CEMENT INSTALLATION:

- CSM Degreaser or GC-6 Isopropyl Alcohol
- Silicon-Carbide Paper
- M-Prep Conditioner A
- M-Prep Neutralizer 5A
- GSP-1 Gauze Sponges
- GT-11 Camel Hair Brush
- SPT-1 Double Blade Spatula



### DESCRIPTION

Single-part, alumina-based ceramic cement for use with ZC-, ZWH-, and ZWN-, and ZWP-Series high-temperature strain gages on materials with low thermal expansion coefficients. **Not for use on steel or other iron-based alloys.**

CHARACTERISTICS	
PARAMETER	DETAILS
OPERATING TEMPERATURE RANGE	-452°F to +1470°F (-269° to +800°C). Higher upper temperatures can be achieved on ceramic parts up to 2190°F (1200°C).
ELONGATION CAPABILITIES	0.5% at +75°F (+24°C).
SHELF LIFE	12 months after date of manufacture. Store at +75°F (+24°C).
POT LIFE	2 weeks after opening. Refer to product label for most recent information.
TEMPERATURE COEFFICIENT OF EXPANSION	4 ppm/°F (7.2 ppm/°C).
CURE REQUIREMENTS	<p><b>Precoat:</b> Air-dry 30 minutes at +75°F (+24°C). Bake at +200°F (+93°C) for 30 minutes. Increase temperature to 400°F (204°C) for 30 minutes. Increase temperature to 600°F (315°C) for 30 minutes.</p> <p><b>Final Cure:</b> Air-dry 30 minutes at +75°F (+24°C). Bake at +200°F (+93°C) for 30 minutes. Increase temperature to 400°F (204°C) for 30 minutes. Increase temperature to 600°F (315°C) for 30 minutes.</p>

PACKAGING OPTION
1 bottle (1 oz/30 ml) cement

## Strain Gage Cement

### OTHER ACCESSORIES USED IN AN HG-1 CEMENT INSTALLATION:

- CSM Degreaser or GC-6 Isopropyl Alcohol
- Silicon-Carbide Paper
- M-Prep Conditioner A
- M-Prep Neutralizer 5A
- GSP-1 Gauze Sponges
- GT-11 Camel Hair Brush
- SPT-1 Double Blade Spatula



### DESCRIPTION

Single-part ceramic cement for use with ZC-, ZWH-, and ZWN-Series high-temperature strain gages. Bonds well to most metals and porous ceramics. Thermal expansion coefficient closely matches that of steel. Contains Chromium VI. **Contains a substance which is restricted in the European Union.**

CHARACTERISTICS	
PARAMETER	DETAILS
OPERATING TEMPERATURE RANGE	-452°F to +1470°F (-269° to +800°C).
ELONGATION CAPABILITIES	0.5% at +75°F (+24°C).
SHELF LIFE	6 months after date of manufacture. Store at +75°F (+24°C).
POT LIFE	2 weeks after opening. Refer to product label for most recent information..
TEMPERATURE COEFFICIENT OF EXPANSION	6 ppm/°F (10.8 ppm/°C).
CURE REQUIREMENTS	<p><b>Precoat:</b> Air-dry 30 minutes at +75°F (+24°C). Bake at +200°F (+93°C) for 30 minutes. Increase temperature to 400°F (204°C) for 30 minutes. Increase temperature to 600°F (315°C) for 30 minutes.</p> <p><b>Final Cure:</b> Air-dry 30 minutes at +75°F (+24°C). Bake at +200°F (+93°C) for 30 minutes. Increase temperature to 400°F (204°C) for 30 minutes. Increase temperature to 600°F (315°C) for 30 minutes.</p>

PACKAGING OPTION
1 bottle (1 oz/30 ml) cement

## Strain Gage Cement

### OTHER ACCESSORIES USED IN A GC CEMENT INSTALLATION:

- CSM Degreaser or GC-6 Isopropyl Alcohol
- Silicon-Carbide Paper
- M-Prep Conditioner A
- M-Prep Neutralizer 5A
- GSP-1 Gauze Sponges
- GT-11 Camel Hair Brush
- SPT-1 Double Blade Spatula



**RoHS**  
COMPLIANT

### DESCRIPTION

Single-part ceramic cement for bonding free-filament strain gages (wire and foil). Recommended for installations on low-TCE materials such as carbon.

CHARACTERISTICS	
PARAMETER	DETAILS
OPERATING TEMPERATURE RANGE	-320°F to +2000°F (-195° to +1093°C).
ELONGATION CAPABILITIES	0.5% at +75°F (+24°C).
SHELF LIFE	Minimum 1 year at +75°F (+24°C). Refer to product label for most recent information.
POT LIFE	1 year at +75°F (+24°C).
TEMPERATURE COEFFICIENT OF EXPANSION	1.5 ppm/°F (2.7 ppm/°C).
CURE REQUIREMENTS*	<p><b>Precoat:</b> Air-dry 30 minutes at +75°F (+24°C), then 30 minutes at +200°F (+95°C) followed by 30 minutes at +300°F (+150°C).</p> <p><b>Final Coat:</b> Air-dry 30 minutes at +75°F (+24°C), then 30 minutes at +200°F (+95°C) followed by 30 minutes at +300°F (+150°C), and final 1 hour at +600°F (+315°C).</p>

PACKAGING OPTIONS
<b>KIT</b>
1 bottle (1 oz/30 ml) premixed.

\* **Reference:** Instruction Bulletin B-177 for complete details.

## Strain Gage Cement

### OTHER ACCESSORIES USED IN AN H CEMENT INSTALLATION:

- CSM Degreaser or GC-6 Isopropyl Alcohol
- Silicon-Carbide Paper
- M-Prep Conditioner A
- M-Prep Neutralizer 5A
- GSP-1 Gauze Sponges
- GT-11 Camel Hair Brush
- SPT-1 Double Blade Spatula
- H Cement Thinner



### DESCRIPTION

Single-part ceramic cement/coating. Excellent electrical insulation properties, even at +1600°F (+870°C). Good adhesion to most metals. **Contains a substance which is restricted in the European Union.**

CHARACTERISTICS	
PARAMETER	DETAILS
OPERATING TEMPERATURE RANGE	-452°F to +1600°F (-269° to +870°C°).
ELONGATION CAPABILITIES	0.5% at +75°F (+24°C).
SHELF LIFE	Minimum 1 year at +75°F (+24°C). Refer to product label.
POT LIFE	Minimum 1 year at +75°F (+24°C). Refer to product label.
TEMPERATURE COEFFICIENT OF EXPANSION	7.0 ppm/°F (13 ppm/°C).
CURE REQUIREMENTS	<p><b>Precoat:</b> Air-dry 30 minutes at +75°F (+24°C), then 30 minutes at +200°F (+95°C) followed by 30 minutes at +350°F (+177°C).</p> <p><b>Final Coat:</b> Air-dry 30 minutes at +75°F (+24°C), then 30 minutes at +200°F (+95°C) followed by 30 minutes at +350°F (+177°C), and final 1 hour at +600°F (+315°C).</p>

PACKAGING OPTIONS		
KITS		
1 bottle (1 oz/30 ml) cement	H CEMENT KIT A	H CEMENT KIT B
	2 bottles Cement (1 oz/30 ml ea) 1 bottle Thinner (0.5 oz/15 ml) 1 bottle Conditioner A (2 oz/60 ml) 1 bottle Neutralizer 5A (2 oz/60 ml) 1 package 100-count CSP-1 Cotton Swabs 1 package 200-count GSP-1 Gauze Sponges 12 sheets 400-grit Silicon-Carbide Paper (2 in x 4.5 in/50 mm x 115 mm ea)	Same as H Cement Kit A except with 6 bottles cement (1 oz/30 ml ea)

## Strain Gage Cement

### OTHER ACCESSORIES USED IN A PBX CEMENT INSTALLATION:

- CSM Degreaser or GC-6 Isopropyl Alcohol
- Silicon-Carbide Paper
- M-Prep Conditioner A
- M-Prep Neutralizer 5A
- GSP-1 Gauze Sponges
- GT-11 Camel Hair Brush
- SPT-1 Double Blade Spatula



**RoHS**  
COMPLIANT



### DESCRIPTION

Two-part ceramic cement/coating with excellent electrical insulating properties up to +1200°F (+650°C). Recommended as a high-temperature cement and coating for free-filament strain gages (wire and foil) and thermocouple applications. Provides good adhesion to most metals. **Contains a substance which is restricted in the European Union.**

CHARACTERISTICS	
PARAMETER	DETAILS
OPERATING TEMPERATURE RANGE	-452°F to +1200°F (-269° to +650°C).
ELONGATION CAPABILITIES	0.5% at +75°F (+24°C).
SHELF LIFE	Minimum 1 year at +75°F (+24°C). Refer to product label for most recent information.
POT LIFE	Minimum 1 year at +75°F (+24°C). Refer to product label for most recent information.
TEMPERATURE COEFFICIENT OF EXPANSION	7.0 ppm/°F (13 ppm/°C).
CURE REQUIREMENTS*	<p><b>Precoat:</b> Air-dry 30 minutes at +75°F (+24°C), then 30 minutes at +200°F (+95°C) followed by 30 minutes at +300°F (+150°C).</p> <p><b>Final Coat:</b> Air-dry 30 minutes at +75°F (+24°C), then 30 minutes at +200°F (+95°C) followed by 30 minutes at +300°F (+150°C), and final 1 hour at +600°F (+315°C).</p>

PACKAGING OPTIONS
<b>KIT</b>
1 jar powder (1 lb/454 gm) 1 bottle solvent (9 oz/279 ml)

\* **Reference:** Instruction Bulletin B-179 for complete details.

## Strain Gage Cement

### OTHER ACCESSORIES USED IN A SAUEREISEN DKS-8 INSTALLATION:

- CSM Degreaser or GC-6 Isopropyl Alcohol
- Silicon-Carbide Paper
- M-Prep Conditioner A
- M-Prep Neutralizer 5A
- CSP-1 Cotton Tip Swabs
- GSP-1 Gauze Sponges
- GT-11 Camel Hair Brush
- SPT-1 Double Blade Spatula



**RoHS**  
COMPLIANT

### DESCRIPTION

Single-part chemical-setting, inorganic, Zircon-based cement supplied as a powder and mixed with water. High electrical-insulation and thermal-conductivity values. Used for installing high-temperature free-filament strain gages.

CHARACTERISTICS	
PARAMETER	DETAILS
OPERATING TEMPERATURE RANGE	-452°F to +2500°F (-269° to +1370°C).
ELONGATION CAPABILITIES	0.5% at +75°F (+24°C).
SHELF LIFE	Minimum 1 year at +75°F (+24°C). Refer to product label for most recent information.
POT LIFE	Minimum 1 year at +75°F (+24°C). Refer to product label for most recent information.
TEMPERATURE COEFFICIENT OF EXPANSION	2.6 ppm/°F (4.7 ppm/°C).
CURE REQUIREMENTS*	18 to 24 hours at +75°F (+24°C). Application of heat will accelerate cure time.
RECOMMENDED POSTCURE (UNCLAMPED)	1 hour at 50°F (30°C) above maximum operating temperature.

PACKAGING OPTION
<b>KIT</b>
1 bottled powder (4 oz/115 gm)

\* **Reference:** Instruction Bulletin B-182 for complete details.

# Installation Tools and Accessories

## CONTENTS

### Tools

SSH-1 .....	46
STW-1 .....	46
BTW-1 .....	46
DPR-1 .....	46
SSC-1 .....	46
SSC-2 .....	46
SSS-1 .....	46
SSS-2 .....	46
DP-1 .....	46
DWC-1 .....	46
NNP-1 .....	46
ATS-2 .....	46
GT-11 .....	47
SPT-1 .....	47
SPT-2 .....	47
MHG-1 .....	47
MHG-2 .....	47

### General-Purpose Tapes and Materials

PCT-2M .....	47
PDT-3 .....	47
PLY-001 .....	47

### High-Temperature Tapes and Materials

MJG-2 .....	48
TFT-2 .....	48
FGC-1 .....	48
TFE-2 .....	48



### Clamping Supplies

HSC-1 .....	48
HSC-2 .....	48
HSC-3 .....	48
GT-12 .....	48
TFE-1 .....	48
GT-14 .....	48
SGP-1 .....	48
SGP-2 .....	48

## General Information and Selection

There is a strong element of craftsmanship involved in making consistently successful strain gage installations. As for any other field, this craft has its own special tools and working materials—found by seasoned professionals to be most effective for achieving the desired results. The installation accessories described on this and the following pages represent the distillation of many years' experience in determining the most appropriate tool or material for each task in the gage installation process.

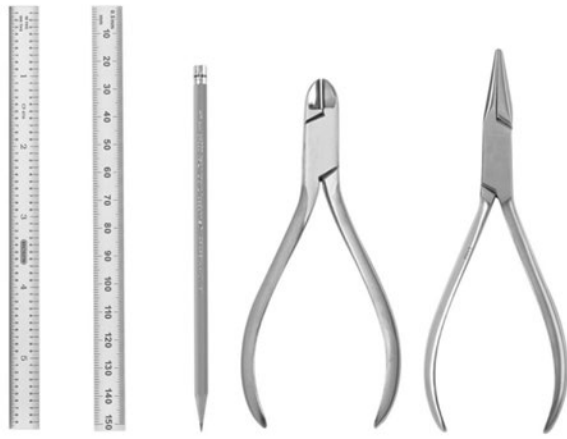

Every accessory item listed here has been thoroughly tested and evaluated in the Micro-Measurements Applications Engineering Laboratory for quality and reliability, for ease of use, and for compatibility with all other Micro-Measurements products. It should be noted that the instruction bulletins supplied for gages, adhesives, protective coatings, etc. assume the availability of these accessories to the user, since such is generally the case for an experienced practitioner in a well-equipped laboratory.

<b>TOOLS</b>	
 SSH-1	<p><b>SSH-1 SURGICAL SHEARS:</b> Chromium steel, 4-1/2 in (115 mm) long, with one sharp pointed blade and one blunt-end blade.</p> <p><b>STW-1 TWEEZERS:</b> Stainless steel, 4-1/2 in (115 mm) long. Rugged, precision ground sharp ends. Primarily used for handling leadwires.</p> <p><b>BTW-1 TWEEZERS:</b> Stainless steel, 4-1/2 in (115 mm) long. Antimagnetic; acid and corrosion resistant. Thin, flat blunt ends ideal for safe handling of strain gages.</p> <p><b>DPR-1 DENTAL PROBE:</b> Stainless steel "pick". Flexible 75° pointed tip.</p> <p><b>SSC-1 SURGICAL SCALPEL AND BLADE:</b> Stainless steel, uses SSC-2 snap-in replacement blade.</p> <p><b>SSC-2 REPLACEMENT SCALPEL BLADES:</b> Five blades per package. Not shown.</p> <p><b>SSS-1 STEEL SCALE:</b> 6 in (150 mm) long, satin-chromed finish. Graduated in inches (1/32, 1/64, 1/10, 1/100).</p> <p><b>SSS-2 STEEL SCALE:</b> 6 in (150 mm) long, satin-chromed finish. Graduated in inches (1/10, 1/100) and millimeters (0.5, 1).</p> <p><b>DP-1 4-H DRAFTING PENCIL:</b> For gage layout.</p> <p><b>DWC-1 DIAGONAL CUTTERS:</b> Stainless steel, 4-1/2 in (115 mm) long, precision cutter for wire up to AWG No. 18 (1 mm diameter).</p> <p><b>NNP-1 NEEDLE-NOSED PLIERS:</b> Nickel-chrome plated, 4-1/2 in (115 mm) long, with serrated needle-nosed jaws.</p> <p><b>ATS-2 GAGE APPLICATION TOOL SET:</b> Includes one of each item plus one additional DPR-1 Dental Probe. Durable, polypropylene box. Not shown.</p>
 STW-1 BTW-1 DPR-1 SSC-1	
 SSS-1 SSS-2 DP-1 DWC-1 NNP-1	















General Information and Selection

TOOLS	
<p><b>GT-11</b></p> 	<p><b>GT-11 CAMEL'S HAIR BRUSH</b> 3/8 in (9.5 mm).</p>
<p><b>SPT-1</b></p> 	<p><b>SPT-1 STAINLESS STEEL MIXING SPATULA</b> Double blade. Overall length 8 in (200 mm).</p>
<p><b>SPT-2</b></p> 	<p><b>SPT-2 STAINLESS STEEL MIXING SPATULA:</b> Single blade. Overall length 7-3/4 in (195 mm). Wooden handle.</p>
<p><b>MHG-1</b></p> 	<p><b>MHG-1 MASTER MITE HEAT GUN:</b> Lightweight, compact, perfectly balanced. 2 lb (0.9 kg) with nozzle attached. 8-7/8 x 7 in (225 x 180 mm). Quiet, brush- less-type shaded pole motor rated for continuous duty. Three interchangeable nozzle heating elements control average outlet temperature 1/2 in (13 mm) from nozzle at +500°F (+260°C), +650°F (+345°C), or +800°F (+425°C). Air- cooled barrel. Three-conductor grounded linecord. Slip-on deflector completely surrounds shrinkable tubing (HST-1) with heat. Pinpoint adapter directs heat without affecting adjacent areas. 120Vac, 60Hz. Maximum current draw 5.4 amps.</p> <p><b>MHG-2 MASTER MITE HEAT GUN:</b> Same as above, except 220 Vac.</p>

GENERAL-PURPOSE TAPES & MATERIALS	
<p><b>PCT-2M</b></p>  <p><b>PDT-3</b></p>  <p><b>PLY-001</b></p> 	<p><b>PCT-2M GAGE INSTALLATION TAPE:</b> For gage handling. 3/4 in x 75 ft (19 mm x 23 m).</p> <p><b>PDT-3 PAPER DRAFTING TAPE:</b> For soldering mask, and lead positioning. 0.75 in x 400 in (19 mm x 10.1 m).</p> <p><b>PLY-001 Kapton® Film:</b> For electrical insulation, 4 x 10 x 0.001 in thick (100 x 250 x 0.02 mm thick).</p> <p><b>Store all at or near +75°F (+24°C).</b></p>

## General Information and Selection

HIGH-TEMPERATURE TAPES & MATERIALS	
 <p><b>MJG-2</b></p>  <p><b>TFT-2</b></p>  <p><b>FGC-1</b></p>  <p><b>TFE-2</b></p>	<p><b>MJG-2 MYLAR® TAPE:</b> For gage handling with heat-curing resin systems. 1/2 in x 216 ft (13 mm x 66 m).</p> <p><b>TFT-2 THERMOSETTING [+340°F (+170°C)] FIBERGLASS TAPE:</b> For electrical insulation at high temperatures. 1/2 in x 180 ft (13 mm x 55 m).</p> <p><b>FGC-1 WOVEN FIBERGLASS CLOTH:</b> Bound edges. For lead anchoring when used in conjunction with M-Bond adhesives and M-Coat protective coatings. 0.015 in x 1 in x 50 yd (0.4 mm x 25 mm x 46 m).</p> <p><b>TFE-2 HIGH MODULUS TFE TEFLON® WITH SILICONE MASTIC:</b> 1/2 in x 108 ft (13 mm x 33 m).</p> <p><b>Store all at or near +75°F (+24°C).</b></p>

CLAMPING SUPPLIES	
 <p><b>HSC-1</b></p>  <p><b>HSC-2</b></p>  <p><b>HSC-3</b></p>	 <p><b>GT-12</b></p>  <p><b>TFE-1</b></p>  <p><b>GT-14</b></p>  <p><b>SGP-2</b></p>  <p><b>SGP-1</b></p>
<p><b>HSC-1 SPRING CLAMP:</b> <i>Maximum Opening:</i> 1 in (25 mm). <i>Maximum Recommended Opening:</i> 1/2 in (13 mm). <i>Nominal Clamp Force at Recommended Opening:</i> 20 lbf (89 N).</p> <p><b>HSC-2 SPRING CLAMP:</b> <i>Maximum Opening:</i> 2 in (51 mm). <i>Maximum Recommended Opening:</i> 1 in (25 mm). <i>Nominal Clamp Force at Recommended Opening:</i> 24 lbf (107 N).</p> <p><b>HSC-3 SPRING CLAMP:</b> <i>Maximum Opening:</i> 3 in (76 mm). <i>Maximum Recommended Opening:</i> 1-1/2 in (38 mm). <i>Nominal Clamp Force at Recommended Opening:</i> 30 lbf (133 N).</p>	<p><b>GT-12 NEGATOR CONSTANT FORCE EXTENSION SPRING CLAMP:</b> 1 x 0.006 x 38 in (25 mm x 0.4 mm x 0.97 m) stainless steel band, drum I.D. 1.16 in (30 mm), 10.6 lb (47 N) load.</p> <p><b>TFE-1 TEFLON FILM:</b> 0.003 in x 1 in x 50 ft (0.08 mm x 25 mm x 15 m).</p> <p><b>GT-14 PRESSURE PADS AND BACKUP PLATES:</b> Kit of 12 Silicone Rubber Pads 3/32 x 1/2 x 1-1/4 in (2.5 x 13 x 32 mm), and 12 aluminum plates, 1/8 x 1/2 x 1-1/4 in (3 x 13 x 32 mm).</p> <p><b>SGP-1 SILICONE RUBBER:</b> Three pieces, each 3/32 x 1 x 6 in (2.5 x 25 x 150 mm).</p> <p><b>SGP-2 SILICONE RUBBER:</b> One piece, 3/32 x 6 x 6 in (2.5 x 150 x 150 mm).</p>

Mylar and Teflon are Registered Trademarks of DuPont.

# Bondable Terminals

## CONTENTS

CEG-25C .....	50
CPF-25C .....	50
CEG-38C .....	50
CPF-38C.....	50
CEG-50C .....	50
CPF-50C.....	50
CEG-75C .....	50
CPF-75C.....	50
CEG-100C .....	50
CPF-100C.....	50
CEG-150C .....	50
CPF-150C.....	50
CEG-50D .....	51
CPF-50D.....	51
CEG-60D .....	51
CPF-60D.....	51
CEG-75D .....	51
CPF-75D.....	51
CEG-100D .....	51
CPF-100D.....	51
CPF-AST .....	51
CEG-21S .....	51
CEG-42S .....	51
CEG-63S .....	51
CEG-83S .....	51

## Terminal Details and Descriptions

For many types of strain gages (i.e., Micro-Measurements EA-Series), instrument leadwires generally should not be attached directly to the solder tabs of the gage. Instead, the normal practice is to install bondable terminals adjacent to the gage and solder the instrument leadwires to these. Small, flexible jumper wires, curved to form strain relief loops, are then connected from the terminals to the gage solder tabs. The accompanying drawings show typical strain gage terminal installations (see also Application Note TT-603. "The Proper Use of Bondable Terminals in Strain Gage Applications").



**RoHS**  
COMPLIANT

### TERMINAL CONSTRUCTION

Micro-Measurements bondable terminals are specially designed for use in strain gage circuits. They are produced from 0.0014-in (0.036-mm) thick, copper foil, laminated on either of two types of backing material. Both backings are readily bondable with strain gage adhesives. Terminals are offered in four different geometries, and in a range of sizes to suit varying gage installation needs.

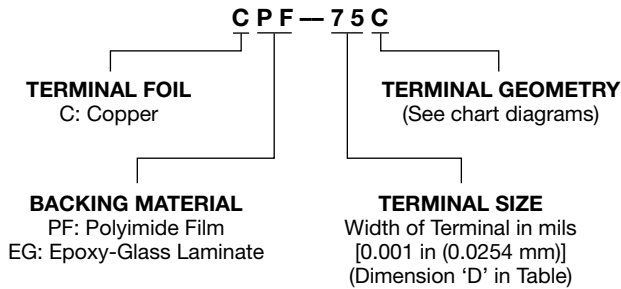

### BACKING MATERIALS

#### TYPE PF POLYIMIDE FILM:





0.003 in (0.08 mm) thick. This is the preferred general-purpose backing material. It is more flexible and conformable than the Type EG, although not as strong. Type PF backing combines high-temperature capability, resistance to soldering damage and good electrical properties. It is suitable for long-term use at +450° to +500°F (+230° to +260°C), limited primarily by gradual oxidation of the copper foil interface. The relatively high thermal expansion coefficient of unfilled polyimide can cause loss of bond at temperatures below -100°F (-75°C).

#### TYPE EG EPOXY-GLASS LAMINATE:



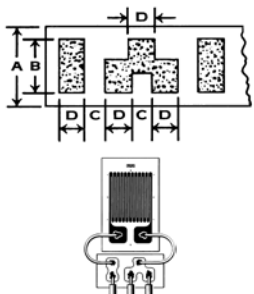

0.005 in (0.13 mm) thick. This special laminate provides a strong but flexible backing for terminals. It is suitable for long-term use at +300°F (+150°C), and is recommended for cryogenic applications at temperatures down to -452°F (-269°C). The radius of curvature of the mounting surface should generally be greater than 1/8 in (3 mm).

Terminal Detail and Description	Terminal Pattern (Actual Size)	Dimensions "A" dimensions nominal				Order Number	Package Strips of 4 Pairs
		A	B	C	D		
<p><b>Suffix C:</b> General-purpose. Widely used between gage jumper wires and main leadwire system. Suitable for many bridge intraconnection applications.</p>		0.11 (2.7)	0.065 (1.65)	0.025 (0.64)	0.025 (0.64)	CEG-25C CPF-25C	70
		0.14 (3.4)	0.095 (2.41)	0.030 (0.76)	0.038 (0.97)	CEG-38C CPF-38C	60
		0.18 (4.5)	0.125 (3.18)	0.036 (0.91)	0.050 (1.27)	CEG-50C CPF-50C	50
		0.25 (6.4)	0.190 (4.83)	0.040 (1.02)	0.075 (1.91)	CEG-75C CPF-75C	30
		0.33 (8.4)	0.250 (6.35)	0.070 (1.78)	0.100 (2.54)	CEG-100C CPF-100C	20
		0.48 (12.1)	0.375 (9.53)	0.070 (1.78)	0.150 (3.81)	CEG-150C CPF-150C	10

Terminal Details and Descriptions

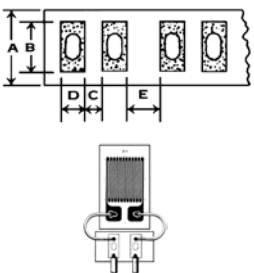
Terminal Detail and Description	Terminal Pattern (Actual Size)	Dimensions "A" dimensions nominal				Order Number	Package Strips of 4 Pairs
		A	B	C	D		
 <p><b>Suffix D:</b> Designed for installations with 2-wire jumper arrangement to gage and a 3-wire main lead system.</p>		0.18 (4.5)	0.125 (3.18)	0.036 (0.91)	0.050 (1.27)	CEG-50D CPF-50D	30
		0.21 (5.3)	0.150 (3.81)	0.038 (0.97)	0.060 (1.52)	CEG-60D CPF-60D	25
		0.25 (6.4)	0.190 (4.83)	0.040 (1.02)	0.075 (1.91)	CEG-75D CPF-75D	20
		0.33 (8.4)	0.250 (6.35)	0.050 (1.27)	0.100 (2.54)	CEG-100D CPF-100D	15

Terminal Assortment	Order Number	Package Strips of 4 Pairs
Contains 2 strips of C and D patterns, except 1 strip of the 150C and 100D designs	CPF-AST	18

Terminal Detail and Description	Terminal Pattern (Actual Size)	Dimensions "A" dimensions nominal					Order Number	Package Pairs
		A	B	C	D	E		
 <p><b>Suffix S:</b> Primarily used where soldering and desoldering may be encountered. Hole in center produces thermal isolation at each end of terminal. Not recommended for high cyclic endurance. Available only in epoxy-glass backing.</p>		0.13 (3.2)	0.063 (1.60)	0.021 (0.53)	0.021 (0.53)	0.042 (1.07)	CEG-21S	200
		0.21 (5.2)	0.125 (3.18)	0.042 (1.07)	0.042 (1.07)	0.084 (2.13)	CEG-42S	100
		0.29 (7.4)	0.190 (4.83)	0.063 (1.60)	0.063 (1.60)	0.126 (3.20)	CEG-63S	100
		0.37 (9.4)	0.250 (6.35)	0.083 (2.11)	0.083 (2.11)	0.166 (4.22)	CEG-83S	60



# Solders and Accessories

## CONTENTS

### Solders

361A-20R .....	54
361-40R.....	54
430-20S.....	54
450-20R.....	54
450-20S.....	54
570-28R.....	54
1240-FPA.....	54

### Flux and Rosin Solvent Kits

FAR-2 .....	55
AR-2 .....	55
RSK-1 .....	55
RSK-2 .....	55
RSK-4 .....	55
FSS-1 .....	55

### Soldering Units

M5S-1.....	55
M5S-2 .....	55
M5S-4.....	55
M5S-4A .....	55
M5S-4B .....	55
M5S-4C .....	55
M5S-4D .....	55
M5S-4E .....	55
WRS-1 .....	56
WRS-2 .....	56
WRS-3 .....	56

## Solders, Fluxes, Kits, and Soldering Units

The quality of the solder joints is a critical element in the performance of any strain gage installation. Because of special requirements associated with strain gage circuitry, many commercial solders and fluxes are not satisfactory for this purpose. Micro-Measurements stocks and distributes a selection of solders and fluxes that have been carefully tested and qualified for use with strain gages.

applications. For ordering purposes, the solders are specified according to the coding system shown at right. All solders are supplied on spools, except for the 1240-FPA paste, which is supplied in a jar.

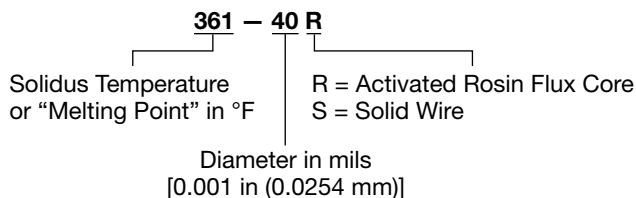

### SOLDERS

Strain gage solders are listed at right, along with their compositions, principal properties, and recommended

<b>SOLDER SELECTION CHART</b>							
Solder Type (See Note 1)	Packaging		Solidus/ Liquidus Temperature	Wetting and Flow	Mech. Strength	Electrical Conductivity	Corrosion Resistance
	Order No.	Unit Size					
<b>361A-20R</b> 63%Tin 36.65% Lead 0.35% Antimony	361A-20R-25	25 ft (7.6 m)	361°/361°F [183°/183°C]	Excellent	Very Good	High	Good
	361A-20R	1 lb (450 g)					
Best all-around solder for general use. Also capable of use at cryogenic temperature. Three-year shelf life.							
<b>361-40R</b> 63%Tin 37% Lead	361-40R-15	15 ft (4.6 m)	361°/361°F [183°/183°C]	Excellent	Very Good	High	Good
	361-40R	1 lb (450 g)					
General use with heavy leadwires. Not recommended for use at cryogenic temperatures. Three-year shelf life.							
<b>430-20S</b> 96.3% Tin 3.7% Silver	430-20S-25	25 ft (7.6 m)	430°/430°F [221°/221°C]	Excellent	Very Good	Best	Excellent
	430-20S	1 lb (450 g)					
Recommended for use where high electrical conductivity is required. Good mechanical fatigue properties. Do not use at cryogenic temperatures. Shelf life is indefinite.							
<b>450-20R</b> 95% Tin 5% Antimony	450-20R-25	25 ft (7.6 m)	450°/460°F [232°/238°C]	Excellent	Very Good	High	Good
	450-20R	1 lb (450 g)					
Higher temperature solder with very good handling properties. Can be used with M-Flux AR or M-Flux SS. Presence of antimony prevents "tin disease"; can be used in cryogenic environments, although quite brittle at low temperatures. Three-year shelf life.							
<b>450-20S</b> 95% Tin 5% Antimony	450-20S-25	25 ft (7.6 m)	450°/460°F [232°/238°C]	Excellent	Very Good, Hard	High	Good
	450-20S	1 lb (450 g)					
Higher temperature solder with very good handling properties. Can be used with M-Flux AR or M-Flux SS. Presence of antimony prevents "tin disease"; can be used in cryogenic environments, although quite brittle at low temperatures. Shelf life is indefinite.							
<b>570-28R</b> 93.5% Lead 5% Tin 1.5% Silver	570-28R-20	20 ft (6.1 m)	565°/574°F [296°/301°C]	Very Good	Very Good, Hard	Fair	Fair
	570-28R	1 lb (450 g)					
High-lead content. For high-temperature connections and long-term use at cryogenic temperature. Three-year shelf life.							
<b>1240-FPA</b> 40% Silver 28% Zinc 30% Copper 2% Nickel	1240-FPA	1 oz (28 g)	1220°/1435°F (660°/780°C)	Excellent	Excellent	High	Good
	For very-high-temperature solder joints, generally with WK-Series strain gages. The WRS-1 Resistance Soldering Unit is an ideal tool for use with this solder. Has a shelf life of 9 months.						

**Note 1:** Products shown in bold are RoHS compliant.



**Solders, Fluxes, Kits, and Soldering Units**

**FLUXES**

With solid wire solders, it is necessary to use separate, externally applied fluxes. Even with rosin-core solders, flux may be helpful when soldering fine jumper wires to gage tabs or printed-circuit terminals, because not enough flux is released from the cored solder. It may also be necessary to supplement the cored flux in high-temperature solders such as Type 570.

Two fluxing compounds are available for strain gage soldering applications. M-Flux AR-2 is an active but noncorrosive rosin flux that is effective on constantan, copper, and nickel. M-Flux SS is a very active acid flux

that is used primarily with solid-wire solders applied to isoelastic and K-alloy gages, and to stainless steel. The two fluxes should never be mixed. Whether the rosin or acid flux is used, it must be completely removed immediately after soldering to prevent degradation of protective coatings and corrosion of the metals, and to eliminate conductive flux residues. Rosin residues are best removed with *M-LINE* Rosin Solvent. Removal of M-Flux SS requires two steps: liberal applications of M-Prep Conditioner A, which must be blotted dry; and then M-Prep Neutralizer 5A, also to be blotted dry.

<b>FLUX AND ROSIN SOLVENT KITS</b> (See Note 1)	
<b>M-Flux FAR-2 Kit</b>	Two 1-oz (30-ml) brush-cap bottles M-Flux AR-2 Two 1-oz (30-ml) brush-cap bottles <i>M-LINE</i> Rosin Solvent
<b>M-Flux AR-2 Bulk</b>	Twelve 1-oz (30-ml) brush-cap bottles M-Flux AR-2
<b>RSK-1 <i>M-LINE</i> Rosin Solvent Kit</b>	Twelve 1-oz (30-ml) brush-cap bottles
<b>RSK-2 <i>M-LINE</i> Rosin Solvent Bulk</b>	1-qt (960-ml) bottles
<b>RSK-4 <i>M-LINE</i> Rosin Solvent Kit</b>	Four 1-oz (30-ml) brush-cap bottles
<b>FSS-1 M-Flux SS Kit</b>	One 1-oz (30-ml) applicator cap bottle M-Flux SS One 1-oz (30-ml) brush-cap bottle M-Prep Conditioner A One 1-oz (30-ml) brush-cap bottle M-Prep Neutralizer 5A

**Note 1:** All products shown are RoHS compliant.

<b>MARK V SOLDERING STATION</b>	
	<p>A time-proven precision soldering instrument for miniature and/or delicate soldering applications. Full 25-watt rating in 17 selector positions to handle all <i>M-LINE</i> solder alloys except 1240-FPA. Specify 115 or 220 Vac, 50 or 60 Hz operation.</p> <ul style="list-style-type: none"> <li><b>M5S-1</b> <b>Mark V Soldering Station, Soldering Pencil, and one Type A Chisel Tip</b></li> <li><b>M5S-2</b> <b>Mark V Control Unit only</b></li> <li><b>M5S-4</b> <b>Mark V Soldering Pencil</b> (includes one Type A tip)</li> <li><b>M5S-4A</b> <b>Mark V Type A Chisel Tip</b> (1.2 mm)</li> <li><b>M5S-4B</b> <b>Mark V Type B Conical Tip</b> (1.0 mm)</li> <li><b>M5S-4C</b> <b>Mark V Type C Chisel Tip</b> (0.8 mm)</li> <li><b>M5S-4D</b> <b>Mark V Type D Conical Tip</b> (0.4 mm)</li> <li><b>M5S-4E</b> <b>Mark V Type E Special Solder Tip</b> (0.25 mm)</li> </ul>

## Solders, Fluxes, Kits, and Soldering Units

### RESISTANCE SOLDERING UNIT



Used in combination with 1240-FPA silver-solder paste, this unit makes an excellent lead attachment system for strain gage operation above +500°F (+260°C). The variable power control allows adjustment from zero to 100 watts and zero to 3 Vac. The power control is fused, and a pilot light is incorporated. The foot switch and tweezing soldering handpiece give excellent operator control over each solder joint. Includes power unit and foot switch, both with three-wire NEMA plugs, tweezing soldering handpiece, and replacement electrodes.

**WRS-1 Resistance Soldering Unit, 110 Vac**

**WRS-2 Resistance Soldering Unit, 220 Vac (not CE rated)**

**WRS-A Replacement Electrodes, package of 6**

### REFERENCES

Application Note TT-606, "Soldering Techniques for Lead Attachment to Strain Gages with Solder Dots."

Application Note TT-602, "Silver Soldering Technique for Attachment of Leads to Strain Gages."

Application Note TT-609, "Strain Gage Soldering Techniques."

# Wire, Cable and Accessories

## CONTENTS

General Information and Selection.....	58
<b>Single-Conductor Wire</b>	
134-AWP .....	59
136-AWP .....	59
127-AWN .....	59
130-AWN .....	59
134-AWN .....	59
136-AWN .....	59
127-AWQ .....	59
130-AWQ .....	59
134-AWQ .....	59
126-GWF .....	59
137-HWN .....	59
142-JWN .....	59
126-DWV .....	59
126-FWK .....	59
130-FWT .....	59
<b>Three-Conductor Cable</b>	
322-DJV .....	60
326-DFV .....	60
330-DFV .....	60
326-BSV .....	60
326-DTV .....	60
326-DSV .....	60
330-FFE .....	60
330-FJT .....	60
336-FTE .....	60
326-FTE .....	60
330-FTE .....	60
326-GJF .....	60
<b>Four-Conductor Cable</b>	
426-DFV .....	61
430-DFV .....	61
422-DSV .....	61
424-DSV .....	61
426-BSV .....	61
426-DTV .....	61
430-FST .....	61
426-FTE .....	61
436-FTT .....	61
426-FFT .....	61
<b>Flat-Ribbon Lead (Uninsulated)</b>	
1-GL-64-001 .....	61
1-KL-16-002 .....	61
1-KL-08-003 .....	61
1-KL-08-005 .....	61
<b>Accessories</b>	
HST-1 .....	62
WTS-1 .....	62
WTS-2 .....	62
WTS-A .....	62

## General Information and Selection

Different strain gage installation conditions and test specifications often necessitate the use of different types or sizes of leadwires. For accurate, reliable strain measurements, it is important to use an appropriate type of leadwire for each installation. Micro-Measurements stocks a wide variety of wires and cables, cataloged in tabular form on the following pages. All wires and cables listed in the tables have been proven in the field to give excellent sensor performance when properly used in the specified environments. Special gage wiring problems may require the use of wires not listed here. In such cases, our Applications Engineering Department can recommend appropriate wire types and can suggest suppliers.



### WIRE AND CABLE CODING SYSTEM

3 26 — D F V  
 Number of Conductors ———— 3  
 AWG (American Wire Gauge) Wire Size ———— 26

#### Types of Wire

- A:** Solid copper
- B:** Stranded copper
- D:** Tinned stranded copper
- F:** Silver-plated stranded
- G:** Nickel-clad solid copper
- H:** Solid Manganin
- J:** Solid Balco®

#### Construction

- F:** Flat cable
- J:** Twisted cable with jacket
- S:** Shielded/twisted with jacket
- T:** Twisted cable without jacket
- W:** Round single wire

#### Insulation

- E:** Etched TFE Teflon®
- F:** Fiberglass braid
- K:** Kapton® (polyimide) wrap
- N:** Nylon/polyurethane enamel
- P:** Polyurethane enamel
- Q:** Polyimide enamel
- T:** TFE Teflon®
- V:** Vinyl (PVC)

AWG	Diameter (nominal)		AWG	Diameter (nominal)	
	in	(mm)		in	(mm)
22	0.0253	0.643	34	0.0063	0.160
26	0.0159	0.404	36	0.0050	0.127
27	0.0142	0.361	37	0.0045	0.114
30	0.0100	0.254	42	0.0025	0.064

Balco is a Registered Trademark of W.B. Driver Company.  
 Teflon and Kapton are Registered Trademarks of DuPont.

\*Solid core wire

### RIBBON WIRE CODING SYSTEM

1 G L 64 001  
 Number of Conductors ———— 1  
 Alloy ———— G  
 Thickness, in mils ———— 64  
 Width ———— 001  
**G:** NiClad copper  
**K:** Nichrome V  
**L:** Uninsulated ribbon  
**64:** 1/64 in (0.4 mm)  
**16:** 1/16 in (1.6 mm)  
**08:** 1/8 in (3.2 mm)

The Wire and Cable Coding System shown above gives the unique designation of each wire type for ordering purposes. The leadwire and cabling selection charts presented on the next three pages are organized

according to the number of conductors. All wires and cables are supplied on spools for user convenience. Some styles may not be continuous length.

#### References:

- Application Note: TT-601, Techniques for Bonding Leadwires to Surfaces Experiencing High Centrifugal Forces.
- Application Note: TT-604, Leadwire Attachment Techniques for Obtaining Maximum Fatigue Life of Strain Gages.
- Application Note: TT-608, Techniques for Attaching Leadwires to Unbonded Strain Gages.







General Information and Selection

		SINGLE-CONDUCTOR TYPES: SOLID WIRE		
		Type	Packaging	Description
			Foot (Meter)*	
<p>AWP    AWN</p> <p>AWQ    GWF</p> <p>HWN    JWN</p>	<b>134-AWP</b> <b>136-AWP</b>	500 ft (150 m) 500 ft (150 m)	<b>Solid copper wire, polyurethane enamel:</b> General-purpose intragage hookup wire. Useful from -100° to +300°F (-75° to +150°C). Enamel coating easily removed by applying heat from soldering iron.	<p><b>RoHS</b> COMPLIANT</p>
	<b>127-AWN</b> <b>130-AWN</b> <b>134-AWN</b> <b>136-AWN</b>	500 ft (150 m) 500 ft (150 m) 500 ft (150 m) 500 ft (150 m)	<b>Solid copper wire, nylon/polyurethane enamel:</b> Identical in use and specifications to Type AWP above, but with superior abrasion resistance and slightly reduced insulation resistance at elevated temperatures. 134-AWN and 136-AWN are available in four colors; specify: -R (red), -W (white), -B (black), -G (green).	
	<b>127-AWQ</b> <b>130-AWQ</b> <b>134-AWQ</b>	500 ft (150 m) 500 ft (150 m) 500 ft (150 m)	<b>Solid copper wire, polyimide enamel:</b> Intragage hookup wire. Temperature range -452° to +600°F (-269° to +315°C) short term. Enamel is extremely tough and abrasion resistant, with excellent electrical properties; generally removed by mechanical scraping or sanding.	
	<b>126-GWF</b> <b>126-GWF</b>	100 ft (30 m) 1000 ft (300 m)	<b>Solid nickel-clad copper wire, fiberglass braid insulation:</b> Useful from -452° to +900°F (-269° to +480°C). Recommended for use with WK-Series gages when silver solder is used for lead attachment.	
	<b>137-HWN</b>	200 ft (60 m)	<b>Solid manganin wire, nylon/polyurethane enamel:</b> Used for bridge balance and span set in transducer circuits. Nominal resistance: 14 ohms/ft (50 ohms/m). Temperature range: +10° to +125°F (-10° to +50°C).	
	<b>142-JWN</b>	500 ft (150 m)	<b>Solid Balco® wire, nylon/polyurethane enamel:</b> Used for bridge temperature compensation of zero shift or span. Nominal resistance: 19 ohms/ft (65 ohms/m). Temperature coefficient of resistance: +0.25%/°F (+0.45%/°C). Temperature range: +10° to +300°F (-10° to +150°C).	
		SINGLE-CONDUCTOR TYPES: STRANDED WIRE		
		Type	Packaging	Description
			Foot (Meter)*	
<p>DWV    FWK    FWT</p>	<b>126-DWV</b>	100 ft (30 m)	<b>Stranded tinned-copper wire, vinyl insulation:</b> General-purpose leadwire. Useful to +180°F (+80°C). Vinyl insulation becomes brittle at low temperature; not normally used below -60°F (-50°C). Specify red, white, black, or green.	<p><b>RoHS</b> COMPLIANT</p>
	<b>126-FWK</b>	25 ft (7.5 m)	<b>Stranded silver-plated copper wire, Kapton® polyimide insulation:</b> High- performance. Recommended for unusually severe service from -452° to over +600°F (-269° to +315°C) short term. Excellent resistance to abrasion, radiation, and outgassing in high vacuum. Treated for bondability.	
	<b>130-FWT</b>	100 ft (30 m)	<b>Stranded silver-plated copper wire, Teflon® insulation:</b> Wide temperature range. Useful from -452° to +500°F (-269° to +260°C). When bonding to Teflon-insulated wire, insulation must be treated with Tetra-Etch® compound (see "Special-Purpose Materials.") Specify red, white, black, or green.	

\*Some types may not be continuous length.

Balco is a Registered Trademark of W.B. Driver Company.  
 Kapton and Teflon are Registered Trademarks of DuPont.  
 TetraEtch is a Registered Trademark of W.L. Gore.











## General Information and Selection

		THREE-CONDUCTOR CABLE		Description	
		Type	Packaging Foot (Meter)*		
 <p>DJV DFV</p>	322-DJV	500 ft (150 m)	Stranded tinned-copper wire, 3-conductor twisted cable, chrome PVC vinyl jacket, vinyl insulation: Good choice for use with EGP-Series Embedment Strain Gages. Color-coded red/white/black.	 <p>Pb-free RoHS COMPLIANT</p>	
	326-DFV 326-DFV 330-DFV 330-DFV	100 ft (30 m) 1000 ft (300 m) 100 ft (30 m) 1000 ft (300 m)	Stranded tinned-copper wire, 3-conductor flat cable, vinyl insulation: Convenient general-purpose cable. For use from -60° to +180°F (-50° to +80°C). Flat construction requires minimum space. Color-coded red/white/black.		
	326-BSV 326-BSV	100 ft (30 m) 1000 ft (300 m)	Stranded copper wire, 3-conductor twisted cable, PVC insulated, braided shield: For use from -60° to 180°F (-50° to +80°C).		
	326-DTV 326-DTV	100 ft (30 m) 1000 ft (300 m)	Stranded tinned-copper wire, 3-conductor twisted cable, vinyl insulation: Convenient general-purpose cable for low electrical noise pickup. For use from -60° to +180°F (-50° to +80°C). Color-coded red/white/black.		
	326-DSV 326-DSV	100 ft (30 m) 1000 ft (300 m)	Stranded tinned-copper wire, 3-conductor twisted cable, vinyl insulation, braided shield, vinyl jacket: Special-purpose cable to minimize electrical noise interference. Useful from -60° to +180°F (-50° to +80°C). Color-coded red/white/black.		
 <p>BSV DTV DSV</p>					
 <p>FFE</p>	330-FFE 330-FFE	100 ft (30 m) 1000 ft (300 m)	Stranded silver-plated copper wire, 3-conductor flat cable, etched Teflon® insulation: For use from -452°F to +500°F (-269°C to +260°C). Color-coded red/white/black. Insulation treated for bonding.	 <p>Pb-free RoHS COMPLIANT</p>	
 <p>FJT FTE GJF</p>	330-FJT 330-FJT	100 ft (30 m) 1000 ft (300 m)	Stranded silver-plated copper wire, 3-conductor twisted cable, Teflon insulation, Teflon jacket: Small, flexible. For use from -452° to +500°F (-269° to +260°C). Color-coded red/white/black. When bonding Teflon-insulated wire, insulation must be treated with Tetra-Etch® compound (see "Special-Purpose Materials.")	 <p>Pb-free RoHS COMPLIANT</p>	
	336-FTE	50 ft (15 m)	Stranded silver-plated copper wire, 3-conductor twisted cable, etched Teflon insulation: Small, flexible cable. For use from -452° to +500°F (-269° to +260°C). Color-coded red/white/black. Insulation treated for bonding.		
	326-FTE 326-FTE 330-FTE 330-FTE	100 ft (30 m) 500 ft (150 m) 100 ft (30 m) 500 ft (150 m)	Stranded silver-plated copper wire, 3-conductor twisted cable, etched Teflon insulation: For use from -452° to +500°F (-269° to +260°C). Color-coded red/white/black. Insulation treated for bonding.		
	326-GJF 326-GJF	100 ft (30 m) 1000 ft (300 m)	Solid nickel-clad copper wire, 3-conductor twisted cable, fiberglass braid insulation and jacket: For use from -452° to +900°F (-269° to +480°C). Recommended for use with WK-Series gages when silver solder is used for lead attachment. Color-coded red/white/black.		

\*Some types may not be continuous length.

Teflon is a Registered Trademark of DuPont.  
TetraEtch is a Registered Trademark of W.L. Gore.

General Information and Selection

FOUR-CONDUCTOR CABLE			
Type	Packaging	Description	
	Foot (Meter)*		
 BSV	100 ft (30 m)	<b>Stranded copper wire, 4-conductor twisted cable, PVC insulated braided shield:</b> For use from -60° to +180°F (-50°C to +80°C).	
	1000 ft (300 m)		
 DFV	100 ft (30 m)	<b>Stranded tinned-copper wire, 4-conductor flat cable, vinyl insulation:</b> For use from -60° to +180°F (-50° to +80°C). Conductors easily separated for stripping and wiring. Color-coded red/white/black/green.	
	1000 ft (300 m)		
	100 ft (30 m)		
	1000 ft (300 m)		
 DSV	100 ft (30 m)	<b>Stranded tinned-copper wire, 4-conductor polypropylene insulated:</b> Twisted shielded pairs (red/black and white/green) with a drain wire, PVC jacket. For use from -60° to +180°F (-50°C to +80°C).	
	1000 ft (300 m)		
	100 ft (30 m)		
	1000 ft (300 m)		
 DTV	100 ft (30 m)	<b>Stranded tinned-copper wire, 4-conductor twisted cable, vinyl insulation:</b> For use from -60° to +180°F (-50° to +80°C). Color-coded red/white/black/green.	
	1000 ft (300 m)		
 FST	100 ft (30 m)	<b>Stranded silver-plated copper wire, 4-conductor twisted cable, Teflon® insulation, braided shield, Teflon jacket:</b> Small, flexible cable. For use from -452° to +500°F (-269° to +260°C). Color-coded red/white/black/green. When bonding Teflon-insulated wire, insulation must be treated with Tetra-Etch® compound (see Special-Purpose Materials, document number 11008).	 RoHS COMPLIANT
	1000 ft (300 m)		
 FTE/FTT	100 ft (30 m)	<b>Stranded silver-plated copper wire, 4-conductor twisted cable, etched Teflon insulation:</b> For use from -452° to +500°F (-269° to +260°C). Color-coded red/white/black/green. Insulation treated for bonding.	
	500 ft (150 m)		
 FFT	100 ft (30 m)	<b>Stranded silver-plated copper wire, 4-conductor twisted cable, Teflon® insulation:</b> Small, flexible cable. For use from -452° to +500°F (-269° to +260°C). Color coded red, white, black, green. When bonding Teflon insulated wire, insulation must be treated with Teflon etchant, such as TEC-1 (see Special-Purpose Materials, document number 11008).	
	500 ft (150 m)		
 FFT	100 ft (30 m)	<b>Stranded silver-plated copper wire, 4-conductor flat cable, Teflon® insulation:</b> For use from -452° to +500°F (-269° to +260°C). Color coded red, white, black, green. When bonding Teflon insulated wire, insulation must be treated with a Teflon etchant, such as TEC-1 (see Special-Purpose Materials, document number 11008).	
	500 ft (150 m)		
FLAT RIBBON LEAD (UNINSULATED)			
Type	Packaging	Description	
	Foot (Meter)*		
	50 ft (15 m)	<b>Uninsulated flat ni-clad copper ribbon:</b> 1/64 in wide x 0.001 in thick (0.4 x 0.025 mm). For use from -452 to 900°F (-269 to +480°C). Can be easily soldered or spot welded.	 RoHS COMPLIANT
	50 ft (15 m)	<b>Uninsulated Nichrome V:</b> 1/16 in wide x 0.002 in thick (1.6 x 0.05 mm). For use from -452 to +2000°F (-269 to +1100°C).	
	50 ft (15 m)	<b>Uninsulated Nichrome V:</b> 1/8 in wide x 0.003 in thick (3.2 x 0.08 mm). For use from -452 to +2000°F (-269 to +1100°C).	
	50 ft (15 m)	<b>Uninsulated Nichrome V:</b> 1/8 in wide x 0.005 in thick (3.2 x 0.127 mm). For use from -452 to +2000°F (-269 to +1100°C).	

\*Some types may not be continuous length.

Teflon is a Registered Trademark of DuPont.  
TetraEtch is a Registered Trademark of W.L. Gore.

## General Information and Selection

### HST-1 HEAT-SHRINKABLE WIRE SPLICE SEALANT



Fast, easy-to-use method for protecting wire splice connections. Constructed of irradiated polyolefin plastic tubing with a heat-flowable inner liner sealant. Forms an immediate and tight seal to splice connection at a shrink temperature of +275°F (+135°C). Inside diameter before heating is 0.125 in (3.2 mm); after heating, 0.023 in (0.6 mm). Large range of shrinkage allows use with leadwire insulation diameters from 0.03 to 0.11 in (0.75 to 2.8 mm). The operating temperature range is -65° to +230°F (-55° to +110°C). Package of eight 6-in (150-mm) lengths.

### THERMAL WIRE STRIPPER



The ease and simplicity of operation of the Thermal Wire Stripper make it ideal for most strain gage leadwire stripping. The variable heat control allows stripping of all thermoplastic insulations, including Teflon®, in sizes No. 18 to No. 36 AWG (1 to 0.1 mm diameter). The foot switch and tweezer hand- piece give excellent operator control over the stripping operation. Includes power unit and foot switch, both with 3-wire NEMA plugs, and tweezer handpiece.

**WTS-1:** 110 Vac

**WTS-2:** 220 Vac (not CE rated)

**WTS-A Replacement Elements:** Set of two.

Teflon is a Registered Trademark of DuPont.



# Protective Coatings

## CONTENTS

General Information .....	64
M-Coat A.....	66
M-Coat B.....	67
M-Coat C.....	68
M-Coat D.....	69
M-Coat F .....	70
M-Coat FBT.....	71
M-Coat JA .....	72
M-Coat W-1 .....	73
3140 RTV.....	74
3145 RTV.....	75
M-Bond AE-10 .....	76
M-Bond AE-15 .....	76
M-Bond 43-B .....	77
M-Bond GA-61.....	78
Barrier E.....	79
Barrier WD .....	80
Gagekote #5.....	81
Gagekote #8.....	82
Gagekote #11.....	83

## General Information

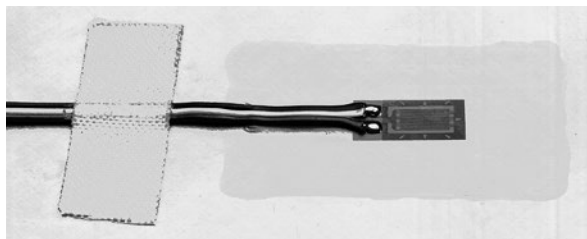

M-Coat A—General-purpose “transparent” polyurethane.



M-Coat W-1—Microcrystalline wax.

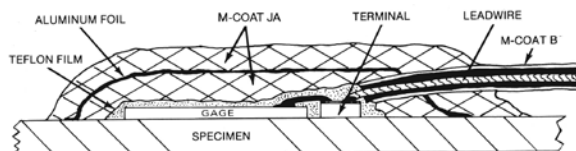

Cross-sectional view of typical long-term installation.

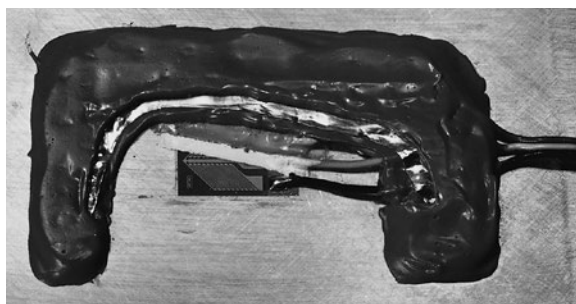

Recommended protective coating system for gage installations that must operate submerged in water for long periods of time.

Strain gage performance is easily degraded by the effects of moisture, chemical attack, or mechanical damage. As a result, gages require varying degrees of protection according to the severity of the environment in which they must operate. While it is often practical to operate fully encapsulated gages without additional protection, in laboratory applications, open-faced gages should always be covered with a suitable coating as soon as possible after installation.

The coating compounds described on the following pages have been formulated specifically for use in protecting strain gage installations from damaging environmental conditions. The range of materials is adequate for handling the majority of gage protection requirements. In an air-conditioned laboratory, for instance, a single layer of M-Coat A would ordinarily provide sufficient protection against moisture, fingerprints, and other contaminants. When the gage installation must operate in a more severe environment, alternate coatings or combinations of coatings can be employed as illustrated above.

To serve as a preliminary guide for coating selection, the chart on the next page gives recommended coating systems for a variety of typical environments. The effectiveness of these materials and procedures has been experimentally validated on numerous occasions. However, application technique is also an important factor in the performance of any gage protection system. It is therefore good practice, particularly in the case of long-term installations, to verify by test that the system performs as required.

Teflon is a Registered Trademark of DuPont.  
Tetra-Etch is a Registered Trademark of W.L. Gore.

### APPLICATION NOTES FOR PROTECTIVE COATINGS

1. For long-term tests, or in particularly hostile environments, carefully clean the surface before applying any protective coating. Coating extending into uncleaned areas will eventually loosen.
2. When several layers of coating are required, extend each overcoat beyond the previous layer.
3. Incomplete protection around leadwires is a common cause of moisture penetration into gage installations. (Many commercial leadwire insulations contain pinholes.)
4. Seal wire splices with HST-1 Heat Shrinkable Tubing.
5. Before applying any protective coating to an unprotected installation that has been exposed to high humidity, dry the installation thoroughly.
6. If the coating is a room-temperature-curing type, the moisture absorption rate can be decreased by postcuring at an elevated temperature.
7. Generally, a thick coating offers a more resistant path to moisture absorption than a thin one.
8. For a further vapor barrier, apply an intermediate layer of metal foil (aluminum, such as M-Coat FA-2, or stainless steel), or TFE Teflon® film (first treated with TEC-1 Tetra-Etch® compound for optimum bond). Since moisture can only penetrate around the edges of the foil or film, the path to the gage is much longer.
9. To evaluate protective coatings for long-term testing, monitor the zero-shift of the gage. Resistance-to-ground measurements can also indicate deterioration.

General Information

<b>PLANNING FOR RELIABLE STRAIN GAGE INSTALLATIONS</b>		
<b>ENVIRONMENT</b>	<b>PREFERRED</b>	<b>ALTERNATE</b>
<b>TYPICAL LABORATORY</b>		
50%, or lower, relative humidity	M-Coat A	M-Coat C, or M-Coat D, or M-Coat F
<b>FIELD APPLICATIONS</b>		
Outdoor installations, shielded from rain and snow	M-Coat F	M-Coat JA
<b>HIGH HUMIDITY, WATER SPLASH</b>		
Laboratory and field applications under damp or wet conditions	<b>Short Term:</b> 3140 RTV <b>Long Term:</b> M-Coat W-1 Wax	<b>Short Term:</b> 3145 RTV <b>Long Term:</b> M-Coat F
<b>WATER IMMERSION</b>		
Short-term, fresh water or salt water	Teflon® + M-Coat B (on vinyl-insulated leadwires) + M-Coat JA	M-Coat W-1 Wax
Long-term, fresh water	Per diagram and photo on previous page	M-Coat W-1 Wax, or M-Coat F
Long-term, salt water	Per diagram and photo on previous page + metal cap and conduit for leadwires	None
High-pressure water	Per diagram and photo on previous page	M-Coat F, or M-Coat W-1 Wax for short-term
<b>STEAM</b>		
+212°F (+100°C), long-term installation	Hermetically sealed metal cap, and conduit for leadwires	None
<b>CONCRETE SURFACES</b>		
Long-term	Per diagram and photo on previous page, preceded by M-Bond AE-10	M-Bond GA-61 to seal concrete surface
<b>OILS AND GASOLINE</b>		
Commercial oils, to +180°F (+80°C), gasoline, and kerosene	M-Coat D + two or three layers of M-Coat B	3145 RTV + M-Coat B
Synthetic oils, to +200°F (+95°C)	Two or three layers of M-Bond 43B	M-Bond GA-61
<b>HIGH-TEMPERATURE AIR</b>		
To +500°F (+260°C), with good mechanical protection	<b>Short Term:</b> M-Bond GA-61	3145 RTV

## Protective Coating

### FEATURES

- Easy to use
- Transparent
- Good general-purpose coating for laboratory use

### DESCRIPTION

Air-drying solvent-thinned (xylene) polyurethane. Transparent. Moderate hardness; good flexibility. Can be removed with *M-LINE* Rosin Solvent or toluene. Film thickness 0.005–0.01 in (0.1–0.25 mm) per coat.

General-purpose coating for lab use, and as base coating for field applications. Must be fully cured before addition of other coatings. Fair moisture resistance. Not readily attacked by many solvents. Convenient to use.



**RoHS**  
COMPLIANT

CHARACTERISTICS	
PARAMETER	DETAILS
CURE REQUIREMENTS	<p>Dries tack-free at room temperature in 20 minutes. Completely dry in 2 hours.</p> <p>Normal cure 24 hours at room temperature. Chemical resistance and coating hardness increase for 6 to 7 days.</p>
OPERATING TEMPERATURE RANGE	<p><b>Short Term:</b> –100° to +300°F (–75° to +150°C).</p> <p><b>Long Term:</b> –100° to +250°F (–75° to +120°C).</p>
SHELF LIFE	<p>Minimum 1 year at +75°F (+24°C). Refer to product label for most recent information.</p>

PACKAGING OPTIONS	
KIT	BULK
4 brush-cap bottles [1 oz (30 ml) ea].	Quart container.

## Protective Coating

### FEATURES

- Good resistance to chemicals
- Air drying
- Also used for priming leadwires



**RoHS**  
COMPLIANT

### DESCRIPTION

Air-drying solvent-thinned (MEK) nitrile rubber. Forms flexible rubbery coating. Do not use directly on exposed foil or bare leads. Often used to prime vinyl-insulated wire to improve bondability to other coatings. If used as primer on leads, thin 50:50 with MEK. Flexible at cryogenic temperatures. Excellent resistance to gasoline, kerosene, commercial oils. Electrical properties poorer than other M-Coats, particularly at elevated temperatures.



CHARACTERISTICS	
PARAMETER	DETAILS
CURE REQUIREMENTS	<p>Air-dries in 1 hour at +75°F (+24°C). Do not apply subsequent protective coatings for at least 2 hours from time of application. Normal cure 24 hours at room temperature.</p> <p>Further improve chemical resistance with 1 hour bake at +200°F (+95°C).</p>
OPERATING TEMPERATURE RANGE	<p><b>Short Term:</b> -320° to +300°F (-195° to +150°C).</p> <p><b>Long Term:</b> -320° to +200°F (-195° to +95°C).</p>
SHELF LIFE	<p>Minimum 1 year at +75°F (+24°C). Refer to product label for most recent information.</p>

PACKAGING OPTIONS	
KIT	BULK
4 brush-cap bottles [1 oz (30 ml) ea].	Quart container.

## Protective Coating

### FEATURES

- Air drying
- Low reinforcement
- Transparent

### DESCRIPTION

Solvent-thinned (naphtha) RTV silicone rubber. Cures to tough, rubbery transparent film. Good all-around mechanical and electrical properties. Completely noncorrosive. Film thickness 0.015–0.02 in (0.4–0.5 mm) per coat.

Recommended for lab and field installations that require a high degree of protection in thin coatings. Good water-splash protection. Good chemical resistance.



**RoHS**  
COMPLIANT

CHARACTERISTICS	
PARAMETER	DETAILS
CURE REQUIREMENTS	<p>Solvents evaporate in about 60 minutes at room temperature. Allow 20 minutes drying time between coats.</p> <p>Cures in 24 hours at +75°F (+24°C) and 50% RH. Longer cure at lower humidity.</p>
OPERATING TEMPERATURE RANGE	<p><b>Short Term:</b> –75° to +550°F (–60° to +290°C).</p> <p><b>Long Term:</b> –75° to +500°F (–60° to +260°C).</p>
SHELF LIFE	<p>Minimum 9 months at +75°F (+24°C) kept tightly sealed. Refer to product label for most recent information.</p>

PACKAGING OPTIONS	
KIT	BULK
4 brush-cap bottles [1 oz (30 ml) ea].	Quart container.

## Protective Coating

### FEATURES

- Air drying
- Opaque
- Good base coating

### DESCRIPTION

Air-drying solvent-thinned (toluene) acrylic. Dense white color for easy visual inspection of coverage. Forms hard thin coating capable of high elongation. Can be removed with *M-LINE* Rosin Solvent or toluene. Apply in thin coats to prevent solvent entrapment. Film thickness 0.005–0.01 in (0.1–0.25 mm) per coat.

Good general laboratory moisture barrier. Electrical leakage negligible even when uncured. Good base coating for subsequent applications of M-Coat B. Convenient for anchoring and insulating intrabridge wiring and jumper leads. Chemical resistance only fair but can be improved by postcure at +175°F (+80°C) for 30 minutes.



**RoHS**  
COMPLIANT

CHARACTERISTICS	
PARAMETER	DETAILS
CURE REQUIREMENTS	Air dry for 15 minutes then cure for 24 hours at +75°F (+24°C) or one hour at +150°F (+65°C).  Overcoats can be applied 30 minutes from time of application.  Coating binder begins to sublimate at +280°F (+140°C), but residue is inorganic and will not become conductive.
OPERATING TEMPERATURE RANGE	<b>Short Term:</b> –100° to +325°F (–75° to +160°C).  <b>Long Term:</b> –100° to +250°F (–75° to +120°C).
SHELF LIFE	Minimum 1 year at +75°F (+24°C) kept tightly sealed. Refer to product label for most recent information.

PACKAGING OPTIONS	
KIT	BULK
4 brush-cap bottles [1 oz (30 ml) ea].	Quart container.

## Protective Coating

### FEATURES

- Excellent for outdoor applications
- No cure required
- Versatile

### DESCRIPTION

Kit of selected materials easily applied in various combinations. Provides environmental and mechanical protection. Particularly well-suited to field applications where conditions are not ideal. Typical applications include pipelines, tunnels, bridges, reinforcement bars in concrete structures, heavy machinery, ships, aircraft, motor vehicles, and pressure vessels.



CHARACTERISTICS	
PARAMETER	DETAILS
CURE REQUIREMENTS	No mixing or curing required.
OPERATING TEMPERATURE RANGE	<p><b>Short Term:</b> -70° to +250°F (-55° to +120°C).</p> <p><b>Long Term:</b> -20° to +175°F (-30° to +80°C).</p>
SHELF LIFE	<p>Minimum 1 year at +75°F (+24°C). Refer to product label for most recent information.</p>

PACKAGING OPTIONS	
KIT	BULK
<p>12 pieces [4-1/2 in x 3-3/4 in x 1/8 in ±1/32 in (115 x 95 x 3.2 mm ±0.8 mm)] each:</p> <ul style="list-style-type: none"> <li>• M-Coat FB Butyl Rubber Sealant</li> <li>• M-Coat FN Neoprene Rubber Sheets</li> </ul> <p>1 roll [0.003 in x 2 in x 20 ft (0.08 mm x 50 mm x 6 m)] M-Coat FA Aluminum Foil Tape</p> <p>2 brush-cap bottles [1/2 oz (15 ml) ea] M-Coat B Air-Drying Nitrile Rubber Coating</p> <p>M-Coat FT Teflon® Tape</p>	<p>25 pieces M-Coat FB-2 Butyl Rubber Sealant</p> <p>25 pieces M-Coat FN-2 Neoprene Rubber Sheets</p> <p>1 roll [20 ft (6 m)] M-Coat FA-2 Aluminum Foil Tape</p> <p>4 brush-cap bottles [1 oz (30 ml) ea] M-Coat B Air-Drying Nitrile Rubber Coating</p> <p>10 pieces [1 x 20 x 0.003 in (25 x 500 x 0.08 mm) ea] M-Coat FT Teflon® Tape</p>

Teflon is a Registered Trademark of DuPont.



## Protective Coating

### FEATURES

- Excellent protection from moisture
- Low reinforcement
- Easy to apply



**RoHS**  
COMPLIANT



### DESCRIPTION

Solvent-thinned butyl rubber designed to provide excellent moisture protection with low reinforcement effects. Principally used in transducers. Exhibits a paste-like consistency and is normally applied with a spatula. Thickness over 0.1 in (2.5 mm) not recommended.

CHARACTERISTICS	
PARAMETER	DETAILS
CURE REQUIREMENTS	Air dry 8 hours, followed by an elevated temperature cure of +150° to +175°F (+65° to +80°C) for 4 to 6 hours.
OPERATING TEMPERATURE RANGE	0° to +175°F (-20° to +80°C).
SHELF LIFE	Minimum 12 months at +75°F (+24°C). Refer to product label for most recent information.

PACKAGING OPTIONS	
KIT	BULK
75g collapsible tubes, 4 each	Quart container.

## Protective Coating

### FEATURES

- Excellent resistance to moisture
- Good resistance to chemicals
- Good protection against mechanical damage
- Room-temperature cure

### DESCRIPTION

Two-part polysulfide liquid polymer compound. Can be applied in coating thickness of 1/8 in (3 mm) without flowing on vertical surfaces. Tough, flexible coating. No weighing required. Uncured coating can be removed with CSM Degreaser, Rosin Solvent, or MEK.

General-purpose coating. Good protection against oil, grease, most acids and alkalis, and most solvents. Strong solvents may cause swelling and softening with time. Concentrated acids eventually break down coating. Good salt-water immersion coating.



**RoHS**  
COMPLIANT

CHARACTERISTICS	
PARAMETER	DETAILS
CURE REQUIREMENTS	Mixed pot life 120 minutes at +77°F (+25°C). Normal cure in 24 hours at +77°F (+25°C).
OPERATING TEMPERATURE RANGE	<b>Short Term:</b> -65°F to +360°F (-54°C to +182°C°). <b>Long Term:</b> -65°F to +250°F (-54°C to +121°C°).
SHELF LIFE	At least 9 months when stored between +40° to +80°F in original unopened containers. Refer to product label for most recent information.

PACKAGING OPTIONS	
M-COAT JA-1 KIT	M-COAT JA-3 KIT
1 mixing dispenser [2 fl oz (59 ml)]  1 piece M-Coat FT Teflon® Tape, 1 x 20 x 0.003 in (25 x 500 x 0.08 mm).	3 mixing dispensers [2 fl oz (59 ml) ea]  3 pieces M-Coat FT Teflon® Tape, 1 x 20 x 0.003 in (25 x 500 x 0.08 mm) ea.

## Protective Coating

### FEATURES

- Outstanding moisture protection
- Easy to apply
- No cure required

### DESCRIPTION

Microcrystalline wax. Has very low water-vapor transmission rate. Attacked by most solvents. Coating thickness 0.015–0.06 in (0.4–1.5 mm).

Excellent water-immersion coating. Poor mechanical protection. Often used as an intermediate coating.



**RoHS**  
COMPLIANT

CHARACTERISTICS	
PARAMETER	DETAILS
APPLICATION REQUIREMENTS	Heat to at least +170°F (+75°C) to melt. For best wetting and sealing, heat specimen surface to at least +100°F (+45°C) before applying. No cure required.
OPERATING TEMPERATURE RANGE	0° to +150°F (–20° to +65°C)
SHELF LIFE	No limit. Store at +75°F (+24°C).

PACKAGING OPTIONS	
PARAMETER	DETAILS
KIT	5 tins [1 oz (28g)]
BULK	1 package [5 lb (2.25 kg)]

## Protective Coating

### FEATURES

- Easy to use
- Translucent
- Self-leveling
- Room-temperature cure



### DESCRIPTION

Single-component 98%-solids RTV silicone rubber. Room-temperature cure (humidity-reactive). Completely non-corrosive. Forms tough, rubbery coating. Excellent properties. Translucent; permits full inspection of installation. Self-leveling; forms fairly thick coats 0.03–0.06 in (0.75–1.5 mm).

Easy-to-apply general-purpose coating. Lab and field use. Low reinforcing effects. High-elongation capabilities. Good for short-term water immersion. Resists many chemicals. Bonds to contaminated surfaces for short-term tests; for best long-term protection, chemically clean surface and prime with *M-LINE* RTV Primer No. 1.

CHARACTERISTICS	
PARAMETER	DETAILS
CURE REQUIREMENTS	Tack-free in approximately 2 hours. Cure 24 hours at +75°F (+24°C), 50% RH for each 0.02-in (0.5-mm) thickness. Longer cure at lower humidity levels. Note: Will not cure properly if coating is not exposed to atmosphere.
OPERATING TEMPERATURE RANGE	–49°F to +392°F (–45°C to +200°C).
SHELF LIFE	Minimum 6 months at +75°F (+24°C). Refer to product label for most recent information..

PACKAGING OPTIONS	
KIT	OPTIONAL PRIMER
1 collapsible metal tube [3 oz (85g)]	4 brush-cap bottles [1 oz (30 ml) ea] RTV Primer No. 1

## Protective Coating

### FEATURES

- Easy to use
- Good mechanical protection
- Good cable anchor
- Room-temperature cure

### DESCRIPTION

Single-component 98%-solids RTV silicone rubber. Room temperature cure (humidity-reactive). Completely non-corrosive. Forms tough, rubbery coating. Excellent properties. Opaque gray coating of higher strength and toughness than 3140 RTV. Not self-leveling.

Easy-to-apply general-purpose coating. Lab and field use. Low reinforcing effects. High-elongation capabilities. Good for short-term water immersion. Resists many chemicals. Bonds to contaminated surfaces for short-



**RoHS**  
COMPLIANT

term tests; for best long-term protection, chemically clean surface and prime with *M-LINE* RTV Primer No. 1. Very thick coatings can be applied without sag or runoff. Tear strength much higher than 3140. Good cable anchor.

CHARACTERISTICS	
PARAMETER	DETAILS
CURE REQUIREMENTS	Tack-free in approximately 2 hours. Cure 24 hours at +75°F (+24°C), 50% RH for each 0.02-in (0.5-mm) thickness. Longer cure at lower humidity levels. Note: Will not cure properly if coating is not exposed to atmosphere.
OPERATING TEMPERATURE RANGE	-49°F to +392°F (-45°C to +200°C).
SHELF LIFE	Minimum 6 months at +75°F (+24°C). Refer to product label for most recent information.

PACKAGING OPTIONS	
KIT	OPTIONAL PRIMER
1 collapsible metal tube [3 oz (85g)]	4 brush-cap bottles [1 oz (30 ml) ea] RTV Primer No. 1

## Protective Coating

### FEATURES

- Thin, hard coating
- Good electrical and mechanical protection
- Good leadwire anchor
- Also used as an adhesive

### DESCRIPTION

Two-component 100%-solids epoxy systems. Primarily used as an adhesive. Often used as protective coatings because of low vapor-transmission rate. AE-15 is superior but requires heat cure. Single coating thickness 0.005-0.015 in (0.1–0.4 mm).

Primarily used where a thin hard coating is required to resist water immersion for short time. Good electrical/mechanical protection where high velocity fluids are present and minimum disturbance to flow is necessary. Good leadwire anchor. Often used as precoat for sealing concrete.



M-Bond AE-10

M-Bond AE-15

CHARACTERISTICS	
PARAMETER	DETAILS
CURE REQUIREMENTS	<p><b>AE-10:</b> Minimum cure 6 hours at +75°F (+24°C).</p> <p><b>AE-15:</b> 6 hours at +125°F (+50°C).</p> <p>To accelerate cure at higher temperatures, see cure schedules for M-Bond AE-10 and M-Bond AE-15.</p>
POT LIFE	<p><b>AE-10:</b> Mixed pot life 15-20 minutes.</p> <p><b>AE-15:</b> 1-1/2 hours at +75°F (+24°C).</p>
OPERATING TEMPERATURE RANGE	-100° to +200°F (-75° to +95°C)
SHELF LIFE	Minimum 12 months at +75°F (+24°C); or 18 months at +40°F (+5°C). Refer to product label for most recent information.

PACKAGING	
KIT	BULK
6 mixing jars AE Resin (10 g ea) 1 bottle Curing Agent 10 or 15 [1/2 oz (15 ml)]	1 bottle AE Resin (200 g) 1 bottle Curing Agent 10 (40 g) or 1 bottle Curing Agent 15 (25 g)

## Protective Coating

### FEATURES

- Excellent chemical, electrical and mechanical properties
- Thin, hard coating
- Excellent in transducer service
- Also used as an adhesive
- Elevated-temperature cure

### DESCRIPTION

Solvent-thinned (MEK and xylene) single-component epoxy resin compound. Primarily used as an adhesive. Cured coating 0.002–0.01 in (0.05–0.25 mm) thick.

Provides excellent chemical, electrical, and mechanical properties when fully cured. Film is hard, with high heat distortion temperature. Excellent in transducer service.



**RoHS**  
COMPLIANT



CHARACTERISTICS	
PARAMETER	DETAILS
CURE REQUIREMENTS	<b>Minimum Cure:</b> 2 hours at +375°F (+190°C)
OPERATING TEMPERATURE RANGE	<b>Short Term:</b> –452° to +400°F (–269° to +205°C)  <b>Long Term:</b> –452° to +300°F (–269° to +150°C)
SHELF LIFE	Minimum 9 months at +75°F (+24°C); or 18 months at +40°F (+5°C). Refer to product label for most recent information.

PACKAGING	
KIT	SINGLE BOTTLE
4 brush-cap bottles [1 oz (30 ml) ea] premixed adhesive	1 brush-cap bottle [1 oz (30 ml)] premixed adhesive

## Protective Coating

### FEATURES

- Excellent mechanical and chemical protection.
- Good leadwire anchor.
- Also used as an adhesive
- Elevated-temperature cure.

### DESCRIPTION

Two-component 100%-solids, elevated-temperature-curing epoxy system. Very high viscosity. Generally applied with a spatula, and can be contoured to the surface. Coating thickness 0.005–0.03 in [0.1–0.75 mm).

Commonly used for mechanical protection at elevated temperatures and in highly reactive hot synthetic oils such as in aircraft engines. Very good leadwire anchor to high g-fields (see Tech Note TT-601. Can be used to fill slots or grooves. Can be machined after cure.



CHARACTERISTICS	
PARAMETER	DETAILS
CURE REQUIREMENTS	6 hours at +250°F (+120°C), or 3 hours at +300°F (+150°C), or 2 hours at +350°F (+175°C), or 1 hour at +400°F (+205°C).
MIXED POT LIFE	10 hours at +75°F (+24°C); increased by refrigeration, indefinite by freezing.
OPERATING TEMPERATURE RANGE	<b>Short Term:</b> –100° to +500°F (–75° to +260°C) <b>Long Term:</b> –100° to +400°F (–75° to +205°C)
SHELF LIFE	Minimum 6 months at +75°F (+24°C); refrigeration recommended. Refer to product label for most recent information.

PACKAGING
KIT
3 mixing jars ea Resin and Hardener (45 g).



## Protective Coating

### FEATURES

- No cure required
- Quick application
- Excellent mechanical protection
- Resistant to water penetration.

### DESCRIPTION

Single-component butyl rubber patch with vinyl carrier. Quick application, even at low temperature. Excellent mechanical protection. Resistant to water penetration.



**RoHS**  
COMPLIANT

CHARACTERISTICS	
PARAMETER	DETAILS
CURE REQUIREMENTS	None
OPERATING TEMPERATURE RANGE	-20° to +200°F (-30° to +95°C)
SHELF LIFE	Minimum 1 year at +75°F (+24°C). Refer to product label for most recent information.

PACKAGING
KIT
5 sheets 4 x 6 x 0.1 in (100 x 150 x 2.5 mm)

## Protective Coating

### FEATURES

- Flexible moisture protection
- Ready to use immediately after application.  
No curing required.

### DESCRIPTION

Single-component soft paste wax. General-purpose moisture protection.



**RoHS**  
COMPLIANT

CHARACTERISTICS	
PARAMETER	DETAILS
OPERATING TEMPERATURE RANGE	-100° to +150°F (-73° to +66°C)
SHELF LIFE	Minimum 1 year. Refer to product label for most recent information.

PACKAGING
KIT
1-lb (454-g) can

## Protective Coating

### OTHER M-LINE COATINGS COMPATIBLE WITH GAGEKOTE #5:

- M-Coat W-1 Wax
- M-Coat B

### DESCRIPTION

Two-part 100%-solids modified polysulfide epoxy. Good for general laboratory and field use. Prime leadwire insulation with M-Coat B. Excellent mechanical protection. Resistant to salt water, gasoline, hydrocarbon oils, most acids, alkalines, and solvents.



**RoHS**  
COMPLIANT

CHARACTERISTICS	
PARAMETER	DETAILS
CURE REQUIREMENTS	Air dry 6 hours at +75°F (+24°C) or 1 hour at +150°F (+66°C).
OPERATING TEMPERATURE RANGE	-90° to +250°F (-68° to +120°C).
SHELF LIFE	Minimum 1 year at +75°F (+24°C). Refer to product label for most recent information.

PACKAGING	
KITS	
4 jars Part A (1.5 oz/45 gm) 4 jars Part B (0.5 oz/15gm)	1 jar Part A (11 oz/340 gm) 1 jar Part B (3.5 oz/114 gm)

## Protective Coating

### OTHER *M-LINE* COATINGS COMPATIBLE WITH GAGEKOTE #8:

- Gagekote #5

### DESCRIPTION

Single component transparent acrylic coating. Recommended as an under or over coating for Gagekote #5. Good for anchoring intra-bridge wiring in high performance transducers. Extremely flexible and resistant to direct water immersion, mild solvents and chemicals. Film thickness of 0.005–0.01 in (0.1–0.25 mm) per coat.



**RoHS**  
COMPLIANT

CHARACTERISTICS	
PARAMETER	DETAILS
CURE REQUIREMENTS	Single coat air dry for 10 minutes at +75°F (+24°C). Prior to encapsulation by other coatings, air dry 4 hours at +75°F (+24°C) or 30 minutes at +150°F (+65°C) to prevent solvent entrapment.
OPERATING TEMPERATURE RANGE	–100° to +270°F (–75° to +130°C).
SHELF LIFE	Minimum 1 year at +75°F (+24°C). Refer to product label for most recent information.

PACKAGING	
KITS	SINGLE
12 brush-cap bottles [1 oz (30 ml) each] 1 bottle [8 oz (240 ml)] 1 bottle [32 oz (960 ml)]	1 brush-cap bottle [1 oz (30 ml)]

## Protective Coating

### OTHER *M-LINE* COATINGS COMPATIBLE WITH GAGEKOTE #11:

- WC-16 Cement
- NCC-3 Cement
- Sauereisen DKS-8 Cement
- GC Cement
- HG-1 Cement
- PBX Cement



**RoHS**  
COMPLIANT

### DESCRIPTION

Single-component clear coating. High temperature protective coating, when cured, seals and protects free filament strain gage installations. Must be reapplied after exposure to temperature excursions above +900°F (+482°C).

CHARACTERISTICS	
PARAMETER	DETAILS
CURE REQUIREMENTS	Air dry 2 hours at +75°F (+24°C), followed by 1 hour at +350°F (+175°C).
OPERATING TEMPERATURE RANGE	-452° to +900°F (-269° to +482°C).
SHELF LIFE	Minimum 1 year at +75°F (+24°C). Refer to product label for most recent information.

PACKAGING
KIT
1 brush-cap bottle [1 oz (30 ml)]





## CONTENTS

GAK-2-200 .....	86
GAK-2-AE-10 .....	86
GAK-2-610 .....	86
BAK-200 .....	87
CEA-200 .....	87
MAK-1 .....	88

# Strain Gage Application Kits

## Strain Gage Application Kits

### GAK-2 FEATURES

- GAK-2 Series Kits include materials necessary to immediately start making strain gage installations for routine applications.
- Kit supplies and materials are provided in a tool box for convenience and portability. CSM Degreaser, previously supplied in the above kit, is to be ordered separately, as needed.
- All application kits should be stored at or near +75°F (+24°C). Refer to product label for most recent information.



GAK-2-200



GAK-2-AE-10



GAK-2-610

KIT CONTENTS		
GAK-2-200	GAK-2-AE-10	GAK-2-610
M-Bond 200, 1 kit MCA-1, M-Prep Conditioner A, 1 bottle MN5A-1, M-Prep Neutralizer 5A, 1 bottle SCP-1 220-grit silicon-carbide paper, 1 roll SCP-2 320-grit silicon-carbide paper, 1 roll SCP-3 400-grit silicon-carbide paper, 1 roll CSP-1, cotton swabs, 1 package GSP-1, gauze sponges, 1 package PCT-2M, gage installation tape, 1 roll PDT-3, paper drafting tape, 1 roll 361A-20R-25, solder, 1 roll, 25 ft (7.6 m) RSK-1, rosin solvent, bottle, 1 oz (30 ml) CPF-AST, bondable terminals, 1 box 326-DFV, 3-conductor leadwire, 100 ft (30 m) M-Coat A protective coating, bottle, 1 oz (30 ml) 134-AWP, solid copper wire, 500 ft (150 m) Plastic tool box	M-Bond AE-10, 1 kit MCA-1, M-Prep Conditioner A, 1 bottle MN5A-1, M-Prep Neutralizer 5A, 1 bottle SCP-1 220-grit silicon-carbide paper, 1 roll SCP-2 320-grit silicon-carbide paper, 1 roll SCP-3 400-grit silicon-carbide paper, 1 roll CSP-1, cotton swabs, 1 package GSP-1, gauze sponges, 1 package PCT-2M, gage installation tape, 1 roll PDT-3, paper drafting tape, 1 roll 361A-20R-25, solder, 1 roll, 25 ft (7.6 m) RSK-1, rosin solvent, bottle, 1 oz (30 ml) CPF-AST, bondable terminals, 1 box 326-DFV, 3-conductor leadwire, 100 ft (30 m) M-Coat A protective coating, bottle, 1 oz (30 ml) 134-AWP, solid copper wire, 500 ft (150 m) SGP-2 silicone rubber, 1 piece HSC-1, No. 1 spring clamp, 1 each HSC-2, No. 2 spring clamp, 1 each Plastic tool box	M-Bond 610 adhesive, 1 kit MCA-1, M-Prep Conditioner A, 1 bottle MN5A-1, M-Prep Neutralizer 5A, 1 bottle SCP-1 220-grit silicon-carbide paper, 1 roll SCP-2 320-grit silicon-carbide paper, 1 roll SCP-3 400-grit silicon-carbide paper, 1 roll CSP-1, cotton swabs, 1 package GSP-1, gauze sponges, 1 package MJG-2, Mylar® tape, 1 roll PDT-3, paper drafting tape, 1 roll 361A-20R-25, solder, 1 roll, 25 ft (7.6 m) RSK-1, rosin solvent, bottle, 1 oz (30 ml) CPF-AST, bondable terminals, 1 box 326-DFV, 3-conductor leadwire, 100 ft (30 m) M-Coat C protective coating, bottle, 1 oz (30 ml) 134-AWP, solid copper wire, 500 ft (150 m) SGP-2 silicone rubber, 1 piece HSC-1, No. 1 spring clamp, 1 each HSC-2, No. 2 spring clamp, 1 each TFE-1, Teflon® film, 1 roll Plastic tool box

Mylar and Teflon are Registered Trademarks of DuPont.



Strain Gage Application Kits

**BAK-200 AND CEA-200 FEATURES**

- BAK-200 kit contains essential materials for M-Bond 200 installations, packaged in a cardboard box.
- CSM Degreaser, previously supplied in the above kit, is to be ordered separately, as needed.
- CEA-200 kit contains CEA strain gages and materials needed for installation of the gages. Perfect for educators and novice strain gage users.
- All application kits should be stored at or near +75°F (+24°C). Refer to product label for most recent information.

<b>KIT CONTENTS</b>		
<b>BAK-200</b>	<b>CEA-200</b>	
M-Bond 200 adhesive, bottle, 1 oz (30 ml) M-Bond 200 catalyst, bottle, 1 oz (30 ml) CSP-1, cotton swabs, 1 package GSP-1, gauze sponges, 1 package PCT-2M, gage installation tape, 1 roll MCA-1, M-Prep Conditioner A, 1 bottle MN5A-1, M-Prep Neutralizer 5A, 1 bottle SCP-2 320-grit silicon-carbide paper, 1 roll SCP-3 400-grit silicon-carbide paper, 1 roll	CEA-13-250UW-350/P2, 5 pieces M-Bond 200 adhesive, bottle, 2 at 2 gm M-Bond 200 catalyst, bottle, 0.5 oz (15 ml) CSP-1, cotton swabs, 1 package GSP-1, gauze sponges, 1 package PCT-2M, gage installation tape, 1 roll GC-6, alcohol, bottle, 4 oz	MCA-1, M-Prep Conditioner A, 1 bottle MN5A-1, M-Prep Neutralizer 5A, 1 bottle SCP-2 320-grit silicon-carbide paper, 1 roll SCP-3 400-grit silicon-carbide paper, 1 roll Aluminum beams, 2 each Practice beams, 2 each DP-1, drafting pencil, 1 each Practice patterns, 25 pieces

## Master Strain Gage Application Kit

### FEATURES

- Includes supplies and special tools for making a wide range of strain gage installations for both laboratory and field applications.
- Successfully complete any organic strain gage installation for operation from  $-452^{\circ}$  to  $+500^{\circ}\text{F}$  ( $-269^{\circ}$  to  $+260^{\circ}\text{C}$ ).
- All materials, including complete instructions, conveniently packaged in a molded, crush-proof, copolymer toolbox. CSM Degreaser, previously supplied in this kit, is to be ordered separately, as needed.
- All application kits should be stored at or near  $+75^{\circ}\text{F}$  ( $+24^{\circ}\text{C}$ ). Refer to product label for most recent information.



### KIT CONTENTS

#### Surface Preparation Materials:

MCA-1, M-Prep Conditioner A, 1 bottle  
 MN5A-1, M-Prep Neutralizer 5A, 1 bottle  
 Silicon-Carbide Paper: 220, 320, 400 grit,  
 one 10-ft (3-m) roll each  
 CSP-1, Cotton Swab, 4 packages  
 GSP-1, Gauze Sponges, 2 packages  
 RSK-1, Rosin Solvent, two 1-oz (30-ml) bottles

#### Application Tools:

SSH-1, Surgical Shears  
 SSC-1, Surgical Scalpel and Blade  
 SSC-2, Scalpel Blades (5)  
 BTW-1, Tweezers  
 STW-1, Tweezers  
 DP-1, 4-H Drafting Pencil  
 DWC-1, Diagonal Cutters  
 DPR-1, Dental Probe (2)  
 NNP-1, Needle-Nosed Pliers  
 SSS-1, Steel Scale  
 SPT-1, Spatula  
 SPT-2, Spatula

#### Hardware:

PCT-2M, Gage Installation Tape, 2 dispenser rolls  
 PDT-3, Drafting Tape, 2 dispenser rolls  
 MJG-2, Mylar<sup>®</sup> Tape, 1 roll  
 HSC-1, No. 1 Spring Clamps (4)  
 HSC-2, No. 2 Spring Clamps (2)  
 HSC-3, No. 3 Spring Clamp (1)  
 TFE-1, Teflon<sup>®</sup> Film, 1 roll  
 GT-14, Pressure Pads and Plates Kit

#### Adhesives:

M-Bond 200, 1 kit  
 M-Bond AE-10, 1 kit  
 M-Bond 610, 1 kit

#### Soldering Supplies:

361A-20R, 1 lb (0.45 kg)  
 361A-20R-25, 1 roll  
 450-20S-25, 1 roll  
 570-28R-20, 1 roll  
 FAR-2 M-Flux AR, 1 kit  
 CPF-AST, Terminal Strip Assortment, 1 box

#### Leadwire:

134-AWP, 100 ft (30 m)  
 126-DWV: Red, White, Black, Green, one 100-ft (30-m) roll each  
 326-DFV, 100 ft (30 m)  
 130-FWT: Red, White, Black, Green, one 50-ft (15-m) roll each

#### Protective Coatings:

M-Coat A, two 1-oz (30-ml) bottles  
 M-Coat B, two 1-oz (30-ml) bottles  
 M-Coat C, 1-oz (30-ml) bottle  
 M-Coat D, 1-oz (30-ml) bottle  
 M-Coat F, 1 kit  
 3145 RTV Silicone Rubber, 3-oz (85-g) tub

Mylar and Teflon are Registered Trademarks of DuPont.

**Reference:** An adhesive selection table is provided in the "M-Bond Strain Gage Adhesives."

# Precision Resistors

Epoxy Cased  
 Wirewound  
 Hermetically Sealed

## CONTENTS

Specifications ..... 90

### Shunt Calibration

W-599880-02 ..... 91  
 W-119880-02 ..... 91  
 S-59880-01 ..... 91  
 S-29880-01 ..... 91  
 S-19880-01 ..... 91  
 S-14880-01 ..... 91  
 S-11880-01 ..... 91  
 S-5880-01 ..... 91  
 W-349650-02 ..... 91  
 W-174650-02 ..... 91  
 S-87150-01 ..... 91  
 S-57983-01 ..... 91  
 S-43400-01 ..... 91  
 S-34650-01 ..... 91  
 S-17150-01 ..... 91  
 W-999000-02 ..... 91  
 W-499000-02 ..... 91  
 W-249000-02 ..... 91  
 W-165666-02 ..... 91  
 W-124000-02 ..... 91

### Bridge Completion

S-50-01 ..... 91  
 S-60-01 ..... 91  
 S-100-01 ..... 91  
 S-120-01 ..... 91  
 S-175-01 ..... 91  
 S-240-01 ..... 91  
 S-350-01 ..... 91  
 S-500-01 ..... 91  
 S-1000-01 ..... 91  
 S-2000-01 ..... 91  
 S-5000-01 ..... 91  
 H-100-01 ..... 91  
 H-120-01 ..... 91  
 H-350-01 ..... 91  
 H-1000-01 ..... 91

## Specifications and Selection Charts

Fixed resistors have two primary uses in strain gage circuits: shunt calibration of strain-measuring instrumentation, and bridge completion. For shunt calibration, a fixed resistor is temporarily shunted across a bridge arm to produce a known resistance change in the bridge circuit. The resulting instrument indication is then compared to the calculated strain corresponding to the resistance change. For bridge-completion applications, a fixed resistor may be used in the adjacent arm of the bridge to complete the external half-bridge circuit when a single strain gage is connected in a quarter-bridge arrangement.

In each of these applications, the accuracy of the strain measurement is affected, directly or indirectly, by the accuracy and stability of the fixed resistor(s) used in the circuit. It is important, therefore, that only precision, high-stability resistors be selected for these purposes.

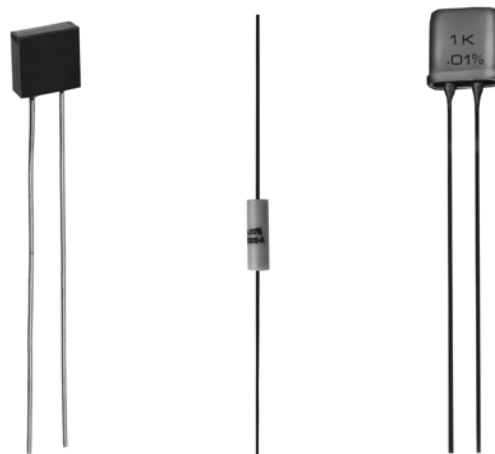

Standard S-Type

Wire Wound

Hermetic

<b>PRECISION RESISTOR SPECIFICATIONS</b>		
<b>STANDARD S-TYPE (PREFIX "S")</b>	<b>WIRE WOUND (PREFIX "W")</b>	<b>HERMETIC (PREFIX "H")</b>
<p>Noted for long-term stability and low temperature-coefficient-of-resistance. Used for shunt calibration (below 100,000 <math>\Omega</math>) and bridge completion.</p> <p><b>Size:</b> 0.295 x 0.320 x 0.10 in (7.5 x 8.1 x 2.5 mm).</p> <p><b>Temperature Coefficient:</b> <math>\pm 0.6</math> ppm/<math>^{\circ}</math>F; +32<math>^{\circ}</math> to +140<math>^{\circ}</math>F (<math>\pm 1</math> ppm/<math>^{\circ}</math>C; 0<math>^{\circ}</math> to +60<math>^{\circ}</math>C).</p> <p><b>Stability:</b> 25 ppm/year max. drift.</p> <p><b>Wattage:</b> 0.3 at +75<math>^{\circ}</math>F (+24<math>^{\circ}</math>C).</p> <p><b>Leadwires:</b> 22 AWG tinned copper.</p> <p><b>Construction:</b> Encapsulated in epoxy case for use in normal laboratory environment.</p>	<p>For high-value shunt resistance requirements (above 100,000 <math>\Omega</math>).</p> <p><b>Size:</b> 0.25 in dia. x 0.75 in long (6.4 x 19.1 mm).</p> <p><b>Temperature Coefficient:</b> <math>\pm 12</math> ppm/<math>^{\circ}</math>F; +32<math>^{\circ}</math> to +140<math>^{\circ}</math>F (<math>\pm 20</math> ppm/<math>^{\circ}</math>C; 0<math>^{\circ}</math> to +60<math>^{\circ}</math>C).</p> <p><b>Stability:</b> 30 ppm/year max. drift.</p> <p><b>Wattage:</b> 0.3 at +75<math>^{\circ}</math>F (+24<math>^{\circ}</math>C).</p> <p><b>Leadwires:</b> 20 AWG tinned copper.</p> <p><b>Construction:</b> Noninductive windings. Encapsulated for use in normal laboratory environment.</p>	<p>Best long-term stability under adverse environmental conditions. Premium resistors used for bridge completion where highest accuracy and stability are required.</p> <p><b>Size:</b> 0.4 in square x 0.15 in thick (10 x 4 mm).</p> <p><b>Temperature Coefficient:</b> <math>\pm 0.6</math> ppm/<math>^{\circ}</math>F; +32<math>^{\circ}</math> to +140<math>^{\circ}</math>F (<math>\pm 1</math> ppm/<math>^{\circ}</math>C; 0<math>^{\circ}</math> to +60<math>^{\circ}</math>C).</p> <p><b>Stability:</b> 5 ppm/year max. drift.</p> <p><b>Wattage:</b> 0.25 at +75<math>^{\circ}</math>F (+24<math>^{\circ}</math>C).</p> <p><b>Leadwires:</b> 22 AWG tinned copper.</p> <p><b>Construction:</b> Hermetically sealed in metal case. Excellent long-term stability.</p>

Specifications and Selection Charts

<b>SHUNT-CALIBRATION RESISTORS</b>				
	<b>ORDER NO.</b>	<b>RESISTANCE IN OHMS</b>	<b>TOLERANCE IN %</b>	<b>EQUIVALENT MICROSTRAIN</b>
<b>FOR 120 Ω GAGE CIRCUIT</b>	W-599880-02	599,880	±0.02	100
	W-119880-02	119,880	±0.02	500
	S-59880-01	59,880	±0.01	1,000
	S-29880-01	29,880	±0.01	2,000
	S-19880-01	19,880	±0.01	3,000
	S-14880-01	14,880	±0.01	4,000
	S-11880-01	11,880	±0.01	5,000
	S-5880-01	5,880	±0.01	10,000
<b>FOR 350 Ω GAGE CIRCUIT</b>	W-349650-02	349,650	±0.02	500
	W-174650-02	174,650	±0.02	1,000
	S-87150-01	87,150	±0.01	2,000
	S-57983-01	57,983	±0.01	3,000
	S-43400-01	43,400	±0.01	4,000
	S-34650-01	34,650	±0.01	5,000
	S-17150-01	17,150	±0.01	10,000
	<b>FOR 1000 Ω GAGE CIRCUIT</b>	W-999000-02	999,000	±0.02
W-499000-02		499,000	±0.02	1,000
W-249000-02		249,000	±0.01	2,000
W-165666-02		165,666	±0.01	3,000
W-124000-02		124,000	±0.01	4,000
S-99000-01		99,000	±0.01	5,000
S-49000-01		49,000	±0.01	10,000

The "Equivalent Microstrain" column shows the true compression strain simulated by shunting each calibration resistor across an active strain gage arm of the exact indicated resistance, based on a circuit gage factor setting of 2.000.

<b>BRIDGE COMPLETION RESISTORS</b>	
<b>CIRCUIT AND BRIDGE COMPLETION TOLERANCE ±0.01%</b>	
<b>ORDER NO.</b>	<b>RESISTANCE IN OHMS</b>
S-50-01	50
S-60-01	60
S-100-01	100
S-120-01	120
S-175-01	175
S-240-01	240
S-350-01	350
S-500-01	500
S-1000-01	1,000
S-2000-01	2,000
S-5000-01	5,000
H-100-01	100
H-120-01	120
H-350-01	350
H-1000-01	1,000

**Note:**

Shunt-calibration resistors are chosen to accurately simulate resistance change in a strain gage subjected to specified levels of compressive strain. Strain indicators generally produce a linear output with a fully active half-bridge or full-bridge input circuit, and will be slightly in error when a single active arm is used. The same nonlinearity occurs whether the gage is actually strained in compression or simulated by shunting the gage with the corresponding calibration resistor. See Tech Note TN-514, "Shunt Calibration of Strain Gage Instrumentation."





## CONTENTS

MR1-350-127.....	94
MR1-10C-129 .....	94
MR1-350-130.....	94
MR2-350-128.....	94

# Bridge Completion Modules

## Information and Selection Chart

Strain gage instrumentation is readily available with built-in bridge completion resistors and “dummy” gages to accept quarter- and half-bridge strain gage input circuits. However, if the instrumentation at hand is not provided with these components, or if the measurement application does not permit their use, external bridge completion must be provided, and MR-Series Bridge Completion Modules can be an excellent choice in these applications.

MR-Series Bridge Completion Modules employ metal-foil resistance elements, bonded to a dense ceramic substrate. The resistance elements are specially processed to “match” the thermal expansion coefficient of the ceramic, resulting in a very low resistance temperature coefficient equivalent to  $\pm 0.15 \mu\epsilon/^\circ\text{F}$  ( $\pm 0.27 \mu\epsilon/^\circ\text{C}$ ) for the half-bridge circuits, and  $\pm 0.35 \mu\epsilon/^\circ\text{F}$  ( $\pm 0.63 \mu\epsilon/^\circ\text{C}$ ) for the dummy gages, over a temperature range from  $0^\circ$  to  $+200^\circ\text{F}$  ( $-18^\circ$  to  $+95^\circ\text{C}$ ). Maximum operating temperature range is  $-50^\circ$  to  $+250^\circ\text{F}$  ( $-45^\circ$  to  $+120^\circ\text{C}$ ).

Each module is covered with a special environmental protection system to ensure long-term stability. A rugged aluminum overlay, embossed with a wiring diagram for easy terminal identification, affords additional protection, and in many applications no supplementary environmental protection is required. Each module is provided with foam tape for easy attachment to the test-part surface or at the instrumentation site, and tinned, heavy copper terminals facilitate attachment of up to 22-gauge (0.64 mm dia.) leadwires.

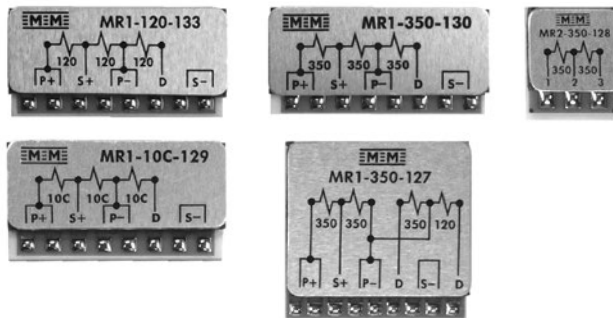

Completing the bridge circuit at the strain gage site provides for a symmetrical, balanced leadwire system between the strain gage circuit and the instrumentation. This can reduce effects of noise pickup in the leadwire system in some environments. Where switch contacts, slip rings, or other mechanical connections are employed between the strain gages and measuring instrumentation, or when leadwires will be periodically disconnected from the measuring instrument, accuracy can be improved by completing the bridge at the measurement site. Bridge completion modules can be designed to meet special circuit requirements. Contact our Applications Engineering Department for a detailed discussion of your special needs.

CHARACTERISTICS		
MODULE TYPE AND FEATURES	BRIDGE EXCITATION (VOLTS)	
	RECOMMENDED	MAXIMUM
<b>MR1-350-127:</b> Provides a precision 350 $\Omega$ half bridge as well as 120 $\Omega$ and 350 $\Omega$ dummy gages. Recommended for use with half-bridge strain gage circuits of any resistance value, or with 120 $\Omega$ or 350 $\Omega$ three-wire quarter-bridge circuits. Size (including foam tape): 1 x 1 x 0.2 in (25 x 25 x 5 mm). Weight: 6 g.	0.5–15 V 0.5–25 V	20 V (D120) 35 V (D350)
<b>MR1-10C-129:</b> Provides a precision 1000 $\Omega$ half bridge and a 1000 $\Omega$ dummy gage. Recommended for use with half-bridge strain gage circuits of any resistance value, or with 1000 $\Omega$ quarter-bridge circuits. High resistance extends battery life in battery-powered instrumentation, reduces strain gage self-heating, and permits higher bridge excitation voltage to improve signal-to-noise ratio. Size (including foam tape): 1.2 x 0.6 x 0.2 in (30 x 15 x 5 mm). Weight: 4 g.	0.5–30 V	40 V
<b>MR1-350-130:</b> Provides a precision 350 $\Omega$ half bridge and a 350 $\Omega$ dummy gage. Recommended for use with half-bridge strain gage circuits of any resistance value, or with 350 $\Omega$ three-wire quarter-bridge circuits. Size (including foam tape): 1.2 x 0.6 x 0.2 in (30 x 15 x 5 mm). Weight: 4 g.	0.5–18 V	25 V
<b>MR2-350-128:</b> Provides a precision 350 $\Omega$ half bridge in a compact size for use with half-bridge strain gage circuits. Small size makes it ideal for attachment at the strain gage site on the test part in many applications. Size (including foam tape): 0.5 x 0.7 x 0.2 in (13 x 18 x 5 mm). Weight: 2 g.	0.4–18 V	25 V
<b>MR1-120-133:</b> Provides a precision 120 $\Omega$ half bridge and a 120 $\Omega$ dummy gage. Recommended for use with half-bridge strain gage circuits of any resistance value, or with 120 $\Omega$ three-wire quarter-bridge circuits. Size (including foam tape): 1.2 x 0.6 x 0.2 in (30 x 15 x 5 mm). Weight: 4 g.	0.5–15 V	20 V

Half-bridge circuits in each module type are balanced to within  $\pm 0.005\%$ . Resistance tolerance on each dummy gage is  $\pm 0.02\%$ .



Model 1300 ..... 96  
Model 700 ..... 98

# Special-Purpose Equipment

## Gage Installation Tester

### FEATURES

- A compact, battery-powered instrument used to verify the electrical quality of a strain gage installation BEFORE it is placed in service
- Reads with the push of a button—no warm-up
- Reads insulation resistance (leakage) to 20,000 megohms with 15 VDC
- Measures deviation of installed gage resistance from precise standards to a resolution of 0.02%
- Ohmmeter scale for troubleshooting questionable installations
- Verifies the complete gage circuit, including leadwires



### DESCRIPTION

Two of the most important measurements used to verify the quality of a strain gage installation are insulation resistance (leakage to ground) and shift in gage resistance due to installation procedures. While these two measurements are not a complete guarantee of eventual proper strain gage performance, any installation that produces questionable values should not be relied upon where accuracy of results is necessary.

For example, a voltage difference between the specimen and strain gage frequently exists. A low insulation resistance will permit this voltage differential to introduce extraneous signals during strain measurement.

Several sources of variations in insulation resistance and shifts in gage resistance are:

- Insulation resistance in excess of 20,000 megohms should be expected for foil strain gages when installed under laboratory conditions. A value of 10,000 megohms should be considered minimum. A reading below this value generally indicates trapped foreign matter, moisture, residual flux or backing damage due to soldering, as well as incomplete solvent evaporation from an overcoating.
- Deterioration of the insulation resistance with time may be an indication of an improperly coated installation.
- At higher test temperatures, particularly above +300°F (+150°C), it is normal to expect lesser values. Ten megohms is considered to be the lower allowable value.
- Shifts in gage resistance during installation should not normally exceed 0.5% when using room-temperature-curing adhesives. Resistance shifts greater than 0.5% generally indicate damage to the gage due to improper handling or clamping. However, strain gages installed using elevated-temperature-curing adhesives may exhibit greater shifts in resistance due to adhesive lock-up at elevated temperatures (difference in linear coefficient of thermal expansion between the strain gage and specimen). These shifts will vary depending upon the specific cure temperature and materials used. The shifts should never exceed 2% and should be uniform within 0.5%.

### SPECIFICATIONS

#### INPUT CIRCUITS

**Gages:** Three-wire quarter bridge (120  $\Omega$  and 350  $\Omega$ ) and half bridge. Other value quarter bridges using customer's reference, at readily accessible panel terminals.

**As ohmmeter:** Two leads (500  $\Omega$  and 500 M $\Omega$  mid-scale)

#### INPUT LEADS

4-ft (1.2 m) 4-conductor AWG #26 (0.4-mm diameter) twisted Teflon<sup>®</sup>-insulated cable supplied (with ground clip and three tinned leads)

#### METER

3.5-in size [3.00-in (76-mm) scale length] with mirror  
Tracking accuracy  $\pm 1\%$  full range

#### MODE SWITCH

Five momentary push buttons: battery check,  $\pm 5\%$  deviation,  $\pm 1\%$  deviation, gage resistance (ohms), and insulation resistance (megohms)

#### DEVIATION MODE

Two ranges,  $\pm 1\%$  and  $\pm 5\%$ , F.S. (50 graduations either side of zero)

#### Accuracy:

1% range: 0.04%  $\Delta R$  (2 meter graduations)

5% range: 0.2%  $\Delta R$  (2 meter graduations)

**Excitation:** 1.0 VDC per gage

#### INSULATION RESISTANCE MODE

Graduated 5 M $\Omega$  to 20,000 M $\Omega$  (500 M $\Omega$  mid-scale)

**Accuracy:** 1 scale division

**Test Voltage:** 15 VDC open circuit

**Gage Installation Tester**

**OHM MODE**

Graduated 5  $\Omega$  to 20 k $\Omega$  (500  $\Omega$  mid-scale)

**Accuracy:** 1 scale division

**Test Voltage:** 2 VDC open circuit (0.4 VDC @ 120  $\Omega$ )

**ENVIRONMENTAL**

+15°F to +125°F (-10°C to +50°C); up to 80% relative humidity, non-condensing

**SIZE**

Aluminum case (separable lid) 5 H x 7 W x 5 D in with lid (125 x 180 x 126 mm)

**WEIGHT**

3.6 lb (1.6 kg) with batteries

**POWER SUPPLY**

Four 9 V NEDA 1604 batteries (Eveready® 216 or equivalent)

**Life:** Will fully test 1000–5000 installation.

*All specifications are nominal or typical @ +23°C unless noted.*

*Teflon is a Registered Trademark of DuPont*

*Eveready is a Registered Trademark of Eveready Battery Co Inc.*



## Portable Strain Gage Welding and Soldering Unit

### FEATURES

- Separate visual and audible indicators monitor welder status. Weld energy is continuously adjustable from 3 to 50 joules, making the Model 700 an excellent choice for installing weldable strain gages and temperature sensors, as well as small thermocouples and light-gauge metal.
- Supplied with a lightweight soldering pencil. A front-panel control adjusts soldering tip temperature for a wide range of soldering applications in the field or in the laboratory.
- “Low-battery” light to warn the user when the internal, sealed lead-acid battery requires charging. A battery charger is included to provide for full battery charge with no danger of overcharging. Indicator lights monitor battery charge rate.
- Convenient storage space for cables, battery charger and instruction manual



### GENERAL SPECIFICATIONS

#### OVERALL SIZE

9 L x 9 W x 9-3/4 H in (230 x 230 x 250 mm)

#### WEIGHT

21 lb (9.5 kg)

#### POWER FOR RECHARGING

115 VAC or 230 VAC, 50-60 Hz. Uses external AC transformer (provided)

#### OPERATING AND STORAGE TEMPERATURE RANGE

0°F to +120°F (-20°C to +50°C)

### WELDING SPECIFICATIONS

#### WELD ENERGY RANGE

3 to 50 joules, continuously adjustable by front-panel control

Maximum open-circuit voltage less than 25 VDC

#### MAXIMUM WELD REPETITION RATE

20 per minute at 30 joules, typical

#### NUMBER OF WELDS PER BATTERY CHARGE

Approximately 2000 at weld energy setting of 30 joules. This is equivalent to 40 Micro-Measurements weldable gage installations.

#### BATTERY CHARGE TIME: (FROM FULL DISCHARGE)

12 hours to 75% full charge; 18 hours to full charge

#### BATTERY

One sealed, rechargeable lead-acid (non-liquid) type, 12 volt, 5 ampere-hour

#### WELDING PROBE

Manually fired with trigger control and “steady-rest”

#### WELDING CABLES

Two 5 ft (1.5m), fully flexible

#### WELD ENERGY MONITOR

Calibrated front-panel control with READY and WAIT indicators; audible indication selectable

Portable Strain Gage Welding and Soldering Unit

**SOLDERING SPECIFICATIONS**

**TEMPERATURE CONTROL**

Continuously variable with bands indicating melting range of solders

**SOLDERING PENCIL**

1.1 oz (31 gm), rated at 25 watts, 12 volt operation. Tip temperature adjustable from +200°F to +900°F (+90°C to +480°C).

**SOLDERING DURATION**

4 hours using +361°F (+183°C) melting point solders (with initial full charge)

**ACCESSORY**

**Model 700-A103 Spot Welding Probe Set:**

Recommended for spot welding instrument leadwires to ZC Series high-temperature gage ribbons

All specifications are nominal or typical at +23°C unless noted.

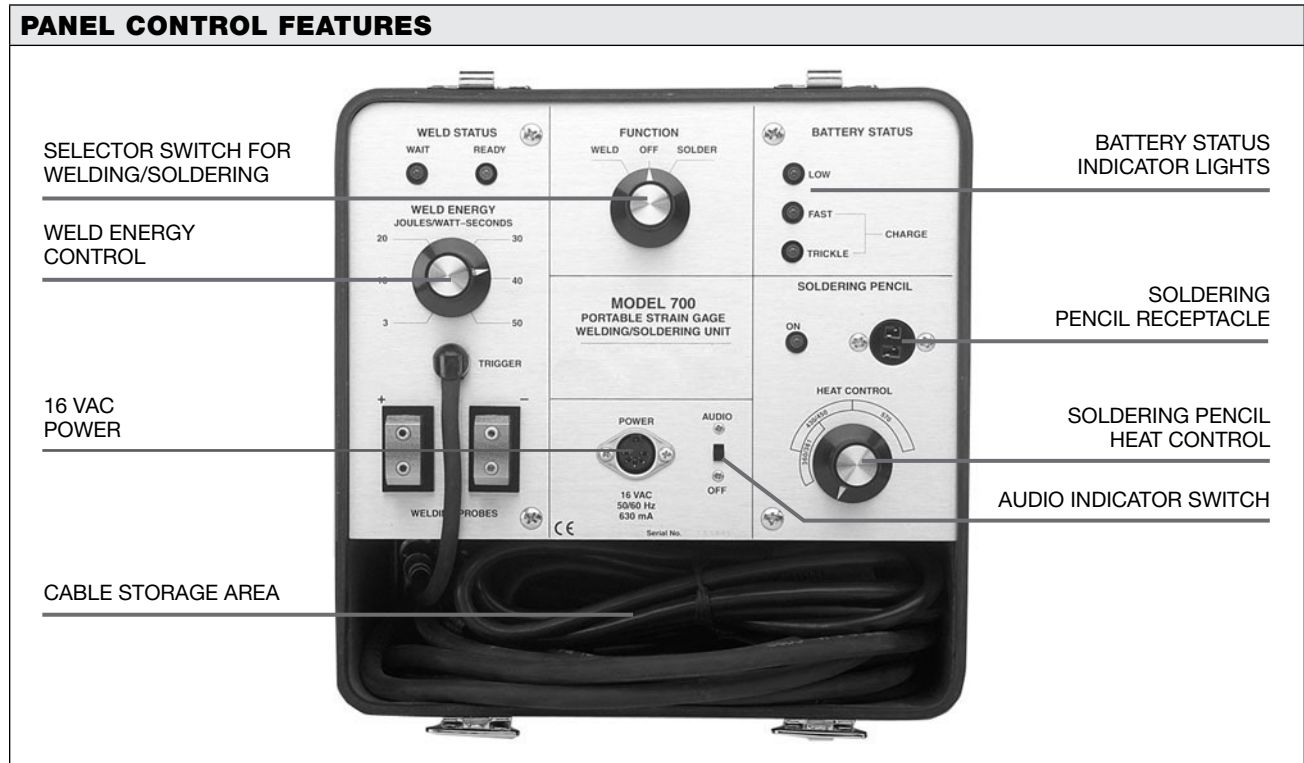





## CONTENTS

Technical Publications.....	100
Applications Engineering.....	100
Technical Training .....	100

# Technical Support

## Technical Support

In the previous sections of this catalog, we have described the necessary tools, materials, and supplies required for successful strain gage installation. Once the proper selection of application accessories is made, the next and most important step in installing the gage is the application technique itself. To this end, Micro-Measurements offers a full range of technical support that includes an extensive set of instructional

publications, regularly scheduled training programs on the procedures and techniques for making high-quality strain gage installations, and self-teaching aids to help trainees quickly gain skill and proficiency in application techniques. Additionally, we maintain a full-time Applications Engineering staff to assist the customer with any particular strain gage installation problem.

### TECHNICAL INFORMATION

Micro-Measurements has published an extensive set of technical notes and detailed instructional literature on practical strain gage application techniques. Most of this technical literature is unique in that the content cannot be found in engineering textbooks or other published sources.

This library of strain gage reference material is continuously updated to reflect the latest technology in application techniques and available in the strain gage technology knowledge base on our website at:

<http://www.vishaypg.com/micro-measurements/stress-analysis-strain-gages/knowledge-base-list/>

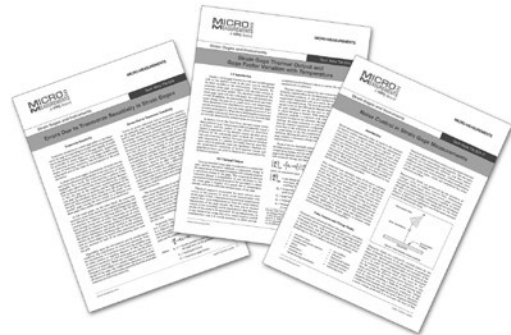

### APPLICATIONS SUPPORT

Micro-Measurements maintains an experienced and highly trained applications engineering staff. Our Applications Engineers are as close as your telephone, and we urge you to call them for recommendations in strain gage selection to satisfy your particular test requirements.



### TRAINING PROGRAMS

Training customers in the proper use of strain measurement techniques is an essential part of the Micro-Measurements philosophy. In support of this principle, Micro-Measurements conducts an extensive series of regularly scheduled technical seminars, workshops, and short courses. Course instructors are recognized authorities in their field. Training sessions are conducted at our facilities in the United States and Europe, as well as at hotels and educational institutions around the world. For schedules, go to:

<http://www.vishaypg.com/micro-measurements/training-programs/>









Contact

[mm@vpgsensors.com](mailto:mm@vpgsensors.com)

[micro-measurements.com](http://micro-measurements.com)