



**VISHAY
PRECISION
GROUP**

BLH

**DXP10/15 Weigh Transmitters
Operator's Manual**

TM002
RevG
6/1/11
Doc 35102

NOTICE

BLH makes no representation or warranties of any kind whatsoever with respect to the contents hereof and specifically disclaims any implied warranties or merchantability or fitness for any particular purpose. BLH shall not be held liable for errors contained herein or for incidental or consequential damages in connection with the furnishing, performance, or use of this publication or its contents.

BLH reserves the right to revise this manual at any time and to make changes in the contents hereof without obligation to notify any person of such revision or changes.

Call (781) 298-2216 for BLH Field Service

Table of Contents

SECTION 1.	General Information.....	1-1
1.1	INTRODUCTION.....	1-1
1.1.1	General Description.....	1-1
1.1.2	Standard Instrument.....	1-1
1.2	OPTIONS.....	1-1
1.2.1	Mounting Options.....	1-1
1.2.2	Optional Terminal Computer Interface.....	1-1
1.2.3	Optional Modbus RTU Interface.....	1-2
1.2.4	Optional Fisher ProVox Protocol.....	1-2
1.2.5	Optional Allen-Bradley Remote I/O.....	1-2
1.2.6	Analog Option.....	1-2
1.2.7	Software Filter Option.....	1-2
1.3	DXp-10/15 SPECIFICATIONS.....	1-2
1.4	ORDERING SPECIFICATIONS.....	1-4
1.5	WARRANTY POLICY.....	1-4
1.6	FIELD ENGINEERING.....	1-4
SECTION 2.	Installation.....	2-1
2.1	INTRODUCTION.....	2-1
2.1.1	General.....	2-1
2.2	MOUNTING.....	2-1
2.2.1	Standard Units.....	2-1
2.2.2	Explosion-Proof and Division 2 Options.....	2-1
2.3	ELECTRICAL.....	2-2
2.3.1	Transducer Inputs.....	2-2
2.3.2	Serial Communication.....	2-2
2.3.3	Analog Output.....	2-3
2.3.4	Mains (AC) Power (Figure 2-4).....	2-3
2.3.5	Auxiliary I/O Port.....	2-3
SECTION 3.	Configuration.....	3-1
3.1	GENERAL.....	3-1
3.2	SET-UP.....	3-1
3.2.1	Power Selection.....	3-1
3.2.2	Excitation Voltage.....	3-1
3.2.3	Serial Format, Address, and Baud Rate.....	3-1
3.2.4	Input Range Selection.....	3-1
3.3	CALIBRATION.....	3-1

3.3.1	Digital Calibration.	3-1
3.3.2	Analog Calibration.	3-2
3.3.3	Monitor Mode Calibration.	3-2
3.3.4	LCp-40 Calibration.....	3-2
3.4	CHECK CAL	3-5
3.5	FILTER SELECTION.....	3-6
3.5.1	Standard Filter.	3-6
3.5.2	Optional Digital Filtering.	3-6
3.6	Factory Default Calibration	3-7
SECTION 4.	Serial Communication	4-1
4.1	GENERAL	4-1
4.1.1	LCp-40 Digi System Network.	4-1
4.1.2	Standard Simplex Output (Continuous Output).....	4-1
4.1.3	Computer/Terminal Interface (Optional).....	4-2
4.1.4	MODBUS BTU Protocol (Optional).	4-4
4.1.5	Fisher ProVox Protocol (Optional).....	4-7
4.1.6	Allen-Bradley Remote I/O (Optional).....	4-8
SECTION 5.	Operation	5-1
5.1	GENERAL	5-1
5.2	GROSS WEIGHT WEIGHING	5-1
5.3	ZERO OPERATION	5-1
5.4	NET WEIGHT WEIGHING	5-1
5.5	TARE OPERATION.....	5-1
5.6	ERROR DETECTION.....	5-1
5.7	CHECK CAL OPERATION.....	5-1

SECTION 1. General Information

1.1 INTRODUCTION

1.1.1 General Description

The DXp-10 and DXp-15 (Figure 1-1) are microprocessor based weight transmitters. DXp-10/15 transmitters sum and convert the millivolt signal from up to four strain gage type load cells into a digital and/or analog voltage or current signal (up to eight cells can be summed using an external 308A summing unit). Bridge excitation voltage is factory selectable for 10 or 15 volts. Units are available in NEMA 4, NEMA 4X or explosion proof enclosures for field mounting. The unit operates from either 110 or 220 VAC at 50/60 Hz, and is equipped with screw terminal connections for power input, and serial/analog outputs. Set-up and calibration is performed using three internal switches (see SECTION III). Communication baud rate and instrument address values are selected via a bank of internal DIP switches (see SECTION III).

The DXp-10 Transmitter performance specifications are designed for inventory and other static weighing applications where moderate resolution and speed is required. The DXp-15 Process Transmitter is equipped with high performance circuitry that provides the greater resolution and speed for dynamic process applications. Externally and in regard to set-up and operation, each model is identical

Using RS 485 serial communication protocol, up to sixteen DXp transmitters can be networked to an LCp-40, 41, or 42 Network Controller. The serial format can also be configured to provide point to point or network communication to a customer supplied computer.

1.1.2 Standard Instrument

The standard instrument includes an RS 485 serial port with BLH Digi-System network or a simplex output protocols, a four cell summing circuit, 10 or 15 volt excitation, averaging filter, and a NEMA 4 mild steel, painted enclosure. Standard instruments are designed to meet

Class I, II, Division 2, Group A-G hazardous location requirements and are optionally available with FM and CSA approvals and certifications.

1.2 OPTIONS

1.2.1 Mounting Options

For corrosive, hose down, or sanitary environments, a NEMA 4X stainless steel enclosure is available. An explosion proof enclosure is available for Class I, II, Division 1, Group B-G locations. Note: BLH 404 or 405 Intrinsic Safety Barriers must be specified for weigh systems located in a Division I area.

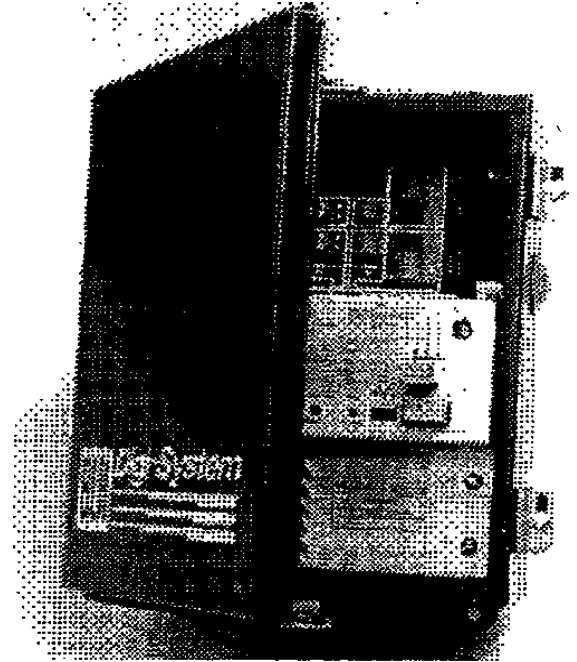

Figure 1-1. DXp-10 Weight Transmitter

1.2.2 Optional Terminal Computer Interface.

The terminal/computer interface option provides a simple mnemonic half-duplex ASCII communications protocol via a built-in macro language consisting of 1 to 3 character command strings (reference Table 4-3).

This powerful feature allows direct keyboard control (using easily remembered commands) of

DXp-10/15 calibration, and programming or recall of weight variables (gross, net, tare, zero, etc.) An on-line help function is available by transmitting an ASCII Ir.

Easily learned macro language syntax greatly simplifies the writing of a host computer communication interface (customer supplied).

1.2.3 Optional Modbus RTU Interface.

The Modbus interface option provides a simple seamless communication link to any PC, PLC or DCS with a mod-bus RTU Driver Option. Use of this industry standard protocol (see paragraph 4.1.4) eliminates the requirement for custom software driver development.

1.2.4 Optional Fisher ProVox Protocol

DXp-15 transmitters may be ordered with the Fisher ProVox protocol. ProVox protocol allows the DXp-15 to interface directly with a Fisher ProVox distributed control system (DCS).

1.2.5 Optional Allen-Bradley Remote I/O

Optional Allen-Bradley Remote I/O (RIO) allows 13Xp-15 transmitters direct access to a PLC master processor. In essence, DXp-15 transmitters become direct coprocessors with the PLC. DXp-15 data is read directly into the

main ladder logic program without using BCD or serial interface cards. A simple three wire RIO network connection ties all units together, even if multiple DXp15s are used. Within the RIO network link, each DXp-15 is addressed as 1/4 'logical rack'. Since a PLC logical rack consists of 128 input and 128 output bits (or points), DXp units communicate 32 input and 32 output bits; 1/4 logical rack format. For a full description of logical rack addressing and data communications formatting, reference the Allen Bradley Remote I/O technical manual, BLH part number TM010.

1.2.6 Analog Option.

An optional analog output provides both a 4-20 mA and a 0-10 VDC output representing the gross weight value. The circuit uses a 12 bit D-A converter providing up to 4096 counts of resolution. The current output drives up to a 1000 ohm load and the voltage output will operate with a 25,000 ohm minimum load resistance.

1.2.7 Software Filter Option.

The digital filtering option offers eight software filtering selections. The filter algorithms dampen noise by averaging successive A-D conversions. Digital filtering allows fast response to true weight changes by setting limits on averaging based upon the magnitude of signal change. Filter selections are presented in SECTION III. Note: BLH tech note TD-071 provides a full discussion of filter operation.

1.3 DXp-10/15 SPECIFICATIONS

PERFORMANCE

Resolution:	
DXp-10	20,000 counts
DXp-15	50,000 counts
Sensitivity	
DXp-10	1.0 μ V/count
DXp-15	0.5 μ V/count
Full Scale Range	25 of 35 mV (selectable)
Dead Load Range	100%
Input Impedance	10 M-ohms, max.
Load Cell Excitation	10 V for up to eight 350 ohm load cells (250 mA)
(Factory Selectable)	15 V for up to six 350 ohm load cells (250 mA)
Linearity	\pm 0.01% of full scale

Temperature Coefficient

Span	2ppm/°C
Zero	± 2ppm/°C
Common Mode Rel.	100 db or better at or below 35Hz
Normal Mode Rej.	100 db or better at or below 35Hz
Conversion Speed	DXp-10 400 msec DXp-15 50 msec

Environment

Operating Temperature	-10 to 55°C (12 to 131°F)
Storage Temperature	-20 to 85°C (-4 to 185°F)
Humidity	5 to 90% rh, non-condensing
Voltage	117/230 1: 15% 50/60 Hz
Power	10 watts max
Parameter Storage	EEPROM
EMVRFI	Shielded from typical industrial interference

ENCLOSURE

Dimensions	(NEMA 414X) 11.5 x 8.0 x 4.3 HWD
Explosion Proof	12.875 x 10.875 x 8.188 HWD

OPTIONS**Isolated Analog Output**

Type	12 bit Digital to Analog Conversion
Voltage	0 to 10 volt (25K ohm min load)
Current	4 to 20 mA (1000 ohm max load)

SERIAL COMMUNICATION**LCp-40 Network (Standard)**

Type	RS 485 Half Duplex (Multi-Drop)
Baud	56.7k

Simplex Data Output (Standard)

Interface Type	RS 485 (Simplex)
Data Format	Simplex ASCII Data
	7 Data Bit
	Even Parity
	1 Stop Bit

Terminal/Computer Interface (Optional)

Interface Type	RS 485 Half Duplex (Standard)
Baud	1200 or 9600
Protocol	Duplex Command/Response Format

MODBUS RTU Protocol (Optional)**Fisher ProVox Protocol (Optional)****Allen-Bradley Remote I/O (Optional)**

Consult factory for details

1.4 ORDERING SPECIFICATIONS

DXp-10 or DXp-15 [M]-[C]-[P]-[S] Includes: RS 485 Serial Output

[M] Mounting

- (1) NEMA 4 Painted — standard
- (2) NEMA 4X Stainless Steel
- (3) NEMA 7 & 9 Explosion-Proof Class I, H, Div. 1,2 Grp. B—G
- (8) #1 & FM/CSA Approved [Class I, Div 2, Group ABCD FG]
- (9) #2 & FM/CSA Approved [Class I, Div 2, Group ABCD FG]

[C] Communication

- (1) RS 485 LCp-40 Network — standard
- (2) RS 485 LCp-40 Network and Terminal/Computer Interface
- (4) Allen Bradley Remote I/O (DXp-15 only)
- (5) MODBUS RTU Protocol (D4-15 only)

[P]Process Output

- (1) No Process Output — standard
- (2) 0-10 V & 4-20 mA analog

[S]Software

- (1) Standard
- (2) Dynamic Digital Filtering (DXp-15 only)

1.5 WARRANTY POLICY

BLH warrants the products covered hereby to be free from defects in material and workmanship.

BLH's liability under this guarantee shall be limited to repairing or furnishing parts to replace, f.o.b. point of manufacture, any parts which, within three (3) years from date of shipment of said product(s) from BLH's plant, fail because of defective workmanship or material performed or furnished by BLH. As a condition hereof, such defects must be brought to BLH's attention for verification when first discovered, and the material or parts alleged to be defective shall be returned to BLH if requested. BLH shall not be liable for transportation or installation charges, for expenses of Buyer for repairs or replacements or for any damages from delay or loss of use for other indirect or consequential damages of any kind. BLH may use improved designs of the parts to be replaced. This guarantee shall not apply to any material which shall have been repaired or altered outside of BLH's plant in any way so as, in BLH's judgment, to affect its strength, performance or reliability, or to any defect due in any part to misuse, negligence, accident or any cause other than normal and reasonable use, nor shall it

apply beyond their normal span of life to any materials whose normal span of life is shorter than the applicable period stated herein. In consideration of the forgoing guarantees, all implied warranties are waived by the Buyer, BLH does not guarantee quality of material or parts specified or furnished by Buyer, or by other parties designated by buyer, if not manufactured by BLH. If any modifications or repairs are made to this equipment without prior factory approval, the above warranty can become null and void.

1.6 FIELD ENGINEERING

The field service department at BLH is the most important tool to assure the best performance from your application. The expertise and understanding of BLH's Field Engineers can solve even the most perplexing installation problem. Precise calibration and start-up procedures, performed by a qualified, experienced field engineer, assure not only the reliability of BLH components, but the integrity of the entire weigh system.

Call (Factory Number) (781) 298-2200

Ask for Field Service

Canada (416) 251-2554

SECTION 2. Installation

2.1 INTRODUCTION

2.1.1 General.

The DXp-10/15 is designed to be installed within the length of the load cell(s) cable which is normally 35 ft or less. The standard NEMA 4 or optional NEMA 4X enclosures are suitable for an outdoor or wash down type environment. Both enclosures are provided with pre-punched holes for installation of conduit or cable fittings and holes for mounting to a bracket or wall.

2.2 MOUNTING

2.2.1 Standard Units.

The NEMA 4 and NEMA 4X enclosures are equipped with four pre-punched holes for mounting to a wall or bracket. A U-bolt can be used for mounting to a pipe support. The

instrument should be installed in a vibration-free location within the normal length of the load cell cables. If conduit is used, drains should be provided to reduce the possibility of condensate entering the enclosure. Outline dimensions for the standard DXp-10/15 transmitter are presented in Figure 2-1.

2.2.2 Explosion-Proof and Division 2 Options.

DXp units may be ordered with an optional explosion-proof enclosure for use in Division I hazardous locations. Dimensions for the optional explosion-proof enclosure are provided in Appendix C.

For Division 2 applications, FM approved units are available as non-incendive devices in NEMA 4/4X enclosures with dimensions identical to those presented in Figure 2-1.

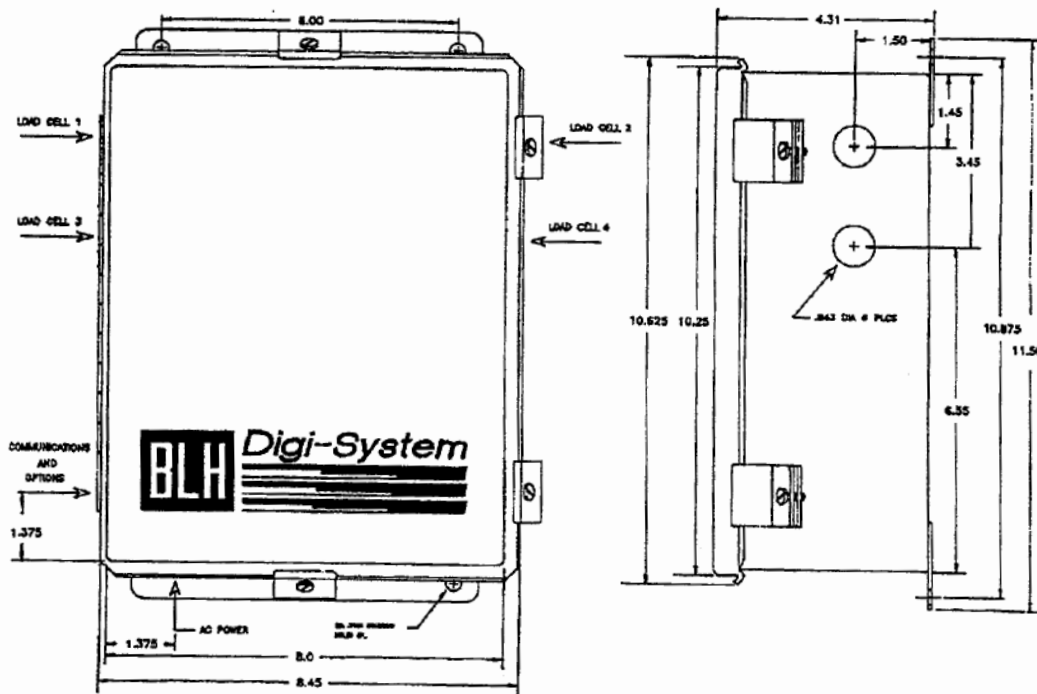

Figure 2-1. DXp-10 Outline Dimensions

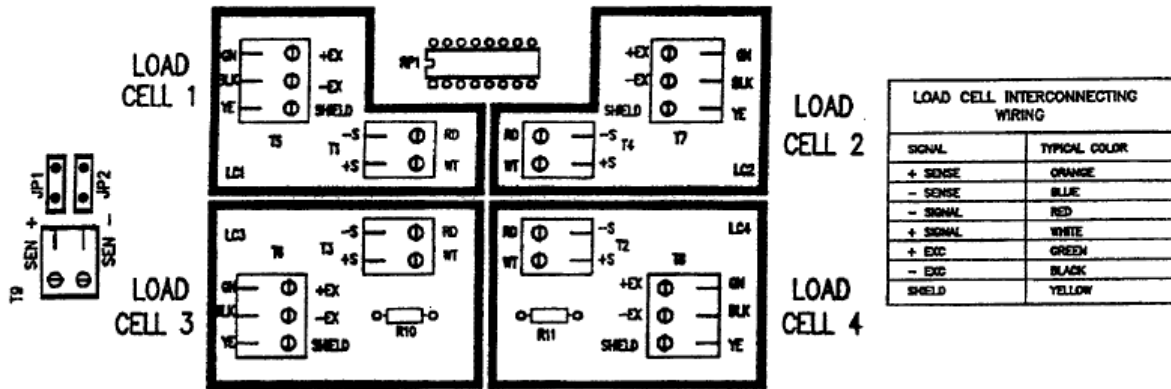

Figure 2-2. Load Cell Connections.

2.3 ELECTRICAL

2.3.1 Transducer Inputs.

Up to four load cells can be connected to the summing circuit within the DXp. Connect individual load cells directly to the circuit board connectors as shown in Figure 2-2. Excitation and signal connection locations are clearly marked according to function and standard color code.

If more than four cells are required, an external 308A summing junction box must be used. Make all load cell connections in the 3084 unit, not the DXp-10/15. Connect the output leads of the 3084 summing box to the load cell #1 terminal blocks in the DXp. Sense leads from the 3084 must be connected to the sense terminal blocks in the DXp-10/15 (Figure 2-2). Jumpers JF1 and JP2 must be removed.

2.3.2 Serial Communication.

If a deadweight or substitution method of calibration is being used, the load cal cable can be shortened as required. The leads should be re-tinned before the final connection is made.

NOTE: If tension or universal load cells are used, red (-signal) and white (+ signal) leads may need to be reversed.

A terminal connector is provided for RS 485 wire connections (Figure 2-3). Multiple DXp transmitters, networked together, are wired in a parallel configuration with a termination jumper installed on the last instrument. A pair of twisted wires (14-20 gauge) is all that is required for interconnection. Communication lines should not be run near ac voltage power lines.

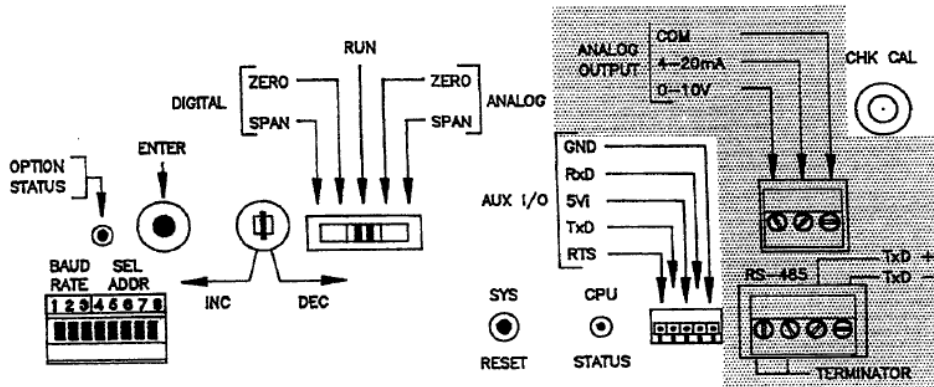

Figure 2-4. Ac Power Connections and Fuse

2.3.3 Analog Output.

When the analog option is installed (shown, Figure 2-3), a three position terminal connector is provided for 4-20 mA, 0-10 V, and common connections. As with serial communication, the wiring should be routed away from ac power lines and other sources of EMI. The current output is essentially immune to noise and can be transmitted long distances. The voltage output is susceptible to EMI/RFI and should be used only for short distances.

2.3.4 Mains (AC) Power (Figure 2-4).

A screw terminal is provided for permanent transmitter power connection. DXp transmitters

can be switch selected to operate at 115 or 220 VAC (see SW1, Figure 2-4). Before connecting power to the unit, verify that the proper power selection has been made. The two position terminal block is equipped with a clear plastic cover to prevent operator injury. Cable can be either solid or stranded 12 or 14 gage with a ground conductor.

The transmitter is protected with a 114 amp slow blow fuse, located adjacent to the mains terminal block. If the fuse opens, replace it with the same type and current rating.

2.3.5 Auxiliary I/O Port.

The auxiliary I/O port connection is a factory test port and is not useful to an operator.

SECTION 3. Configuration

3.1 GENERAL

Set-up and calibration of the DXp-10/15 is accomplished by an operator without programming using the DIP switches, push-buttons, and toggle switches within the unit. Units connected to an LCp-40 or computer terminal can be set-up and calibrated remotely via the serial port (see Appendix E).

3.2 SET-UP

3.2.1 Power Selection

All units are shipped from the factory configured for 115 VAC operation. To change the voltage selection to 230 VAC, change SW1 (see Figure 2-4) to the 230V setting. The unit will operate within specification at 50 or 60 Hz.

3.2.2 Excitation Voltage.

All units are shipped from the factory set for 10 volt excitation.

3.2.3 Serial Format, Address, and Baud Rate.

DIP switch selections for transmitter address, baud rate and serial interface format are presented and defined in SECTION IV, Serial Communication.

3.2.4 Input Range Selection.

Units are shipped configured for a 25 mV input range. To increase this range to 35 mV, remove the jumper shunt from JP2 on the A-D converter board as shown in Figure 3-1 (see Appendix A photo for A-D board location).

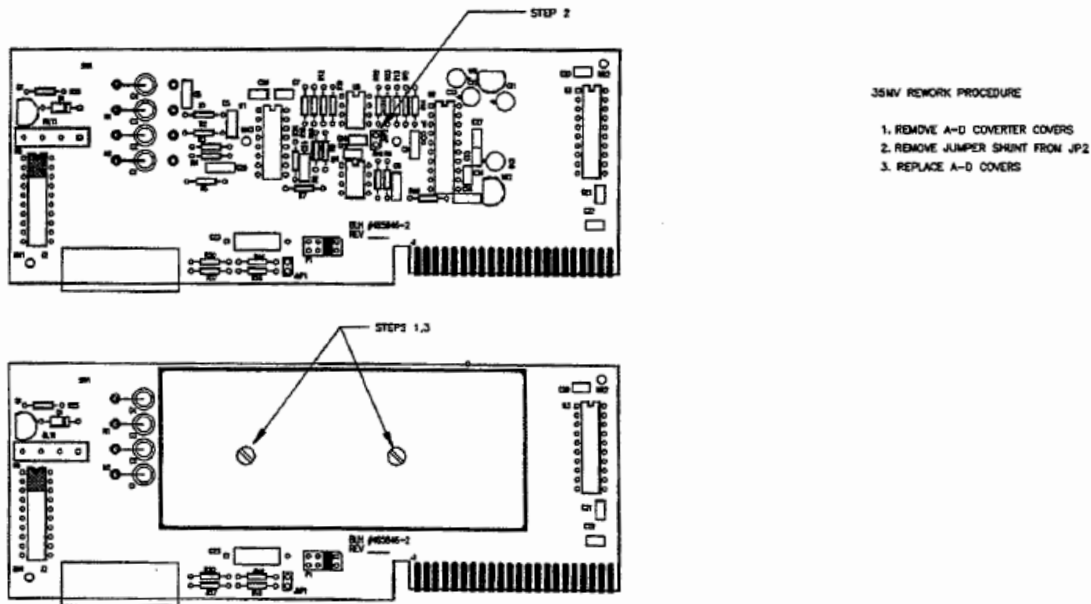

Figure 3-1. 35 mV Input Conversion Instructions

3.3 CALIBRATION

Note: All switches mentioned in paragraphs 3.3.1 – 3.3.4 are depicted in Figure 3-1.

3.3.1 Digital Calibration.

The transmit only serial output can be digitally calibrated using the DIGITAL selector, 1NC/DEC

and ENTER switches mounted on the DXp-10/L5 control panel. For those systems where applying a full capacity dead weight or input signal is not practical, the DXp-10/15 will automatically calculate a linear full span calibration based on a single span point. See Table 3-1 for instructions.

3.3.2 Analog Calibration.

The analog output is calibrated independently of the digital calibration and can be set using span points anywhere between zero and full scale capacity. The 0-10 V and 4-20 mA outputs CAN NOT be calibrated independently. See Table 3-2 for complete analog calibration instructions.

3.3.3 Monitor Mode Calibration.

The terminal/computer interface option enables the DXp-10/15 to be calibrated remotely from a host computer or terminal. The monitor mode functionally accesses the software routines used to provide remote access via the keypad of an LCp-40 Network Controller. In response, the DXp-10/15 transmits two lines of information similar to the two line display on an LCp-40. In this mode the capacity, graduations, decimal

point, 5 point linearization and other values can be established from the host device. Help messages also can be accessed at any time to aid in the set-up process. The procedure recorded in Table 3-3 shows the command sequence required to perform remote calibration. Consult SECTION IV for serial communication details.

3.3.4 LCp-40 Calibration.

When networked to an LCp-40, 41, or 42 controller, the DXp-10/15 can be remotely calibrated using the controller display and keypad. In this configuration, up to five linearized span points can be entered. Appendix E presents step by step flow diagrams for remote LCp-40 calibration and parameter set-up.

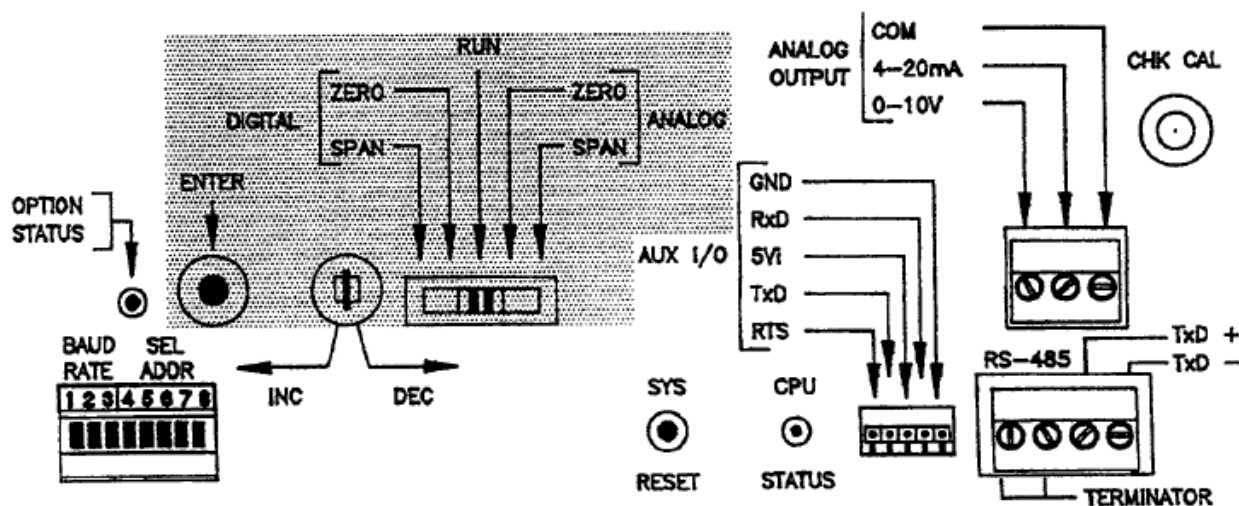

Figure 3-2. Set-up and Calibration Switch Locations (Shade)

Table 3-1. DXp-10 Digital Calibration Instructions

[1]. Connect Load Cells and Remote Terminal.

Install the load cells and wire them to the DXp-10/15. Connect the RS 485 serial output to a compatible terminal/readout device. Select a compatible serial output format and establish that the communication link is operating (paragraph 3.2.3).

[2]. Establish Zero.

Make sure that all dead weight (vessel, mixer, pipes, etc) is applied as it will be during normal operation. Move the five position slide switch (Figure 3-2) to the digital zero position. Press the enter button to acquire zero and wait approximately 5 seconds for the zero reference value to be stored. The red OPTION STATUS LED will resume flashing when the storage procedure is complete.

[3]. Load System.
Apply a known “live” weight value to the scale/vessel or input a known mV/V signal from a BLH 625 calibrator to the DXp unit. (NOTE: An external mV source cannot be used to calibrate a DXp-10/15. A BLH 625 calibrator is required. If a 625 calibrator is not available, contact a BLH field service center for assistance.)

[4]. Establish Full Span.
Move the 5 position slide switch to the digital span position. Use the increment/decrement toggle switch to increase or decrease the displayed (terminal/output device) weight value until the displayed value matches the known weight value. Note that the rate of the value change accelerates the longer the switch is depressed. When the desired value is displayed, press the enter button and wait approximately five seconds for storage. Again, the red OPTION STATUS LED will resume flashing when storage is complete. NOTE: There is no decimal point available using this calibration method. The DXp will default to the best resolution possible based upon the scale capacity and input signal.

[5]. Resume Normal Operation.
Return the 5 position slide switch to the run position. Digital calibration is complete.

Table 3-2. DXp-10 Analog Calibration Instructions

[1]. Connect Load Cells and Volt/Current Meter.
Install the load cells and wire them to the DXp-10/15. Connect the analog output to a voltage or current meter.

[2]. Establish Zero Reference/First Span Point.
Make sure that all dead weight (vessel, mixer, pipes, etc.) is applied as it will be during normal operation. Move the five position slide switch (Figure 3-2) to the analog zero position. Use the increment/decrement toggle switch to adjust the analog output so that the desired value is displayed on the meter. Holding the toggle switch in the depressed position increases the rate of change. Press the enter button to acquire zero and wait approximately 5 seconds for the zero reference value to be stored. The red OPTION STATUS LED will resume flashing when the storage procedure is complete.

[3]. Load System.
Apply a known “live” weight value to the scale/vessel or input a known mV/V signal from a BLH 625 calibrator to the DXp unit. (NOTE: An external mV source cannot be used to calibrate a DXp-10/15. A BLH 625 calibrator is required. If a 625 calibrator is not available, contact a BLH field service center for assistance.)

[4]. Establish Full Span.
Move the 5 position switch to the analog span position. Use the increment/decrement toggle switch to increase or decrease the displayed (meter display) weight value until the displayed value matches the known weight value. When the desired value is displays, press the enter button and wait approximately 5 seconds for storage. Again, the red OPTION STATUS LED will flash when storage is complete.

[5]. Resume Normal Operation.
Return the 5 position slide switch to the run position. Digital calibration is complete.

Table 3-3A. Setup in Monitor Mode.

ASCII Command in Order of Operation	Serial Output	Explanation
SMM	Set Monitor Mode	Access Monitor Mode
C	Setup	Access Setup to Enter/Alter System Parameters
M	5000 – CAP LB	Modify Setup
M-I or D	500.00 (flashing) CAP LB	Modify Capacity
I or D	400.00	Increment or Decrement Digits
E	400.00 CAP LB	Enter Capacity
E	400.00	Select Decimal Position
M-I or D	400.00 DECIMAL	Change Decimal Position
E	400.00	Enter Decimal
E	0.050 GRAD	Graduation Setting
M I or D E	0.050 0.050 0.050 GRAD	Modify Graduation Increment/Decrement Enter
E	102 OVER	Overrange Setting
M-I or D	OFF/102	Select OFF or 102%
E	20 ZERO	Change Zero Selection
M-I or D	2 ZERO	Select 2% or 20% Full Scale Zero Allowance
E	2 ZERO	Enter Selection
E	OFF MN BAND	Change Motion Band Selection
M-I or D	OFF MN BAND	Select OFF, 1, or 2 counts
E	OFF MN BAND	Enter Selection
E	SETUP	Parameter Enter/Alter Complete
E	Normal Weighing	

Table 3-3B. Calibration in Monitor Mode

ASCII Command in Order of Operation	Serial Output	Explanation
E	CAL	Enter Calibration Mode
M	000 ZERO	Zero Setting
Z	000 Acquire	Acquire Zero
E	CLEAR	Clear Old Span Point(s)
M-Z or E	SPANS	Span Setting
M	5100.00 166329	Span 1 Value Internal Counts
X	SPANS	Skips Span
E	Adjust	Change Spans
M	000 (flashing) SPAN 1	Adjust Span1
M	0000 (flashing)	Acquire Span 1
M & I/D	1000.0	Enter Span 1 Weight Value
Note: Use M & E to access and change spans 2-5 if desired.		
E E	Normal Weighing	Exit CAL Mode

3.4 CHECK CAL

The standard transmitter is provided with a check cal feature that can be operated manually by pushing a button on the DXp operator panel (see Figure 3-1) or remotely via the serial port. This feature provides a check of the instrument calibration to verify that drift or other problems have not occurred. Check cal uses an internal shunt resistor circuit to provide a fixed repeatable signal into the input of the transmitter. The input signal produces a known output which can be verified by viewing the terminal/meter used to perform calibration.

Due to the infinite variety of calibrations and applications, a range of shunt calibration values are available by changing the position of the resistor circuit component carrier in socket U6 on the A/D board. Access is obtained by removing the card rack cover and should be performed by a qualified technician. In most cases, a value that produces a signal equal to 80% of system capacity is desired. Table 3-4 lists the positions and resulting percent of output given a typical 2.0 mV/V load cell application.

Table 3-4. Check Cal Percentage Selection/Module Position.

Module Position	Resistance (ohms)	1 Cell	2 Cells	3 Cells	4 Cells
1	13400	125%	114%	78%	59%
2	94800	125%	125%	110%	84%
3	15800	125%	97%	66%	50%
4	70400	41%	22%	15%	11%
5	546000	53%	28%	19%	14%
6	395000	74%	39%	26%	20%
7	309000	94%	50%	33%	25%
8	237000	125%	65%	44%	33%

Percent of Full Scale (2 mV/V) Output when Check Cal Button is Pressed.

3.5 FILTER SELECTION

3.5.1 Standard Filter.

Standard filtering offers simple successive averaging of A-D conversions to stabilize the output signal. Pressing and holding the enter button accesses the selection mode: the increment/decrement toggle switch changes the setting. As the setting is changed, the OPTION STATUS LED flashes to indicate the selection. Average selections of 1, 2, 4, 8, 16, 32, 64 or 128 are available (Table 3-5).

Table 3-5. Standard Filter Selections

Setting (Flashes)	Conversions Averaged
1	1
2	2
3	4
4	8
5	16
6	32
7	64
8	128

Hold down enter key and toggle INC/DEC key for selections.

3.5.2 Optional Digital Filtering.

Optional digital filtering offers the benefits of successive averaging without the corresponding delay in response time to real weight changes. Digital filtering software determines the number of A-1) conversions to be averaged on a moving basis (Figure 3-3). Conventional averaging takes place at the selected rate within a window of counts defined as 'band' (Table 3-6). If the signal exceeds the band count limits, averaging continues on a reduced basis within the larger window of counts designated 'response'. Once the signal exceeds both windows, band and response, averaging stops until the signal begins to stabilize again. This two-dimensional approach provides fast, accurate, and stable weight data for difficult process weighing applications. Consult BLH technical note 7D-071' for a complete explanation of optional digital filtering.

Pressing and holding the ENTER button accesses the filter selection mode: the increment/decrement toggle switch changes the setting. As the setting is changed, the OPTION STATUS LED flashes to indicate the selection (one flash = setting one, etc.). Table 3-6 (upper portion) defines the parameters of each of the eight possible selections. Releasing the ENTER button stores the

selection. After selecting a filtering parameter, choose an averaging value (Table 3-6 lower portion). Select averaging by holding the toggle switch to increment or decrement to access the selection mode. Press the ENTER button to change. The OPTION STATUS LED flashes to indicate the selection number (14 flashes). Releasing the toggle switch stores the selection.

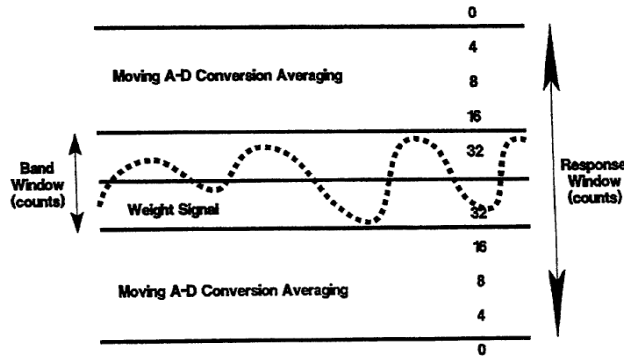

Figure 3-3. Optional Digital Filtering Operation.

Table 3-6. Optional Digital Filtering Selections.

Filter Type Selection: Hold down enter key and toggle INC/DEC key for selections.

Setting (Flashes)	Averaging*	Band (Counts)	Response (Counts)
0	*	0	0
1	*	1	4
2	*	2	8
3	*	4	16
4	*	8	32
5	D*	1	4
6	D*	2	8
7	D*	4	16
8	D*	8	32

Averaging Selection: Hold toggle switch to INC/DEC, press enter key for selections.

Setting (Flashes)	Conversions Averaged
1	1
2	2
3	4
4	8
5	16
6	32
7	64
8	128

*Insert averaging value as selected in table above; 'D' doubles averaging value selection.

3.6 Factory Default Calibration

Table 3-7 presents the DXp-10/1.5 factory calibration default parameters. All DXp units shipped by BLH are calibrated to the specifications shown in Table 3-7.

Table 3-7. Factory Calibration Default Parameters

DXp Parameter	Default Specification
Capacity	10,000
Units	Pounds
Decimal Point	None
Grad	1
Overrange	Off
Zero Band	2% of capacity
Motion Band	Off
External Zero	0
Span 1 Units	10,000
Span 2 Units	Cleared
Span 3 Units	Cleared
Span 4 Units	Cleared
Span 5 Units	Cleared
D/A Zero Volt Output	0 (min bit of 4095)
D/A 10V Output	4095 (max bit of 4095)
Filter	1
Averaging	1

* The Dxp-10 has up to 368,640 raw internal counts.

SECTION 4. Serial Communication

4.1 GENERAL

The DXp-10/15 is equipped with a variety of standard and optional serial output formats that are selected using a series of DIP switches (Figure 4-1). DIP switch positions 1, 2, and 3 allow three format choices; Digi-System network, continuous output, and terminal/computer interface (Table 4-1). All three types of DXp interfacing will be discussed in the following paragraphs. Positions 4-7 designate transmitter address for applications requiring more than one DXp unit (Table 4-2). Switch position 8 is unused and should be left in the '0' (ON) position.

NOTE: If the MODBUS option is installed and enabled, use the DIP switch selections presented in Figure 4-2• (Page 4-4).

4.1.1 LCp-40 Digi System Network.

Up to 16 DXp-10/1.5 transmitters can be networked to the LCp-40 Network Controller. The half duplex format used to run the network is designed to provide remote operation of gross, net, tare, zero, calibration/set-up, and diagnostics, at high speed. This format is not intended for direct interface with a terminal or computer. The baud rate is selectable to accommodate systems with very long (low baud) or short (high baud) distances between DXp units.

4.1.2 Standard Simplex Output (Continuous Output).

The simplex output format is designed to transmit gross weight data (ASCII coded) to a remote terminal or computer. The accuracy of this point to point, digital communication

interface is much greater than simple analog current or voltage approximates. Simplex outputs are transmitted in the format on page 4-2, top left-hand column.

Table 4.1. Serial Interface and Band Rate Selections

Switch Positions 1 2 3	Baud Rate	Interface
0 0 0	9600	Digi-System Network
1 0 0	28800	Digi-System Network
0 1 0	57600	Digi-System Network
1 1 0	1200	Continuous Output
0 0 1	9600	Continuous Output
1 0 1	1200	Terminal Interface
0 1 1	9600	Terminal Interface
1 1 1	-	Reserved Setting; used for special protocol interface options

Switch Position 4 5 6 7	Address
0 0 0 0	16
1 0 0 0	1
0 1 0 0	2
1 1 0 0	3
0 0 1 0	4
1 0 1 0	5
0 1 1 0	6
1 1 1 0	7
0 0 0 1	8
1 0 0 1	9
0 1 0 1	10
1 1 0 1	11
0 0 1 1	12
1 0 1 1	13
0 1 1 1	14
1 1 1 1	15

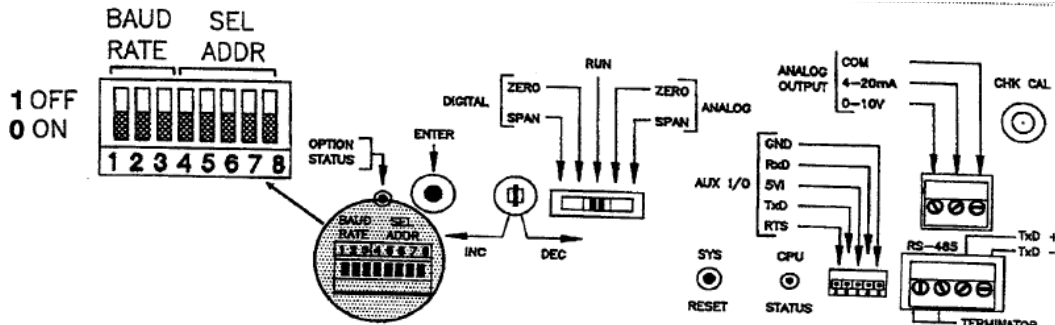

Figure 4-1. Serial Communication Parameter Selection Switch.

Transmit Only Data String Format

stx/adr/pol/data/sp/units/mode/stat/tc/CRLF

Where:

- stx = 1char. Start of Text (02H)
- adr = unit address 01-16, 3 chars; high add, low add, sp
- pol = Polarity sign; space (ASCII 2H) for positive data, minus (-) (ASCII 2D) for negative data
- data = 7 char; six digits with decimal point or leading space, leading zeros = spaces
- sp = 1 char; ASCII space (20H)
- units = 1 char; L= pounds, K= kilograms, C= Checkcal
- mode = 1 char; G= gross, N= net, C= checkcal
Z= zero cal, and S= span cal
- stat = 1char; M (motion), O (overload), or sp
- tc = 1 char. temperature compensation; R= remote inhibit, sp= auto
- CRLF= 2 char; carriage return, line feed (0DH/0AH)

Total bits per character = 1 start, 1 even parity, 7 data, and one stop.

4.1.3 Computer/Terminal Interface (Optional).

This half duplex (transmit and receive) format is designed for two way communication between a single D4-10/15, or a network of DXp-10/15 units, and a computer/terminal. Protocol accommodates all operations such as gross, net, tare, zero, as well as remote set-up, calibration, and filter selection. Use of this format requires customer developed device specific software to run the various network operations. Table 4-3 defines the terminal interface protocol. Monitor mode (see Table 4-3) allows many of the LCp-40 keypad switch functions to be implemented from the host terminal/computer. These functions are essential when performing remote calibration and parameter set-up.

Table 4-3a. Computer/Terminal Interface Protocol.

ASCII Command	Description	Action	Response
W	Weight	Return Current Weight Data and Mode Information	[stx/adr/pol/data/sp/units/mode/stat/tc/CRLF]
G	GROSS	Switch to Gross Mode	[stx/adr/pol/data/sp/units/"G"/stat/tc/CRLF]
N	Net	Switch to Net Mode	[stx/adr/pol/data/sp/units/"N"/stat/tc/CRLF]
T	Tare	Switch to gross mode and Tare	[stx/adr/pol/data/sp/units/"N"/stat/tc/CRLF]
Z	Zero	Switch to gross mode and Zero	[stx/adr/pol/data/sp/units/"G"/stat/tc/CRLF]
L	Pounds	Switch to Pounds	[stx/adr/pol/data/sp/"L"/mode/stat/tc/CRLF]
K	Kilograms	Switch to Kilograms	[stx/adr/pol/data/sp/"K"/mode/stat/tc/CRLF]
SMC	Set Continuous Mode	Send weight data continuously	[stx/adr/pol/data/sp/units/mode/stat/tc/CRLF]
SMD	Set Demand Mode	Must request data	
SC	Check Cal	Remotely Operates Check Cal	[stx/adr/pol/data/"C" "C"/stat/tc/CRLF]

Table 4-3b. Computer/Terminal Interface Protocol.

ASCII Command	Description	Action	Response
SMM	Set Monitor Mode	Transmit display each update	Instrument display output Lower Display/sp/Upper Display/CR
SMR	Set Mode for Remote Inhibit Of Temperature Conversions	Turn off Auto Temperature Compensation Cycles	
SMA	Set Mode for Automatic Temperature Compensation	Turns on Temperature Compensation Cycles (note 1)	
SFx	Set Digital Filter Value X = 0-8	Remote Selection of Digital Filter Value (note 2)	
SVx	Set Digital Averaging Value x = 0-7	Remote Selection of Digital Averaging (note 2)	
I	Increment	Increment blinking digit/selection	Monitor Mode Only
D	Decrement	Decrement blinking digit/selection	Monitor Mode Only
U	Units	Select lb/kg when modifying capacity	Monitor Mode Only
M	Modify/Shift	Same as MOD key	Monitor Mode Only
E	Enter/Step	Same as Enter/Step key	Monitor Mode Only
H	Help	Same as Help key	Monitor Mode Only
X	Exit	Same as Exit key	Monitor Mode Only
C	Cal	Same as Cal key	Monitor Mode Only
AXX	Address 01 – 16	Enable Addressed DXp Unit	

Note 1: In auto mode, 90 millisecond temperature compensation cycles occur once every 2 seconds. Temperature cycles are inhibited if there is critical positive or negative system motion.

Note 2: Remote filter and averaging selections are not stored in EEPROM. EEPROM values will be loaded at time of unit power up. See Table 3-6 for selection definitions.

List of abbreviations.

- stx= 1char. Start of Text (02H)
- adr= unit address 01-16,3 chars; high add, low add, Sp
- POI = Polarity sign; space (ASCII 2H) for positive data, minus (-) (ASCII 2D) for negative data
- data= 7 char; six digits with decimal point or leading space, leading zeros = spaces
- sP = 1 char; ASCII space (20H)
- units= 1 that; L= pounds, K= kilograms, C= Checkcal
- mode= 1 char; G= gross, N= net, C= checkcal
- Z= zero cal, and S= span cal
- stat = 1char; M (motion), 0 (overload), Or sp
- to = 1 char, temperature compensation; IR= remote
- inhibit sp = auto
- CR/LF= 2 char; carriage return, line feed (ODH/OAH)
- "= single quotes = ASCII character or string
- upper display = 7 ASCII characters
- lower display = 6 ASCII characters

4.1.4 MODBUS BTU Protocol (Optional).

MODBUS is a protocol developed by Modicon Inc. for communication between programmable controllers and operator stations which support them. For a complete description of the MODBUS interface, request BLH technical document TD-075. If the MODBUS option is

installed and enabled (DIP switch position 8 = OFF), interface parameters must be selected using the DIP switch configurations shown in Figure 4-2

If the MODBUS option is installed but not enabled, DIP switch selections will function as shown in Tables 4-1 and 4-2 (page 4-1). MODBUS protocol formats are presented on the following pages.

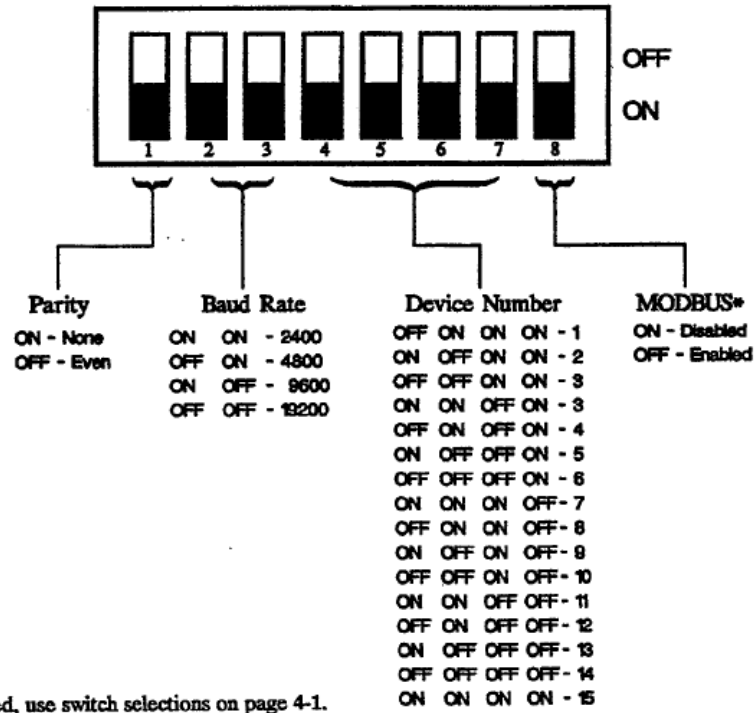

Figure 4-2. DIP Switch Selections for MODBUS Protocol.

MODBUS FUNCTIONS SUPPORTED:

- 02 Read Input Status
- 03 Read Holding Registers
- 06 Preset Single Register
- 16 (10 Hex) Preset Multiple Registers

DATA FORMATS:

- FORMAT #1: One 16 bit signed integer - 32768 to 32767 for all data
- FORMAT #2: Two 16 bit signed integers for weight data (the two integers must be added together to get -65536 to 65534) One 16 bit unsigned integer for status & setup parameters
- FORMAT #3: Two 16 bit signed Integers for weight data (the high word, 1st

integer, must be multiplied by 32768.0 then added to the low word, 2nd Integer)
One 16 bit unsigned integer for status & setup parameters

INPUT STATUS DEFINITIONS (Function 02)

INPUT STATUS

1	MOTION
2	UNABLE TO TARE/ZERO BECAUSE OF MOTION
3	UNABLE TO ZERO BECAUSE OF UMIT
4	CHECK CAL
5	ND UNDERLOAD
6	A/D OVERLOAD
7	SPARE (0)
8	POWERUP

9	IN ANALOG CAL
10	IN DIGITAL CAL
11	ACQUIRING CAL DATA
12	FILTER BEING CHANGED
13	EEPROM CODE ERROR - DEFAULT DATA LOADED
14	EEPROM READ ERROR
15	EEPROM WRITE ERROR
16	EEPROM DATA ERROR - FAULTED DATA REPLACED WITH DEFAULT DATA

DXP10/15 READ ONLY REGISTERS (Function 03)

READ ONLY	FORMAT #1 ADR #REG	FORMAT #2 ADR #REG	FORMAT #3 ADR #REG
STATUS	40001 1	40033 1	40065 1
GROSS	40002 1	40034 2	40066 2
NET	40003 1	40036 2	40068 2

DXP10/15 READ/WRITE REGISTERS (Functions 03, 06-format #1 only, 16)

READ/WRITE	FORMAT #1 ADR #REG	FORMAT #2 ADR #REG	FORMAT #3 ADR #REG
TARE	40004 1	40038 2	40070 2
ZERO	40005 1	40040 2	40072 2
ZERO UMIT	40006 1	40042 1	40074 1
FILTER TUNE	40007 1	40043 1	40075 1
AVERAGING	40008 1	40044 1	40076 1
MOTION	40009 1	40045 1	40077 1
MOTION TIMER	40010 1	40046 1	40078 1
SPAN CAL	40011 1	40047 2	40079 2

DXP10/15 WRITE ONLY COMMAND REGISTER (Functions 06, 16)

WRITE ONLY	FORMAT #1 ADR #REG	COMMANDS
COMMAND	40101 1	01 = TARE net weight 02 = ZERO gross weight

STATUS REGISTER BIT DEFINITIONS for addresses 40001, 40033, 40065

BIT	STATUS
0	MOTION
1	UNABLE TO TARE/ZERO BECAUSE OF MOTION
2	UNABLE TO ZERO BECAUSE OF LIMIT
3	CHECK CAL
4	ND UNDERLOAD
5	ND OVERLOAD
6	SPARE (0)
7	POVVERUP

- 8 IN ANALOG CAL
- 9 IN DIGITAL CAL
- 10 ACQUIRING CAL DATA
- 11 FILTER BEING CHANGED
- 12 EEPROM CODE ERROR - DEFAULT DATA LOADED
- 13 EEPROM READ ERROR
- 14 EEPROM WRITE ERROR
- 15 EEPROM DATA ERROR - FAULTED DATA REPLACED WITH DEFAULT DATA

ZERO LIMIT, FILTER, & MOTION SETIINGS

ZERO LIMIT (note on next page)

Setting	% of capacity
0	2
2	20

FILTER TUNE			AVERAGING	
setting	band (counts)	Response (counts)	setting	averaging
0	OFF	OFF		
1	1	4	0	1
2	2	8	1	2
3	4	16	2	4
4	8	32	3	8
5*	1	4	4	16
6*	2	8	5	32
7*	4	16	6	64
8*	8	32	7	128

*tune settings 5-8 double current averaging setting

MOTION		MOTION TIMER	
setting	counts	setting	time
0	OFF	0	0.8 sec
1	1	1	1.6 sec
2	2	2	32 sec
3	3	3	6.4 sec

If the count difference from conversion to conversion is greater than the motion setting, the motion status bit is set to 1. Once the count difference from conversion to conversion returns to be equal to or less than the motion setting, the motion bit remains set for the time selected for the Motion Timer.

Note 1: Zero limit settings are stored in EEPROM and are not lost if unit powers down. Filter and motion settings are lost if unit powers down.

Note 2: counts refers to weight graduations. If weight graduations are 2 lb increments then presetting a register to 2 would mean 4 lbs.

4.1.5 Fisher ProVox Protocol (Optional)

DXp-15 transmitters may be ordered with the Fisher ProVox protocol. Units equipped with this option communicate with a Fisher ProVox C16921 external interface card, configured for the 'Toledo' interface. For a further description of the hardware and software aspects of this interface, refer to BLH technical document TD-073.

Definitions for the byte and bit formats transmitted by the DXp-15 are presented below. To select the ProVox protocol option, DIP switch positions 1-3 must be set to 14,1. Baud rate is fixed at 4800 continuous output.

NOTE: Hardware requirement - An external hardware converter is required to change the DXp-15 RS-485 output to 20 mA current loop for interface with the ProVox CL6921 card.

FISHER PROVOX INTERFACE

1. TRANSMITT ONLY FORMAT - approx. every 200ms
2. BYTE FORMAT -10 BIT ASCII: 1 start, 7 data, 1 parity - even, 1 stop
3. DATA OUTPUT FORMAT - GROSS/TARE or NET/TARE provided - (tare always =0)
4. TOTAL (RESPONSE PACKET) FORMAT -18 bytes - 4800 baud – continuous

BIT ASSIGNMENTS FOR EACH BYTE

BYTE

#1	STX (02hex) (always first character sent)								
#2	STATUS WORD A - DECIMAL POINT POSITION OR DUMMY ZERO LOCATION bits 0,1,2								
bits	X00	X0	X	X	XX	XX	XXX	XXXX	XXXXX
0	0	1	0	1	0	1	0	1	1
1	0	0	1	1	0	0	1	1	1
2	0	0	0	0	1	1	1	1	1
COUNT BY SELECTION bits 3, 4									
bits	BY 1	BY 2	BY 5						
3	1	0	1						
4	0	1	1						
5	ALWAYS ONE								
6	ALWAYS ZERO								
7	EVEN PARITY (DONE BY INTERRUPT)								

#3 STATUS WORD B

bits	
0	GROSS=0, NET=1
1	POS=0, NEG=1
2	NOT OVERRANGE=0, OVERRANGE=1
3	NO MOTION=0, IN MOTION=1
4	LB DISPLAY = 0 KG DISPLAY = 1
5	ALWAYS = 1
6	NORMAL = 0 POWER UP = 1
7	EVEN PARITY (DONE BY INTERRUPT)

#4 STATUS WORD C bit 5 set all other bits zero

#5-#10 Indicated weight (Gross - ASCII form) (dxp-no net)

#11-#16 TARE weight (ASCII)- (dxp tare=zero)

#17 Carriage Return

#18 Checksum Character (2' compliment of all chars preceding checksum character, note:calculated without carry)

Byte Numbers Information Explanation	1 STX	2 SWA Decimal Point	3 SWB Gross/Net Plus/Minus	4 SWC Not Used	5-10 DATA Indicated Weight	11-16 DATA Tare Weight	17 CR	18 CHKSUM Two's Compliment
--------------------------------------	-------	---------------------	----------------------------	----------------	----------------------------	------------------------	-------	----------------------------

4.1.6 Allen-Bradley Remote I/O (Optional).

DXp-15 transmitters are available with the Allen-Bradley Remote 110 interface option. This option is available via a technology licensing agreement between BLH and Allen-Bradley. Functionally, this interface allows up to 8 BLH DXp-15 transmitters to communicate with an AB PLC-5 or SLC-5 programmable logic controller using discrete data transfers. Consult BLH manual TM010 for complete details.

SECTION 5. Operation

5.1 GENERAL

As a stand-alone unit (no terminal, computer, or LCp-40), either analog or digital, the DXp-1W15 typically transmits only gross weight data upon power-up. If the DXp-10/15 is being operated remotely from a host terminal, computer, or LCp-40, it can perform gross, net, tare, and zero functions.

5.2 GROSS WEIGHT WEIGHING

In the gross mode, all of the live weight of the system is transmitted. Live weight does not include the dead weight of a vessel or other mechanical equipment that is zeroed out during calibration.

5.3 ZERO OPERATION

A new zero can be acquired to compensate for changes in the dead load of the system due to heel build-up etc. Acquiring a new zero reference value does not affect the slope of the calibration. The zero function in the DXp-10/15 can be configured for either a 2% or a 20% ceiling (max percent of full scale capacity) if the unit is connected to a host terminal/computer or LCp-40.

5.4 NET WEIGHT WEIGHING

Net weight weighing is used when the operator wants to reset to zero to compensate for the

addition of live weight, or a container, before adding a specific amount of material. Tare is used to establish a zero reference in net mode.

5.5 TARE OPERATION

With the DXp-10/15 in net weighing mode, the tare operation resets the output to zero. Taring allows the operator to achieve a new zero reference before addition of each ingredient so that errors do not become cumulative.

5.6 ERROR DETECTION

When the DXp is reporting weight data to a host computer, dashes will be transmitted if an overrange condition occurs. When connected to an LCp-40, the node identification and dashes will be transmitted and displayed. When used in the monitor mode, a complete library of error codes is available for transmission (see Table 5-1).

5.7 CHECK CAL OPERATION

Manually depressing or remotely activating check cal through the serial port causes the transmitted weight data to increase by the given percentage (see Table 34). In systems using a host computer, this check can be made on a routine basis to verify the accuracy of the system.

Table 5-1. Error Codes and Flashing Display Explanations

DXp-10/15 Error Messages (As seen on an LCP-40 display or computer/terminal in monitor mode)

Error Message	Description	Action
E02	Signal Overrange	Check for open load cell circuit or overranged load cell (reading in excess of 35 mV at J-Box)
E03	Signal Underrange	
E04	Digital Overrange	Return to setup and increase capacity
E10	Internal Autozero Measure Is out of range	If external summing, check that SEN+ and SEN- leads are secure
E200	Cannot Attain Capacity	Return to setup and decrease capacity or review hardware gain setting
E201	Cannot Attain Capacity	Return to setup and increase GRAD or review hardware gain setting.

DXp-10/15 Power-Up/EEPROM Errors

LCp-40 Display	DXp-10/15 CPU Status LED	Description	Action
"EE DFAULT"	1 Blink	Default data loaded into EEPROM (New EEPROM)	Press Reset on DXp-10/15 Press exit on LCp-40
"EE WRITE"	2 Blinks	EEPROM write error	Press Reset on DXp-10/15 Press exit on LCp-40
"EE READ"	3 Blinks	EEPROM read error	Press Reset on DXp-10/15 Press exit on LCp-40
"EE XXXXXX"	4 Blinks	EEPROM checksum error	Press Reset on DXp-10/15 Press exit on LCp-40

NOTE: If pressing reset on the DXp does not clear an "EE" error, consult factory.

Flashing Display Explanations (As seen on LCp-40 display or computer terminal)

Operating Mode	Key Pressed	Flashing Display	Explanation
Gross	TARE	LB/KG	Cannot tare gross weight
Gross	ZERO	LB/KG	Current weight out of zero range
Gross	DISPLAY	No Change	Display set to show gross only
Net	ZERO	LB/KG	Cannot acquire zero while in net mode
Net	TARE	MOTION	Cannot tare while in motion
Net	TARE	GROSS	Cannot tare negative gross weight
Net	TARE	LB/KG	Cannot tare, gross weight beyond capacity

Appendix A

Spare Parts

Power Supply/Summing Board	PN 468372-3
A/D Converter with Shields	PN 466508-2*
CPU Board w/o EPROM	PN 464789-2
Programmed EPROM (specify code)	PN 465114
Switch Board (w/o analog)	PN 465432-2
D/A (Analog) Option Board	PN464941-2

Documentation

Outline Drawing NEMA 4/4X	PN 464952-3
Outline Drawing Exp. Proof	PN 465545-3
Outline Uncased	PN 465433-3
Interconnect Wiring	PN 465385-3
Assembly Drawing	PN 465170-3
Operator's Manual	TM 002

Accessories

625 Calibrator	PN 203797
Conduit Fitting Kit	PN 465231
Cable Fitting Kit	PN 465232

*Part #466508-2 is not a direct replacement for older part #465168-2; consult factory

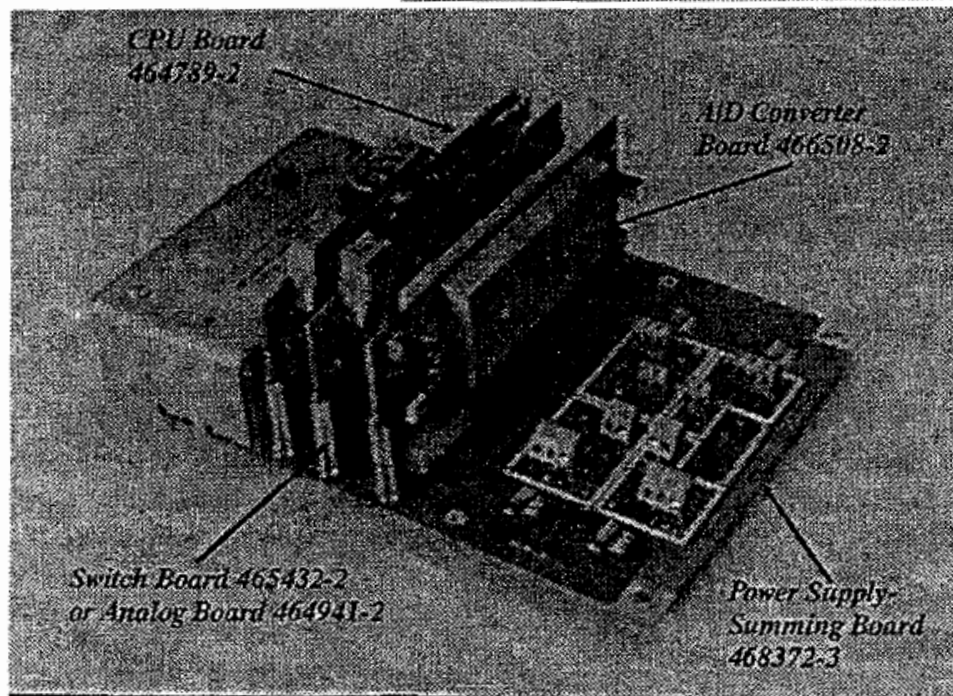

Note: Card rack covers removes

Appendix B

Uncased DXp-10/15 Transmitter

Consult factory for ordering information.

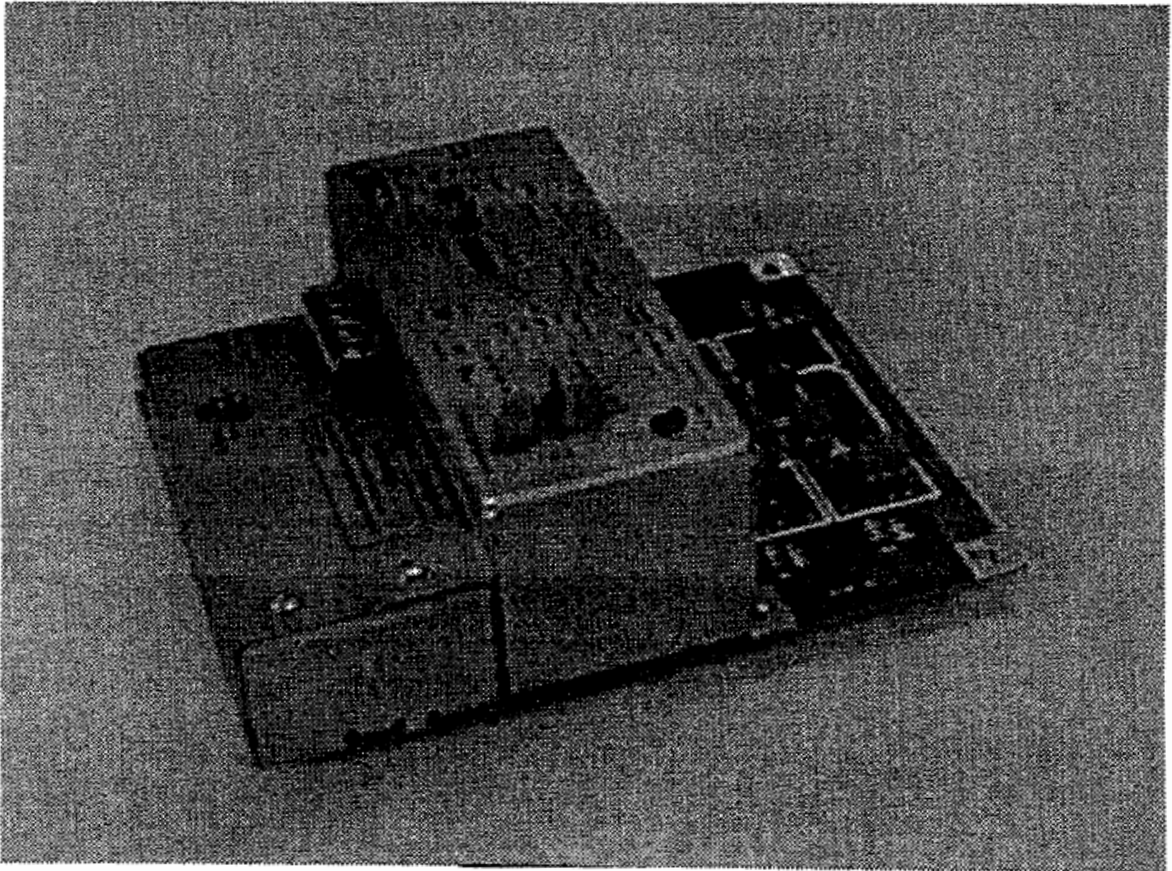

Outline Dimensions for Uncased Unit

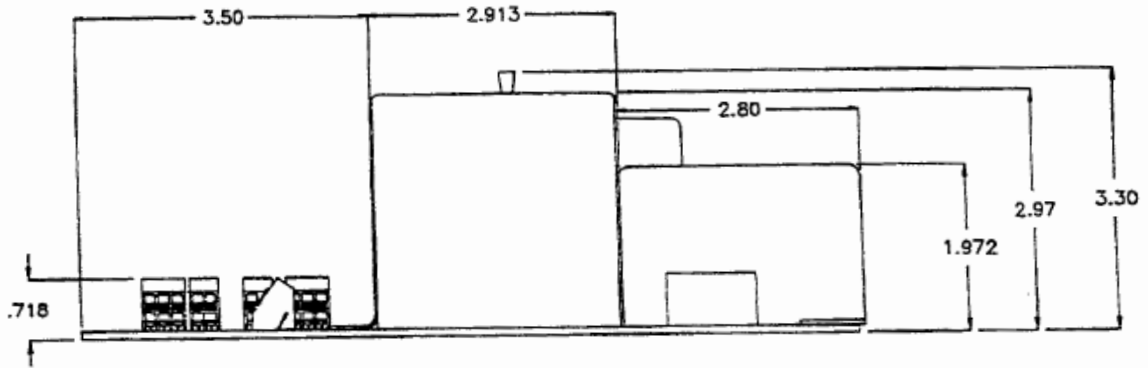
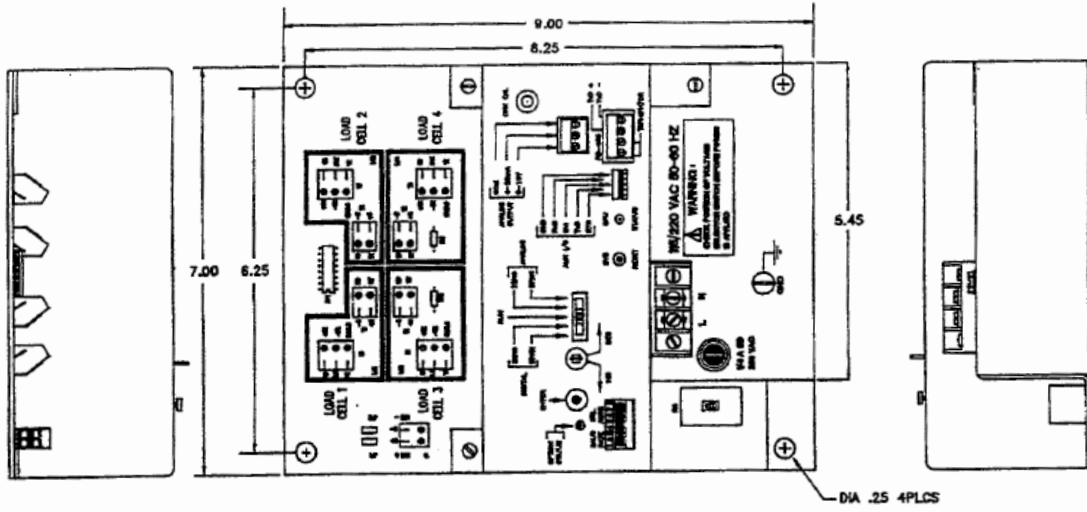

Appendix C: Wiring and Outline Drawings

Customer Wiring Diagram

Standard Unit Outline

Explosion-Proof Enclosure Outline

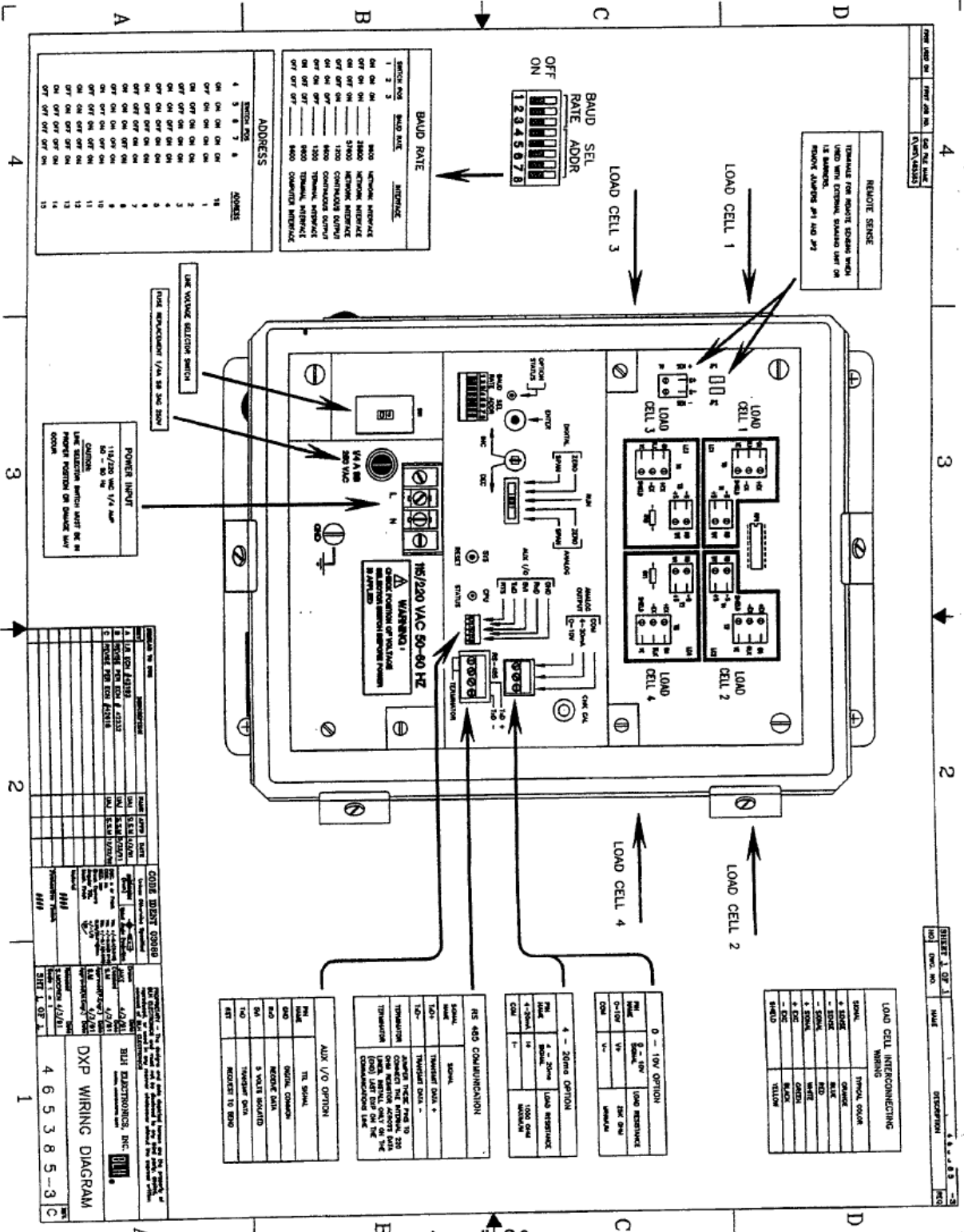

BAUD RATE

BAUD RATE	INTERFACE
300	NETWORK INTERFACE
600	NETWORK INTERFACE
1200	NETWORK INTERFACE
2400	NETWORK INTERFACE
4800	COMPARISON BOARD
9600	COMPARISON BOARD
19200	TRIMMABLE INTERFACE
38400	TRIMMABLE INTERFACE
76800	TRIMMABLE INTERFACE

ADDRESS

ADDRESS	ADDRESS
1	18
2	19
3	20
4	21
5	22
6	23
7	24
8	25
9	26
10	27
11	28
12	29
13	30
14	31
15	32

POWER INPUT

115/220 VAC 50-60 HZ
50 - 60 Hz
OUTLINE
POWER SWITCH MUST BE IN
OFF POSITION ON POWER UP
CIRCUIT

LOAD CELL INTERCONNECTING WIRING

WIRE COLOR	WIRE COLOR
GREEN	GREEN
RED	RED
BLACK	BLACK
YELLOW	YELLOW

0 - 10V OPTION

WIRE COLOR	WIRE COLOR
GREEN	GREEN
RED	RED
BLACK	BLACK
YELLOW	YELLOW

4 - 20mA OPTION

WIRE COLOR	WIRE COLOR
GREEN	GREEN
RED	RED
BLACK	BLACK
YELLOW	YELLOW

RES 485 COMMUNICATION

WIRE COLOR	WIRE COLOR
GREEN	GREEN
RED	RED
BLACK	BLACK
YELLOW	YELLOW

AUX I/O OPTION

WIRE COLOR	WIRE COLOR
GREEN	GREEN
RED	RED
BLACK	BLACK
YELLOW	YELLOW

DXP WIRING DIAGRAM

4 6 5 3 8 5 -3 C

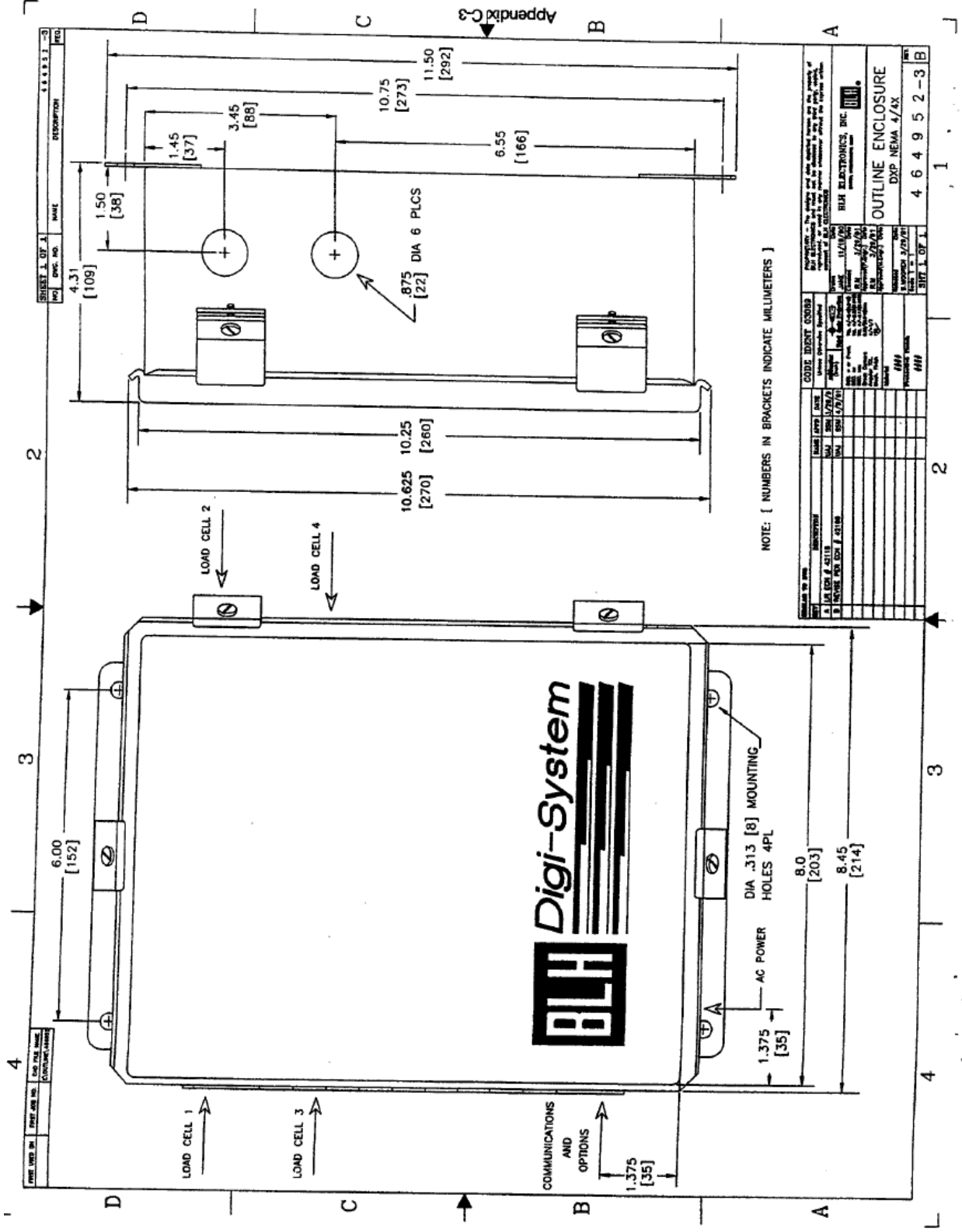

REV	DATE	BY	CHKD	DESCRIPTION
1	10/11/83	J. J.	J. J.	REVISED TO ADD LOAD CELL 1, 2, 3, 4

CODE IDENT. CODES NAME: BLH ELECTRONICS, INC. ADDRESS: 11111 N. 111TH ST., SUITE 100, OMAHA, NE 68148 PHONE: (402) 426-1111 FAX: (402) 426-1112 TELETYPE: (402) 426-1113 CABLE: BLHELE WWW: WWW.BLHELE.COM		OUTLINE ENCLOSURE DXP NEMA 4/XX 4 6 4 9 5 2 -3 B	
DATE: 10/11/83 DRAWN BY: J. J. CHECKED BY: J. J. APPROVED BY: J. J. TITLE: 111		DATE: 10/11/83 DRAWN BY: J. J. CHECKED BY: J. J. APPROVED BY: J. J. TITLE: 111	

NOTE: [NUMBERS IN BRACKETS INDICATE MILLIMETERS]

Part	4
Rev	1
Issue	1
Drawn	1
Checked	1
Approved	1
Material	1
Quantity	1
Notes	1

Part	4
Rev	1
Issue	1
Drawn	1
Checked	1
Approved	1
Material	1
Quantity	1
Notes	1

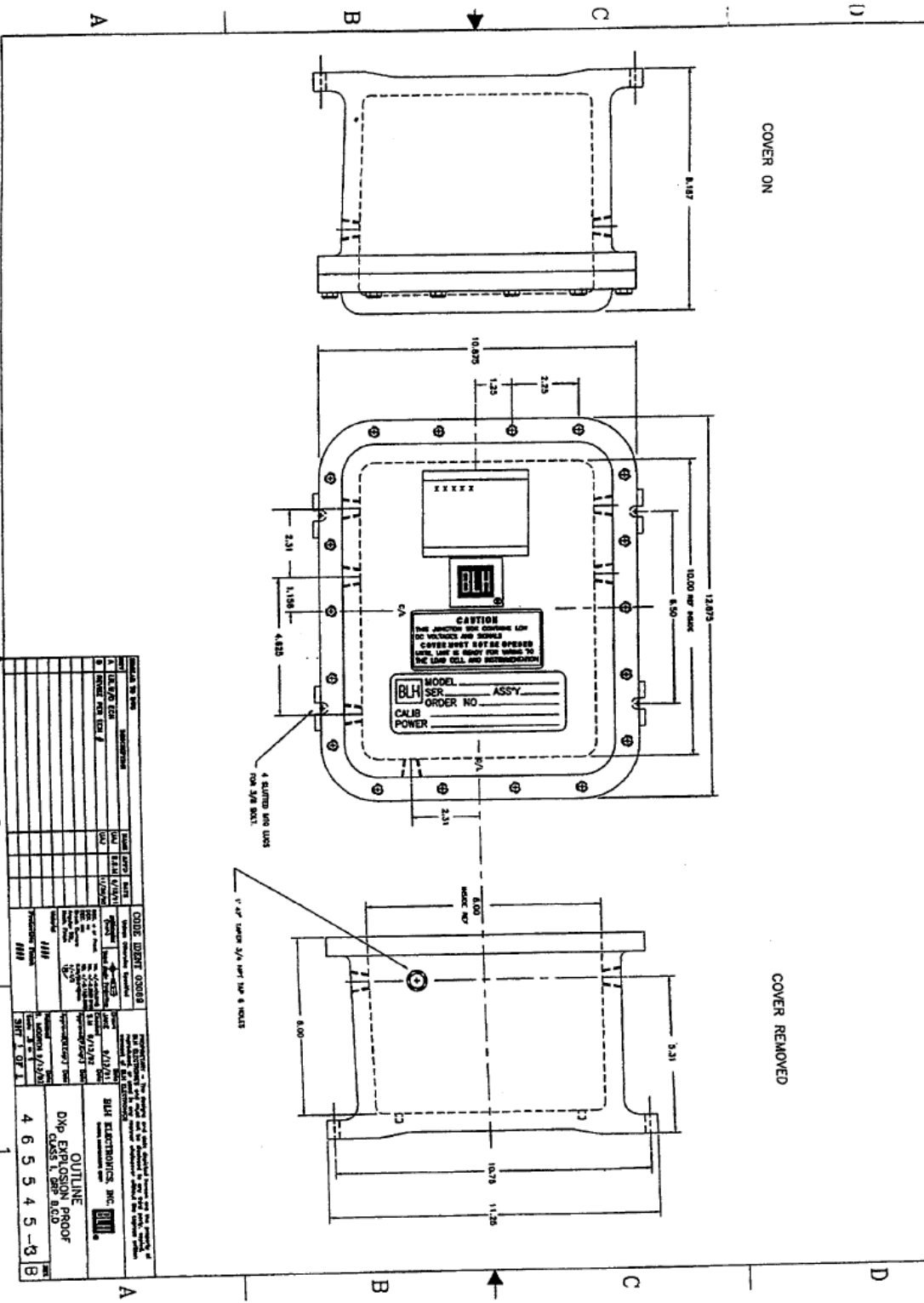

DATE	1/1/73	BY	MM
REV	1	BY	MM
ISSUE	1	BY	MM
DRAWN	1	BY	MM
CHECKED	1	BY	MM
APPROVED	1	BY	MM
MATERIAL	1	BY	MM
QUANTITY	1	BY	MM
NOTES	1	BY	MM

Appendix C-4

Appendix D, ASCII Table

DECIMAL	HEX	CHAR.	ALTERNATE NAME(S)	DECIMAL	HEX	CHAR.	ALTERNATE NAME(S)
0	00	NUL	NULL, ctrl @	64	40	@	AT SIGN
1	01	SOH	START OF HEADER, ctrl A	65	41	A	UPPER CASE "A"
2	02	STX	START OF TEXT, ctrl B	66	42	B	
3	03	ETX	END OF TEXT, ctrl C	67	43	C	
4	04	EOT	END OF TRANSMISSION, ctrl D	68	44	D	
5	05	ENQ	ENQUIRY, ctrl E	69	45	E	
6	06	ACK	ACKNOWLEDGE, ctrl F	70	46	F	
7	07	BEL	BELL ALARM, ctrl G	71	47	G	
8	08	BS	BACK SPACE, ctrl H	72	48	H	UPPER CASE "H"
9	09	HT	HORIZONTAL TAB, ctrl I	73	49	I	
10	0A	LF	LINE FEED, NL, ctrl J	74	4A	J	
11	0B	VT	VERT. TAB, VTAB, ctrl K	75	4B	K	
12	0C	FF	FORM FEED, PAGE, ctrl L	76	4C	L	
13	0D	CR	CARRIAGE RET, EOL, ctrl M	77	4D	M	
14	0E	SO	SHIFT OUT, RED, ctrl N	78	4E	N	
15	0F	SI	SHIFT IN, BLACK, ctrl O	79	4F	O	
16	10	DLE	DATA LINK ESC., DCO, ctrl P	80	50	P	UPPER CASE "P"
17	11	DC1	XON, READER ON, ctrl Q	81	51	Q	
18	12	DC2	TAPE, PUNCH ON, ctrl R	82	52	R	
19	13	DC3	XOFF, READER OFF, ctrl S	83	53	S	
20	14	DC4	PUNCH OFF, ctrl T	84	54	T	
21	15	NAK	NEG. ACKNOWLEDGE, ctrl U	85	55	U	
22	16	SYN	SYNCHRONOUS IDLE, ctrl V	86	56	V	
23	17	ETB	END OF TEXT BUFFER, ctrl W	87	57	W	
24	18	CAN	CANCEL, CANCL, ctrl X	88	58	X	UPPER CASE "X"
25	19	EM	END OF MEDIUM, ctrl Y	89	59	Y	
26	1A	SUB	SUBSTITUTE, ctrl Z	90	5A	Z	
27	1B	ESC	ESCAPE, PREFIX, ctrl [91	5B	[LEFT BRACKET
28	1C	FS	FILE SEPARATOR, ctrl \	92	5C	\	BACK SLASH
29	1D	GS	GROUP SEPARATOR, ctrl]	93	5D]	RIGHT BRCKT.
30	1E	RS	RECORD SEPARATOR, ctrl ^	94	5E	^	UP ARROW
31	1F	US	UNIT SEPARATOR, ctrl _	95	5F	_	UNDERLINE
32	20	SP	SPACE, BLANK	96	60	`	ACCENT GRAVE
33	21	!	EXCLAMATION POINT	97	61	a	LOWER CASE "A"
34	22	"	QUOTE MARK	98	62	b	
35	23	#	POUND SIGN	99	63	c	
36	24	\$	DOLLAR SIGN	100	64	d	
37	25	%	PERCENT SIGN	101	65	e	
38	26	&	AMPERSAND	102	66	f	
39	27	'	APOSTROPHE	103	67	g	
40	28	(LEFT PARENTHESIS	104	68	h	LOWER CASE "H"
41	29)	RIGHT PARENTHESIS	105	69	i	
42	2A	*	ASTERISK, STAR	106	6A	j	
43	2B	+	PLUS SIGN	107	6B	k	
44	2C	,	COMMA	108	6C	l	
45	2D	-	DASH, MINUS SIGN	109	6D	m	
46	2E	.	PERIOD, DOT	110	6E	n	
47	2F	/	SLASH	111	6F	o	
48	30	0	NUMBER ZERO	112	70	p	LOWER CASE "P"
49	31	1	NUMBER ONE	113	71	q	
50	32	2	NUMBER TWO	114	72	r	
51	33	3	NUMBER THREE	115	73	s	
52	34	4	NUMBER FOUR	116	74	t	
53	35	5	NUMBER FIVE	117	75	u	
54	36	6	NUMBER SIX	118	76	v	
55	37	7	NUMBER SEVEN	119	77	w	
56	38	8	NUMBER EIGHT	120	78	x	LOWER CASE "X"
57	39	9	NUMBER NINE	121	79	y	
58	3A	:	COLON	122	7A	z	
59	3B	;	SEMICOLON	123	7B	;	
60	3C	<	LESS THAN	124	7C		VERTICAL SLASH
61	3D	=	EQUAL SIGN	125	7D		ALTERNATE MODE
62	3E	>	GREATER THAN	126	7E		TILDE
63	3F	?	QUESTION MARK	127	7F	DEL	DELETE, RUBOUT

Appendix E

Remote Calibration Using an LCp-40, 41, or 42

DXp-10/15 transmitters can be calibrated and configured remotely using an LCp-40 series network controller. Remote calibration/configuration provides the advantage of displaying parameter entries for maximum setup accuracy. The following pages present flow diagrams for each available remote parameter entry.

Remote Calibration and Configuration of a DXp Node, Using an LCp-40, 41, or 42 Network Controller

Select DXp node as shown in LCp-40, 41, 42 Operator's Manual, then press MOD

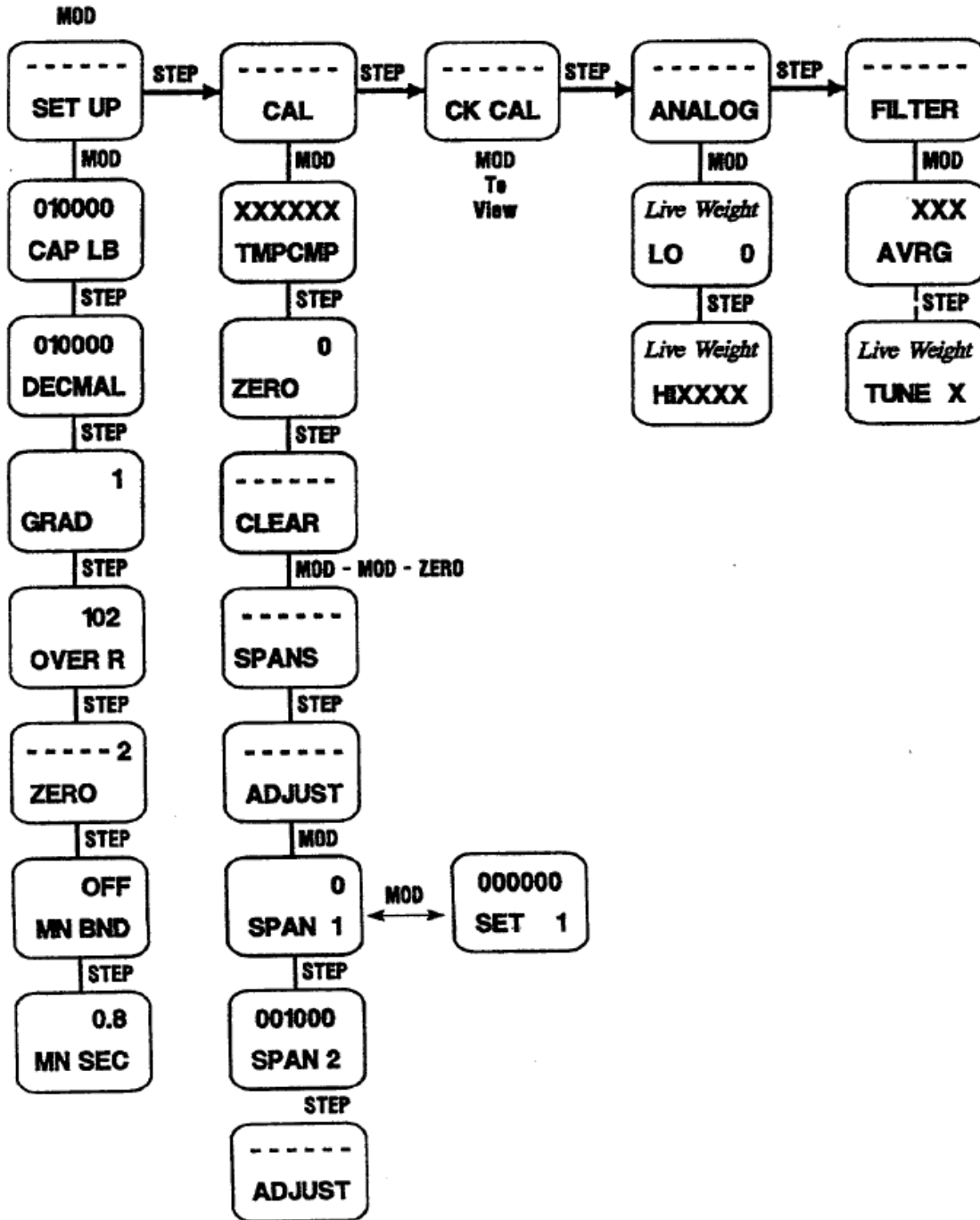

Select Operating Parameters

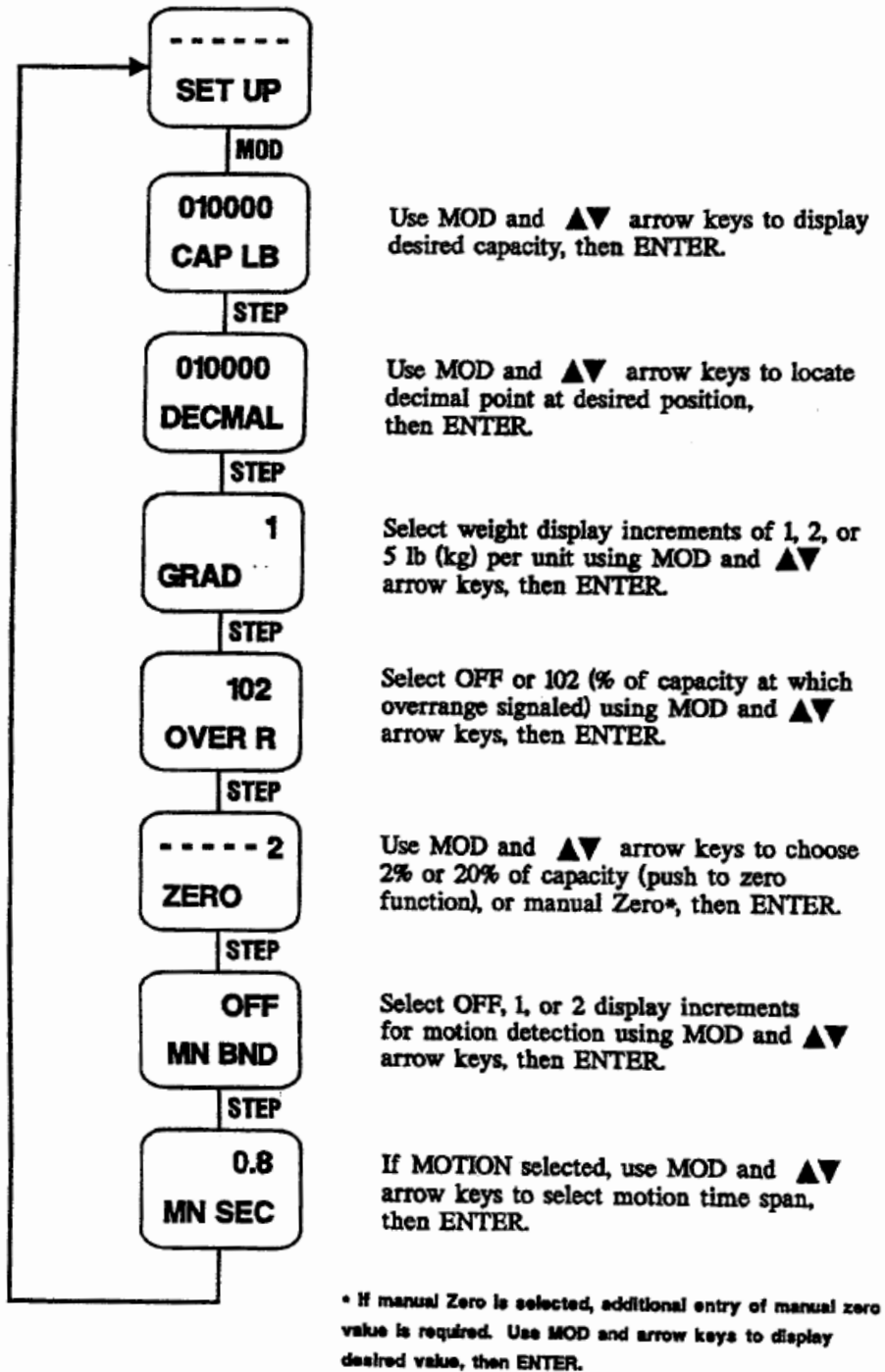

Perform System Calibration

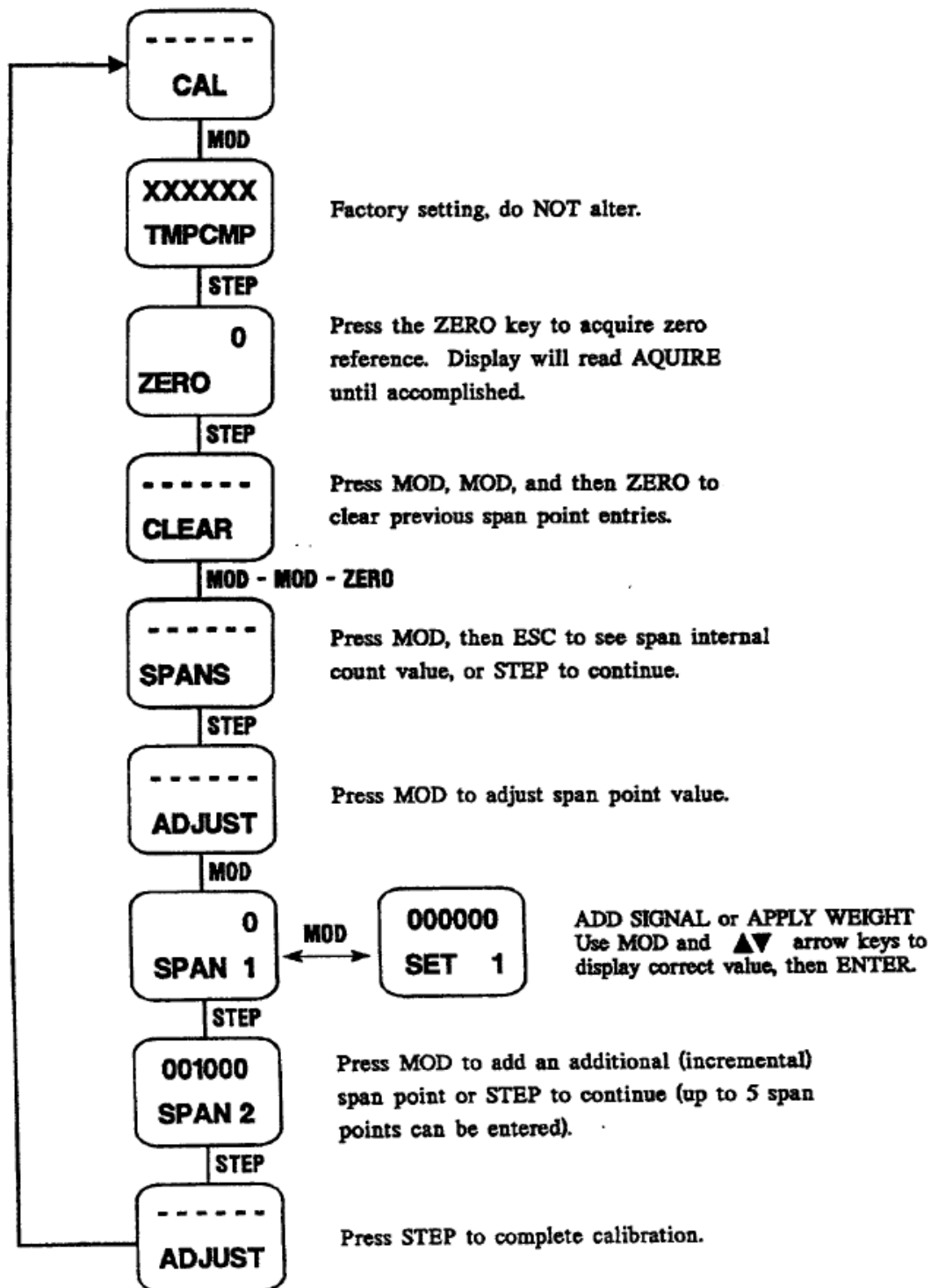

Establish Analog Output (Optional)

Connect a calibrated voltage or current meter to the analog output of the DXp-10/15. The upper display will show actual system gross weight. The lower display will show internal D-A converter counts (0 - 4095).

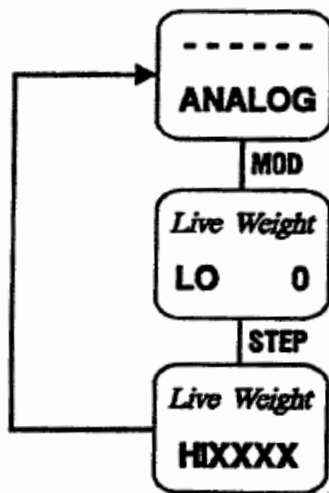

Adjust the system gross weight for low analog output (ie: 0 lb gross = 4 mA). Use the ▲▼ keys to adjust the analog output to the desired value. Press ENTER to store.

Increase/adjust the system gross weight for high analog output (ie: full capacity = 20 mA). Use the ▲▼ keys to adjust the analog output to the desired value. Press ENTER to store.

NOTE: It is not always possible to attain the actual LO and HI weight readings desired for the analog output points. In some cases interpolation between points will be necessary.

Set or Change Filtering

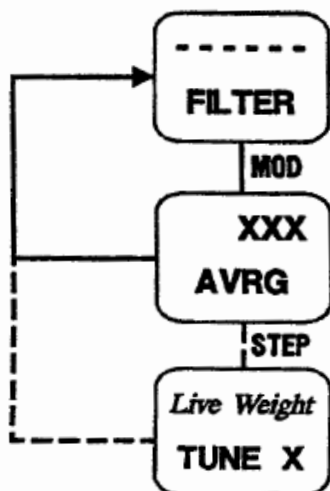

Use the MOD and ▲▼ arrow keys to select averaging of 1, 2, 4, 8, 16, 32, 64, or 128 A/D conversions.

Tune denotes optional digital filter. Use the MOD and ▲▼ arrow keys to select 1 - 8. See paragraph 3.5.2 and Table 3-6 in Section III for explanation.



BLH

3 Edgewater Drive,
Norwood, MA 02062 U.S.A.

Phone (781) 298-2200

Fax (781) 762-3988

www.vishaypg.com