



BLH

DXt-40
Web Tension Transmitter
Operator's Manual

NOTICE

BLH makes no representation or warranties of any kind whatsoever with respect to the contents hereof and specifically disclaims any implied warranties or merchantability or fitness for any particular purpose. BLH shall not be held liable for errors contained herein or for incidental or consequential damages in connection with the furnishing, performance, or use of this publication or its contents.

BLH reserves the right to revise this manual at any time and to make changes in the contents hereof without obligation to notify any person of such revision or changes.

Call (781) 298-2216 for BLH Field Service

Table of Contents

SECTION 1.	General Information	1-1
1.1	INTRODUCTION.....	1-1
1.1.1	General Description	1-1
1.2	OPERATING MODES.....	1-1
1.2.1	Operating Mode A	1-1
1.2.2	Operating Mode B	1-1
1.2.3	Operating Mode C.....	1-1
1.3	STANDARD FEATURES	1-2
1.3.1	On-Line Diagnostics.....	1-2
1.3.2	Digital Filtering.....	1-2
1.3.3	Digital Calibration	1-2
1.4	DXt-40 SPECIFICATIONS.....	1-4
1.5	OPTIONS	1-4
1.5.1	Mounting Options	1-4
1.5.2	Display Window.....	1-4
1.5.3	Terminal Computer Interface	1-4
1.5.4	MODBUS RTU Protocol.....	1-4
1.5.5	Allen-Bradley Remote I/O Network Interface	1-5
1.6	DXt-40 ORDERING INFORMATION	1-5
1.7	WARRANTY POLICY	1-5
1.8	FIELD ENGINEERING.....	1-6
SECTION 2.	Installation	2-1
2.1	INTRODUCTION.....	2-1
2.1.1	General.....	2-1
2.2	MOUNTING.....	2-1
2.3	ELECTRICAL	2-2
2.3.1	Transducer Inputs	2-2
2.3.2	Serial Communication	2-2
2.3.3	Mains (AC) Power (Figure 2-4)	2-3
2.3.4	Auxiliary I/O Ports.....	2-3
2.3.5	Four Analog Outputs/Single Set Point	2-3
2.3.6	Single Analog Output/Four Set Points	2-3
2.3.7	Wiring Considerations	2-3
SECTION 3.	Calibration	3-1

3.1	GENERAL	3-1
3.2	MODE SELECTION	3-2
3.2.1	Load Cells (Modes B, C)	3-2
3.2.2	Calibrate Channel (Modes B, C)	3-2
3.3	SETUP PARAMETERS	3-2
3.3.1	Display Units	3-2
3.3.2	Decimal Point Location	3-2
3.3.3	Capacity	3-3
3.3.4	Count By.....	3-3
3.4	DIGITAL CALIBRATION	3-3
3.4.1	Transducer Calibration Data	3-3
3.4.2	Entering mV/V Calibration Points.....	3-4
3.4.3	Acquire Deadload.....	3-4
SECTION 4.	Operation.....	4-1
4.1	GENERAL	4-1
4.1.1	Operating Mode A	4-1
4.1.2	Operating Mode B	4-1
4.1.3	Operating Mode C	4-1
4.2	OPERATIONAL KEY FUNCTIONS	4-2
4.2.1	Mode A Key Functions	4-2
4.2.2	Mode B Flash Keys	4-2
4.2.3	Mode C Flash Key Functions.....	4-2
4.3	VIEW INDIVIDUAL CELL DATA (modes B & C only).....	4-3
4.4	ERROR DETECTION AND CORRECTION	4-3
4.5	MOTION DETECTION	4-3
SECTION 5.	Digital Filtering.....	5-1
5.1	GENERAL	5-1
5.1.1	Filter Parameters.....	5-1
5.1.2	Mode Considerations	5-1
5.2	MOTION DETECTION (Standard).....	5-1
SECTION 6.	On-Line Transducer Diagnostics.....	6-1
6.1	GENERAL	6-1
6.1.1	Overload.....	6-3
6.1.2	Recall Peak	6-3
SECTION 7.	Serial Communication	7-1

7.1	GENERAL	7-1
7.1.1	Standard Simplex Output (Continuous Output)	7-1
7.1.2	Optional Computer/Terminal interface	7-2
7.1.3	Optional Modbus Protocol	7-4
7.1.4	Optional Allen Bradley Remote I/O	7-8
SECTION 8.	Process Control	8-1
8.1	GENERAL	8-1
8.2	Analog Output Configuration	8-2
8.2.1	Mode A Output Designations	8-2
8.2.2	Mode B Output Designations	8-2
8.2.3	Mode C Output Designations	8-2
8.2.4	Single Analog Output Option	8-2
8.3	Optional Set Point Outputs	8-2
8.3.1	Four Set Point Options	8-2
8.3.2	Single Set Point Option	8-4
SECTION 9.	Introduction	9-1
9.1	RIO OVERVIEW	9-1
9.2	HE DM-40-HTU WEB TENSION TRANSMITTER	9-1
9.3	ALLEN-BRADLEY PLC-5 PROGRAMMABLE CONTROLLER	9-1
SECTION 10.	The Remote I/O Interface	10-1
10.1	OPERATIONAL OVERVIEW	10-1
10.2	HARDWARE CONFIGURATIONS	10-1
10.3	DISCRETE DATA TRANSFER	10-3
10.3.1	Output Image Table	10-3
10.3.2	Input Image Table	10-3
10.4	BLOCK DATA TRANSFERS	10-4
10.4.1	Interface Basics	10-4
10.4.2	Block Transfer Reads (BTRs)	10-4
10.4.3	Block Transfer Writes (BTWs)	10-5
10.4.4	A Perpetual Pointer	10-5
10.4.5	Fault Evaluation	10-5
10.4.6	Remote Filter Configuration	10-5
SECTION 11.	Definitions and Explanations	11-1
11.1	INPUT IMAGE TABLE BITS	11-1
11.2	OUTPUT IMAGE TABLE BITS	11-1

SECTION 1. General Information

1.1 INTRODUCTION

1.1.1 General Description

The DXt-40 Tension Transmitter (Figure 1-1) is a microprocessor based device designed to convert the mV/V signal from up to four individual strain gage type web tension transducers into a digital signal representing tension, or percent of span measurement units. Individually regulated, fault protected 10 VDC excitation is supplied to each transducer. Units operate at either 115 or 230 VAC. Standard transmitters are housed in NEMA 4 enclosures. NEMA 4X or explosion-proof enclosures are available as options. The digital RS-485 serial output port is configured for various baud rate and protocol selections using a series of DIP switches. Entry of calibration data, diagnostic parameters, and filter selections is accomplished using a series of push-button switches. Figure 1-2 presents an overall flow diagram for establishing the calibration and system operating parameters which will be discussed in the following chapters. An internal multi-line LCD display is provided for viewing the setup sequence, diagnostic information, and live operation.

Instrument features include an RS-485 serial port with a simplex output protocol, four ND converter channels with 10 volt excitation per channel, four independent 4-20 mA analog outputs, digital filtering, a fault alarm output, and a NEMA 4 mild steel, painted enclosure. Standard instruments are designed to meet Class I, II, Division 2, Group A-G hazardous location requirements.

1.2 OPERATING MODES

DXt-40 Tension Transmitters offer three operational modes, with each mode measuring up to four tension transducers. Modes A and B provide left, right, total, and differential tension measurement readings. Mode C simply measures four independent transducers and provides outputs accordingly. See Section IV for full definitions and illustrations of each mode.

1.2.1 Operating Mode A

Operating mode A measures two transducers on each side of a single roll. This maximum resolution configuration locates two transducers beneath the work side pillow block bearing and two more beneath the drive side pillow block bearing. Use this mode when installing HTA measurement units. Mode A analog outputs are total tension, total drive, total work, and difference.

1.2.2 Operating Mode B

Mode B measures two independent tension zones. This configuration usually measures two independent rolls, each with a work side and drive side transducer (4 transducers total). Mode B analog outputs are roll.

1 (transducers 1 & 2) total tension, roll 1 difference, roll two total (transducers 3 & 4), and roll two difference.



Figure 1-1. DXt-40 Weight Transmitter

1.2.3 Operating Mode C

Mode C is used in conjunction with four separate and independent 'cantilevered' type tension transducers. Cantilevered transducers are typically not used in pairs. They attach in-line to a pulley or small roll (not over 12 inches). With this configuration, measurements can be taken from four zones on a single machine, a single zone on four machines, etc. For Mode C

configuration, each transducer has a total tension analog output.

1.3 STANDARD FEATURES

1.3.1 On-Line Diagnostics

System diagnostics can be communicated from the serial port to a host computer. This real time information regarding system performance enables the host process computer to alert the operator to potential problems.

1.3.2 Digital Filtering

Dynamic digital filters use a selectable 'running average' to derive optimum filtering settings. Once the noise is characterized, the operator

selects the optimal frequency needed to maintain both display stability and fast response time for better system control. Operating Mode A has a single filter, Mode B has two filters (one for each roll), and Mode C has four filter selections (one for each transducer).

1.3.3 Digital Calibration

Digital calibration uses a factory calibration curve embedded in firmware to establish a reference between weight (force) and mV/V. This allows an operator to set-up and calibrate the system without the need for dead weights or system 'strapping'. For systems with mechanical interactions, this calibration method can be modified to correct system non-linearities.

DXp-40 Main Menu Flow Diagram

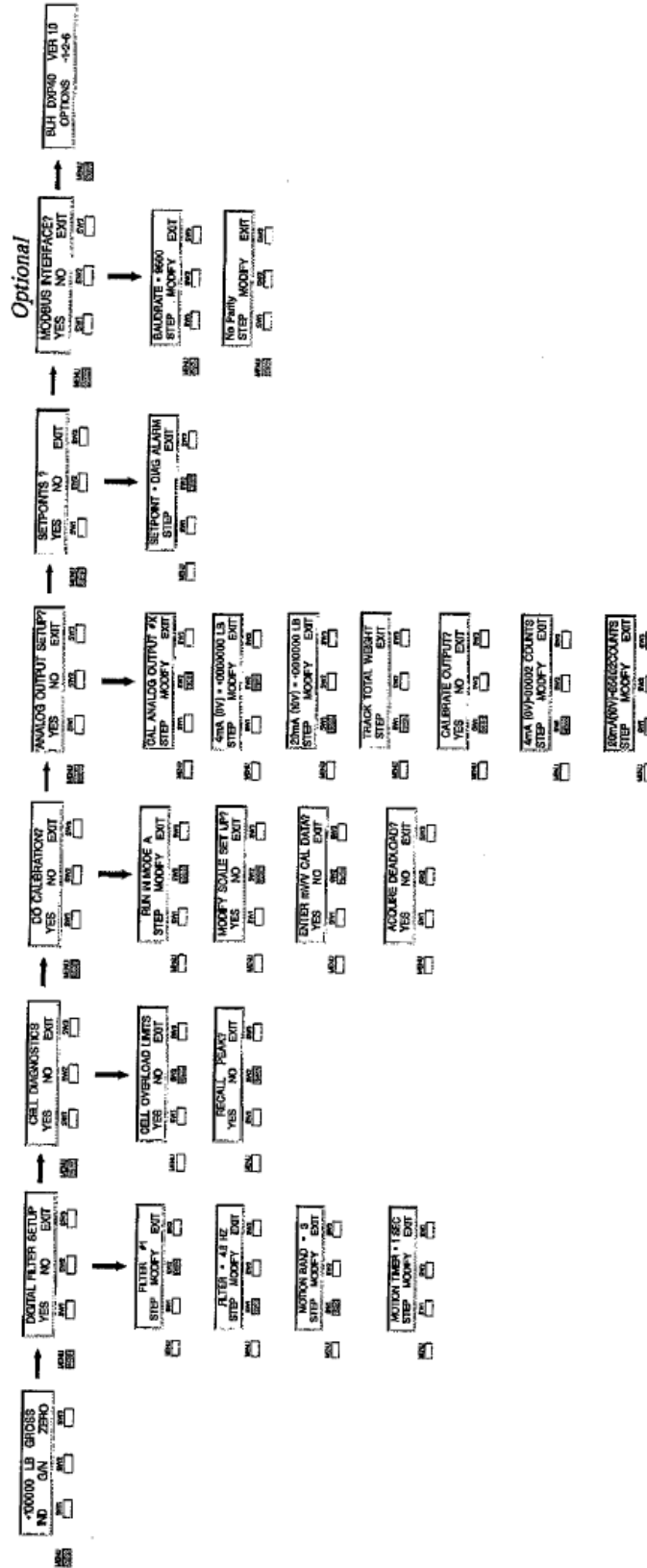

Figure 1-2. DXt-40 Calibration and Configuration.

1.4 DXt-40 SPECIFICATIONS

Performance

Internal Resolution	4,194,304 total counts
Max. Display Resolution	3,000,000 total counts
Max. Resolution Per Channel	750,000 counts
Conversion Speed	50 msec (20 updates/sec)
Sensitivity (Noise)	0.0011% full scale (max 16 counts w/o filter)
Full Scale Range	35 mV/channel
Dead Load Range	100%
Input Impedance	10 M-ohms, min. per channel
Load Cell Excitation	10 V 2 x 350 ohm load cells, 65 mA/channel max
Remote Sense	user configurable on each channel
Linearity	(0.0015% of full scale
Calibration Repeatability	0.3 μ V per count
Software Filter (Std.)	50 to 6400 msec
Dynamic Digital Filter (Opt.)	multi-variable up to 64 seconds

Temperature Coefficient

Span/Zero	(2ppm/ $^{\circ}$ C
Step Response	one conversion
Common Mode Rej.	100 db @ 60 Hz
Normal Mode Rej.	100 db above 35Hz

Environment

Operating Temperature	-10 to 55 $^{\circ}$ C (12 to 131 $^{\circ}$ F)
Storage Temperature	-20 to 85 $^{\circ}$ C (-4 to 185 $^{\circ}$ F)
Humidity	5 to 90% rh, non-condensing
Voltage	117/230 (15% 50/60 Hz
Power	12 watts max
Parameter Storage	EEPROM
EMI/RFI	shielded from typical industrial

Interference

Enclosure

Dimensions	see outline dimensions - Figure 2-1
------------	-------------------------------------

Internal Display/Operator Interface

High-Contrast LCD or	2 columns of 20
Optional Vacuum	characters each
Fluorescent	
Interface	4 'soft buttons'

Isolated Analog Outputs (4)

Type	16 bit digital to analog
Current	4-20 mA (600 ohm max load)

Relay Outputs (setpoints/alarm annunciator)

Closed Contact	28V ac/dc @ 0.4 amps (max.)
Solid State	110/220 Vac @ 1.0 amp

Standard Simplex Data Output (Transmit Only)

Type	RS-485 simplex
Baud	1200 or 9600
Data Format (Selectable)	
ASCII	7 data bits even parity stop bit

Terminal/Computer Interface

Interface Type	RS-485 half duplex
Baud	1200 or 9600
Protocol	duplex command/response format
ASCII	7 data bits even parity stop bit

Special Protocol (optional)

Modbus	RTU protocol - slave
--------	----------------------

Special Interface (optional)

Allen Bradley Remote I/O	represents 1/4 rack of discrete data also supports block transfer
--------------------------	--

Weight

NEMA 4/4X	approx. 12.0 lb
-----------	-----------------

1.5 OPTIONS

1.5.1 Mounting Options

For corrosive, hose down, or sanitary environments, a NEMA 4X stainless steel enclosure is available. An explosion proof enclosure is available for Class I, II, Division 1, Group B-G locations. Note: BLH 406 or 408 Intrinsic Safety Barriers must be specified for weigh systems located in a Division I area.

1.5.2 Display Window

To allow viewing of the internal multi-line display at all times, units may be ordered with a front door panel polycarbonate window. Window units also have a brighter vacuum fluorescent type display panel for even greater visibility. See paragraph 1.3 for display specifications and Figure 2-1 for outline dimensions.

1.5.3 Terminal Computer Interface

The terminal/computer interface option provides a simple mnemonic half-duplex ASCII communications protocol via a built-in macro language consisting of 1 to 3 character command strings (reference Table 7-3).

This powerful feature allows direct keyboard control (using easily remembered commands) of DXt-40 operation and recall of tension values.

Easily learned macro language syntax greatly simplifies the writing of a host computer communication interface (customer supplied).

1.5.4 MODBUS RTU Protocol

MODBUS is often recognized as an industry standard method of digital communication between a master or host computer and a slave device. This protocol was originally developed by Modicon to communicate discrete and analog information between PLCs. As implemented in

the DXt-40, this protocol efficiently communicates tension and diagnostics information to a MODBUS driver equipped host.

1.5.5 Allen-Bradley Remote I/O Network Interface

The Allen-Bradley Remote I/O interface is a communication link that supports remote, time critical I/O control communications between a master processor and a remote I/O slave. It is typically used to transfer 110 bit images between the master and slave.

The DXt-40 represents a quarter (114) Rack of discrete I/O with 32 bits of input and output image files to the scanning PLC. All weight data and status information uses discrete reads and writes to communicate scale information to the PLC in the shortest time possible. Discrete transfers also are used to upload and download non-time critical information such as calibration and lower priority diagnostic data.

1.6 DXt-40 ORDERING INFORMATION

DXt-40 [M] [C] [P] [S]

[M] Mounting

- (1) NEMA 4 painted - standard
- (2) NEMA 4X stainless steel
- (3) NEMA 7 & 9 EX Enclosures for Class I, 11, DIV. 1, 2, Grp. B - G
- (5) #2 with Polycarbonate Window and integral VFD display
- (8) #1 & FM/CSA approval (Class 111111, Div 2, Group ABCD FG)
- (9) #2 & FM/CSA approval (Class 111111, Div 2, Group ABCD FG)
- (11) #9 with Polycarbonate Window and integral VFD display

[C] Communication

- (1) RS 485 Network
- (2) #1 and Terminal/Computer Interface, ASCII protocol
- (4) Allen Bradley Remote I/O (Note: RS-485 Deleted)
- (5) #1 and MODBUS™ RTU (may require RS-485 to RS-232 serial conversion)

[P] Process Outputs

- (1) None
- (2) 0-10V/4-20 mA Analog (includes switchable filter) & 4 Inputs/Outputs With Dry Contact Relays (not available with FM approval)
- (4) Four (4) 4-20 mA Analog Outputs with diagnostic solid state relay (includes switchable filter)

[S]Software

- (6) Standard Web Tension System (except for HTU) Keypad Calibration, Dynamic Digital Filters, On-Line Diagnostics
- (8) Model HTU Web Tension System

Accessories

Conduit Fitting Kit (6 connectors) P/N 465231 Cable Fitting Kit (6 connectors) P/N 465232

1.7 WARRANTY POLICY

BLH warrants the products covered hereby to be free from defects in material and workmanship. BLH's liability under this guarantee shall be limited to repairing or furnishing parts to replace,

f.o.b. point of manufacture, any parts which, within three (3) years from date of shipment of said product(s) from BLH's plant, fail because of defective workmanship or material performed or furnished by BLH. As a condition hereof, such

defects must be brought to BLH's attention for verification when first discovered, and the material or parts alleged to be defective shall be returned to BLH if re-quested. BLH shall not be liable for transportation or installation charges, for expenses of Buyer for repairs or replacements or for any damages from delay or loss of use for other indirect or consequential damages of any kind. BLH may use improved designs of the parts to be replaced. This guarantee shall not apply to any material which shall have been repaired or altered outside of BLH's plant in any way, so as in BLH's judgment, to affect its strength, performance, or reliability, or to any defect due in any part to misuse, negligence, accident or any cause other than normal and reasonable use, nor shall it apply beyond their normal span of life to any materials whose normal span of life is shorter than the applicable period stated herein. In consideration of the forgoing guarantees, all implied warranties are waived by the Buyer, BLH does not guarantee quality of material or parts specified or furnished by Buyer, or by other parties designated by buyer, if not manufactured by BLH. If any modifications or repairs are made to this equipment without prior factory approval, the above warranty can become null and void.

1.8 FIELD ENGINEERING

Improper DXt-40 installation or usage may result in system damage. Please follow instructions carefully. BLH will not accept any liability for faulty installation and/or misuse of this product. Authorized BLH Field Service Engineers are

available around the world to install DXt-40 transmitters and/or train factory personnel to do so. The field service department at BLH is the most important tool to assure the best performance from your application. Field service phone numbers are listed below.

Call (Factory Number)

(781) 298-2200

Ask for Field Service

In Canada, Call

(416) 251-2554

or

(800) 567-6098 Toll Free

Notice:

BLH makes no representation or warranties of any kind whatsoever with respect to the contents hereof and specifically disclaims any implied warranties or merchantability or fitness for any particular purpose. BLH shall not be held liable for errors contained herein or for incidental or consequential damages in connection with the furnishing, performance, or use of this publication or its contents.

BLH reserves the right to revise this manual at any time and to make changes in the contents hereof without obligation to notify any person of such revision or changes.

SECTION 2. Installation

2.1 INTRODUCTION

2.1.1 General

The DXt-40 is designed to be installed within the length of the transducer(s) cable which is normally 35 ft or less. Standard NEMA 4 or optional NEMA 4X enclosures are suitable for outdoor or wash down type environments. Both enclosures are provided with pre-punched holes for installing conduit or cable fittings and holes for mounting to a bracket or wall.

2.2 MOUNTING

The NEMA 4 and NEMA 4X enclosures are equipped with four pre-punched holes for mounting to a wall or bracket. A U-bolt can be used for mounting to a pipe support. The instrument should be installed in a vibration-free location within the normal length of the transducer cables. If conduit is used, drains should be provided to reduce the possibility of condensate entering the enclosure. Outline dimensions for the standard DXt-40 transmitter are presented in Figure 2-1.

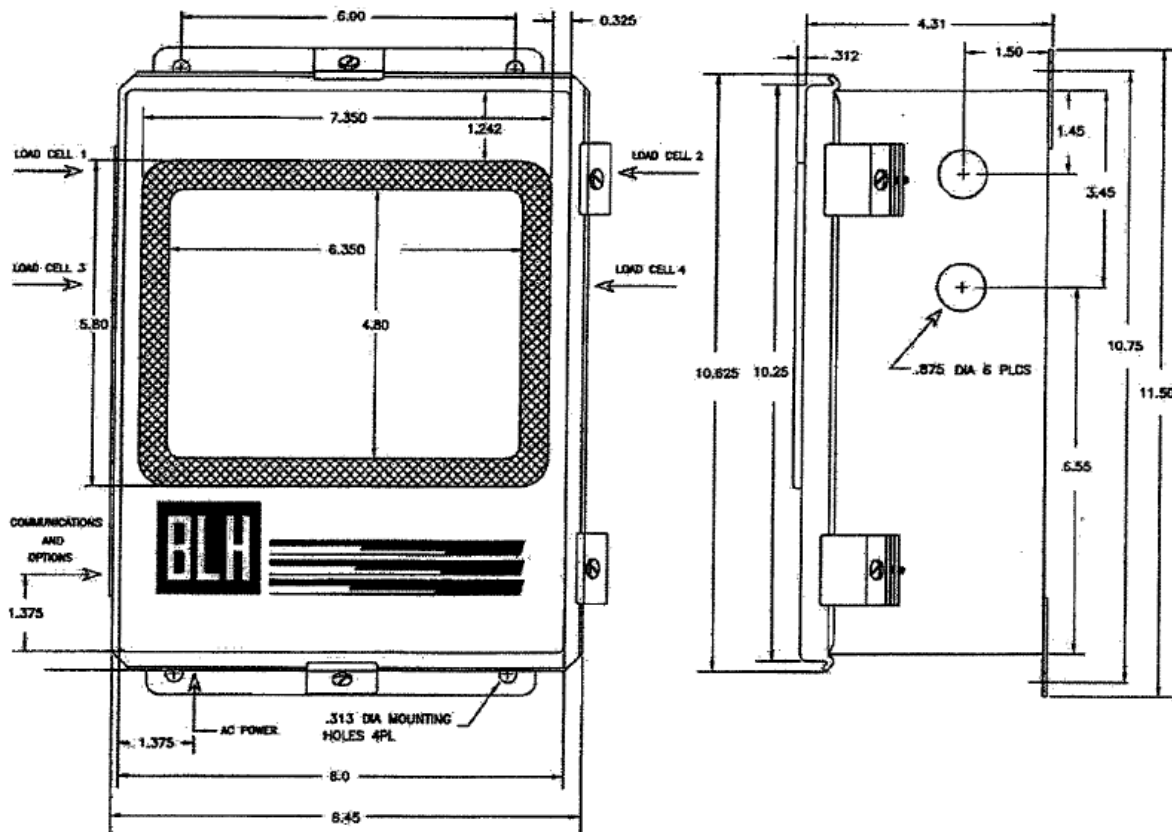

Figure 2-1. DXt-40 Outline Dimensions.

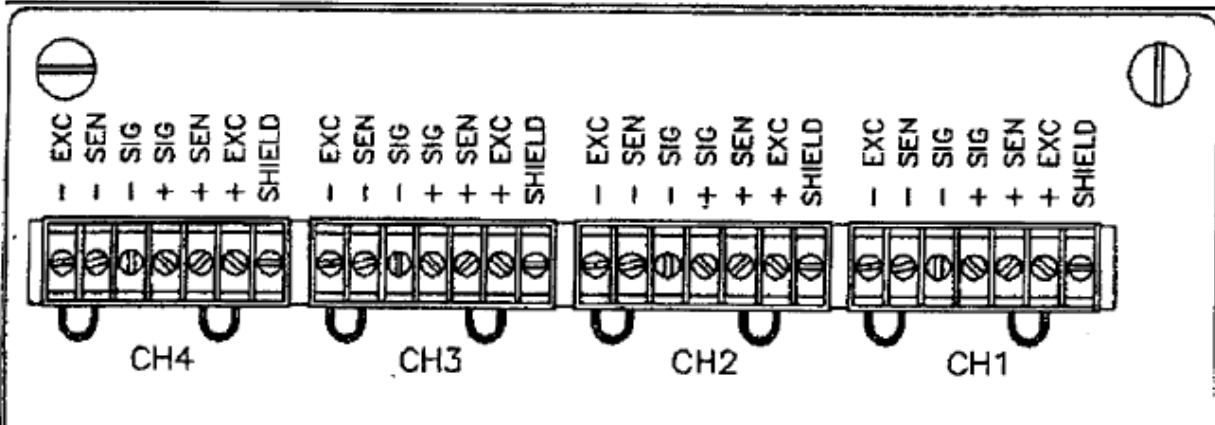

Figure 2-2. Load Cell Connections.

2.3 ELECTRICAL

2.3.1 Transducer Inputs

Up to four tension transducers, one per channel can be connected to the DXt-40. Connect individual transducers directly to the circuit board connectors as shown in Figure 2-2. Excitation and signal connection locations are clearly marked according to function and standard color code. When remote sensing is not used (most cases), connect -SENSE to -EXCITATION and +SENSE to +EXCITATION.

NOTE: All system transducers must be connected during power-up in order to turn on all AID channel inputs.

2.3.2 Serial Communication

A terminal connector is provided for RS-485 wire connections (Figure 2-3). Multiple DXt transmitters, networked together, are wired in a parallel configuration with a termination jumper installed on the last instrument. A pair of twisted wires (20-24 gauge, Belden #9501) is all that is required for interconnection. Communication lines should not be run near AC voltage power lines.

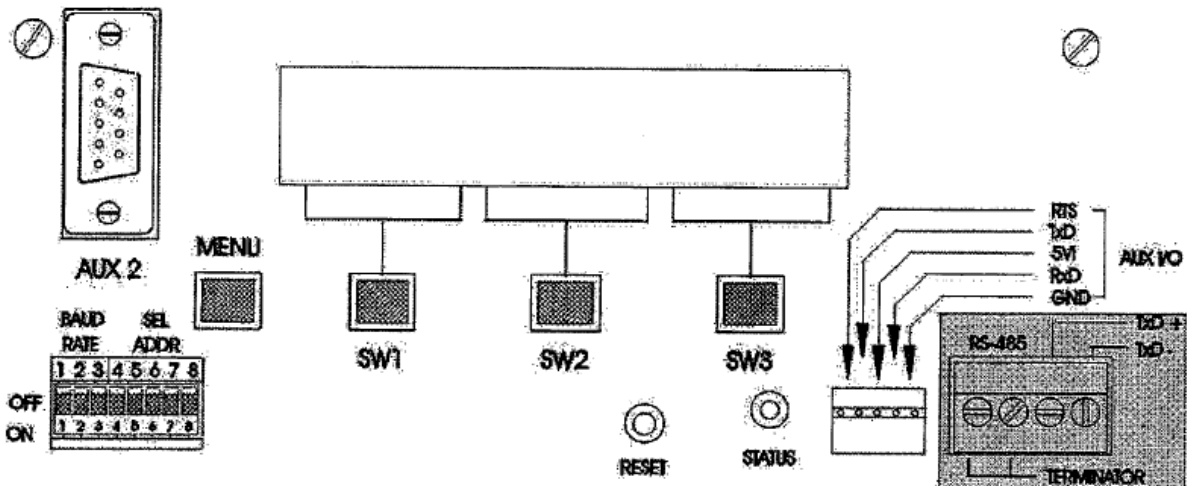

Figure 2-3. Serial Output Connections.

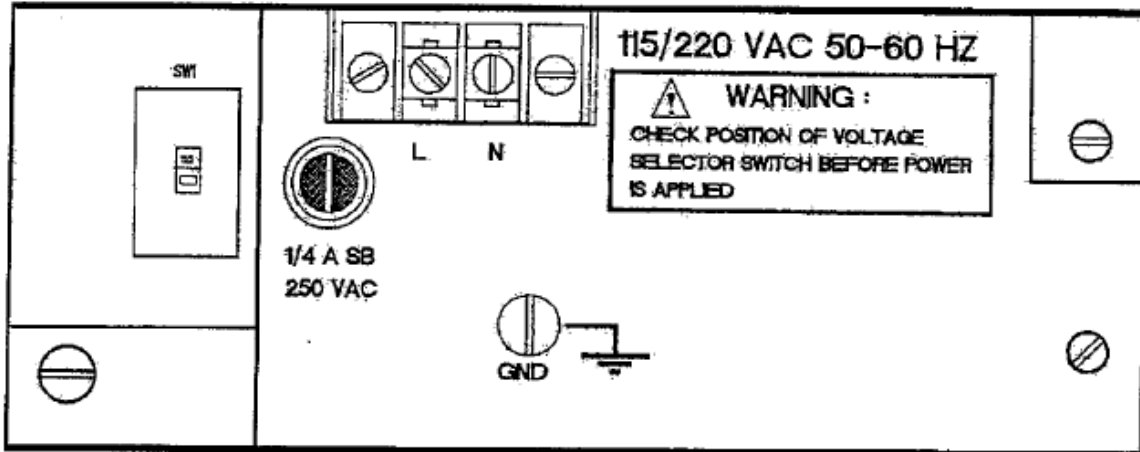

Figure 2-4. AC Power Connections and Fuse.

2.3.3 Mains (AC) Power (Figure 2-4)

A screw terminal is provided for permanent transmitter power connection. All units are shipped from the factory configured for 115 VAC operation. To select 230 VAC operation, change SW1 on the base or 'mother' board (see Figure 2-4) to the 230V setting. The unit will operate within specification at 50 or 60 Hz. Before connecting power to the unit, verify that the proper power selection has been made. The two position terminal block is equipped with a clear plastic cover to prevent operator injury. Cable can be either solid or stranded 12 or 14 gage with a ground conductor.

The transmitter is protected with a 1/4 amp slow blow fuse, located adjacent to the mains terminal block. If the fuse opens, replace it with the same type and current rating.

2.3.4 Auxiliary I/O Ports

The auxiliary I/O port connections are factory test ports and are not useful to an operator.

2.3.5 Four Analog Outputs/Single Set Point

With option [P4] installed (page 1-5), four, two position terminal connectors are provided for the 4-20 mA outputs (Figure 2-5). The single set point relay is connected at the RLY terminal and configured for normally open operation. See Section VIII for complete details concerning these outputs.

2.3.6 Single Analog Output/Four Set Points

With options [P2] installed (page 1-5), one analog output and four set points are available. Note that the analog output can be wired for 0-10V or 4-20 mA operation. Wiring arrangements are presented in Figure 2-5. All set point relay outputs are configured for normally open operation. See Section VIII for complete details concerning these outputs.

2.3.7 Wiring Considerations

All external wiring should be routed away from AC power lines even though current outputs are essentially immune to noise and can be transmitted long distances. Always use twisted pair, shielded cable.

Option [P2] Connections*

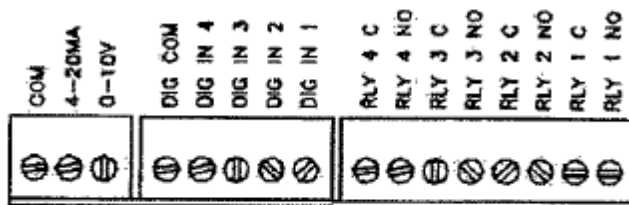

Option [P4] Connections*

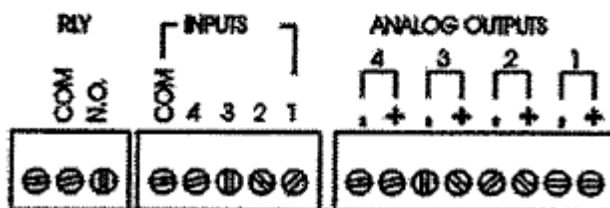

Figure 2-5. Optional I/O Connections.

SECTION 3. Calibration

3.1 GENERAL

Calibration is the fourth step in parameter entry menu (Figure 3-1). Although calibration parameter entries are basically the same from mode to mode, there are subtle differences. Calibration repetition also is a factor in mode B and C. Calibration is performed only once for the entire system in mode A, for each two-

transducer channel in mode B, or for each individual transducer in mode C. Check diagrams in this section closely for the mode selected. Calibration is accomplished easily using the internal display and its four switches.

Calibration flow for all modes is shown in Figure 3-2.

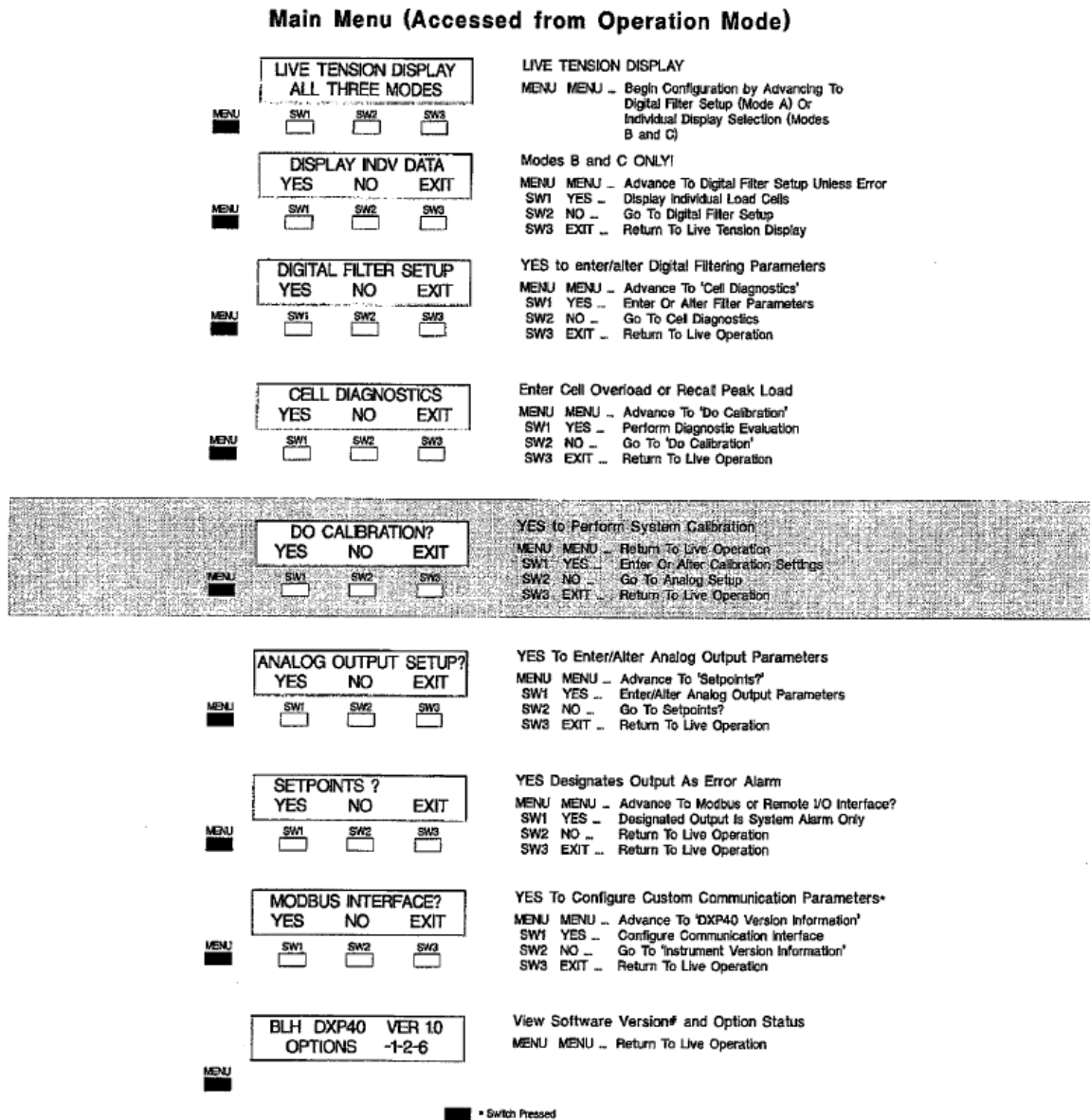

Figure 3-1. DXt-40 Main Menu Showing Calibration Display.

3.2 MODE SELECTION

The first selection under calibration determines the mode of total system operation, i e., A, B, or C.

NOTE: Mode selection affects total system operation and subsequent parameter entries. Reference Section IV for a complete description of each operating mode.

3.2.1 Load Cells (Modes B, C)

For modes B and C, the instrument must know how many transducers are being used (Mode A is automatically 4). In mode B, channels 1, 2, and 3, 4 each represent one load cell. Channels 3 and 4 may be omitted if only one zone is used. In mode C, cells used (1-4) are selected individually.

3.2.2 Calibrate Channel (Modes B, C)

Mode A HTA systems always default to single pass calibration and require no selection. In mode B, calibration must be performed for each channel combination (channel 1 & 2 and channels 3 & 4 if

used). Calibration is required for each cell used in mode C.

3.3 SETUP PARAMETERS

Setup establishes operating parameters such as system capacity, decimal point location, display units (pounds, kilograms, tons, ph), and count by multipliers. To enter or alter operating parameters, select YES for 'MODIFY SETUP?' in Figure 3-2 and proceed to Figure 3-3.

NOTE: Parameters must be selected for each channel in mode B and each individual transducer in mode C.

3.3.1 Display Units

Designate the desired display unit type by entering LB (pounds), KG (kilograms), TN (tons), or PLI (pounds/linear inch).

3.3.2 Decimal Point Location

Position the decimal point as desired for tension display and serial printouts.

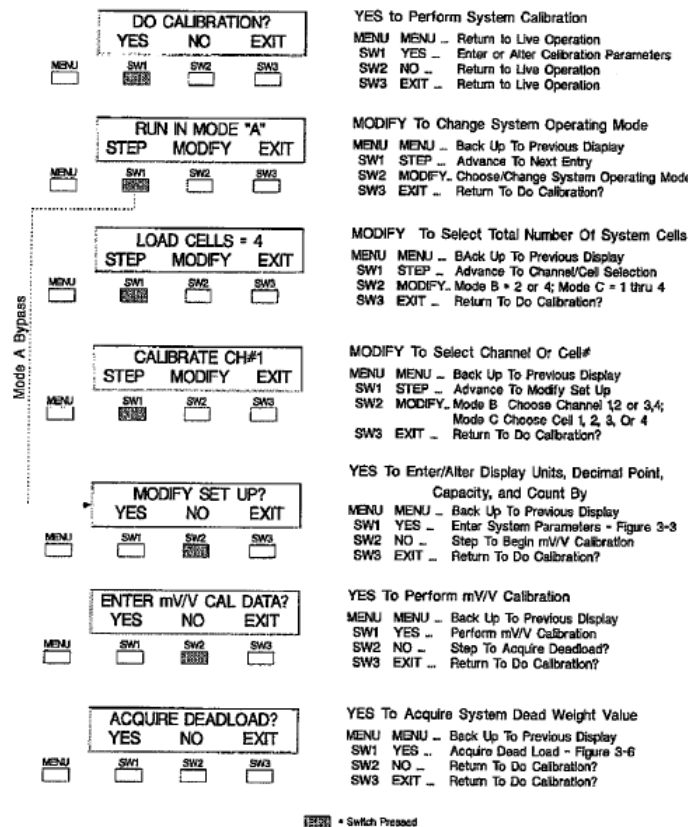

Figure 3-2. DXt-40 Calibration Menu.

Modify Scale Set Up

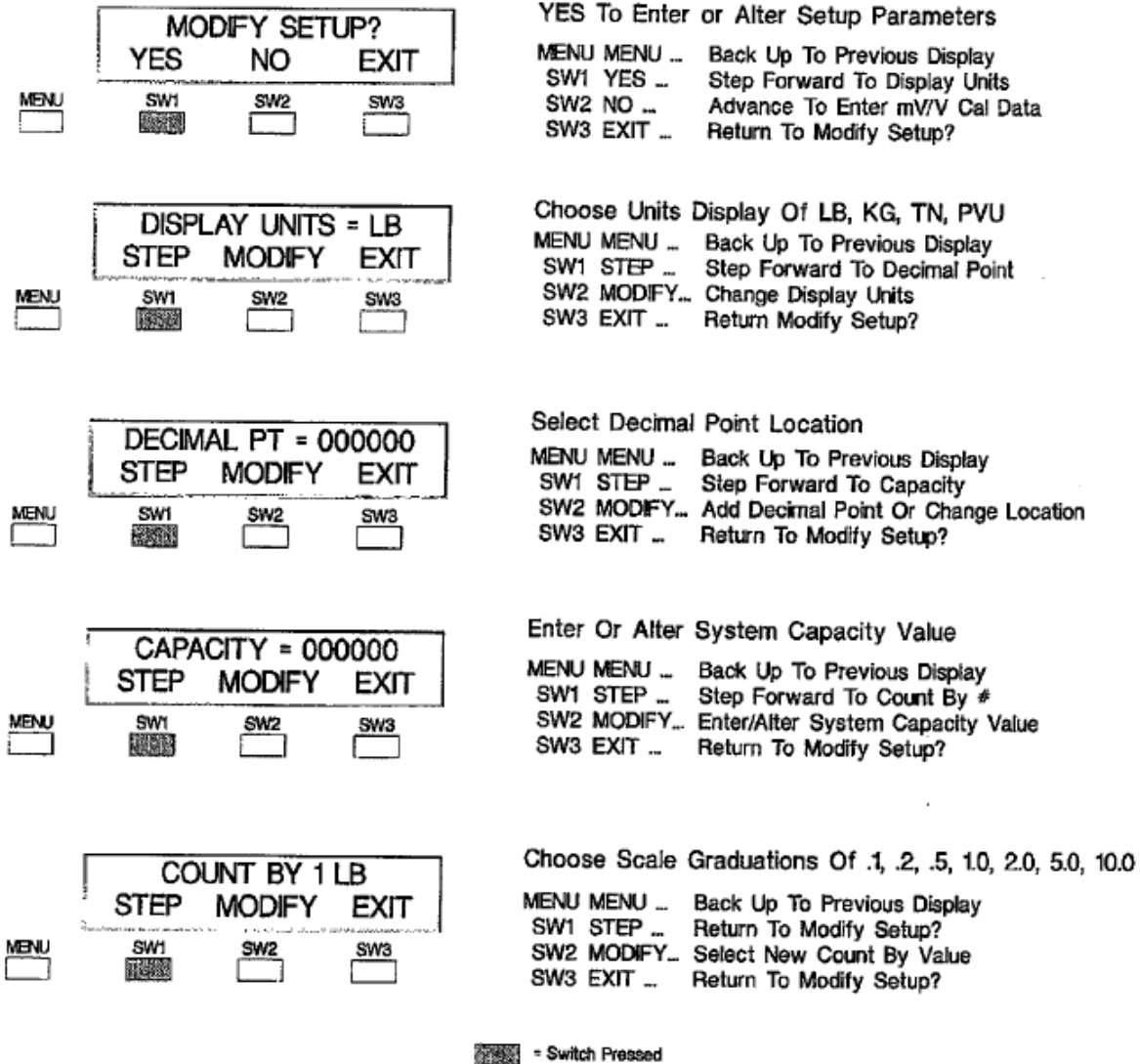

Figure 3-3. System Parameter Entry Flow Diagram.

3.3.3 Capacity

Enter the system total capacity value. A capacity of 10,000 will be 10.000, 100.00, 1000.0, or 10,000 relative to decimal point selection.

3.3.4 Count By

Define the count value of each display increment by selecting 1, 2, 5, or 10 (note that decimals apply).

3.4 DIGITAL CALIBRATION

3.4.1 Transducer Calibration Data

Individual channels and embedded mV/V calibration curves make it possible to calibrate a DXt-40 by simply entering mV/V equivalent force or weight values from a load cell calibration sheet (Figure 3-4). A cal sheet presents the load cell mV/V output reading for either 3 or 10 known load values. The highest value recorded should match the rated capacity of the load cell.

Note that there is also a 0 or no load mV/V output recorded. Each cell must have its own cal sheet (match serial number on sheet to serial number on cell) in order to perform mV/V calibration.

3.4.2 Entering mV/V Calibration Points

Following Figure 3-5 instructions, select a load cell and enter the zero balance (no load) mV/V value. After zero balance is established, enter the load point mV/V and load point pound value for the highest value on the calibration certificate. Repeat this procedure for each load cell before advancing to 'Acquire Deadload?' (next paragraph). Note that load cells are numbered according to their channel connection position (Figure 2-2).

All modes require calibration entries for each transducer. If operating in mode B, mV/V calibration must be repeated for the second zone, channels 3 & 4, when used.

3.4.3 Acquire Deadload

After all mV/V load points are entered, a scale zero reference must be acquired. Deadload zero determines the weight or signal output at which the system is in no load condition (typically roll and bearing weight factors). Addition of any tension induced weight will be referenced from this point to produce accurate live readings. Following Figure 3-6 instructions, acquire the deadload value by either entering a known weight value for all system components (manual) or letting the DXt-40 read and store the no load signal (live). When cal sheet span points are entered and deadload acquired, calibration is complete.

NOTE: When operating in mode B, deadload acquisition must be repeated for the second zone, channels 3 & 4, if used. In mode C, deadload must be acquired for each individual transducer.



Calibration Chart

Customer: ABC Co. P.O.: 28523004D
 Capacity: 50000 lb Type: G2P1 Serial No.: 71258
 Mode: Tension Bridge: A Test Report No.: C37-8506
 Indicator: N.A. Serial No.: N.A.
 Date Of Calibration: 4/15/98 Temperature: 70 F
 Calibrated By: M. Houston Humidity: 58 %

Applied Load [lb]	Response Run 1 mv/V	Response Run 2 mv/V	Response Run 3 mv/V
0	0.0000	0.0000	0.0000
5,000	0.2000	0.2000	0.2000
10,000	0.4001	0.4001	0.4001
15,000	0.6001	0.6001	0.6001
20,000	0.8002	0.8002	0.8002
25,000	1.0003	1.0003	1.0003
30,000	1.2003	1.2003	1.2003
35,000	1.4003	1.4003	1.4003
40,000	1.6003	1.6003	1.6003
45,000	1.8003	1.8003	1.8003
50,000	2.0003	2.0003	2.0003
25,000	1.0000	1.0000	1.0000
0	0.0000	0.0000	0.0000

Applied Load [lb]	Output Average lb	Ideal Output lb	Output Error lb	Output Error % FS	Hysteresis Error % FS
0	0.0000	0.0000	0.0000	.000%	
5,000	0.2000	0.2000	0.0000	-.001%	
10,000	0.4001	0.4001	0.0000	.002%	
15,000	0.6001	0.6001	0.0000	.000%	
20,000	0.8002	0.8001	0.0001	.004%	
25,000	1.0003	1.0002	0.0001	.007%	
30,000	1.2003	1.2002	0.0001	.006%	
35,000	1.4003	1.4002	0.0001	.004%	
40,000	1.6003	1.6002	0.0001	.003%	
45,000	1.8003	1.8003	0.0000	.001%	
50,000	2.0003	2.0003	0.0000	.000%	
25,000	1.0000	1.0002	-0.0002	-.007%	-.015%
0	0.0000	0.0000	0.0000	.000%	.000%

John Bailey
 Q. C. Manager 4/15/98

Figure 3-4. Typical Load Cell Calibration Sheet.

Digital Calibration

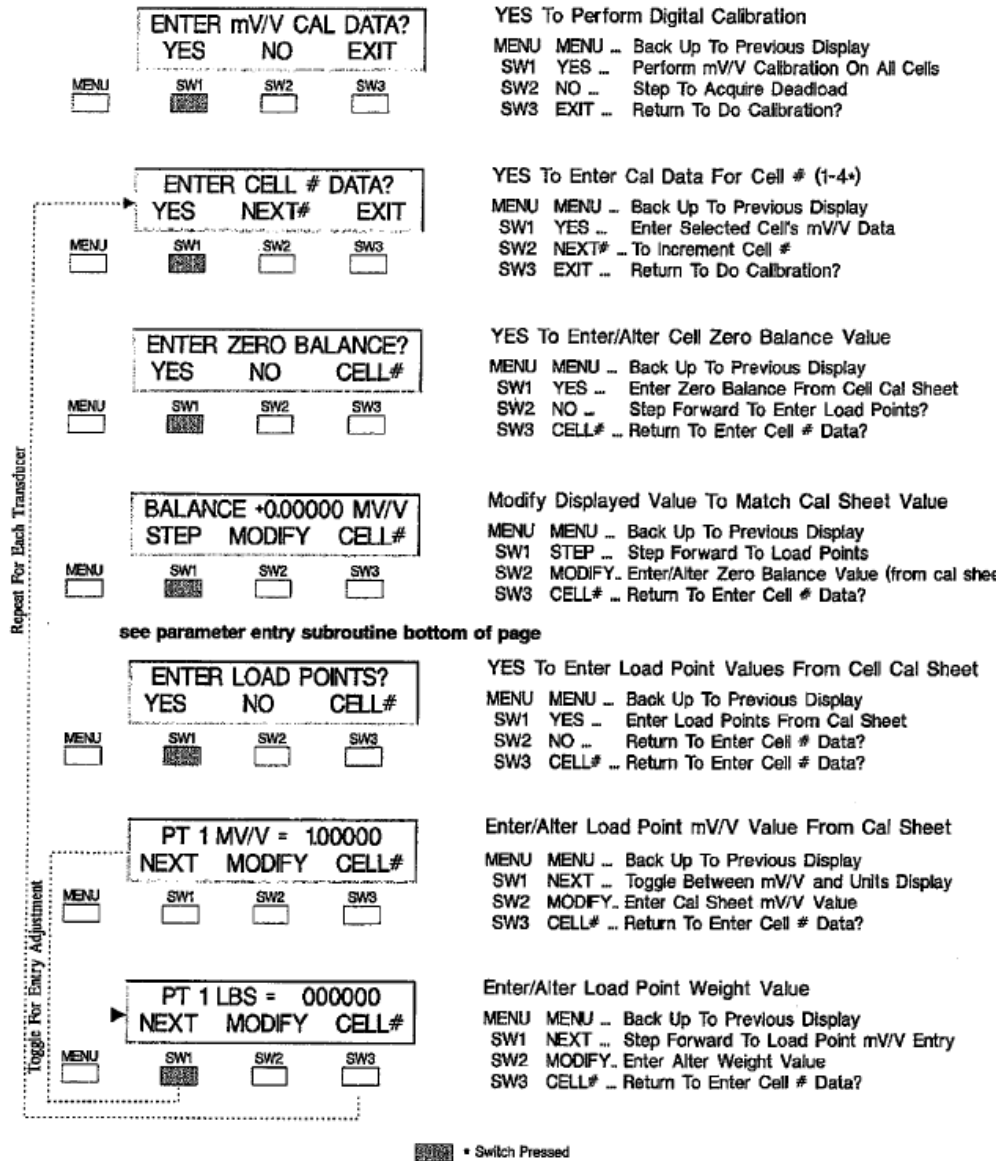

*In mode B, digital calibration must be performed twice if using all 4 channels. Once for transducers 1 & 2, and then again for transducers 3 & 4.

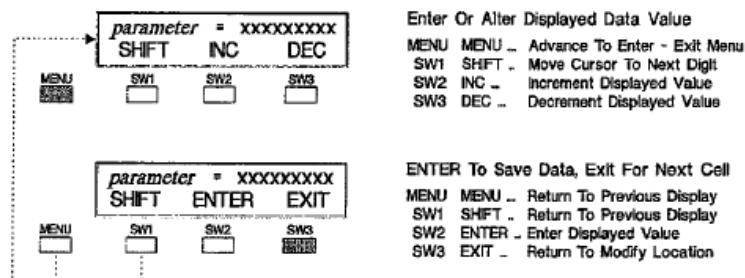
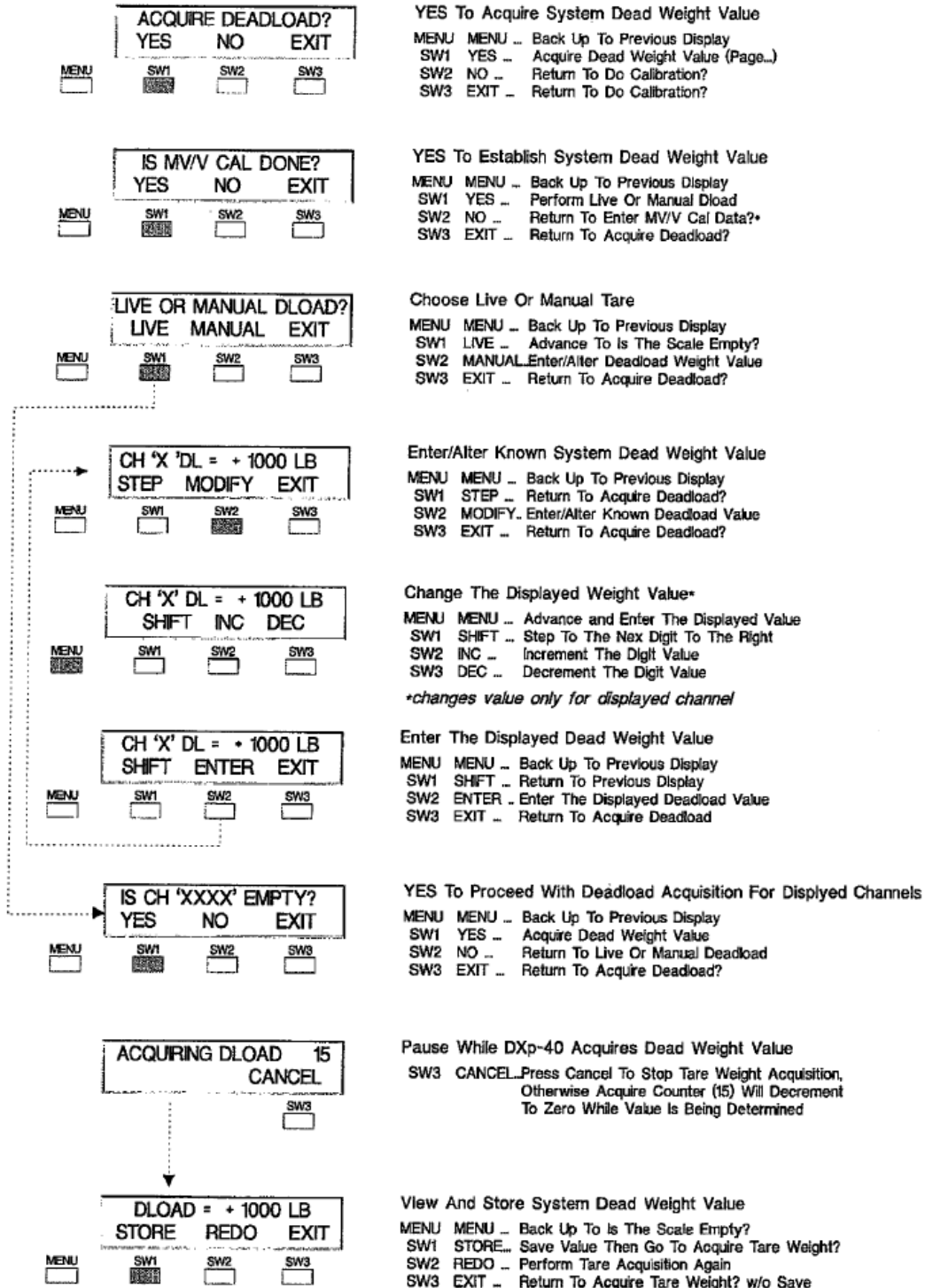

Figure 3-5. Millivolt per Volt Calibration Guide.

Acquire Deadload (Establish Zero Weight Reference)



= Switch Pressed

Figure 3-6. Acquire Deadload (Used with m/V/V Cal Only).

SECTION 4. Operation

4.1 GENERAL

DM-40 Tension Transmitter operation depends upon mode selection. Each of the three operating modes performs a different function. Mode selection is determined during calibration, as noted in Section III. Units default to mode A upon initial power-up.

4.1.1 Operating Mode A

Operating mode A measures two transducers on each side of a single roll. This maximum resolution configuration locates two transducers beneath the work side pillow block bearing and two more beneath the drive side pillow block bearing (Figure 4-1). Use this mode when installing HTA measurement units. Mode A analog outputs are total tension, total drive, total work, and difference. Although four transducers are employed, the DXt-40 regards this configuration as one system. Calibration is performed only once.

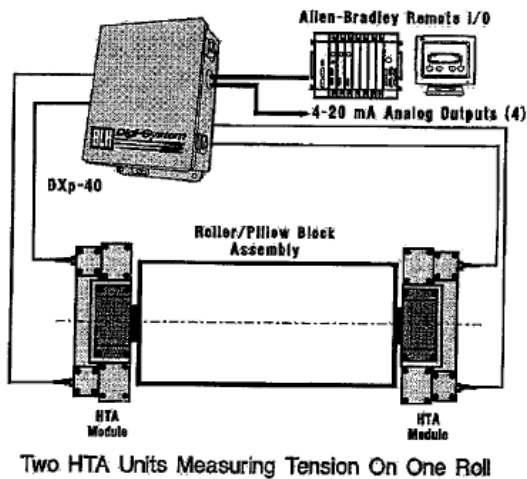

Figure 4-1. Mode A Transducer Allocation

4.1.2 Operating Mode B

Mode B typically measures two independent tension zones (rolls). These zones may be two independent points on the same web (Figure 4-2) or any point on two different webs. This configuration usually measures two independent rolls, each with a work side and drive side transducer (4 transducers total). Mode B analog

outputs are roll 1 (transducers 1 & 2) total tension, roll 1 difference, roll two total (transducers 3 & 4), and roll two difference. Mode B also functions with only one, two-transducer tension zone. It is not necessary to use both zones.

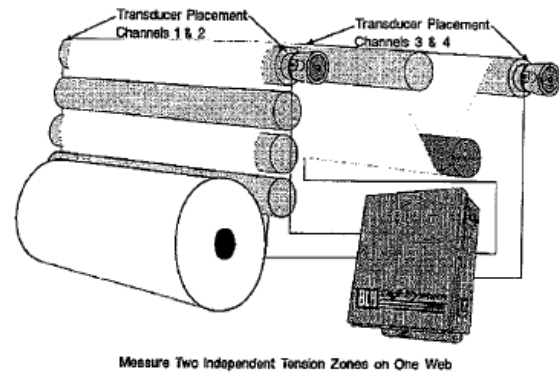

Figure 4-2. Mode B Measuring Two Zones on One Web

4.1.3 Operating Mode C

Mode C usually is used in conjunction with four separate and independent 'cantilevered' type tension transducers (Figure 4-3). Cantilevered transducers are typically not used in pairs. They attach in-line to a pulley or small roll (not over 12 inches). With this configuration, measurements can be taken from four zones on a single machine, a single zone on four machines, etc. For Mode C configuration, each transducer has a total tension analog output.

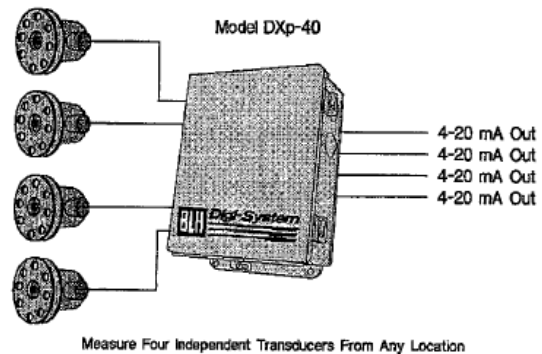

Figure 4-3. Mode C Configuration with 4 Transducers

4.2 OPERATIONAL KEY FUNCTIONS

During operation, the internal pushbutton switches SW1, SW2, and SW3 function differently in each mode. The MENU pushbutton will always switch the unit from live operation to the main configuration menu.

4.2.1 Mode A Key Functions

Mode A operating key functions are defined in Figure 4-4. The default display is total system tension. Switches 1-3 allow viewing of separate work and drive side, individual transducer, or differential (drive minus work) values. Press the EXIT key to revert to total tension display.

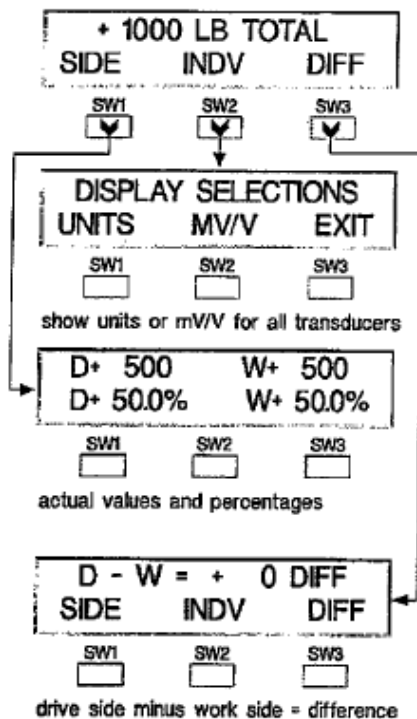

Figure 4-4. Key Functions - Mode A.

4.2.2 Mode B Flash Keys

In mode B, Switches 1-3 function by flashing requested displays i.e., data is displayed for several seconds before the display reverts to default. The default display shows channel 1&2 (zone 1) and channel 3&4 (zone 2) total tension values (see Figure 4-5).

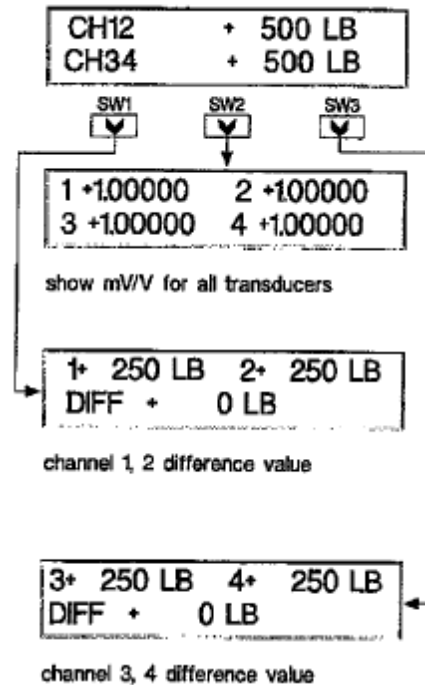

Figure 4-5. Mode B Momentary Flash Key Functions.

4.2.3 Mode C Flash Key Functions

Switches 1-3 all perform the same function in Mode C. Pressing any switch results in a momentary display of each transducer's engineering unit designation (LB, KG, etc.) and then a momentary display of each transducer's mV/V value (Figure 4-6). The default display is total tension for each transducer.

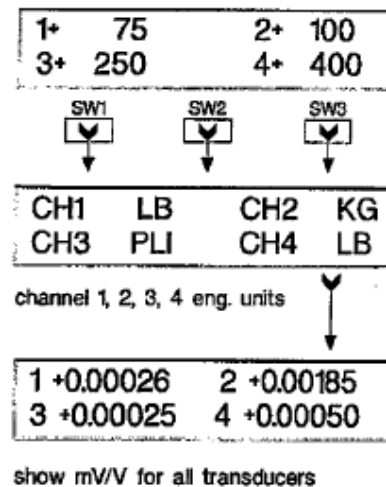

Figure 4-6. Mode C Flash Displays

4.3 VIEW INDIVIDUAL CELL DATA (modes B & C only)

Pressing the MENU switch in modes B and C allows the operator to view individual transducer parameters in engineering units or millivolt. Mode B also allows viewing of zone (side) difference factors. Figure 4-7 provides details for mode B. See Figure 4-8 (next page) for mode C functions.

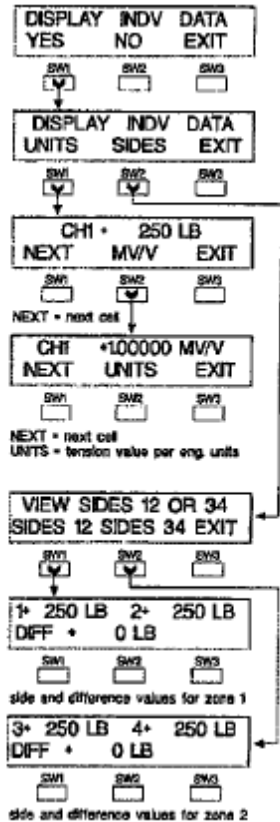

Figure 4-7. Mode B Individual Cell/Zone Values.

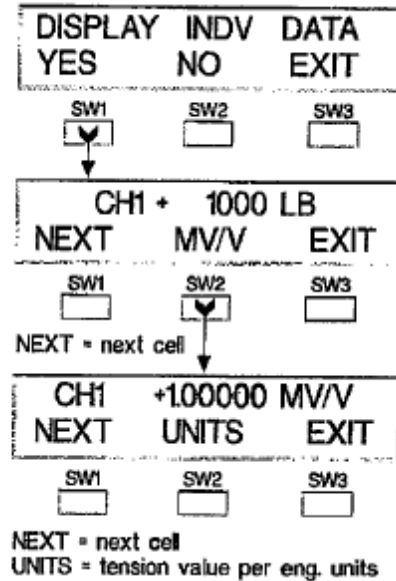

Figure 4-8. Mode C Individual Cell Parameter Viewing.

4.4 ERROR DETECTION AND CORRECTION

Should an error condition occur during system operation, a flashing capital 'E' will appear next to the weight/status information on the display. In modes B and C, the 'E' will appear next to the channel at fault. To evaluate and correct system errors, press the MENU key and view existing error(s) (see Figure 4-9, mode A example).

4.5 MOTION DETECTION

During operation in any mode, the DXt-40 will AC-knowledge any system, zone, or transducer that is in motion. In mode A, the word MOTION is displayed: in modes B and C, a capital M appears next to the zone/cell that is in motion. Motion values are entered/alterd in Section 5, Digital Filters.

SECTION 5. Digital Filtering

5.1 GENERAL

Digital filtering (including motion) constitutes the first set of parameter entries in the main menu (Figure 5-1, shaded). Filtering removes unwanted, mechanically induced fluctuations from the tension signal while maintaining rapid response to genuine operational changes. Choose the lowest frequency selection that eliminates vibration induced noise from the active display.

5.1.1 Filter Parameters

Filtering offers selections of OFF, 0.4 Hz, 0.6Hz, 0.8Hz, 1.0 Hz, 1.3Hz, 1.7Hz, 2.5Hz, and 4.8Hz (see Figure 5-2). After making a selection view live display to evaluate result. Select the lowest frequency (or off) that provides display stability.

NOTE: Filter selections will affect analog outputs. The higher the frequency selection, the slower the response.

5.1.2 Mode Considerations

Filtering parameter entries are affected by mode selection. In mode A, enter parameters once for the entire HTA system. Mode B allows entries for both zones and with Mode C, parameters must be entered for each transducer.

5.2 MOTION DETECTION (Standard)

Motion detection parameters_ are entered along with filtering parameters (Figure 5-2). Motion simply determines when the system is active and when it is not. Motion can be configured for band width of 1, 2, 3, 5, 10, 20, or 50 counts, or turned OFF. Once a band is selected, a time length (window) also must be established for the band. Motion must occur for the designated time interval before the system acknowledges an in motion' condition.

The motion timer is the time the system remains in an "in motion" condition before returning to a "not in motion" condition. This time provides a stabilizing period for display and documentation purposes. Selections are 0.5, 1, 2, and 3 seconds.

Main Menu (Accessed from Operation Mode)

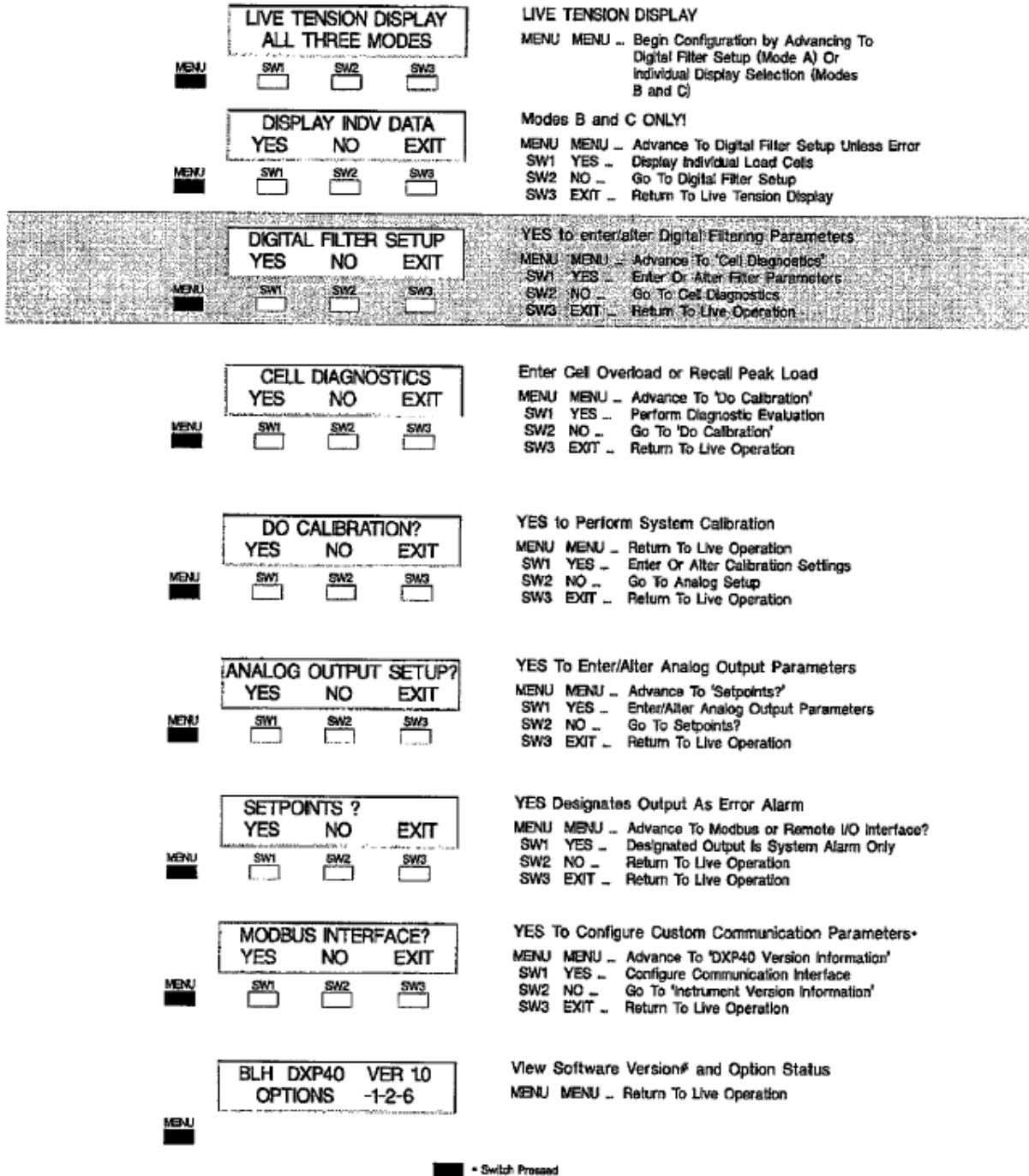
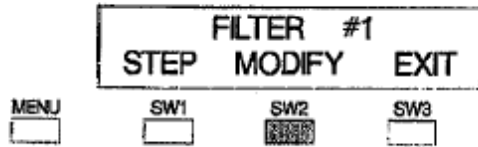

Figure 5-1. Main Menu Digital Filter Selection.

Digital Filtering Setup



View Or Modify Filters

MENU MENU ... Return To Digital Filter Setup
 SW1 STEP ... Return To Digital Filter Setup Mode A
 Select Next Zone Mode B
 Select Next Transducer Mode C
 SW2 MODIFY.. Modify Selected Filter Parameters
 SW3 EXIT ... Return To Digital Filter Setup

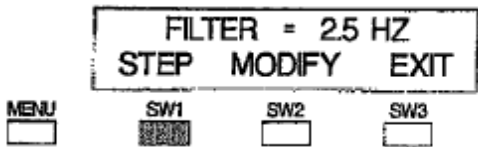

View/Modify Filter Frequency Selection (Hz)

Choose: OFF, .4, .6, .8, 1.0, 1.3, 1.7, 2.5, 4.8

MENU MENU ... Back Up To Previous Display
 SW1 STEP ... Advance To Motion Band
 SW2 MODIFY.. Jump To Parameter Change Subroutine
 SW3 EXIT ... Return To Filter # Selection

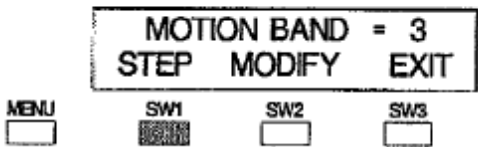

View/Modify Motion Detection Band Selection

Choose: OFF, 1, 2, 3, 5, 10, 20, Or 50 Display Counts

MENU MENU ... Back Up To Previous Display
 SW1 STEP ... Advance To Motion Timer
 SW2 MODIFY.. Jump To Parameter Change Subroutine
 SW3 EXIT ... Return To Filter # Selection

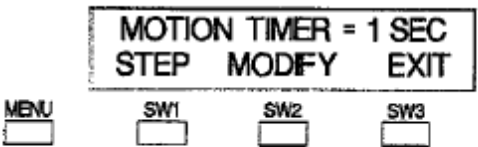

View/Modify Motion Time Selection (sec)

Choose: Time 'Window' Of .5, 1, 2, 3 Seconds

MENU MENU ... Back Up To Previous Display
 SW1 STEP ... Return To Digital Filter Setup?
 SW2 MODIFY.. Jump To Parameter Change Subroutine
 SW3 EXIT ... Return To Filter # Selection

 = Switch Pressed

Parameter Change Subroutine

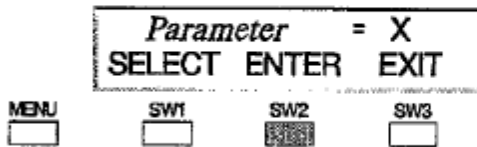

Enter Selected Parameter Value

MENU MENU ... Back Up To Previous Display
 SW1 SELECT.. Change Parameter Selection
 SW2 ENTER .. Enter/Store New Parameter Value
 SW3 EXIT ... Return To Filter # Selection

 = Switch Pressed

Figure 5-2. Digital Filter and Motion Setup.

SECTION 6. On-Line Transducer Diagnostics

6.1 GENERAL

The next step in the DXt-40 main menu is diagnostic error analysis and parameter entry (Figure 6-1). The unique quad AID converter design makes it possible to diagnose system errors down to the exact load cell. Each cell is continually checked for overload conditions.

Diagnostic evaluations also include peak force viewing for each cell. Peak indicates the maximum force experienced by each individual cell.

Together, cell overload and peak force functions protect and ensure the longevity of each system transducer. Figure 6-2 provides an overall flow diagram for entering overload values and viewing peak force figures.

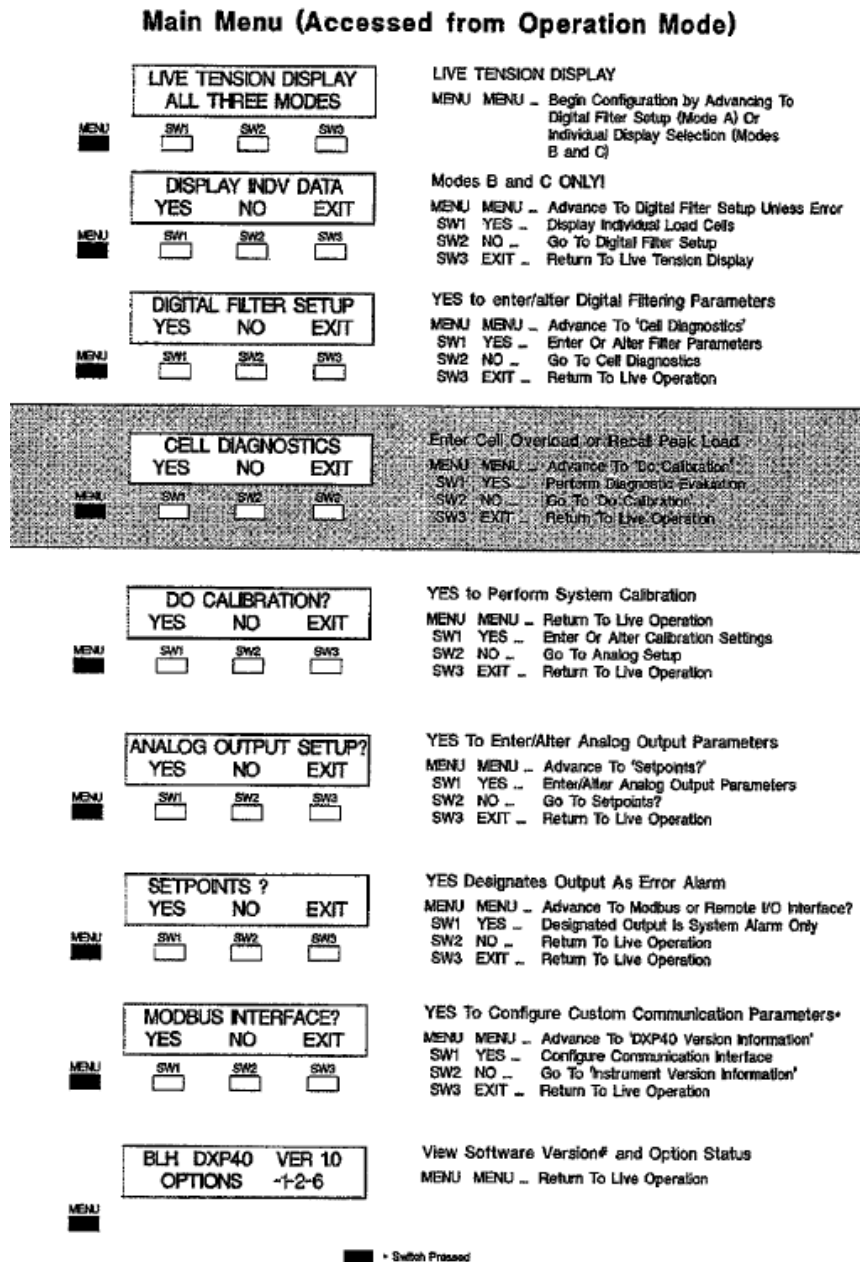
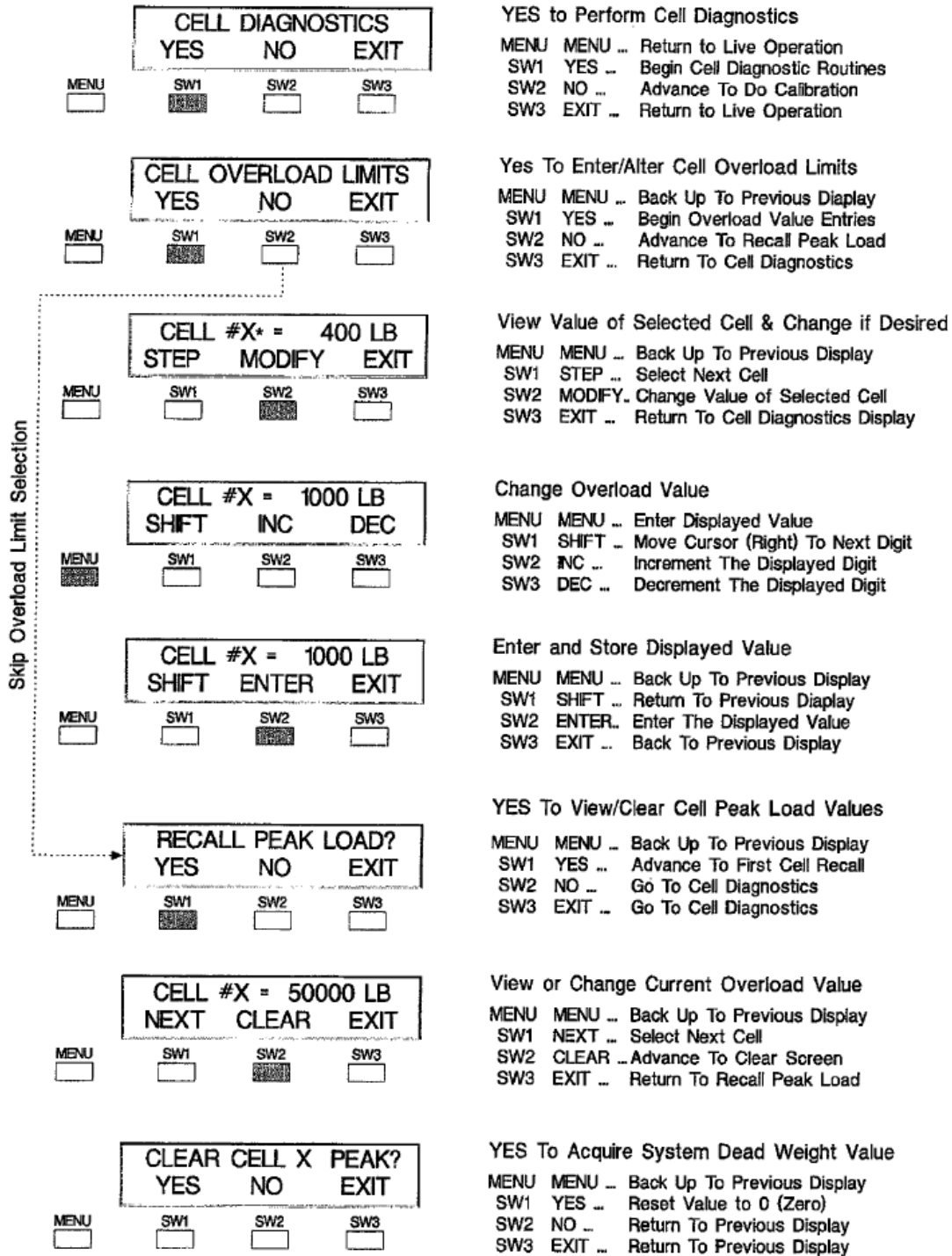

Figure 6-1. Diagnostic Error Evaluation Main Menu.

Diagnostic Flow Main Menu



* Switch Pressed

*Selection Available for Four Cells in Each Mode

Figure 6-2. DXt-40 Diagnostic Routines.

6.1.1 Overload

Since overload is critical to system safety and load cell integrity, it is checked every 50 msec. Cell overload limits are typically set at the cell's rated capacity. A running peak value for each cell is recorded and may be checked (or cleared) at any time. In most web tension systems, overload typically signaled a total system overload (system capacity exceeded).

The DXt-40, however, can alert an operator to a single cell overload, even though total tension/force does not exceed system capacity. Single cell overloads can be caused by web drift, shock loads, and poor system design. Figure 6-2 provides a flow diagram for cell overload value entry.

6.1.2 Recall Peak

Recall values allows an operator to view the highest force applied to each individual cell. Figure 6-2 shows how to recall peak values and clear them if desired.

SECTION 7. Serial Communication

7.1 GENERAL

The DXt-40 is equipped with a variety of standard and optional serial output formats that are selected using a series of DIP switches (Figure 7-1). DIP switch positions 1, 2, and 3 (Table 7-1) allow four format choices; continuous output, terminal/computer interface, and Modbus RTU. Allen-Bradley Remote I/O is available as an option, but requires different documentation (see page 7-8). All types of DXt interfacing will be discussed in the following paragraphs. Positions 4-7 designate transmitter address for applications requiring more than one DXt unit (Table 7-2). Switch position 8 is unused and should be left in the '0' (ON) position.

7.1.1 Standard Simplex Output (Continuous Output).

The simplex output format is designed to transmit tension data (ASCII coded) to a remote terminal or computer. The accuracy of this point to point, digital communication interface is much greater than simple analog current or voltage approximates. Simplex out-puts are transmitted in the format on page 7-2, top left-hand column.

Table 7-1. Serial Interface and Baud Rate Selections

Switch Positions	Baud Rate	Interface
1 2 3		
0 0 0	9600	Digi-System Network
1 0 0	28800	Digi-System Network
0 1 0	57600	Digi-System Network
1 1 0	1200	Continuous Output
0 0 1	9600	Continuous Output
1 0 1	1200	Terminal Interface
0 1 1	9600	Terminal Interface
1 1 1	*	MODBUS RTU
0 = ON		

Table 7-2. DXt-40-HTU Transmitter Address Selections

Switch Position	Address
4 5 6 7	
0 0 0 0	16
1 0 0 0	1
0 1 0 0	2
1 1 0 0	3
0 0 1 0	4
1 0 1 0	5
0 1 1 0	6
1 1 1 0	7
0 0 0 1	8
1 0 0 1	9
0 1 0 1	10
1 1 0 1	11
0 0 1 1	12
1 0 1 1	13
0 1 1 1	14
1 1 1 1	15
0 = ON	

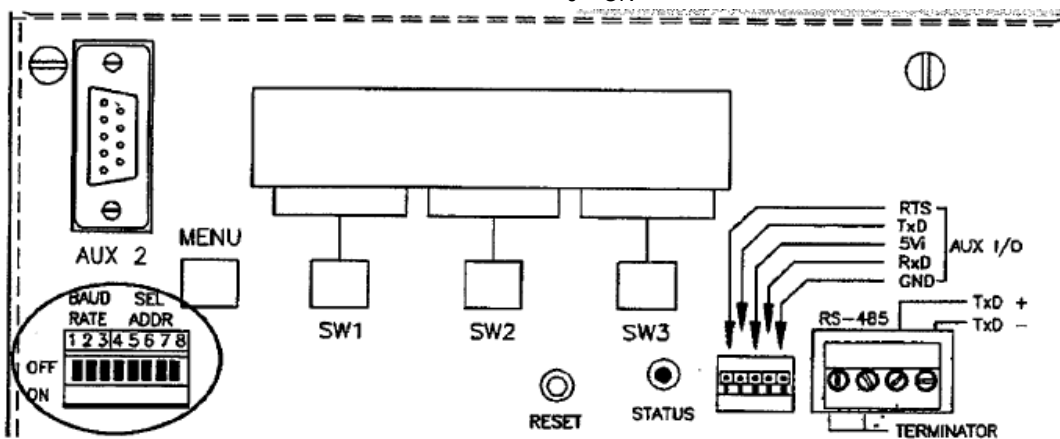

Figure 7-1. Serial Communication Parameter Selection Switch.

STX/ADR/POL/DATA/SP/UNITS/MODE/STATUS/CR/LF

Where:

STX= 1 char. Start of Text (02H)
 ADR= DX1-40 unit address, 2 ASCII characters
 POL= Polarity sign; space for positive data,
 minus (-) for negative data
 DATA= 7 char; six digits with decimal point or
 leading space, leading zeros = spaces
 CR/LF= 2 char; carriage return, line feed (0DH/0AH)
 SP= 1 char; ASCII space (20H)

Total bits per character = 1 start, 1 even parity, 7 data, and one stop.

7.1.2 Optional Computer/Terminal interface.

This half duplex (transmit and receive) format is de-signed for two way communication between a single DXt-40, or a network of DXt-40 units, and a computer/terminal. Protocol accommodates all operations such as total, work, drive, and difference. Use of this format requires customer developed device specific software to run the various network operations. Table 7-3 defines the terminal interface protocol.

Table 7-3. Computer/Terminal Interface Protocol.

Terminal			
ASCII Command	Description	Action	DXt-40 Response (starts with stx, 02h)
MODE 'A'			
'G'	TOTAL	Sum of all 4 Transducers	'01 (8 pol & data bytes) G' [adr/sp/pol/data/sp/'G'/CRLF]
'N'	DRIVE	Total Tension of Cells 1&2	'01 (8 pol & data bytes) N' [adr/sp/pol/data/sp/'N'/CRLF]
'T'	WORK	Total Tension of Cells 3&4	'01 (8 pol & data bytes) T' [adr/sp/pol/data/sp/'T'/CRLF]
'Z'	DIFFERENCE	Difference Between Work & Drive	'01 (8 pol & data bytes) Z' [adr/sp/pol/data/sp/'Z'/CRLF]
MODE 'B'			
'G'	TOTAL	Sum of Cells 1&2	'01 (8 pol & data bytes) G' [adr/sp/pol/data/sp/'G'/CRLF]
'N'	DIFFERENCE	Difference Between Cells 1&2	'01 (8 pol & data bytes) N' [adr/sp/pol/data/sp/'N'/CRLF]
'T'	TOTAL	Sum of Cells 3&4	'01 (8 pol & data bytes) T' [adr/sp/pol/data/sp/'T'/CRLF]
'Z'	DIFFERENCE	Difference Between Cells 3&4	'01 (8 pol & data bytes) Z' [adr/sp/pol/data/sp/'Z'/CRLF]
MODE 'C'			
'G'	TOTAL 1	Total Tension. Cell 1	'01 (8 pol & data bytes) G' [adr/sp/pol/data/sp/'G'/CRLF]
'N'	TOTAL 2	Total Tension. Cell 2	'01 (8 pol & data bytes) N' [adr/sp/pol/data/sp/'N'/CRLF]
'T'	TOTAL 3	Total Tension. Cell 3	'01 (8 pol & data bytes) T' [adr/sp/pol/data/sp/'T'/CRLF]
'Z'	TOTAL 4	Total Tension. Cell 4	'01 (8 pol & data bytes) Z' [adr/sp/pol/data/sp/'Z'/CRLF]

Table 7-3 (cont.) Computer/Terminal Interface Protocol.

ASCII Command	Description	Action	DXt-40 Response (starts with stx, 02h)
Mode A Only			
'Q%'	Dual Data Percent	Compare Drive to Work for %	'01 (sp 8 pol & data bytes sp)x1 %' [adr/(sp pol data 1-2 sp)'/%/CRLF]
Modes A, B, C			
'QD'	Quad Data	Send Individual Data for Each Cell	'01 (sp 8 pol & data bytes sp)x3 G' [adr/(sp pol data 1-4 sp)'/G'/CRLF]
'QD'	Quad Data (mV/V)	Send Individual mV/V Data for Each Cell	'01 (sp 8 pol & data bytes sp)x3 V' [adr/(sp pol data 1-4 sp)'/V'/CRLF]
'DE'	Diag. Errors	Check Overload Cells 1-4 (capital O in posn 1-4 shows overloaded cell)	'01 . . . 'no errors '01 . O . . 'overload cell 2
'SC'	Set Continuous	Send Constant Tension Data Transmission DXt-40 sends G N T Z data every update	'01 (8 pol & data bytes) GNTZ' x4 First = [adr/sp/pol/data/sp/'G'/CRLF] Second = [adr/sp/pol/data/sp/'N'/CRLF] Third = [adr/sp/pol/data/sp/'T'/CRLF] Fourth = [adr/sp/pol/data/sp/'Z'/CRLF]
'SD'	Set Demand	Tension Data Upon Request DXt-40 sends only requested data, when demanded	Stops Continuous Mode, If Selected
'SFxxxx'	Set Serial Format: where Xxxx 0= 6 digits data 1= 7 digits data xXxx 0= leading spaces 1= leading zeros xxXx 0= decimal point 1= no decimal point xxxX 0= confirm with (GNTZ) 1= no confirm of (GNTZ)	Changes To Serial Data Format: transmit 0 or 1 in designated position (xxxx) to effect change	No Response
'SRxxxx'	Recall of Serial Format: where Xxxx 0= 6 digits data 1= 7 digits data xXxx 0= leading spaces 1= leading zeros xxXx 0= decimal point 1= no decimal point xxxX 0= confirm with (GNTZ) 1= no confirm of (GNTZ)	Recall Serial Data Format	'01 RFxxxx' CRLF

Table 7-3 (cont.) Computer/Terminal Interface Protocol.

ASCII Command	Description	Action	DXt-40 Response (starts with stx, 02h)
'SL1-4x'	Set Filter for Each Cell* (x) x=0: filter is OFF x=1: filter 4.8 Hz x=2: filter 2.5 Hz x=3: filter 1.7 Hz x=4: filter 1.3 Hz x=5: filter 1.0 Hz x=6: filter 0.8 Hz x=7: filter 0.6 Hz x=8: filter 0.4Hz	Enter or Alter Filter Frequency: by transmitting SL, the cell number (1-4) and the number of the desired filter frequency (0 thru 8)	No Response
'RL1-4'	Recall Filter for Each Cell* (1-4) x=0: filter is OFF x=1: filter 4.8 Hz x=2: filter 2.5 Hz x=3: filter 1.7 Hz x=4: filter 1.3 Hz x=5: filter 1.0 Hz x=6: filter 0.8 Hz x=7: filter 0.6 Hz x=8: filter 0.4Hz	Recall Filter Frequency Selections: by transmitting RL, and the cell number	'01 RL(0 to 8)' CRLF

* 1 filter max for mode A, 2 (each zone) for mode B, and 4 (each cell) for mode C

Note: Remote filter settings are not stored in EEPROM and will revert to EEPROM settings upon power down.

Abbreviations:

adr	address, 3 ASCII chars: first two are '01' - '16' followed by an ASCII space
Poi	polarity: ASCII plus or minus sign
data	weight data: 7/8 characters, 617 digits w/decimal point or leading space
sp	ASCII space (20H)
sp	one character: L=pounds, K=kilograms

7.1.3 Optional Modbus Protocol

This interface method is applicable to virtually any PLC or other process control computer with Modbus communication capability. The interface provides tension and diagnostics information and allows for remote computer to download new calibration data and overload values. Information is transmitted in blocks of data thereby minimizing polling and response delays. The interface operates with the DXt-40 configured as the slave device and the host computer as the master. Table 7-4 presents a complete overview of register and bit allocations for each Modbus format. Figure 7-2 (page 7-9) presents the interface baud rate and parity selections.

Modbus Functions Supported:

- 02 Read Input Status
- 03 Read Holding Registers
- 06 Preset Single Register
- 16 (10 Hex) Preset Multiple Registers

DXt-40 Data Formats Provided:

- **FORMAT #1:** One 16 bit signed integer - 32768 to 32767 for all weight data mv/v data is divided by 10
- **FORMAT #2:** Two 16 bit signed integers for most tension data (the two integers must be added together to get -6553610 65534) One 16 bit signed integer for diagnostic & % data One 16 bit signed integer for mv/v data (divided by 10)
- **FORMAT #3:** Two 16 bit signed integers for all tension data (the high word, 1st

integer, must be multiplied by 32768.0
then added to the low word, 2nd integer)

Table 7-4. MODBUS Register Allocations

DXt40 READ ONLY REGISTERS (Function 03)				
READ ONLY	FORMAT #1		FORMAT #2	
ITEM	ADR #REG		ADR #REG	FORMAT #3 ADR #REG
1 - STATUS 3	40001	1	40201	1 40401
2 - STATUS 2	40002	1	40202	1 40402
3 - STATUS 1	40003	1	40203	1 40403
4 - TENSION DECIMAL POINT	40004	1	40204	2 40404
5 - SPARE	40005	1	40206	2 40406
6 - GROSS CELL 1	40006	1	40208	2 40408
7 - GROSS CELL 2	40007	1	40210	2 40410
8 - GROSS CELL 3	40008	1	40212	2 40412
9 - GROSS CELL 4	40009	1	40214	2 40414
10 - TENSION TOTAL	40010	1	40216	2 40416
11 - FORCE TOTAL	40011	1	40218	2 40418
12 - ANGLE TOTAL	40012	1	40220	2 40420
13 - SPARE	40013	1	40222	2 40422
14 - MV/V/10 CELL 1	40014	1	40224	1 40424
15 - MV/V/10 CELL 2	40015	1	40225	1 40426
16 - MV/V/10 CELL 3	40016	1	40226	1 40428
17 - MV/W10 CELL 4	40017	1	40227	1 40430
18 - % LOAD CELL 1	40018	1	40228	1 40432
19 - % LOAD CELL 2	40019	1	40229	1 40433
20 - % LOAD CELL 3	40020	1	40230	1 40434
• 21 - % LOAD CELL 4	40021	1	40231	1 40435
22 - SPARE	40022	1	40232	2 40436
23 - PEAK CELL 1	40023	1	40234	2 40438
24 - PEAK CELL 2	40024	1	40236	• 2 40440
25 - PEAK CELL 3	40025	1	40238	2 40442
26 - PEAK CELL 4	40026	1	40240	2 40444
27 - DRIVE TENSION	40027	1	40242	2 40446
28 - DRIVE FORCE	40028	1	40244	2 40448
29 - DRIVE ANGLE	40029	1	40245	2 40450
30 - WORK TENSION	40030	1	40246	2 40452
31 - WORK FORCE	40031	1	40250	2 40454
32 - WORK ANGLE	40032	1	40252	2 40456
33 - 56 SPARE				

Table 7-4 (cont.) Status Register Bit Definitions.

STATUS REGISTER DEFINITIONS (Function, 03)

STATUS 1 (GENERAL STATUS)

BIT 0- ACTIVE FILTER, (0) = FILTER 1, (1) = FILTER 2 BIT 1 - SPARE

BIT 2- SPARE

BIT 3 - SPARE

BIT 4 - IN CAL

BIT 5- DIAG ERROR

BIT 6 - LIMIT OVERLOAD

BIT 7- A/D OVERLOAD

BIT 8- SPARE

BIT 9- SPARE

BIT 10 - POWERUP BIT 11 - SPARE (0) BIT 12 - SPARE (0) BIT 13 - SPARE (0) BIT 14 - SPARE (0) BIT 15 - SPARE (0)

STATUS 2

BIT 0- SETPOINT 1

BIT 1 - SETPOINT 2

BIT 2- SETPOINT 3

BIT 3- SETPOINT 4

BIT 4 - OVERLOAD LIMIT CELL 1 BIT 5 - OVERLOAD LIMIT CELL 2 BIT 6- OVERLOAD LIMIT CELL 3 BIT 7 - OVERLOAD LIMIT CELL 4 BIT 8- AID UNDERLOAD CELL 1 BIT 9- AID OVERLOAD CELL 1 BIT 10- A/D UNDERLOAD CELL 2 BIT 11 - AID OVERLOAD CELL 2 BIT 12- AID UNDERLOAD CELL 3 BIT 13- A/D OVERLOAD CELL 3 BIT 14- AID UNDERLOAD CELL 4 BIT 15- A/D OVERLOAD CELL 4

STATUS 3- SPARE, NOT USED

DXt-40 Read/Write Registers (Functions 03, 06, 16)

	Format #1	Format #2	Format #3
		ADR #REG	ADR #REG
1 SPARE	40101 1	40301 1	40501 1
2 SPARE	40102 1	40302 2	40502 2
3 SPARE	40103 1	40304 2	40504 2
4 SPARE	40104 1	40306 2	40506 2
5 SPARE	40105 1	40308 2	40508 2
6 FILTER* 1 FREQUENCY	40106 1	40310 1	40510 1
7 FILTER* 1 MOTION BAND	40107 1	40311 1	40511 1
8 FILTER* 1 MOTION TIMER	40108 1	40312 1	40512 1
9 FILTER* 2 FREQUENCY	40109 1	40313 1	40513 1
10 FILTER* 2 MOTION BAND	40110 1	40314 1	40514 1
11 FILTER* 2 MOTION TIMER	40111 1	40315 1	40515 1
12 FILTER* 3 FREQUENCY	40112 1	40316 1	40516 1
13 FILTER'S MOTION BAND	40113 1	40317 1	40517 1
14 FILTER* 3 MOTION TIMER	40114 1	40318 1	40518 1
15 FILTER* 4 FREQUENCY	40115 1	40319 1	40519 1
16 FILTER* 4 MOTION BAND	40116 1	40320 1	40520 1
17 FILTER* 4 MOTION TIMER	40117 1	40321 1	40521 1
18 SPARE	40118 1	40322 1	40522 1
19 SPARE	40119 1	40323 2	40523 2
20 SPARE	40120 1	40325 1	40525 1
21 SPARE	40121 1	40326 1	40526 1
22 OVERLOAD CELL 1	40122 1	40327 2	40527 2
23 OVERLOAD CELL 2	40123 1	40329 2	40529 2
24 OVERLOAD CELL 3	40124 1	40331 2	40531 2
25 OVERLOAD CELL 4	40125 1	40333 2	40533 2

FILTER* (frequency)

- 00= OFF
- 01 = 4.8 Hz
- 02 = 2.5 Hz
- 03 = 1.7 Hz
- 04 = 1.3 Hz
- 05 = 1.0 Hz
- 06 = 0.8 Hz
- 07 = 0.6 Hz
- 08 = 0.4 Hz

MOTION (band)

- 00 = OFF**
- 01 = 1 count**
- 02 = 2 counts
- 03 = 3 counts
- 04 = 5 counts
- 05 = 10 counts
- 06 = 20 counts
- 07 = 50 counts

MOTION TIMER

- 00 = 1/2 SEC**
- 01 = 1 SEC
- 02 = 2 SEC
- 03 = 3 SEC

*Filter Designations as Follows:

Mode A - Filter 1 Only

Mode B - Filter 1 and Filter 2 If Second Zone Selected Mode C - Filter 1 thru 4 If Cells Selected

Note: counts refers to displayed counts. If the display is counting by 2 (x2 increments), then presetting a register to 9 would equal 18 lb/ph/etc.

MODBUS Configuration Parameters



<p>MENU </p>	<p>MODBUS INTERFACE? YES NO EXIT</p>	<p>YES To Configure MODBUS Parameters</p> <p>MENU MENU .. Advance To 'DXP40 Version Information'</p> <p>SW1 YES .. Configure MODBUS Interface</p> <p>SW2 NO .. Go To 'DXP40 Version Information'</p> <p>SW3 EXIT ... Return To Live Operation</p>
<p>SW1 SW2 SW3</p> <p><input type="checkbox"/> <input type="checkbox"/> <input type="checkbox"/></p>		
<p>MENU </p>	<p>BAUDRATE = 9600 STEP MODIFY EXIT</p>	<p>Modify To Select 2400, 4800, 9600, or 19200 Baud</p> <p>MENU MENU .. Return To Previous Display</p> <p>SW1 STEP .. Advance To Parity Selection</p> <p>SW2 MODIFY.. Select Desired Baud Rate</p> <p>SW3 EXIT ... Return MODBUS Interface?</p>
<p>SW1 SW2 SW3</p> <p><input type="checkbox"/> <input type="checkbox"/> <input type="checkbox"/></p>		
<p>MENU </p>	<p>No Parity STEP MODIFY EXIT</p>	<p>Modify To Select Parity - No, ODD, EVEN</p> <p>MENU MENU .. Return To Previous Display</p> <p>SW1 STEP .. Return To MODBUS Interface?</p> <p>SW2 MODIFY.. Select Desired Parity Option</p> <p>SW3 EXIT ... Return To MODBUS Interface?</p>
<p>SW1 SW2 SW3</p> <p><input type="checkbox"/> <input type="checkbox"/> <input type="checkbox"/></p>		

Figure 7-2. Modbus Baud rate and Parity Selections (accessed from main menu).

7.1.4 Optional Allen Bradley Remote I/O

This interface option uses Allen Bradley components in the DXt-40 to establish a remote I/O network communication link to the PLC 5 series of programmable logic controllers. To the PLC, the DXt-40 represents 1/4 rack of discrete I/O with 32 bits of input and output image files. All tension and status data use discrete reads and writes to communicate scale information to the PLC in the shortest time possible. Non time critical information such as higher level diagnostics relies upon block transfers.

The complete details of this interface will be covered later in this manual.









SECTION 8. Process Control

8.1 GENERAL

The DXt-40 Tension Transmitter provides analog and set point outputs to control system operation. Output functions are based upon two factors, mode selection and option installation. This chapter defines output configurations for each mode as well as parameter selection procedures.

Depending upon option selection (page 1-5 item "P", process outputs), units fall into one of three categories; no process outputs [P1], four set points and one analog output [P2], or four analog outputs and one set point [P4]. At power up, this option is displayed as the second - (dash) value (-1,-2, or -4). If no process outputs are installed, skip this section.

Main Menu (Accessed from Operation Mode)

<p>MENU  LIVE TENSION DISPLAY ALL THREE MODES</p> <p>SW1 <input type="checkbox"/> SW2 <input type="checkbox"/> SW3 <input type="checkbox"/></p>	<p>LIVE TENSION DISPLAY MENU MENU _ Begin Configuration by Advancing To Digital Filter Setup (Mode A) Or Individual Display Selection (Modes B and C)</p>
<p>MENU  DISPLAY INDV DATA YES NO EXIT</p> <p>SW1 <input type="checkbox"/> SW2 <input type="checkbox"/> SW3 <input type="checkbox"/></p>	<p>Modes B and C ONLY! MENU MENU _ Advance To Digital Filter Setup Unless Error SW1 YES _ Display Individual Load Cells SW2 NO _ Go To Digital Filter Setup SW3 EXIT _ Return To Live Tension Display</p>
<p>MENU  DIGITAL FILTER SETUP YES NO EXIT</p> <p>SW1 <input type="checkbox"/> SW2 <input type="checkbox"/> SW3 <input type="checkbox"/></p>	<p>YES to enter/alter Digital Filtering Parameters MENU MENU _ Advance To 'Cell Diagnostics' SW1 YES _ Enter Or Alter Filter Parameters SW2 NO _ Go To Cell Diagnostics SW3 EXIT _ Return To Live Operation</p>
<p>MENU  CELL DIAGNOSTICS YES NO EXIT</p> <p>SW1 <input type="checkbox"/> SW2 <input type="checkbox"/> SW3 <input type="checkbox"/></p>	<p>Enter Cell Overload or Recall Peak Load MENU MENU _ Advance To 'Do Calibration' SW1 YES _ Perform Diagnostic Evaluation SW2 NO _ Go To 'Do Calibration' SW3 EXIT _ Return To Live Operation</p>
<p>MENU  DO CALIBRATION? YES NO EXIT</p> <p>SW1 <input type="checkbox"/> SW2 <input type="checkbox"/> SW3 <input type="checkbox"/></p>	<p>YES to Perform System Calibration MENU MENU _ Return To Live Operation SW1 YES _ Enter Or Alter Calibration Settings SW2 NO _ Go To Analog Setup SW3 EXIT _ Return To Live Operation</p>
<p>MENU  ANALOG OUTPUT SETUP? YES NO EXIT</p> <p>SW1 <input type="checkbox"/> SW2 <input type="checkbox"/> SW3 <input type="checkbox"/></p>	<p>YES to Enter/Alter Analog Output Parameters MENU MENU _ Advance To 'Setpoints' SW1 YES _ Enter/Alter Analog Output Parameters SW2 NO _ Go To Setpoints? SW3 EXIT _ Return To Live Operation</p>
<p>MENU  SETPONTS ? YES NO EXIT</p> <p>SW1 <input type="checkbox"/> SW2 <input type="checkbox"/> SW3 <input type="checkbox"/></p>	<p>YES Designates Output A2 Error Alarm MENU MENU _ Advance To Modbus or Remote I/O Interface? SW1 YES _ Designated Output Is System Alarm Only SW2 NO _ Return To Live Operation SW3 EXIT _ Return To Live Operation</p>
<p>MENU  REMOTE I/O BAUDRATE? YES NO EXIT</p> <p>SW1 <input type="checkbox"/> SW2 <input type="checkbox"/> SW3 <input type="checkbox"/></p>	<p>YES To Configure Custom Communication Parameters MENU MENU _ Advance To 'DX40 Version Information' SW1 YES _ Configure Communication Interface SW2 NO _ Go To 'Instrument Version Information' SW3 EXIT _ Return To Live Operation</p>
<p>MENU  BLH DX40 VER 1.0 OPTIONS -1-2-6</p>	<p>View Software Version# and Option Status MENU MENU _ Return To Live Operation</p>

 = Switch Pressed

Figure 8-1. Analog and Set Point Selections in Main Menu.

8.2 Analog Output Configuration

With option [P4], the four 4-20 mA analog output functions are defined by mode selection and will be discussed in the following paragraphs. Each output derives from a 16 bit digital to analog (D-A) conversion which represents up to one part in 65536 of analog precision. The scaling of the output is accomplished after the DXt-40 is calibrated and can be ranged for any portion of the system tension output curve. Although functions are different, each analog channel (output) follows the same configuration procedure shown in Figure 8-2.

After configuring the first output, simply press STEP in the second block of Figure 8-2 (CAL ANALOG OUTPUT #X) and repeat the process for each subsequent channel.

To begin configuration, connect a current meter to the appropriate analog output points (see Figure 2-5) and proceed with configuration as shown in Figure 8-2.

8.2.1 Mode A Output Designations

Table 8-1 depicts the four analog output functions available with mode A operation. This configuration is typically used with BLH HTA measurement units.

Output Number	Function	How Derived
1	Total Tension	Sum of all cells
2	Drive Tension	Sum cells 1&2
3	Work Tension	Sum Cells 3&4
4	Difference	Drive-Work

8.2.2 Mode B Output Designations

Table 8-2 depicts the four analog output functions available with mode B operation. Two outputs offer sum and difference signals for zone one, while the other two outputs provide sum and difference for zone two.

Table 8-2. Mode B Analog Output Functions

Output Number	Function	How Derived
1	Total 1+2	Sum of cells 1&2
2	Difference	Cell 1 - Cell 2
3	Total 3+4	Sum of cells 3&4
4	Difference	Cell 3 - Cell 4

8.2.3 Mode C Output Designations

Table 8-3 depicts the four analog output functions available with mode C operation. Each output reflects a total tension value for the designated transducer.

Output Number	Function	How Derived
1	Total 1	NA
2	Total 2	NA
3	Total 3	NA
4	Total 4	NA

8.2.4 Single Analog Output Option

If option [P2] is installed, only one analog output is available. Note differences in the configuration menu (Figure 8-2). This output can be set for any tracking option available with the selected mode (see grey block, Figure 8-2). After selecting output tracking type, perform range calibration with high and low reference points.

8.3 Optional Set Point Outputs

8.3.1 Four Set Point Options

Option [P2] provides four independent set point entries with accompanying relay outputs. Option [P2] relays are dry contact. See page 1-3 for relay specifications. Each set point relay can be configured for any tracking function available in the selected mode (see Tables 8-1 to 8-3), or a diagnostic output annunciator. If diagnostic is selected, any error condition encountered, single cell or system wide, activates the output.

Figure 8-3 (next page) presents procedures for entering the numeric value and configuring the output status of each set point. Note that available selections include relay active state (above or below set point) and hysteresis. Hysteresis represents the number of display counts (above or below set point) that must be exceeded before relay re-activation.

Analog Output Configuration

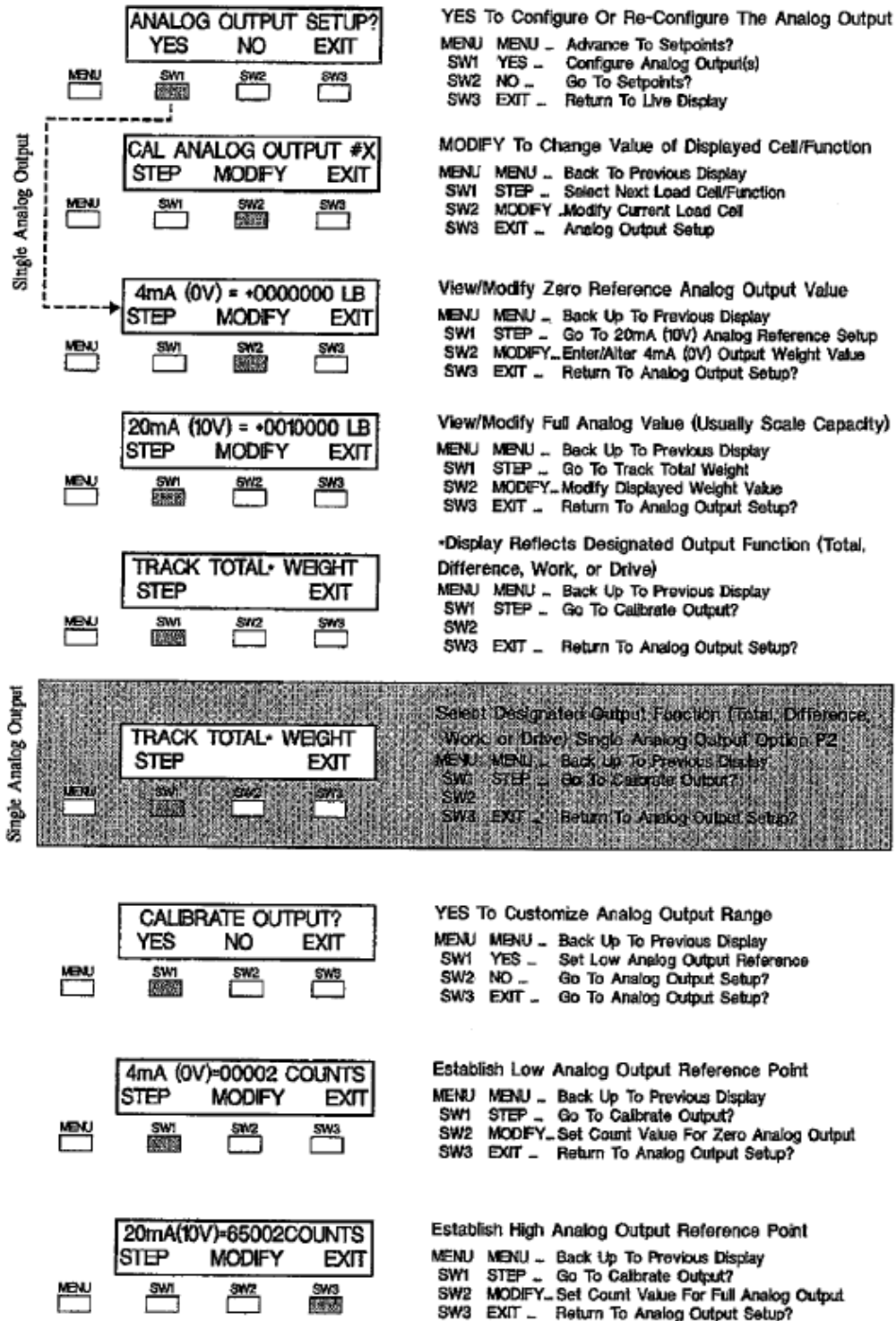

YES To Configure Or Re-Configure The Analog Output

MENU MENU _ Advance To Setpoints?
SW1 YES _ Configure Analog Output(s)
SW2 NO _ Go To Setpoints?
SW3 EXIT _ Return To Live Display

MODIFY To Change Value of Displayed Cell/Function

MENU MENU _ Back To Previous Display
SW1 STEP _ Select Next Load Cell/Function
SW2 MODIFY _ Modify Current Load Cell
SW3 EXIT _ Analog Output Setup

View/Modify Zero Reference Analog Output Value

MENU MENU _ Back Up To Previous Display
SW1 STEP _ Go To 20mA (10V) Analog Reference Setup
SW2 MODIFY _ Enter/Alter 4mA (0V) Output Weight Value
SW3 EXIT _ Return To Analog Output Setup?

View/Modify Full Analog Value (Usually Scale Capacity)

MENU MENU _ Back Up To Previous Display
SW1 STEP _ Go To Track Total Weight
SW2 MODIFY _ Modify Displayed Weight Value
SW3 EXIT _ Return To Analog Output Setup?

*Display Reflects Designated Output Function (Total, Difference, Work, or Drive)

MENU MENU _ Back Up To Previous Display
SW1 STEP _ Go To Calibrate Output?
SW2 SW3 EXIT _ Return To Analog Output Setup?

Select Designated Output Function (Total, Difference, Work, or Drive) Single Analog Output Option P2

MENU MENU _ Back Up To Previous Display
SW1 STEP _ Go To Calibrate Output?
SW2 SW3 EXIT _ Return To Analog Output Setup?

YES To Customize Analog Output Range

MENU MENU _ Back Up To Previous Display
SW1 YES _ Set Low Analog Output Reference
SW2 NO _ Go To Analog Output Setup?
SW3 EXIT _ Go To Analog Output Setup?

Establish Low Analog Output Reference Point

MENU MENU _ Back Up To Previous Display
SW1 STEP _ Go To Calibrate Output?
SW2 MODIFY _ Set Count Value For Zero Analog Output
SW3 EXIT _ Return To Analog Output Setup?

Establish High Analog Output Reference Point

MENU MENU _ Back Up To Previous Display
SW1 STEP _ Go To Calibrate Output?
SW2 MODIFY _ Set Count Value For Full Analog Output
SW3 EXIT _ Return To Analog Output Setup?

Figure 8-2. Analog Output Configuration Flow Diagram.

8.3.2 Single Set Point Option

The single set point relay output (option [P4]) can be configured for one selected mode function (see Tables 8-1 to 8-3), or a diagnostic output annunciator. As a diagnostic annunciator, any error condition encountered, whether single cell related or system malfunction, activates the output. Typical errors tracked are cell overloads, motion, and excitation faults.

All value entry and configuration details are presented in Figure 8-3 (next page). Note that available selections include relay active state (above or below set point) and hysteresis. Hysteresis represents the number of display counts (above or below set point) that must be exceeded before relay re-activation.

Setpoint/Relay Output Configuration

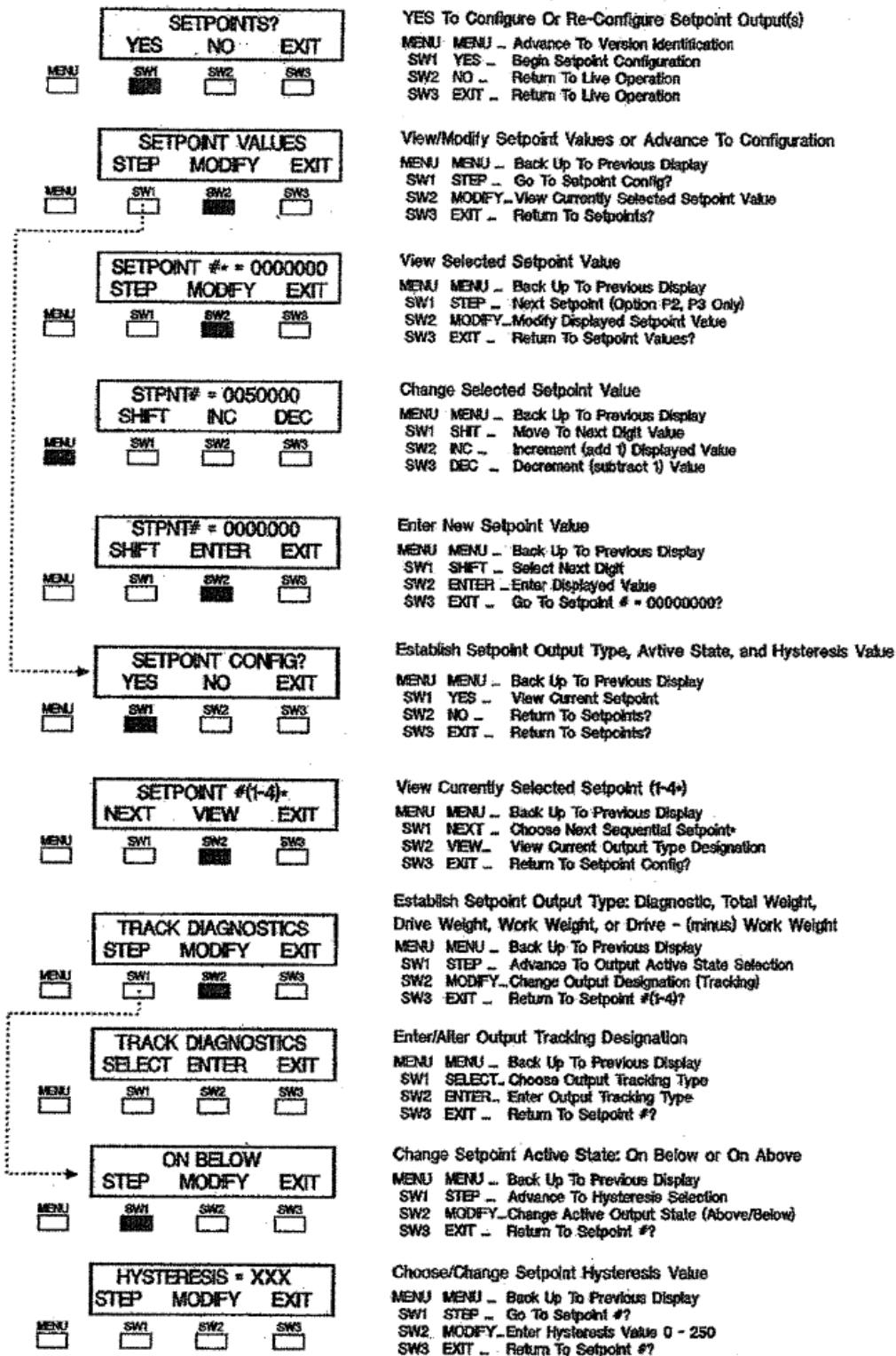

Figure 8-3. Relay Output Configuration.

Part-2
The Allen-Bradley
Remote I/O Interface



ENABLED™
BY ALLEN-BRADLEY TECHNOLOGY

Precision Force and Weight Measurement Technologies

SECTION 9. Introduction

This manual describes an Allen-Bradley Remote I/O (R10) communication link between a BLH DXt-40 Web Tension Transmitter and an Allen-Bradley PLC-5 (Figure 1-1). This interface method uses technologies licensed by BLH from Allen-Bradley. Functionally this digital communication method provides a simple method of transferring web tension data, status, and diagnostic information as well as the retrieval and download of filter and other set-up parameters. Refer to BOOK I for DXt-40-HTU operating procedures and parameter definitions.

9.1 RIO OVERVIEW

The Allen-Bradley Remote I/O (R10) interface is a communications link that supports remote, time critical I/O control communications between a master processor and a remote I/O slave. It is typically used to transfer I/O bit images between the master and slave. The DXt-40 represents a quarter (1/4) Rack of discrete I/O with 32 bits of input and output image files to the scanning PLC. All web tension data and status information uses discrete reads and writes to communicate system information to the PLC in the shortest time possible. Block transfers are used to upload and download non-time critical information such as diagnostic, status, and individual load cell data.

NOTE: Transfer data differs according to mode selection

9.2 HE DM-40-HTU WEB TENSION TRANSMITTER

The DXt-40-1-ITU is a high performance web tension transmitter with features that make it suitable for all tension measurement applications.

Allen-Bradley PLC-5. The transmitter includes individual analog to digital conversion channels for up to four load cells, microprocessor based electronics to digitize the load cell signals, and a serial RS-485 or Allen-Bradley Remote I/O communication port. For field mount applications, standard units are housed in a NEMA 4 epoxy painted steel enclosure.

Optionally the DXt-40-HTU is available with on-line diagnostics, digital calibration, and Dynamic Digital Filtering. Units also are available with Factory Mutual Approval for installation in a Class I, II, III, Division 2 hazardous locations.

Set-up and calibration procedures are accomplished using a series of internal switches and the internal display. In operation, it provides up to three million counts of web tension resolution at an update rate of 50 milliseconds.

9.3 ALLEN-BRADLEY PLC-5 PROGRAMMABLE CONTROLLER

The Allen Bradley PLC-5 series of mid-size programmable controllers are used as part of distributed process automation architecture. A variety of 1771 series racks and I/O modules are available for local or remote discrete and analog process control. The PLC-5 can digitally • communicate to other devices using a conventional RS 232 or 423 serial port in addition to special interface ports such as Data Highway Plus, Scanner Communications, and Remote I/O Adapter.

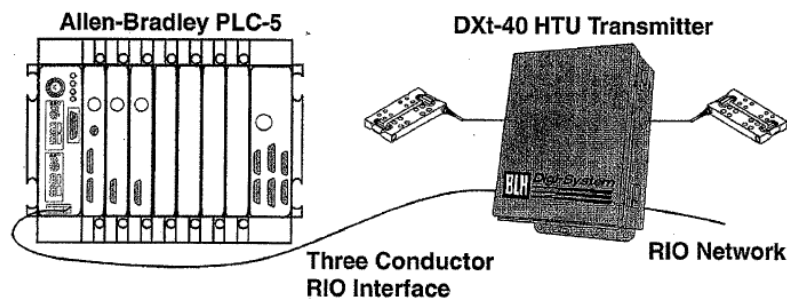

Figure 1-1. Allen-Bradley Remote I/O Network Interface.

SECTION 10. The Remote I/O Interface

10.1 OPERATIONAL OVERVIEW

The Allen-Bradley Remote I/O (RIO) interface is standard on many PLC-2, 3, and 5 series programmable logic controllers. The technology used in the interface and licensed by Allen-Bradley to BLH enables the DXt-40 HTU transmitter to communicate tension information to the PLC as if it were a 1/4 rack of discrete I/O. By using the standard RIO interface port and representing tension data as simple discrete I/O, a low cost reliable communication link between the PLC and system is established. Standard PLC ladder logic instructions convert binary data to an integer or floating point tension value without special software drivers and scan delays that occur when data block transfers are used. The DXt-40 HTU also communicates status information, diagnostics, and calibration data to the PLC.

CONFIGURATIONS:

- One Quarter Rack. The DXt-40 is configured to act as 1/4 rack of I/O using 2 input words and 2 output words in the PLC's I/O image table. DXt-40 addressing supports racks 1-8 only. Four DXt-40's constitute 1 full rack, each using a different starting quarter.

- Discrete Transfer Tension data and operating status information transmitted through discrete transfer using the PLC's Remote I/O image table.
- Block Transfer Block data transfers are initiated by the PLC ladder logic program to obtain more in depth status, diagnostic, and individual load cell data.
- Word Integrity Is Ensured. The DXt-40 will always transmit both input image table words intact. To ensure word integrity on the PLC side, immediate writes to the output image table should be written low word first.

10.2 HARDWARE CONFIGURATIONS

Rack address and starting quarter designations are all configured using a row of DIP switches in the DXt-40 (Figure 10-1). The DXt-40 is able to be addressed up to rack number 32. Whenever the DIP switch settings are changed, the unit must be reset to allow the processor to read the new switch settings.

RIO interface baud rate selections are available through the DXt-40 main menu (Figure 10-2). Recommended cable lengths are presented in Figure 10-1.

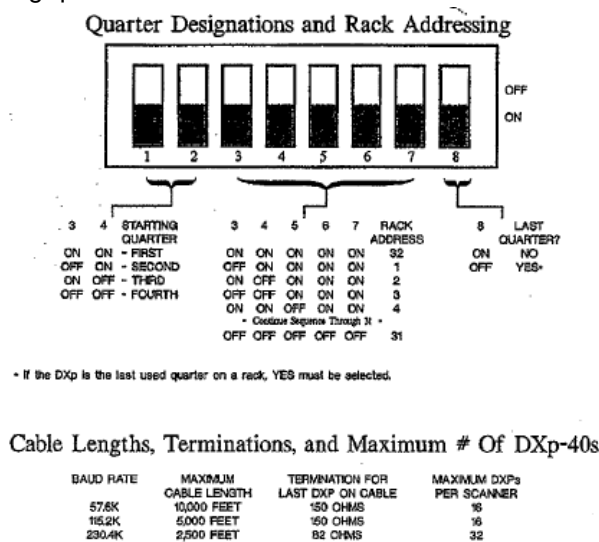

Figure 10-1. RIO Communication DIP Switch Settings.

10.3 DISCRETE DATA TRANSFER

10.3.1 Output Image Table

The PLC-5 initiates the communication interface by transmitting two words from the output image

table (Figure 10-3). The first word is regarded as a 'spare' by the DXt-40 HTU.

The second word contains the commands that the PLC-5 expects the DXt-40 to perform. Word 2 controls set points, filter selection, filter operation, and DXt-40 operating mode status.

Word 1

15 14 13 12 11 10 09 08 07 06 05 04 03 02 01 00



Word 2

15 14 13 12 11 10 09 08 07 06 05 04 03 02 01 00

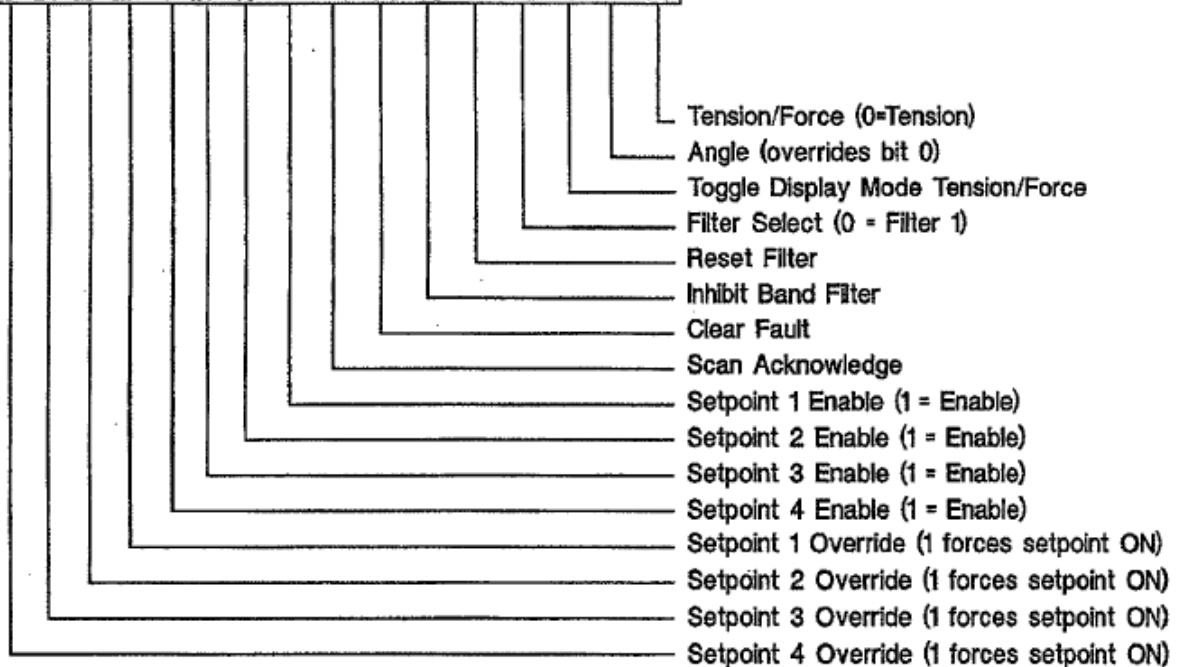

Figure 10-3. The Output Image Table.

10.3.2 Input Image Table

After evaluating the contents of the output image table, the DXt-40 responds by transmitting two words to the input image table (Figure 10-4).

The first word contains signed integer weight data. The second word contains the upper order data bits, system status, error condition, and set point status information.

Word 1 - Signed Integer Data

15 14 13 12 11 10 09 08 07 06 05 04 03 02 01 00

Word 2 - Command, Request, Data

15 14 13 12 11 10 09 08 07 06 05 04 03 02 01 00

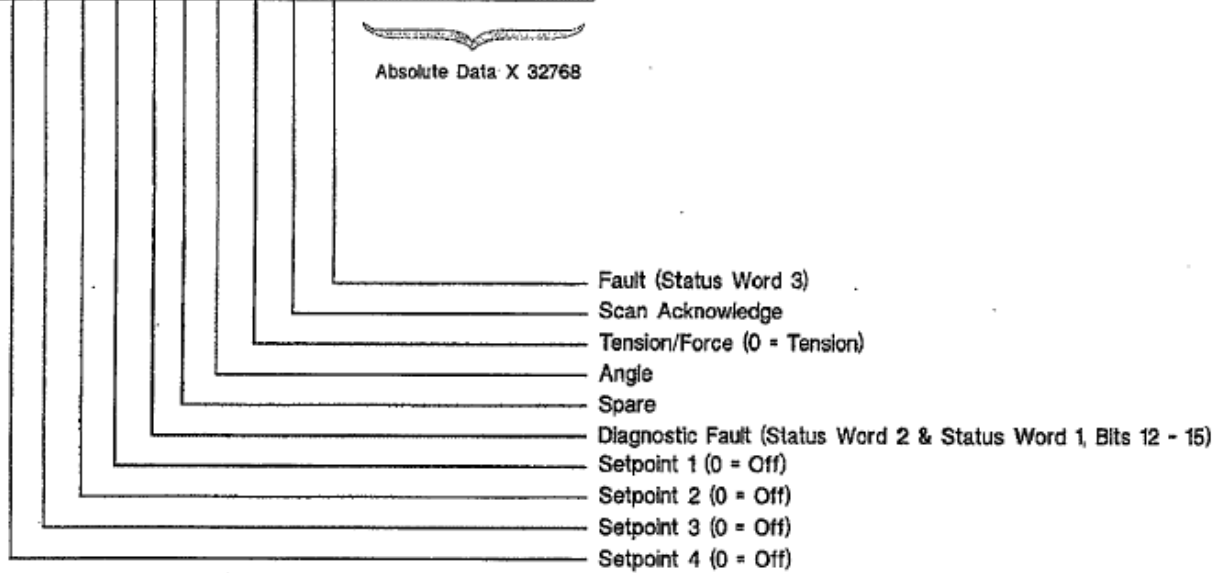

Figure 10-4. The Input Image Table.

10.4 BLOCK DATA TRANSFERS

10.4.1 Interface Basics

Block data transfers are initiated by the ladder logic program write (BTW) and read (BTR) commands. The transfer sequence begins when the PLC sends the DXt-40 a one word (16 bit integer) write command containing a register location pointer. This pointer is the 16 bit integer value of the first register the PLC wishes to read (factory default upon shipment is register 1).

Table 10-1 presents all available single and double word register locations. After establishing the starting register location, the PLC then transmits a read transfer block command telling the DXt-40 how many words of information are needed.

10.4.2 Block Transfer Reads (BTRs)

Once the register location pointer value is established, the PLC logic program must issue a block transfer read command to obtain DXt-40 information. A BTR can request up to 64 words of DXt-40 information (see Table 10-1). The DXt-40 will respond to the BTR by transmitting the number of words requested, starting at the pointer location. NOTE: The first word transmitted by the DXt-40 will be the register pointer value. The DXt-40 adds this word at the beginning of the transmission to 'echo' the pointer value prior to transmitting requested data. Therefore, the SIR command MUST add 1 to the number of words requested. If the PLC needs four words of DXt information, the BTR request must be for five words (Figure 10-5).

10.4.3 Block Transfer Writes (BTWs)

Some of the DXt-40 registers may be written to by the PLC (indicated by an '*' in Table 10-1). This allows parameters such as filter, set point, and diagnostic values to be down loaded on-the-fly by the PLC ladder logic program. When writing to the DXt-40, the first word must be the register location pointer. Therefore, the program MUST always add 1 to the BTW command length (Figure 10-6). For example, to change a set point value, the BTW length must equal 2 with the first word being the set point register location pointer and the second word being the new set point value. Parameter guidelines for writing data to the DXt-40 are presented in Table 10-2.

10.4.4 A Perpetual Pointer

One advantage to DXt-40 block transfers is that the register pointer is retained in DXt-40 EEPROM. When a write block selects (points to) a register location, that location may be accessed (read) repeatedly without having to re-write the register location word. Of course the register pointer can be changed as often as needed, but the last written location will always be remembered, even during power down. This feature saves a lot of BTWs when the PLC is monitoring a particular register or block of registers over a period of time.

10.4.5 Fault Evaluation

Three status words, register locations 1, 2, and 3, provide detailed explanations of error conditions encountered by the DXt. When a fault is detected, either bit 6 (fault) or bit 11 (diagnostic fault) in word 2 of the input image table is set to a '1' to alert the PLC of an error condition. The PLC must then perform a BTR of the appropriate status register to evaluate and correct the error. If bit six (fault) is set, check status word 3 for the error explanation. If bit 11 (diagnostic fault) is active, check status word 2 and status word 1 bits 12 - 15 for the error explanation. Table 10-3 gives the status word bit definitions.

10.4.6 Remote Filter Configuration

DXt-40 transmitters equipped with the optional Dynamic Digital Filter can be instructed by the PLC to change filter settings on-the-fly. This unique feature allows optimal, pre-determined filtering parameters to be implemented at critical moments during system operation. Changing filter parameters throughout the process ensures data stability and maximum system response to actual tension changes. Filter parameters are stored at register locations 59-70 (Table 10-1). Table 10-2 defines the filter parameters that can be written to these registers in the DXt-40.

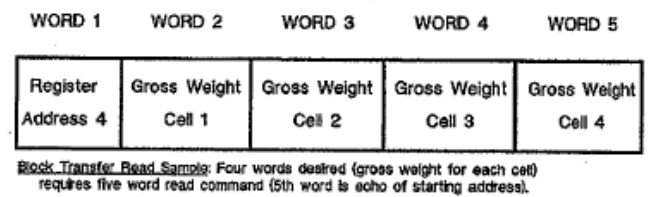

Figure 10-5. Block Transfer Read (I3TR) Sample.

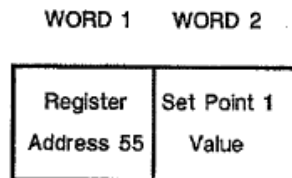

Figure 10-6. Block Transfer Write (BTW) Sample.

Table 10-1. Single & Double Word Register Pointer Locations

Single Word Registers		Double Word Registers	
01	STATUS 3	100	SPARE
02	SPARE	102	SELECTION 1 (see output image table)
03	STATUS 1	104	SELECTION 2 (see output image table)
04	SELECTION 1 (see output image table)	106	SELECTION 3 (see output image table)
05	SELECTION 2 (see output image table)	108	SELECTION 4 (see output image table)
06	SELECTION 3 (see output image table)	110	SPARE
07	SELECTION 4 (see output image table)	112	INDV TOTAL CELL 1
08	INDV TOTAL CELL 1	114	1NDV TOTAL CELL 2
09	1NDV TOTAL CELL 2	116	INDV TOTAL CELL 3
10	INDV TOTAL CELL 3	118	1NDV TOTAL CELL 4
11	INDY TOTAL CELL 4	120	MV/V CELL 1
12	MV/V/10 CELL 1	122	MV/V CELL 2
13	MV/V/10 CELL 2	124	MV/V CELL 3
14	MV/V/10 CELL 3	126	MV/V CELL 4
15	MV/V/10 CELL 4	128	PEAK TOTAL (MODE A ONLY)
16	% LOAD DRIVE (MODE A ONLY)	130	PEAK CELL 1
17	% LOAD WORK (MODE A ONLY)	132	PEAK CELL 2
18	SPARE (MODE A ONLY)	134	PEAK CELL 3
19	SPARE (MODE A ONLY)	136	PEAK CELL 4
20	PEAK TOTAL CELLS 1-4 (MODE A	138	SPARE
21	PEAK CELL 1	140	SPARE
22	PEAK CELL 2	142	SPARE
23	PEAK CELL 3	144	SPARE
24	PEAK CELL 4	146	SPARE
25	SPARE	148	SPARE
26	SPARE	150	SPARE
27	SPARE	152	SPARE
28	SPARE	154	SPARE
29	SPARE	156	SPARE
30	SPARE	158	SPARE
31	SPARE	160	SPARE
32	SPARE	162	SPARE
33	SPARE	164	SPARE
34	SPARE	166	OVERLOAD CELL 1
35	SPARE	168	OVERLOAD CELL 2
36	SPARE	170	OVERLOAD CELL 3
37	SPARE	172	OVERLOAD CELL 4
38	SPARE		
39	SPARE		
40	SPARE		
41	SPARE		
42	SPARE		
43	SPARE		
44	SPARE		
	SPARE		
46	SPARE		
47	SPARE		
48	SPARE		
49	SPARE		
50	SPARE		
51	SPARE		
52	SPARE		
53	SPARE		
	SPARE		
	SPARE		
55*	SETPOINT 1 (Option)		
56*	SETPOINT 2 (Option)		
57*	SETPOINT 3 (Option)		
58*	SETPOINT 4 (Option)		
59*	FILTER 1 LENGTH		
60*	FILTER 1 MOTION BAND		
61*	FILTER 1 MOTION TIMER		
62*	FILTER 2 LENGTH		
63*	FILTER 2 MOTION BAND		
64*	FILTER 2 MOTION TIMER		
65*	FILTER 3 LENGTH		
66*	FILTER 3 MOTION BAND		
67*	FILTER 3 MOTION TIMER		
68*	FILTER 4 LENGTH		
69*	FILTER 4 MOTION BAND		
70*	FILTER 4 MOTION TIMER		
71*	SPARE		
72*	SPARE		
73*	SPARE		
74*	SPARE		

* Word(s) can be written to by PLC I*

1). Single word register integer data = -32768 to +32767

2). Double word integer data must be converted to floating point using the following equation:

$$\frac{((word2) \times 32768.0)}{word1}$$

range = -9,999,999 to 9,999,999

75* OVERLOAD CELL 1
 76* OVERLOAD CELL 2
 77* OVERLOAD CELL 3
 78* OVERLOAD CELL 4

Table 10-2. Block Transfer Write Parameters.

Set Point Entries

0 to 9,999,999

Filter Parameter Entries

Filter Length	Band Averaging	Motion	Motion Timer
00 = 50 ms	00 = 2	00 = OFF	00 = 1/2 sec
01 = 100 ms	01 = 4	01 = 1 count	01 = 1 sec
02 = 200 ms	02 = 8	02 = 2 counts	02 = 2 sec
03 = 400 ms	03 = 16	03 = 3 counts	03 = 3 sec
04 = 800 ms	04 = 32	04 = 5 counts	
05 = 1600 ms	05 = 64	05 = 10 counts	
06 = 3200 ms	06 = 128	06 = 20 counts	
07 = 6400 ms	07 = 256	07 = 50 counts	

Band Filter

0 to 250 counts

Filter Response

0 to 250 counts

Overload

0 to 9,999,999

* Counts refers to displayed counts. If displayed weight is counting by 2 lb increments, then a selection of nine counts will equal 18 lb.

NOTE: Refer to BOOK 1 for DXt-40-FITU parameter definitions.

Table 10-3. Status Word Bit Definitions

STATUS 1 (GENERAL STATUS)

BIT 0	SPARE
BIT 1	SPARE
BIT 2	SPARE
BIT 3	SPARE
BIT 4	SPARE
BIT 5	IN CAL
BIT 6	SPARE
BIT 7	SPARE
BIT 8	INPUT 1
BIT 9	INPUT 2
BIT 10	INPUT 3
BIT 11	INPUT 4
BIT 12	OVERLOAD LIMIT CELL 1
BIT 13	OVERLOAD LIMIT CELL 2
BIT 14	OVERLOAD LIMIT CELL 3
BIT 15	OVERLOAD LIMIT CELL 4

STATUS 2 Not Used - SPARE

STATUS 3 (FAULTS)

BIT 0	POWERUP
BIT 1	EEPROM CODE ERROR - DEFAULT DATA
OVERLOAD	
BIT 2	EEPROM READ ERROR
BIT 3	EEPROM WRITE ERROR
BIT 4	SPARE
BIT 5	SPARE
BIT- 6	SPARE
BIT 7	SPARE
BIT 8	ND UNDERLOAD ¹ CELL 1
BIT 9	AID OVERLOAD ² CELL 1
BIT 10	ND UNDERLOAD CELL 2
BIT 11	ND OVERLOAD CELL 2
BIT 12	AID UNDERLOAD CELL 3
BIT 13	ND OVERLOAD CELL 3
BIT 14	ND UNDERLOAD CELL 4
BIT 16	ND OVERLOAD CELL 4

1 Underload = input signal too low

2 Overload = input signal too high

SECTION 11. Definitions and Explanations

11.1 INPUT IMAGE TABLE BITS

A table is provided to explain the Input Image

Table presented in Figure 10-4. Table 11-1

defines the bit structure of both input words.

Table 11-1. Input Image Table Word 'Bit' Definitions

Word 1 BITS 0 - 15 DATA (signed integer, -32768 to +32767)
Signed integer.

Word 2

BITS 0- 5 ABSOLUTE OVERFLOW DATA x 32768

Word 2 bits 0-5 is absolute overflow data from word 1 used if absolute tension data is greater than 32,767. These 5 bits are combined with the word 1 integer in a floating point register by the following steps.

1. Do a Masked move of Word 2 bits 0 - 5 to an integer register.
2. Multiply the integer register by 32768.0 and put the result in a floating point register.
3. Negate the floating point result if the word 1 integer is negative.
4. Add the word 1 integer to the floating point result.

BIT 6 FAULT

Is set If there is a fault causing tension data to be incorrect. This bit is cleared or suppressed by setting the clear fault bit in word 2 of the output image table.

BIT 7 SCAN ACKNOWLEDGE

This bit is a copy of *the* same bit in the output image table. When the DXt-40 receives the output image table data it copies this bit to the same location in the input image table. The plc can thus know if the remote I/O DXt-40 has received the last write to the output image table.

BIT 8 T/F, TENSION/FORCE DATA ID

If this bit = 0 the data in word 1 and bits 0-5 of word 2 is tension data. If this bit = '1 the data is force data.

BIT 9 ANGLE DATA ID.

If this bit =1, then bit 8 is superceded and the data in word 1 and bits 0-5 of word 2 is angle data.

BIT 10 SPARE

BIT 11 DIAGNOSTIC FAULT

Is set if any of the diagnostic fault bits are set in the status #1 register bits 12 -15 or status #2 register bits 0-15. These status registers are accessible through a block transfer read.

BIT 12 SETPOINT #1

Is set If setpoint #1 output is on. If word 2 bit 8 of the output image table = 1 the setpoint #1 output is controlled by the DXt-40. If word 2 bit 8 of the output image table = 0 the setpoint #1 output Is controlled by word 2 bit 12 of the output image table.

BIT 13 SETPOINT #2

Is set If setpoint #2 output is on. If word 2 bit 9 of the output Image table = 1 the setpoint #2 output is controlled by the DXt-40. If word 2 bit 9 of the output image table = 0 the setpoint #2 output is controlled by word 2 bit 13 of the output image table.

BIT 14 SETPOINT #3

Is set if setpoint #3 output is on. If word 2 bit 10 of the output Image table = 1 the setpoint #3 output is controlled by the DXt-40. If word 2 bit 10 of the output image table = 0 the setpoint #3 output is controlled by word 2 bit 14 of the output Image table.

BIT 15 SETPOINT #4

Is set if setpoint #4 output is on. If word 2 bit 11 of the output Image table = 1 the setpoint #4 output is controlled by the DXt-40. If word 2 bit 11 of the output image table = 0 the setpoint #4 output Is controlled by word 2 bit 15 of the output image table.

11.2 OUTPUT IMAGE TABLE BITS

Table 11-2 shows the structure and bit definition of each Output Image Table word. Reference Figure 10-3 to view word breakouts.

Table 11-2. Output Image Table Word/Bit Definitions

Word 1 Unused

Word 2

BIT 0 TENSION/FORCE (0 = TENSION)

Used for requesting tension or force data. If = 0, tension data will be returned to the input image table. If = 1, force data will be returned.

BIT 1 ANGLE

If this bit changes from 0 to 1, then bit 0 is superseded and the data returned is angle data.

BIT 2 TOGGLE DISPLAY

If this bit changes from 0 to 1, the DXt display changes from tension to force or vice-versa

BIT 3 FILTER SELECT (0 = FILTER 1, 1 = FILTER 2)

This bit is 'or'ed with the discrete filter select input as shown in the following table:

ININPUT SELECT	BIT 3	FILTER SELECTED
FILTER 1	0	FILTER 1
FILTER 1	1	FILTER 2
FILTER 2	0	FILTER 2
FILTER 2	1	FILTER 2

BIT 4 RESET FILTER

If this bit changes from 0 to 1 the DXt-40 will reset or restart the filter using data from the current aid conversion. This may be helpful in overcoming time lags caused by heavy averaging.

BIT 5 INHIBIT BAND FILTER

When this bit is set to 1 the band filter is inhibited. Set to 1 for a minimum of 50 milliseconds and then reset to 0 resets the band filter. If the band is wide, and heavy averaging is applied this will quicken the response to small signal changes which fall within the band width. When the band filter is reset quick centering algorithms will rapidly find the center of a noisy input signal.

BIT 6 CLEAR FAULT

Setting this bit will clear all fault bits in status register 3 except for eeprom faults. Eeprom faults require the DXt-40 to be reset. If the a/d overfunderange faults persist the corresponding fault flags will be set again when this bit returns to 0.

BIT 7 SCAN ACKNOWLEDGE

This bit is set or reset by the plc to achieve data transfer synchronization between the plc's program scan and the remote I/O scan. When the DXt-40 receives the output image table data it copies this bit to the same location in the input image table. The plc can thus know if the remote ifo DXt-40 has received the last write to the output image table.

BIT 8 SETPOINT #1 ENABLE (I = ENABLE)

Setting this bit to 1 enables the DXt-40 setpoint #1 output to be controlled by the DXt-40. If reset to 0 the setpoint #1 output is controlled by BIT 12.

BIT 9 SETPOINT #2 ENABLE (1 = ENABLE)

Setting this bit to 1 enables the DXt-40 setpoint #2 output to be controlled by the DXt-40. If reset to 0 the setpoint #2 output is controlled by BIT 13.

BIT 10 SETPOINT #3 ENABLE (1 = ENABLE)

Setting this bit to 1 enables the DXt-40 setpoint #3 output to be controlled by the DXt-40. If reset to 0 the setpoint #3 output is controlled by BIT 14.

BIT 11 SETPOINT #4 ENABLE (1 = ENABLE)

Setting this bit to 1 enables the DXt-40 setpoint #4 output to be controlled by the DXt-40. If reset to 0 the setpoint #4 output is controlled by BIT 15.

BIT 12 SETPOINT #1 OVERRIDE

If BIT 8 = 0 the state of this bit controls the setpoint #1 output. A 1 turns on the setpoint #1 output.



BLH

3 Edgewater Drive,
Norwood, MA 02062 U.S.A.

Phone (781)298-2200

Fax (781)762-3988

www.vishaypg.com