



**VISHAY
PRECISION
GROUP**

BLH

**LCp-104
Weighing System
Operator's Manual**

NOTICE

BLH makes no representation or warranties of any kind whatsoever with respect to the contents hereof and specifically disclaims any implied warranties or merchantability or fitness for any particular purpose. BLH shall not be held liable for errors contained herein or for incidental or consequential damages in connection with the furnishing, performance, or use of this publication or its contents.

BLH reserves the right to revise this manual at any time and to make changes in the contents hereof without obligation to notify any person of such revision or changes.

Call (781) 298-2216 for BLH Field Service

Table of Contents

SECTION 1.	General Information	1-1
1.1	SYSTEM DESCRIPTION.....	1-1
1.1.1	Introducing the Plug-n-Weigh Concept	1-1
1.1.2	The Safe-Weigh Software System	1-1
1.1.3	The LCp-104 Front Panel.....	1-2
1.1.4	Main Configuration Flow Diagram.....	1-4
1.1.5	Serial Communication	1-4
1.2	OPTIONS	1-4
1.2.1	Mounting Options	1-4
1.2.2	Analog Output Options	1-4
1.2.3	Allen-Bradley Remote 110 Network Interface	1-4
1.2.4	MODBUS RTU Protocol.....	1-4
1.2.5	MODBUS Plus Protocol	1-5
1.2.6	DeviceNet Protocol.....	1-5
1.3	LCP-104 PERFORMANCE SPECIFICATIONS.....	1-5
1.4	LCP-104 ORDERING SPECIFICATIONS	1-6
1.5	WARRANTY POLICY	1-6
1.6	FIELD ENGINEERING	1-7
SECTION 2.	System Installation	2-1
2.1	INTRODUCTION.....	2-1
2.2	MOUNTING.....	2-1
2.2.1	Display Console Mounting	2-1
2.2.2	Smart Junction Box Mounting	2-1
2.3	ELECTRICAL CONNECTIONS	2-1
2.3.1	The LCp-104 Rear Panel	2-1
2.3.2	Module Interconnection	2-1
2.3.3	Transducer Signal Inputs	2-3
2.3.4	Mains (ac) Power	2-3
2.3.5	Serial Communication	2-5
2.3.6	Analog Output (Option)	2-5
2.3.7	Digital (Remote) Inputs	2-6
2.3.8	Open Collector Set point Outputs (Optional)	2-6
2.3.9	Triac Set point Relay Outputs (Optional)	2-6
2.3.10	Quad Analog Outputs.....	2-7

2.4	SMART JUNCTION BOX LED's	2-7
2.4.1	Communication Status	2-7
2.4.2	Load Cell Status Indication	2-7
SECTION 3.	Calibration	3-1
3.1	SYSTEM CALIBRATION (CALIBRAT)	3-1
3.2	SET-UP SYSTEM PARAMETERS	3-1
3.2.1	Number of Load Cells	3-1
3.2.2	Display Units	3-1
3.2.3	Decimal Point Location	3-1
3.2.4	Capacity	3-1
3.2.5	Output.....	3-1
3.2.6	Front Panel Display Counts	3-1
3.3	SYSTEM CALIBRATION	3-1
3.3.1	Quick Type Calibration.....	3-2
3.3.2	Deadload Calibration.....	3-2
3.3.3	Keypad Calibration.....	3-5
3.4	DEGRADE MODE FUNCTION	3-5
SECTION 4.	Dynamic Digital Filter	4-1
4.1	GENERAL	4-1
4.1.1	Digital Averaging	4-1
4.1.2	Band Selection	4-1
4.1.3	Conversion Selection	4-1
4.1.4	Filter Set-Up Procedures.....	4-1
SECTION 5.	Front Panel Display Functions	5-1
5.1	FRONT PANEL FUNCTIONS	5-1
5.1.1	Horizontal Bar Graph	5-1
5.1.2	Vertical Bar Graph.....	5-1
5.1.3	Alarm Status Annunciators.....	5-1
5.1.4	Configuring the TARE Key	5-1
5.1.5	Configuring the ZERO Key.....	5-1
5.1.6	The Gross/Net Key.....	5-1
SECTION 6.	Process Outputs.....	6-1
6.1	ANALOG OUTPUT(S) (Optional).....	6-1
6.1.1	Output Definition.....	6-1
6.1.2	Set-Up Procedure.....	6-1

6.2	SERIAL COMMUNICATION	6-1
6.2.1	Transmit Only Output Formats (ASCII)	6-1
6.2.2	Full/Half Duplex Bi-Directional Interface	6-4
6.3	SETPOINT CONFIGURATION	6-4
6.3.1	Main Set point Function and Selections	6-4
6.3.2	Entering/Altering Main Set points	6-5
6.3.3	Dribble Set point Function and Selection	6-5
SECTION 7.	System Diagnostics	7-1
7.1	OVERVIEW	7-1
7.2	DIAGNOSTIC USER	7-1
7.3	DIAGNOSTIC VERSION	7-1
7.4	DIAGNOSTIC RECALL	7-1
7.4.1	Recall Tare and Zero Values	7-1
7.4.2	Recall Shift	7-1
7.4.3	Recall Drift	7-1
7.5	SELECTING LIMITS	7-1
7.5.1	Zero Limit	7-1
7.5.2	Overload Limit	7-2
7.5.3	Motion Limit Selections	7-2
7.5.4	Shift Limit	7-2
7.5.5	Drift Limit	7-2
7.6	FRONT PANEL KEY TEST	7-2
7.7	CHECK REMOTE INPUTS	7-2
7.8	TEST/VERIFY THE ANALOG OUTPUT	7-2
7.9	TEST/TROUBLESHOOT THE SERIAL OUTPUT	7-2
7.10	TEST/TROUBLESHOOT THE OPTIONAL DEVICENET OUTPUT	7-2
SECTION 8.	The LCp-104 Security System	8-1
8.1	INTRODUCTION	8-1
8.1.1	Lock On/Off	8-1
8.1.2	Menu Locks	8-1
8.1.3	Key Locks	8-1
8.1.4	Set point Locks	8-1
8.2	PASSWORD ACCESS	8-1
8.2.1	Selecting/Storing a Password	8-1
8.2.2	Entering the Password	8-1

SECTION 9.	Operation.....	9-1
9.1	GENERAL	9-1
9.2	GROSS WEIGHT WEIGHING	9-1
9.3	ZERO OPERATION	9-1
9.4	NET WEIGHT WEIGHING	9-1
9.5	TARE OPERATION	9-1
9.6	INDIVIDUAL LOAD CELL DISPLAYS	9-1
9.7	RATE-BY-WEIGHT	9-2
9.7.1	Minimum Flow Rate Capability.....	9-2
9.7.2	Determining Weight/Rate Resolution	9-2
9.7.3	Parameter Selections	9-2
9.8	ERROR DETECTION AND CORRECTION	9-3
SECTION 10.	Allen-Bradley Remote I/O	10-1
10.1	INTERCONNECT CABLE	10-1
10.2	RIO OVERVIEW.....	10-1
10.3	THE ALLEN-BRADLEY PLC.....	10-1
10.4	THE REMOTE I/O INTERFACE	10-1
10.4.1	Operational Overview.....	10-1
10.4.2	Interface Configurations	10-2
10.4.3	Discrete Data Transfers	10-3
10.5	BLOCK DATA TRANSFERS.....	10-4
10.5.1	Interface Basics.....	10-4
10.5.2	A Perpetual Pointer	10-5
10.5.3	Fault Evaluation.....	10-5
10.5.4	Remote Filter Configuration	10-5
SECTION 11.	Modbus Protocols.....	11-1
11.1	MODBUS RTU PROTOCOL.....	11-1
11.1.1	Common Data Format.....	11-1
11.1.2	Modbus RTU Functions Supported.....	11-1
11.1.3	Setup	11-1
11.1.4	Manipulating the Front Panel Display	11-1
11.2	MODBUS PLUS INTERFACE.....	11-2
11.2.1	Routing Path Addressing	11-2
11.2.2	Global Data Transfers	11-2
11.2.3	Wiring and Node Addressing	11-3

11.2.4	Configuration	11-3
11.2.5	Data Formatting.....	11-3
11.2.6	Flashing LED Status	11-4
11.2.7	Manipulating the Front Panel Display	11-4
SECTION 12.	DeviceNet Protocols.....	12-1
12.1	THE INTERFACE DEFINED.....	12-1
12.1.1	General ODVA DeviceNet Description	12-1
12.1.2	LCp-104 DeviceNet Interface Description.....	12-1
12.2	INTERFACE WIRING	12-1
12.3	LED STATUS INDICATION	12-1
12.3.1	LCp-104 Status	12-2
12.3.2	DeviceNet Network Status	12-2
12.4	LCp-104 MENU CHANGES.....	12-2
12.4.1	I/O Menu Changes	12-2
12.4.2	Diagnostic Menu Changes	12-2
12.4.3	Display Menu Changes	12-4
12.5	DATA EXCHANGE FORMATS.....	12-4
12.5.1	Produced Data (LCp-104 Transmission)	12-5
12.5.2	Consumed Data (LCp-104 Receive).....	12-6
12.6	DeviceNet EDS FILE.....	12-12
12.7	DeviceNet CABLE CONSIDERATIONS	12-13

SECTION 1. General Information

1.1 SYSTEM DESCRIPTION

The LCp-104 System's patented synchronous digital measurement of multi-cell systems establishes the new benchmark in scale technology. Systems individually digitize each transducer in a multi-cell system and display the resultant weight or rate-by-weight signals, live, on the console display. Measuring each individual load cell provides greater system resolution and accuracy, while facilitating on-line dynamic diagnostics throughout the system process.

The LCp-104 'Expert Technology' Process Weighing System (Figure 1-1) consists of two modules designed to convert the mV/V signal from strain gage type force transducers (load cells) into a high resolution digital signal representing force or weight. Load cells connect directly to the smart junction box located in the immediate vicinity of the vessel/tank/hopper being weighed. Resultant rate/weight/force signals are communicated from the smart junction box directly to the console display module located up to 300 feet away. Console units operate at either 115 or 230 VAC and provide regulated, fault protected 10 VDC excitation for conventional 350-ohm strain gage type transducers. Standard features include an RS-422/485 serial port with PC interface or simplex output ASCII, a sigma delta type ND converter for each transducer, and dynamic digital filtering. Options include up to four high-resolution analog outputs, Modbus RTU Protocol, and various digital communication interfaces such as Allen-Bradley Remote I/O and Modbus Plus.

The Smart Junction Box enclosure is constructed entirely of stainless steel and rated NEMA 4X. Available cable glands provide access for load cell connection while maintaining NEMA integrity.

Console Display Modules are housed in an aluminum case with a powder coated aluminum panel mounting bezel. NEMA 4/4X wall mount

enclosures are available as options. Simple entry of calibration data, diagnostic parameters, and filter selections is accomplished using the front panel keypad. All electrical connections are made at the rear panel with unpluggable screw terminal connectors.

1.1.1 Introducing the Plug-n-Weigh Concept

The BLH Plug-n-Weigh concept takes advantage of technology to minimize start-up time and the operator learning curve. Intuitive configuration menus, self configuration of many set-up parameters, and simple push-button type digital calibration combine together to make the LCp-104 one of the easiest process instruments to configure and operate.

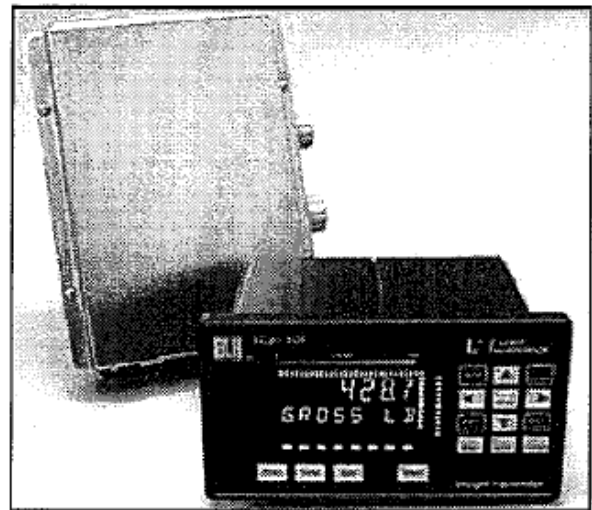

Figure 1-1. Both Modules of the LCp-104 System

1.1.2 The Safe-Weigh Software System

Safe-Weigh software system benefits include Expert System Diagnostics, Dynamic Digital Filtering, and a wide range of proven DCS/PLC connectivity options. Expert System Diagnostics provides on-line preventative maintenance information that quickly identifies electrical and/or mechanical problems. Dynamic Digital Filtering ensures precise, repeatable set point

control in 'noisy' process environments. Proven connectivity with Allen-Bradley, Modicon (AEG Schneider) General Electric, Johnson Yokogawa, Honeywell, Fisher-ProVox, Bailey, and other PLC/DCS devices eliminates the risks associated with digital integration of weight information into the process control environment.

1.1.3 The LCp-104 Front Panel

All configuration, calibration, and operation transactions are performed using the front panel push buttons and the high intensity vacuum fluorescent display (Figure 1-2). The user-friendly design separates the operating push buttons (gross/net, zero, tare, and print) from the configuration menu keypad. The two line alphanumeric display indicates weight data and status while in the operate mode and provides instructions, etc., during the configuration mode.

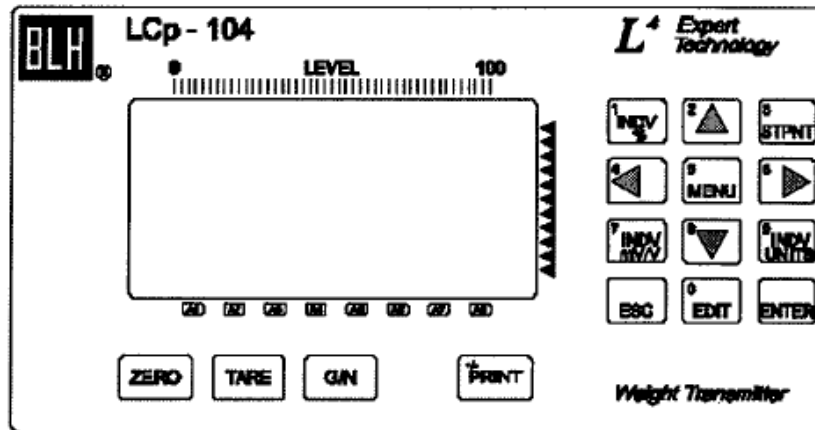
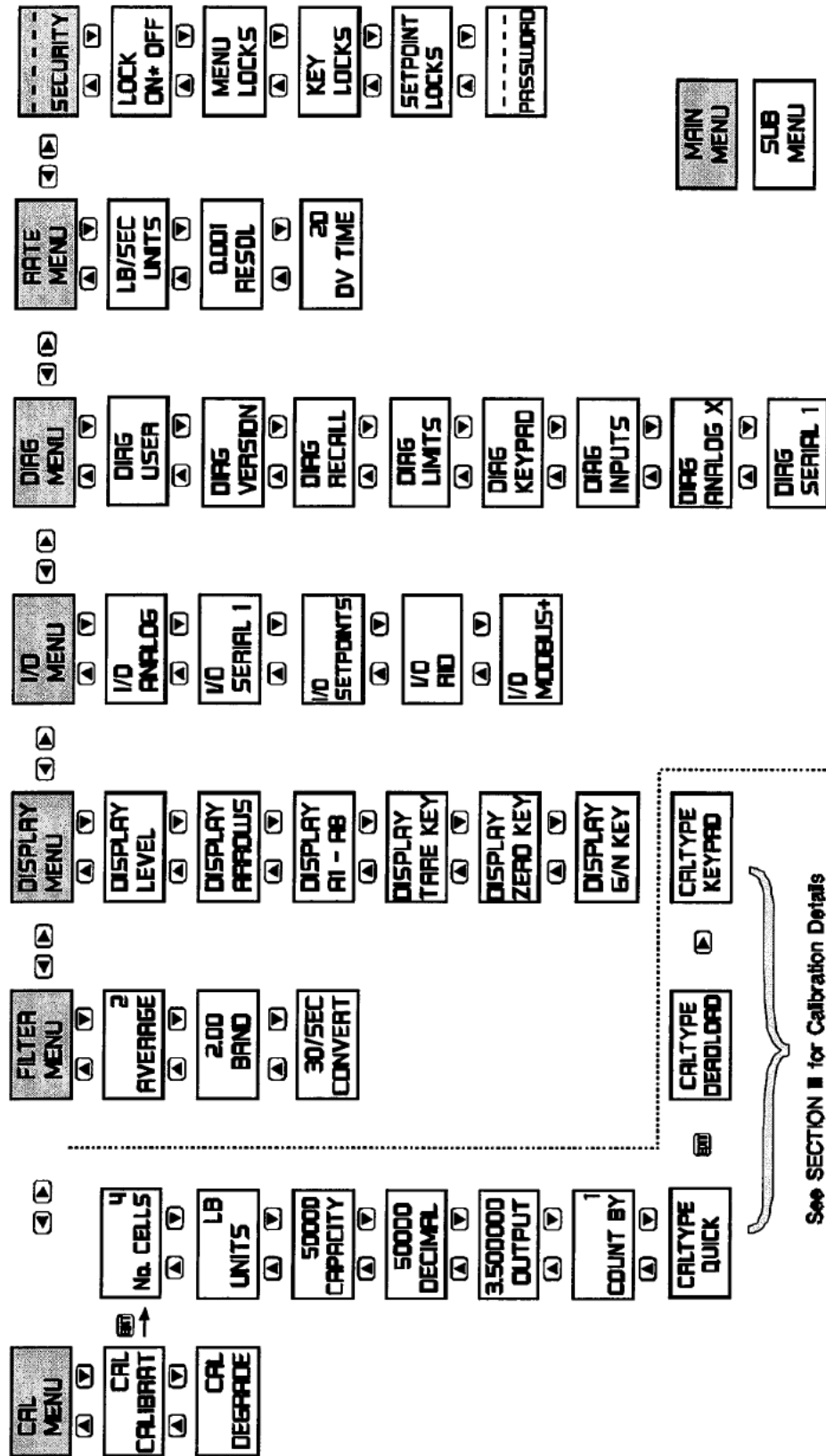

Figure 1-2. The LCp-104 Console Front Panel.



- ▲ Step back to previous sub menu selection.
- ▼ Advance to next sub menu selection.
- ▶ Advance to next main menu flow selection.
- ◀ Return to previous main menu flow selection.
- ⏪ Enter main menu from live operation mode.
- ⏩ Return to live operation from menu.
- ⏴ Change sub menu parameters.
- ⏵ Store displayed sub menu parameter in memory.

See SECTION 1 for Calibration Details

LCp-104 Overall Flow Diagram

Figure 1-3. The LCp-104 Main Flow Diagram.

1.1.4 Main Configuration Flow Diagram

LCp-104 configuration is performed using the menu driven keypad on the right side of the front panel and follows the flow diagram presented in Figure 1-3. This diagram shows the overall structure and general guidelines of LCp-104 set-up, calibration, filter, display, I/O, diagnostic, and security configuration routines. Detailed explanations of sub menu parameter selections are provided in sequential chapters, starting with Section III.

To browse through the menus, press MENU and use the arrow keys to move across menu subjects, or up and down within a menu. Parameters are not actually changed until the edit and enter keys are used.

1.1.5 Serial Communication

Standard LCp-104's are equipped with a single serial communication port that can be selected to operate as an RS-422 full duplex, or RS-485 half-duplex port. The type selection is made using a series of DIP switches on the Console Display rear panel. Protocol selection is made within the keypad menu structure. Standard units ship with ASCII protocol for communication with a printer, PC, remote display, or data logger. This port can be selected for continuous or demand operation. Extensive diagnostics verify transmit and receive, proper parity and framing, and a visualization function allows the user to view the actual serial transmit and receive characters. See Section II for wiring information and Section VI for protocol information.

1.2 OPTIONS

LCp-104 units are available with several different application enhancement options. Options include various mounting enclosures, analog output selections, and custom network interfaces/protocols. All options will be fully defined later in this manual.

1.2.1 Mounting Options

For units located in a general factory/plant floor, or if corrosive, hose down, or sanitary requirements are a factor, a NEMA 4X stainless steel enclosure is available (Console Display). For Div. 2 hazardous locations, units are available with CSA approval as non-incendive devices.

1.2.2 Analog Output Options

Systems are available with either one or four 16 bit analog output(s) with industry standard 4-20 mA operation. Set-up and calibration of these output(s) is accomplished using the menu keypad and can be configured to track gross, net, or rate-by-weight. Loop diagnostics are also provided to verify that the analog connection is intact. See Section 2 for wiring information, and Section VI for configuration details.

1.2.3 Allen-Bradley Remote 110 Network Interface

The Allen-Bradley Remote I/O interface is a communication link that supports remote, time critical I/O control communications between a master processor and a remote I/O slave. It is typically used to transfer I/O bit images between the master and slave. Each LCp-104 system represents a quarter (1/4) Rack of discrete I/O with 32 bits of input and output image files to the scanning PLC. All weight data and status information use discrete reads and writes to communicate scale information to the PLC in the shortest time possible. Block data transfers are used to communicate non-time critical diagnostic and calibration data, and remotely configure diagnostic limits and digital filter parameters.

1.2.4 MODBUS RTU Protocol

MODBUS is often recognized as an industry standard method of digital communication protocol between a master or host computer and a slave device. This protocol was originally developed by Modicon to communicate discrete and analog information between a PLC and a master host. As implemented in the LCp-104, this protocol efficiently communicates weight

and diagnostics information to a MODBUS Master driver equipped host.

1.2.5 MODBUS Plus Protocol

MODBUS Plus protocol allows the LCp-104 systems to communicate on a peer-to-peer network link with Modicon 984 and Quantum PLC devices.

1.2.6 DeviceNet Protocol

DeviceNet is a low cost industrial network designed to easily connect up to 64 "cell" type devices to a PLC/ PC. Information in this Section XIII defines the LCp-104 DeviceNet register allocations and interface instructions.

1.3 LCP-104 PERFORMANCE SPECIFICATIONS

Performance

Internal Resolution	4,194,304 total counts
Max. Display Resolution	3,000,000 total counts
Max. Res. Per Channel	1,000,000 counts
Conversion Speed	selectable 7.5, 15, 30, 60 and 120 conversions per second
Sensitivity (Noise)	0.001 1% full scale (max +/-16 counts w/o filter)
Full Scale Range	+/-35 mV/channel
Dead Load Range	100%
Input Impedance	10 M-ohms, min. per channel
Load Cell Excitation	10 V (65 mA/channel max)
Remote Sense	user configurable, each channel
Linearity	+/-0.0015% of full scale
Calibration Repeatability	0.3 uV per count

Temperature Coefficient

Span/Zero	+/-2ppm/°C
-----------	------------

Environment

Operating Temperature	-10 to 55°C (12 to 131°F)
Storage Temperature	-20 to 85°C (-4 to 185°F)
Humidity	5 to 90% rh, non-condensing
Voltage (Console)	115/230 +/-15% 50/60 Hz
(Jbox)	16 Vdc
Power	12 watts max

Display/Operator Interface

Type	high intensity cobalt green vacuum fluorescent
Active Digits	7 digit alpha numeric.59" high for weight: 8 digit alphanumeric .39" high for status

Approval

CSA	C22.2 (Class I, II,III; Div.2; Groups A-G)
-----	--

Isolated Analog Output(s)

Type	16 bit digital to analog
Current	4-20 mA (600 ohm max load) 0-20 mA (500 ohm max load)

DC Setpoint Outputs - 8 (Optional)

Type	open collector (current sinking)
Operating Voltage	5 - 35 Vdc
ON Voltage	1.2 Vdc @ 40 mA 0.8 Vdc @ 1 mA
OFF State Leakage Power	0.04 uA @ 40 Vdc external supply required

AC Setpoint Outputs - 8 (Optional)

Type	triac
Operating Voltage	12 - 240 Vac
AC Frequency	20 - 500 Hz
ON State Voltage Drop	1.2 Vrms
Min - Max Load Current	5mA - 1A
Leakage Current	1mA @ full rated load voltage
Power	external supply required

Digital Inputs

Logic'0' (Low)	less than 0.5Vdc, sink 3mA (min)
Logic'1' (High)	10 to 28 Vdc (TTL open collector)
Mechanical Relay'0'	closed (one side = digital common, the other side = input)
Mechanical Relay'1'	open (input internally pulled up)

Network Serial Communication (Std)

Type	RS-485 Half Duplex (Multi-Drop)
Baud	9.6K, 28.8K' and 56.7k

Simplex Data Output (Standard)

Type	RS-485 (Simplex)
Baud	1200 or 9600
Data Format (Selectable)	ASCII
	7 data bits, even parity, stop bit

Terminal/Computer Interface (Optional)

Interface Type	RS-485 half duplex (standard)
Baud	1200 or 9600
Protocol	duplex command/response format
ASCII	7 data bits, even parity, stop bit

Special Protocols (Optional)

Modbus	RTU Protocol
--------	--------------

Special Interface (Optional)

Allen Bradley	Remote I/O - 1/4 logical rack
Modbus Plus	peer-to-peer (with global data)
DeviceNet	to ODVA specification

1.4 LCP-104 ORDERING SPECIFICATIONS

Designator	Option Number	Option Definition
IM1 Mounting	[1]	NEMA 4X Panel Mount
	[2]	NEMA 4X Stainless Steel Wall Mount Enclosure
[A] Expansion Slot A	[1]	None (nothing installed)
	[2]	Modbus RTU Card
	[3]	Modbus Plus
	[4]	Allen-Bradley Remote 110
	[5]	Profibus
	[6]	DeviceNet
[P] Process Outputs	[1]	Remote Inputs (standard)
	[2]	#1 with Analog Output
	[3]	(4) Individual Analog Outputs
[C] Communication	[1]	RS-485, RS-422, or Multi-Drop RS-422 with PC Interface - ASCII Print Format
	[2]	Modbus RTU Protocol
[B] Expansion Slot B	[1]	None (standard)
	[2]	8 Open Collector DC Outputs
	[3]	8 Solid State Relay Outputs

Interconnecting cable part number is 149971-8. Specify length when ordering.

1.5 WARRANTY POLICY

BLH warrants the products covered hereby to be free from defects in material and workmanship. BLH's liability under this guarantee shall be limited to repairing or furnishing parts to replace, f.o.b. point of manufacture, any parts which, within three (3) years from date of shipment of said product(s) from BLH's plant, fail because of defective workmanship or material performed or furnished by BLH. As a condition hereof, such defects must be brought to BLH's attention for verification when first discovered, and the material or parts alleged to be defective shall be returned to BLH if requested. BLH shall not be

liable for transportation or installation charges, for expenses of Buyer for repairs or replacements or for any damages from delay or loss of use for other indirect or consequential damages of any kind. BLH may use improved designs of the parts to be replaced. This guarantee shall not apply to any material which shall have been repaired or altered outside of BLH's plant in any way, so as in BLH's judgment, to affect its strength, performance, or reliability, or to any defect due in any part to misuse, negligence, accident or any cause other than normal and reasonable use, nor shall it

apply beyond their normal span of life to any materials whose normal span of life is shorter than the applicable period stated herein. In consideration of the forgoing guarantees, all implied warranties are waived by the Buyer, BLH does not guarantee quality of material or parts specified or furnished by Buyer, or by other parties designated by buyer, if not manufactured by BLH. If any modifications or repairs are made to this equipment without prior factory approval, the above warranty can become null and void.

1.6 FIELD ENGINEERING

Authorized BLH Field Service Engineers are available around the world to install LCp-104 based weigh systems and/or train factory personnel to do so. The Field Service Department at BLH is the most important tool to assure the best performance from your application. Field Service phone numbers are listed below.

Factory: (Main Number) (781) 298-2200

Midwest: (614) 476-6453

Southwest (281) 655-5041

Canada: (416) 251-2554

or

(800) 567-6098 in Canada

SECTION 2. System Installation

2.1 INTRODUCTION

This chapter provides LCp-104 system mounting and electrical installation information. Instruments will operate accurately (to specification) in locations with temperatures ranging from -10°C to +55°C (+14°F to + 130°F). The installation location should be free of vibration. Unless equipped with the proper enclosure option, instruments should not be located in areas containing explosive or corrosive vapors. In all installations, ac (mains) power should be supplied from a clean (transient free) instrument power source.

2.2 MOUNTING

2.2.1 Display Console Mounting

The LCp-104 Display Console is shipped with the necessary hardware for panel mounting. Outline and panel cutout dimensions are depicted in Figure 2-1. Installation of panel mount adapters is shown in Figure 2-2. Display Console units can be located up to 300 feet from the junction box.

2.2.2 Smart Junction Box Mounting

Locate the NEMA 4X Junction Box centrally, within cable reach of the load cells, to ensure maximum system performance. Figure 2-3 shows the j-box outline dimensions and mounting hole designations. Four pre-punched holes enable wall or bracket mounting in the immediate load cell vicinity.

2.3 ELECTRICAL CONNECTIONS

2.3.1 The LCp-104 Rear Panel

Figure 2-4 (page 2-3) shows the LCp-104 Display Console Rear Panel where most connections are made.

2.3.2 Module Interconnection

Connect the Smart Junction Box to the Display Console Module using the four lead cable supplied by BLH. Carefully connect this cable to both modules as designated in Figure 2-5 (previous page). Be certain to connect the cable shield to the SHIELD terminal on BOTH modules. Cable length will be determined per sales order instructions.

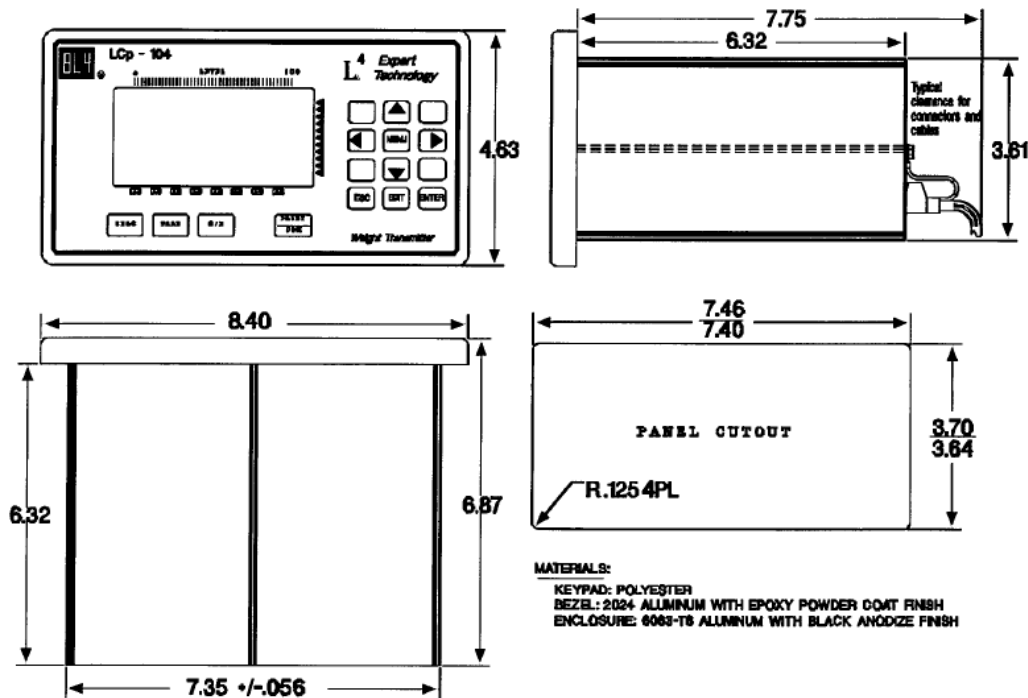

Figure 2-1. LCp-104 Display Console Outline Dimensions.

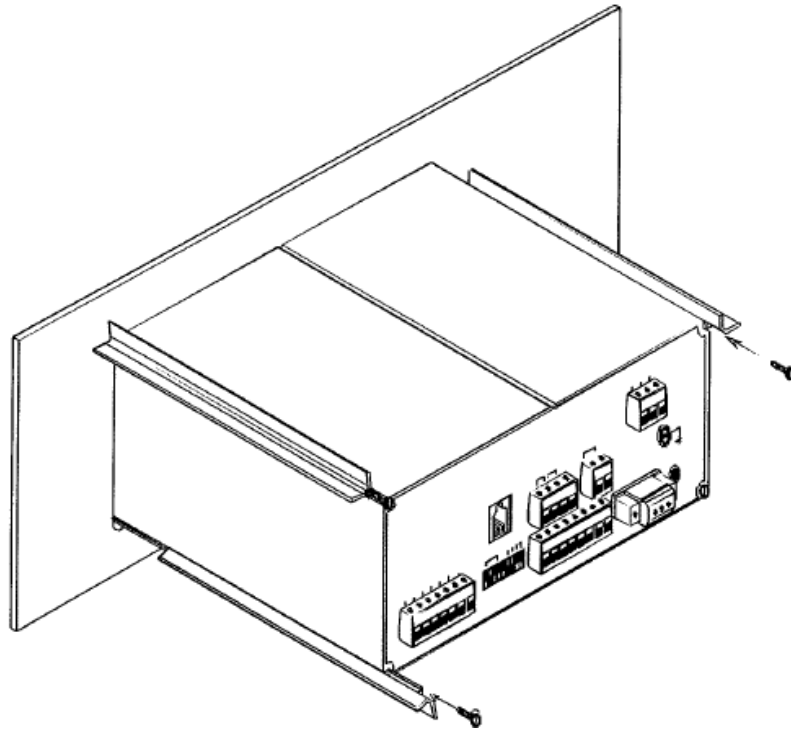

Figure 2-2. Display Console Panel Mounting Arrangements.

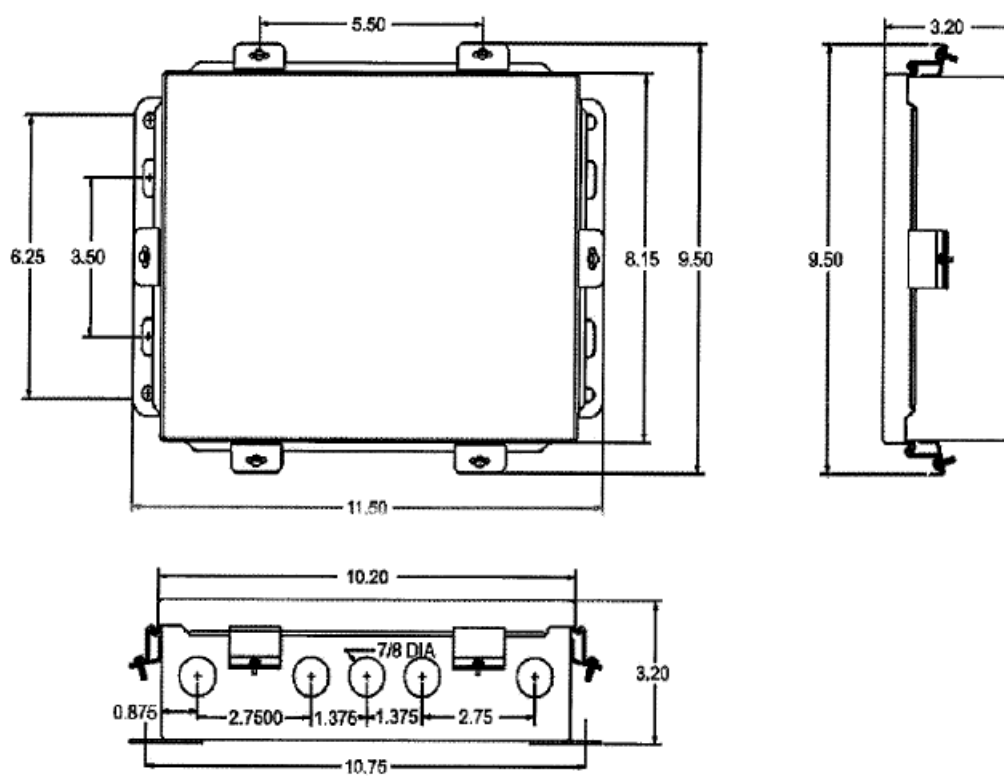

Figure 2-3. LCp-104 Smart Junction Box Outline Dimensions.

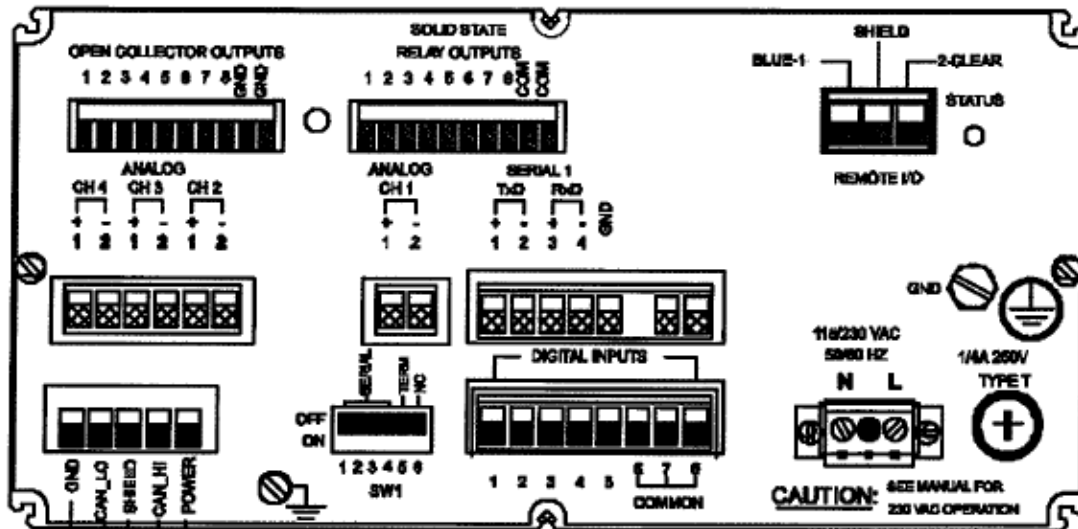

Figure 2-4. Display Console Rear Panel Electrical Connections - Remote I/O Option Shown.

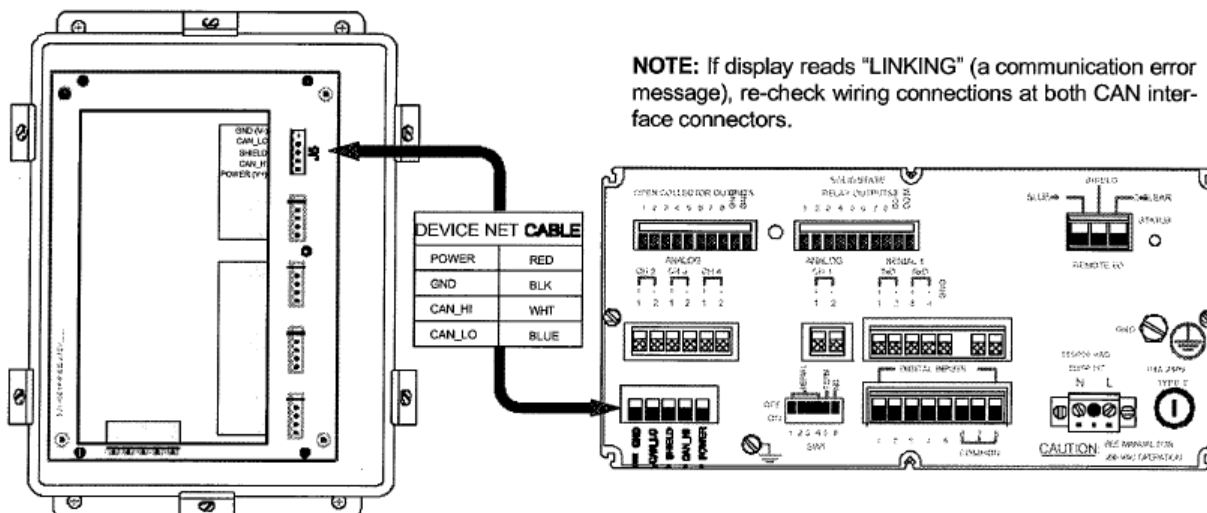

Figure 2-5. Display Console to Smart Junction Box Interconnect Wiring Diagram.

2.3.3 Transducer Signal Inputs

Transducer (load cell) input leads are wired directly to the Junction Box Circuit Board as shown in Figure 2-6. BLH load cells and junction box cables are shipped with pre-stripped, tinned leads so that leads need only be inserted in the proper terminal location, and the screw above tightened securely. Lead designations are clearly labeled for standard BLH color coded load cell cables.

2.3.4 Mains (ac) Power

LCp-104 Instruments are shipped ready to connect to 115 VAC (50 or 60 Hz) as shown in Figure 2-7. If requested, units will be factory configured for 220 VAC operation; otherwise, remove the rear panel and change the internal voltage selection switch as shown in Figure 2-8 (next page). Each instrument is protected with a 1/4 amp, 250 volt 'T' type fuse located adjacent to the ac power socket. If the fuse opens, replace it with the same type, current, and voltage rating.

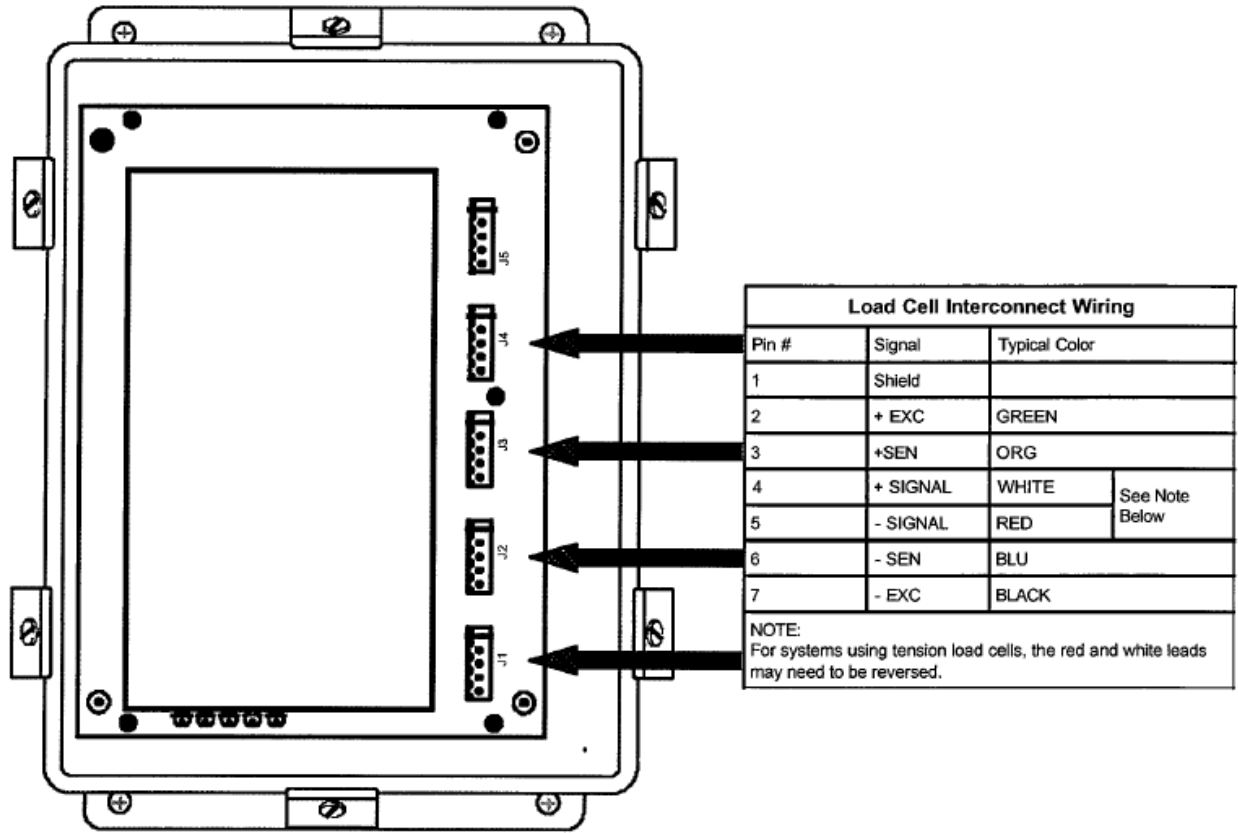

Figure 2-6. Load Cell Connection Designations.

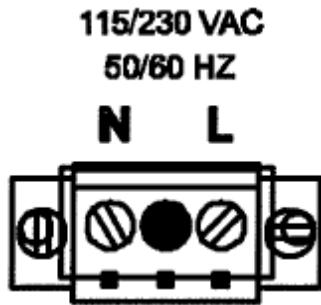

Figure 2-7. Ac 'Mains' Power Connection.

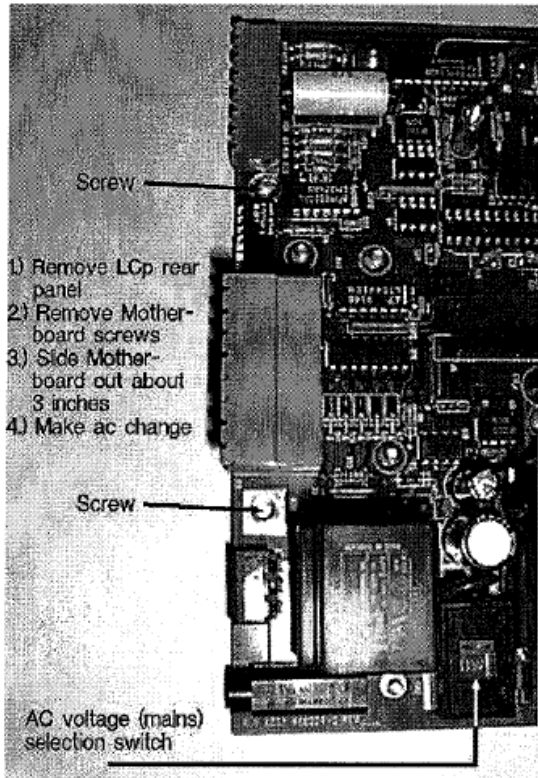

Figure 2-8. Ac Power Selection Switch.

2.3.5 Serial Communication

A 4-socket mating half connector is provided for serial communication wiring. Connect wires for either RS-485 or RS-422 operation as shown in Figure 2-9. Note that connector position 5 is a ground terminal and should be used for three-wire, RS-485 communication networks. Set DIP switch Si positions 1-4 for desired interface function (Figure 2-8). See Section VI for details concerning serial interfacing.

2.3.6 Analog Output (Option)

Analog current output is optional on LCP-104 instruments. Units are factory prepared for either 0-24 or 4- 20 mA operation, depending upon sales order instruction. Use the two-socket mating half terminal connector to attach plus and minus signal wires as shown in Figure 2-10. Route wires away from ac power lines and other EMI sources to prevent interference. Section 6 provides analog output configuration procedures.

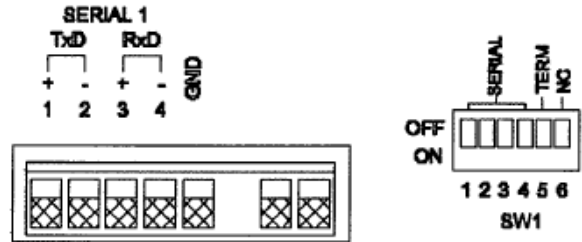

DIP SWITCH SETTING				
SW 1.1	SW 1.2	SW 1.4	SW 1.4	SERIAL FUNCTION
ON	OFF	OFF	OFF	422 MULTI-DROP
OFF	OFF	OFF	OFF	422 FULL DUPLEX
ON	ON	ON	ON	485 STANDARD
SW 1.5 TERMINATION RESISTOR				
ON RECEIVER TERMINATED 120 OHM				
OFF NO TERMINATION				
SW 1.6 UNUSED				

RS 422/ 485 COMMUNICATION			
PIN NO	SIGNAL NAME	SIGNAL	
		RS 422	RS 485
1	TxD+	TRANSMIT DATA +	NOT USED
2	TxD-	TRANSMIT DATA -	NOT USED
3	RxD+	RECEIVE DATA +	DATA +
4	RxD-	RECEIVE DATA -	DATA -
5	GND		

Figure 2-9. The Serial Communication Interface.

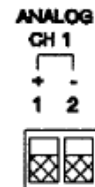

ANALOG OUTPUT OPTION /SINGLE/QUAD		
RANGE	LOAD RESISTANCE	NOTE: SWITCHES FOR 4-20 ARE FACTORY PRE-SET
4-20 MA	600 OHM	
0-24 MA	500 OHM	

Figure 2-10. Analog Output Configuration.

2.3.7 Digital (Remote) Inputs

Certain front panel key functions can be initiated remotely using the rear panel digital inputs. Figure 2-11 gives wiring designations for remote operation of the ZERO, TARE, Gross/Net (GN), and PRINT keys. Interconnecting wire/cable length should not exceed 50 feet. Route wires/cable away from ac power lines and other EMI sources to prevent interference.

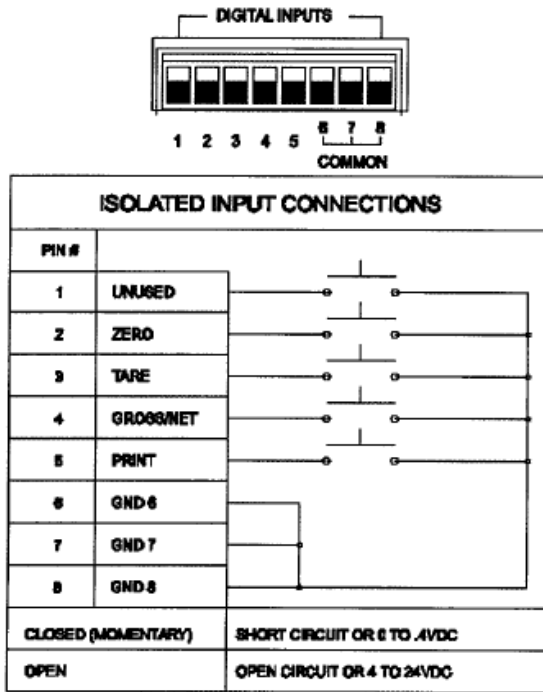

Figure 2-11. Remote Input Switch Configuration.

2.3.8 Open Collector Set point Outputs (Optional)

Units with eight open collector type set point outputs (optional) can be configured for main or dribble operation with in-flight compensation (see Section VI). Outputs are open collector type, capable of sinking 35 mA at 1.2 VDC. Wire set point outputs as shown in Figure 2-12.

OPEN COLLECTOR OUTPUTS

1 2 3 4 5 6 7 8 GND GND

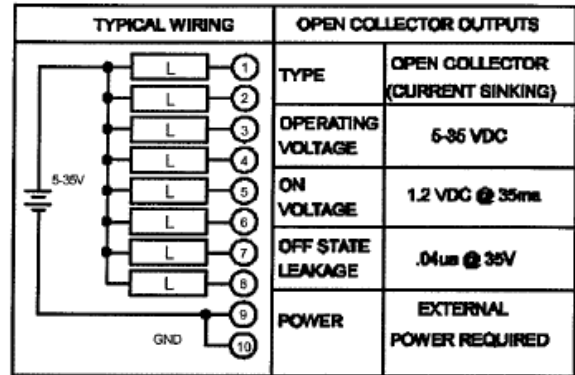
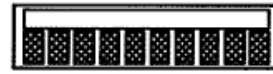

Figure 2-12. Open Collector Relay Wiring

2.3.9 Triac Set point Relay Outputs (Optional)

When installed, optional solid state triac outputs operate at 12 to 240 VAC and handle loads of 50 mA to 1 amp. Operationally, they are identical to the open collector set point outputs defined in paragraph 2.3.7. Wire outputs in accordance with Figure 2-13.

SOLID STATE RELAY OUTPUTS

1 2 3 4 5 6 7 8 COM COM

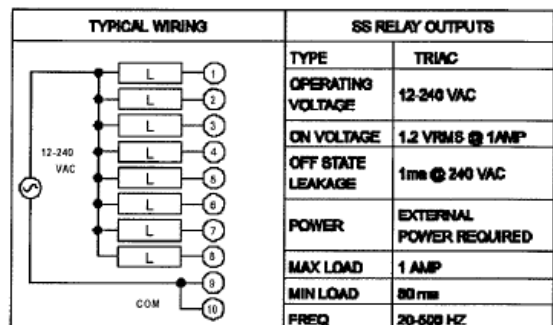

Figure 2-13. Triac Relay Wiring Arrangements.

2.3.10 Quad Analog Outputs

When option [P] [3] is ordered, instruments ship with four (quad) analog outputs. Wiring connection locations for these outputs are presented in Figure 2-14. See paragraph 6.1.1 for functional and configuration information.

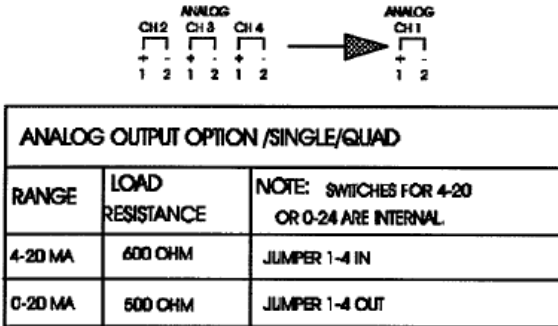

Figure 2-14. Quad Analog Wiring Arrangements.

2.4 SMART JUNCTION BOX LED'S

A series of five LED's (Figure 2-15) on the j-box pc board provide visual verification of communication and load cell wiring. These indicators are extremely useful for troubleshooting installation/start-up wiring problems.

2.4.1 Communication Status

The first of the five LED's, STAT, monitors the communication interface between the j-box and the console display. When communication between the two units is correctly established, this LED blinks on/off. If the LED is off, there is no communication link between the units. The off condition usually indicates a wiring error. When the units are attempting to establish a link, CH1 - CH4 LED's cycle through a sequential on/off pattern.

2.4.2 Load Cell Status Indication

When all system load cells (4 typical) are correctly wired, the CH1 - CH4 LED's are constantly illuminated (on). If any load cell LED is off, either the cell is not used (as in the case of a 3 cell system) or it is not connected correctly. If the LED is blinking (one second interval), the cell is functioning in degrade mode.

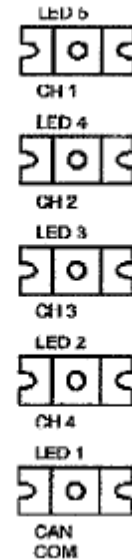

Figure 2-15. Smart Junction Box Internal LED's.

SECTION 3. Calibration

The Calibration main menu (CAL) consists of two functions; system calibration (CALIBRAT), and degrade mode (DEGRADE). To begin parameter entries, press the MENU key until CAL MENU is displayed. Press the 'down' arrow key for a display of CAL CALIBRAT.

3.1 SYSTEM CALIBRATION (CALIBRAT)

After installation, set-up and calibration are the next steps in preparing an LCp-104 system for operation (see main menu diagram, Figure 1-3). Setup and calibration parameters are established easily using the front panel display and eight configuration keys. Figure 3-1 (page 3-2) presents details for set-up parameter entry and Figure 3-2 (page 3-3) shows procedures for each calibration type.

3.2 SET-UP SYSTEM PARAMETERS

Set-up establishes system operating parameters such as system capacity, decimal point location, display units, count by, etc. Follow the flow diagram presented in Figure 3-1 to enter or alter set-up parameters.

3.2.1 Number of Load Cells

The first parameter entry requests the number of system load cells. Simply enter the number of 'live' system cells. Do not enter simulated ('dummy') cells. This value defines the system for the LCp-104 and will affect subsequent parameter entries as well as system performance.

3.2.2 Display Units

Designate the desired display units as pounds, kilograms, tons, ounces, grams, newtons, kilonewtons, liters, or blank (no units). Selection also appears on printouts and other serial communication transactions.

3.2.3 Decimal Point Location

Position the decimal point as desired for weight display and serial communication.

3.2.4 Capacity

Enter the full-scale system capacity value. (Capacity is the rated load of the load cell(s) or platform - not simply live load or gross weight.) A capacity of 10000 can be displayed as 0.010000, 0.10000, 1.0000, 10.000, 100.00, 1000.0, or 10000, depending upon decimal point location.

3.2.5 Output

Enter the rated mV/V output of the system. (The electrical output at rated capacity independent of excitation) The rated output of a multi-cell system is the average of the rated output of all the cells. For example: In a three-cell system with load cell rated outputs of 2.01, 2.05, and 1.95 mV/V, the average rated output is 2.003 mV/V.3

3.2.6 Front Panel Display Counts

Define the count value of each display increment by selecting 1, 2, 5, 10, 20, 50, or 100 (note that decimal selection still applies). Note that before the count value is selected, the LCp-104 will automatically attempt to achieve the best possible resolution.

3.3 SYSTEM CALIBRATION

LCp-104 systems offer three types of calibration; quick, deadload, and keypad. Both quick and keypad calibration use an internal mV/V reference within the LCp-104 to perform an electrical only type calibration.

Deadload type calibration is a method that is used when known amounts of weight are applied to the vessel or scale to achieve calibration. Figure 3-2 provides flow diagrams for each calibration type.

NOTE: All three methods of calibration provide a display of system deadload. This value is not configurable. It simply shows the amount of deadload (vessel and vessel appendage weight) permanently placed upon the load cells.

3.3.1 Quick Type Calibration

Quick calibration is the fastest and least complex method of calibration. Based upon entries of scale capacity and mV/V output, the LCp-104 will automatically interpolate system calibration. This method is generally suitable on any linear system that has minimal piping or other load shunting structures.

NOTE: To optimize quick calibration, enter a known zero reference value (from calibration sheet/certificate) for each individual cell.

3.3.2 Deadload Calibration

Deadload calibration is potentially the most complex method but results in the highest system accuracy. Deadload calibration requires that known quantities of weight be added incrementally to the scale/vessel, preferably to full capacity. This method is preferred on systems that have attached pipes or other load shunting structures.

Enter/Alter Set-Up Parameters

CAL CALIBRAT [ENT] Choose 1-4 Load Cells

4 [▲] [▼] No. CELLS

LB [▲] [▼] UNITS

500.00 [▲] [▼] DECIMAL

50000 [▲] [▼] CAPACITY

3.500000 [▲] [▼] OUTPUT

1 [▲] [▼] COUNT BY

SELECTIONS:
 LB (pounds)
 KG (kilograms)
 TN (tons)
 OZ (ounces)
 GM (grams)
 N (newtons)
 KN (kilonewtons)
 L (liters)
 (blank space)

SELECTIONS:
 Use EDIT, ▼, and then ENTER

ENTER NUMBER:
 0 to 9999999

SELECTIONS:
 12,5,10,20,
 50, or 100

SELECTIONS:
 Press to increment selected digit.
 Press to decrement selected digit.
 Press to advance to next digit.
 Press to return to previous digit.
 Press to store selection in memory.

General Key Functions:

- [▲] Step back to previous menu selection.
- [▼] Advance to next menu selection.
- [ENT] Advance to next main menu selection.
- [ESC] Return to live operation from menu.
- [ENT] Change sub menu parameters.
- [ENT] Store displayed sub menu parameter in memory.

To Enter/Alter a Numeric Value:

- [ENT] Press to initiate a change.
- [▲] [▼] Key in desired numeric value.

OR - In some cases -

- [▲] Press to increment selected digit.
- [▼] Press to decrement selected digit.
- [▶] Press to advance to next digit.
- [◀] Press to return to previous digit.
- [MEM] Press to store selection in memory.

To Enter/Alter a Parameter Selection:

- [ENT] Press to initiate a change.
- [▼] Press to view parameter options.
- [MEM] Press to store selection in memory.

[MAIN MENU] [SUB MENU]

Figure 3-1. Setup Parameter Entries.

Calibration Type - Flow Diagrams

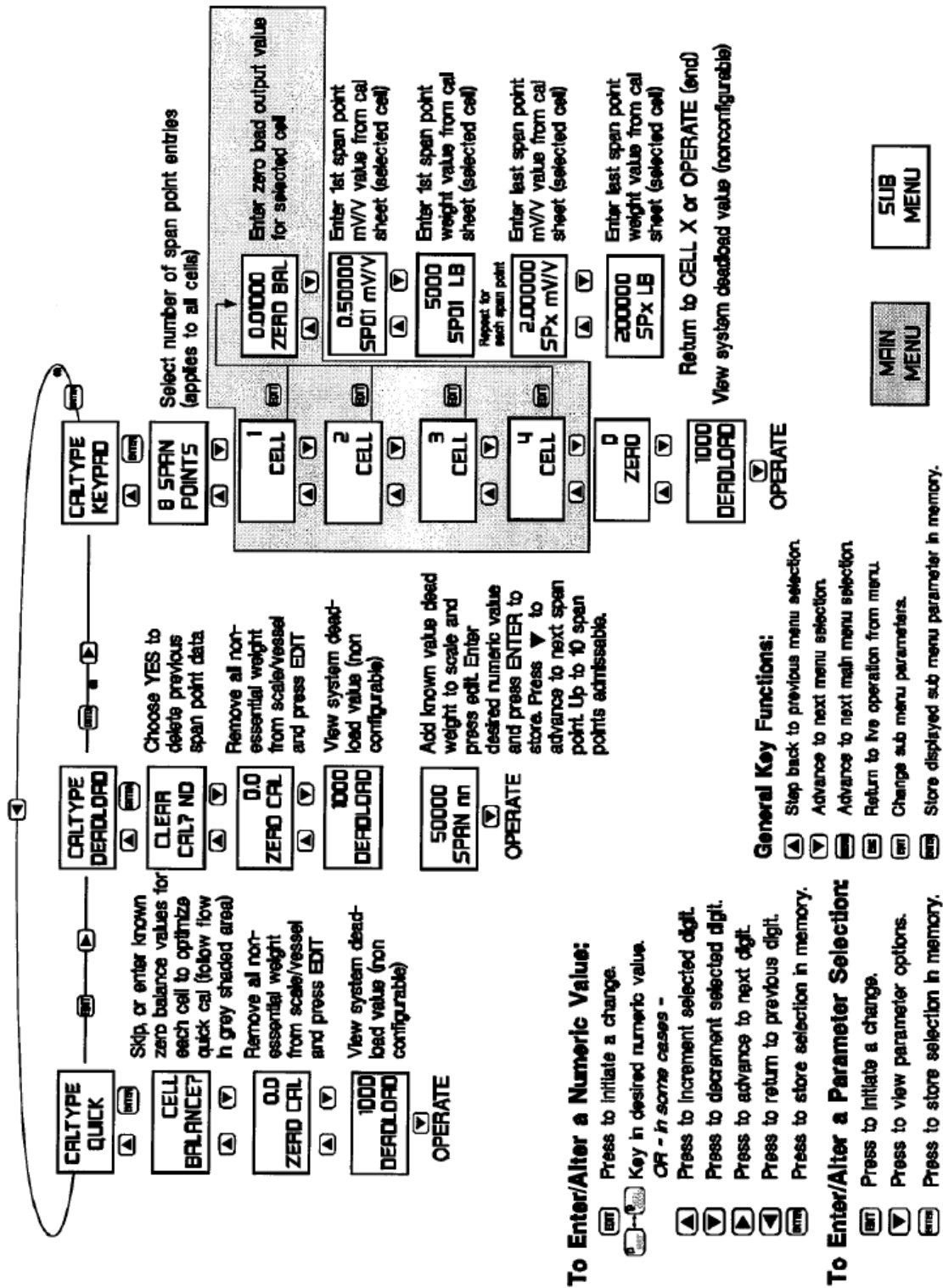

To Enter/Alter a Numeric Value:

- (↵) Press to initiate a change.
- (▲) (▼) Key in desired numeric value.
- (◀) (▶) CR - in some cases -
- (▲) Press to increment selected digit.
- (▼) Press to decrement selected digit.
- (▶) Press to advance to next digit.
- (◀) Press to return to previous digit.
- (↵) Press to store selection in memory.

To Enter/Alter a Parameter Selection:

- (↵) Press to initiate a change.
- (▲) (▼) Press to view parameter options.
- (↵) Press to store selection in memory.

General Key Functions:

- (▲) (▼) Step back to previous menu selection.
- (▶) (◀) Advance to next menu selection.
- (↵) Advance to next main menu selection.
- (↵) Return to live operation from menu.
- (↵) Change sub menu parameters.
- (↵) Store displayed sub menu parameter in memory.

Figure 3-2. Calibration Methods and Procedures.

3.3.3 Keypad Calibration

LCp-104 instruments are factory calibrated with a very precise mV/V measurement device. The keypad calibration method establishes a relationship between force and mV/V, resulting in an extremely accurate electrical type of calibration. Keypad calibration allows entry of known zero balance and span point mV/V values. These values are typically obtained from a factory issued calibration sheet or certificate (each load cell must have its own sheet).

Keypad calibration allows for the entry of zero balance and up to 10 span points. On multi-cell systems, zero balance and span points must be entered for each individual load cell (up to 4). This method is applicable on systems with minimal piping or other load shunting structures and can be used to correct for load cell nonlinearities.

3.4 DEGRADE MODE FUNCTION

Degrade mode selection is the next main menu (CAL) selection. If a diagnostic test identifies one or more load cells in the system as providing faulty data, it is possible using degrade mode operation to eliminate the erroneous data from the errant cell(s) and continue operating while the cell(s) is repaired or replaced. Since the LCp-104 measures each channel independently and digitally sums the weight information, degraded mode operation shuts off the actual measurement from the suspect channel(s) and uses a calculated digital substitute value, corrected for system balance and channel sensitivity. The resulting system performance will be reduced somewhat but will still be compensated for load imbalance. This mode of operation makes it possible to continue weigh system operation with minimal interruption.

To activate degraded mode operation it is necessary to shutoff the suspect channel (cell) using the Cell ON/ OFF selection (Figure 3-3) accessed via the keypad. It is not possible to automatically activate this mode internally or remotely through the serial port.

Prior to degrade mode operation a degrade mode reference must be established. This reference profiles individual cell characteristics for use in future degrade mode operation. To enter the reference point, perform the following:

1. Calibrate the system and acquire a system deadload zero (mV/V calibration also must acquire deadload zero).
2. Load system to at least 20% of full scale capacity.
3. Proceed to the Degrade Set-up Menu (Figure 3-3) and make sure all cells are 'ON'.
4. With a display of REF MV/V, press EDIT to enter a reference value. Then press ESC to return to the calibration main menu.

NOTE: When degrade mode is operational, a message will scroll across the console display at regular intervals.

NOTE: Degrade mode cannot be implemented remotely using the serial interface or digital inputs.

NOTE: For proper degrade mode function, the scale center of gravity must remain the same.

NOTE: To enter a degrade mode reference point, all cells must be functional, turned 'On', and the system must be loaded to at least 20% of total capacity.

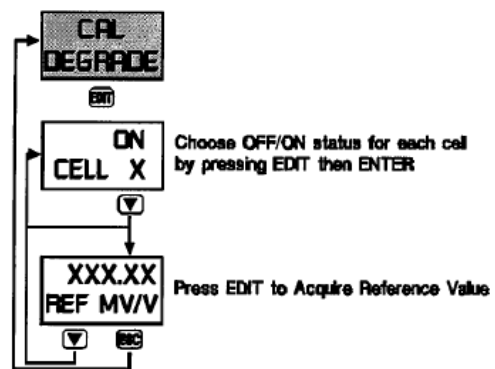

Figure 3-3. Degrade Mode Operation.

SECTION 4. Dynamic Digital Filter

4.1 GENERAL

The LCp-104 uses a two stage digital filter. Each stage requires parameter entries as shown in Figure 4-1 (next page). Also required is selection for the conversion speed of the analog to digital signal which will affect filter length time (response). Make parameter entries while viewing live weight changes on the front panel display. This unique feature allows editing of parameters to 'fine tune' precision settings.

4.1.1 Digital Averaging

The filter first stage calculates a running average of weight input readings. Available selections are OFF, and 1 - 12 (see Figure 4-1). With averaging OFF, the response time will be maximum, and noise reduction will be least. With higher settings, response time increases and noise levels are diminished.

Using a 'first in - first out' algorithm, running averaging provides display updates every 50 msec regardless of the number of readings averaged. However, since each conversion averaged adds 50 msec to the filter length, the larger the averaging selection, the longer the filter length becomes.

4.1.2 Band Selection

The second stage of the filter, BAND, is applied after averaging is selected. A BAND value between 0 and 100 must be entered as shown in Figure 4-1. Dynamic Digital Filtering constantly compares the amount of input signal change between consecutive conversions. If the differences for all cells fall within the BAND setting, a mathematical filter attenuates the conversion-to-conversion variation. Once the difference for any cell (between conversions) exceeds the BAND selection, the BAND filter is canceled and the display tracks live weight with maximum response. To achieve the best overall filter response, keep the BAND selection as low as possible without hindering system performance (see next paragraph for set-up instructions). If the BAND setting is higher than necessary, sensitivity to small weight changes will be reduced.

4.1.3 Conversion Selection

Conversion speed selection plays a role in filtering. If the conversion speed is decreased, the length of the filter response time will be longer. When adjusting filter parameters, try slower conversion speeds first since they usually generate less noise. If, however, the response time is not appropriate, then increase the conversion rate and repeat filter procedure.



4.1.4 Filter Set-Up Procedures



Setting filter parameters requires a balance between achieving maximum noise reduction and maintaining quick response and good sensitivity to real weight changes. The goal of filter set-up is to use the lowest averaging and BAND selections needed for smooth system display/operation. If selections are higher than necessary, accurate detection of small weight changes may be hindered. Using the six steps presented below, tune the system to its maximum performance level.



1. Begin with the BAND set at a low value (approx. 4-10).
2. Increase averaging until the noise (watch display) is reduced to the least significant digit (approx. +/- 10 divisions).
3. Increase BAND, if necessary, to reduce the remaining noise to the desired level.
4. If increasing the BAND value does not reduce the noise, return to averaging and select the next higher setting, then repeat step three.
5. If the BAND value required to quiet the display becomes large (65-100), it may be better to use more averaging. Try to achieve the best balance between BAND (small weight change sensitivity reduction) and averaging (longer response time).
6. If a stable weight display cannot be achieved with reasonable selections, it may be necessary to change the instrument set-up to reduce sensitivity.



Enter/Alter Set-Up Parameters



CAL CALIBRAT 



4
No. CELLS  

LB
UNITS  

500.00
DECIMAL  

50000
CAPACITY  

3.500000
OUTPUT  

1
COUNT BY  

Continue to Figure 3-2

Select the Number of System Load Cells (1-4) Choose 1-4 Load Cells

Choose Display/Printout Unit Type

Locate Display/Printout Decimal Point

Enter Full Scale Capacity









Enter Scale Output Enter Rated mV/V output of system (numeric value)



SELECTIONS:
12.5, 10, 20,
50, or 100







SELECTIONS:
LB (pounds)
KG (kilograms)
TN (tons)
OZ (ounces)
GM (grams)
N (newtons)
KN (kilonewtons)
L (liters)
(blank space)

SELECTIONS:
Use EDIT,
▼, and then
ENTER

ENTER NUMBER:
0 to
9,999,999

To Enter/Alter a Numeric Value:
 Press to initiate a change.
  Key in desired numeric value.
CR - in some cases -
 Press to increment selected digit.
 Press to decrement selected digit.
 Press to advance to next digit.
 Press to return to previous digit.
 Press to store selection in memory.

To Enter/Alter a Parameter Selection:
 Press to initiate a change.
 Press to view parameter options.
 Press to store selection in memory.

General Key Functions:
 Step back to previous menu selection.
 Advance to next menu selection.
 Advance to next main menu selection.
 Return to live operation from menu.
 Change sub menu parameters.
 Store displayed sub menu parameter in memory.

MFIN MENU **SUB MENU**

Figure 4-1. Filter Parameter Selections.

SECTION 5. Front Panel Display Functions

5.1 FRONT PANEL FUNCTIONS

The front panel display of the LCp-104 (Figure 5-1) includes a two-line alpha numeric digital display for weight and status information as well as horizontal and vertical bar graphs and diagnostic alarm annunciators. The bar graphs and alarm annunciators can be used for several different functions as defined in the following paragraphs. Use the display menu flow diagram (Figure 5-2) to configure the front panel functions for desired system operation.

5.1.1 Horizontal Bar Graph

The horizontal bar graph is considered the primary level indicator and is typically used to monitor the overall gross weight contents of the scale vessel. Vacuum fluorescent segments located under the 0 to 100% bar graph give instant visual reference to system capacity. Select ON to use; OFF for no function. Choose net, gross, or rate-by-weight tracking and then enter the starting and ending weight values. Note that this indicator also can be configured for reverse polarity depending upon the starting and ending values.

5.1.2 Vertical Bar Graph

The vertical bar graph is considered the secondary level indicator and is typically used to monitor net weight. Located to the right of the weight display area, this indicator provides a graphical representation of 0 to 100% in 10% increments (each arrow = 10% capacity). Select ON to use;

OFF for no function. Choose net, gross, or rate-by-weight tracking and then enter the starting and ending weight values. Note that this indicator also can be configured for reverse polarity depending upon the starting and ending values.

5.1.3 Alarm Status Annunciators

Eight front panel alarm/status annunciators provide ongoing system diagnostic information. Each annunciator can be configured to represent 1 of 11 conditions; OFF (no function), system in motion, zero limit exceeded, overload limit exceeded, serial communication receive, serial communication transmit, serial communication parity error, serial framing error, analog output fault, analog output over high selection, analog output under low selection, Allen-Bradley Remote I/O (option) status, modem receive active, modem transmit active, or Modbus Plus status. Once configured as A1-A8, vacuum fluorescent segments will be illuminated when configured condition is true. Configure each annunciator consecutively as shown in Figure 5-2.

5.1.4 Configuring the TARE Key

The front panel TARE key can be configured for manual or automatic operation. If 'automatic' is selected and the unit is operating in net mode, the displayed weight value will be zeroed resulting in a display of zero (units) net. If manual is selected and the unit is operating in net mode, the operator will be prompted to enter the desired tare weight value. TARE has no affect on the gross weight.

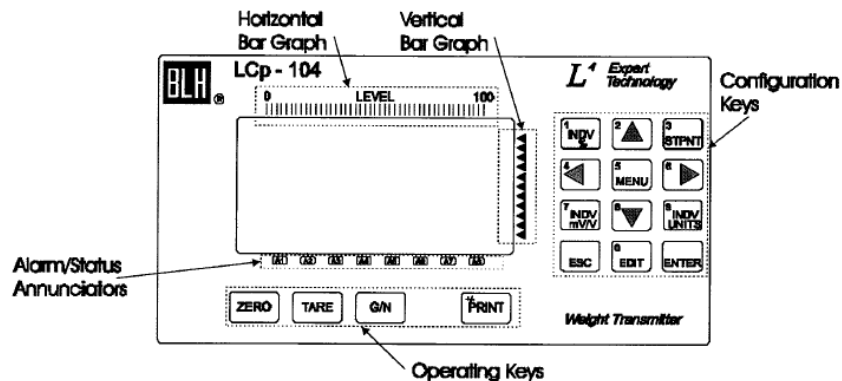

Figure 5-1. LCp-104 Front Panel Functions.

Display Menu Flow Diagram

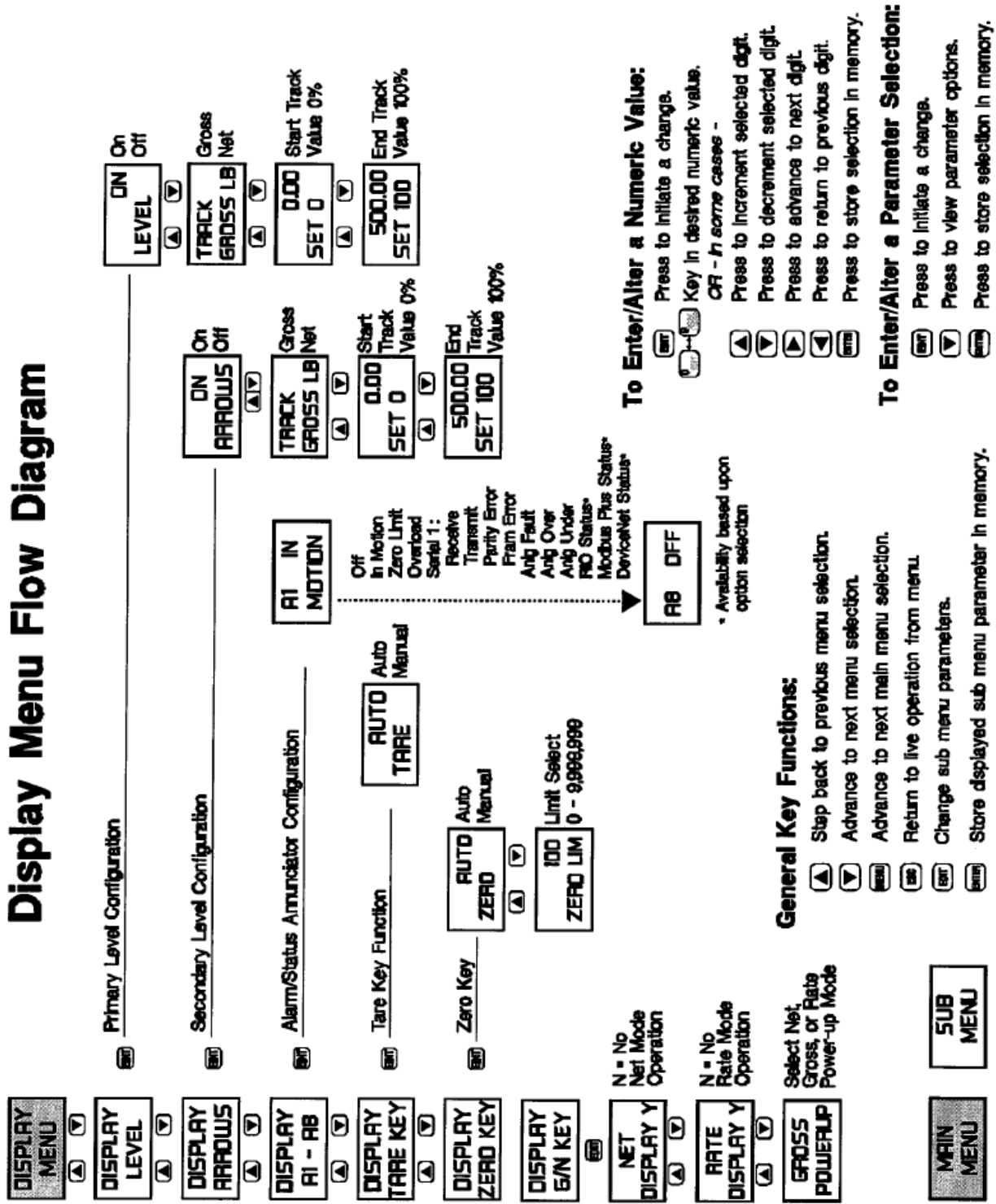

Figure 5-2. LCp-104 Front Panel Function Configuration Menu.

5.1.5 Configuring the ZERO Key

The front panel ZERO key can be configured for manual or automatic operation. If 'automatic' is selected, the displayed gross weight value will be zeroed out when the key is pressed. If manual is selected, the operator will be prompted to enter the desired gross zero weight value.

A full scale limit selection also must be entered for the zero key. Enter a zero limit value between scale zero and full scale capacity (recommended 2-20%). The zero key will not function automatically or manually after the displayed weight value has reached the zero limit entry.

5.1.6 The Gross/Net Key

The GIN (gross/net/rate) key typically toggles the system between its three modes of operation (see SECTION 9) when pressed. Menu configuration allows net and rate modes to be deselected (N = no for net or rate modes of operation) if desired. If net and rate modes are turned off, the instrument will display only gross weight data at all times; otherwise, the key will toggle between all operational modes.

A second selection determines the power-up mode of operation. Select GROSS, NET, or RATE to establish the default power-up mode.

NOTE: If net and/or rate modes are deselected, they cannot be designated for power-up default.

SECTION 6. Process Outputs

6.1 ANALOG OUTPUT(S) (Optional)

6.1.1 Output Definition

LCp-104 systems provide up to four high-resolution analog current outputs representing either gross, net, or rate-by-weight, for driving external process equipment/recorders. Units are configured for either 4-20 or 0-20 mA operation (note: 100 ohm load resistance reduction with 0-20 mA) depending upon sales order instructions. Output(s) is based upon a 16-bit digital to analog (D-A) conversion which represents up to one part in 65536 of analog precision. Output scaling is performed after calibration and can be ranged for any portion of the gross, net, or rate output curve.

Systems using the analog output for level control usually configure the output to track gross weight (live product weight). Batch control systems that use weight as a variable to determine set point cut-offs can be configured to operate in the net weighing mode while using a discrete remote input to activate the tare function.

6.1.2 Set-Up Procedure

Connect a current meter to the rear panel analog output points (see Figure 2-10 for +, - designations) and proceed with ANALOG I/O configuration as shown in Figure 6-1 (next page).

6.2 SERIAL COMMUNICATION

LCp-104 units come with a versatile, bi-directional, serial communication port. Electronically, this port can be configured for RS-422 multi-drop (loop), RS-422 full duplex (point-to-point, transmit/receive), or RS-485 half duplex (point-to-point, transmit then receive) operation. Selection is made via rear panel DIP switch positions 1-4 (see Figure 2-9).

After selecting the electrical interface, the port operating parameters must be entered using the flow diagram presented in Figure 6-1. Figure 6-2 (page 6-3) provides a full description of each (serial communication) parameter block depicted in Figure 6-1. Note that certain parameter entries are dependent upon the print format selection

(accessed by pressing edit when SERIAL I/O is displayed). Standard indicators offer 3 formats; PRINT for output to a printer, CON'T (continuous) for constant output to a data logger, PLC, etc., and PC for full duplex interfacing with a more sophisticated host device. MODBUS RTU, Modbus Plus, Profibus, Allen-Bradley Remote I/O, and DeviceNet options are defined in later Sections of this manual.

6.2.1 Transmit Only Output Formats (ASCII)

Both the PRINT and CON'T ASCII output formats are 'transmit' only. The print format is designed for use in conjunction with the front panel PRINT key. Pressing the PRINT key transmits all data strings that are selected 'YES' in Figure 6-1 (DISPLAY, GROSS, NET, ZERO, and TARE) to the printer. Table 6-1 shows the printer output format used for each transmitted data string.

Table 6-1. The Printer Output Format

Printer Output String Format	
String Format: stx~adr~data~units~status~crlf	
Command	Definition
stx	start of text character, hex 02
adr	address; 3 ASCII characters: first 2 are '01'-'99' followed by an ASCII space
data	weigh data 8 characters: 7 digits with decimal point or leading space; if msd is an ASCII minus '-', the data is negative
abbreviated units	two characters; first character is 'L','K','T','Z','G','N','K','L','S' or 'spaces' for pounds, kilograms, tons, ounces, grams, newtons, kilonewtons, liters, special, or null (space). second character is 'G','N','Z' or 'T' for gross, net, zero, or tare
expanded units	ten characters; first three characters are a space plus a two character units abbreviation 'LB','KG','TN','OZ','GM','N','KN','L', or 4 spaces for pounds, kilograms, tons, ounces, grams, newtons, kilonewtons, liters, or 4 user defined characters. the last seven characters are a space plus the data type spelled out with added spaces 'GROSS','NET','ZERO', or 'TARE'.
stat	one status character: '=' everything ok, 'M' = motion, 'U' = a/d underload (signal below instrument capability) 'V' = above overload limit, 'O' = a/d overload (signal beyond instrument capability), 'E' = load cell connect fault
space	ASCII space, hex 20
crlf	carriage return linefeed two characters ODH OAH
Character Format (bits): 1 start, 1 even parity, 7 data, and 1 stop	

Analog, Serial, and Setpoint Output Flow Diagram

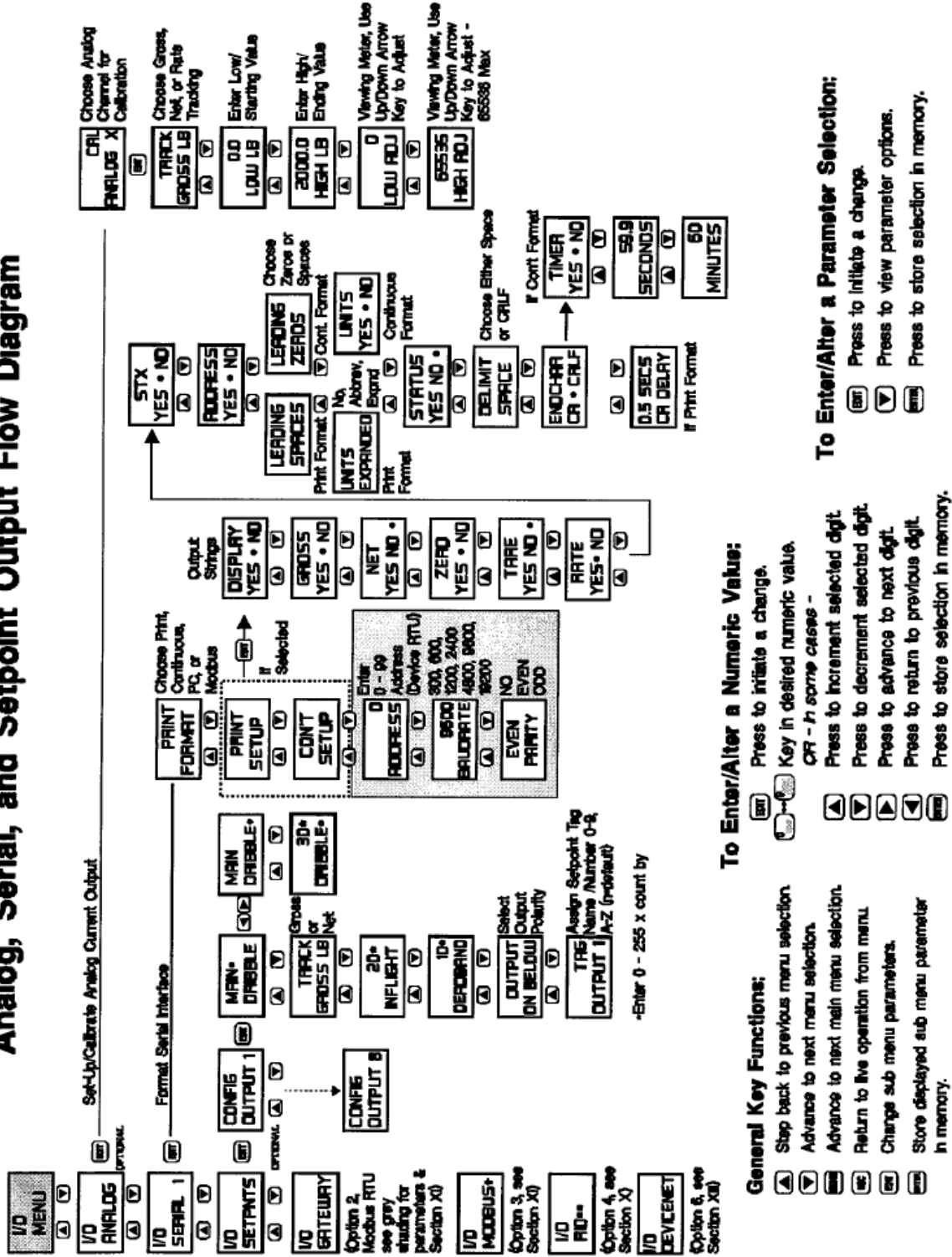

Figure 6-1. Analog and Serial Communication Parameter Entries.

Serial Output Flow Diagram Block Explanations

DISPLAY YES • NO	Transmit current weight display (gross or net)	STX YES • NO	Typical leading character of any ASCII output data string
GROSS YES • NO	Transmit current gross weight value	ADDRESS YES • NO	Include designated address in output data string
NET YES • NO	Transmit current net weight value	LEADING SPACES	Choose either leading spaces or leading zeros in output string
ZERO YES • NO	Transmit current manual zero value	UNITS EXPANDED	Choose either no units, abbreviated units (2 characters), or expanded (10 character) units in printout
TARE YES • NO	Transmit current manual tare value	UNITS YES • NO	Include units in transmit string; units are abbreviated (2 characters)
		STATUS YES • NO	Include status character in output string
		DELIMIT SPACE	If more than one data selection (i.e. gross, net, tare) is requested, chose either a space or a carriage return/line feed (CRLF) to separate them
		ENDCHAR CR CRLF	Choose either a carriage return (CR) or a carriage return/line feed (CRLF) to end the output string
		0.5 SECS CR DELAY	If the printer does not have a character buffer, prevent data loss by selecting a delay time between carriage returns
		TIMER YES • NO	Choose whether or not to use a timed interval between continuous transmissions
		59.9 SECONDS	If YES chosen, select seconds portion of time interval
		60 MINUTES	If YES chosen, select minutes portion of time interval
		BOTH FORMATS	
		CONTINUOUS OUTPUT FORMAT	
		PRINTER OUTPUT FORMAT	

Figure 6-2. Definition of Serial Communication Terms.

The CONT output string is defined in Table 6-2. Continuous output transmissions occur at the time rate selected in Figure 6-1. Continuous outputs 'feed' weight data, status, and address information to a remote data logger or PLC type device without operator intervention.

Output string formats can be modified to accommodate custom interface requirements (Figure 6-1). Leading zeros can be replaced with ASCII spaces. STX (start of text), address, and instrument status can be omitted by selecting 'NO'. Units can be expanded or abbreviated in the print format and dropped altogether from the continuous format. Line feed can be deleted from the CRLF output or both characters can be replaced by an ASCII space. Figure 6-2 provides definitions for each parameter to assist in formatting custom output strings.

6.2.2 Full/Half Duplex Bi-Directional Interface

If PC output format is selected, units are capable of transmitting and receiving ASCII data strings. Table 6-3 (page 6-5) presents digit for digit data and syntax information for this interface.

Basically, the LCp-104 has 92 internal (EEPROM) registers that store all calibration, configuration, operation, and live weight data parameters. The PC format allows data in these registers to be read or re-written. By re-writing calibration span points (keypad type calibration) and operating parameters, LCp-104 systems can be quickly and completely reconfigured by a remote host device.

Note: Downloading data to the Model LCp-104 is accomplished by sending a 3 character command, the data enclosed in brackets <>, and a carriage return as shown in Table 6-3. The response will be staggered depending upon the time it takes to store the data. First the command will be resumed and then after the data is stored the CRLF (carriage return/line feed) or next command will be returned.

Several additional tables are provided to explain PC interfacing. Table 6-4 (page 6-7) provides

examples of EEPROM reading/writing, and error code exchanges. Table 6-5 (page 6-8) demonstrates live weight transactions.

Table 6-2. The Continuous Output Format.

Continuous Output String Format	
String Format: stx~adr~data~units~status~crlf	
Command	Definition
stx	start of text character, hex 02
adr	address; 3 ASCII characters: first 2 are '01'-'99' followed by an ASCII space
data	weigh data 8 characters: 7 digits with decimal point or leading space; if msd is an ASCII minus '-', the data is negative
units	two characters; first character is 'L','K','T','Z','G','N','K','L','S'; or 'spaces' for pounds, kilograms, tons, ounces, grams, newtons, kilonewtons, liters, special, or null (space). second character is 'G','N','Z',or 'T' for gross, net, zero, or tare
stat	one status character: "=" everything ok, 'M'= motion, 'U' = a/d underload (signal below instrument capability) 'V' = above overload limit, 'O' = a/d overload (signal beyond instrument capability), 'E' = load cell connect fault
space	ASCII space, hex 20
crlf	carriage return linefeed two characters ODH OAH
Character Format (bits): 1 start, 1 even parity, 7 data, and 1 stop	

6.3 SETPOINT CONFIGURATION

Model LCp-104 controllers provide eight outputs for set point operation. Standard units offer open collector/TTL signals at the rear panel connector. Optionally, triac-based analog outputs may be ordered. In either case, the output signals are identical, based upon configuration selections presented in Figure 6-1. Following the flow diagram to select main or dribble function for each output used. Also, select the polarity (valve 'ON' above or below set point) and a tag description (name) for each set point.

6.3.1 Main Set point Function and Selections

Main corresponds to a fast (coarse) or high speed input. To avoid over-filling in fast mode, enter an INFLIGHT value which corresponds to ingredient weight that will fall into the process

vessel after valve closure. To make sure the valve does not reopen, enter a DEADBAND (hysteresis) value. After vessel motion ceases, the Model LCp-104 checks vessel weight against the main set point value (entered via the front panel STPNT key). If vessel weight is less than the set point value minus the total inflight and deadband values, the Model LCp-104 will signal the valve to reopen; otherwise, the main set point is complete. Set point polarity (i.e. valve on below or above selected value) can be configured for each main set point. The TAG selection allows each main set point to be designated by an alphanumeric name or number. Tag designations are communicated through the PC and PLC interfaces to a host device.

NOTE: Set point relays always "OPEN" when an error condition is detected regardless of polarity selection.

6.3.2 Entering/Altering Main Set points

Main set point values may be entered/alterd at any time by pressing the front panel STPNT key. Use the procedure shown in Figure 6-3 to enter/alter main set points.

6.3.3 Dribble Set point Function and Selection

Many high resolution process systems have two speeds (or two valves) for ingredient filling.

Dribble represents the slow, (fine) precision, fill mode. Select a value that allows ample time for the system to switch from main to dribble (dribble value is subtracted from the main value) and achieve a highly accurate final fill.

Dribble values can only be entered/alterd during configuration. After designating a set point for dribble function, the value must be entered immediately. Enter a whole number dribble set point value (i.e. 1000 lb).

NOTE: Dribble set point values cannot be entered/alterd using the front panel STPNT key. Dribble set points are skipped over by the STPNT key.

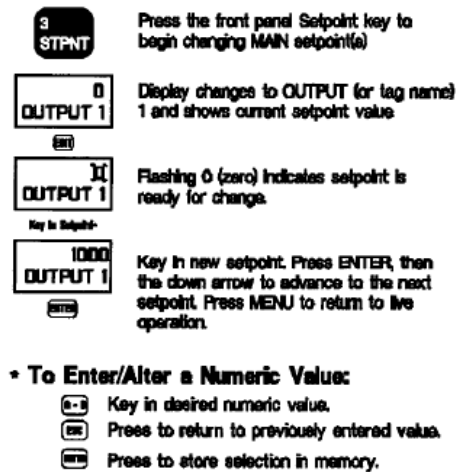

Figure 6-3. Entering and Altering Main Set Points.

Table 6-3. PC Interface Register Allocations.

LCp-104 PC Interface Register Allocations: Please Read Notes Below			
Code	Definition	LCp Response	Explanation
00	NA		NA = unused (spare)
01;	Serial #	01<1234567>	1 = year, 2-3 = week, 4-7 = instrument number
02;	Ref Date	02<mmddyy>	month-day-year of next due mV/V cal
03;	Analog 2 Low	03* <00000000>	low output weight selection
04;	Analog 2 High	04* <00000000>	high output weight selection
05;	Analog 2 Low Adjust	05* <xxxxx>	low analog output adjustment
06;	Analog 2 High Adjust	06* <xxxxx>	high analog output adjustment
07;	Analog 3 Low	07* <00000000>	low output weight selection
08;	Analog 3 High	08* <00000000>	high output weight selection
09;	Analog 3 Low Adjust	09* <xxxxx>	low analog output adjustment
10;	Analog 3 High Adjust	10* <xxxxx>	high analog output adjustment
11;	Analog 4 Low	11* <00000000>	low output weight selection
12;	Analog 4 High	12* <00000000>	high output weight selection
13;	Analog 4 Low Adjust	13* <xxxxx>	low analog output adjustment
14;	Analog 4 High Adjust	14* <xxxxx>	high analog output adjustment
15-34	NA		
35;	Level Config	35<x>	horizontal bar graph configuration: 0 = off/gross, 1 = on/gross, 2 = off/net, 3 = on/net
36;	Level 0%	36<00000000>	level 0% selection
37;	Level 100%	37<00000000>	level 100% selection
38;	Arrows Config	38 <x>	vertical bar graph configuration: 0 = off/gross, 1 = on/gross, 2 = off/net, 3 = on/net
39;	Arrows 0%	39 <00000000>	vertical bar graph 0% value
40;	Arrows 100%	40 <00000000>	vertical bar graph 100% value
41;	Annunciator A1	41 <xx>	annunciator status selections range from 0-15 where: 0 = off, 1 = in motion, 2 = zero limit, 3 = overload, 4 = ser1 rx, 5 = ser1 tx, 6 = ser1 parity error, 7 = ser1 framing error, 8 = analog fault, 9 = analog over, 10 = analog under, 11 = RIO status, 12 = spare, 13 = spare, 14 = setpoints, 15 = Modbus Plus status
42;	Annunciator A2	42 <xx>	
43;	Annunciator A3	43 <xx>	
44;	Annunciator A4	44 <xx>	
45;	Annunciator A5	45 <xx>	
46;	Annunciator A6	46 <xx>	
47;	Annunciator A7	47 <xx>	
48;	Annunciator A8	48 <xx>	
49;	Zero Key Config	49 <x>	0 = auto zero, 1 = manual zero
50;	Tare Key Config	50 <x>	0 = auto tare, 1 = manual tare
51;	NA		
52;	Analog Low	52 <00000000>	low output weight selection
53;	Analog High	53 <00000000>	high output weight selection
54;	Analog Low Adjust	54 <xxxxx>	low analog output adjustment
55;	Analog High Adjust	55 <xxxxx>	high analog output adjustment
56-61	NA		
62;	Security Lock	62 <x>	0 = lock ON, 1 = lock OFF
63;	Password	63 <AAAAAA>	security password: 1-0, '-', 'A-Z'
64;	Menu Locks	64 <xxxxx>	0 = off, 1 = on: msd-lsd (bit map) = spare, diagnostics, I/O, display, filter, calibration
65;	Key Locks	65 <xxxxx>	0 = off, 1 = on: msd-lsd (bit map) = edit, print, gross/net, tare, zero
66;	Serial 1 Format	66 <x>	0 = print, 1 = continuous, 2 = pc, 3 = Modbus RTU
67;	Serial 1 Address	67 <x>	0 - 99
68;	Serial 1 Baud Rate	68 <x>	0 = 9600, 1 = 19200, 2 = 300, 3 = 600, 4 = 1200, 5 = 2400, 6 = 4800
69;	Serial 1 Parity	69 <x>	0 = none, 1 = even, 2 = odd
70;	Print Data	70 <xxxxx>	0 = off, 1 = on: msd-lsd (bit map) = spare, tare, zero, net, gross, display

* These registers functional only when the quad analog option [P] [3] is installed, otherwise they are NA

Table 6-3. con't. PC Interface Register Allocations.

LCp-104 PC Interface Register Allocations: Please Read Notes Below			
Code	Definition	LCp Response	Explanation
71;	Print Data Format	71 <xxxxxxx>	1sd = stx (0/1 = no/yes), 2sd = address (0/1 = no/yes), 3sd = leading zeros (0 = spaces, 1 = zeros), 4sd = units (0 = no, 1 = abbreviated, 2 = expanded), 5sd = status (0/1 = no/yes), 6sd = delimiter (0 = space, 1 = carriage return/line feed), 7sd = end character (0 = carriage return/line feed, 1 = carriage return)
72;	Print CRLF Delay	72 <x.x>	0.0 to 9.9 second carriage return/line feed delay time
73;	Continuous Data	73 <xxxxx>	0 = off, 1 = on: msd-lsd (bit map) = spare, tare, zero, net, gross, display
74;	Cont. Data Format	74 <xxxxxxxx>	1sd = stx (0/1 = no/yes), 2sd = address (0/1 = no/yes), 3sd = leading zeros (0 = spaces, 1 = zeros), 4sd = units (0/1 = no/yes), 5sd = status (0/1 = no/yes), 6sd = delimiter (0 = space, 1 = carriage return/line feed), 7sd = end character (0 = carriage return/line feed, 1 = carriage return), 8sd = timer (0/1 = no/yes)
75;	Continuous TX Timer	75 <xx.x>	00.0 to 59.9 seconds
76;	Continuous TX Timer	76 <xxx>	0 - 240 minutes
77;	Tag Number/ID	77 <AAAAAAA>	customer assigned tag number: 1-0, '.', 'A-Z'
78 - 90	NA		
91;	G/N Key Configuration	91 <xxx>	1sd = display powerup (0 = gross, 1 = net), 2sd = net display (0/1 = no/yes)
92	NA		
VER	Software Version	VER <x.xx>	read only, identify software version 1.00 to 9.99
OPT	Options Installed	OPT <xxxxx>	read only option identification [M]-[A]-[P]-[C]-[B]

Note - This is an ASCII interface. Requesting data from the LCp-104 is done mainly by sending a 3 character command followed by a carriage return (ODH). These 3 character commands are listed under "Code" in the Table above. The response to these commands is listed under LCp Response. The response data is followed by a carriage return line feed (ODH, OAH). There are also ways of stringing the commands together as shown in examples immediately following this Table.

Note - <00000000> represents weight data: # of zeros = number of digits. If there is a decimal point there will be one less digit. If the number is negative the most significant digit will be an ASCII minus '-' i.e. -500 will be '-<00000000>0500', -0.5 will be '-<00000000>00.5' is numeric data, <xxxxxxx> is mV/V data; if negative leading x = '-'

Note - If unit address is selected, PC must transmit address code as 01A, 02A, etc. to establish communication.

Table 6-4. Interface Error Code Definitions.

Interface Error Codes		
NA = not allowed NT = no terminator LM = limit BF = input buffer overflow (too many characters transmitted) A/D = a/d error ? = unknown command received		
Error Code Examples		
String Sent	String Received	Error Description
99,CR	99,?CRLF	unknown command
CR	?CRLF	unknown command
00<A1>CR	00<NA>CRLF	not valid value for a/d rev
00<000>CR	00<NA>CRLF	not valid value for a/d rev
41<16>CR	41<LM>CRLF	value limit for annunciator
36<000050000>CR	36<NT>CRLF	no terminator (too many digits)

Table 6-5. PC Interface Live Data Transactions.

LCp-104 PC Interface Live Data Transactions: Please Read Note Below			
Code	Definition	LCp Response	Explanation
00,	Gross Weight	00(00000000)	current gross weight
01,	Net Weight	01(00000000)	current net weight
02,	mV/V	02(x.xxxxxx)	current mV/V data
03	NA		
04,	Weight Status	04(A)	A = a/d status: () = normal, (M) = motion, (U) = signal underload, (V) = above overload limit, (O) = signal overload, (E) = load cell connection fault
05,	Analog Status	05(A)	A = analog output status: () = normal, (U) = analog underrange, (O) = analog overrange, (E) = analog open circuit
06,	Analog Value	06(xxxxx)	0 - 65537 analog output
07,	Display	07(A-U)	ABCDEFGH = upper display (alphanumeric) with decimal point or leading space IJKLMNOPQ = lower display (alphanumeric) with decimal point or leading space R = horizontal bar graph (-=off, @=left arrow on, A-Z=segments on, +=right arrow on) S = vertical bar graph (-=off, @=bottom arrow on, A-I=segments on, +=top arrow on) T = annunciators A1-A4 (low four bits of T, T = 1 0 0 0 0 0, for A1-A4 off T=@*, if A3 is on T= B*) U = annunciators A5-A8 (low four bits of U, U = 1 0 0 0 0 0, for A5-A8 off U=@*, if A6,7 are on U=F*)
08,	Remote Inputs	08(xxxxx)	remote inputs msd-lsd (5-1): print, gross/net, tare, zero, unused (0 = low/1 = high)
09	Rate Data	09(00000000)	current rate data
Convenience Command Codes			
G	Switch to Gross Mode	(per print format)	switch to gross mode and return current gross weight value
N	Switch to Net Mode	(per print format)	switch to net mode and return current net weight value
T	Switch Net & Tare	(per print format)	switch to net mode, tare, and return current net weight value
Z	Switch Gross & Zero	(per print format)	switch to gross mode, zero out, and return current gross weight value
Note - live weight data uses () and not, <> as a frame, this is because the numerical part of the live weight data and stored eeprom data codes are the same number sequence 00 01 etc.			
* hexadecimal equivalent i.e. @ = 40 hex			

Live Data Request Examples	
(1). to get gross weight (code 00,) if current gross weight is -10.1 lb sent received 00,CR 00(-000010.1)CRLF	
Sent	Received
00,CR	00(1000010.0)CRLF
(2). to get gross & net weights and status (codes 00, 01, 04,) if current gross weight is 440.05, tare value is 200.1 and scale is in motion:	
Sent	Received
00,01,04,CR	00(000440.05)01(000240.04)04(M)CRLF
(3). to get live data codes 00 - 05 (data values used as example only):	
Sent	Received
00-02,CR	00(000440.05)01(000240.04)02(1.200505)CRLF
Live Data Convenience Command Examples	
(1). to switch Model LCp-104 to gross mode and get gross weight (code G), if current gross weight is -10.1 lb, unit # is 01, and scale is in motion:	
Sent	Received (print format)
GCR	01-000010.1LGMCRFL
(2). to switch to net mode, tare and get net weight (code T), if current gross weight is -10.1 lb, unit # is 01:	
Sent	Received (print format)
TCR	01 000000.0LNCRLF

Table 6-6. PC Interface Set Point Data Transactions.

LCp-104 PC Interface Setpoint Register Format: Please Read Note Below			
Code	Definition	LCp Response	Explanation
00/	Output 1 Main	00[00000000]	output 1 main value
01/	Output 1 Inflight	01[000000]	output 1 inflight compensation value
02/	Output 1 Deadband	02[000000]	output 1 deadband value
03/	Output 1 Configuration	03[000]	output 1 config: msd on below (0)/above, 2sd gross (0)/net, lsd main (0)/dribble
04/	Output 1 Tag	04[AAAAAAAA]	output 1 tag: space, 1-0, '-', A-Z
05/	Output 2 Main/Drib	05[00000000]	output 2 main or dribble value
06/	Output 2 Inflight	06[000000]	output 2 inflight if config is main
07/	Output 2 Deadband	07[000000]	output 2 deadband if config is main
08/	Output 2 Configuration	08[000]	output 2 config: msd on below (0)/above, 2sd gross (0)/net, lsd main (0)/dribble
09/	Output 2 Tag	09[AAAAAAAA]	output 2 tag: space, 1-0, '-', A-Z
10/	Output 3 Main/Drib	10[00000000]	output 3 main or dribble value
11/	Output 3 Inflight	11[000000]	output 3 inflight if config is main
12/	Output 3 Deadband	12[000000]	output 3 deadband if config is main
13/	Output 3 Configuration	13[000]	output 3 config: msd on below (0)/above, 2sd gross (0)/net, lsd main (0)/dribble
14/	Output 3 Tag	14[AAAAAAAA]	output 3 tag: space, 1-0, '-', A-Z
15/	Output 4 Main/Drib	15[00000000]	output 4 main or dribble value
16/	Output 4 Inflight	16[000000]	output 4 inflight if config is main
17/	Output 4 Deadband	17[000000]	output 4 deadband if config is main
18/	Output 4 Configuration	18[000]	output 4 config: msd on below (0)/above, 2sd gross (0)/net, lsd main (0)/dribble
19/	Output 4 Tag	19[AAAAAAAA]	output 4 tag: space, 1-0, '-', A-Z
20/	Output 5 Main/Drib	20[00000000]	output 5 main or dribble value
21/	Output 5 Inflight	21[000000]	output 5 inflight if config is main
22/	Output 5 Deadband	22[000000]	output 5 deadband if config is main
23/	Output 5 Configuration	23[000]	output 5 config: msd on below (0)/above, 2sd gross (0)/net, lsd main (0)/dribble
24/	Output 5 Tag	24[AAAAAAAA]	output 5 tag: space, 1-0, '-', A-Z
25/	Output 6 Main/Drib	25[00000000]	output 6 main or dribble value
26/	Output 6 Inflight	26[000000]	output 6 inflight if config is main
27/	Output 6 Deadband	27[000000]	output 6 deadband if config is main
28/	Output 6 Configuration	28[000]	output 6 config: msd on below (0)/above, 2sd gross (0)/net, lsd main (0)/dribble
29/	Output 6 Tag	29[AAAAAAAA]	output 6 tag: space, 1-0, '-', A-Z
30/	Output 7 Main/Drib	30[00000000]	output 7 main or dribble value
31/	Output 7 Inflight	31[000000]	output 7 inflight if config is main
32/	Output 7 Deadband	32[000000]	output 7 deadband if config is main
33/	Output 7 Configuration	33[000]	output 7 config: msd on below (0)/above, 2sd gross (0)/net, lsd main (0)/dribble
34/	Output 7 Tag	34[AAAAAAAA]	output 7 tag: space, 1-0, '-', A-Z
35/	Output 8 Main/Drib	35[00000000]	output 8 main or dribble value
36/	Output 8 Inflight	36[000000]	output 8 inflight if config is main
37/	Output 8 Deadband	37[000000]	output 8 deadband if config is main
38/	Output 8 Configuration	38[000]	output 8 config: msd on below (0)/above, 2sd gross (0)/net, lsd main (0)/dribble
39/	Output 8 Tag	39[AAAAAAAA]	output 8 tag: space, 1-0, '-', A-Z
40/	Setpoint Locks	40[xxxxxxxx]	setpoint locks - 0 = off, 1 = on: lsd - msd = setpoint 1 thru setpoint 8

Note - setpoint data uses [] and not <> or () as a frame, this is because the numerical part of the live weight data and stored eeprom data codes are the same number sequence 00 01 etc.

Table 6-6 can't. PC Interface Set Point Data Transactions.

Setpoint Data Request Examples	
(1). to get output 1 main (code 00/) if main = 2000	
Sent	Received
00/CR	00(00002000)CRLF
(2). to get output 1 main, inflight, deadband, status, tag, and output 2 is configured as dribble to output 1; if main = 2000, inflight = 10, deadband = 5, status = on below tracking net weight, tag = SLURRY, dribble = 35:	
Sent	Received
00-09/CR	00[00002000]01[000010]02[000005]03[010]04[SLURRY] 05[00000035]06[000000]07[000000]08[001]09[OUTPUT 2]CRLF
(3). to get outputs 1 - 4 main values: if 2000, 4000, 6000, and 8000:	
Sent	Received
00/05/10/15/CR	00[00002000]05[00004000]10[00006000]15[00008000]CRLF
Setpoint Data Write Examples	
(1). to download output 1 (code 00/)	
Send	Response Will Be
send (if main = 50000) 00[00050000]CR or 00[50000]CR	00[00050000]CRLF
(2). to download output 1 inflight deadload status and tag	
Send	Response Will Be
(if inflight and deadband are 15 and 5, configured as on below tracking gross, and tag is WATER) 01[000015]02[000005]03[000]04[WATER]CR or 01[15]02[5]03[000]04[WATER]CR	01[000015]02[000005]03[000]04[WATER]CRLF

SECTION 7. System Diagnostics

7.1 OVERVIEW

LCp-104 diagnostics provide easy access to critical operating system data, and test/verification procedures for many indicator functions. Figure 7-1 (next page) presents the diagnostic flow diagram. Follow the procedures in this diagram to view values, set function limitations, test the front panel keypad, and verify I/O functions.

7.2 DIAGNOSTIC USER

Diagnostic user provides three registers for storage of customer tag and calibration records. Users may enter a tag number, current calibration date, and projected date of next calibration, if desired.

7.3 DIAGNOSTIC VERSION

Diagnostic version provides the software version, the installed option code derived from the ordering specification, the serial number, and the date of the factory calibration.

7.4 DIAGNOSTIC RECALL

Recall allows operating personnel to view current process related values. Values may be viewed for the total system or on an individual cell basis.

7.4.1 Recall Tare and Zero Values

Recall allows the operator to view current tare and zero values. Press the INDV UNITS key to see values for individual cells.

7.4.2 Recall Shift

Load shift testing detects significant load changes in an operational weigh system. An excessive load shift value indicates that system equipment or vessel contents have shifted so as to place a disproportional amount of weight on a single cell. Load shifts can be caused by many things, among a few are: heel buildup on one side of a tank, support structure changes introducing more force from connected pipes or process equipment, excessive deflection of a support leg, or faulty signal from the load cell.

Recall shift shows the percent of shift value for each individual cell. A scrolling message (for the 'worst case' cell) prompts the operator to press the INDV % key to see the shift values of all other cells.

NOTE: Shift testing is reset if motion is detected (motion function must be selected).

7.4.3 Recall Drift

Drift testing detects a load cell output that is changing beyond acceptable tolerance levels. When the system stabilizes after a period of weight activity, the processor waits approximately 30 seconds and then stores a reference value for each cell. Successive values, averaged every 256 conversions, are compared to the stored value and checked for compliance with the drift band selection. Drift testing is abandoned when the system is active.

Long-term load cell drift problems may be caused by electrical leakage or system structural problems. Since most systems usually experience inactive periods of 8 or more hours, this test is highly effective at catching long-term drift problems. Long-term drift testing provides 'early warning detection' for cells that may fail completely at a later date.

Recall drift shows plus and minus drift values for each individual cell. A scrolling message (for the 'worst case' cell) prompts the operator to press the INDV % key to see the drift values of all other cells.

7.5 SELECTING LIMITS

Diagnostic limits allow operator entry of 'not-to-exceed' values for critical system functions. Most of these selections can be assigned to a front panel annunciator (A1-A8, paragraph 5.1.3) to provide visual indication of the error condition.

7.5.1 Zero Limit

The value entered for zero will limit the range of the front panel zero keys (recommended 2-20%). The zero keys will not function beyond if the range is exceeded.

7.5.2 Overload Limit

This value is critical for system protection. Repeated system overloading may permanently damage load cells and other process equipment. Enter a value of up to 150% of system capacity.

7.5.3 Motion Limit Selections

Motion determines how many counts must be exceeded before the 'in motion' alarm annunciator is activated. The motion timer determines how long the motion alarm remains activated after the motion condition is cleared.

7.5.4 Shift Limit

The shift limit is a percentage value entered for the entire system. It is compared against the sum of all individual cell shift percentages.

7.5.5 Drift Limit

The drift limit is a unit value entered for all cells in the system. It is compared against individual cell drift values.

7.6 FRONT PANEL KEY TEST

DIAG KEYPAD allows an operator to functionally test any/all front panel keys. Press any two keys simultaneously to exit.

7.7 CHECK REMOTE INPUTS

DIAG INPUTS is a check of all remote inputs. If inputs are inactive, their respective numbers will appear (54321). Once activated, the input number will change to a dash.

7.8 TEST/VERIFY THE ANALOG OUTPUT

DIAG ANALOG tests the analog output. Testing should be performed with a current meter attached. Testing firstly shows the actual analog count value being transmitted. Since the analog output is based on a 16-bit D-A conversion, the percent of span can be calculated by dividing the displayed counts by 65535. Secondly, any value may be entered to test the analog output. Enter a known value such as 65535 (max setting) and check current meter for appropriate output. Exiting this menu will automatically discontinue the test mode.

7.9 TEST/TROUBLESHOOT THE SERIAL OUTPUT

DIAG SERIAL provides the means to view both the transmit and receive buffers. After pressing EDIT, use the left/right arrow keys to increment forward or decrement backward through the selected buffer and view the hexadecimal value of each character. Using this procedure, incoming data requests can be checked for protocol/syntax accuracy and compared to LCp-104 output responses.

7.10 TEST/TROUBLESHOOT THE OPTIONAL DEVICENET OUTPUT

DIAG DEVICE N provides the means to view the status of the DeviceNet interface. After pressing EDIT, scroll through the menu to see the error number (if an error exists), the number of resets, and the current values of the receive and transmit buffers.

SECTION 8. The LCp-104 Security System

8.1 INTRODUCTION

From password access to individually selectable menu and key 'locks', Safe-Weigh Software protects the entire weigh system from overt tampering or accidental data/configuration/calibration alterations. Figure 8- 1 (next page) presents the security menu flow diagram. Follow the procedures designated to secure as many parameters as desired.

8.1.1 Lock On/Off

Lock 'On' restricts access to the security menu and all other menus/keys designated as 'locked'. If locked, the designated password (see paragraph 8.2) must be entered to gain access to the security menu. Units are shipped with the lock 'Off to allow initial configuration without a password.

8.1.2 Menu Locks

Any or all of the LCp-104 main menus can be 'locked' to prevent parameter changes. To lock a menu, choose ON by pressing the EDIT and RIGHT arrow keys in sequence. Then press ENTER to store. Once a menu is designated as locked, access to that menu is barred. To 'unlock' a locked menu, return to the security menu, enter the correct password, and change the status to OFF.

8.1.3 Key Locks

Five of the LCp-104 front panel keys can be 'locked' to prohibit key function. Keys that can be locked are; ZERO, TARE, GIN (gross/net), PRINT, and EDIT. To lock a key, choose ON by pressing the EDIT and RIGHT arrow keys in sequence. Then press ENTER to store. If a key is designated as locked, it will not function when pressed. To 'unlock' a locked key, return to the

security menu, enter the correct password, and change the status to OFF.

8.1.4 Set point Locks

All eight set points can be locked to prevent unauthorized access/changes. To lock set points, follow the Set point Locks flow diagram in Figure 8-1. When the lock is 'ON', access is denied until the status is changed to 'OFF'.

8.2 PASSWORD ACCESS

If lock ON is selected (paragraph 8.1.1), a password must be entered to regain access to the security menu. The following paragraphs explain how to select and enter a password. Once a password is chosen, it should be written down and stored in a confidential area.

8.2.1 Selecting/Storing a Password

A password can be any combination of alpha-numeric characters up to seven digits long. It is not necessary to use all seven digits.

At the PASSWORD display, key in the designated characters using the arrow keys (LEFT/RIGHT to change digits, UP/DOWN to select character). When the password is correctly displayed, press ENTER to store.

8.2.2 Entering the Password

If the lock is 'ON', the password must be entered to access the security menu. With the display reading SECURITY (a row of dashes above), press EDIT. Use the arrow keys to enter the complete password, as it was stored, on the row above SECURITY. When the correct password is displayed, press ENTER. Note that entering the password does not turn the lock off; it simply allows access to the security menu. If the lock is left ON, the password must be entered each time the security menu is accessed.

Security Menu Flow Diagram

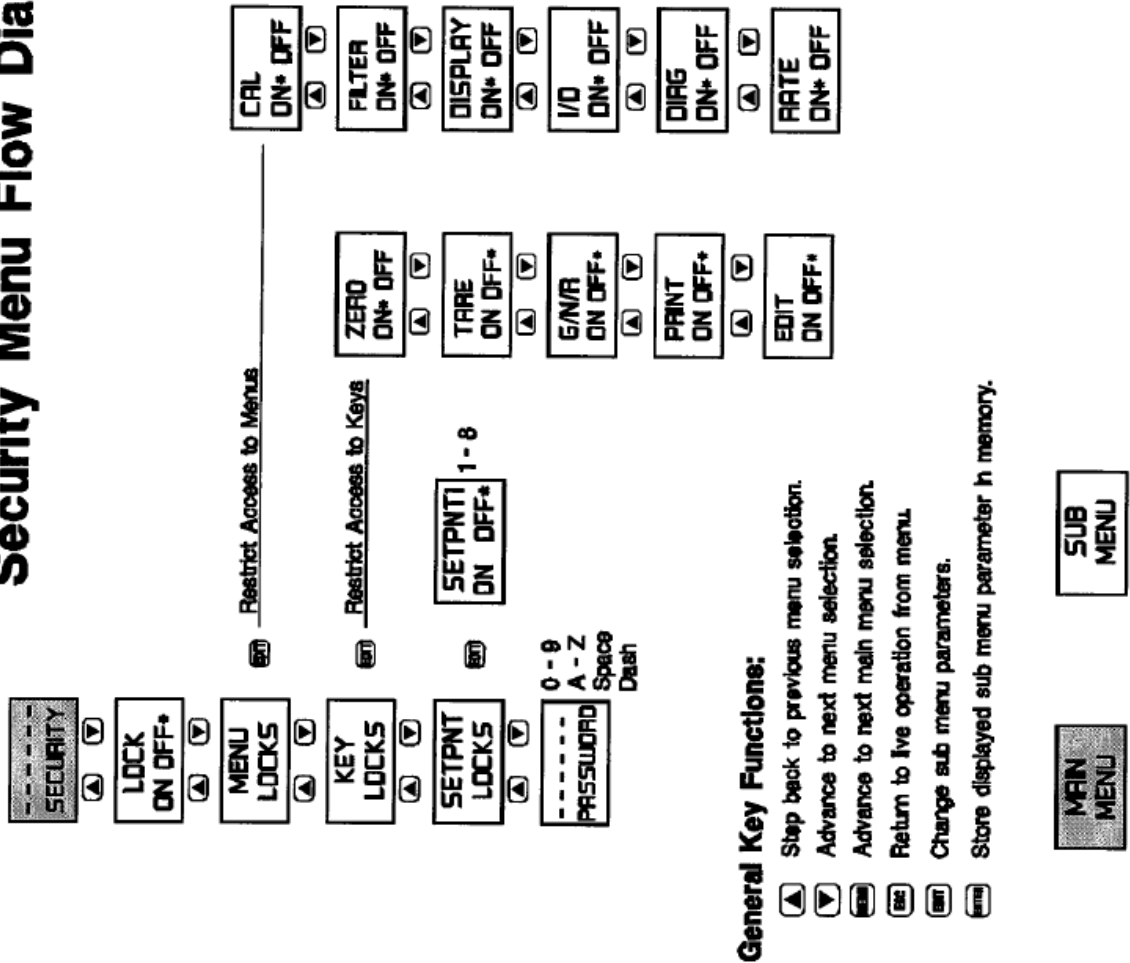

Figure 8-1. Security Menu Functions.

SECTION 9. Operation

9.1 GENERAL

LCp-104 indicator/transmitters power up in either the gross or net weight weighing mode depending upon the selection made in paragraph 5.1.6. If no critical system errors are detected, the front panel display will show the selected mode weight value.

Figure 9-1 presents the front panel switch functions for the operating mode. GIN toggles the operating mode from gross to net or net to gross. ZERO performs push to zero (gross mode), and TARE initiates the tare function in the net mode. PRINT/COM transmits the current weight status data to a printer if print format is selected. If the LCp-104 is connected to a host computer or PLC, gross, net, zero, tare, and print functions can be initiated remotely using the rear panel digital inputs.

9.2 GROSS WEIGHT WEIGHING

In the gross mode, all of the live weight of the system is displayed on the front panel. Live weight does not include the dead weight of a vessel or other mechanical equipment that is factored out during calibration.

9.3 ZERO OPERATION

A new zero can be acquired to compensate for changes in the dead load of the system due to heel build-up etc. Acquiring a new zero reference value does not affect the slope of the calibration. The push to zero range in the LCp-104 can be configured from OFF to 100% of system capacity (or 9999999). To prevent system overload, the zero selection limit usually does not exceed 20% of system capacity. Zero may be acquired only if the system is not in motion and the zero limit has not been exceeded.

9.4 NET WEIGHT WEIGHING

Net weight weighing is used when the operator wants to reset zero to compensate for the addition of live weight, or a container, before adding a specific amount of material. Tare is used to establish a zero reference in net mode.

9.5 TARE OPERATION

With the LCp-104 in net weighing mode, the tare function resets the output to zero. Push button taring (TARE key) allows the operator to achieve a new zero reference before addition of each ingredient so that errors do not become cumulative. If manual tare is selected, a tare value must be entered using the EDIT and arrow keys (press ENTER to store). Manual tare values typically represent the known weight of empty containers placed upon the scale/platform.

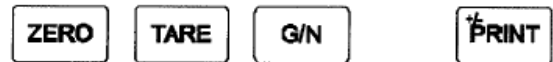

Figure 9-1. Front Panel Operating Keys.

9.6 INDIVIDUAL LOAD CELL DISPLAYS

Viewing individual load cells live, throughout the entire process, allows operating personnel to profile system trends or tendencies and adjust equipment for maximum performance. Although the total system may never overload, certain cells may experience overload or underload 'moments' which can affect cell integrity, longevity, and ultimately, product quality.

LCp-104 technology allows operating personnel to view individual load cell data in one of three forms. In accordance with Figure 9-2, view either the unit weight value (individual units), millivolt per volt signal (individual mV/V), or the percent of total load (individual %) each cell is carrying.

Individual View Key Functions

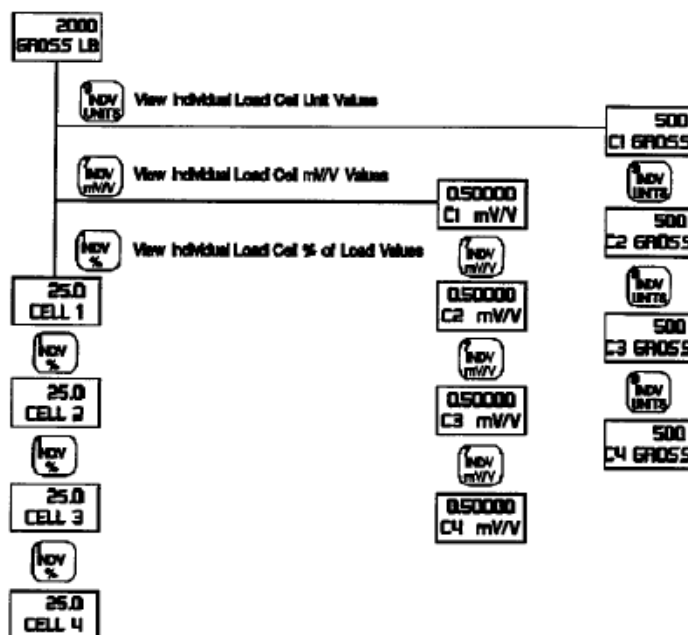

Figure 9-2. Individual Load Cell View Keys.

9.7 RATE-BY-WEIGHT

LCp-104 Systems calculate the mass flow rate by dividing change in weight by elapsed time. Flow rate is computed each update based upon filtered weight data. Rate values are accumulated based upon the derivation time selected by the operator. Display and output values are the average of accumulated rate updates during the derivation time period. Longer derivation time selections result in greater stability.

9.7.1 Minimum Flow Rate Capability

Application parameters such as transducer type, dead/ live loads, and the use of intrinsic safety barriers (Div 1 hazardous locations only) affect the instrument's ability to measure very low flow rates.

9.7.2 Determining Weight/Rate Resolution

Rate resolution varies according to unit selection (seconds or minutes) and display count (count by's) configuration. Also, static weight and rate-by-weight resolutions can be set independently. For example, a system with a static weight resolution

of 1.0 lb can potentially have a rate resolution of 0.002 lb/sec.

If the static weight display has no decimal point, rate resolution will equal 10, 5, 2, 1, 0.5, 0.2, 0.1, 0.05, 0.02, 0.01, 0.005, 0.002, or 0.001. Add decimal places to the left for any increase in the static weight resolution decimal.

9.7.3 Parameter Selections

Figure 9-3 (next page) shows the flow diagram for selecting and entering rate parameters. Follow the sequence to make all entries.

Units - Faster flow rates should be entered as units per second while slower flow rates should be entered as units per minute.

Resolution - This selection tells the LCp-104 approximately how many units will flow in the time frame selected; i.e., 0.01 pounds per second.

Derivation Time - Derivation time is the estimated time frame in which a specified amount (resolution/units) of material will flow into or out of the weigh vessel.

Rate-By-Weight Flow Diagram

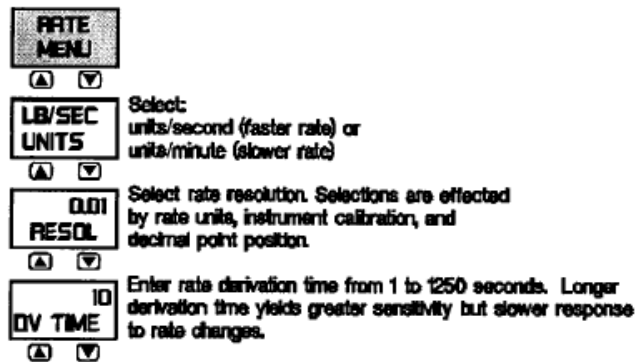

To Enter/Alter a Numeric Value:

- Press to initiate a change.
- Key in desired numeric value.
OR - in some cases -
- Press to increment selected digit.
- Press to decrement selected digit.
- Press to advance to next digit.
- Press to return to previous digit.
- Press to store selection in memory.

To Enter/Alter a Parameter Selection:

- Press to initiate a change.
- Press to view parameter options.
- Press to store selection in memory.

General Key Functions:

- Step back to previous menu selection.
- Advance to next menu selection.
- Advance to next main menu selection.
- Return to live operation from menu.
- Change sub menu parameters.
- Store displayed sub menu parameter in memory.



Figure 9-3. The LCp-40 Rate-by-Weight Flow Diagram.

9.8 ERROR DETECTION AND CORRECTION

Should an error condition occur, a scrolling message will appear on the bottom line of the

front panel display. As much as possible, messages define the exact error and suggest a remedy. Once the error is cleared, the scrolling message will stop, and normal operation will resume. Table 9-1 presents all error messages with recommended solutions.

Table 9-1. LCp-104 Fault Message Displays				
No.	Fault	LCp-104 Display (Scrolling)	Cause	Remedy
1	Lost Tare	'LOST TARE VALUE'	Power Up Checksum Error	Acquire New Tare
2	Lost Zero	'LOST ZERO VALUE'	Power Up Checksum Error	Acquire New Zero
3	No mV/V Cal	'NO MV/V CAL'	Power Up Checksum Error	Perform mV/V Cal
4	No Engineering Cal	'NO ENGINEERING CAL'	Power Up Checksum Error	Re-enter Calibration Parameters
5	No Temperature Compensation	', NO TEMP COMPENSATION'	Power Up Checksum Error	Consult Factory
6	Jbox EEPROM Error	'JBOX EEPROM ERROR'	Unable To Write To EEPROM (Jbox)	Power Down and Power Up. If Error Persists, Consult Factory
7*	Local EEPROM Error	'LOCAL EEPROM ERROR'	Unable To Write To EEPROM (Console)	Power Down and Power Up. If Error Persists, Consult Factory
8*	AID Overrange	Upper Display -'OVER RANGE' or 'UNDER RANGE'	Input Signal Out of Range	Check Input Signal and Wiring
9*	Excitation Open	'EXCITATION OPEN CELL (1-4) CHECK WIRING'	Wiring Error Most Likley	Check Load Cell Wiring
10*	Excitation Low	'EXCITATION LOW CELL (1-4) CHECK WIRING'	Faulty Load Cell or Shorted Wiring	Check Load Cell Wiring
11*	Overload	'OVERLOAD CELL (1-4)'	Overload Limit Exceeded	Check Load Cell % and Adjust System Installation
12*	Zero Limit	Lower Display -'ZERO' 'LIMIT' ZERO"LIMIT'	Zero Limit Exceeded	Check for System Heel Build-Up
13*	Shift Limit	Lower Display - 'SHIFT ERROR CELL (1-4)'	Cell Shift Limit Exceeded	Check for System Mechanical Shift/Imbalance
14*	Drift Limit	Lower Display - 'DRIFT ERROR CELL (1-4)'	Cell Drift Limit Exceeded	Check Wiring and Connections for Moisture/Contamination
15	Interconnect Wiring	'LINKING'	Faulty Wiring between J-Box and Display	Check Interface Wiring and Connections

*Faulty cell(s) will be designated.

SECTION 10. Allen-Bradley Remote I/O

This chapter describes the Allen-Bradley Remote I/O (RIO) communication link between the LCp-104 Process Weighing System and an Allen-Bradley PLC-5. Remote I/O interfacing uses technologies licensed to BLH from Allen-Bradley. Functionally, this simple digital interface expedites the transfer of weight data, system status, and diagnostic information. It also significantly simplifies the retrieval and download of filter and other set-up parameters.

10.1 INTERCONNECT CABLE

LCp-104 units ordered with the Allen-Bradley Remote I/O option have an additional 3-socket mating half connector. Connector and wiring designations are presented in Figure 10-1. Connect 'Blue Hose' cable to the supplied connector as designated.

10.2 RIO OVERVIEW

The Allen-Bradley Remote I/O (RIO) interface is a communications link that supports remote, time critical I/O control communications between a master processor and a remote I/O slave unit. It is typically used to transfer I/O bit images between the master and slave. The LCp-104 represents a quarter (1/4) rack of discrete I/O with 32-bit input and output image files. Time critical system information (weight and status data) is communicated to the PLC using discrete read and write commands. Block transfers are used to up-load and download non-time critical information such as diagnostic, status, and individual load cell data.

NOTE: Transfer data differs according to mode selection

10.3 THE ALLEN-BRADLEY PLC

Allen Bradley PLC-5 programmable controllers are typically used as part of a distributed process automation architecture. A variety of 1771 series racks and I/O modules are available for local or remote discrete and analog process control. PLC-5 units digitally communicate to other devices using a conventional RS-232 or -422 serial port.

10.4 THE REMOTE I/O INTERFACE

10.4.1 Operational Overview

The Allen-Bradley Remote I/O (RIO) interface is standard on many PLC-2, 3, and 5 series programmable logic controllers. The technology used in the interface and licensed by Allen-Bradley to BLH enables the LCp-104 system to communicate weight information to the PLC as if it were 1/4 rack of discrete I/O. Using the standard RIO interface port to represent weight data as simple discrete I/O, a low cost reliable communication link between the PLC and system is established. Standard PLC ladder logic instructions convert binary data to an integer or floating point weight value without special software drivers and scan delays that occur when data block transfers are used. The LCp also communicates status information, diagnostics, and calibration data to the PLC.

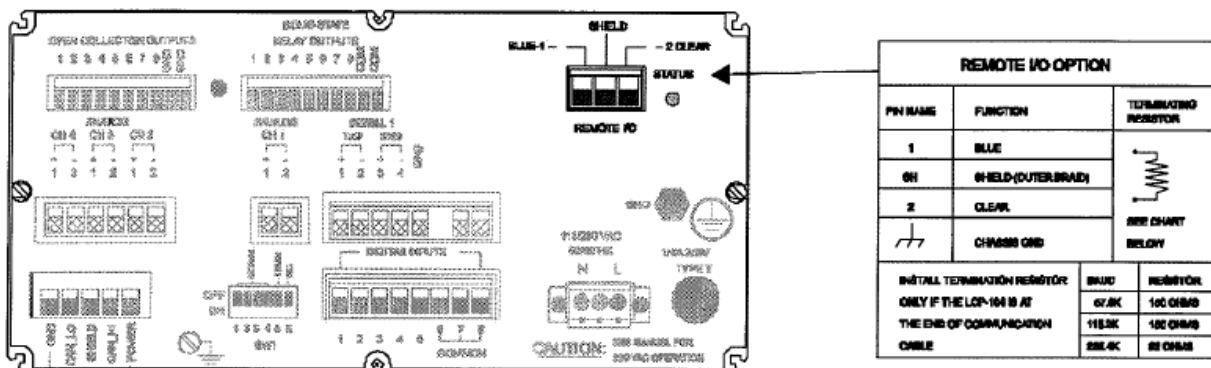
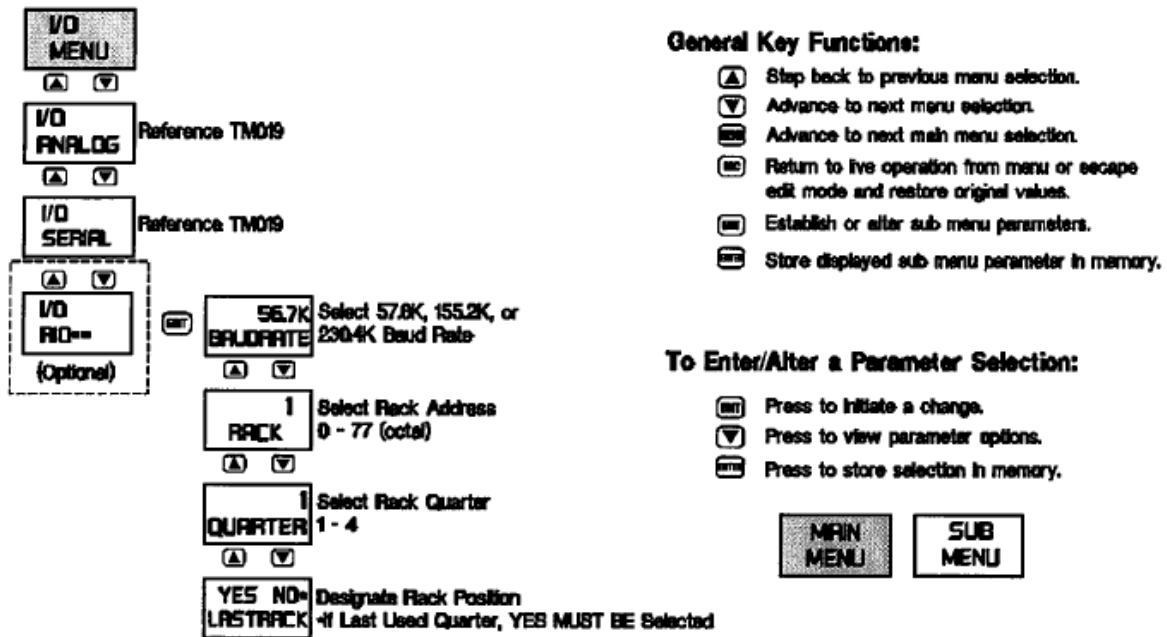

Figure 10-1. Allen-Bradley Remote I/O Cable Connection.

Allen-Bradley RIO Interface Flow Diagram



Cable Lengths, Terminations, and Maximum # Of LCp Units

BAUD RATE	MAXIMUM CABLE LENGTH	TERMINATION FOR LAST LCp ON CABLE	MAXIMUM LCps PER SCANNER
57.8K	10,000 FEET	150 OHMS	16 Units
155.2K	5,000 FEET	150 OHMS	16 Units
230.4K	2,500 FEET	82 OHMS	32 Units

Figure 10-2. Remote I/O Menu and Cable Considerations.

CONFIGURATIONS:

- One Quarter Rack. The LCp-104 is configured to act as 1/4 rack of I/O using 2 input words and 2 output words in the PLC's I/O image table. Four LCp-104's constitute 1 full rack, each using a different starting quarter.
- Discrete Transfer. Weight data and operating status information transmitted through discrete transfer using the PLC's Remote I/O image table.
- Block Transfer. Block data transfers are initiated by the PLC ladder logic program to obtain more in depth status, diagnostic, and individual load cell data.
- Word Integrity Is Ensured. LCp's always transmit both input image table words intact. To ensure word integrity on the

PLC side, immediate writes to the output image table should be written low word first.

10.4.2 Interface Configurations

Baud rate, rack address, starting quarter, and last rack designations are all configured through the LCp I/O sub-menu (Figure 10-2). Access the I/O sub menu (reference operator's manual for keypad functions), step to the I/O RIO display, and make selections. The LCp is able to be addressed up to rack number 77 (octal).

Additional Figure 10-2 information provides a relationship table for baud rate, cable length, last rack termination resistance, and the number of LCp's on the RIO loop. Careful consideration must be given to all four factors to ensure proper RIO loop operation.

10.4.3 Discrete Data Transfers

Output Image Table

The PLC-5 initiates the communication interface by transmitting two words from the output image table (Figure 10-3). The first word is regarded as a 'spare' by the LCp-104.

The second word contains the commands that the PLC-5 expects the LCp-104 system to perform. Word 2 controls set points, filter selection, filter operation, and operating mode status.

Table 10-1 shows the structure and bit definition of each Output Image Table word.

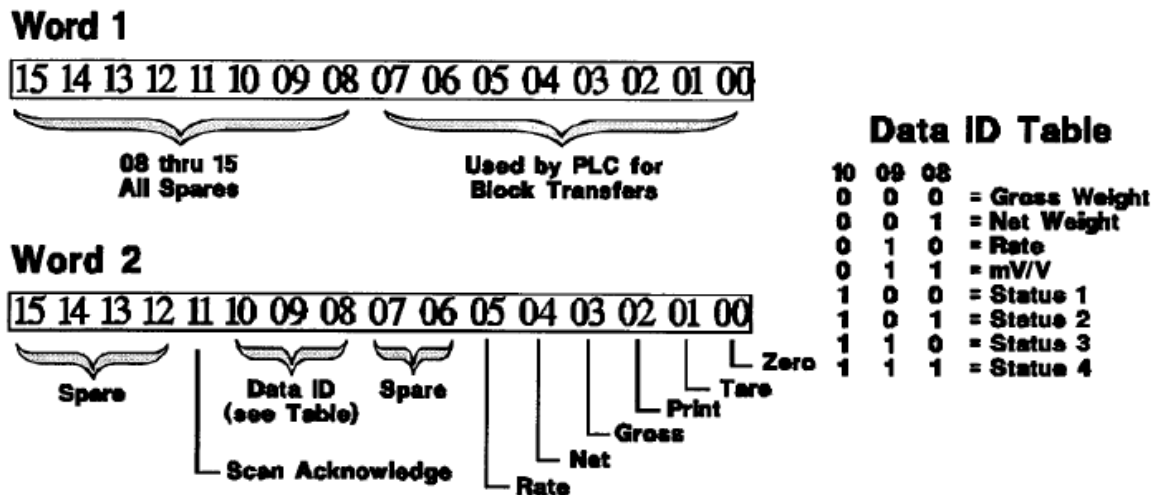

Figure 10-3 and Table 10-1. Remote I/O Output Image Table Bit Designations

Output Image Table Bit Designations			
Word	Bits	Function	Definition
1	0-15	Weight Data	Not used by the LCp-104
2	0	Zero	If this bit changes from 0 to 1, the LCp will zero the gross weight if not currently in "motion" as determined by the motion status bit or if not outside the selectable zero limit. If not successful, bit (1) UNABLE TO TARE/ZERO BECAUSE OF MOTION or bit (2) UNABLE TO ZERO BECAUSE OF LIMIT in STATUS reg (10) of the block transfer registers will be set causing the fault bit (bit 15 of word 2 in the input image table) to be set.
2	1	Tare	If this bit changes from 0 to 1, the LCp will tare the net weight if not currently in "motion" as determined by the motion status bit. If not successful, bit (1) UNABLE TO TARE/ZERO BECAUSE OF MOTION in STATUS reg (10) of the block transfer registers will be set causing the fault bit (bit 13 of word 2 of the input image table) to be set.
2	2	Print	If this bit changes from 0 to 1, the LCp will transmit data in the transmit buffer if the serial port is configured for PRINT:
2	3	Gross	If set, switch LCp-104 to gross weight mode.
2	4	Net	If set, switch LCp-104 to net weight mode.
2	5	Rate	If set, switch LCp-104 to rate-by-weight mode.
2	6-7	Spare	Not used.
2	8-10	Data ID	Requests data to be returned in Word 1 and Word 2 Bits 0-5 input image table.
2	11	Scan Acknowledge	This bit is set or reset by the PLC to achieve data transfer synchronization between the PLC's program scan and the remote I/O scan. When the LCp receives the output image table data, it copies this bit to the same location in the input image table. The PLC can thus know if the LCp has received the last write to the output image table.
2	12-15	Spare	Not Used

Input Image Table

After evaluating the contents of the output image table, the LCp-104 responds by transmitting two words to the input image table (Figure 10-4). The first word contains signed integer weight

data. The second word contains the upper order data bits, system status, error condition, and set point status information.

Table 10-2 defines the bit structure of both input words.

Word 1

15 14 13 12 11 10 09 08 07 06 05 04 03 02 01 00

Data • 1 (Signed Integer)

Word 2

15 14 13 12 11 10 09 08 07 06 05 04 03 02 01 00

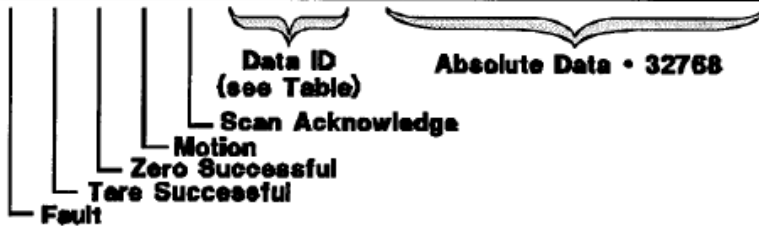

Data ID Table

10	09	08	
0	0	0	= Gross Weight
0	0	1	= Net Weight
0	1	0	= Rate
0	1	1	= mV/V
1	0	0	= Status 1
1	0	1	= Status 2
1	1	0	= Status 3
1	1	1	= Status 4

Figure 10-4 and Table 10-2. Remote I/O Input Image Table Bit Designations.

Input Image Table Bit Designations			
Word	Bits	Function	Definition
1	0-15	Weight Data	Signed integer
2	0-7	Absolute Overflow Data x 32768	Word 2 bits 0-7 are absolute overflow data from word 1 used if weigh data is greater than 32,767. These 8 bits are combined with the word 1 integer in a floating point register by the following steps. 1. Do a masked move of Word 2 bits 0 - 7 to an integer register. 2. Multiply the integer register by 32768.0 and put the result in a floating point register. 3. Negate the floating point result if the word 1 integer is negative. 4. Add the word 1 integer to the floating point result.
2	8-10	Data ID	Identifies the data in Words 1/2 bits 0-5
2	11	Scan Acknowledge	This bit is a copy of the same bit in the output image table. When the LCp receives the output image table data, it copies this bit to the same location in the input image table. The PLC now knows if the remote I/O LCp has received the last write to the output image table.
2	12	Motion	If set, weight data is in motion (see paragraph 7.5.3)
2	13	Zero Successful	Gross zero OK.
2	14	Tare Successful	Net tare (zero-out) OK.
2	15	Fault	If set, there is a fault causing weight or status data to be incorrect. Evaluate status registers to determine and correct fault.

10.5 BLOCK DATA TRANSFERS

10.5.1 Interface Basics

Block data transfers are initiated by the ladder logic program write (B1W) and read (BTR) commands. The transfer sequence begins when the PLC sends a one word (16-bit integer) write

command containing a register location pointer. This pointer is the 16 bit integer value of the first register the PLC wishes to read (factory default upon shipment is register 1).

Table 10-3 presents all available single and double word register locations. After establishing the starting register location, the PLC then

transmits a read transfer block command telling the LCp-104 how many words of information are needed.

Block Transfer Reads (BTR's)

Once the register location pointer value is established, the PLC logic program must issue a block transfer read command to obtain information. A BTR can request up to 64 words of LCp-104 information (see Table 103). The LCp responds to the BTR by transmitting the number of words requested, starting at the pointer location.

NOTE: The first word transmitted by the LCp will be the register pointer value. This word is added at the beginning of the transmission to 'echo' the pointer value prior to transmitting requested data. Therefore, the BTR command MUST add 1 to the number of words requested. If the PLC needs four words of LCp information, the BTR request must be for five words (Figure 10-5).

WORD 1	WORD 2	WORD 3
Register Address 12	Gross Weight Low Word	Gross Weight High Word

Block Transfer Read Sample: Two words desired (system requires three word read command (3rd word is echo of st

Figure 10-5. A Block Transfer Read Command.

WORD 1	WORD 2
Register Address 136	New Pole Selection

Block Transfer Write Sample: One word desired (new filter requires two word write command (1st word is address).

Figure 10-6. A Block Transfer Write Command.

Block Transfer Writes (BTW's)

Some registers may be written to by the PLC (indicated by a 'W' in the RNV column table 10-3). This allows parameters such as filter, set point, and diagnostic values to be downloaded on-the-fly by the PLC ladder logic program. When writing to the LCp-104, the first word must be the register location pointer. Therefore, the program MUST always add 1 to the BTWV command length (Figure 10-6). For example, to change the filter value, the BTW length must equal 2 with the first word being the filter register location pointer and the second word being the new pole value.

10.5.2 A Perpetual Pointer

One advantage to block transfers is that the register pointer is retained in LCp-104 EEPROM memory. When a write block selects (points to) a register location, that location may be accessed (read) repeatedly without having to re-write the register location word. Of course, the register pointer can be changed as often as needed, but the last written location will always be remembered, even during power down. This feature saves a lot of BTW's when the PLC is monitoring a particular register or block of registers over a period of time.

10.5.3 Fault Evaluation

Four status words, register locations 1, 2, 3, and 4 provide detailed explanations of error conditions experienced by the LCp-104 system. When a fault is detected, bit 15 (fault) in word 2 of the input image table is set to a '1' to alert the PLC of an error condition. The PLC must then perform a BTR of the four status registers to evaluate and correct the error. Table 10-4 gives the status word bit designations.

10.5.4 Remote Filter Configuration

The filter 'pore' parameter can be changed on-the-fly by the PLC. This unique feature allows optimal, pre-determined filtering parameters to be implemented at critical moments during system operation. Changing filter parameters throughout the process ensures data stability and maximum system response to actual weight changes. The pole parameter is stored at register location 136 (Table 10-3). Make pole

selections in accordance with Section 4

guidelines.

Table 10-3. Allen-Bradley Remote I/O Register Allocations							
Data	Address	Registers	R/W	Data	Address	Registers	R/W
Status 1	0	1	R	Zero	128	2	R/W
Status 2	1	1	R	Tare	130	2	R/W
Status 3	2	1	R	Zero Limit %	132	1	R/W
Status 4	3	1	R	Overload %	133	1	R/W
Gross	4	2	R	Shift Limit %	134	1	R/W
Net	6	2	R	Drift Limit +/-	135	1	R/W
N/A	8	2	-	Filter	136	1	R/W
mV/V	10	2	R	Motion Band	137	1	R/W
Peak	12	2	R	Motion Timer	138	1	R/W
Gross 1	14	2	R	Rate DV Time	139	1	R/W
Gross 2	16	2	R	Setpoint #1	140	2	R/W
Gross 3	18	2	R	Setpoint #2	142	2	R/W
Gross 4	20	2	R	Setpoint #3	144	2	R/W
Net 1	22	2	R	Setpoint #4	146	2	R/W
Net 2	24	2	R	Setpoint #5	148	2	R/W
Net 3	26	2	R	Setpoint #6	150	2	R/W
Net 4	28	2	R	Setpoint #7	152	2	R/W
mV/V 1	30	2	R	Setpoint #8	154	2	R/W
mV/V 2	32	2	R	Inflight #1	156	1	R/W
mV/V 3	34	2	R	Inflight #2	157	1	R/W
mV/V 4	36	2	R	Inflight #3	158	1	R/W
Peak 1	38	2	R	Inflight #4	159	1	R/W
Peak 2	40	2	R	Inflight #5	160	1	R/W
Peak 3	42	2	R	Inflight #6	161	1	R/W
Peak 4	44	2	R	Inflight #7	162	1	R/W
% Load 1	46	1	R	Inflight #8	163	1	R/W
% Load 2	47	1	R	Tag #1	164	4	R/W
% Load 3	48	1	R	Tag #2	168	4	R/W
% Load 4	49	1	R	Tag #3	172	4	R/W
% Shift 1	50	1	R	Tag #4	176	4	R/W
% Shift 2	51	1	R	Tag #5	180	4	R/W
% Shift 3	52	1	R	Tag #6	184	4	R/W
% Shift 4	53	1	R	Tag #7	188	4	R/W
+ Drift 1	54	1	R	Tag #8	192	4	R/W
+ Drift 2	55	1	R	System Tag	196	4	R/W
+ Drift 3	56	1	R				
+ Drift 4	57	1	R				
- Drift 1	58	1	R				
- Drift 2	59	1	R				
-Drift 3	60	1	R				
- Drift 4	61	1	R				
Zero 1	62	2	R				
Zero 2	64	2	R				
Zero 3	66	2	R				
Zero 4	68	2	R				
Serial #	70	4	R				
Software Ver	74	1	R				
Ref. Date	75	3	R				

Table 10-4. Status Register Bit Definitions.

Status Register Number 1		
BIT	Name	Definition
0	Power Up	JBox Power Up (true for 5 seconds)
1	Spare	
2	Lost Tare	Checksum Error at Power Up
3	Lost Zero	Checksum Error at Power Up
4	No mV/V Cal	Checksum Error at Power Up
5	No Engineering Cal	Checksum Error at Power Up
6	No Temperature Compensation	Checksum Error at Power Up
7	EEPROM Error	Error Writing EEPROM
8	Comm Power Fault	Serial Output - Power Supply Fault
9	JBox Power Low	Power to JBox is Low
10	Linking	Attempting Communication Link to JBox
11	Unable to Tare/Zero: Motion	System in Motion (true for 5 seconds)
12	Analog #1 Open	Open Connection
13	Analog #1 Underrange	Weight Data Below Analog Output Range
14	Analog #1 Overage	Weight Data Above Analog Output Range
15	Spare	

Status Register Number 2		
BIT	Name	Definition
0	A/D Overage Channel (Cell) 1	Signal Greater Than A/D Range
1	A/D Overage Channel (Cell) 2	Signal Greater Than A/D Range
2	A/D Overage Channel (Cell) 3	Signal Greater Than A/D Range
3	A/D Overage Channel (Cell) 4	Signal Greater Than A/D Range
4	Spare	
5	Spare	
6	Spare	
7	Spare	
8	Excitation Open Channel (Cell) 1	Load Cell Not Connected
9	Excitation Open Channel (Cell) 2	Load Cell Not Connected
10	Excitation Open Channel (Cell) 3	Load Cell Not Connected
11	Excitation Open Channel (Cell) 4	Load Cell Not Connected
12	Excitation Low Channel (Cell)	Check Wiring for Short(s)
13	Excitation Low Channel (Cell)	Check Wiring for Short(s)
14	Excitation Low Channel (Cell)	Check Wiring for Short(s)
15	Excitation Low Channel (Cell)	Check Wiring for Short(s)

Table 10-4 (continued). Status Register Bit Definitions.

Status Register Number 3		
BIT	Name	Definition
0	Overload Limit Cell 1	Cell Overload Value Has Been Exceeded
1	Overload Limit Cell 1	Cell Overload Value Has Been Exceeded
2	Overload Limit Cell 1	Cell Overload Value Has Been Exceeded
3	Overload Limit Cell 1	Cell Overload Value Has Been Exceeded
4	Zero Limit Cell 1	Cell Zero Limit Has Been Exceeded
5	Zero Limit Cell 2	Cell Zero Limit Has Been Exceeded
6	Zero Limit Cell 3	Cell Zero Limit Has Been Exceeded
7	Zero Limit Cell 4	Cell Zero Limit Has Been Exceeded
8	Load Shift Cell 1	Cell Shift Limit Has Been Exceeded
9	Load Shift Cell 2	Cell Shift Limit Has Been Exceeded
10	Load Shift Cell 3	Cell Shift Limit Has Been Exceeded
11	Load Shift Cell 4	Cell Shift Limit Has Been Exceeded
12	Drift Cell 1	Cell Drift Limit Has Been Exceeded
13	Drift Cell 2	Cell Drift Limit Has Been Exceeded
14	Drift Cell 3	Cell Drift Limit Has Been Exceeded
15	Drift Cell 4	Cell Drift Limit Has Been Exceeded

Status Register Number 4		
BIT	Name	Definition
0	Output #1	Setpoint is ON if Bit = '1'
1	Output #2	Setpoint is ON if Bit = '1'
2	Output #3	Setpoint is ON if Bit = '1'
3	Output #4	Setpoint is ON if Bit = '1'
4	Output #5	Setpoint is ON if Bit = '1'
5	Output #6	Setpoint is ON if Bit = '1'
6	Output #7	Setpoint is ON if Bit = '1'
7	Output #8	Setpoint is ON if Bit = '1'
8	Input #1	Input is Activated if Bit = '1'
9	Input #2	Input is Activated if Bit = '1'
10	Input #3	Input is Activated if Bit = '1'
11	Input #4	Input is Activated if Bit = '1'
12	Motion	System is in Motion
13	Zero Successful	Zero Acquired Successfully (active for 5 seconds)
14	Tare Successful	Tare Acquired Successfully (active for 5 seconds)
15	Key Pressed	Front Panel Key Pressed (active for 5 seconds)

SECTION 11. Modbus Protocols

11.1 MODBUS RTU PROTOCOL

This interface method is applicable to virtually any PC or other process control computer with Modbus RTU Master communication capability. The interface provides weight and diagnostic information and allows for remote control of tare, zero, and gross/net/rate functions. New calibration data also may be downloaded via this interface. Information is transmitted in blocks of data, thereby minimizing polling and response time delays. The interface operates with the LCp-104 configured as the slave device and the host computer as the master. To initiate Modbus RTU protocol, simply select the Modbus print format as shown in Figure 6- 1 (page 6-2). Modbus RTU typically uses the standard LCp-104 RS-485/422 communication port and requires no hardware alterations. However, with option [A] [2] installed, Modbus RTU is available through the UART port connector (Figure 11-1). This option allows RS-485, -422, or -232 operation. Option [A] [2] leaves the standard LCp-104 serial port available for communication with a remote display or other serial enabled device.

11.1.1 Common Data Format

Table 11-2 presents a complete overview of Modbus register and bit allocations. Table 11-2 information which appears in conventional text applies to both Modbus RTU and Modbus Plus formats. Allocations which pertain only to Modbus Plus appear in italic text. In addition to Table 11-2 information, the following data formats and definitions are identical for both Modbus protocol options:

Weight Data (BLH format for Modbus Plus) - Two 16 bit signed integers, the first (high) integer must be multiplied by 32768 and then added to the second (low) integer.

Status and setup parameters - One 16 bit unsigned integer.

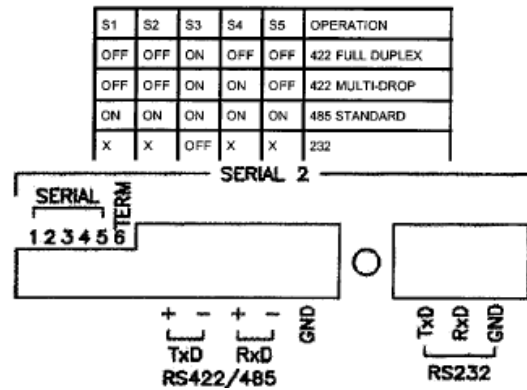

Figure 11-1. RTU Connector/DIP Switch Designations.

Alpha data - For each register: high byte is first character, low byte is second character.

NOTE: If a decimal point is required, the resulting value must be multiplied by the appropriate fraction, i.e., 0.01 for hundreds of a unit. In the case of mV/V values, the multiplier is 0.000001. The LCp-104 range is (-9999991+9999999).

NOTE: counts refer to displayed counts. If displayed weight is counting by 2 lb increments, then presetting a register to 9 would mean 18 lbs.

11.1.2 Modbus RTU Functions Supported

03 Read Holding Registers

06 Preset Single Register

16 (10 Hex) Preset Multiple Registers

11.1.3 Setup

Modbus RTU format, device address, baud rate, and parity are all selectable under the SERIAL 1 section of the I/O MENU.

11.1.4 Manipulating the Front Panel Display

Provision has been made for the host PLC to display messages on the LCp-104 front panel display. Messages may occupy both the upper

(7 character) and lower (8 character) display lines (Figure 11-4, page 11-8). To send a message, the host PLC transmits the message coded in conventional ASCII characters* to registers 40203 thru 40210 along with a display control word; register 40202. Information written to these LCp-104 registers determines not only the message content but also the display time period.

When the host message display time period expires, the LCp-104 will revert to its normal weight/status display. See Table 11-2 and Figure 11-4 for a detailed breakout of register allocations and byte designations.

Host messages displayed on the LCp front panel can be used to alert operators to error conditions, prompt required inputs, etc.

NOTE: Host messages are not displayed if the LCp-104 is in any calibration or parameter configuration menu mode.

11.2 MODBUS PLUS INTERFACE

Thermo BLH is an official ModConnect® Partner. As such, BLH has been authorized by Schneider Automation to incorporate Modbus Plus Communication Technology in its LCp-104 series product line. Modbus Plus protocol allows the LCp-104 to communicate on a peer-to-peer network link with Modicon 984 and Quantum PLC devices.

LCp-104 units equipped with the Modbus Plus option have a custom rear panel with a specific MODBUS PLUS connector (see Figure 11-2 and paragraph 11.2.3). The Modbus Plus interface does not use the standard LCp-104 RS-485/422 communication port.

11.2.1 Routing Path Addressing

The LCp-104 Modbus Plus node is a Host Computer node with 8 data-slave input paths. When using Read/ Write MSTR operations, or multiple Modbus Plus networks, take note of the message routing format. A routing address is five bytes in length. This allows communication between multiple Modbus Plus Networks over Bridge Mux hardware devices. Since the LCp is

a host computer node, two of the five routing address bytes are required to identify it.

The next-to-last non-zero byte specifies the network node station address (1-64). The last non-zero byte specifies the input path or task number (1-8) to which the message is assigned. The other three routing address bytes allow communication through up to 3 Bridge Mux Devices. Table 11-1 depicts the address routing path for an LCp device at address 12, using path/task number 1.

NOTE: If multiple devices access the same LCp, BLH recommends using a different task/path number for each requesting device. This will prevent address contention problems.

Table 11-1. Routing Path Address Designations

Routing Path Example	Five Byte Address
No Bridge Mux Device	12-1-0-0-0
Bridge Mux @ Address 26	26-12-1-0-0
1st Bridge Mux @ Address 26 2nd Bridge Mux @ Address 28 3rd Bridge Mux @ Address 30	26-28-30-12-1

NOTE: Host device routing path format is different from PLC designated device addressing. When using PLC designated devices, the input path/task number is not required since it is automatically selected. NOTE: BLH assumes reader/operator familiarity with Modbus Plus token passing network operation. Readers/operators unfamiliar with Modbus Plus should obtain the 'Modicon Modbus Plus Network Planning and Installation Guide' (GM-MBPL-001) and 'Modicon Ladder Logic Block Library User Guide' (840 USE 101 00) from the Schneider Corporation.

11.2.2 Global Data Transfers

For high-speed process control, BLH recommends that global data transfers be used. LCp-104 global data allocations are defined in the Figure 11-3 parameter selection menu.

11.2.3 Wiring and Node Addressing

Wiring is simply a matter of connecting the Modicon supplied, 9 pin D-type connector cable to the LCp-104 rear panel Modbus PLUS D-type socket mating half (see Figure 11-2).

NOTE: Host device routing path format is different from PLC designated device addressing. When using PLC designated devices, the input path/task number is not required since it is automatically selected.

NOTE: BLH assumes reader/operator familiarity with Modbus Plus token passing network operation. Readers/operators unfamiliar with Modbus Plus should obtain the 'Modicon Modbus Plus Network Planning and Installation Guide' (GM-MBPL-001) and 'Modicon Ladder Logic Block Library User Guide' (840 USE 101 00) from the Schneider Corporation.

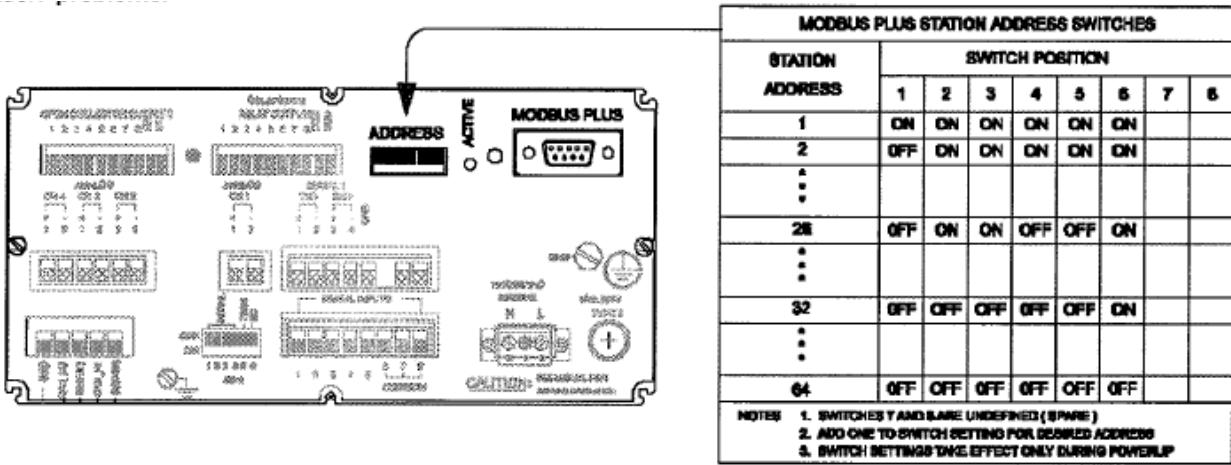

Figure 11-2. Modbus PLUS Rear Panel with Address Designations.

LCp-104 nodes may occupy any station address location from 1 to 64. Selection is made at the rear panel (see table in Figure 11-1) DIP Switch designated ADDRESS. Add '1' to the switch selection to obtain the actual address (i.e., selection-0 +1 =1). DIP switch positions 7 and 8 are unused.

NOTE: Switch selections are read only during power-up. If the address selection is changed, the instrument must be powered down and then powered up again.

11.2.4 Configuration

Figure 11-3 presents the Modbus Plus configuration menu. Parameters are as follows:

ADDRESS is non-configurable. It simply indicates that the network has recognized the LCp-104 device at the designated address.

GLOBAL DATA allows up to 14 words of live weight and status data to be selected for broadcast with each token pass. Each item selected represents two words of global data. The first item selected 'YES' becomes the first two words, the second 'YES' becomes words three and four, and so forth. The seven available selections, status, gross weight, net weight, mV/V, live mV/V, rate, and set points are defined in Figure 11-3.

ROTATION is non-configurable. Rotation shows the time used for one complete token pass of all network nodes.

11.2.5 Data Formatting

Table 11-2 presents a complete overview of Modbus register and bit allocations. Table 11-2 information which appears in conventional text applies to both Modbus RTU and Modbus Plus formats. Allocations which pertain only to Modbus Plus appear in bold italic text.

BLH formatted weight data consists of two 16 bit signed integers, the first (high) integer must be multiplied by 32768 and then added to the second (low) integer (see illustration - next column).

NOTE: If a decimal point is required, the resulting value must be multiplied by the appropriate fraction, i.e. 0.01 for hundreds of a unit. In the case of mV/V values, the multiplier is 0.000001. The LCp-104 range is (-9999991+9999999).

NOTE: counts refers to displayed counts. If displayed weight is counting by 2 lb increments, then presetting a register to 9 would mean 18 lbs.

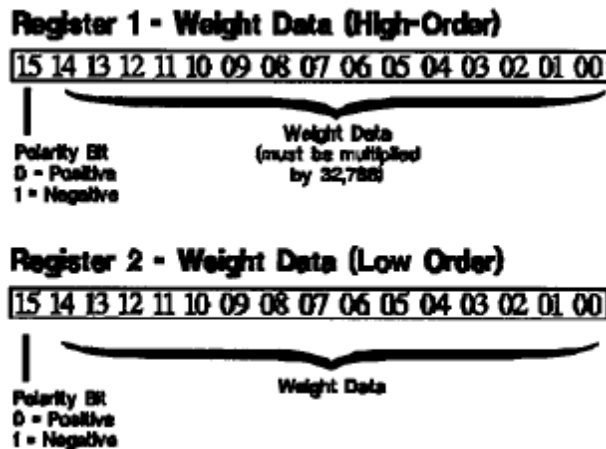

11.2.6 Flashing LED Status

A flashing green `ACTIVE' LED located on the LCp-104 rear panel (Figure 11-2) indicates the status of Modbus Plus network operation. To

interpret flash patterns, refer to the Modbus Plus Planning Guide (GM-MBPL-004).

NOTE: To display flashing status on the LCp-104 front panel, configuring an Alarm/Status Annunciators for `Modbus Plus Status' indication (see Section 5).

11.2.7 Manipulating the Front Panel Display

Provision has been made for the host PLC to display messages on the LCp-104 front panel display. Messages may occupy both the upper (7 character) and lower (8 character) display lines (Figure 11-4, page 11-8). To send a message, the host PLC transmits the message coded in conventional ASCII characters* to registers 40203 thru 40210 along with a display control word; register 40202. Information written to these LCp-104 registers determines not only the message content but also the display time period.

When the host message display time period expires, the LCp-104 will revert to its normal weight/status display. See Table 11-2 and Figure 11-4 for a detailed breakout of register allocations and byte designations.

Host messages displayed on the LCp front panel can be used to alert operators to error conditions, prompt required inputs, etc.

NOTE: Host messages are not displayed if the LCp-104 is in any calibration or parameter configuration menu mode.

Modbus Plus Parameter Selections

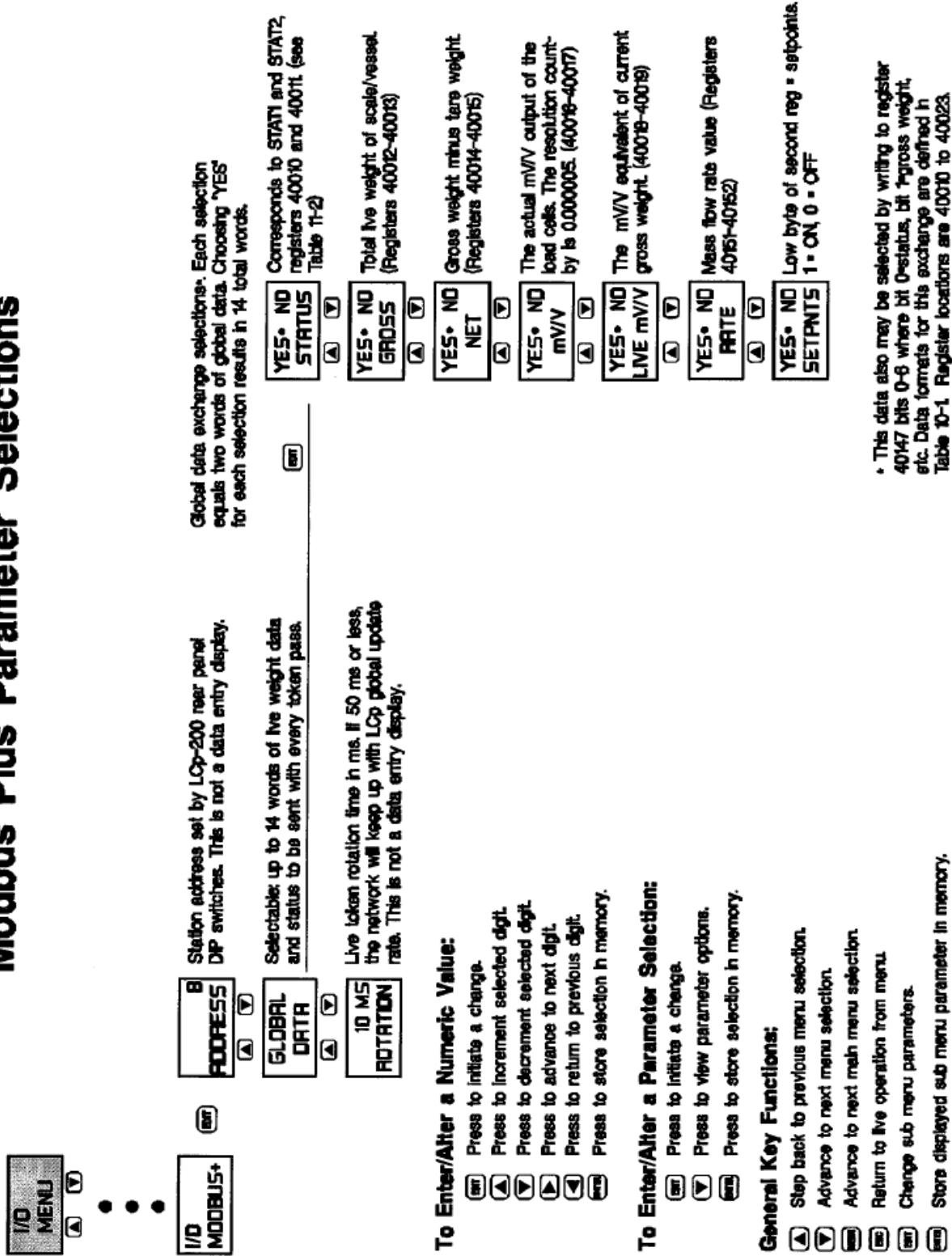

Figure 11-3. Parameter Selection Menu and Global Data Designations.

Table 11-2. Modbus RTU and Plus Register Allocations

Data	Address	Registers	R/W	Data	Address	Registers	R/W
Status 1	40001	1	R	Zero	40129	2	R/W
Status 2	40002	1	R	Tare	40131	2	R/W
Status 3	40003	1	R	Zero Limit %	40133	1	R/W
Status 4	40004	1	R	Overload %	40134	1	R/W
Gross	40005	2	R	Shift Limit %	40135	1	R/W
Net	40007	2	R	Drift Limit +/-	40136	1	R/W
Rate	40009	2	R	Filter	40137	1	R/W
mV/V	40011	2	R	Motion Band	40138	1	RNV
Peak	40013	2	R	Motion Timer	40139	1	R/W
Gross 1	40015	2	R	Rate DV Time	40140	1	R/W
Gross 2	40017	2	R	Set point #1	40141	2	R/W
Gross 3	40019	2	R	Set point #2	40143	2	R/W
Gross 4	40021	2	R	Set point #3	40145	2	R/VV
Net 1	40023	2	R	Set point #4	40147	2	R/W
Net 2	40025	2	R	Set point #5	40149	2	RNV
Net 3	40027	2	R	Set point #6	40151	2	RNV
Net 4	40029	2	R	Set point #7	40153	2	R/W
mV/V 1	40031	2	R	Set point #8	40155	2	R/W
mV/V2	40033	2	R	Inflight #1	40157	1	R/W
mV/V 3	40035	2	R	Inflight #2	40158	1	R/W
mV/V4	40037	2	R	Inflight #3	40159	1	RNV
Peak 1	40039	2	R	Inflight #4	40160	1	R/W
Peak 2	40041	2	R	Inflight #5	40161	1	R/W
Peak 3	40043	2	R	Inflight #6	40162	1	R/W
Peak 4	40045	2	R	Inflight #7	40163	1	R/W
% Load 1	40047	1	R	Inflight #8	40164	1	RNV
% Load 2	40048	1	R	Tag #1	40165	4	RNV
% Load 3	40049	1	R	Tag #2	40169	4	R/W
% Load 4	40050	1	R ₁	Tag #3	40173	4	RNV
% Shift 1	40051	1	R	Tag #4	40177	4	R/W
% Shift 2	40052	1	R	Tag #5	40181	4	R/W
% Shift 3	40053	1	R	Tag #6	40185	4	R/W
% Shift 4	40054	1	R	Tag #7	40189	4	RNV
+ Drift 1	40055	1	R	Tag #8	40193	4	R/W
+ Drift 2	40056	1	R	System Tag	40197	4	R/W
+ Drift 3	40057	1	R	Command*	40201	1	R/W
+ Drift 4	40058	1	R	Control Data	40202	1	R/W
- Drift 1	40059	1	R	Upper Display	40203	4	R/W
- Drift 2	40060	1	R	Lower Display	40207	4	R/W
-Drift 3	40061	1	R	Global Data	40211	1	R/W
- Drift 4	40062	1	R				
Zero 1	40063	2	R	*Command Register			
Zero 2	40065	2	R	One Shot Write Value			Function
Zero 3	40067	2	R	1			Tare
Zero 4	40069	2	R	2			Zero
Serial #	40071	4	R	3			Switch to Net
Software Ver	40075	1	R	4			Switch to Gross
Ref. Date	40076	3	R	5			Switch to Rate

Table 11-3. Status Word Bit Designations.

Status Register Number 1		
BIT	Name	Definition
0	Power Up	JBox Power Up (true for 5 seconds)
1	Spare	
2	Lost Tare	Checksum Error at Power Up
3	Lost Zero	Checksum Error at Power Up
4	No m $\sqrt{\sqrt{}}$ Cal	Checksum Error at Power Up
5	No Engineering Cal	Checksum Error at Power Up
6	No Temperature Compensation	Checksum Error at Power Up
7	EEPROM Error	Error Writing EEPROM
8	Comm Power Fault	Serial Output - Power Supply Fault
9	JBox Power Low	Power to JBox is Low
10	Linking	Attempting Communication Link to JBox
11	Unable to Tare/Zero: Motion	System in Motion (true for 5 seconds)
12	Analog #1 Open	Open Connection
13	Analog #1 Underrange	Weight Data Below Analog Output Range
14	Analog #1 Overrange	Weight Data Above Analog Output Range
15	Spare	
Status Register Number 2		
BIT	Name	Definition
0	ND Overrange Channel (Cell) 1	Signal Greater Than AID Range
1	ND Overrange Channel (Cell) 2	Signal Greater Than ND Range
2	ND Overrange Channel (Cell) 3	Signal Greater Than ND Range
3	ND Overrange Channel (Cell) 4	Signal Greater Than ND Range
4	Spare	
5	Spare	
6	Spare	
7	Spare	
8	Excitation Open Channel (Cell) 1	Load Cell Not Connected
9	Excitation Open Channel (Cell) 2	Load Cell Not Connected
10	Excitation Open Channel (Cell) 3	Load Cell Not Connected
11	Excitation Open Channel (Cell) 4	Load Cell Not Connected
12	Excitation Low Channel (Cell)	Check Wiring for Short(s)
13	Excitation Low Channel (Cell)	Check Wiring for Short(s)
14	Excitation Low Channel (Cell)	Check Wiring for Short(s)
15	Excitation Low Channel (Cell)	Check Wiring for Short(s)

Table 11-3. Status Word Bit Designations (continued)

Status Register Number 3		
BIT	Name	Definition
0	Overload Limit Cell 1	Cell Overload Value Has Been Exceeded
1	Overload Limit Cell 1	Cell Overload Value Has Been Exceeded
2	Overload Limit Cell 1	Cell Overload Value Has Been Exceeded
3	Overload Limit Cell 1	Cell Overload Value Has Been Exceeded
4	Zero Limit Cell 1	Cell Zero Limit Has Been Exceeded
5	Zero Limit Cell 2	Cell Zero Limit Has Been Exceeded
6	Zero Limit Cell 3	Cell Zero Limit Has Been Exceeded
7	Zero Limit Cell 4	Cell Zero Limit Has Been Exceeded
8	Load Shift Cell 1	Cell Shift Limit Has Been Exceeded
9	Load Shift Cell 2	Cell Shift Limit Has Been Exceeded
10	Load Shift Cell 3	Cell Shift Limit Has Been Exceeded
11	Load Shift Cell 4	Cell Shift Limit Has Been Exceeded
12	Drift Cell 1	Cell Drift Limit Has Been Exceeded
13	Drift Cell 2	Cell Drift Limit Has Been Exceeded
14	Drift Cell 3	Cell Drift Limit Has Been Exceeded
15	Drift Cell 4	Cell Drift Limit Has Been Exceeded

Status Register Number 4		
BIT	Name	Definition
0	Output #1	Set point is ON if Bit = '1'
1	Output #2	Set point is ON if Bit = '1'
2	Output #3	Set point is ON if Bit = '1'
3	Output #4	Set point is ON if Bit =
4	Output #5	Set point is ON if Bit = '1'
5	Output #6	Set point is ON if Bit = '1'
6	Output #7	Set point is ON if Bit = '1'
7	Output #8	Set point is ON if Bit =
8	Input #1	Input is Activated if Bit = '1'
9	Input #2	Input is Activated if Bit = '1'
10	Input #3	Input is Activated if Bit = '1'
11	Input #4	Input is Activated if Bit = '1'
12	Motion	System is in Motion
13	Zero Successful	Zero Acquired Successfully (active for 5 seconds)
14	Tare Successful	Tare Acquired Successfully (active for 5 seconds)
15	Key Pressed	Front Panel Key Pressed (active for 5 seconds)

LCp Upper Display Line

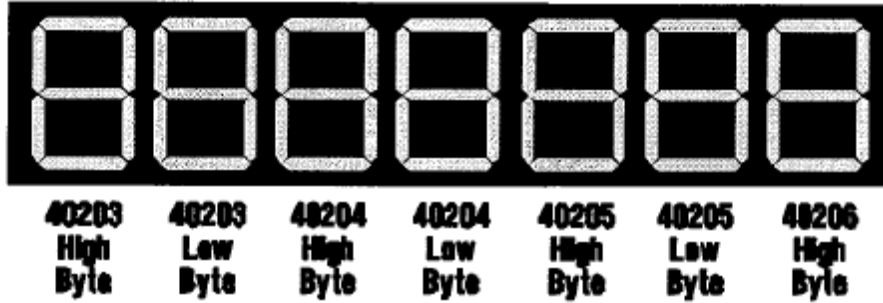

LCp Lower Display Line

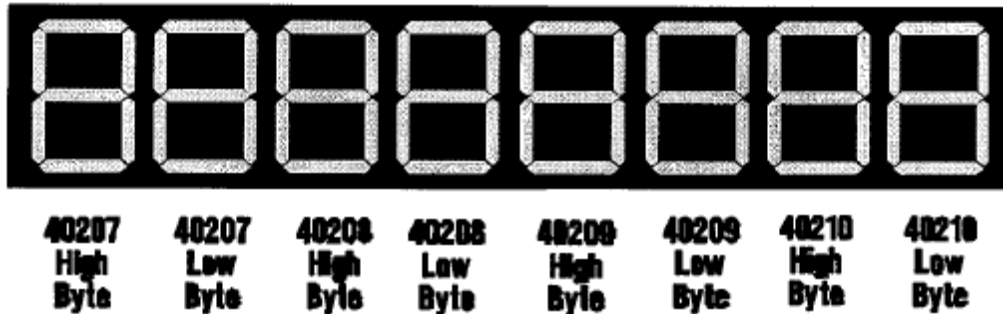

Figure 11-3. Front Panel Display Write - Register and Byte Allocations.

Address	Data Format	# Registers	Register Contents
40202	Control Data	1 Register	if bit 0 = 1, apply data in registers 40203-40206 to upper display if bit 1 = 1, apply data in registers 40207-40210 to lower display if bit 2 = 1 and bit 0 = 1, flash the upper display if bit 3 = 1 and bit 1 = 1, flash the lower display
40203 - 40206	Upper Display Data	4 Registers	see Figure 11-3 for byte allocations
40207-40210	Lower Display Data	4 Registers	see Figure 11-3 for byte allocations

SECTION 12. DeviceNet Protocols

This chapter defines the optional DeviceNet interface as it pertains to BLH LCp-104 instruments. DeviceNet is a low cost industrial network designed to easily connect up to 64 "cell" type devices to a PLC/PC. Information in this section defines the LCp-104 DeviceNet register allocations and interface instructions.

12.1 THE INTERFACE DEFINED

12.1.1 General ODVA DeviceNet Description

DeviceNet is one of the world's leading device-level networks for industrial automation. In fact, more than 40% of end users surveyed by independent industry analysts report choosing DeviceNet over other networks. DeviceNet offers robust, efficient data handling because it is based on Producer/Consumer technology. This modern communications model offers key capabilities that allow the user to effectively determine what information is needed and when. Users also benefit from ODVA's strong conformance testing policies, which ensure that products are interoperable. As a result, users can mix-and-match products from a variety of suppliers and integrate them seamlessly.

NOTE: ODVA stands for Open DeviceNet Vendor Association. For all specifications, wiring, power, cable lengths, etc., please access the ODVA web site. Reference: Specifications DeviceNet Volume II, release 2.0 (latest release), web address: <http://www.odva.org>

12.1.2 LCp-104 DeviceNet Interface Description

The LCp-104 DeviceNet interface uses vendor supplied product technology. This product has passed the compliance specifications set forth by ODVA and is registered with them (ODVA) by the vendor. BLH embeds this product in the LCp-104 to communicate weight and parameter data to a connected device. Thermo BLH is registered with ODVA as Vendor #661.

12.2 INTERFACE WIRING

Figure 12-1 depicts the LCp-104 rear panel DeviceNet connector. Each unit has a DeviceNet compatible sealed micro connector. Make connections in accordance with pinouts as shown.

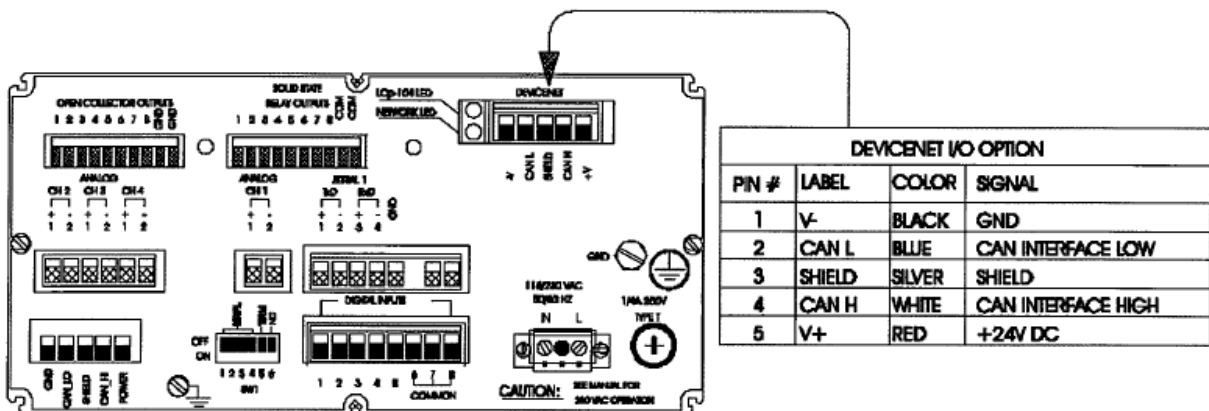

Figure 12-1. DeviceNet Rear Panel Wiring Configurations and LED Status.

12.3 LED STATUS INDICATION

Two bicolor (red/green) LED indicators are mounted beside the network connector (Figure 12-1). The upper LED indicates LCp-104 status

while the lower LED displays the DeviceNet Network Status. If an LED is flashing, the nominal flash rate is 500ms ON, and 500ms OFF.

12.3.1 LCp-104 Status

The upper (LCp-104 status) LED indicator flash sequences are defined in the following Table:

LED Status	LCp-104 Network Status
Off	No Power
Flashing Red	Recoverable configuration fault (invalid firmware, OEM data, or personality data)
Solid Red	Hardware error
Flashing Green	No errors, client interface is not open
Solid Green	No errors, client interface is active
Red/Green	Configuration mode

12.3.2 DeviceNet Network Status

The lower (network status) LED indicator flash sequences are defined in the following Table:

LED Status	DeviceNet Network Status
Off	No Power
Flashing Red	I/O connection in timed-out state or other recoverable fault
Solid Red	Unrecoverable fault
Flashing Green	Device is online but has no connections
Solid Green	Device is online with established connections
Red/Green	Device is in communication faulted state and responding to an identify communication faulted request

12.4 LCp-104 MENU CHANGES

With the DeviceNet option installed, parameter selections change in several menus. These changes override definitions and selections presented in earlier chapters of this manual. The following pages discuss specific changes to several menus.

12.4.1 I/O Menu Changes

With DeviceNet installed, other expansion slot A interfaces are disabled. Figure 12-2 shows the modified I/O menu with DeviceNet available rather than Modbus Plus, Allen-Bradley Remote I/O, or Profibus. Baud rates, address selections, and commands can be selected through the front panel display under the I/O Device N menu. Baud

rate selection must be identical to the master control setting. The Mac ID address must be uniquely different from all other nodes. Additional DeviceNet selections allow individual units to be reset or taken off-line.

NOTE: Go commands can be used if an operator wants to change settings on the LCp-104 and does not want invalid data to be sent to the master controller. Also, if a customer wants to change baud rate or Mac id, the LCp-104 must be off line.

NOTE: Upon power-up the LCp-104 will attempt to link to a master host.

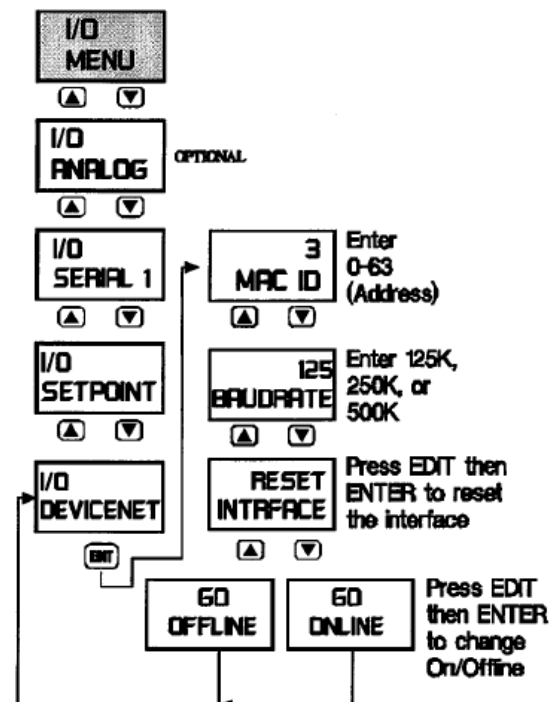

Reset: This command is a hard reset of the Devicenet interface. Reset also transpires during power-up.

Go online: This command can be issued from the LCp-104 to instruct the DeviceNet interface to initiate communication with a master.

Go offline: This command can be issued from the LCp-104 to instruct the Devicenet interface to stop communication with a master.

Figure 12-2. I/O Menu Changes.

12.4.2 Diagnostic Menu Changes

Figure 13-3 presents changes to the diagnostic menu. Two added features define DeviceNet errors if they occur and current online/offline status.



Error Number	Description
1	Hardware Error
2	Configuration Mode
4	Start-Up Error
5	Assert Error
6	Abort Error
7	Kernal Error
8	Watchdog Time-Out
9	Unreported Watchdog Time-Out
10	Invalid Module Status
16	Module Not Present
20	Unresolved Hardware Interrupt
21	Busy Time-Out
32	ID Block Major Rev Mismatch
33	ID Block Minor Rev Mismatch
34	Control/Status Block Major Rev Mismatch
35	Control/Status Block Minor Rev Mismatch
48	Open Interface Response Time-Out
49	Heartbeat Response Time-Out
50	Module Reported Heartbeat Time-Out
51	Invalid Trigger Out Pointer
52	Invalid Trigger In Pointer
53	Trigger Que is Full
54	Invalid Event Out Pointer
55	Invalid Event In Pointer
56	Trigger Error Event Received
57	Invalid Event Received
58	Unexpected Event Received
64	Data Idle
65	Data Invalid

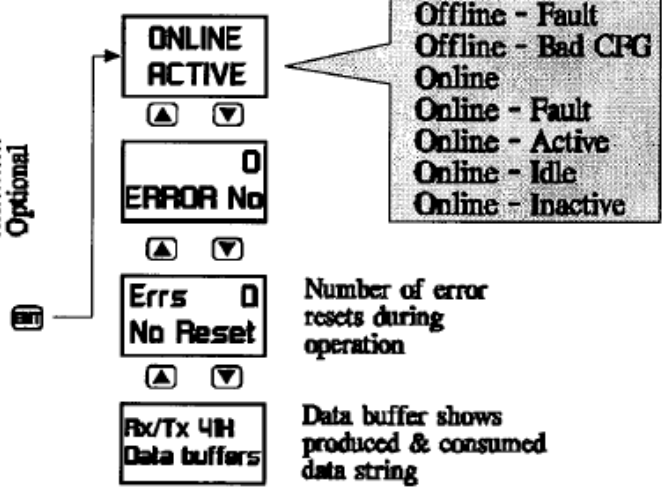

Figure 13-3. Diagnostic Menu Changes.

12.4.3 Display Menu Changes

See Figure 12-4 for alarm annunciator changes. The DeviceNet selection allows the lower rear

panel network status LED activity to be mirrored on one of the eight front panel annunciators. Behavior of this LED is network specific and defined in Figure 12-4.

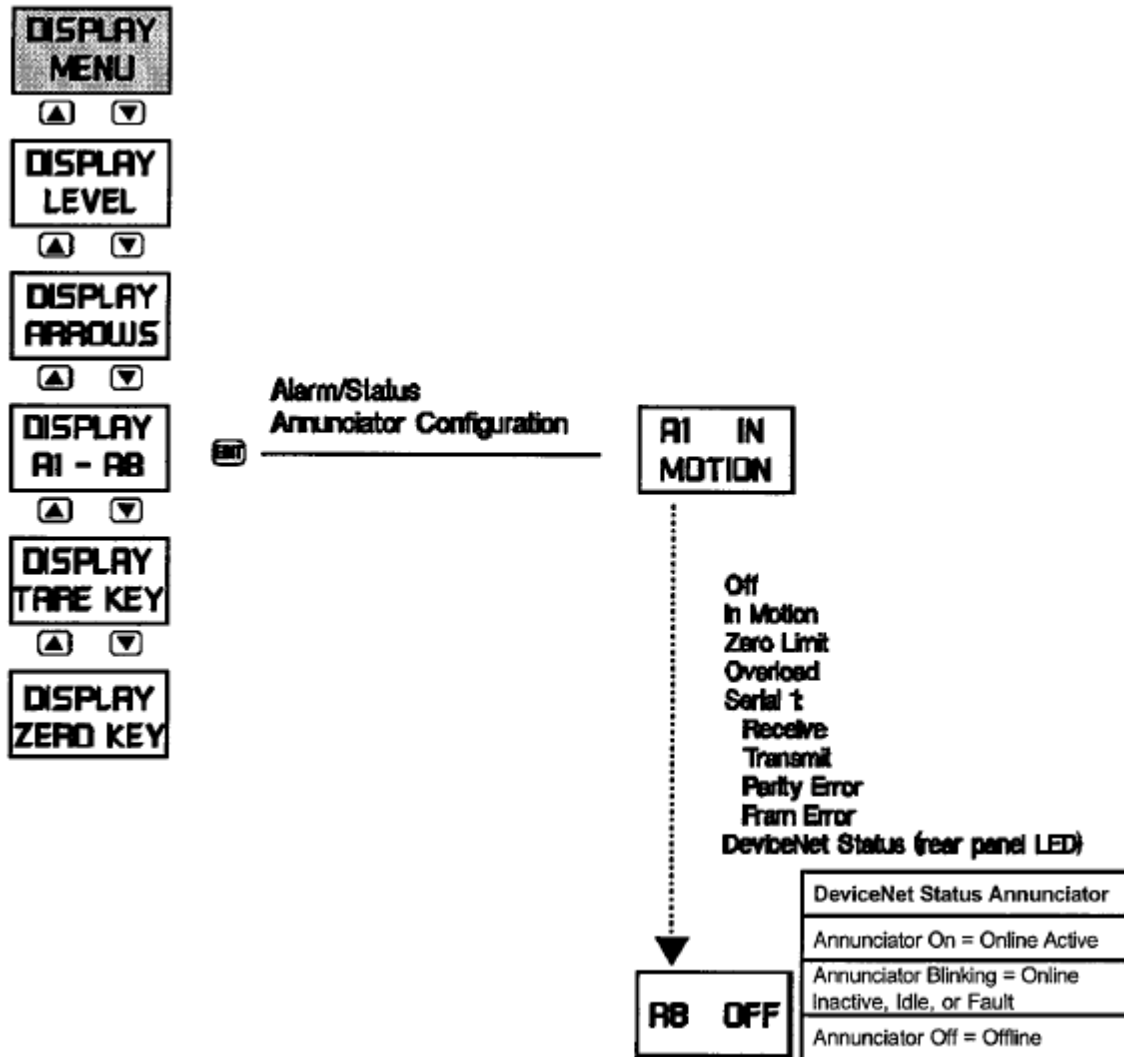

Figure 12-4. Display Menu Changes.

12.5 DATA EXCHANGE FORMATS

LCp-104 DeviceNet input and output data formats consist of up to 8 bytes each as shown in

Table 12-1. Each grouping of two bytes constitutes one 16-bit word.

Table 12-1. Data Exchange Formats

Input data format				
msg#	Data ID	status	data low	data high
Word 1		Word 2	Word 3	Word 4
byte1	byte2	byte3 byte4	byte5 byte6	byte7 byte8
Output data format				
msg#	Data ID	command	data low	data high
Word 1		Word 2	Word 3	Word 4
byte1	byte2	byte3 byte4	byte5 byte6	byte7 byte8

12.5.1 Produced Data (LCp-104 Transmission)

The input data string is transmitted by the LCp-104 to the requesting master device. Each string consists of eight bytes and breaks down as follows:

- Byte 1. Message #: Message # is an echo of the first byte of the output data string (transmitted by the master). This is used by the master for data transfer verification.
- Byte 2. Input data ID: Data ID code as shown in Table 12-4.
- Bytes 3 & 4. Status: The LCp-104 operating status - each bit of the word

made up of bytes 3 & 4 represents specific operating status. The descriptions of the bits are in Table 13-2. Bits 0 - 7 are in Byte 3, bits 8- 15 are in Byte 4.

- Bytes 5 - 8 (Words 3 & 4). Input data: These two words contain the actual weight value (low word and then high word). Word 3, low word, is a 16 bit signed integer -32768 to 32767 with byte 5 being the low byte. Word 4, high word, is a 16 bit signed integer times 32768 with byte 7 being the low byte. If word 3 = 2 and word 4 = 1, the total data value would be 32770 (2 + 32768).

Table 12-2. Status Word Definitions

Status Word					
Bit Description		Decimal Point Position			
0	Decimal Point Position A	C	B	A	Position
1	Decimal Point Position B	0	0	0	0
2	Decimal Point Position C	0	0	1	0.0
3	Powering up or Linking to Jbox	0	1	0	0.00
4	Motion	0	1	1	0.000
5	Zero successful	1	0	0	0.0000
6	Tare successful	1	0	1	0.00000
7	Unable to Zero/Tare	1	1	0	0.000000
8	Status register one				
9	Status register two		Display Data		
10	Status register three		B	A	Display
11	Status register four		B	A	Gross
12	Display A				Rate
13	Display B			0	Rate
14	Download address error				Spans
15	Download data error				

12.5.2 Consumed Data (LCp-104 Receive)

Output data is transmitted to the LCp-104 by the requesting master. It consists primarily of command and ID data. ID data is defined in Table 12-4. Each string consists of eight bytes and breaks down as follows:

Table 12-3. DeviceNet Master Command List

Profibus Interface Commands	
Command ID	Description
0	Null Command
1	Switch to Gross
2	Switch to Net
3	Switch to Rate
4	Zero Gross Weight
5	Tare Net Weight
6	Download Data

- Byte 1. Message #: Any number between 0 and 255 generated by the master and copied by the LCp-104 into the first byte of the input string for host data transfer verification.
- Byte 2. Output data ID. When the DeviceNet master issues a download command, it must include the output data ID and the output data as well. Byte 2 provides output data ID code as shown in Table 12-4.
- Bytes 3 & 4 (Word 2). Command: This command word is used by DeviceNet master to control LCp-104 (as a slave). The meanings of commands are shown in Table 12-3.
- Bytes 5 - 8 (Words 3 & 4). Output Data: The third and fourth words of the DeviceNet output are low word and high word of the actual download data. Word 3, low word, is a 16 bit signed integer -32768 to 32767. Word 4, high word, is a 16 bit signed integer times 32768. See example in Inputs Words 3 & 4 definition. See Table 12-4 for ID codes and definitions of writable data.

Table 12-4. DeviceNet Data Identification Codes

DeviceNet Data ID Codes				
Type	ID Code	Data	Words	Description
System	0	Status 1&2	2	System status registers 1&2 (see Table 12-5)
System	1	Status 3&4	2	System status registers 3&4 (see Table 12-6)
Operate	2	Gross	2	Current Total Gross Data
Operate	3	Net	2	Current Total Net Data
Operate	4	Rate	2	Current Rate data
Arrow K	5	Mv/v	2	mV/V average signal from load cell's (actual)
spare	6	spare	2	spare
Indy K	7	Gross Cell 1	2	Gross data from cell one
Indy K	8	Gross Cell 2	2	Gross data from cell two
Indy K	9	Gross Cell 3	2	Gross data from cell three
Indy K	10	Gross Cell 4	2	Gross data from cell four
Indy K	11	Net cell 1	2	Net data from cell one
Indy K	12	Net cell 2	2	Net data from cell two
Indy K	13	Net cell 3	2	Net data from cell three
Indy K	14	Net cell 4	2	Net data from cell four
Indy K	15	mV/V cell 1	2	Mv/v data from cell one
Indy K	16	mV/V cell 2	2	Mv/v data from cell two
Indy K	17	mV/V cell 3	2	Mv/v data from cell three

Table 12-4. DeviceNet Data Identification Codes (cont.)

DeviceNet Data ID Codes				
Type	ID Code	Data	Words	Description
Indy K	18	Mv/v cell 4	2	Mv/v data from cell four
spare	19	spare	2	spare
spare	20	spare	2	spare
spare	21	spare	2	spare
spare	22	spare	2	spare
Indy K	23	% load cell 1	1	Percent live load on cell one
Indy K	24	% load cell 2	1	Percent live load on cell two
Indy K	25	% load cell 3	1	Percent live load on cell three
Indy K	26	% load cell 4	1	Percent live load on cell four
Diag M	27	% shift cell 1	1	Percent shift on load cell one
Diag M	28	% shift cell 2	1	Percent shift on load cell two
Diag M	29	% shift cell 3	1	Percent shift on load cell three
Diag M	30	% shift cell 4	1	Percent shift on load cell four
Diag M	31	Plus drift cell 1	1	Positive drift on load cell one
Diag M	32	Plus drift cell 2	1	Positive drift on load cell two
Diag M	33	Plus drift cell 3	1	Positive drift on load cell three
Diag M	34	Plus drift cell 4	1	Positive drift on load cell four
Diag M	35	Neg drift cell 1	1	Negative drift on load cell one
Diag M	36	Neg drift cell 2	1	Negative drift on load cell two
Diag M	37	Neg drift cell 3	1	Negative drift on load cell three
Diag M	38	Neg drift cell 4	1	Negative drift on load cell four
Diag M	39	Zero cell 1	2	Aquired zero data for cell one
Diag M	40	Zero cell 2	2	Aquired zero data for cell two
Diag M	41	Zero cell 3	2	Aquired zero data for cell three
Diag M	42	Zero cell 4	2	Aquired zero data for cell four
Diag M	43	Tare cell 1	2	Aquired tare data for cell one
Diag M	44	Tare cell 2	2	Aquired tare data for cell two
Diag M	45	Tare cell 3	2	Aquired tare data for cell three
Diag M	46	Tare cell 4	2	Aquired tare data for cell four
Diag M	47	Serial number	2	7 Digit number in decimal fronnat *
Diag M	48	Software ver	1	3 Digit number in decimal format *
Diag M	49	Ref date	2	6 Digit number in decimal format *
Diag M	50	Zero total	2	Zero data total if Downloaded Zero data / number of cells

Table 12-4. DeviceNet Data Identification Codes (cont.)

Type	ID Code	Data	Words	Description
Diag M	51	Tare total	2	Tare data total if Downloaded Tare data / number of cells
Diag M	52	Zero limit	2	Zero total limit allowed
Diag M	53	Overload limit	2	Overload total limit allowed (if zero = no overload protection)
Diag M	54	Shift limit	1	Shift max. limit allowed before setting fault (if zero = no shift)
Diag M	55	Drift limit	1	Drift max. limit allowed before setting fault (if zero = no drift)
Filter M	56	Filter averaging	1	Fliter setting (off, 1-12 decimal)
Diag M	57	Motion band	1	Motion setting (off, 1-58 decimal)
Diag M	58	Motion timer	1	Motion timer setting 0-4 sec (0-7 decimal)
spare	59	spare	2	spare
Spnt K	60	Set point 1	2	Set point one main value
Spnt K	61	Set point 2	2	Set point two main value
Spnt K	62	Set point 3	2	Set point three main value
Spnt K	63	Set point 4	2	Set point four main value
Spnt K	64	Set point 5	2	Set point five main value
Spnt K	65	Set point 6	2	Set point six main value
Spnt K	66	Set point 7	2	Set point seven main value
Spnt K	67	Set point 8	2	Set point eight main value
I/O M	68	Inflight 1	1	Inflight one value
I/O M	69	Inflight 2	1	Inflight two value
I/O M	70	Inflight 3	1	Inflight three value
I/O M	71	Inflight 4	1	Inflight four value
I/O M	72	Inflight 5	1	Inflight five value
I/O M	73	Inflight 6	1	Inflight six value
I/O M	74	Inflight 7	1	Inflight seven value
I/O M	75	Inflight 8	1	Inflight eight value
I/O M	76	Tag id 1	2	Tag low (4 asscii char) , { 31-39, 41-5A, 20 & 2D hex)
I/O M	77	Tag id 1	2	Tag high (4 asscii char)
I/O M	78	Tag id 2	2	Tag low (4 asscii char)
I/O M	79	Tag id 2	2	Tag high (4 asscii char)
I/O M	80	Tag id 3	2	Tag low (4 asscii char)
I/O M	81	Tag id 3	2	Tag high (4 asscii char)
I/O M	82	Tag id 4	2	Tag low (4 asscii char)
10 M	83	Tag id 4	2	Tag high (4 asscii char)

Table 124. DeviceNet Data Identification Codes (cont.)

Type	ID Code	Data	Words	Description
I/O M	84	Tag id 5	2	Tag low (4 ascii char)
I/O M	85	Tag id 5	2	Tag high (4 ascii char)
I/O M	86	Tag id 6	2	Tag low (4 ascii char)
I/O M	87	Tag id 6	2	Tag high (4 ascii char)
I/O M	88	Tag id 7	2	Tag low (4 ascii char)
I/O M	89	Tag id 7	2	Tag high (4 ascii char)
I/O M	90	Tag id 8	2	Tag low (4 ascii char)
I/O M	91	Tag id 8	2	Tag high (4 ascii char)
Diag M	92	User tag	2	User tag 3 digits high (same as setpoint ascii)
Diag M	93	User tag	2	User tag 4 digits low (same as setpoint ascii)
Display	94	Control data	1	Control data for lower & upper display messaging
Display	95	Upper display	2	Upper display first 4 chars (ascii)* see note
Display	96	Upper display	2	Upper display last 3 chars (ascii)
Display	97	Lower display	2	Lower display first 4 chars (ascii)
Display	98	Lower display	2	lower display last 4 chars (ascii)

Registers I- 49 are read only, 50 - 98 are read/write

FOR DISPLAY MESSAGING:

REGISTER 94 CONTROL if bit 0 = 1 apply data in registers 95&96 to upper display
 if bit 1 = 1 apply data in registers 97&98 to lower display
 if bit 2 = 1 & bit 0 = 1 flash the upper display
 if bit 3 = 1 & bit 1 = 1 flash the lower display
 bits 4-7 are spares, set to zero
 bits 8-15 are the display timer, each increment adds 50 msec i.e.
 00000001 = 50msec timer; 0000010 = 100 msec timer

Note: For display messaging all following hex code are acceptable.

30 - 7A (hex) numbers and letters or symbols, also space 20H or minus 2DH

Note: Messaging will only display if Lcp-104 is in weight operating mode. (no menu routines)

Table 12-5. DeviceNet Status Registers 1 and 2.

DeviceNet Status Register #1		
BIT	NAME	Definition
0	spare	
1	spare	
2	Lost tare	Checksum error @ power up
3	Lost zero	Checksum error @ power up
4	No mv/v cal	Checksum error @ power up
5	No engineering cal	Checksum error @ power up
6	No temperature cal	Checksum error @ power up
7	Eeprom error	Error writing eeprom
8	Comm power fault	Serial output - power supply fault
9	spare	
10	spare	
11	spare	
12	Analog #1 open	Open connection
13	Analog #1 underrange	Weight data below analog output range
14	Analog #1 overrange	Weight data above analog output range
15	spare	

DeviceNet Status Register #2		
BIT	NAME	Definition
0	A/d overrange channel cell 1	Signal greater than ND range
1	A/d overrange channel cell 2	Signal greater than ND range
2	A/d overrange channel cell 3	Signal greater than ND range
3	A/d overrange channel cell 4	Signal greater than ND range
4	spare	
5	spare	
6	spare	
7	spare	
8	Excitation open channel cell 1	Load cell not connected
9	Excitation open channel cell 2	Load cell not connected
10	Excitation open channel cell 3	Load cell not connected
11	Excitation open channel cell 4	Load cell not connected
12	Excitation Low channel cell 1	Check cell for shorts
13	Excitation Low channel cell 2	Check cell for shorts
14	Excitation Low channel cell 3	Check cell for shorts
15	Excitation Low channel cell 4	Check cell for shorts

Table 12-6. DeviceNet Status Registers 3 and 4

DeviceNet Status Register #3		
BIT	NAME	Definition
0	Overload limit cell 1	Cell overload value has been exceeded
1	Overload limit cell 2	Cell overload value has been exceeded
2	Overload limit cell 3	Cell overload value has been exceeded
3	Overload limit cell 4	Cell overload value has been exceeded
4	Zero limit cell 1	Cell zero limit has been exceeded
5	Zero limit cell 2	Cell zero limit has been exceeded
6	Zero limit cell 3	Cell zero limit has been exceeded
7	Zero limit cell 4	Cell zero limit has been exceeded
8	Load shift cell 1	Cell shift limit has been exceeded
9	Load shift cell 2	Cell shift limit has been exceeded
10	Load shift cell 3	Cell shift limit has been exceeded
11	Load shift cell 4	Cell shift limit has been exceeded
12	Drift cell 1	Cell drift limit has been exceeded
13	Drift cell 2	Cell drift limit has been exceeded
14	Drift cell 3	Cell drift limit has been exceeded
15	Drift cell 4	Cell drift limit has been exceeded
DeviceNet Status Register #4		
BIT	NAME	Definition
0	Output #1	Set point is on if bit = '1'
1	Output #2	Set point is on if bit = '1'
2	Output #3	Set point is on if bit = '1'
3	Output #4	Set point is on if bit = '1'
4	Output #5	Set point is on if bit = '1'
5	Output #6	Set point is on if bit = '1'
6	Output #7	Set point is on if bit = '1'
7	Output #8	Set point is on if bit = '1'
8	Input # 1	Input is activated if bit = '1'
9	Input # 2	Input is activated if bit = '1'
10	Input #3	Input is activated if bit = '1'
11	Input #4	Input is activated if bit = '1'
12	spare	
13	spare	
14	spare	
15	spare	

12.6 DeviceNet EDS FILE

An Electronic Data Sheet (EDS) is a simple file format that includes the device's configurable parameters and public interfaces to those

parameters. It provides user friendly configuration tools that can be easily updated without having to constantly revise the configuration software tool. EDS files are used by network tools to read or set device

parameters. Table 12-7 presents the simple EDS file code used for the LCp-104.

12.7 DeviceNet CABLE CONSIDERATIONS

Table 12-8 shows the length vs. baud rate and wire gage specifications required for Device Net communication.

Table 12-8. DeviceNet Cable Considerations

Cable Type and Maximum Length	
Communication Rate	Cable Length (m)
125 kb	500
250 kb	250
500 kb	100
DeviceNet Cable Specifications: 2- Shielded Twisted Pairs Data Pair - 18 awg; blue, white Power Pair - 15 awg; black, red Drain Wire - 18 awg non-insulated	

Table 12-7. Actual EDS File Code

\$ DeviceNet Electronic Data Sheet

\$ Electronic Data Sheet generated using SST EDS Editor

\$ Copyright (C) 1998 S-S Technologies Inc.

[File]

```
DescText = "Weight/Rate Transmitter eds file";
CreateDate = 11-16-00;
CreateTime = 11:19:02;
ModDate = 01-18-01;
ModTime = 09:48:45;
Revision = 1.0;
```

[Device]

```
VendCode = 661;
VendName = "Thermo BLH";
ProdType = 12;
ProdTypeStr = "Communication Adapter"; ProdCode = 1;
MajRev = 1;
MinRev = 1;
ProdName = "Lcp-series";
Catalog
```

[I/O.Info]

```
Default = 0x0001;
PollInfo = 0x000D, 1, 1;
COS Info = 0x000D, 1, 1;
CyclicInfo = 0x000D, 1, 1;
Input1=
8, 0, 0x000D, "input1",
2, "61 49",
Output1=
8, 0, 0x000D, "output1",
2, "61 4F",
```

[ParamClass] [Params]

[EnumPar]

[Groups]



BLH

3 Edgewater Drive,
Norwood, MA 02062 U.S.A.

Phone (781)298-2200

Fax (781)762-3988

www.vishaypg.com