

EEVblog Electronics Community Forum

A Free & Open Forum For Electronics Enthusiasts & Professionals

Hello volvo_nut_v70

Show unread posts since last visit.
Show new replies to your posts.
March 31, 2022, 08:06:07 pm

This topic

News:
No news is good news. Be excellent to each other.

- Home
- Help
- Search
- Profile
- About us
- My Messages
- Calendar
- Links
- Members
- Logout

EEVblog Electronics Community Forum » Electronics » Metrology » Valhalla 2701c schematics + firmware V3

« previous next »

Pages: 1 2 3 4 [All] **Go Down**

[REPLY](#) [NOTIFY](#) [MARK UNREAD](#) [SEND THIS TOPIC](#) [PRINT](#) [SEARCH](#)

Author

Topic: Valhalla 2701c schematics + firmware V3 (Read 15351 times)

volvo_nut_v70 and 1 Guest are viewing this topic.

lowimpedance

Super Contributor



Posts: 1200

Country:

Watts in an ohm?



Valhalla 2701c schematics + firmware V3

« on: December 21, 2017, 02:53:58 am »

[Say Thanks](#) [Reply](#) [Quote](#)

After searching high and low there appears to be no schematics for the 2701c online. So having located a paper copy I will add here the schematics plus the parts lists and any other extra info that is not already uploaded, including a dump of the firmware, as I get the spare time. To start with we have the Main PCB with the parts overlay and useful notes plus the relevant schematics.

Additional is the option I-T2 120mA option schematic.

One thing that I have not found answered yet is the firmware different for units with the current option installed or is it all the same and there is a jumper or link on the main PCB that tells the system it is present 🤔. A possible hint might be from the GPIB option where on the schematic there is a pin on the header connection to the main PCB, (pin 20), called IEEE FIT tied to 0V which pulls down a pin on a 6821, (pin 16 portb), when plugged in. So perhaps the firmware just checks a logic level for the current option too !.





Edit:1. added display and GPIB schematics + comp overlays.

2. Had a good look on the main PCB and schematics and it looks like there is no test for the current option so its most likely a firmware difference, pity.

I noted that the firmware from a 2701c with the current option was obtained but had not been uploaded, in this thread :

<https://www.eevblog.com/forum/metrology/tear-down-valhalla-2707a/msg941497/#msg941497>

Would be nice to try the firmware for the current option one day !.

-  main BD comp lc.pdf (225.57 kB - downloaded 519 times.)
-  main board cct.pdf (500.24 kB - downloaded 621 times.)
-  120mA option cct.pdf (78.82 kB - downloaded 345 times.)
-  display_GPIB cct.pdf (559.44 kB - downloaded 381 times.)

« Last Edit: December 22, 2017, 02:14:56 am by lowimpedance »

Report to moderator  Logged

The odd multimeter or 2 or 3 or 4...or.....can't remember !.

The following users thanked this post: quarks, TiN, Mickle T., Le_Bassiste, zhtoor, alm

lowimpedance

Super Contributor



Posts: 1200

Country: 

Watts in an ohm?



 **Re: Valhalla 2701c schematics +..**



« Reply #1 on: December 21, 2017, 02:55:57 am »

Say Thanks

Reply

Quote

Mechanical drawings and Parts list.

-  Mechanical dwg.pdf (271.81 kB - downloaded 271 times.)
-  2701c Parts lst.pdf (469.01 kB - downloaded 283 times.)

« Last Edit: December 22, 2017, 01:00:48 am by lowimpedance »

Report to moderator  Logged

The odd multimeter or 2 or 3 or 4...or.....can't remember !.

The following users thanked this post: TiN, Le_Bassiste

quarks

Frequent Contributor



Posts: 872

Country: 



 **Re: Valhalla 2701c schematics +..**

« Reply #2 on: December 21, 2017, 02:06:42 pm »

Say Thanks

Reply

Quote

thanks a lot for sharing this documents

just in case anyone missed it, have a look at a very nice video from Shahriar Shahramian (aka Hugoneus) "The Signal Path"

<https://www.eevblog.com/forum/testgear/teardown-repair-calibration-of-a-valhalla-2701c-programmable-precision-source/msg840669/#msg840669>

« Last Edit: December 21, 2017, 03:15:38 pm by quarks »

Report to moderator  Logged

The following users thanked this post: TiN

TiN

 **Re: Valhalla 2701c schematics +..**

« Reply #3 on: December 21, 2017, 05:05:58 pm »

Say Thanks

Reply

Quote

Super Contributor

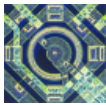

Posts: 4489

Country:

#StopInvasion



lowimpedance

Super Contributor



Posts: 1200

Country:

Watts in an ohm?



lowimpedance, we missed your threads indeed. 🙌

[Report to moderator](#) Logged

[YouTube](#) | [Metrology IRC Chat room](#) | Let's share T&M documentation? [Upload!](#) No upload limits for firmwares, photos, files.

Re: Valhalla 2701c schematics +..

« **Reply #4 on:** December 22, 2017, 02:14:20 am »

[Say Thanks](#)

[Reply](#)

[Quote](#)

Lastly we have the ROM firmware from the 2701c with bonus pic of the label and the programmer read showing the correct checksum as per the label 🙌.

Please note this binary file is for the 2701c with NO current option. Also the unit does not have the GPIB option either but I'll wager the firmware contains that function and does a check at power on. Displaying a "no IEEE" message during the startup test on the unit here. (must test that theory by shorting to 0V pin 20 on the header socket).



2701c ROM label.jpg (135.5 kB, 556x1024 - viewed 331 times.)

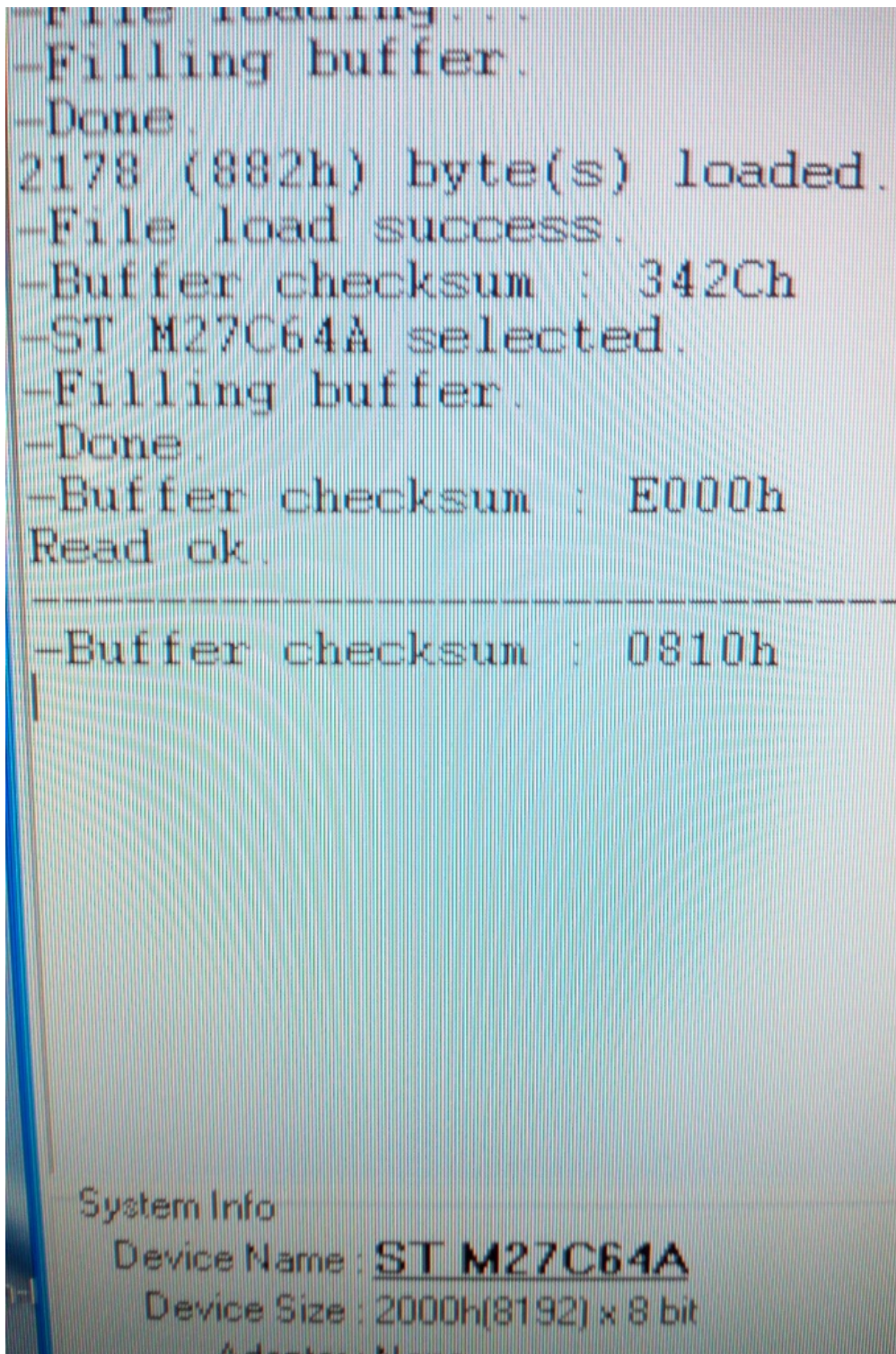

2701c checksum.jpg (356.68 kB, 680x1024 - viewed 384 times.)

valhalla 2701c firm.zip (3.28 kB - downloaded 163 times.)

Report to moderator Logged

The odd multimeter or 2 or 3 or 4...or.....can't remember !.

The following users thanked this post: quarks, TiN, Le_Bassiste

jasonbrent
Regular Contributor

Posts: 176

Re: Valhalla 2701c schematics + firmware V3

Say Thanks Reply Quote

« Reply #5 on: February 13, 2018, 05:37:14 pm »

I've got a 2701c en route that I found on fleabay. I'm hoping it is reasonably functional. Calibration keys are available from Valhalla... \$50 per set plus shipping.

Sent from my SM-N950U using Tapatalk

Report to moderator Logged

texaspyro

Super Contributor



Posts: 1406



Re: Valhalla 2701c schematics + firmware V3

Say Thanks Reply Quote

« Reply #6 on: February 13, 2018, 10:09:05 pm »

Quote from: jasonbrent on February 13, 2018, 05:37:14 pm

I've got a 2701c en route that I found on fleabay. I'm hoping it is reasonably functional. Calibration keys are available from Valhalla... \$50 per set plus shipping.

I took the cal switch out of a 2703 to my local locksmith... 10 minutes and \$5 later, I had a set of keys,

Report to moderator Logged

jasonbrent

Regular Contributor



Posts: 176



Re: Valhalla 2701c schematics + firmware V3

Say Thanks Reply Quote

« Reply #7 on: February 14, 2018, 05:55:13 pm »

Quote from: texaspyro on February 13, 2018, 10:09:05 pm

Quote from: jasonbrent on February 13, 2018, 05:37:14 pm

I've got a 2701c en route that I found on fleabay. I'm hoping it is reasonably functional. Calibration keys are available from Valhalla... \$50 per set plus shipping.

I took the cal switch out of a 2703 to my local locksmith... 10 minutes and \$5 later, I had a set of keys,

I wish I'd thought of that. =) .. As an aside, I also asked them for a quote on refurbishment/repair if necessary; \$2500 flat rate. While I don't expect to go down that route, it's good to know that they are still willing to rework very old gear. Given the price point of these new, that isn't horrible (but falls way outside of my comfort zone for hobby).

Report to moderator Logged

lowimpedance

Super Contributor



Posts: 1200

Country:

Watts in an ohm?



Re: Valhalla 2701c schematics + firmware V3

Say Thanks Reply Quote

« Reply #8 on: February 14, 2018, 10:52:37 pm »

Quote from: jasonbrent on February 13, 2018, 05:37:14 pm

I've got a 2701c en route that I found on fleabay. I'm hoping it is reasonably functional. Calibration keys are available from Valhalla... \$50 per set plus shipping.

Sent from my SM-N950U using Tapatalk

Does the soon to arrive 2701c have the 'Current option' installed ?.
If yes would you be able to read the firmware if you have access to a programmer, and only if your comfortable doing so of course.
The required parts for the option are easy enough but unfortunately the firmware appears to be different so to retrofit one would need the firmware first.

Any way if possible it would be much appreciated , but if not that's okay.
BTW given the schematics it should be relatively straight forward to repair if needed.

Report to moderator Logged

The odd multimeter or 2 or 3 or 4...or.....can't remember !.

jasonbrent

Regular Contributor



Posts: 176



Re: Valhalla 2701c schematics + firmware V3

Say Thanks Reply Quote

« Reply #9 on: February 14, 2018, 11:41:17 pm »

@lowimpedance - I don't believe it does.. but I'll check it when it arrives. I don't currently have a programmer, but I can acquire one if it indeed has that option.

Report to moderator Logged

The following users thanked this post: lowimpedance

 **jasonbrent**

Regular Contributor



Posts: 176



 **Re: Valhalla 2701c schematics + firmware V3**

Say Thanks

Reply

Quote

« Reply #10 on: February 15, 2018, 09:45:54 pm »

It looks like this doesn't have the 120mah option... but I need to crack it open. This is... very non-functional at the moment. It's producing 40volts out the rear in 20volt mode with the output on or off... and the front outputs are different yet again.

I guess this turns into My First Repair(tm). =)

EDIT: The traces for the banana plugs on the front were apparently desoldered at some point leaving only the rear banana jacks live. This unit has rack mounts on it, so it was likely a "safety" modification at some point in the past. I see a couple of date codes of 07 and 09, definitely doesn't have the 120mah option and the rom has a handwritten sticker that says "2701C-LNF" on it. I'm unsure if it's out of calibration because someone played with it, or if it is broken. The keys I ordered won't be here until Tuesday. In the interim, I'll start checking components on the board as best I can.

-j

« Last Edit: February 15, 2018, 11:12:07 pm by jasonbrent »

Report to moderator  Logged

 **lowimpedance**

Super Contributor



Posts: 1200

Country: 

Watts in an ohm?



 **Re: Valhalla 2701c schematics + firmware V3**

Say Thanks

Reply

Quote

« Reply #11 on: February 15, 2018, 11:37:26 pm »

If the current option is not installed there will be components missing at the front right hand side of the PCB. Post up a pic. of the inside of your unit to compare with others, to see if there are any significant revisions.

As for the busted output , start your check at the Mosfet output string, (rear right hand side). one or more are likely S/C. Check TR11, 12 and D3 etc for starters.

Report to moderator  Logged

The odd multimeter or 2 or 3 or 4...or.....can't remember !.

 **jasonbrent**

Regular Contributor



Posts: 176



 **Re: Valhalla 2701c schematics + firmware V3**

Say Thanks

Reply

Quote

« Reply #12 on: February 15, 2018, 11:59:12 pm »

Here's a few shots... whole board view and the unsoldered front panel.... and the special work around the transformer..

I'm about to check tr6-12 per the manual and then ic110/111, I think.

Repairing the front is easy enough, they look to be clean pulls.

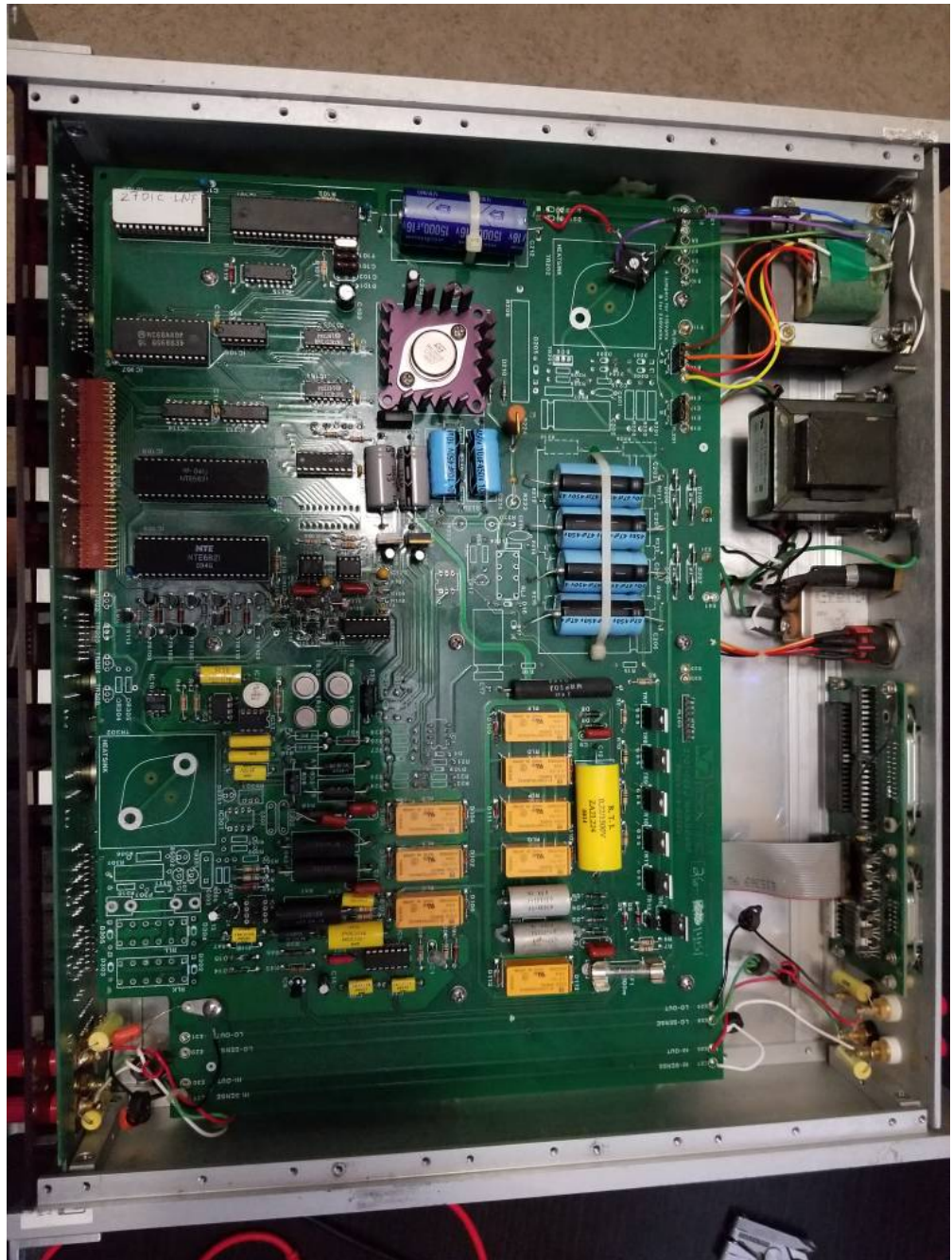

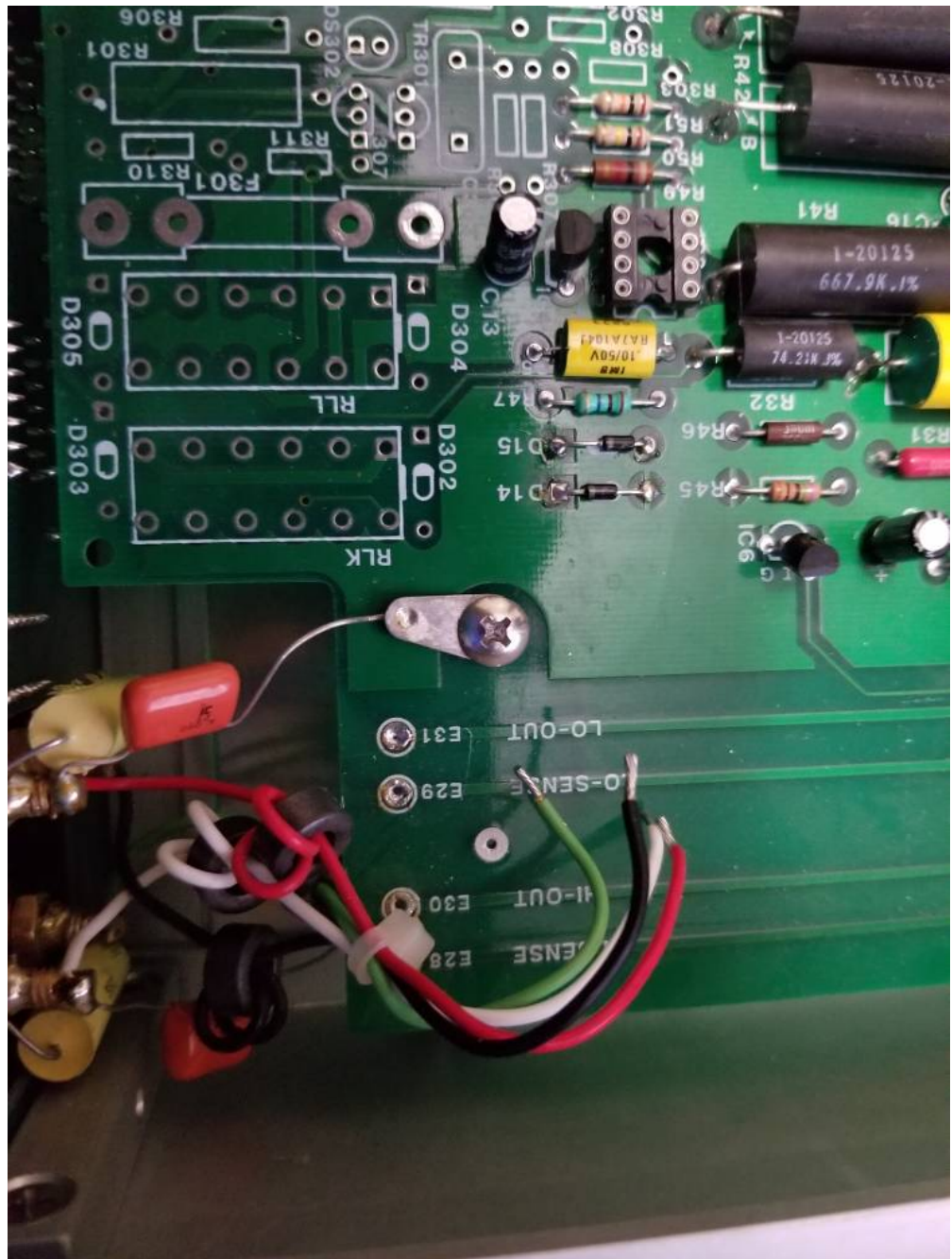

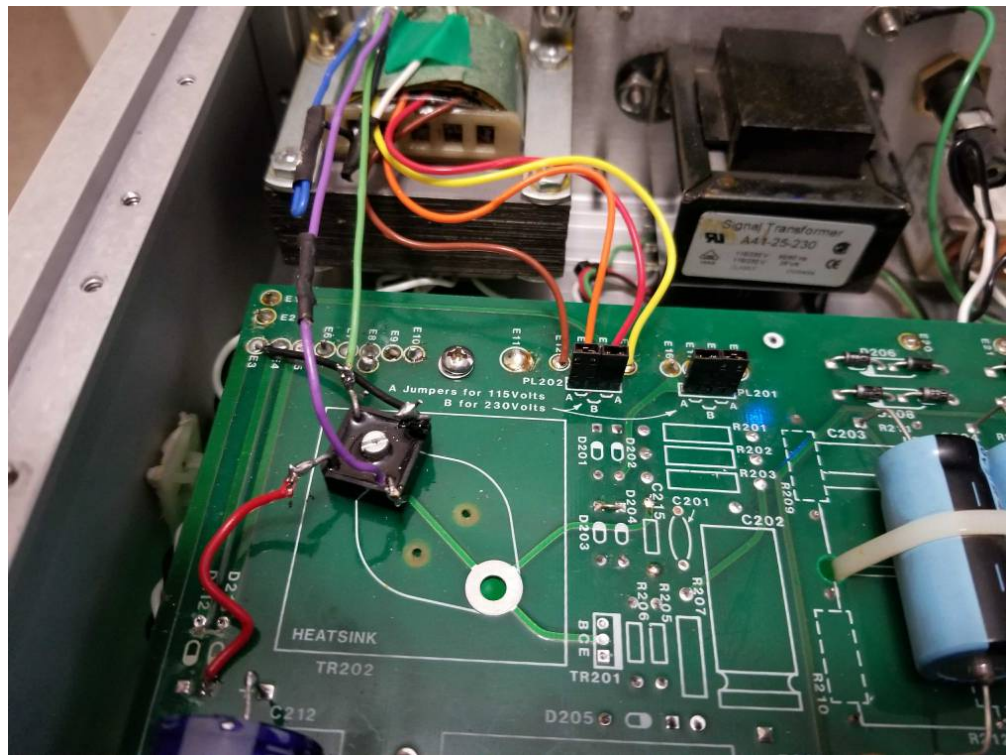

« Last Edit: February 16, 2018, 03:27:27 am by jasonbrent »

Report to moderator Logged

lowimpedance

Super Contributor



Posts: 1200

Country:

Watts in an ohm?



Re: Valhalla 2701c schematics + firmware V3

« Reply #13 on: February 16, 2018, 12:18:26 am »

Say Thanks Reply Quote

Sadly no current option, but whats going on with 'that' transformer bodge . At least you have the GPIB option. Would be interesting to see what happens on the display at power up if you remove the header ribbon connector before hand. Should show no IEEE I suspect. (proves that the comm's firmware is at least standard and just tests the installation of the connector to the interface PCB). Of course only do this test after repairs. PS I can post up any pictures of the inside of mine if you need any (if not already online).

Report to moderator Logged

The odd multimeter or 2 or 3 or 4...or.....can't remember !.

jasonbrent

Regular Contributor



Posts: 176



Re: Valhalla 2701c schematics + firmware V3

« Reply #14 on: February 16, 2018, 01:59:22 am »

Say Thanks Reply Quote

Bodges/kludges/questionables:

- * External fuse is 1.5 amps installed, spec'd for 1.0 amp.
- * Internal fuse (F1/100m marking on the board) is too large physically for the clips, so someone just shoved a fuse between the clamp posts bending them outwards to "make it fit".
- * Whatever is going on with the transformer...
- ** The wiring around the transformer is much 'worse' than I see in other 27xx pictures. Most others have all of the wiring topside and soldering bottom with neat tiwraps. This one has no tiwraps and many of the wires are soldered from the bottom of the board instead of the top. I don't know if this is a "Feature" of the LNF option (which drops the 1200v secondary transformer...) or what.
- * random components on the board have flux around the solder joints, but most joints are pristine; makes me think someone has repaired this before. majority of the flux is around the diodes.

I'm going to take my time with this and read/study... I'm honestly clueless with more gear than my skillset. So I'm going to try to grok what is going on around the board and see if I can identify anything that's been replaced vs. any documentation. Caps all look good... I'll open the bottom in a bit and see what's going on there.

« Last Edit: February 16, 2018, 02:23:36 am by jasonbrent »

Report to moderator Logged

jasonbrent

Re: Valhalla 2701c schematics + firmware V3

Say Thanks Reply Quote

Regular Contributor



Posts: 176



« Reply #15 on: February 16, 2018, 02:40:38 am »

I think someone has pulled the mainboard out of this at some point completely and desoldered every wire that went to the board.... each wire joint has flux on it, is on the wrong side of the board, or is otherwise poor.

This should be fun.... I probably need to move this over to "repair" to not anger the Metrology gods.

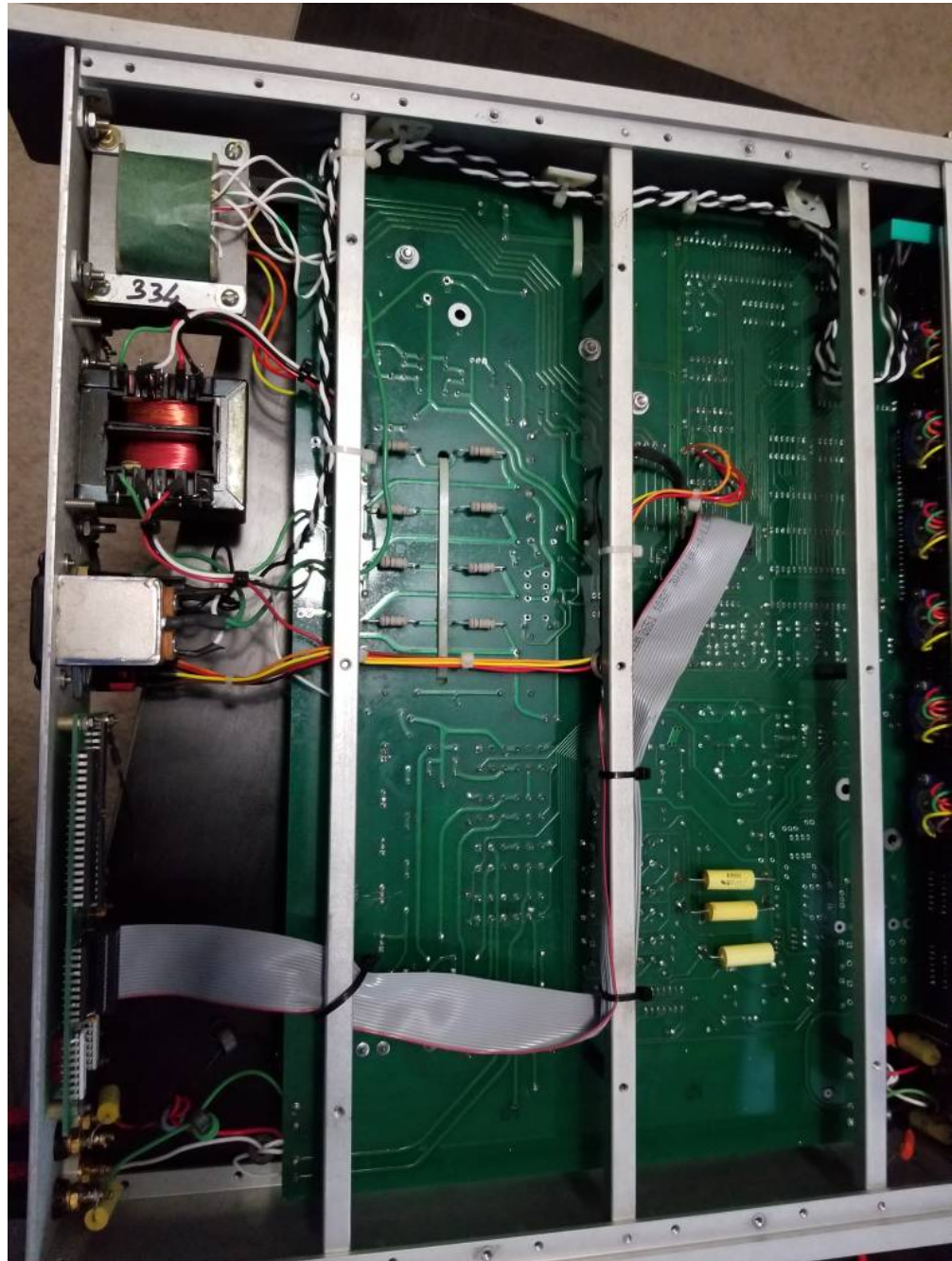

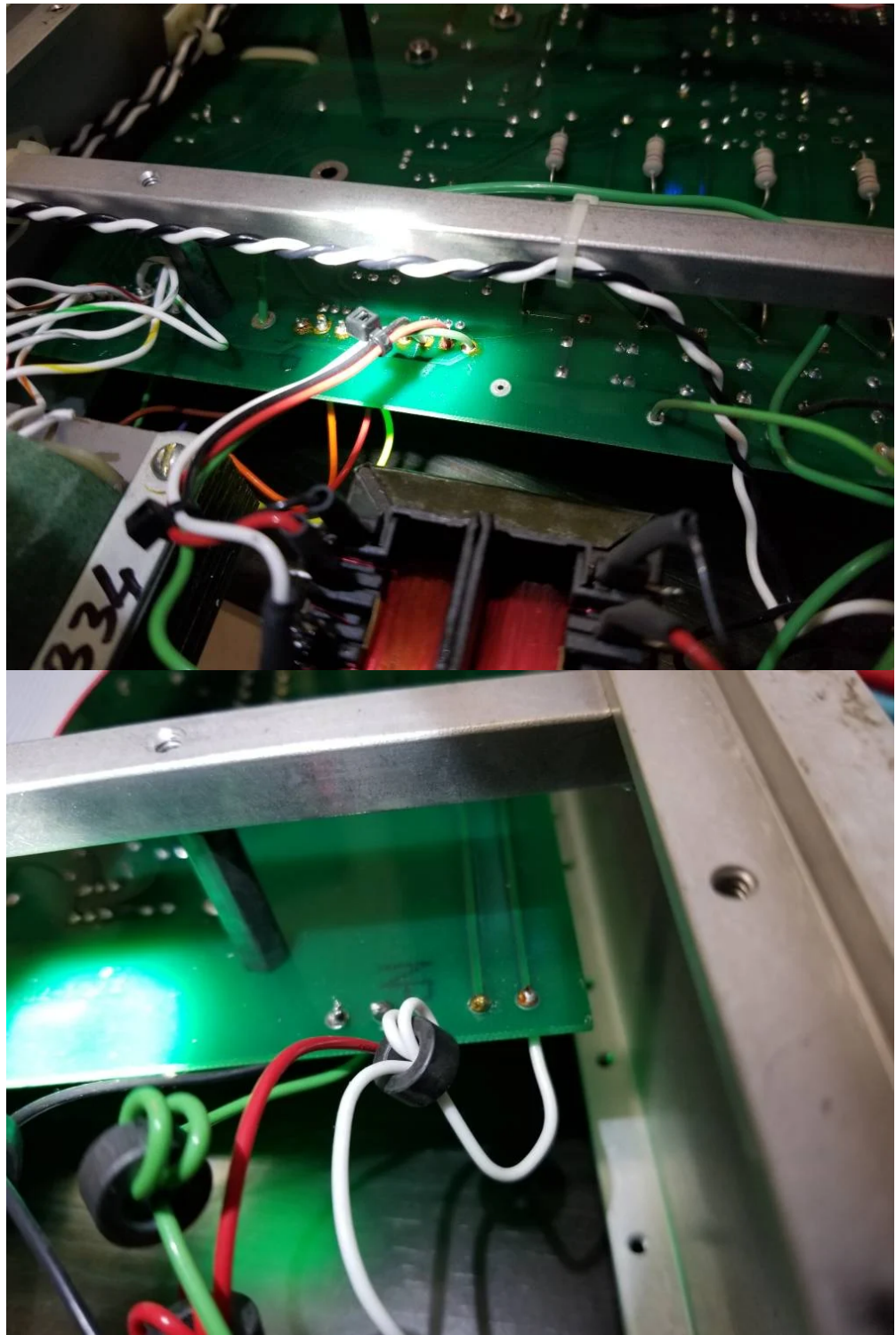

« Last Edit: February 16, 2018, 03:26:52 am by jasonbrent »

Report to moderator Logged

jasonbrent

Regular Contributor



Posts: 176



Re: Valhalla 2701c schematics + firmware V3

« **Reply #16 on:** February 16, 2018, 03:17:56 am »

Say Thanks Reply Quote

The transformer input is interesting... what should be TR202 has the piece in the following picture in place... no markings on it other than the sinusoidal pattern on opposite corners and a +,- on the opposing corners.

+ goes to where D213 should be and feeds straight into the 16v 15000uF cap.

- goes to E3.

Is yours LNF? If so, mind sharing pictures of the board?

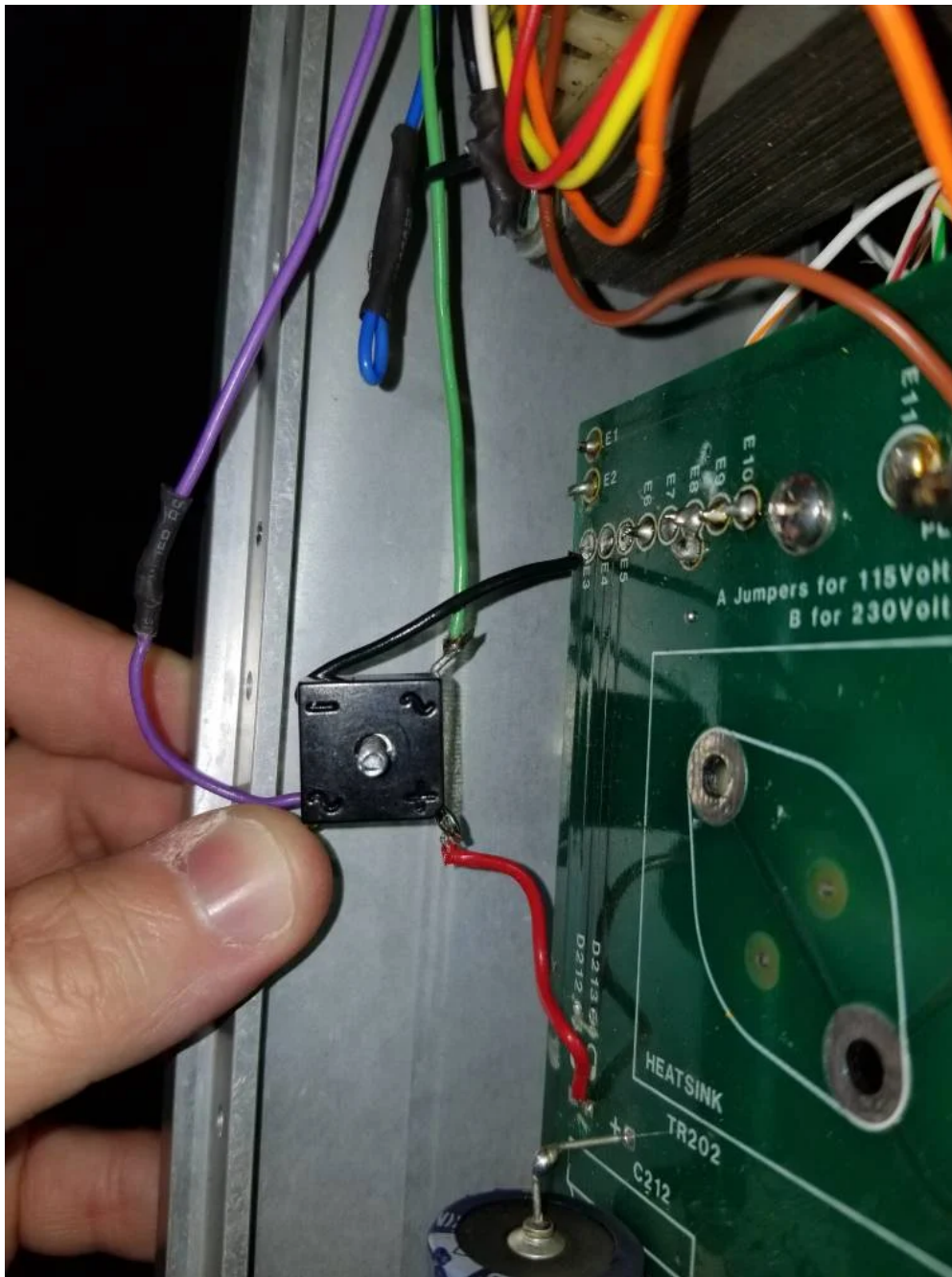

« Last Edit: February 16, 2018, 03:31:04 am by jasonbrent »

Report to moderator Logged

jasonbrent

Regular Contributor



Posts: 176



Re: Valhalla 2701c schematics + firmware V3

« Reply #17 on: February 16, 2018, 05:25:26 am »

Say Thanks

Reply

Quote

I'm thinking relay(s) at least... once powered on, output voltage is present.

- * All of the precision resistors are in spec according to my keithley 2015... well, R41 confuses me, but I think that's due to the 0.0uF cap piggy backing on it.
- * Operate/Standby does not change the output voltage (haven't checked schematic to see if a relay is connected, but none switches regardless.
- * in 200mv range, it produces 0.100mV
- * in 2v range, it produces 12V
- * in 20v range, it produces 40V
- * in 120V range, it produces 51V; interestingly enough, this is the only voltage range that I can impact with the front knobs. Turning the 10s place from 30 to 40 changes the output from 51 to 52 volts. In all other ranges, the front panel seems to have zero impact on the output voltage.

Relays flip when switching ranges; 1200V range is ignored because this has the LNF option.

I'm unsure how to test relays, especially on the board. Time to search....

Report to moderator  Logged

 **jasonbrent**

Regular Contributor



Posts: 176



 **Re: Valhalla 2701c schematics + firmware V3**

Say Thanks Reply Quote

« Reply #18 on: February 16, 2018, 05:27:39 am »

Quote from: lowimpedance on February 16, 2018, 12:18:26 am

Sadly no current option, but whats going on with 'that' transformer bodge .
At least you have the GPIB option. Would be interesting to see what happens on the display at power up if you remove the header ribbon connector before hand.
Should show no IEEE I suspect. (proves that the comm's firmware is at least standard and just tests the installation of the connector to the interface PCB).
Of course only do this test after repairs.
PS I can post up any pictures of the inside of mine if you need any (if not already online).

Confirmed, it displays "no IEEE" with the board disconnected.

Report to moderator  Logged

 **jasonbrent**

Regular Contributor



Posts: 176



 **Re: Valhalla 2701c schematics + firmware V3**

Say Thanks Reply Quote

« Reply #19 on: February 17, 2018, 04:56:05 am »

At this point I'm stuck I think; in part in trying to decide if this board is in the middle of someone else's failed repair, or the way it's supposed to be, but ready for repair.

Rail voltages off of the transformers are all correct, both AC and DC. mosfet chain appears good for the outputs.

Q: Do ya'll hear a relay switch when you toggle between output and standby?

EDIT: I've manually tested the 8 relays on the board and they do seem to properly latch in both directions... at least one of them is weaker than the others on one latch.

There are components that used to be populated and have been cut off (pins still through the board, components just gone). I don't know if this is back to someone else's previous modifications, or part of the LNF (low noise floor) option.

« Last Edit: February 17, 2018, 06:38:34 am by jasonbrent »

Report to moderator  Logged

 **jasonbrent**

Regular Contributor



Posts: 176



 **Re: Valhalla 2701c schematics + firmware V3**

Say Thanks Reply Quote

« Reply #20 on: February 18, 2018, 02:55:50 pm »

Valhalla Scientific tells me that the LNF option was "discontinued years ago", even though it shows up on the 2701C's webpage; perhaps there is another "LC" variant that provides that low noise floor in current models.

This 2701C-LNF I have diverges from the schematics posted by a reasonable amount...including capacitors where resistors should be, and extra capacitors on the bottom of the board piggy backed on some of the high precision resistors. The high voltage caps, by comparison, have dotted line silkscreening on the front of the board to identify where the resistors on the bottom of the board would go.

So.. at my skill level I' having a hard time telling if someone tried to repair this, tried to modify it's functionality, or if this is a variation due to the Low Noise Floor option coupled with various repairs (there are very obvious signs of repairs that I would consider poor; flux that wasn't cleaned up, pieces of paper towel caught on the pins on the bottom of the board as if someone tried to wipe the board off, etc).

I've been scouring the internet for information on the LNF option, hopefully with associated pictures, but haven't had any luck yet.

Calibration keys arrive tomorrow, and while I don't think all of the wonkiness on this can be explained by calibration alone, I'm going to give that a shot as the next step. I've got a Hakko 808 on order so make it easier to pull and test these some of these thruhole components, and I've ordered a spare set of NoS ICs for everything except the microprocessor from fleabay... The next bit to order are some of

the relays; I've got a couple that are questionable on their latching, and a couple of the latches seem to allow a small bit of conductance on what should be open circuits.

(... and with the baby now crying, this thought process escapes my head... so hitting post and hoping it's cogent.)

EDIT: IC9 is unpopulated from sheet one, lower right. IC10 is populated. IC9 is a JFET just like IC8 and IC11; IC9->IC10 feeds into line 15 on IC108 which controls the relays. I'm unsure of the control flow here, but I can't grok why IC would be unpopulated. Currently trying to scavenge a LF356N (unlikely) before ordering a few. Either the -LNF option is primarily "remove a lot of parts" or someone decided to use this one as a donor unit or some-such. Meh.

-j

« Last Edit: February 18, 2018, 10:11:56 pm by jasonbrent »

Report to moderator  Logged

lowimpedance

Super Contributor



Posts: 1200

Country: 

Watts in an ohm?



Re: Valhalla 2701c schematics + firmware V3

« Reply #21 on: February 19, 2018, 12:02:00 am »

Say Thanks Reply Quote

It looks very much like some one has done a butcher job in converting it to a "LNF" version by replacing both transformers and hacking out all the components related to the high voltage sections. None of this looks like Valhalla mods, so who ever hacked into it presumably had access to the circuit details of the LNF version and Firmware too).

One check to see if the ROM has the correct firmware is at start up the display will show 2701C40 which is the LNF identifier.

Sorry I dont have any documentation on the LNF version, perhaps you could get that direct from Valhalla which may help you do a better job on this unit.

I recall reading that the LNF version is limited to only +/- 40V out and uses toroid transformers !. (clearly not the bodged in ones in your unit). Also having a GPIB doubles the wideband noise spec. again.

Given the correct details it should be possible to revise this unit properly. Or if your after more than 40V I would suggest moving it along as it may be too costly to repair it to its original high voltage version.

Considering the transformers will be Valhalla custom made ones and you will need those to start. The other componenets should be readily available and the firmware is attached here.

Report to moderator  Logged

The odd multimeter or 2 or 3 or 4...or.....can't remember !.

jasonbrent

Regular Contributor



Posts: 176



Re: Valhalla 2701c schematics + firmware V3

« Reply #22 on: February 19, 2018, 12:08:30 am »

Say Thanks Reply Quote

Quote from: lowimpedance on February 19, 2018, 12:02:00 am

It looks very much like some one has done a butcher job in converting it to a "LNF" version by replacing both transformers and hacking out all the components related to the high voltage sections.

None of this looks like Valhalla mods, so who ever hacked into it presumably had access to the circuit details of the LNF version and Firmware too).

One check to see if the ROM has the correct firmware is at start up the display will show 2701C40 which is the LNF identifier.

Sorry I dont have any documentation on the LNF version, perhaps you could get that direct from Valhalla which may help you do a better job on this unit.

I recall reading that the LNF version is limited to only +/- 40V out and uses toroid transformers !. (clearly not the bodged in ones in your unit). Also having a GPIB doubles the wideband noise spec. again.

Given the correct details it should be possible to revise this unit properly. Or if your after more than 40V I would suggest moving it along as it may be too costly to repair it to its original high voltage version.

Considering the transformers will be Valhalla custom made ones and you will need those to start. The other componenets should be readily available and the firmware is attached here.

Both the factory product sticker on the back and the bolt sequence suggest it is a "real" LNF. ... which yes, limits to 40v. :/

I'll spend a couple more days on it since I've spent a little on new ICs and calibration keys and then decide about using the 14 day return with this seller or selling it. Darn.

... the serial number on the board makes me wonder if someone made a mistake at the factory, or what... it matches the exterior serial, however. I'd love to know the history of this unit.

I'm just imagining someone had an LNF and non-variant, LNF broke, they figured they'd adapt the other board, scratch in a new serial number, put it in the old LNF case and be good to go...

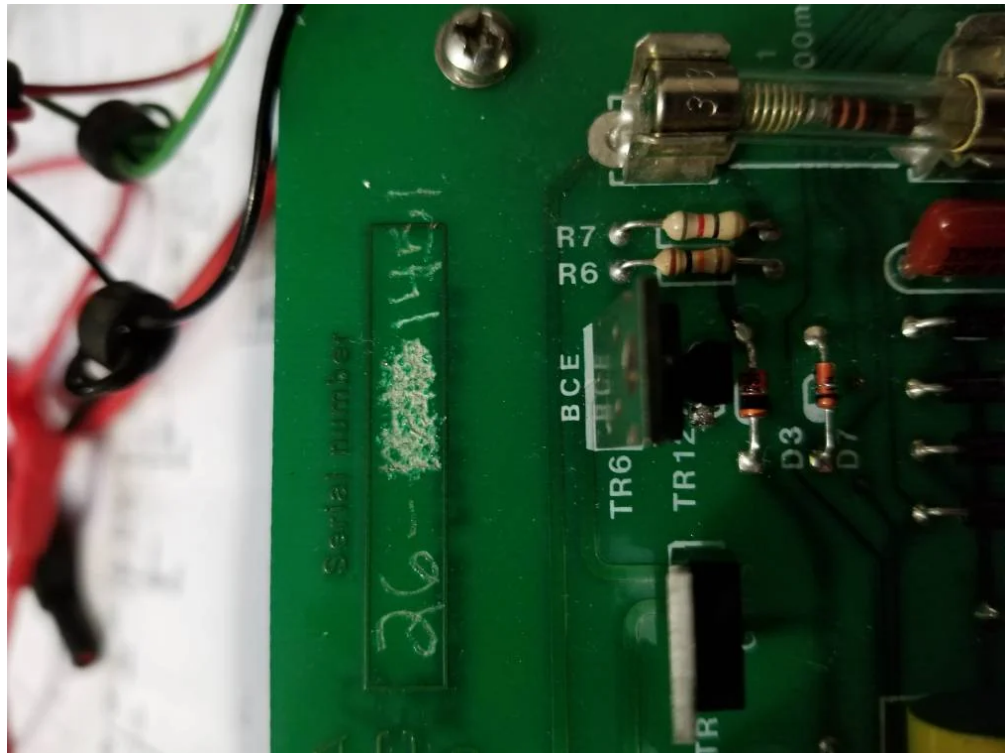

« Last Edit: February 19, 2018, 12:43:24 am by jasonbrent »

[Report to moderator](#) Logged

lowimpedance

Super Contributor



Posts: 1200

Country:

Watts in an ohm?



Re: Valhalla 2701c schematics + firmware V3

[Say Thanks](#) [Reply](#) [Quote](#)

« **Reply #23 on:** February 19, 2018, 02:25:51 am »

It would be nice to get the background to what happened to this unit, could be exactly as you suggested. Certainly had nothing to do with Valhalla. Perhaps try to find another unit and keep this one for an interesting project 🙄 ... good luck.

[Report to moderator](#) Logged

The odd multimeter or 2 or 3 or 4...or.....can't remember !.

 **jasonbrent**
Regular Contributor

Posts: 176

 **Re: Valhalla 2701c schematics + firmware V3** Say Thanks Reply Quote
« **Reply #24 on:** February 19, 2018, 04:17:05 pm »

Cal keys just arrived... and no go. Too far out of spec for calibration to work as I guessed. I've asked Valhalla for schematics on the LNF, will see if that yields fruit. Otherwise, I'm continuing to literally follow traces testing component by component while I wait on spares.

Another example is that IC110 and IC111 (if memory serves) calls for dual optocoupler 8 pin dips... mine has a single in one of the two (110 I believe).. which while that doesn't match the parts list, it DOES match the actual functionality. The electrical path through that particular socket only uses one optocoupler.

What's kind of interesting is the power rails generate 12volt and 40volt and that's basically what I'm getting on the outputs depending on range selected. Almost like the power rails are shorted straight through somehow. A frustrating learning experience. :-)

-j

Report to moderator  Logged

 **lowimpedance**
Super Contributor



Posts: 1200
Country: 

Watts in an ohm?

 **Re: Valhalla 2701c schematics + firmware V3** Say Thanks Reply Quote
« **Reply #25 on:** February 19, 2018, 10:51:53 pm »

If Valhalla can supply the documentation for the LNF version that would make life so much easier and then this would be a very interesting project. A frustrating learning experience is good ! , it will stick in your mind and will be very useful for those 'other' frustrating learning occasions 😊

Report to moderator  Logged

The odd multimeter or 2 or 3 or 4...or.....can't remember !.

 **wictor**
Regular Contributor

Posts: 119
Country: 

 **Re: Valhalla 2701c schematics + firmware V3** Say Thanks Reply Quote
« **Reply #26 on:** February 21, 2018, 06:33:53 am »

Hi!

Does anyone have full schematics for older 2701 or 2701B? I cannot even find pictures of the boards of the oldest model.

Wictor

« Last Edit: February 21, 2018, 06:47:48 am by wictor »

Report to moderator  Logged

 **jasonbrent**
Regular Contributor

Posts: 176

 **Re: Valhalla 2701c schematics + firmware V3** Say Thanks Reply Quote
« **Reply #27 on:** February 21, 2018, 04:42:31 pm »

Quote from: wictor on February 21, 2018, 06:33:53 am

Hi!

Does anyone have full schematics for older 2701 or 2701B? I cannot even find pictures of the boards of the oldest model.

Wictor

Check with <http://artekmanuals.com/manuals/other-manuals/> -- he responded quickly when I asked if what he had on the 2701c contained the LNF variant (it did not). He lists the 2701A/B/C.

Report to moderator  Logged

 **wictor**
Regular Contributor

Posts: 119
Country: 

 **Re: Valhalla 2701c schematics + firmware V3** Say Thanks Reply Quote
« **Reply #28 on:** February 22, 2018, 06:04:35 am »

Quote from: jasonbrent on February 21, 2018, 04:42:31 pm

Quote from: wictor on February 21, 2018, 06:33:53 am

Hi!

Does anyone have full schematics for older 2701 or 2701B? I cannot even find pictures of the boards of the oldest model.

Wictor

Check with <http://artekmanuals.com/manuals/other-manuals/> -- he responded quickly when I asked if what he had on the 2701c contained the LNF variant (it did not). He lists the 2701A/B/C.

Yes, that seems to be best option right now.

Report to moderator Logged

jasonbrent

Regular Contributor



Posts: 176



Re: Valhalla 2701c schematics + firmware V3

Say Thanks Reply Quote

« Reply #29 on: February 27, 2018, 05:13:51 am »

Update on my -LNF saga:

- * Valhalla Scientific does not appear to have the -LNF schematics
- * Their VP of engineering reached out to me in lieu of the schematics, but I've yet to hear back from him after my initial response. ./
- * I've sourced and replaced every single relay (\$\$) and TR6-12 in the "output drive" section.
- * I've sourced and replaced every socketed IC except the microprocessor, NOVRAM, and ROM.
- * I've verified that the digital portion of the board appears to be doing the right thing at the signal level, things just aren't making it out the analogue end properly.

I've at least partially convinced myself that the components missing on the board are appropriate for the LNF variant after much tracing of the schematics. Otherwise, I think the -LNF is nothing more than a smaller transformer in place of the 1200V one, removal of the HV circuitry on the board, a rom check or different rom, and the addition of some 0.01uF filter caps across the banana plugs, and a few other spots on the board. Where I lose the convincing is around the analogue output side.... the manual describes HV analog function and I simply don't have the clue at the moment to translate it into how this should work otherwise.

Symptoms are still the same, unfortunately.

I've got replacement electrolytics en route as a hail mary.

-j

Report to moderator Logged

precaud

Frequent Contributor

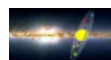

Posts: 665

Country:



Re: Valhalla 2701c schematics + firmware V3

Say Thanks Reply Quote

« Reply #30 on: March 01, 2018, 06:57:17 pm »

I have a PDF op/service manual for the 2701C which Valhalla gave to me a few years back. It mentions the -LNF option but gives no circuit details. PM me if you can use it.

Report to moderator Logged

lowimpedance

Super Contributor



Posts: 1200

Country:

Watts in an ohm?



Re: Valhalla 2701c schematics + firmware V3

Say Thanks Reply Quote

« Reply #31 on: March 01, 2018, 11:37:08 pm »

Quote from: precaud on March 01, 2018, 06:57:17 pm

I have a PDF op/service manual for the 2701C which Valhalla gave to me a few years back. It mentions the -LNF option but gives no circuit details. PM me if you can use it.

The manual I have , and have attached here, also mentions this option but has no further detail either 😞. What I find odd is that Valhalla themselves say they don't have the details. Or some one couldn't be bothered hunting through a filing cabinet 😞

Report to moderator Logged

The odd multimeter or 2 or 3 or 4...or.....can't remember !.

precaud

Frequent Contributor



Re: Valhalla 2701c schematics + firmware V3

Say Thanks Reply Quote

« Reply #32 on: March 02, 2018, 03:47:21 am »

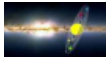

Posts: 665
Country:



Quote from: lowimpedance on February 16, 2018, 12:18:26 am

At least you have the GPIB option. Would be interesting to see what happens on the display at power up if you remove the header ribbon connector before hand.

The manual I have says of the -LNF version that, if the GPIB option is installed, the noise improvement is reduced by 50%

Report to moderator Logged

lowimpedance

Super Contributor



Posts: 1200
Country:

Watts in an ohm?



Re: Valhalla 2701c schematics + firmware V3

« Reply #33 on: March 02, 2018, 03:52:43 am »

Say Thanks Reply Quote

Same here in my manual !. As for the unit that Jason is working on its origin , as a LNF at least, is unclear as it certainly looks like some one had access to a proper LNF (as they have copied the firmware too) and have butchered a standard 2701c to become a LNF as you see in Jasons pictures above.

« Last Edit: March 02, 2018, 03:57:30 am by lowimpedance »

Report to moderator Logged

The odd multimeter or 2 or 3 or 4...or.....can't remember !.

jasonbrent

Regular Contributor



Posts: 176



Re: Valhalla 2701c schematics + firmware V3

« Reply #34 on: March 02, 2018, 04:12:35 am »

Say Thanks Reply Quote

Quote from: lowimpedance on March 01, 2018, 11:37:08 pm

Quote from: precaud on March 01, 2018, 06:57:17 pm

I have a PDF op/service manual for the 2701C which Valhalla gave to me a few years back. It mentions the -LNF option but gives no circuit details. PM me if you can use it.

The manual I have , and have attached here, also mentions this option but has no further detail either 😞. What I find odd is that Valhalla themselves say they don't have the details.

Or some one couldn't be bothered hunting through a filing cabinet 😞

I'm beginning to think that the -LNF variants were hand adjusted, potentially by a very small number of people (1?); and those people/person isn't with them anymore, so the information is lost. Honestly, the only differences I see, other than removing a lot of the HV path is 7 capacitors. 4 across each of the pairs of terminals, and 3 in parallel with R42A/R42B/R41 -- 0.1uF 5% 100V caps that might be custom rolled (yellow, paper? unsure, can't take a picture at the moment).

Valhalla told me to check the output voltages and all of the rails match the schematic, except the HV rail between I and J on sheet 1 of the schematics.... that one simply isn't specified. I'm getting 376V potential across I/J which appears to simply match TR201's output between E20 and E21 (280V) plus TR202's E9-E10 (93V). I asked them to confirm what voltage should exist there and was told that they don't know --- they don't have an LNF to check. 😞

As an aside, on sheet 1, TR6, part of the output drive, is listed as a TIP29A in the parts list; is a TIP31A a reasonable substitute there? I *THINK* it is based on the specs of each... but the TIP29A I pulled from the board seems to be fine according to this peak atlas DCA75.

I sat down with a "real" EE and the schematics a couple of days ago to look at the output drive section and at this point I'm wondering if the zener, D3, isn't misbehaving. In circuit, it is ~1.5MΩ in 1 direction, and ~55kΩ in the other... but in circuit could be lying to me.

Incidentally, I sent the same pictures from earlier in this thread to Valhalla asking if they could verify if that is what an LNF was supposed to look like, or if it was someone else's butcher job... They didn't appear to know, at least, they didn't answer that question, which was the only real question in my email. 😞

Eventually this thing will work again....

-j

« Last Edit: March 02, 2018, 04:14:53 am by jasonbrent »

Report to moderator Logged

Edwin G. Pettis

Frequent Contributor



Re: Valhalla 2701c schematics + firmware V3

« Reply #35 on: March 02, 2018, 05:03:37 am »

Say Thanks Reply Quote

Posts: 437

Country: 

The plural of anecdote is not data.



jasonbrent

Regular Contributor



Posts: 176



Valhalla was not known for using 'special' components, the vast majority of the components in their instruments were standard off-the-shelf even if they had in-house numbering on them. During the period we were making all of their PWV resistors, I do not recall a LNF option in the 2701C models in production at the time. This 'option' may have been a 'special' done for a particular customer at some time before the 'C' version and the instrument you have come by may have been somebody's attempt at bodging an LNF into the unit. I have a 2701C manual from Valhalla and first chance I get, I'll take a look at it and see if there is anything in it about this option.

Report to moderator  Logged

 **Re: Valhalla 2701c schematics + firmware V3**

Say Thanks Reply Quote

« Reply #36 on: March 02, 2018, 05:08:13 am »

Quote from: Edwin G. Pettis on March 02, 2018, 05:03:37 am

Valhalla was not known for using 'special' components, the vast majority of the components in their instruments were standard off-the-shelf even if they had in-house numbering on them. During the period we were making all of their PWV resistors, I do not recall a LNF option in the 2701C models in production at the time. This 'option' may have been a 'special' done for a particular customer at some time before the 'C' version and the instrument you have come by may have been somebody's attempt at bodging an LNF into the unit. I have a 2701C manual from Valhalla and first chance I get, I'll take a look at it and see if there is anything in it about this option.

Hmmm, useful information. The serial# sticker on the outside says "2701C-LNF" for what it's worth. The only other reference I found to LNF (other than ebay scrapers), is an index of content in use at Sandia National Labs in the recent past. It lists both a 2701C and a 2701C-LNF in their possession. http://www.sandia.gov/psl/_assets/documents/Electrical%20Lab%20Supported%20Equip%2021May2015.pdf

Report to moderator  Logged

precaud

Frequent Contributor

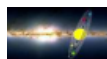

Posts: 665

Country: 



 **Re: Valhalla 2701c schematics + firmware V3**

Say Thanks Reply Quote

« Reply #37 on: March 02, 2018, 02:21:05 pm »

I have a couple 2701C's here in the repair pile, I'll look and see if either of them are LNF's.

Quote

The serial# sticker on the outside says "2701C-LNF" for what it's worth. The only other reference I found to LNF (other than ebay scrapers), is an index of content in use at Sandia National Labs in the recent past. It lists both a 2701C and a 2701C-LNF in their possession.

That makes sense. I tested that unit when it was offered for sale and decided to pass on it. You must have bought it on eBay from "solanotraders", an aggressive eBay flipper. I would advise you to assume that almost anything you buy from him has significant issues. I attend the same industrial auctions he does, and it is part of my job to make sure he doesn't get TE stuff that works 😊

Report to moderator  Logged

jasonbrent

Regular Contributor



Posts: 176



 **Re: Valhalla 2701c schematics + firmware V3**

Say Thanks Reply Quote

« Reply #38 on: March 02, 2018, 02:51:47 pm »

Quote from: precaud on March 02, 2018, 02:21:05 pm

I have a couple 2701C's here in the repair pile, I'll look and see if either of them are LNF's.

Quote

The serial# sticker on the outside says "2701C-LNF" for what it's worth. The only other reference I found to LNF (other than ebay scrapers), is an index of content in use at Sandia National Labs in the recent past. It lists both a 2701C and a 2701C-LNF in their possession.

That makes sense. I tested that unit when it was offered for sale and decided to pass on it. You must have bought it on eBay from "solanotraders", an aggressive eBay flipper. I would advise you to assume that almost anything you buy from him has significant issues. I attend the same industrial auctions he does, and it is part of my job to make sure he doesn't get TE stuff that works 😊

I had to go back and look, no it wasn't "solanotraders". I'll add that info to my mental filing cabinet though. 😊

Report to moderator  Logged

precaud

Re: Valhalla 2701c schematics + firmware V3

Frequent Contributor

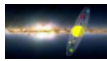

Posts: 665

Country:



jasonbrent

Regular Contributor



Posts: 176



precaud

Frequent Contributor

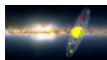

Posts: 665

Country:



jasonbrent

Regular Contributor



Posts: 176



« **Reply #39 on:** March 03, 2018, 03:07:35 pm »

[Say Thanks](#)

[Reply](#)

[Quote](#)

Neither of my 2701C's are -LNF's...

[Report to moderator](#)



Logged



Re: Valhalla 2701c schematics + firmware V3

[Say Thanks](#)

[Reply](#)

[Quote](#)

« **Reply #40 on:** March 03, 2018, 03:29:00 pm »

Quote from: precaud on March 03, 2018, 03:07:35 pm

Neither of my 2701C's are -LNF's...

Trade you one Rare^WVintage^Unique -LNF for a working 2701C in your pile? :-)

I guess I'll start up a thread in the Repair section and see if we can crowd source this. 😊

Thank you for checking.

-j

[Report to moderator](#)



Logged



Re: Valhalla 2701c schematics + firmware V3

[Say Thanks](#)

[Reply](#)

[Quote](#)

« **Reply #41 on:** March 03, 2018, 03:46:23 pm »

Quote from: jasonbrent on March 03, 2018, 03:29:00 pm

Trade you one Rare^WVintage^Unique -LNF for a working 2701C in your pile? :-)

Thanks for your *kind* offer 😊

Neither of mine are working, they've been patiently waiting in the repair pile for a couple years. I put numerous hours into troubleshooting each of them at some point with only partial success, and had to put them aside for a rainy day. Global Climate Change has given us far fewer such days, and so they have sat unattended to ... 😊

[Report to moderator](#)



Logged



Re: Valhalla 2701c schematics + firmware V3

[Say Thanks](#)

[Reply](#)

[Quote](#)

« **Reply #42 on:** March 10, 2018, 02:03:37 am »

TL;DR: To test the analog circuitry, I took the digital out of the equation (I think). Still have the voltage potential where it shouldn't be. As best I can tell, with no signal out of IC5 pin 10 to TR12, the high voltage should go to 0va through D7 (I think..).

After setting this aside for a few days, I pulled pins 1,2,12,13 off of IC112 (feeds the 2 variable duty cycle square waves into the precision resistor chain and on to the chopper amp before hitting the mosfet output chain) temporarily to take the digital bits out of the equation. I still have the voltage potential that shouldn't be there. For anyone playing the home game (OPs post, "main board cct.pdf"), on the main PCB diagram, sheet 1, the voltage I see across the outputs when in standby mode is the same voltage I see across the pair of diodes D6/D5 and across C12.

On sheet 3, power supply, R223 (high voltage output, near "J" on the right) is a piece of wire on mine. R224 is in place, however. I don't quite understand how the windings on the low voltage transformer between E9/E10 that feed through "L" back to sheet 1 between R7 and the slow blow fuse F1 works. It basically looks like the T201 transformer sends to I/J on the output side, but T202 also helpfully gives another 120V as "L".

I think need to study input "L" at the very top of sheet 1 to understand the relationship between that, the F1 fuse, D1/D2/D5/D6/D8/D9... if I pull the fuse F1, I still get the same voltage potentials on the outputs... but I think that's an "input" protection fuse vs. output. I don't grok the current flow in this thing. 🤔

While thing thing works exactly as it did when I received it despite all of my cutting/removing/replacing/testing, I'd be hard pressed to even put it up for sell as it'd just feel slimy.



« Last Edit: March 10, 2018, 04:18:11 am by jasonbrent »

Report to moderator Logged

Le_Bassiste

Regular Contributor



Posts: 242

Country:



Re: Valhalla 2701c schematics +..

« Reply #43 on: July 06, 2021, 02:13:16 pm »

Say Thanks Reply Quote

Quote from: lowimpedance on December 22, 2017, 02:14:20 am

Please note this binary file is for the 2701c with NO current option. Also the unit does not have the GPIB option either but I'll wager the firmware contains that function and does a check at power on.

can confirm that the firmware (V1.0) for a 2701C, that did not originally have the GPIB option, does indeed contain the GPIB functions.
it doesn't respond to an "IDN?", though.

Report to moderator Logged

An assertion ending with a question mark is a brain fart.

The following users thanked this post: lowimpedance

Le_Bassiste

Regular Contributor



Posts: 242

Country:



Re: Valhalla 2701c schematics + firmware

V3

« Reply #44 on: July 20, 2021, 06:19:38 am »

Say Thanks Reply Quote

... and just in case someone wants to upgrade the unit with a GPIB interface:
[https://www.eevblog.com/forum/projects/valhalla-2701c-gpib-\(ieee\)-upgrade/](https://www.eevblog.com/forum/projects/valhalla-2701c-gpib-(ieee)-upgrade/)

Report to moderator Logged

An assertion ending with a question mark is a brain fart.

The following users thanked this post: lowimpedance, precaud

RaymondMack

Regular Contributor



Posts: 63

Country:



Re: Valhalla 2701c schematics + firmware

V3

« Reply #45 on: July 23, 2021, 09:36:08 pm »

Say Thanks Reply Quote

I have a Valhalla 2701C with all the gblets (GPIB and current source / IT2). It's one of the newerish units that have white paint on the front panel. Date codes are all over the place, but I think it was made in 1991 (or 1993 if the HV transistors and OP07 opamp are to be trusted). The sticker covering the UV EPROM has fallen off (and since replaced with some electrical tape) so I don't know what FW version is on my instrument, but I can read the ROM and copy it to the forum if anyone is interested.

I'm still waiting for a few parts to come (radial caps and bleed resistors), but I should have my unit up and going by the end of next week. Every electrolytic cap has gone bad in this unit like they were in some sort of suicide pact. Possibly drinking the Kool-Aid at the local metrology cult meeting 😊. Meanwhile, the HV bleed resistors had Cheech and Chonged up in smoke and nearly carbonized the PCB traces nearest to them. I'm confused why Valhalla used 1W resistors when 3W parts seems more appropriate. Though I'd rather have seen a single 7W wire wound used for each HV cap.

Report to moderator Logged

Le_Bassiste

Regular Contributor



Posts: 242

Country:



Re: Valhalla 2701c schematics + firmware

V3

« Reply #46 on: July 24, 2021, 09:40:54 am »

Say Thanks Reply Quote

yeah, would really like to see the fully fledged FW of this thing. mine doesn't have the current source option and i'm hesitating to retrofit the current source option w/o knowing whether the FW could actually support it.

as for the churned bleeder resistors in your unit, that issue may point at some problem in the pre-regulator on the primary side. could be that the HV DC bus was always at max voltage, regardless of the selected range. you can check that by measuring the voltage across the entire series regulator chain. should be constant at some 240 VDC with the instrument set to 0 VDC at any range.

Report to moderator Logged

An assertion ending with a question mark is a brain fart.

The following users thanked this post: RaymondMack

Electrole

Contributor

Posts: 41

Country: 



Re: Valhalla 2701c schematics + firmware V3

Say Thanks

Reply

Quote

« Reply #47 on: July 24, 2021, 07:17:58 pm »

The bleeder resistors in the 2701C have clearly a too low power rating. It makes one wonder if no basic design checks of dissipation were made by Valhalla. Check out my unit at <https://dabledoo.weebly.com/valhalla-2701c.html> where I replaced the original resistors with ROX55 from TE Connectivity, rated at 5 W.

The larger power rating by itself is not the reason why changing the resistors is a good idea: Physically larger resistors have a larger surface area and this a good property if you want to mitigate a hot spot.

Report to moderator  Logged

The following users thanked this post: lowimpedance, quarks, RaymondMack

lowimpedance

Super Contributor



Posts: 1200

Country: 

Watts in an ohm?



Re: Valhalla 2701c schematics + firmware V3

Say Thanks

Reply

Quote

« Reply #48 on: July 25, 2021, 02:38:25 am »

Quote from: RaymondMack on July 23, 2021, 09:36:08 pm

The sticker covering the UV EPROM has fallen off (and since replaced with some electrical tape) so I don't know what FW version is on my instrument, but I can read the ROM and copy it to the forum if anyone is interested.

I would be also interested in the firmware to see if the non current option is the same and contains the current drive section like it does for the GPIB.

So if you could copy and upload sometime that would be much appreciated.

Report to moderator  Logged

The odd multimeter or 2 or 3 or 4...or.....can't remember !.

RaymondMack

Regular Contributor



Posts: 63

Country: 



Re: Valhalla 2701c schematics + firmware V3

Say Thanks

Reply

Quote

« Reply #49 on: July 25, 2021, 02:55:23 am »

Quote from: Le_Bassiste on July 24, 2021, 09:40:54 am

yeah, would really like to see the fully fledged FW of this thing. mine doesn't have the current source option and i'm hesitating to retrofit the current source option w/o knowing whether the FW could actually support it. as for the churned bleeder resistors in your unit, that issue may point at some problem in the pre-regulator on the primary side. could be that the HV DC bus was always at max voltage, regardless of the selected range. you can check that by measuring the voltage across the entire series regulator chain. should be constant at some 240 VDC with the instrument set to 0 VDC at any range.

I'll upload the ROM dump tomorrow. Thanks for the advice, I'll check the pre-regulator after I get the new parts installed.

Quote from: Electrole on July 24, 2021, 07:17:58 pm

The bleeder resistors in the 2701C have clearly a too low power rating. It makes one wonder if no basic design checks of dissipation were made by Valhalla. Check out my unit at <https://dabledoo.weebly.com/valhalla-2701c.html> where I replaced the original resistors with ROX55 from TE Connectivity, rated at 5 W.

The larger power rating by itself is not the reason why changing the resistors is a good idea: Physically larger resistors have a larger surface area and this a good property if you want to mitigate a hot spot.

They must have assumed that the HV range would only be used briefly. But even then, it's bad engineering to not take into account temperature rise of the resistors and derate the power. I completely agree about using larger resistor bodies to reduce hot spots. The larger volume and surface area aid in keeping the temperature of the resistors down. And by association, the PCB and nearby components. The ROX55 are a good choice and even the reduced sized ROX55S aren't a bad idea if using two of them. These reduced size parts are at the physical limits for a part that can just drop into the original holes without bending the leads underneath the resistor body. I ended up going with two 27kohm KOA Speer MOS3 parts, but in hindsight, a single 56kohm MOS5 would have been the better choice. Oh well.

« Last Edit: July 25, 2021, 03:32:26 am by RaymondMack »

Report to moderator  Logged

RaymondMack

Regular Contributor



Posts: 63

Country:



Re: Valhalla 2701c schematics + firmware V3

Say Thanks Reply Quote

« Reply #50 on: July 26, 2021, 01:46:58 am »

I dumped the ROM today and compared with the V3.0 file uploaded earlier. Structurally, they look similar, which is good. And while there are some general similarities, the contents are quite different. Mine has data written up till 0x1485 while the other FW ends at 0x132B. So there is a little bit more written to the ROM.

I'm fairly certain that my unit has a different FW version (not just the IT2 option), so that could contribute to some of the differences.

Does anyone know the date of the instrument using the V3.0 firmware? My unit is somewhere between 1991 and 1993.

I added the UV EPROM's datasheet and a readme file with the firmware. Have fun hacking.

2701C_IT2_Firmware.zip (1049.88 kB - downloaded 81 times.)

Report to moderator Logged

The following users thanked this post: lowimpedance, quarks, Le_Bassiste

lowimpedance

Super Contributor



Posts: 1200

Country:

Watts in an ohm?



Re: Valhalla 2701c schematics + firmware V3

Say Thanks Reply Quote

« Reply #51 on: July 26, 2021, 03:12:34 am »

Well I uploaded version 3 as part of the OP from my still to be repaired unit which has the white paint front as well. So probably similar vintage, will have to dig it out of the cupboard to check some date codes.

Thanks for the extra firmware, certainly worth investigating further when I have a working unit.

« Last Edit: July 26, 2021, 03:14:10 am by lowimpedance »

Report to moderator Logged

The odd multimeter or 2 or 3 or 4...or.....can't remember !.

Le_Bassiste

Regular Contributor



Posts: 242

Country:



Re: Valhalla 2701c schematics + firmware V3

Say Thanks Reply Quote

« Reply #52 on: July 26, 2021, 05:17:35 am »

as a side note, upgrading from V1.0 to V3.0 will get you a "no dAtA" error message on power-on, indicating that the cal constants are either missing or corrupted. in fact, the output voltages will be out of cal after the upgrade. this message goes away after a full cal/adjust run, though. fwiw, i'm using an AT28C64B-150 as replacement for the 2764A.

Report to moderator Logged

An assertion ending with a question mark is a brain fart.

The following users thanked this post: quarks, RaymondMack

lowimpedance

Super Contributor



Posts: 1200

Country:

Watts in an ohm?



Re: Valhalla 2701c schematics + firmware V3

Say Thanks Reply Quote

« Reply #53 on: July 27, 2021, 12:41:58 am »

Quote from: RaymondMack on July 26, 2021, 01:46:58 am

Does anyone know the date of the instrument using the V3.0 firmware? My unit is somewhere between 1991 and 1993.

Had a look and mine and it has parts ranging from 88 to 94 dates, so approximately the same time period at best guess !.

Report to moderator Logged

The odd multimeter or 2 or 3 or 4...or.....can't remember !.

The following users thanked this post: RaymondMack

RaymondMack

Re: Valhalla 2701c schematics + firmware V3

Regular Contributor



Posts: 63

Country:

 « **Reply #54 on:** July 27, 2021, 07:37:37 am »[Say Thanks](#)[Reply](#)[Quote](#)

Thanks for looking. Yours seems to be a year newer, so maybe it has newer firmware? I suppose I could get a AT28C64B EEPROM that Le_Bassiste suggested and see if the V3.0 FW has the IT2 code in it. I'm not sure I would trust leaving a AT28C64B in any equipment where it's used for the FW (seeing how it only has 10 years data retention), but for testing they look pretty neat to have around.

I noticed that you started the thread in 2017! What do you think is wrong with your calibrator?

[Report to moderator](#) [Logged](#) **lowimpedance**

Super Contributor



Posts: 1200

Country:

Watts in an ohm?

 **Re: Valhalla 2701c schematics + firmware V3**« **Reply #55 on:** July 28, 2021, 04:55:04 am »[Say Thanks](#)[Reply](#)[Quote](#)

The high voltage FET string is damaged , gets rather hot !, from memory. Isolating the regulator pass transistors TR 6 and 12 allowed me to test the operation of the micro system etc which looks ok. I will have another go at it soon when I get a few other jobs out of the way, and will post what needed replacing here for general info for others.

Interesting thought that if version 3 might have all the required code, would be easy to check with those parts already populated. Otherwise now having your firmware it maybe time to investigate the BOM for that option.

[Report to moderator](#) [Logged](#)

The odd multimeter or 2 or 3 or 4...or.....can't remember !.

 RaymondMack

Regular Contributor



Posts: 63

Country:

 **Re: Valhalla 2701c schematics + firmware V3**« **Reply #56 on:** July 30, 2021, 05:06:36 am »[Say Thanks](#)[Reply](#)[Quote](#)

Well, after soldering in the new bleeder resistors and radial electrolytic capacitors (of which all had failed in one way or another) the calibrator turned on and started working. DC volts was pretty close to bang on, maybe 10 or 20 counts out from my HP 3456A using some Pomona low thermal banana plug cables connected to the sense terminals. The current source option appeared to be a little noisy and was out of spec by about 400 counts. Visually, the current source circuit looks okay--there isn't any discoloration of the board from overheating or any obvious faults. And again, it appears to work, if a little noisy on the last digit.

While repairing the unit, I noticed some further heat related discoloration near the opto isolators around a TO-92 5V regulator and around the TO-220 +15V regulator a little further away as well as the big TO-3 5V regulator for the digital side. While turned on, all three of these parts get pretty damn hot. Is this normal? Or does this imply I have further issues that need to be resolved? Maybe I should replace the TO-92 with a TO-220 and put heat sinks on the TO-220 +-15V and the soon to be TO-220 5V reg near the optos.

The digital +5V side also had discoloration around the two rectifier diodes, but these now seem to run cool to the touch. I believe the 15000 cap was shorted, so it makes sense they had gotten toasty previously.

After working on this unit, I feel that the engineers at Valhalla had put in as much effort as possible to cut costs when designing this calibrator. At least three voltage regulators are either under specified or lack the appropriate heatsinking required to reliably perform their job. Almost every electrolytic capacitor is too close to high temperature parts while many resistors are under sized and likely not even rated for the applied voltage across them. Then there is the issue of the smaller transformer making faint arcing noises... And the list goes on! I would give these calibrators a C+: They work, but their construction and performance is just at the edge of useable.

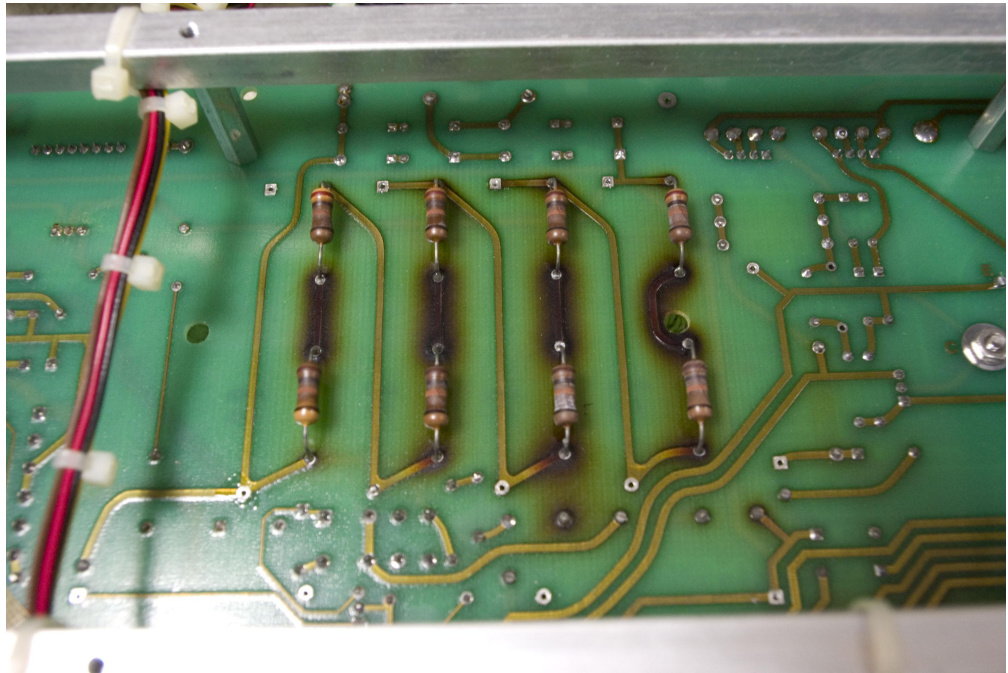

IMG0131.jpg (644.05 kB, 3000x2008 - viewed 154 times.)

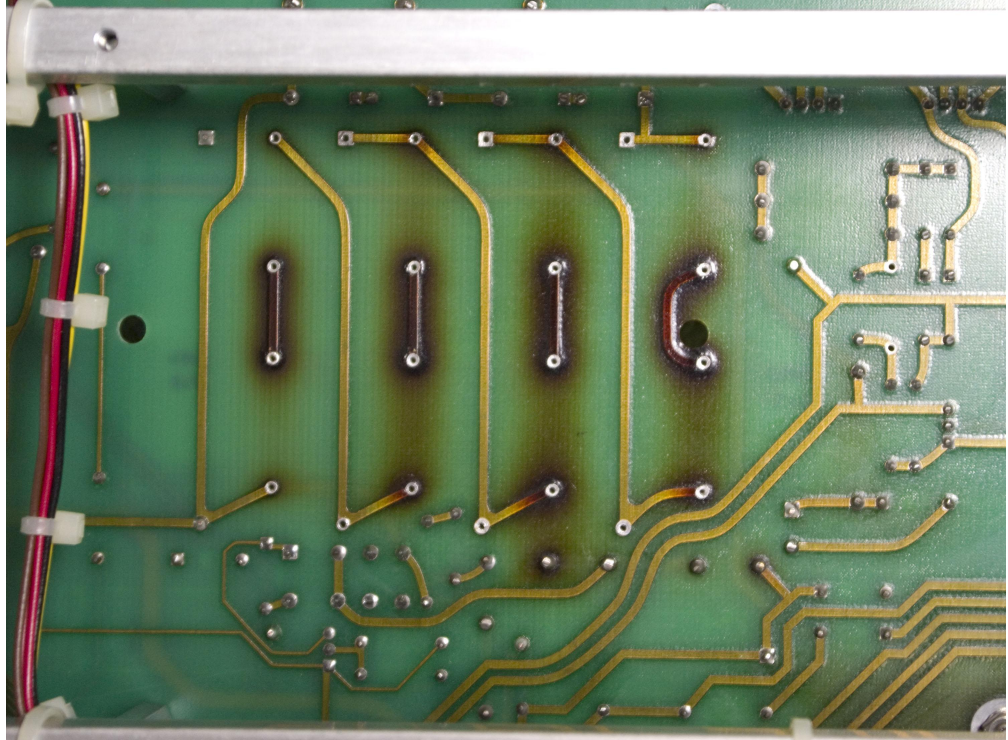

IMG02236.jpg (839.22 kB, 3000x2232 - viewed 139 times.)

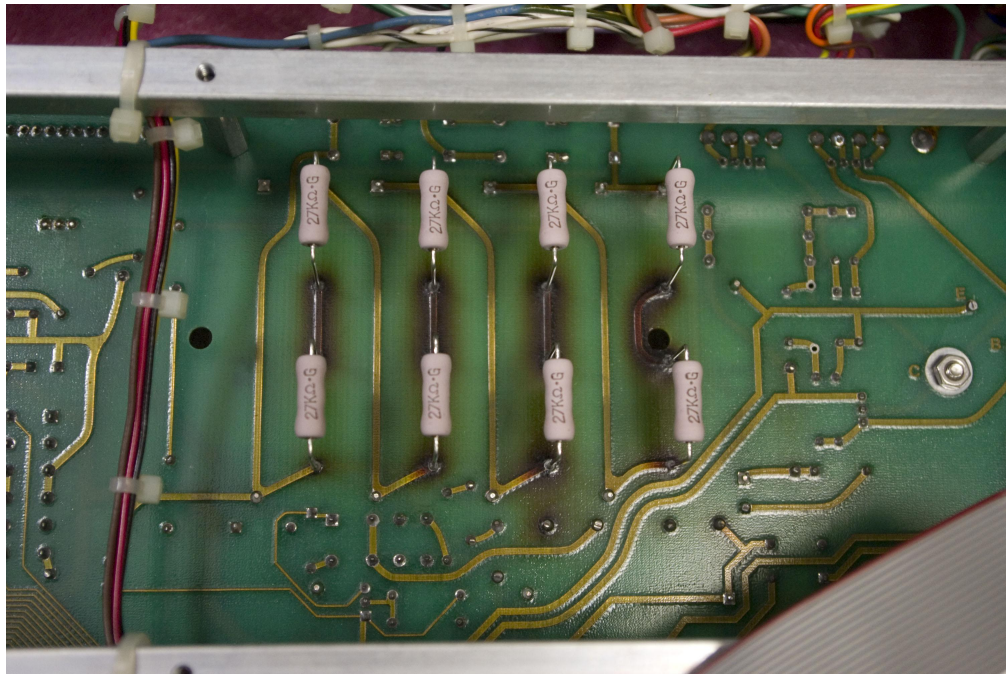

IMGP2238.jpg (758.26 kB, 3000x2008 - viewed 146 times.)

« Last Edit: August 04, 2021, 08:10:01 pm by RaymondMack »

Report to moderator Logged

The following users thanked this post: Le_Bassiste

Le_Bassiste

Regular Contributor



Posts: 242

Country:



Re: Valhalla 2701c schematics + firmware V3

Say Thanks

Reply

Quote

« Reply #57 on: July 30, 2021, 07:40:18 am »

Quote from: RaymondMack on July 30, 2021, 05:06:36 am

While repairing the unit, I noticed some further heat related discoloration near the opto isolators around a TO-92 5V regulator and around the TO-220 +5V regulator a little further away as well as the big TO-3 5V regulator for the digital side. While turned on, all three of these parts get pretty damn hot. Is this normal? Or does this imply I have further issues that need to be resolved? Maybe I should replace the TO-92 with a TO-220 and put heat sinks on the TO-220 +-5V and the soon to be TO-220 5V reg near the optos.

The digital +5V side also had discoloration around the two rectifier diodes, but these now seem to run cool to the touch. I believe the 15000 cap was shorted, so it makes sense they had gotten toasty previously.

in my unit, D212,D213 (5V supply rectifiers), IC201(5V regulator), IC202(+15V regulator) get well beyond 60°C, and there's some discoloration around D212/13. as for IC116 (5V regulator for the PWM isolators), i only can confirm indirectly, as i'm using an SOT223 on my opto-piggyback, which is somewhere in the 45°C range. what worries me are the D212, D213, IC201 cooking away, and i don't know how to tackle that. exchanging the diodes with schottkys would just move the saved losses over to IC201, which is already on the edge. IC201 is by far the hottest running part in my unit. my unit is running on 230 VAC, and i'm thinking about opening the linkage at PL202 and putting a high power chassis-mount resistor in series there to bring the secondary voltages down just a bit. that would hopefully cool off IC201 and then allow for the replacement of the diodes with schottky types.

i agree with your assessment that the entire unit is pretty much "auf kante genäht". funnily enough, the much older FLUKE 343 is running circles around it when it comes to noise and linearity performance. however, i am quite fond of the GPIB programmability and the straight-forward and easy to grasp concept, which makes it a fun playground for understanding precision equipment fundamentals and testing diy improvements. bottom line, though not flawless, its a keeper for sure. is it worth 10 grand? hell, no.

p.s.: as for the output noise, electrole pointed out that this is due to PWM-filtering issues and that the (LF-)noise can be improved by modifying the filter around IC8.

here's what i got after simply increasing R43,44 to 100k each:

(K2002: DC @ 20V, 10 NPLC, no FIL, SDEV after 200 readings. AC @ 200 mV, no FIL)

setpoint: 10.0V

FLUKE 343A: SDEV = 1.5 uV, VACRMS = 50uV (for comparison, my K2002 has its floor at 35 uV)

VS2701C : SDEV = 2.85 uV, VACRMS = 0.93 mV(!)

« Last Edit: July 30, 2021, 08:00:13 am by Le_Bassiste »

Report to moderator Logged

An assertion ending with a question mark is a brain fart.

The following users thanked this post: RaymondMack

 **Electrolite**

Contributor

Posts: 41

Country: 



 **Re: Valhalla 2701c schematics + firmware V3**

Say Thanks

Reply

Quote

« Reply #58 on: July 30, 2021, 01:06:20 pm »

I suppressed the PWM residuals to some extent in my 2701C, partly by changing the PWM low-pass filter, and partly by inserting a shield between the ends of the resistor pair R38A and R38B.

PWM-filter: I changed both C6 and C7 from 1 μF to 2.2 μF . This should give about 4 times better attenuation at the PWM chopper frequency, but I found to my disappointment that the reduction of the PWM noise was much smaller. I suspect the PWM transients are difficult to tame in the 2701C layout, which does not seem to have received sufficient attention to good layout practices.

R38 shield (check out the pictures): In the 2701C one end of R38A is connected to a node which has full PWM amplitude, and one end of R38B is connected to the feedback node of the chopper amplifier IC5. For some reason Valhalla decided to locate these two ends next to each other. As a result, the PWM transitions couple to IC5. The shield is an attempt to lower this coupling. Again, the improvement by the shielding was not large, about 3 dB, but at least the improvement shows that there is an issue with coupling. The cost of the shield is next to nothing, so I would recommend adding it.

The PWM is only one of the sources of noise in the 2701C, and most noise is caused by the power supply switcher. This is difficult to get around, and real improvements will require another (non-switched) fixed-voltage supply, and getting rid of the 1200 V range, much in line with the LN-option Valhalla offered.

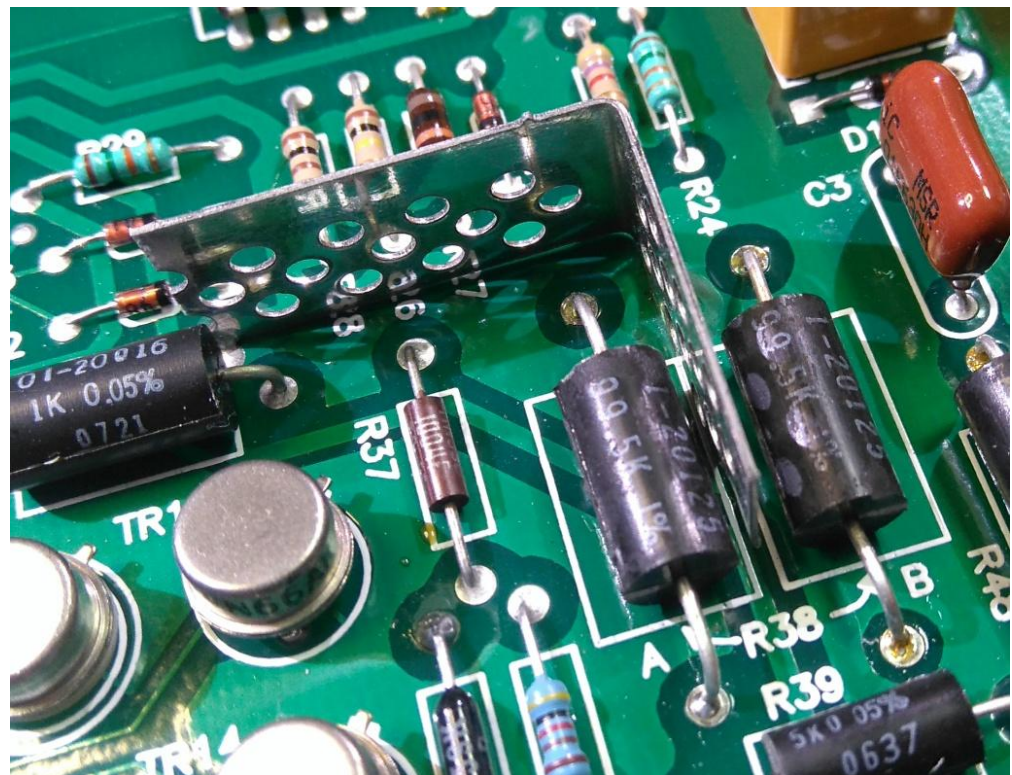

 R38 shield DSC_0044.jpg (389.56 kB, 1029x793 - viewed 105 times.)

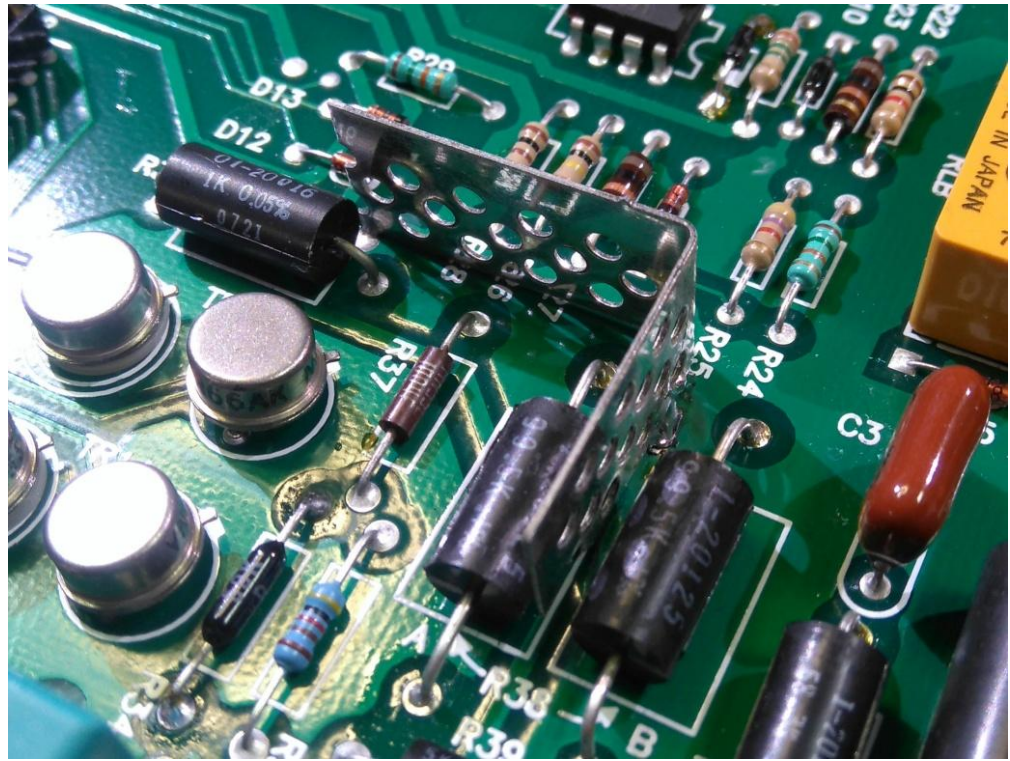

R38 shield DSC_0045.jpg (369.77 kB, 1036x782 - viewed 100 times.)

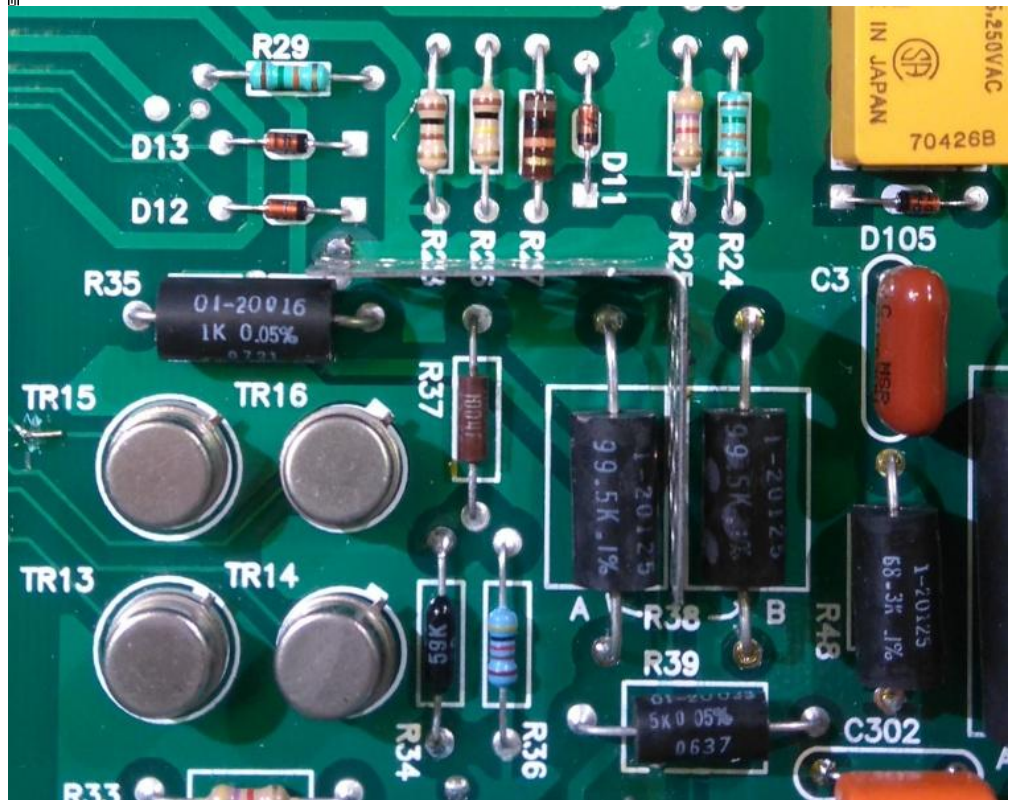

R38 shield DSC_0046.jpg (232.09 kB, 757x602 - viewed 100 times.)

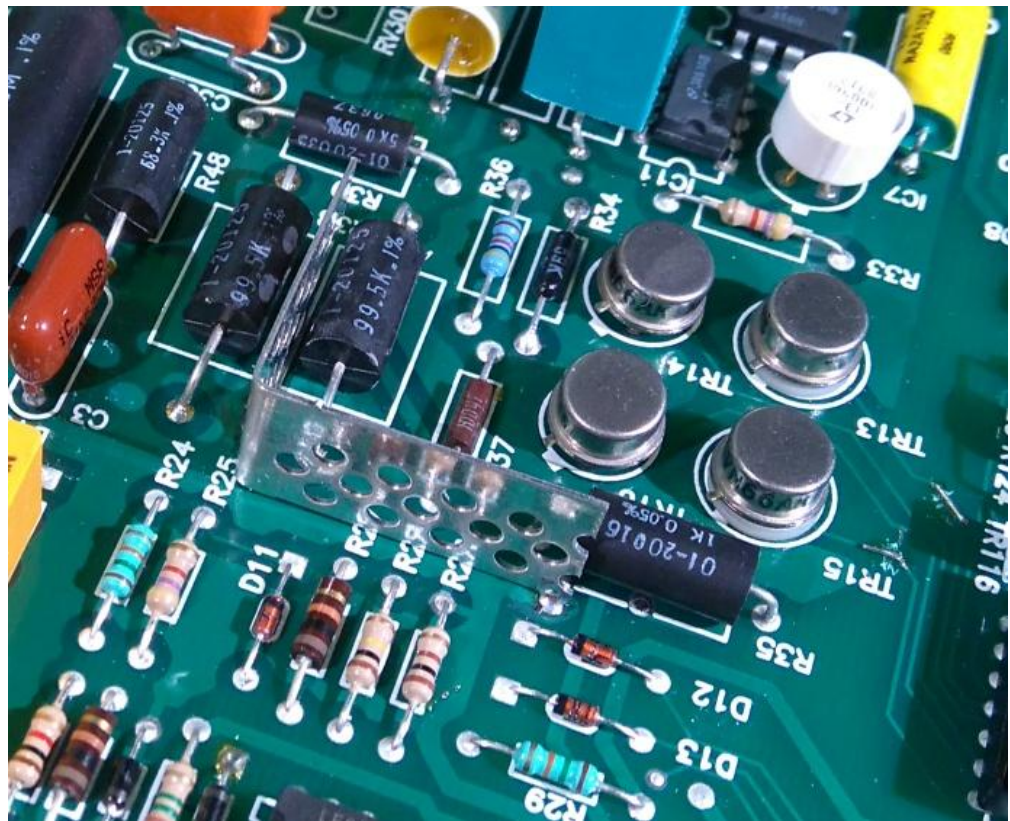

R38 shield DSC_0048.jpg (243.51 kB, 689x562 - viewed 106 times.)

Report to moderator Logged

The following users thanked this post: ch_scr, RaymondMack

RaymondMack

Regular Contributor



Posts: 63

Country:



Re: Valhalla 2701c schematics + firmware V3

Say Thanks

Reply

Quote

« Reply #59 on: July 30, 2021, 08:50:42 pm »

So I just ran a few tests and I think I'll need to do most of these modifications to lower the noise on the output. Using my Racal Dana 5002, I measured 6 mVrms AC ripple on the output at full bandwidth with the Valhalla set to 10V. With the 100kHz filter enabled that dropped to 0.441 mVrms, so there is a lot of HF content in the noise. Flipping the isolate switch to earth ground, the noise jumps to 7.3 mVrms. Using my HP 3400B I measured the same 7.3 mVrms wideband noise (it's input is earth referenced and has no option for ground isolation).

While looking at photos of other people's units, I noticed that some have two orange capacitors connected between Low Sense and Low Out to earth/chassis ground. Why would some units have these installed and other not? I have a couple of these exact same caps sitting in a parts bin...I guess it couldn't hurt to try installing them. Hopefully it helps with attenuating some of the HF noise on the output.

I also need to look at the slew rate of the switcher and check for ringing. I'm also curious if changing out the series connected 1N4007s with proper HV diodes will reduce the HF noise. Though that might just be a drop in the bucket with regards to noise sources in these units.

10V, 100 NPLC, Duration: 28m 56s

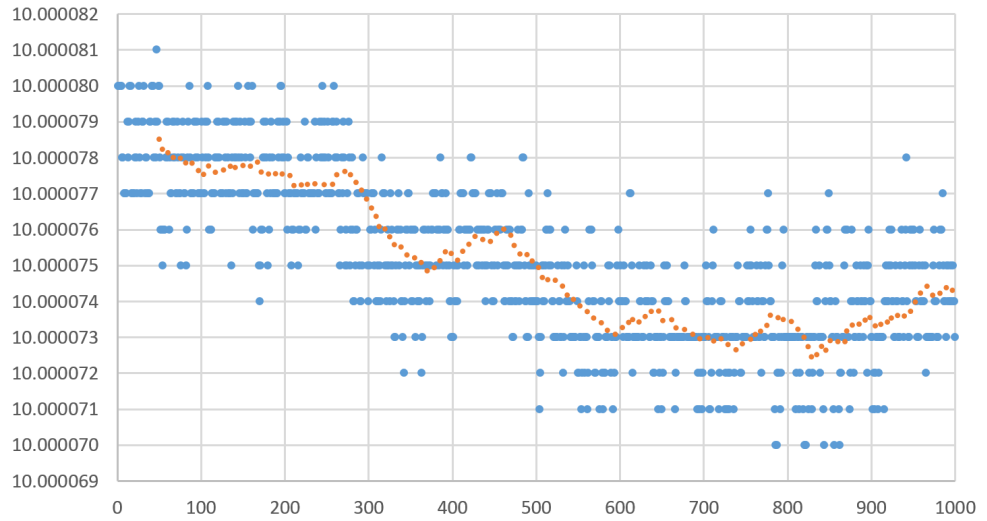

1k_samples_100nplc.png (78.96 kB, 1483x886 - viewed 78 times.)

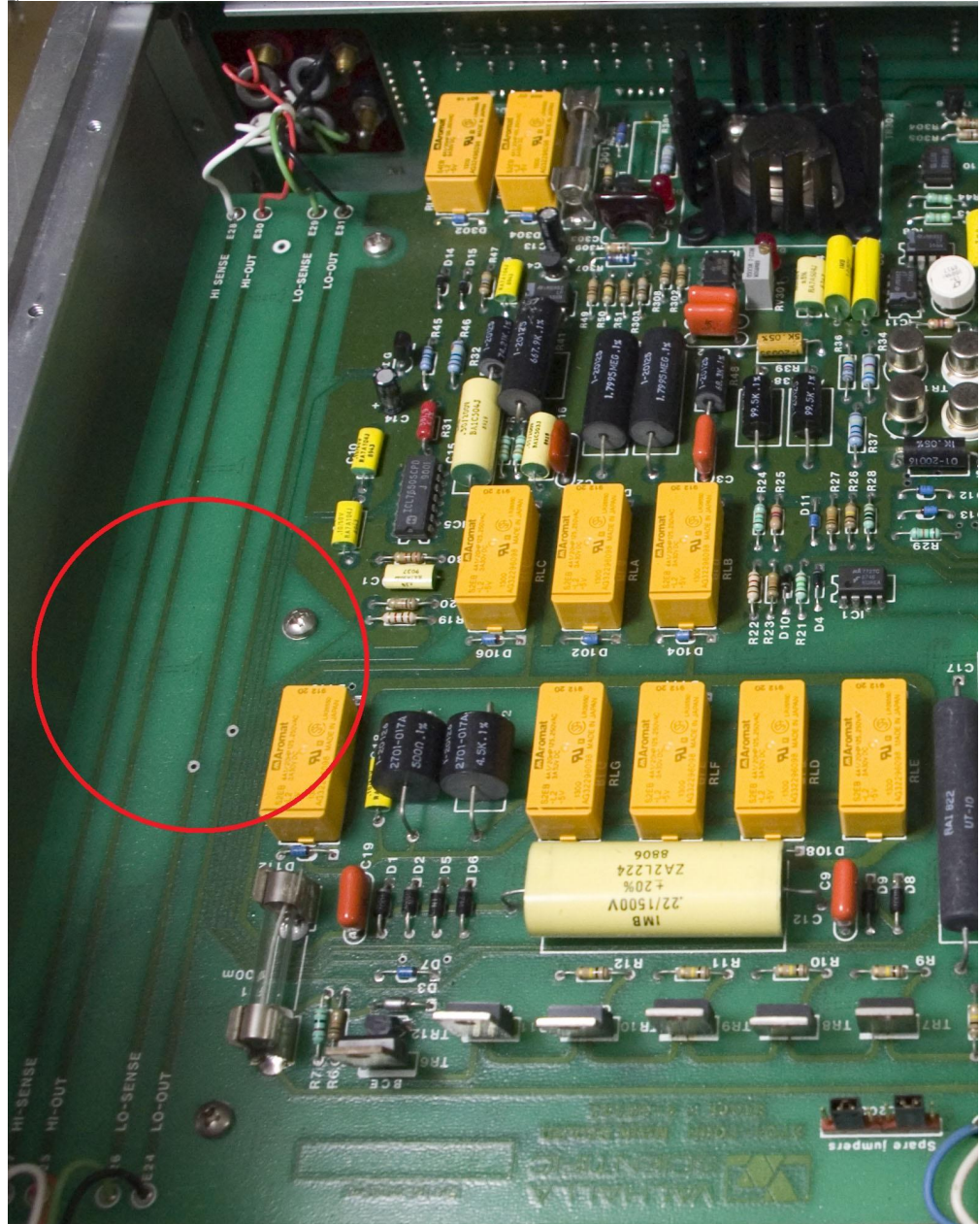

my_unit_without_caps.jpg (758.99 kB, 1576x1991 - viewed 113 times.)

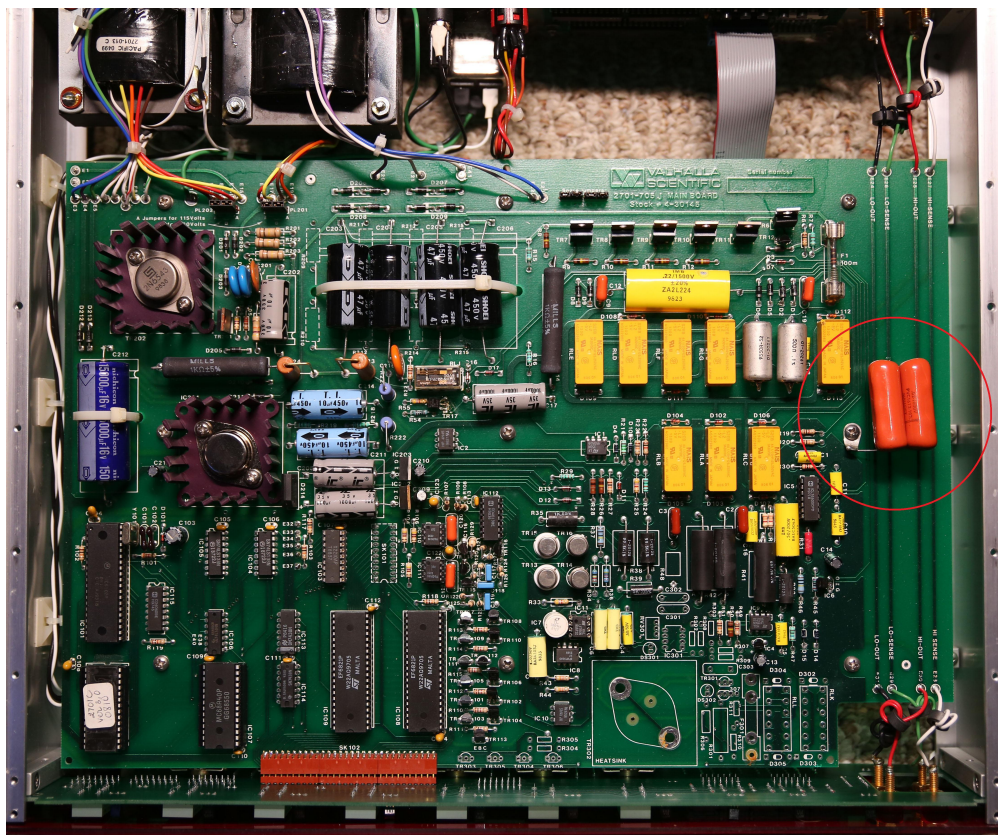

with_low_to_earth_caps.jpg (2467.7 kB, 4428x3672 - viewed 112 times.)

[Report to moderator](#)

Electrole

Contributor

Posts: 41

Country:



Re: Valhalla 2701c schematics + firmware V3

[Say Thanks](#) [Reply](#) [Quote](#)

« **Reply #60 on:** July 30, 2021, 09:43:29 pm »

Interesting that not all units have the two capacitors installed. I just checked my unit, and it has two orange 20 nF / 1600 V film capacitors mounted in parallel between chassis and the LO-SENSE node.

There is one unused pad for LO-SENSE, and another for LO-OUT, but only the pad for LO-SENSE is used for the capacitors; There is no capacitor connected between LO-OUT and chassis. Both are connected between chassis and the LO-SENSE node.

I assume these capacitors were mounted to suppress some emission of switching noise from the power supply, but the issue is that the power supply pollutes the calibrator with switching noise in the first place.

If you add similar capacitors, or one sufficiently large, let us hear if this changes your noise measurements.

[Report to moderator](#)

The following users thanked this post: RaymondMack

RaymondMack

Regular Contributor



Posts: 63

Country:



Re: Valhalla 2701c schematics + firmware V3

[Say Thanks](#) [Reply](#) [Quote](#)

« **Reply #61 on:** July 30, 2021, 11:21:21 pm »

Thanks. I couldn't see how they were connected and assumed that LO-SENSE also had a capacitor installed.

I'll keep everyone updated on the changes as I incrementally do the suggested mods. Hopefully I can tame the noise somewhat. And eventually find a better calibrator... These 2701Cs are pretty disappointing to be completely honest.

« *Last Edit:* July 31, 2021, 04:17:06 am by RaymondMack »

[Report to moderator](#)

RaymondMack

Regular Contributor





Posts: 63

Re: Valhalla 2701c schematics + firmware V3

[Say Thanks](#) [Reply](#) [Quote](#)

« **Reply #62 on:** July 31, 2021, 02:23:17 am »

Country: 

I installed the 2x 20nF, 1.6kV capacitors. Tried to make it look factory done, but ended up touching the edge of a relay with my soldering iron . But other than that goof, I think it looks good. It's pretty surprising I had these exact caps in my junk bin.

Anyways, I hooked everything back up the same as before and actually saw a minor reduction in noise as measured by the Racal Dana 5002 and HP 3400B.

Wide band noise measured with the 3400B dropped to 2.55 mVrms while the Racal Dana saw a much less impressive 4.27 mVrms isolated and 4.92 mVrms when earth referenced. Using the 100kHz filter on the 5002 saw a minor reduction as well 0.217 mVrms isolated and 0.275 mVrms when earth referenced. Interestingly, looping the coax through a ferrite choke (split clamshell type) drops the isolated 100kHz measurement to 0.130 mVrms and the wideband noise to 2.56 mV. For whatever reason, the 3400B shows very little change with the ferrite. My guess is there is some sort of ground interaction between the 2701C and 5002.

So it helped, but certainly wasn't a magic bullet.

With the above in mind, I think a common mode ferrite tube could help to reduce the HF noise content if placed before the small ferrite toroids on the front panel wiring.

Next up will be the 2.2uF filter capacitors and then checking the slew rate and dampening of the switching supply.

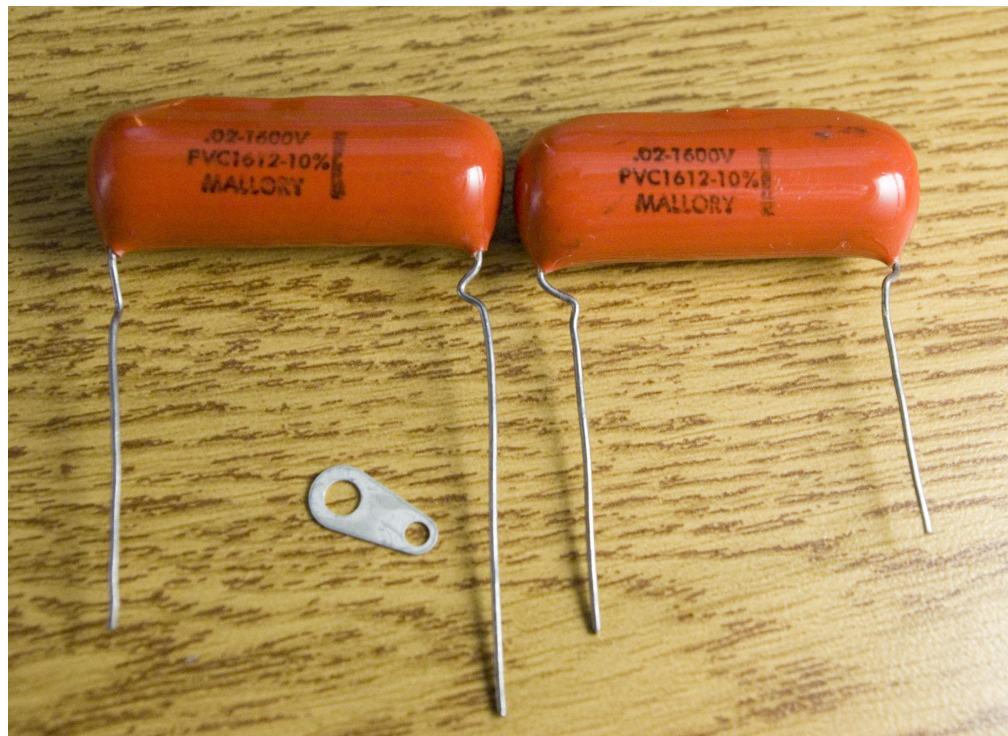

IMGP2242.jpg (474.73 kB, 2000x1463 - viewed 85 times.)

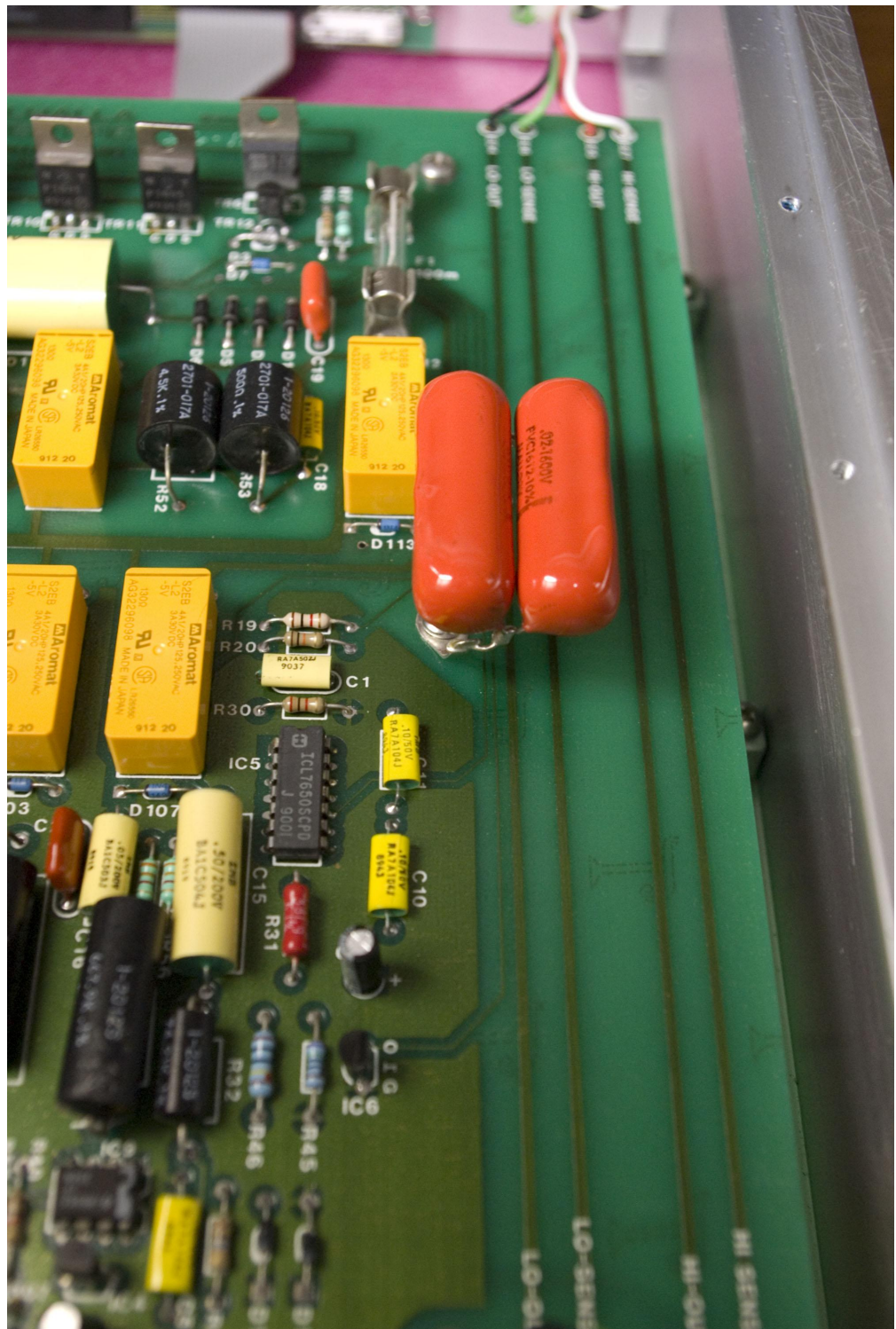

IMGP2245.jpg (674.5 kB, 2008x3000 - viewed 95 times.)

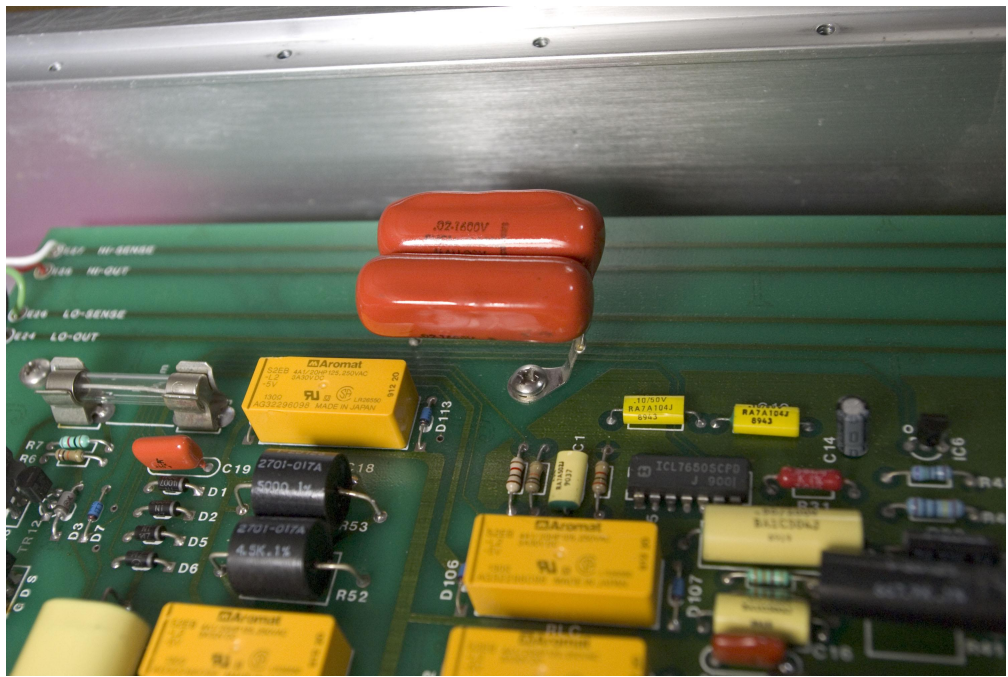

IMGP2246.jpg (631.4 kB, 3000x2008 - viewed 91 times.)

[Report to moderator](#) [Logged](#)

The following users thanked this post: quarks

RaymondMack

Regular Contributor



Posts: 63

Country:



Re: Valhalla 2701c schematics + firmware V3

[Say Thanks](#) [Reply](#) [Quote](#)

« **Reply #63 on:** July 31, 2021, 04:04:55 am »

I was trying to figure out why the 5002 and 3400B were getting different readings, as they usually agree on most measurements and I found that there is about a 100 mVrms to earth ground from either terminal of the 2701C. I need to lift the 2x 20nF capacitor and see how that affects this common mode AC signal, but there is indeed some ground loop interaction that is throwing off my measurements.

Previously I measured the output noise with a Tektronix DMM4050 to around 1.24 mV using the slow filter. After the capacitor mod it now reads 0.07 mV. So it does look like it actually helps with the noise.

If someone else could measure the AC voltage between each terminal of their 2701C to earth/chassis ground while on the 10V range I would appreciate it.

« Last Edit: July 31, 2021, 04:14:25 am by RaymondMack »

[Report to moderator](#) [Logged](#)

Electrole

Contributor

Posts: 41

Country:



Re: Valhalla 2701c schematics + firmware V3

[Say Thanks](#) [Reply](#) [Quote](#)

« **Reply #64 on:** July 31, 2021, 08:29:30 am »

I did a few RMS measurements on my 2701C this morning.

NOTE: The power switcher in my 2701C is not the original. I made a new one from scratch as the switcher was blown in my 2701C when I got it. This is likely going to impact the switching noise generated, and thereby the RMS measurements. I hope that other owners of a 2701C (with the original switcher) can make RMS measurements, so that we may compare. Anyway, here are my numbers:

Between 2701C chassis and any of the four output terminals, 20 V range and 10 V setting, activate or standby:

About 215 mV measured with a Racal-Dana 9300B

About 217 mV measured with a Rohde & Schwarz URE (same reading in different BW settings => Must be dominated by LF noise)

Between the output terminals, 20 V range and 10 V setting

Operate:

Rohde & Schwarz URE, full BW: 1.054 mV (drops to 0.968 mV when connecting the chassis to the

negative terminal)

Rohde & Schwarz URE, 100 kHz BW: 0.274 mV

HP 3400A: About 1.05 mV

Racal-Dana 9300B: About 1.29 mV

Standby:

Rohde & Schwarz URE, full BW: 1.048 mV (drops to 0.945 mV when connecting the chassis to the negative terminal)

Rohde & Schwarz URE, 100 kHz BW: 0.268 mV

HP 3400A: About 1.02 mV

Racal-Dana 9300B: About 1.28 mV

The larger reading by the Racal-Dana 9300B can be explained by its wider bandwidth (-3 dB @ 57 MHz) compared to the HP 3400A and the R&S URE.

The measurements are sensitive to the wiring of the setup. By merely touching the instruments I could make the values change. This could be an indication of switching noise being radiated from both the output terminals and the power line. During the measurements the 2701C and the RMS meters were connected to the same power outlet strip with ground, and all power cables used had ground. On my web page <https://dabbledoo.weebly.com/valhalla-2701c.html> there are a few more noise measurements.

Besides this, your measurements in 100 kHz bandwidth are not far from mine, but you seem to have more noise in a wide bandwidth. Maybe that is related to the some of the components I added to the power switcher. For instance, I have a 680 nF / 300 VAC noise suppressing capacitor connected across the mains power going to the switcher. If you try something similar make sure that the capacitor is a Class X safety capacitor.

[Report to moderator](#)  Logged

The following users thanked this post: RaymondMack

Electrole

Contributor

Posts: 41

Country: 



Re: Valhalla 2701c schematics + firmware V3

« Reply #65 on: August 01, 2021, 07:37:27 pm »

[Say Thanks](#)

[Reply](#)

[Quote](#)

Just a few additional observations:

The measured noise level of my 2701C depends on what's connected to the mains elsewhere in the lab!

By switching on an LED lamp having a switch-mode driver the measured level increases some 10 %, even though the lamp and its driver are located 2 m away.

The effect can be reduced by adding clamp-on ferrites to the output and/or to the mains inlet of the 2701C.

This was observed using the Rohde & Schwarz URE RMS Voltmeter connected to the same mains outlet strip as the Valhalla 2701C, and with 1 m coaxial cable between the 2701C and the URE.

Without making further investigations I cannot tell how much noise is being picked up by the measurement setup and how much really comes from the 2701C. However, the measured noise level is without doubt higher from the 2701C than from my Fluke 5440B using the same setup. The 5440B gives 316 μ V at full bandwidth of the URE, whereas the 2701C gives about 1 mV (at least my units do). The noise floor of the URE is about 78 μ V at full bandwidth, so the actual figures will be lower.

I also tried to de-activate the switching pre-regulator in the 2701C and replaced the supply with an external supply.

This did to my surprise NOT reduce the noise, at least not in the specific setup with 10 V output in the 20 V range, and no load. Clearly, the switcher is not the sole source of the elevated noise we see.

I'm still thinking the seemingly disorganized layout of the 0V(a) reference plane in the 2701C is partly to blame for the noise issues and puts a limit on how much we may reduce the noise 😞

As a final remark, I have for a while used a combined common-mode and differential-mode filter on the output of the 2701C in order to reduce the noise.

This turned out to be necessary in order not to overload my EM N1a nanovoltmeter when making measurements between the 2701C and other DC-sources!

[Report to moderator](#)  Logged

The following users thanked this post: RaymondMack

RaymondMack

Regular Contributor



Posts: 63

Re: Valhalla 2701c schematics + firmware V3

« Reply #66 on: August 02, 2021, 06:44:18 pm »

[Say Thanks](#)

[Reply](#)

[Quote](#)

Country: 

Thanks for performing those measurements Electrole, I really appreciate the time you took to make them.

I did a second round of tests to see how the two 20nF capacitors affected the output of the 2701C.

All measurements are wideband RMS using the 3400B with the 2701C set to the 20V range and 10V output. The 3400B is using a 1 meter RG223 BNC cable with three ferrite CM chokes attached to the cable during assembly and a Pomona BNC to 4mm banana plug adapter on the end. The 2701C and 3400B are connected to the same mains power strip with about 400 uV between chassis grounds (measured by connecting the 3400B HI to the 2701C's chassis). So ground loop current shouldn't be a concern.

With the 2x 20nF capacitors disconnected (screw connecting the ring terminal to chassis ground removed):

AC common mode at each of the four terminals to earth/chassis ground was about 2.5V. This seems rather high.

2701C Polarity	Connections	Sense Terminals	Output Terminals
Normal (+)	3400B HI/LO to 2701C HI/LO	6.5 mV	6.6 mV
Normal (+)	3400B HI/LO to 2701C LO/HI	7.5 mV	7.3 mV
Reverse (-)	3400B HI/LO to 2701C HI/LO	7.2 mV	7.3 mV
Reverse (-)	3400B HI/LO to 2701C LO/HI	6.8 mV	6.6 mV

With the 2x 20nF capacitors connected:

AC common mode at each of the four terminals to earth/chassis ground was about 86 mV. Much lower, but still higher than I'd like. I think another bypass capacitor should be located closer to the source of the common mode AC signal.

2701C Polarity	Connections	Sense Terminals	Output Terminals
Normal (+)	3400B HI/LO to 2701C HI/LO	1.6 mV	2.5 mV
Normal (+)	3400B HI/LO to 2701C LO/HI	3.1 mV	3.5 mV
Reverse (-)	3400B HI/LO to 2701C HI/LO	3.2 mV	3.2 mV
Reverse (-)	3400B HI/LO to 2701C LO/HI	1.5 mV	1.8 mV

Since the 3400B's LO terminal is earth referenced, we can see that orientation of the connection to the 2701C affects the measured noise. This leads me to believe the location Valhalla chose to place the 2x 20nF bypass capacitors does not seem optimal. Once I get this sorted I'll try adjusting the filter capacitors C6-8 and possibly try swapping the ICL7650S with an LTC1052 or TLC2652A.

« Last Edit: August 02, 2021, 07:06:26 pm by RaymondMack »

[Report to moderator](#)  [Logged](#)

The following users thanked this post: quarks, Le_Bassiste

Le_Bassiste

Regular Contributor



Posts: 242

Country: 



Re: Valhalla 2701c schematics + firmware V3

[Say Thanks](#)

[Reply](#)

[Quote](#)

« **Reply #67 on:** August 03, 2021, 07:53:26 am »

Quote from: RaymondMack on August 02, 2021, 06:44:18 pm

...Once I get this sorted I'll try adjusting the filter capacitors C6-8 and possibly try swapping the ICL7650S with an LTC1052 or TLC2652A.

the pin-layout of IC5 basically "supports" 8DIP packages, so it's easily doable. trying different chopper amps would require a socket in place of IC5 in order to enable exchange of DUTs. however, the presence of a socket alone could induce enough thermal noise and drift that it would easily mask any positive effect of the DUT on the overall performance of the calibrator.

i tried exactly that with an ADA4522-1 in my 2701C and i couldn't find any improvement over the original ICL7650S (output drift, SDEV). so, either the ADA4522 wasn't the best choice in the first place, or i screwed it because of the socket that i was using. i ended up with removing the socket and putting the ICL7650S (a fresh one, that is) back in.

looking forward to read about your findings!

as for the low frequency noise in the region of $x \dots 120$ Hz, there's one interesting phenomenon that i could observe while taking DCV readings with less than 10 NPLC and no FIL: the fluctuation of the measurement was periodic. this suggests that the LF output noise is indeed stemming from the PWM stage rather than mains hum, as the clock of the PWM is running at approx. 90 Hz, thus escaping the

filtering of the mains-synched NPLC settings.
 this also suggests that the mains pre-regulator is a major noise contributor in the HF region, but not so much in the LF portion of the noise, where the PWM dominates.

« Last Edit: August 03, 2021, 08:13:32 am by Le_Bassiste »

Report to moderator Logged

An assertion ending with a question mark is a brain fart.

The following users thanked this post: RaymondMack

Electrole

Contributor

Posts: 41

Country:



Re: Valhalla 2701c schematics + firmware V3

Say Thanks Reply Quote

« Reply #68 on: August 03, 2021, 09:52:31 pm »

I thought I'd better do a fresh FFT of the signal from the 2701C. Again, the 2701C was set to 10 V in the 20 V range.

I amplified the output signal (AC-coupled) by an EG&G model 113 amplifier in balanced mode, set to 100 x gain, and digitized with a National Instruments USB-4431.

The sampling rate was set to 20 kHz and 20 k samples so that I focus on frequencies up to 10 kHz, and I used the RMS averaging function in NI's "Power Spectrum and PSD.vi".

I have included two spectra: One with a logarithmic frequency scale from 0.1 Hz to 10 kHz, and one with a linear frequency scale between DC and 2 kHz.

You can clearly see the mains related components (50 Hz here in Europe) and the PWM-related components.

The graphs are scaled so that the 100 x gain is compensated for. The levels therefore represent what we see on the 2701C output.

Le_Bassiste, you may be right about the mains components being dominant at high frequencies, but it's hard to tell from this FFT included here.

I may try to do another FFT later ... 😊

A while ago, I considered finding a better substitute for the chopper amplifier, but that was before I realized how noisy the 2701C is.

I have no measurements of the 2701C with the original pre-regulator switcher, but the data provided by RaymondMack suggest that it may even be noisier (though there may be differences caused by our measurement setups). The effort is therefore better spent trying to lower the noise in a 2701C, I believe.

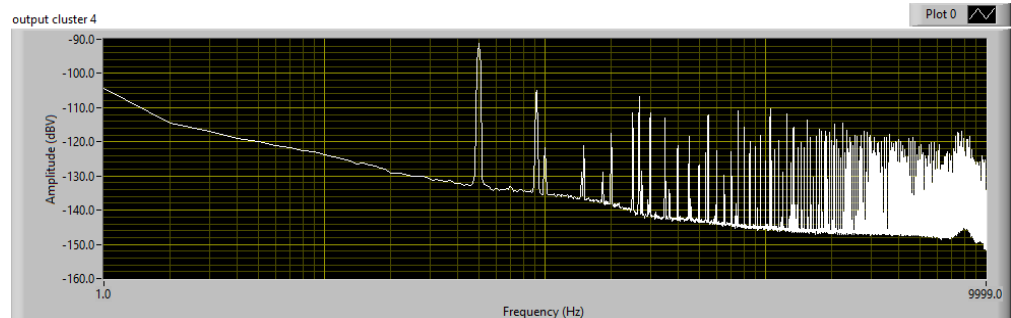

Valhalla 2701C 10V in 20V range via EG&G 100x 100 mHz - 10 kHz 20kHz 20kS.png (14.3 kB, 984x313 - viewed 83 times.)

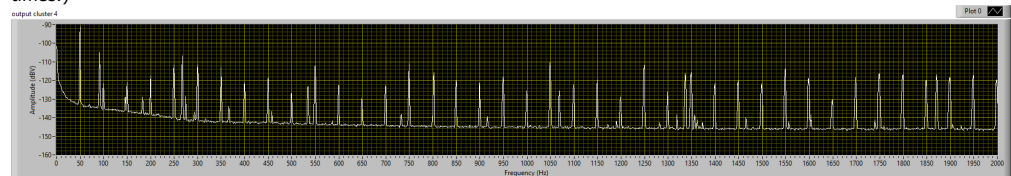

Valhalla 2701C 10V in 20V range via EG&G 100x Lin scale DC-2kHz 20kHz 20kS.png (28.29 kB, 1812x313 - viewed 66 times.)

Report to moderator Logged

The following users thanked this post: Le_Bassiste, RaymondMack

Le_Bassiste

Regular Contributor



Re: Valhalla 2701c schematics + firmware V3

Say Thanks Reply Quote

« Reply #69 on: August 04, 2021, 08:33:09 am »

Quote from: Electrole on August 03, 2021, 09:52:31 pm



Posts: 242
Country:



I have included two spectra: One with a logarithmic frequency scale from 0.1 Hz to 10 kHz, and one with a linear frequency scale between DC and 2 kHz.
You can clearly see the mains related components (50 Hz here in Europe) and the PWM-related components.
The graphs are scaled so that the 100 x gain is compensated for. The levels therefore represent what we see on the 2701C output.
Le_Bassiste, you may be right about the mains components being dominant at high frequencies, but it's hard to tell from this FFT included here.
I may try to do another FFT later ... 😊

thanks for the log diagram! yeah, i can see now that my wording is misleading, because in your FFT diagram the AC mains components are indeed the major contribution in LF range. however (and that was the point i was trying to make), on a DMM that has its sampling synched with AC mains and NPLC, AC mains components (fundamentals and harmonics) will be "punched out" of the spectrum, thus making the PWM (@ 90 Hz) the main contributor in the DMM readings, aka SDEV.

as for your filter optimization around IC8: did you have the chance to test different opamps? i found an OPA134 to give at least some improvement (10%, iirc) over the LF356.

« Last Edit: August 04, 2021, 08:35:43 am by Le_Bassiste »

Report to moderator Logged

An assertion ending with a question mark is a brain fart.

The following users thanked this post: RaymondMack

Electrole

Contributor

Posts: 41
Country:



Re: Valhalla 2701c schematics + firmware V3

Say Thanks Reply Quote

« Reply #70 on: August 08, 2021, 12:52:12 pm »

Inspired by the observations with the OPA134 made by Le_Bassiste I measured the noise of the Valhalla 2701C when using different op-amps for IC8 in the low-pass filter: LF356N (used by Valhalla), and these following substitutes: AD743JN, AD711AQ, OPA277PA, LT1677IN8 and LT1793ACN8. These were selected among single op-amps with low current noise I had readily available. I did not have the OPA134 available.

The noise in 10 kHz bandwidth was measured with NI USB-4431 with EG&G model 113 (set to 100 x gain) as pre-amplifier, with the 2701C set to 10 V in its 20 V range. I found that the measured noise was essentially the same for all op-amp used in this test, around 29.2 to 29.8 mV, with no solid correlation to the op-amp used.

The wide-band noise (about 20 MHz) was measured with Rohde & Schwarz URE, with the 2701C set to 10 V in 20 V range. This was also essentially the same for all op-amps used in this test, about 1.36 mV - 1.41 mV (which is higher than my previous measurements as the mains related noise using this setup depends on what else is connected to my mains power strip!) Again, not really any correlation to the op-amp used in this test.

The interesting part, however, is the low-frequency noise. At low frequencies the 1/f noise performance of the op-amp used for IC8 makes a difference. I measured the low-frequency noise with an EM Electronics model N1a nanovoltmeter (via a filter between the 2701C and the N1a to suppress noise above 10 Hz, and common-mode noise), with the 2701C set to 10 μ V in the 2 V range. The voltage from the N1a was digitized by a Fluke 8842A at its medium measurement rate. An FFT was made on filtered data in LabVIEW. The LF356N used by Valhalla gives the highest noise of the op-amps used in this test. The following summarizes the findings, expressed as the standard deviation, and the observed peak-to-peak voltage, for two different frequency spans:

LF356N

Std. dev. = 305 nV / 2.33 μ Vpp 0.01 Hz - 1 Hz

Std. dev. = 269 nV / 2.31 μ Vpp 0.1 Hz - 1 Hz

AD743JN

Std. dev. = 199 nV / 1.77 μ Vpp 0.01 Hz - 1 Hz

Std. dev. = 162 nV / 1.48 μ Vpp 0.1 Hz - 1 Hz

AD711AQ

Std. dev. = 217 nV / 1.79 μ Vpp 0.01 Hz - 1 Hz

Std. dev. = 184 nV / 1.41 μ Vpp 0.1 Hz - 1 Hz

OPA277PA

Std. dev. = 204 nV / 1.51 μ Vpp 0.01 Hz - 1 Hz

Std. dev. = 163 nV / 1.23 μ Vpp 0.1 Hz - 1 Hz

LT1677IN8

Std. dev. = 257 nV / 2.11 μ Vpp 0.01 Hz - 1 Hz

Std. dev. = 222 nV / 1.82 μ Vpp 0.1 Hz - 1 Hz

LT1793ACN8

Std. dev. = 249 nV / 1.91 μ Vpp 0.01 Hz - 1 Hz

Std. dev. = 200 nV / 1.58 μ Vpp 0.1 Hz - 1 Hz

Based on this, I think it would sense to replace the LF356 with AD743, AD711 or OPA277. Other op-amps may be work equally well, the question is where the 1/f noise kicks in and that the op-amp is fine with the actual impedance level of the filter. Some low-noise op-amps with high current noise will not produce good results.

The OPA134 has low current noise, but its 1/f voltage noise starts to creep up below 100 Hz, so it would be interesting to find the noise at low frequencies.

Le_Bassiste: What was the frequency span of your measurements when you observed the improvement compared to LF356N?

[Report to moderator](#)  [Logged](#)

The following users thanked this post: quarks, RaymondMack

 **RaymondMack**

Regular Contributor



Posts: 63

Country: 



 **Re: Valhalla 2701c schematics + firmware V3**

[Say Thanks](#)

[Reply](#)

[Quote](#)

« **Reply #71 on:** August 08, 2021, 11:00:45 pm »

Thanks for taking those measurements Electro! I have some OPA277PA sitting in a drawer, should be an easy swap. Though maybe I should put a gold plated collet socket for comparison tests. I have an EG&G 5113 preamp and an Agilent 89410A VSA that can do FFT up to 10MHz for comparison. Probably not the best setup, but it should work.

Unfortunately further progress from me is halted since I killed one of the HV MOSFETs 🤦 while probing around with my DMM. I believe my unit has an issue with the smaller transformer. With the 2x 20nF capacitor removed I can hear audible buzzing from the small transformer used to power the mainboard. When the bypass capacitor is installed the buzzing greatly quiets down, but doesn't completely go away. I need to put one of my wideband current probes on the capacitor to see what the ground current looks like.

When probing with my DMM4050 in AC volts (approx. 1 megohm AC coupled to earth ground) the compliance light in the current source would start flashing/dimly glow and random relays would start switching on and off. The 2701C uses opto isolators with the digital side connected to earth ground, so I don't think it has to do to the digital side. It must be one of the protection mechanisms on the analog side getting triggered. This would happen when trying to measure the AC common mode at node "L" on C211 as well as transformer nodes E9 and E10 on the edge of the PCB. In particular, the HV MOSFET died while probing E9, which caused the relays and LEDs to start randomly clicking/light up. It seemed like an oscillation. After disconnecting the DMM, relay RLJ clicked on and off about once per second 🗡️. If I remember correctly, I had disconnected the 2x 20nF capacitors and everything from the front panel terminals. So the only current path would be leakage / arcing through the transformer itself.

While killing my 2701C I did discover that the primary source of my CM noise is not related to the switching supply. I believe that the bypass capacitor should be located at node "L" but while probing I had the issues discussed above. Looking at the schematic, I don't see how I killed the MOSFET or why the entire analog circuit goes haywire when probing E9, E10 or "L". Node "L" is connected to earth ground by the 2x 20nF when set to normal polarity through relays RLD and RLG. This is why the noise goes up when the polarity is reversed: node "L" is disconnected from the bypass capacitors and the CM signal passes through the HI lead of my 3400B to earth ground. Moving the bypass capacitor closer to "L" should--in theory--help with my noise issue as it shortens the path length and ignores the polarity reversal relays.

I should have some replacement MOSFETs here soon. There may be a few more parts that need to be replaced, as I haven't done an exhaustive search for bad parts yet. Thankfully the analog side is fairly simple, so it shouldn't be too hard to get it working again.

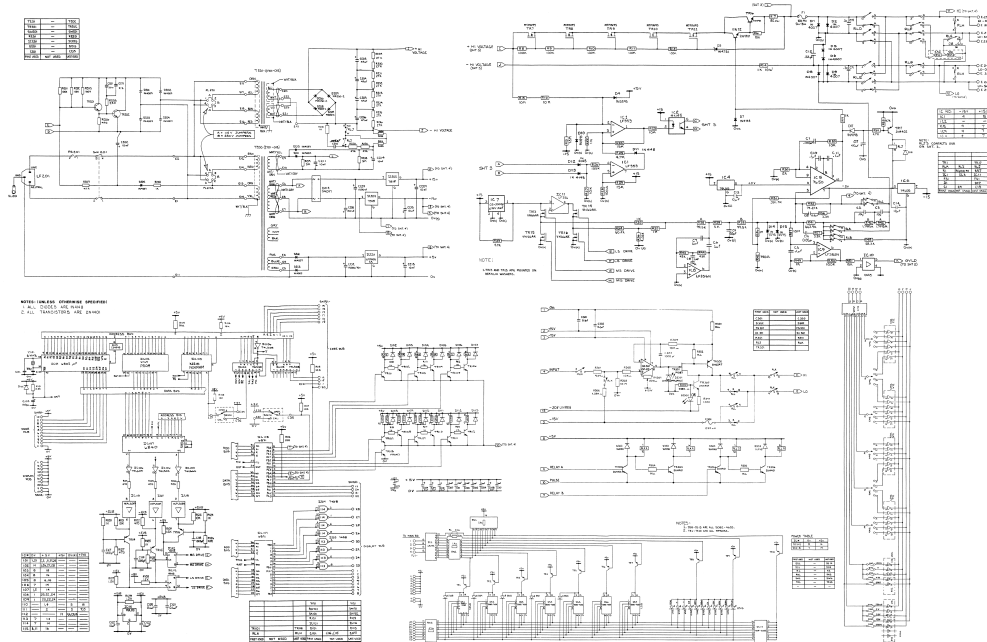

2701C_schematic.png (2576.83 kB, 7181x4673 - viewed 99 times.)

Report to moderator Logged

The following users thanked this post: quarks

RaymondMack

Regular Contributor



Posts: 63

Country:



Re: Valhalla 2701c schematics + firmware V3

Say Thanks Reply Quote

« Reply #72 on: August 12, 2021, 11:05:18 am »

I finished repairing the 2701C today. All that had failed was a single MTP1N95 MOSFET. That said, I decided to replace all five with FQP2N90 from onsemi so the threshold voltages of each part would match. The FQP2N90 are a reasonably close match for the MTP1N95 and seem to work fine so far.

While checking the calibrator over, I noticed that some of the buzzing near the transformers appears to come from C201, a 1kV 10nF Y5U ceramic part. I'm going to try swapping it out tomorrow and see if I can reduce the audible noise. While I'm at it, I'll check for ringing and slew rate.

After that, I'll add in a collet socket for IC8 and run some tests with the stock LF356 vs an OPA277PA. I couldn't find any axial 2uF polypropylene capacitors to replace C6, C7 and C8 but I do have some 1uF parts that I can solder in parallel on the underside of the board for testing. If they help, I'll order some proper replacements.

I just noticed that this is the same filter topology as the active filter module used in the Fluke 8505/6A. If all goes well here, I may try replacing the LM301 with OPA277PA in my 8506A's active filter after I finish fixing the current shunt module.

Motorola MTP1N950 MOSFET.pdf (184.55 kB - downloaded 24 times.)

onsemi FQP2N90 MOSFET.pdf (1296.12 kB - downloaded 23 times.)

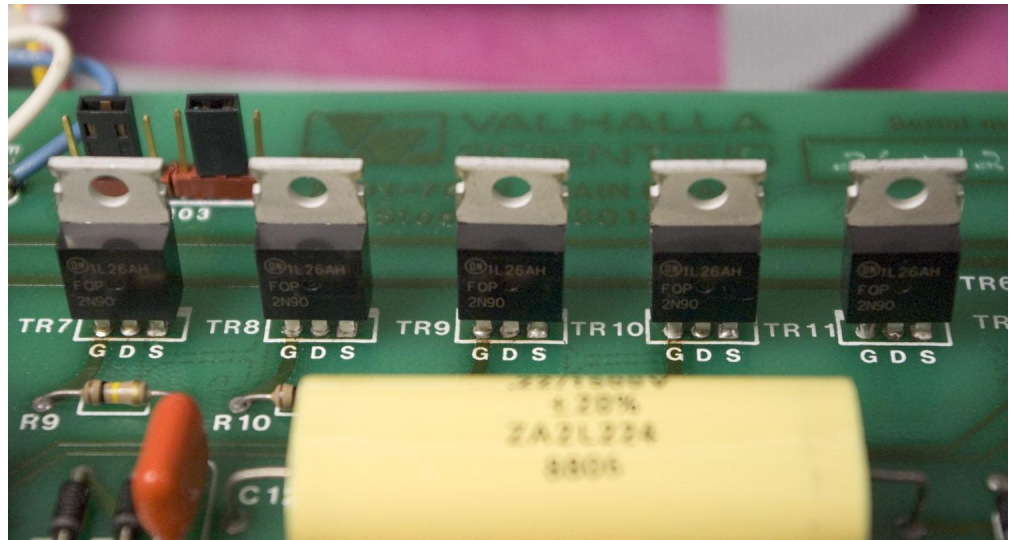

IMGP2344.jpg (158.67 kB, 1500x804 - viewed 70 times.)



IMGP2343.jpg (254.89 kB, 1500x785 - viewed 65 times.)

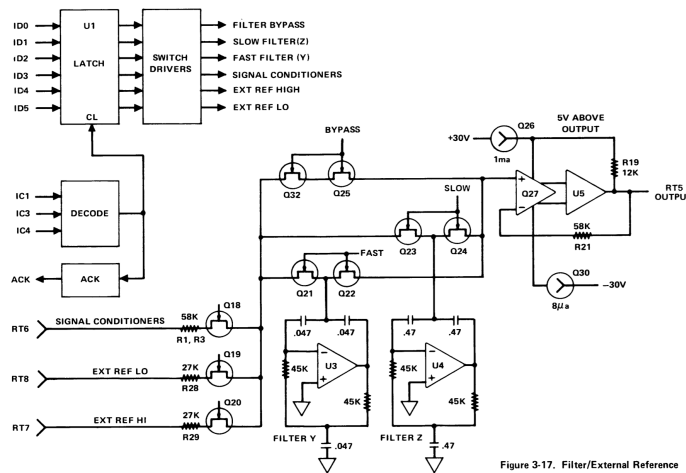

Figure 3-17. Filter/External Reference

3-63. Filter/External Reference

3-64. All inputs to the A/D Converter are routed through the Filter/External Reference module. Refer to Figure 3-17. External measurements are made by multiplexing the three filter module inputs to the A/D Converter. Q18, Q19, and Q20 switch the signal conditioner input, the external reference LO input, and the external reference HI input respectively. Data controlling the switches is latched into U1 upon termination of the address (IC1, 3, 4 high).

3-65. Three-pole, active Bessel filters (U3 and U4) have different setting times and cut-off points. Either filter may be selected from the front input panel for application to the signal conditioner input. Bypass is automatically selected for external reference inputs and may be selected for signal conditioner inputs. The combination of Q32, Q25, Q23, Q24, or Q21, Q22 is turned on to select a filter mode.

3-66. A dual, super-beta transistor in a differential configuration (Q27) drives U5. A current source (Q26) and sink (Q30) bias Q27. Enough current is drawn through R19 by Q26 to bootstrap the input amplifier, Q27, 5V above the output. Gain of the amplifier is set at one by the combination of R21 and the input resistors. The external reference inputs have additional series resistors located on the Front/Rear Input Assembly.

Fluke_8505A_Active_Filter.png (695.13 kB, 2588x1259 - viewed 76 times.)

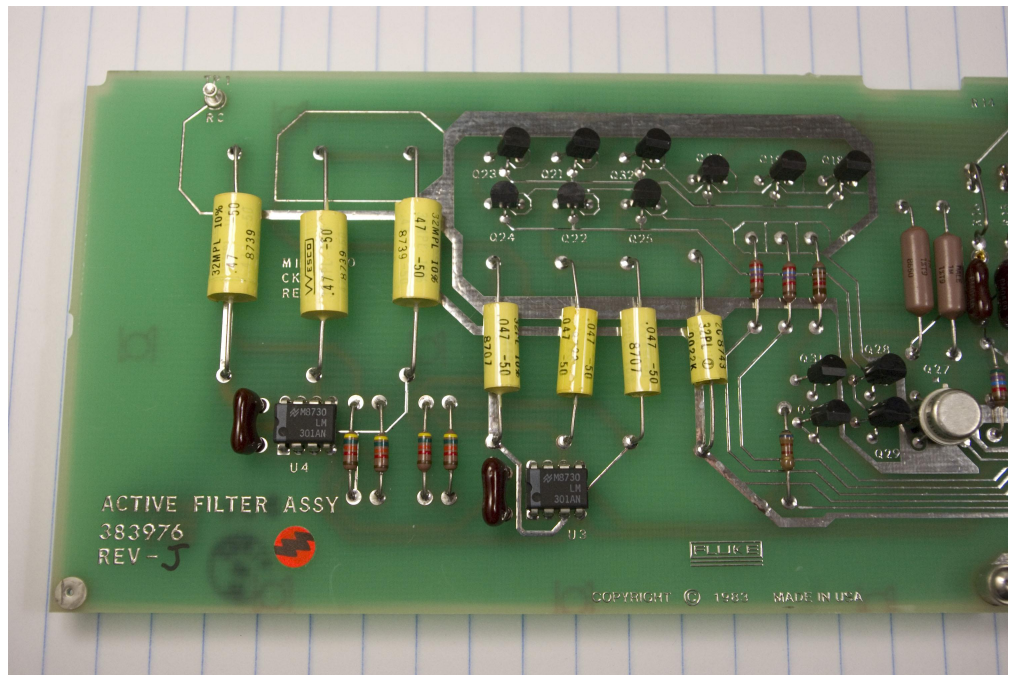

IMG2345.jpg (647.37 kB, 3000x2008 - viewed 85 times.)

[Report to moderator](#) [Logged](#)

The following users thanked this post: quarks, Le_Bassiste

Le_Bassiste

Regular Contributor



Posts: 242

Country:



Re: Valhalla 2701c schematics + firmware V3

[Say Thanks](#) [Reply](#) [Quote](#)

« **Reply #73 on:** August 13, 2021, 08:39:38 am »

Quote from: Electrole on August 08, 2021, 12:52:12 pm

Le_Bassiste: What was the frequency span of your measurements when you observed the improvement compared to LF356N?

unfortunately, i don't have such nifty gear as yours in my possession. i'm directly measuring the 10 V output of the 2701C in 2-wire mode with a Keithley 2002 set to 10 NPLC, no FILT, and let it collect 200 samples. when testing the OPA134, that set of samples had SDEV = 2.85 μ V. for comparison, an LTZ1000 measured in the same manner directly at the output (Dr. Frank's design) gives SDEV = 1.0 μ V. that's about as good as it gets with my setup. a FLUKE 343A comes out at SDEV = 1.5 μ V with above settings.

for wide-band noise measurement, i'm using the 2002 simply in ACRMS mode, 200 mV, no FILT. baseline of the 2002 is about 30 μ VRMS. the 2701C @ 10 VDC gives approx. 0.87 mVRMS after warm-up. it doesn't have Y-caps on the LO SENSE (yet), but i inserted 50 μ H toroidal inductors on each of the four front output wires, and a 470 pF cap across + and - output terminals. it wasn't equipped with any EMI measures when i got it, and had about 2 mVRMS before the modification. again, a 343A would read just about 50 μ V with the same settings.

« Last Edit: August 13, 2021, 08:46:42 am by Le_Bassiste »

[Report to moderator](#) [Logged](#)

An assertion ending with a question mark is a brain fart.

RaymondMack

Regular Contributor



Posts: 63

Country:



Re: Valhalla 2701c schematics + firmware V3

[Say Thanks](#) [Reply](#) [Quote](#)

« **Reply #74 on:** August 22, 2021, 01:17:06 am »

I got busy with work and a few other projects so I haven't had much time to work on the 2701C until last night. I replaced C201 with a more modern ceramic part and the audible buzzing associated with the old capacitor went away. I then held a short length of flexible plastic tubing up to my ear to safely "probe" around and find the remaining source of the buzzing, and it seems that aside from normal transformer hum on the small transformer, the switching transformer is the primary culprit. I may pour some epoxy in the large gap between the laminations and windings on each side of the transformer, since that is where my probing identified as the primary source of the buzzing. For some reason I thought the smaller transformer was louder than it is

I was going to probe the switcher but it turns out I didn't have any alkaline AA batteries and my NiMH batteries were slightly too fat to fit in my Yokogawa 701921 differential probe. So measurements / further adjustment of the switcher circuit will have to wait until I can remember to buy some more batteries.

As for other news, I did some simulation in Tina-TI and think that something like the OPA189 is actually a better replacement than the OPA277. Simulations of the OPA134 were disappointing, as it was worse than the LF356. It is interesting to note that the noise of the LF356 peaks at 5Hz with the default filter capacitors and can be tamed somewhat by lowering C8 to 0.5uF and increasing C6,7 to 2uF and C4 to 1uF. From the simulation results, I think I'll just increase C6,7 to 2uF and use an OPA189. I still want to do comparison testing with the OPA277 and LF356 for validation. It could be that the switching noise of the PSU swamps out the noise of the voltage reference circuit.

Step response testing shows that the settling time increases by about 72% when C6,7 = 2uF. With the OPA189 (or similar AZ opamp) C6,7 could be lowered somewhat and still see a measurable improvement in reference noise without excessively increasing the calibrator's settling time.

(Note: All macro models except for the LF356 were downloaded from TI. So these should be fairly representative of real noise performance in the given filter circuit. Color Key: Maroon = OPA134, Blue = OPA189, Gold = OPA277, Green = LF356.)

Also, I believe the LTC1052 is the better replacement for the ILC7650s. It either matches or beats the ILC7650s in most DC parameters and notably has both lower current noise and voltage noise. The current noise of the LTC1052 at 10Hz is 0.6 fA/sqrt(Hz) vs. 10 fA/sqrt(Hz) (or 0.01 pA/sqrt(Hz) as per the datasheet) and the voltage noise from DC to 10 Hz is 1.5uV versus 2uV. So it promises to be an all-around improvement over the ILC7650s. The TLC2652A has better long term stability and Vos temp co but has worse voltage noise and the current noise is only specified for 4 fA/sqrt(Hz) at 1kHz making me believe it is higher than even the ICL7650s at low frequencies.

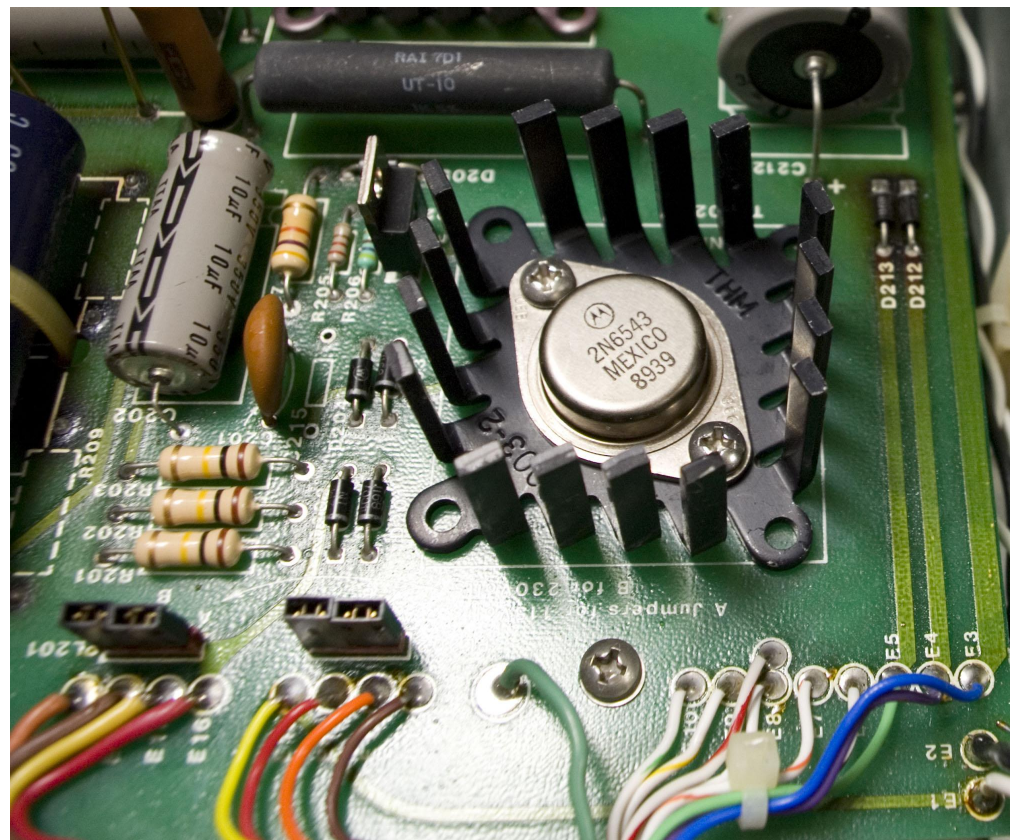

old_c201.jpg (549.16 kB, 2000x1672 - viewed 56 times.)

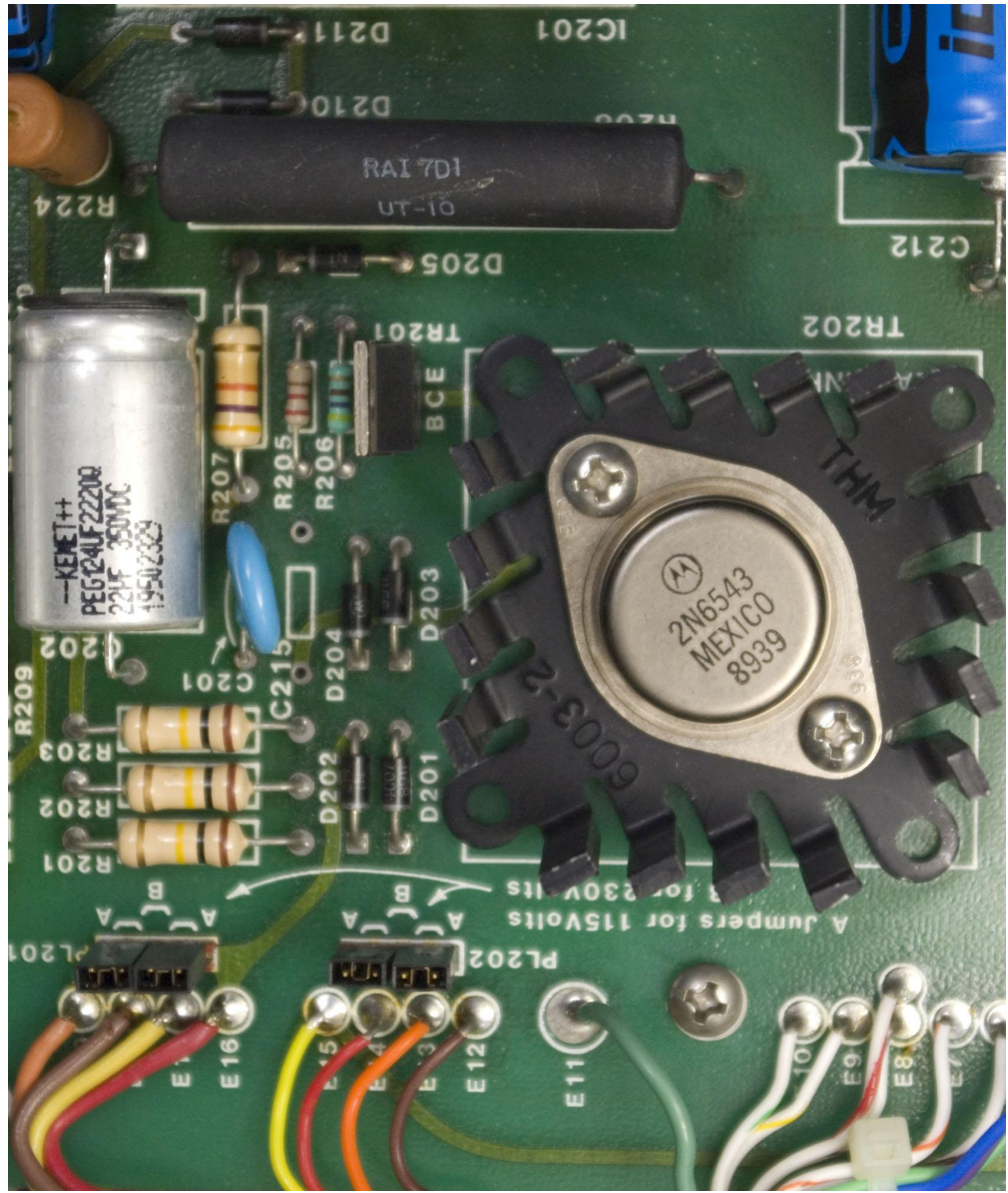

new_c201.jpg (458.54 kB, 1681x2000 - viewed 50 times.)

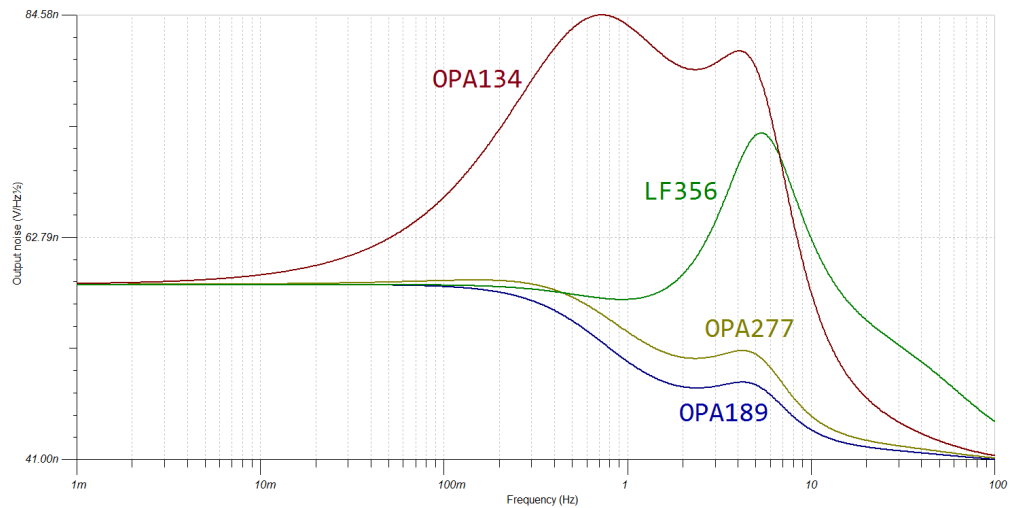

sim_opa189,134,277,lf356_stock_filter_noise.png (35.09 kB, 1472x765 - viewed 43 times.)

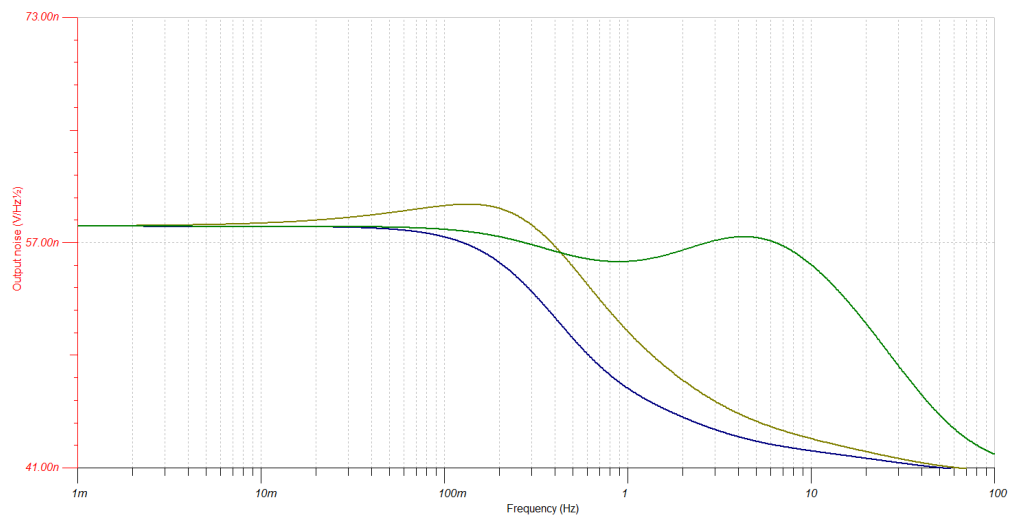
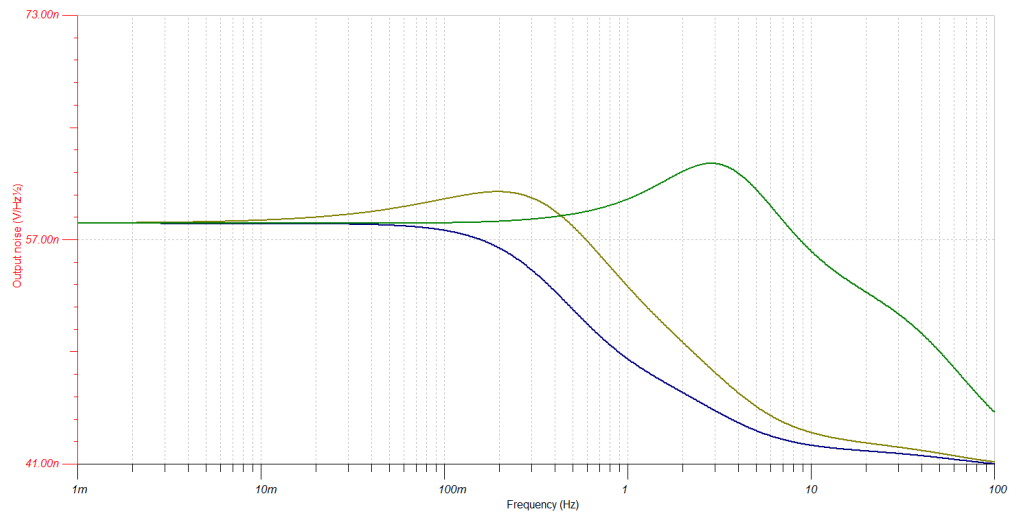
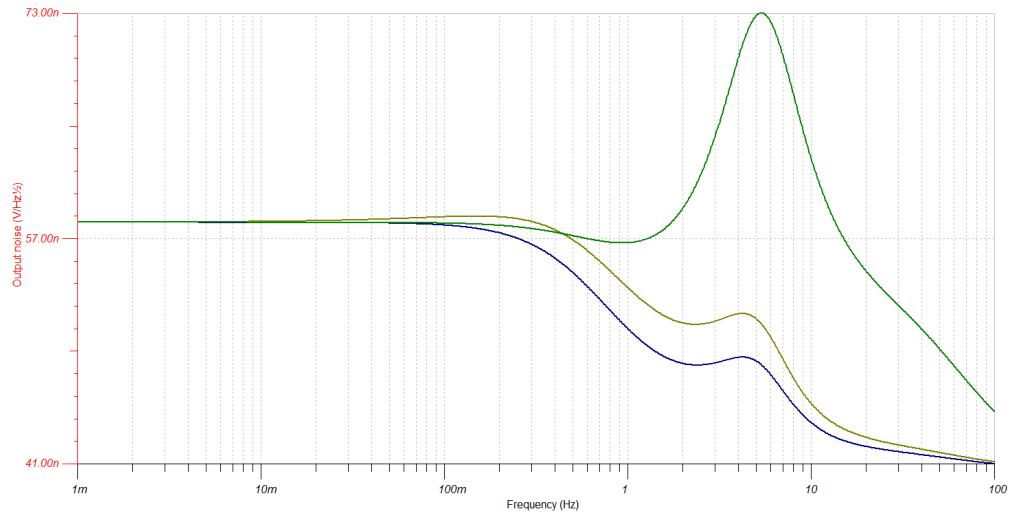

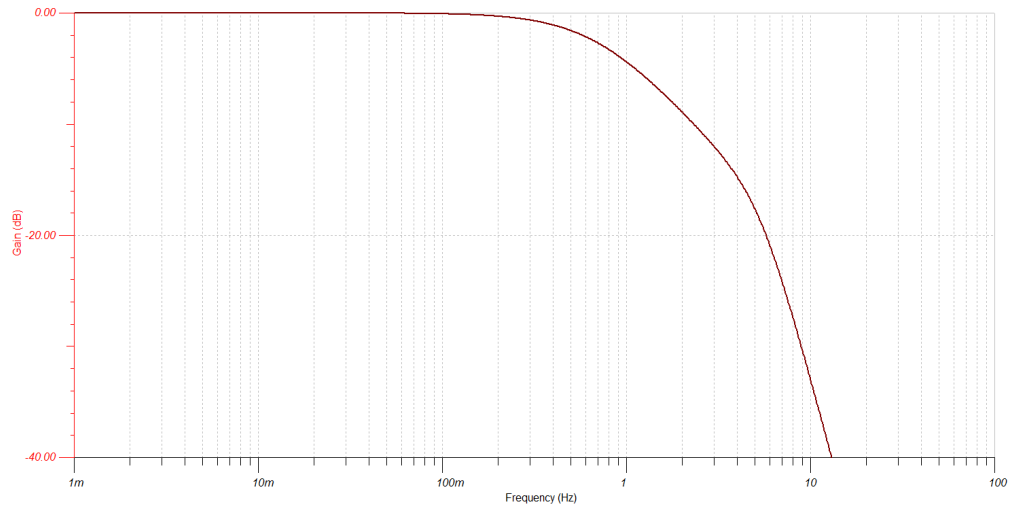

sim_opa189,134,277,lf356_stock_filter_ac_transfer.png (16.8 kB, 1472x765 - viewed 35 times.)

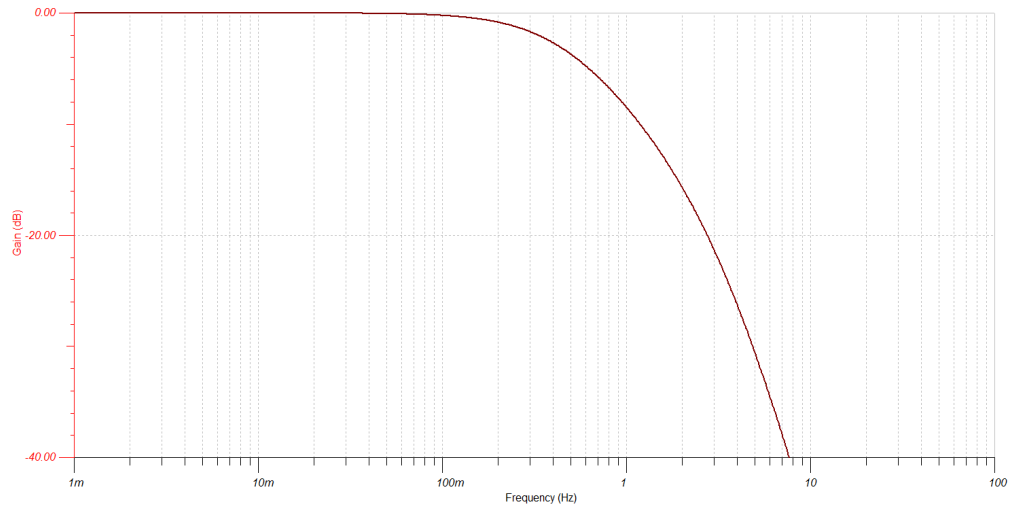

sim_opa189,277,lf356_c6,7=2uf_ac_transfer.png (16.93 kB, 1472x765 - viewed 28 times.)

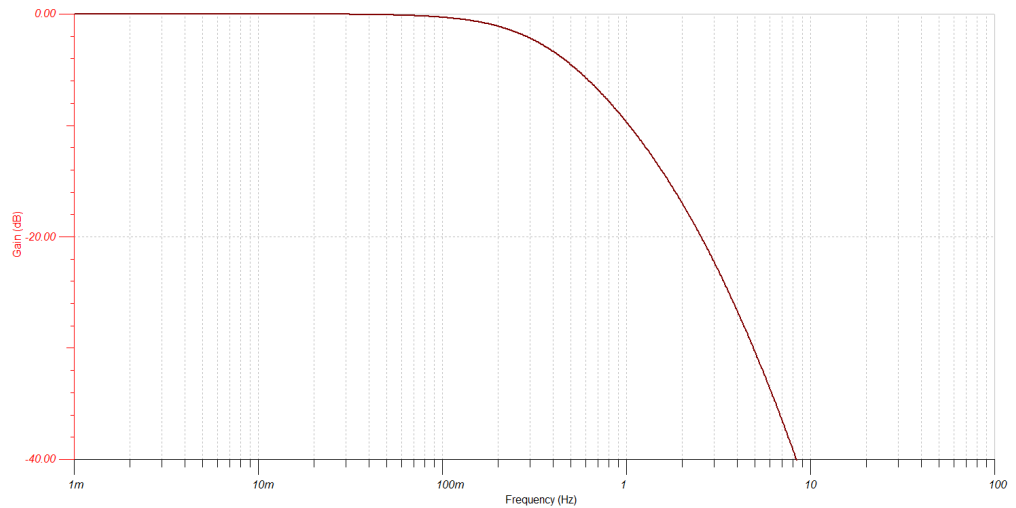

sim_opa189,277,lf356_c6,7=2uf,c8=0.5uf,c4=1uf_ac_transfer.png (17.08 kB, 1472x765 - viewed 34 times.)

2701C_Vref_filter_comparison_testing.zip (172.22 kB - downloaded 13 times.)

« Last Edit: August 23, 2021, 04:30:35 am by RaymondMack »

Report to moderator Logged

RaymondMack

Regular Contributor



Posts: 63

Country:

Re: Valhalla 2701c schematics + firmware V3

Say Thanks

Reply

Quote

« Reply #75 on: August 22, 2021, 08:09:53 am »

I played around with the Tina-TI simulations again and found a few mods that look interesting.



Blue: C6,7,8 = 1uF, C4 = 0.5uF (original filter, fastest settling time)
 Green: C6 = 1uF, C7= 2uF, C8 = 0.5uF, C4 = 1uF (lowest LF noise)
 Maroon: C6,7 = 2uF, C8 = 1uF, C4 = 0.5uF (sharpest attenuation)
 Gold: C6,7 = 2uF, C8 = 0.5uF, C4 = 1uF (slow, but decent LF noise and attenuation)

Both the LF356 and OPA189 have the lowest LF noise with the "Green" filter (swapping C8 and C4 values and increasing C7 to 2uF). This also has equal or better attenuation than the original filter but has about 67% longer settling time.

The "Maroon" filter increases C6,7 to 2uF and has slightly (72%) longer settling time and more LF noise but the sharpest attenuation.

The Gold filter has the longest settling time (twice the original filter) but sharper attenuation and nearly as good as noise performance as the "Green" filter.

The primary downfall of each filter mod is the increased settling time, but since the 2701Cs are so noisy I think they might be worth testing out.

Time to reach 99.999% of input
 Blue: 2.45s (original filter)
 Green: 4.08s, delta = 1.63s
 Maroon: 4.20s, delta = 1.75s
 Gold: 4.89s, delta = 2.44s

-----Attenuation-----				
Filter	-10dB	-20dB	-40dB	-80dB
Blue	2.32 Hz	5.74 Hz	13.03 Hz	54.97 Hz
Green	1.30 Hz	3.54 Hz	11.43 Hz	48.85 Hz
Maroon	1.19 Hz	2.75 Hz	7.68 Hz	36.14 Hz
Gold	1.03 Hz	2.54 Hz	8.38 Hz	40.19 Hz

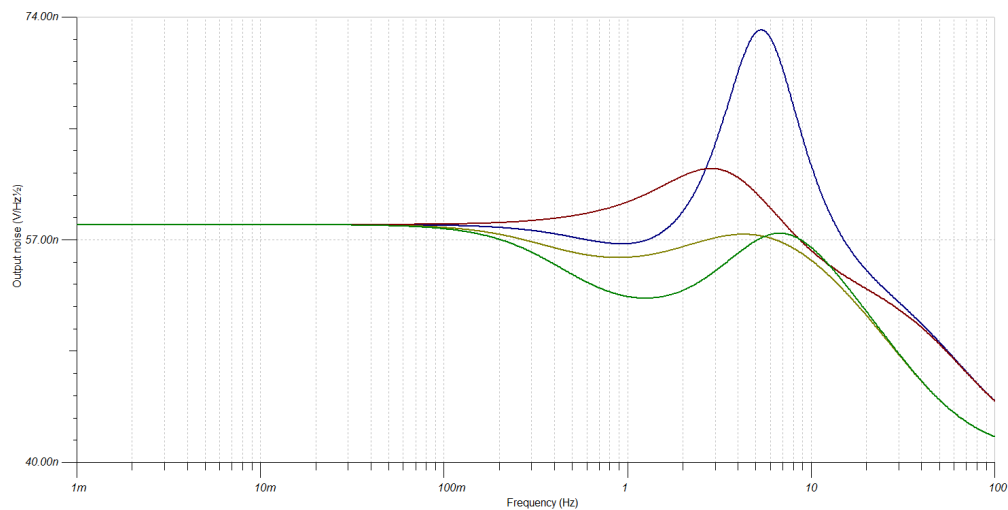

vref_lf356_filter_mod_noise.png (25.89 kB, 1472x765 - viewed 59 times.)

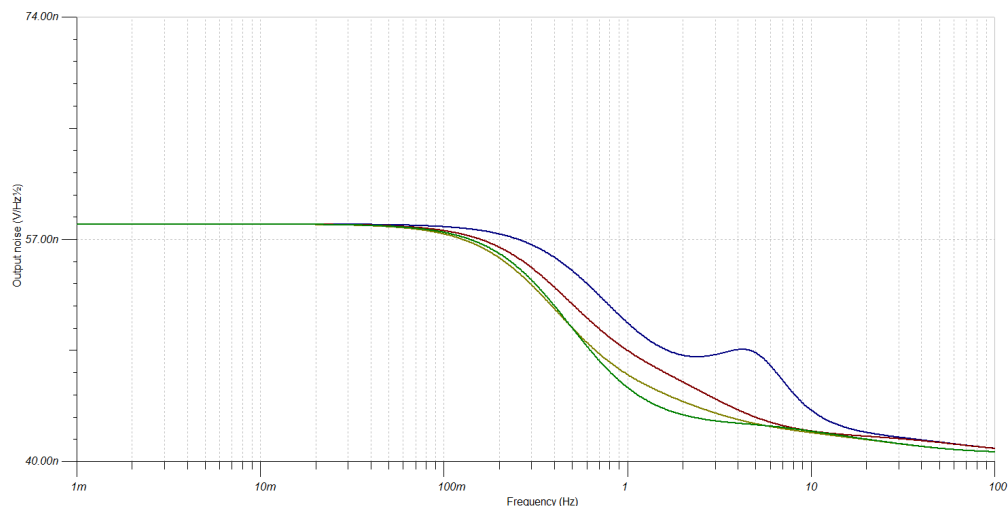

vref_opa189_filter_mod_noise.png (24.8 kB, 1472x765 - viewed 65 times.)

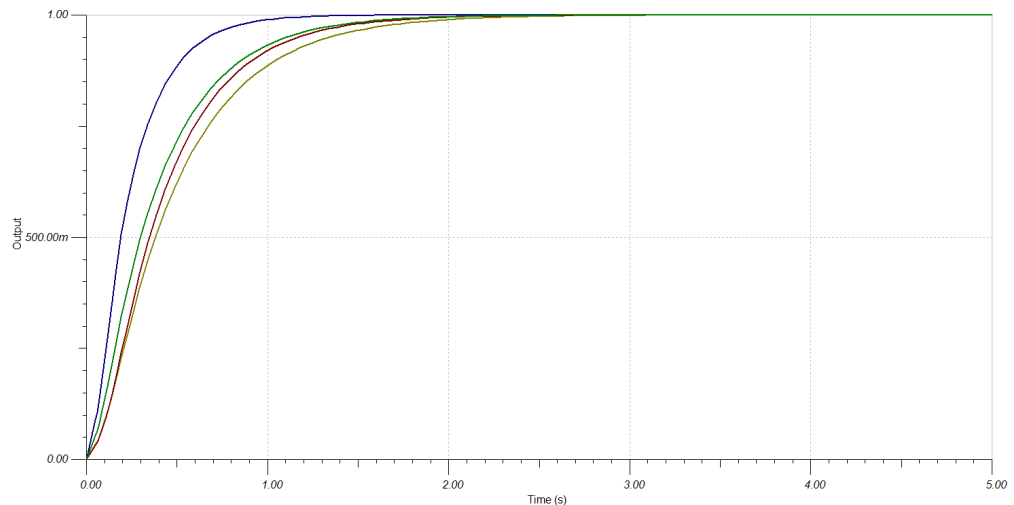

vref_opa189_filter_mod_settling_time.png (16.91 kB, 1472x765 - viewed 56 times.)

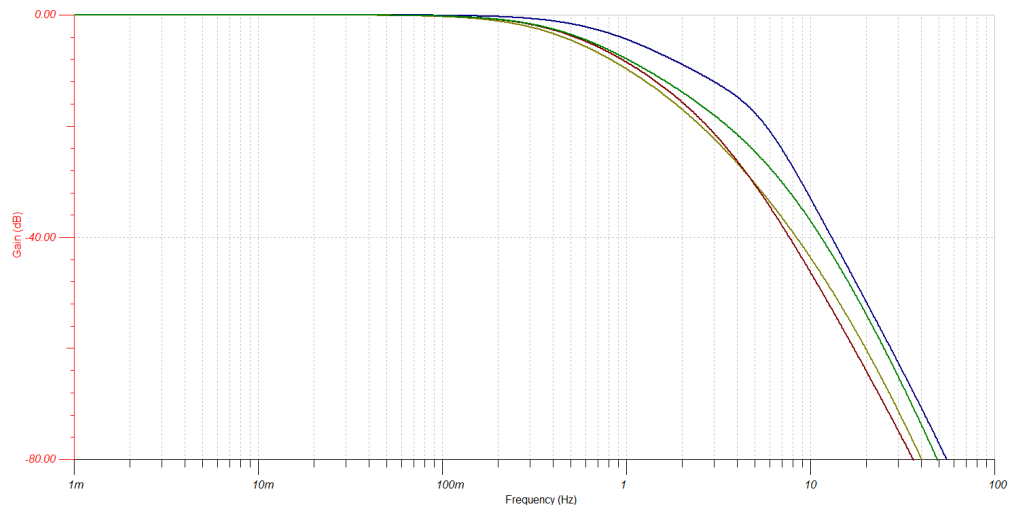

vref_opa189_filter_mod_ac_transfer.png (24.07 kB, 1472x765 - viewed 61 times.)

« Last Edit: August 22, 2021, 08:20:24 am by RaymondMack »

Report to moderator  Logged

 **Electrole**

Contributor

Posts: 41

Country: 



 **Re: Valhalla 2701c schematics + firmware V3**

Say Thanks Reply Quote

« Reply #76 on: August 22, 2021, 10:32:56 am »

The noise simulations are very interesting. They definitely show that the filter design is not just about suppressing PWM-noise, but one should also keep an eye on the noise generated by the filter itself. The simulations also suggest that despite the low current noise of the OPA134 the voltage noise kicks in below some 10 Hz. The LF356 seems to have more noise above 10 Hz which could explain the improvements observed when replacing the LF356 with the OPA134. The OPA189 is a cool op-amp, but it's not available in a leaded 8-pin package, so I don't know if it's worth the effort required to put it into use in the 2701C. Personally, I would just settle for the OPA277.

It's also interesting that Le_Bassiste's 2701C wasn't equipped with any EMI measures. In my unit there were already toroidal inductors installed for each of the 8 terminals. There are inductors shown in the Rev J mechanical drawing, so these are presumably added at one point. Unfortunately the assembly drawing reveals no details on these ferrites so I took out one and measured it: It reads close to 5.39 μH + 0.10 Ohm at 100 kHz, and 5.20 μH + 7.55 Ohm at 1 MHz. The 50 μH ferrites used by Le_Bassiste may be an even better choice. If others have a 2701C with no ferrites added, it will be a good idea to add some. I don't think the exact value is essential, but I would go for ferrite inductors that are lossy over a wide frequency range rather than inductors with a high Q. At one point I also considered adding common-mode inductors inside the 2701C but eventually I went for an external filter.

Regarding the buzzing noise from the high-voltage transformer: I have a bit of that too, and the level of noise depends on the voltage setting, which changes the current draw and the firing angle of the switching controller. I do not notice the noise, not even with the lid off, so the transformer in my unit may simply be more quiet.

It may be an idea to replace the ICL7650S with an LTC1052. Again, it will not do anything to the wideband noise issues, but if the stability and the low-frequency noise are improved, then why not. I would also consider replacing the socket with a better model, or solder IC5 directly into the board. I will not have time to modify the 2701C any further right now, so I will be looking forward to seeing results from a shoot-out between ICL7650S and LTC1052 :-)

Finally, a note on CE-marking and EMI/EMC: My 2701C does not have any CE-marking, neither does the unit shown on Valhalla's home page. The question is then how much consideration Valhalla gave EMC when designing the 2701C, and how much testing of EMC Valhalla has carried out. I suspect there could be a link between the noise issues we see and potential EMC issues. Without the CE-marking Valhalla is not even allowed to market or sell the 2701C inside the European Union, as far as I understand the legislation. Perhaps that's why there are no links to sales representatives abroad on the Valhalla home page?

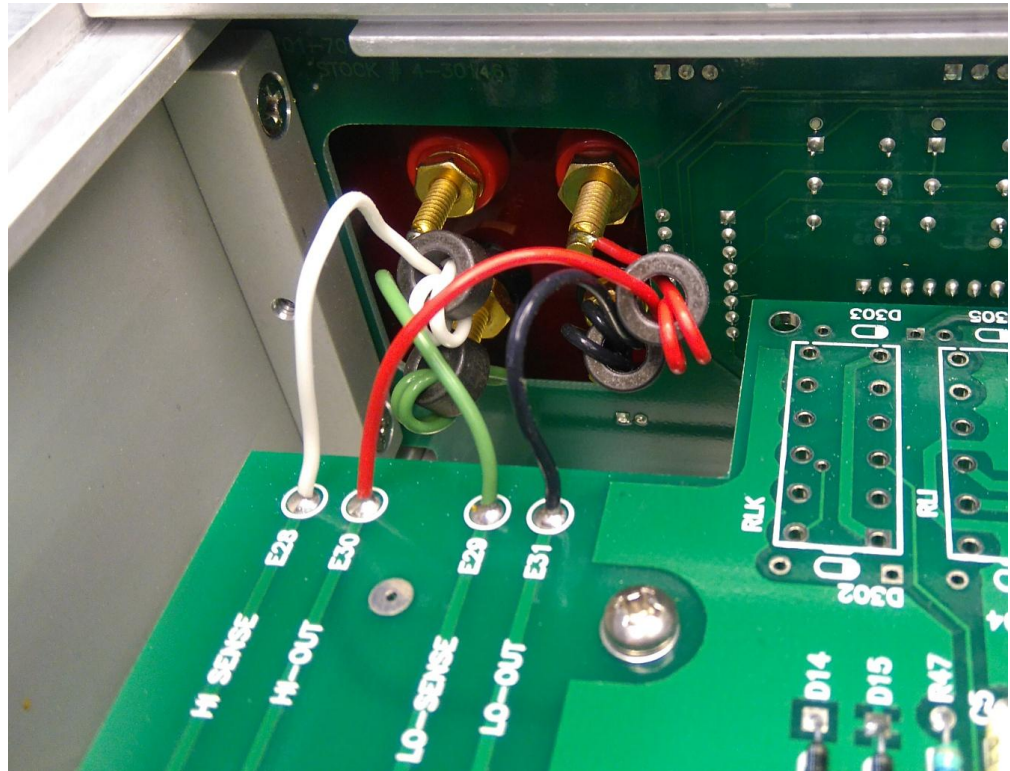

Valhalla 2701C with toroidal ferrites on front terminals.jpg (459.91 kB, 1337x1030 - viewed 124 times.)

[Report to moderator](#) [Logged](#)

The following users thanked this post: quarks

1audio
Regular Contributor

Posts: 241
Country:

Re: Valhalla 2701c schematics + firmware V3

[Say Thanks](#) [Reply](#) [Quote](#)

« **Reply #77 on:** August 23, 2021, 04:23:42 am »

RE EMC/EMI- I have a very early 2701 (pre-a). and it has almost no bypass caps on the digital circuits. Mine had chunks of drafting vellum as insulators for the brackets at each end of the PCB. They had broken down and were arcing at higher voltages. I get the feeling that this may have been someone's PHD or MSEE project that morphed into a business. There are aspects that even a junior engineer would have done (like the caps) that were not. It also has plastic top, bottom and front panels. Nevertheless it seems to work pretty well.

Maybe they were reluctant to make too many changes which would have needed a lot of verification on performance.

[Report to moderator](#) [Logged](#)

quarks
Frequent Contributor

Re: Valhalla 2701c schematics + firmware V3

[Say Thanks](#) [Reply](#) [Quote](#)

« **Reply #78 on:** December 21, 2021, 09:59:05 am »





today I inspected my 2701C and found an annoying clicking noise most likely I just did not notice it before, but now I used a Stethoscope to verify where it is coming from

9

Posts: 872
Country: 
  

 1audio

Regular Contributor

Posts: 241
Country: 
  

 lowimpedance

Super Contributor



Posts: 1200
Country: 
Watts in an ohm?
 

Transformer TR201 and (as mentioned above) C201 are the source of the clicking replacement of C201 with a new Ceramic cap did not help, therefore I tried a MKP and now the noise of the cap is gone

only TR201 noise is still there, but it is very low compared to the before C201 ceramic cap clicking

Report to moderator   Logged

 Re: Valhalla 2701c schematics + firmware V3

« Reply #79 on: December 21, 2021, 03:48:16 pm »

Say Thanks Reply Quote

many large value ceramic caps make noise and change value with voltage. Same stuff inside are used as tweeters (Motorola Piezo) as well.

Report to moderator   Logged

 Re: Valhalla 2701c schematics + firmware V3

« Reply #80 on: February 25, 2022, 02:54:02 am »

Say Thanks Reply Quote

Quote from: RaymondMack on July 27, 2021, 07:37:37 am

I noticed that you started the thread in 2017! What do you think is wrong with your calibrator?

Spurred on by the very helpful replies here gave me the confidence to tackle this repair. Thanks for your shared experiences.

So my earlier thought that the HV MOSFET string was the problem as it was getting very hot turned out to be only a symptom of the actual failures. After replacing the entire HV transistor set TR6-TR12 with no fix, and observing that 1600 V was being applied across the HV transistor string it was no wonder they were getting hot. Also RLJ was cycling on and off every 1 to 2 seconds.

So the next tests were static measurements for any obvious component shorts wrong values etc from the HV rectifier output to the output control CCT. Nothing stood out as failed. Replacing the chopper IC5 made no difference. The reference cct measured okay too. Moved onto IC1 and opto IC2. replaced both with again no fix 🙄.

Okay obviously being a bit slow on the up take! , I then checked the HV switcher transistors TR201 and TR202 out of CCT as trying to decipher the readings otherwise was not conclusive. Upshot was TR202 had gone rather leaky C-E (not a full short or open CCT any terminal), and TR201 seemed okay. All other components in that CCT measured okay. Note that TR201 was an MJE13005 with higher VCE ratings, not the 2N6499 specified in the parts list. Finding the 2N6543 used for TR202 proved fruitless from the usual trusted suppliers, so not wanting to take the risk on ebay etc I looked at suitable sub's. There are a number of possibles including the BUX80 which I had one to hand so I tried that plus a new MJE13005 just in case!

Result was no fix 🙄, still overheating TR7-12 with maxed out HV across them and RLJ slow cycling on off. Measuring the output of IC1 showed no switching just ~ -13V, loop not functioning at all. I removed IC 2 and put a shorting link across pins 4 and 5 to simulate the opto transistor turned full on. The theory was it would turn TR201 and 202 completely off. The result was such that the HV output dropped from max ~1600V down to just under 100V with no clicking from RLJ or heat issues and now the output could be controlled from 0 up to 80 odd volts 🙄. Proving the chopper control was working.

All components around IC1 tested okay so why no feedback ?? I tested on the bench the opto coupler with the conditions found in the 2701 and found the opto was not turning on properly !, so upping the LED current a bit improved the switching and was still within the LF353 specs so I reduced R23 to 2K and used a CNY117-3 opto which has better CTR than the 4N25. The result was a now functioning HV switcher with a steady 230V across the HV transistor string and output controllable from 0 up to 1200 V.

In the end the culprit was TR202 which had failed for whatever reason and the hot output transistors and hot bleeder resistors R209-216 as well as RLJ cycling on/off were a result of the HV transformer being fully on. The one thing that puzzles is the fact the opto feedback required such a change to the LED drive current to get the switcher working again. Must be a marginal design to start with. Also not what you would call fail safe with MAX HV output 🙄.

I am in the process of measuring the HV switcher with a MicSig HV diff probe and will post some pictures showing various conditions of TR202 C-E wave forms with no snubber then with the original snubber, and some further experiments with added snubbers across the rectifiers and HV transformer PRI. Inspiration to tinker taken from Electrol's write up (see link he posted earlier). I will also do some of the suggested mods and use my HP3400 to measure the output RMS noise. Will update thread as these things are done.

« Last Edit: February 26, 2022, 12:28:30 am by lowimpedance »

Report to moderator  Logged

The odd multimeter or 2 or 3 or 4...or.....can't remember !.

Pages: 1 2 3 4 [All] **Go Up**

REPLY

NOTIFY

MARK UNREAD

SEND THIS TOPIC

PRINT

SEARCH

« previous next »

Share me



EEVblog Electronics Community Forum » Electronics » Metrology » Valhalla 2701c schematics + firmware V3

LINK TO CALENDAR

Jump to: => Metrology

 Quick Reply

PCB PARTNER **\$1 SHIPPING WITH FREE PCB**
 GET 1-2 OR 4 LAYER PCBs FOR ONLY \$1
COUNTRY AND DIMENSION LIMITATIONS MAY APPLY **GET YOUR QUOTE**

BUDGET MULTIMETERS !!
 ANENG, UNI-T and more...

[EEVblog Main Site](#)

[EEVblog on Youtube](#)

[EEVblog on Twitter](#)

[EEVblog on Facebook](#)

[EEVblog on Library](#)

SMF 2.0.18 | SMF © 2021, Simple Machines

Simple Audio Video Embedder

SMFAds for Free Forums

XHTML RSS Mobile WAP2