

Valhalla Instrument Catalog 1989-1990

Building New Standards
for Technology

Introduction

Valhalla Scientific is a technology leading manufacturer of precision electronic measurement and calibration instrumentation and automated systems. Since 1971, when we introduced our first 3½ multi-meter-frequency counter, Valhalla has been dedicated to creating innovative, affordable solutions to tough measurement problems. *Today, Valhalla Scientific is designing and building new standards for technology.*

Our new 2730GS Calibrator combines precision voltage generation and extremely accurate measurement capability in one instrument to provide performance rivaling and bettering that of many primary standards laboratories.

We manufacture electronic test equipment; but we sell test and measurement solutions. We're proud of the outstanding reputation for quality and reliability our solutions have achieved.

We want you to be more than satisfied with Valhalla, whether you're working with our products or our people.

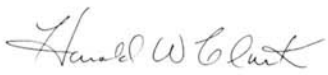
Harold W. Clark
Chief Executive Officer

Valhalla instruments help engineers design better, more power-efficient products.



Performance that meets the test: In-house ATE board testing is conducted on all Valhalla Digital Power Analyzers.



Guaranteed Delivery: Stock to 4 weeks on all standard models.



Valhalla manufacturing includes calibration and verification of all wattmeter V-A-W measurement accuracies. Power Factor response is tested on a Valhalla 3 Phase 100 Amp per phase Automatic Calibration System.



Certificate of Calibration: Putting the Valhalla Measure of Excellence on every product we sell.

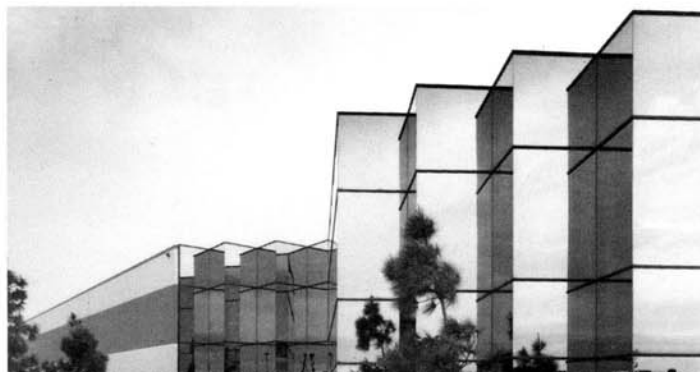

Table of Contents

Indexes and New Products	1
Systems Capability	2
Calibrators, Standards and Systems	3
Digital Ohmmeters	4
Digital Wattmeters/Power Analyzers	5
Digital Comparators & Data Conditioners	6
Sales Offices & Ordering Information	7

Model Number Index

1

Accessories

"286CBT"	16
"286RC"	16
"A"	53, 58
"AC"	53, 58
"AC-1", "AC-2"	69, 70
"AL"	47-51, 58
"BAT"	31
"BBL"	31, 34, 38, 39, 41, 43-46
"BCD"	49-50, 58
"BCD-MX"	55
"CC4"	53, 55, 58
"CPT"	41

Instruments

1248 Digital Comparator	69
2009 Buffer Amplifier	42
2100 Digital Power Analyzer	62
2101 Digital Power Analyzer	62
2190D Data Conditioner	68
2191D BCD Output Conditioner	68
2300 3 ϕ Digital Power Analyzer	65
2300L 3 ϕ Digital Power Analyzer	65
2500 Current Calibrator	43
2500EN Current Calibrator	44
2500EP Current Calibrator	44
2555A Current Calibrator	45

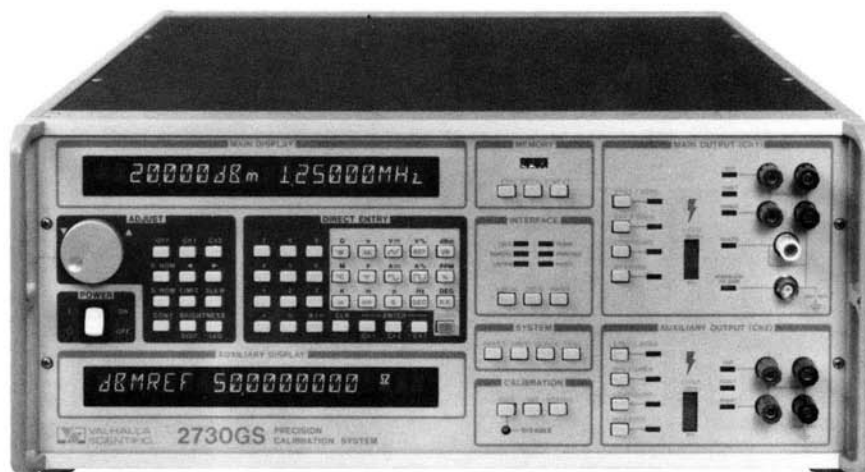

"CU"	47-51, 58, 64
"DMX"	64
"EXR-1, 10"	30
"GP-1", "GP-2"	31, 36, 38, 39, 41
"HP-CAL"	17
"HC", "HMF"	45-46
"I-150", "I-1000"	64, 67
"I01", "I0X"	67
"IT-2"	36
"JAWS"	49-58
"K", "KCS", "KK"	47-58
"KL", "KC"	49-58
"LTB"	29
"MP-1, -2, -4, -5"	49-58
"PC-CAL"	17
"R1"	22, 43, 50-52, 54
"R2"	44
"R3"	45
"R4"	53, 55, 64
"R7"	29
"RH-2"	29
"RP20"	31
"R01"	36
"RX3"	33, 36, 41, 46, 49, 57
"RX7"	31, 38, 39, 67
"SL-48"	29, 31
"TX-34"	33
"TL-1"	41
"TL-2"	38, 39
"TL-3"	36
"TL-5"	67
"TL-488"	49
"VS488"	16
"X21"	64

2575A AC-DC Current Shunt	46
2701C DC Voltage Standard	35
2703 AC Voltage Standard	37
2704A Reference Divider	35
2705 AC Voltage/Phase System	39
2720GS DC Voltage System	30
2724A Resistance Standard	40
2730GS Multi-Function Calibrator	23
2734A Direct Voltage Reference Standard	32
2790B Systems Interface Console	22
4014 Digital Ohmmeter	54
4020 Digital Ohmmeter	43
4100ATC Digital Ohmmeter	50
4150ATC Digital Ohmmeter	51
4165 Digital Ohmmeter	52
4300B Digital Ohmmeter	49
4314A Igniter Tester	55
4314B Igniter Tester	55
4650 Igniter Tester	56
27000 Automatic Cal System	11
27010 Meter Station	13
27020 Scopes	14
27030 Meter & Scope Station	15
MCC1 Mobile Calibration Cabinet	12
MCU1 Mobile Enclosure Upgrade	12

2

Functional Index

Meters, Digital

Ammeters	62-67
Micro-Ohmmeters	49-51
Milli-Ohmmeters	49-57
Ohmmeters	59-67
V-A-W Meters	59-67
Wattmeters	59-67
Meter Calibration System	11-29
Meter Calibrators	11-46
Multi Channel Power Analyzers	65-67
Ohmmeters, Digital	47-58
Power Analyzers, Digital	59-67

Probes

Clamp-On Current	64, 67
Four-Wire Micro-Probes	58
Four-Wire Mini-Probes	58
Precision AC Calibrator	23-29, 37-39
Precision Buffer Amplifier	42
Precision DC Calibrator	23-36
Precision Resistance Standard	40-41
Process Controller	69-70
Reference Divider	25
Resistance Standard	40-41
Shunt, Wideband AC-DC	46
System, Automatic Calibration	11-29
System Controller	
Systems Interface Console	22

Testers

Contact Resistance	52
Igniter	55-57
Transformer Core Loss	59-67
Winding Resistance	49-54
Transconductance Amplifiers	42-45
True RMS Ammeters	59-67
True RMS Voltmeters	59-67
Voltage Calibrator, AC	23-29, 37-39
Voltage Calibrator, DC	30-36
Voltage Calibrator System, Automatic	11-36

Software

PC CAL	17-20
HP CAL	17-20
Driver Modules	21
Procedures	21
PC WATTS	66

Wattmeter, Digital

Benchtop, Single Phase Systems	63-64
Three Phase	65-67
Wideband AC-DC	59-61
"PC WATTS" Software	66
AC-DC Current Calibrators	23-24, 42, 45
AC-DC Current Shunt	46
AC Voltage Calibrator	23-24, 37-39
Wideband AC Voltage	23-29

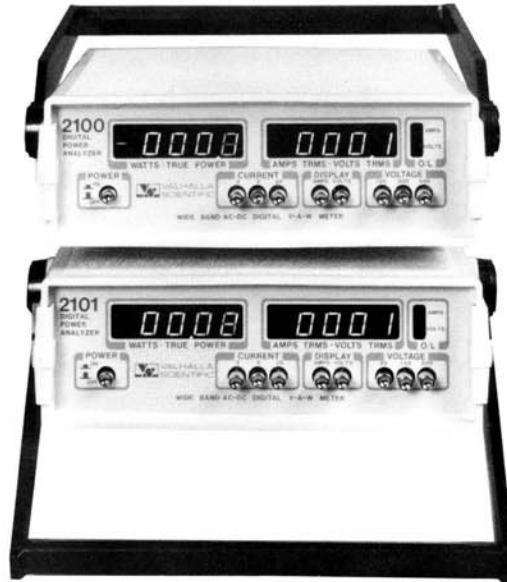

Accessories

Digital Ohmmeter	58
Digital Wattmeter	63
(Other accessories listed with each product)	

Amplifiers

Buffer	42
Chopper Stabilized	46
Kilovolt	19, 25, 2
Transconductance	42-45
Ammeters	59-67
Automatic Calibration System	11-29
Automatic Temperature Compensators	47-48

Automated Systems

2730 Multi-Function Calibrator	23-29
27000 ACS	11-12
Meter Station	13-14
Meter & Scope Station	14-15
Scope Station	15
DC Voltage System	30-31
Controllers	16

Calibrators & Standards

AC-DC Current	23-29, 42-45
AC Voltage	23-29, 37-39
Automated Calibration System	11-29
DC Voltage	30-36
Resistance 6½ Digit	40-41
Comparator, Dual Limit	69-70
Controller, IEEE-488 Systems	16
Controller, Digital	69-70
Multi-Function Calibrator	23-29
Phase Standard	23-29, 39
WATTS, Power Factor, VA	23-29



Current

AC-DC Calibrators	23-29, 4-45
AC-DC Shunt	46
C.T.s, Clamp-On	64, 67
Meters	59-67
D to A Converter, Isolated	68
DC Voltage Standard, Programmable	23-31

Digital

Ammeters	59-67
Comparator	69-70
Contact Resistance Tester	52
Igniter Tester	55-57
Micro-Ohmmeters	49-51
Ohmmeters	47-58
Power Analyzers	59-67
V-A-W Meters	59-67
Wattmeters	59-67

Dividers

Reference	35
IEEE-488 Information	16
Igniter Tester	55-57
Kelvin Lead Compensation	47-48

New Products

There are many new, exciting, Valhalla products that we are proud to introduce which were developed with a host of user friendly features and designed with a variety of powerful time-saving capabilities. Besides the new Valhalla instrumentation featured on these two pages, Valhalla's automated system engineers are proud to introduce our IBM-PC compatible calibration software 'PC-CAL'. Valhalla's 'PC-CAL'® software is compatible with any of our GPIB based calibration standards.

Many new product concepts come from our primary source of new product ideas—you 'the customer'. If you are interested in any of our products or would like to discuss a special application or modification, Valhalla's sales staff and field sales engineers are more than willing to discuss your requirements.



2730GS Precision Multi-Function Calibrator

Valhalla's new 2730GS Precision Multi-Function Calibrator is the talk of the industry. This remarkable offering to the standard's world provides the best accuracy and flexibility of any programmable calibration system anywhere. In addition to the U.S. Navy choosing the 2730GS as the MECCA II Multi-Function Calibrator, it was the calibrator of choice for the U.S. Army's TMDE workstation and the U.S. Airforce's PMEL labs worldwide.

The standard 2730GS features 8½ digit direct voltage output, AC voltage capability to 1.25 MHz, high level (12 Amps) AC-DC current capability and resistance standard capability from 1Ω to 100MΩ.

One of the truly unique features of the 2730GS is its modular "One Calibrator-on-a-Card" design approach. Optional flexibility choices include 7½ digit high accuracy AC thermal measurement, Phase Capability (0.008° accuracy), Watts Calibration, 8½ digit DC voltage measurement capability, choice of wideband outputs to 20 MHz, 30 MHz or 50 MHz. For more information on this performance packed calibration system, turn to page 23 in Section 2 of this catalog.

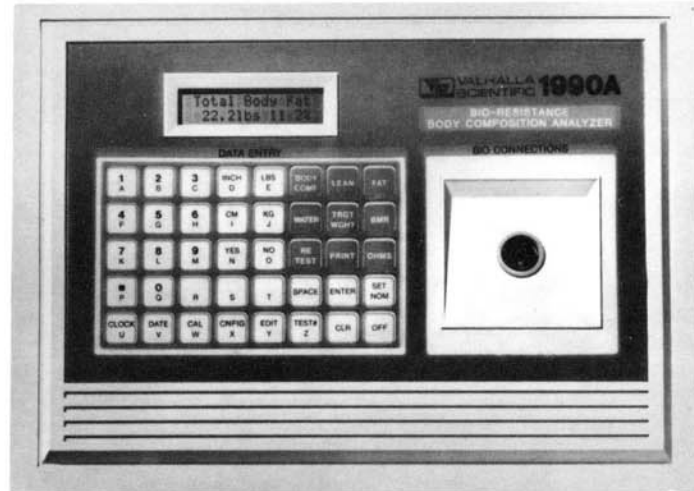

1990B Body Composition Analyzer

The 1990B is the latest addition to Valhalla Scientific's Medical Instrument Division. This compact unit eliminates the need to climb into a "dunk tank" in order to accurately measure body fat. The technology behind the instrument is based on a 4-terminal 50KHz AC resistance measurement and substantiated by a nationwide, eight-university study. The multi-page health and body composition report generated by the 1990B is the heart of a comprehensive wellness center. Contact Valhalla Health/Medical Group for complete information.

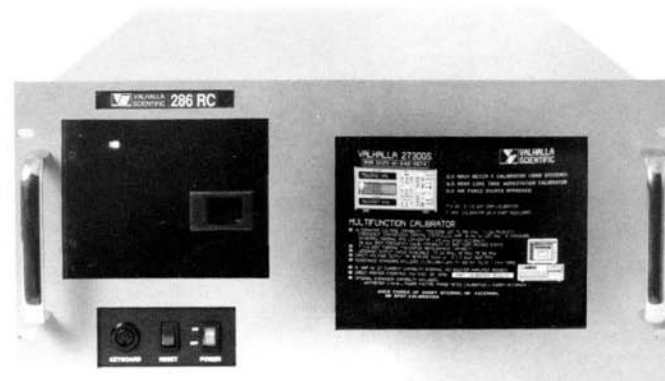

286RC® Rackmount GPIB Controller

For rackmount computer/controller applications, Valhalla's new 286RC® fits your rack and your budget too. This IBM PC/AT compatible is a 10 MHz zero wait-state 80286 based CPU with self-contained 9" monitor, 1 megabyte on-board RAM, 3½" floppy, 20Mbyte hard disk, VS-488 GPIB card and detachable 101 key keyboard. Designed and built for the U.S. Army's Mobile Calibration Van program, this 8¾" tall controller is practically bullet-proof. Detailed information is provided on page 19.

New Products



2701C Direct Voltage/Current Standard

The Valhalla 2701 era just keeps getting better. The new 2701C is a precision microprocessor based enhancement of our original 2701 introduced back in 1978. The newer "C" version is feature-packed with such capabilities as "covers on" calibration, GPIB programmability of direct voltage to 1200VDC or direct current to 120mA, 8 ppm 30 day basic accuracy, 2/4 wire remote sensing at a keypress and more. See p. 35.



2734A Direct Voltage Reference

The new 2734A is a remarkably stable and quiet primary Direct Voltage Reference Standard. When used as a transfer standard any one of the four individual ultra-zener based references may be used for better than 0.4 ppm 30 day accuracy. The 2734A is ideal for use as a support standard for use with the Valhalla 2730GS calibrator or the Valhalla 2720GS Ultra-Precision DC system.



4650A GPIB Igniter Tester

At last, Valhalla has combined the safety of our battery powered portable igniter testers with the convenience of IEEE-488 programmability. Our new 4650A utilizes custom ASIC and PAL technology to provide ultra-safe 5½ digit (249,999 count) resistance measurement to squibs, igniters, explosive bolts and other sensitive devices. In addition to dual fail-safe current limiting, the 4650A also features active voltage clamping, internal fail-safe verification routines, "covers-on" calibration, true ohms, offset compensation and a basic accuracy of 0.008%. The 4650A has been tested and safety approved by the U.S. Navy.



2790B Universal Calibration Interface Console

Automate GPIB based Calibration Standards you already own. The Valhalla 2790B allows the user to accomplish "closed-loop" or pushbutton calibration on a UUT plugged into the 2790B's front terminals without having to stop for an operator to switch test leads from one source to another. As part of any automated system application (ie., DMM calibration), the 2790B Universal Calibration Interface console can be integrated with any calibration measurement or source standards (GPIB based) and is software compatible with Valhalla's new HP-CAL™ and PC-CAL™ Automatic Calibration System Software Driver Modules. See page 22 for complete information.

Product Quality Assurance

Valhalla Scientific is absolutely committed to designing, manufacturing, testing and delivering reliable electronic instrumentation. Automating Valhalla's production printed circuit board test environment for subassembly and component level diagnostic analysis with in-house ATE is making Valhalla products more reliable than ever.

Our growing reputation as a quality conscience manufacturer is a result of double and triple the product MTBF (mean time between failure) since the use of **ATE level board testing**. Marginal, wrong value or faulty components have been virtually eliminated since Valhalla invested in the automated board test. Plugging working tested boards into a working tested chassis provides a functional product ready for Valhalla's **temperature elevated burn-in room**.



Infant component mortality has been significantly prevented at the customer level since Valhalla has instituted 100% burn-in on all Valhalla instrumentation at elevated temperatures.

Our commitment to quality assurance extends from full in-house static control of receiving, inspection, production and calibration departments to internal and external quality control audits of our production process, final inspection of finished goods as well as auditing our qualified suppliers.

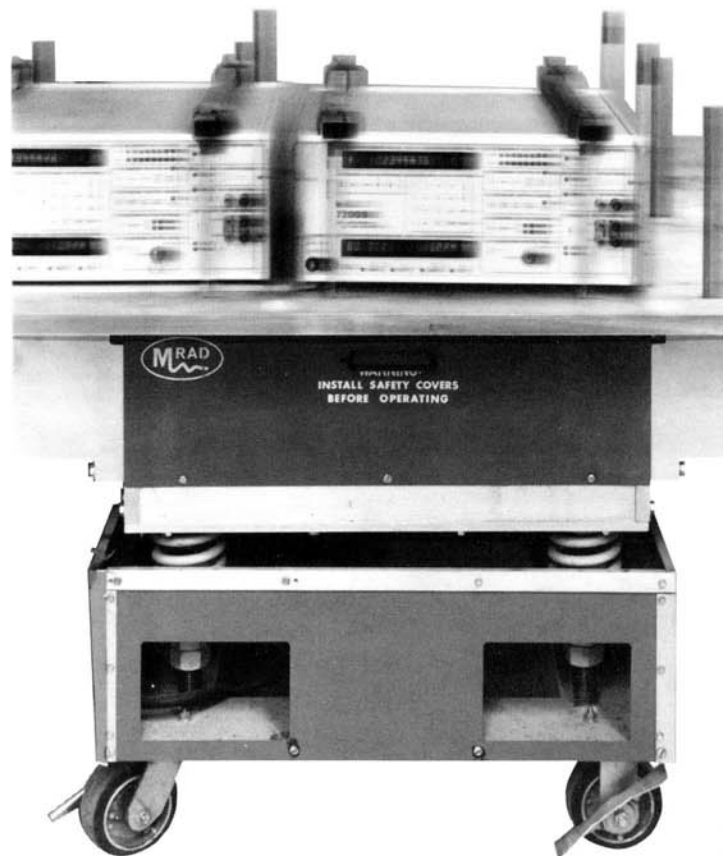

Vibration, Humidity and Heat Stress

Designing reliable instrumentation starts with a product concept whose critical electronic circuitry (i.e., phase response, distortion) is optimized with 'SPICE' computerized circuit simulation analysis. **Vibration analysis** (shake room) **at elevated temperatures** is later performed during the pre-production and early production cycle process on all new Valhalla electronic instrumentation. Should a mechanical or electrical failure take place during the 'vibration testing stage', the collected data is used for projected MTBF reports (i.e., required for 2730GS military contracts) and maintainability test reports by Valhalla's reliability engineers. Product reliability is further enhanced by testing all new products at **elevated humidity levels** (90-95% RH) and elevated temperature levels (45°C).

Automated Systems Capabilities

Valhalla's Contribution to Metrology

Physical evidence of this philosophy is present in every calibrator manufactured by Valhalla. To achieve these goals of cost, performance and reliability enhancement, we have resorted to innovative means to attain success. Our first contribution was in the origination of the precision AC-DC current amplifier for calibration purposes. Valhalla pioneered and holds the basic patent in transconductance amplifier technology (US Patent No. 4,091,333). The cost/performance advantage came by utilizing the existing precision AC and DC laboratory voltage standards as a reference for the generation of precision current. Thus, the technique greatly reduces cost through the elimination of reference redundancy. To this day, the Valhalla 2555A 100 Ampere AC-DC current calibrator is recognized as the leader in transconductance technology. The newer Valhalla 2730GS calibrator has a surface mount technology based 12 ampere transconductance amplifier board.

In 1978, to advance state-of-the-art in Direct Voltage Calibration, Valhalla developed the **pulse width modulated digital attenuator**. This crystal based, digital technology virtually eliminated attenuator drift, non-linearity and dependence on switch contact resistance associated with the traditional Kelvin-Varley approach. In addition, program interfacing has been greatly simplified through the implementation of the digital attenuator. Internal amplitude programming is accomplished at the logic to logic interface level without the introduction of any electromechanical relays. Again, improved performance at reduced cost is realized. With 8½ digit resolution and 3.5 ppm/yr stability the Valhalla 2720GS Ultra-Precision Direct Voltage System is delivering strategic voltage performance to the U.S. Navy Fleet. The 2720GS Ultra-Precision Direct Voltage system is the first calibrator to maintain reference stability using a real time clock (NOV-RAM based drift analysis) and an automatic onboard reference monitoring system (OBRMS) verifying the units internal diode reference integrity. To date, **only the Valhalla 2720GS has been accepted and approved** as the U.S. Navy MECCA II Direct Voltage Calibrator (180 systems delivered and accepted).

The Valhalla 2730GS Multifunction Calibrator uses drift analysis (microprocessor-real time clock based) for enhanced long term DC Voltage stability.

Ease of calibration has always been a major design goal for enhancing the user friendliness of all Valhalla instrumentation.

Valhalla engineers pioneered the use of front panel generated or via GPIB digital auto-cal calibration capability. The microprocessor based 2703 AC Voltage Standard, introduced in 1981, was the first AC Voltage Standard in the marketplace to have the covers on digital calibration capability. Calibration correction



factors are stored in non-volatile memory (NOVRAM or EAROM). Analog offset voltages for zeros, full scales, and with the 2730GS at user defined 'spots', may be calibrated and characterized for later high accuracy output compensation with the instrument's internal digital to analog converter. The storing of digital correction values for analog offsets may be performed on all Valhalla microprocessor based standards (2701C, 2720GS, 2724A, etc.) with the instrument top cover intact. This feature facilitates ease and stability of calibration in less than ideal ambient circumstances. Many competitive instruments lack this digital calibration feature, requiring covers to be removed and resistive trim pots adjusted (ie JF5101B). A calibrator being trim pot adjusted with the covers off will drift to different levels when the lid is reinstalled.

For AC Voltage, the 2730GS calibrator's proprietary non-volatile 3 dimensional calibration data array provides 'spot calibration' with enhanced accuracy (40 ppm) for 'both output and measurement' at up to 500 user defined points. (U.S. patent pending).

Unlike our competitor's 'just a 2 amp DMM calibrator', the Valhalla 2730GS 'calibrator-on-a-card' construction, with multiple channels (phase, watts), output and measure capability plus... means you can calibrate a lot more instrumentation than 'just a digital multimeter'. We believe the term 'multifunction calibrator' is truly befitting for the Valhalla 2730GS.

Automated Systems Capabilities

GPIB

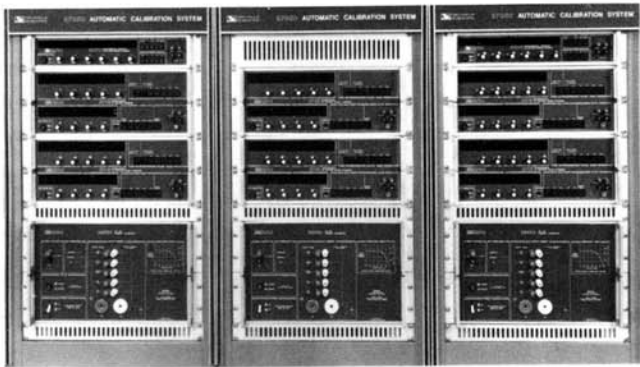

3 Phase Watts Calibration System —

capable of delivering 100 amperes RMS per phase solved a critical power calibration requirement for the Nuclear Power Utility Industry. This powerful system provides a graphic demonstration of Valhalla's ability to design and configure an automated calibration system to fulfill your most demanding requirements.



Mobile Calibration/Data Acquisition System —

can be configured with automated alternating/direct voltage standards, programmable resistance. Includes a 16 channel cold junction compensated thermocouple data acquisition system (HP 3497A) with rack mounted HP 200 Series instrument controller and Valhalla automated calibration/test software.

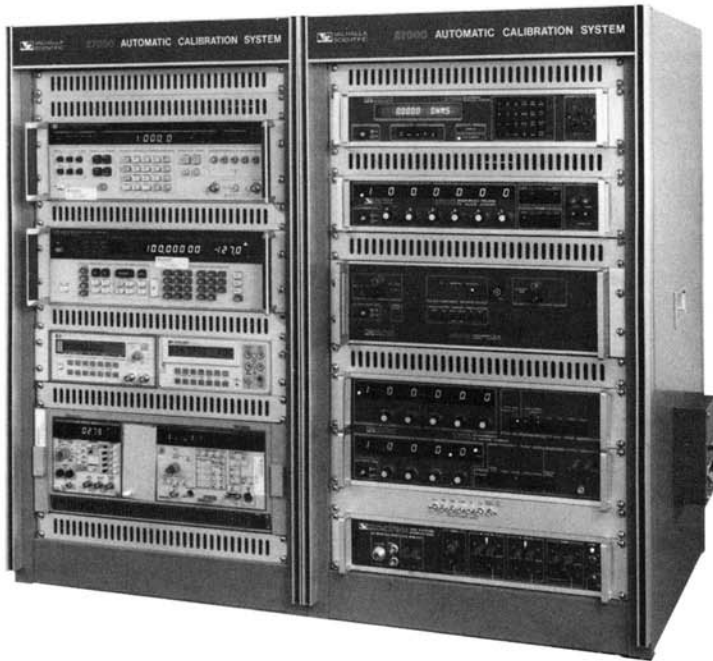

Dual Benchtop Rack Station (option DB-32) —

configured for meters, oscilloscopes, and general RF calibration capabilities. Automated calibration stimulus includes direct/alternating voltage, direct/alternating current (12 Amperes), resistance, signal generation to 990 MHz (HP 8656B), and oscilloscope calibration generator (Tek CG5001), frequency counter (HP 5384A), and general system multimeter (HP 3478A).



Rack Cabinets

Modular Horizontal Laboratory Benchtop

Option "HCC-1", "HCC-2" and "HCC-3" modular horizontal laboratory benchtop rack cabinets. Each section accommodates 18" for rack mounting purposes. "HCC-1" is a single horizontal bay, while "HCC-3" is the three horizontal bay cabinet as pictured.

Automated Systems Capabilities



Valhalla Automatic Calibration System Configuration Guide

Calibration Instrumentation Packages

- Valhalla 27000 ACS based Calibration standards with appropriate options—See page 11 for general capabilities, see below for optional software and controller packages.
- Valhalla 2730GS Multi-Function Calibrator based system with appropriate options. See below for additional system instrumentation, optional software, controller and rack mounting packages.
- Option “ACS-5001” Tektronix CG5001 Programmable Oscilloscope Calibrator complete with TM5006 power supply, fast edge mode rise-time pulse head (see below for software and computer options). For budgetary pricing purposes add Valhalla 2730GS with appropriate options to “ACS-5001” price.
- Any GPIB instrument (ie., 8½ digit system DMM, signal generator, frequency counter, etc.) may be optionally added to the Valhalla Automatic Calibration System at any time. See below for software driver module requirements. Consult with the Valhalla factory for specific recommendations.

Automatic Calibration System Software

“PC-CAL”™—software is MS-DOS based and runs on most IBM XT or AT compatible instrument controllers (ie., HP Vectra, Compaq, Sun). “PC-CAL” operates in Microsoft Quick BASIC™, requires a hard disk drive with at least 1.5 megabytes free storage for PC-CAL™, PC-PAINT™ and Valhalla’s clipped Ashton-Tate Database III + calibration management/workload utilities. Although PC-CAL can be operated manually by keyboard, it is also compatible with most PC based COM-1 mouse devices (optical or track-ball based). See the “PC-CAL” section of this catalog for complete details on software features and capabilities.

“HP-CAL”™—software runs on HP 200 series (HP9816, 9836) and HP 300 series instrument controllers. The “HP-CAL” software operates in HP BASIC 4.0, is CSS-80 drive compatible (ie., HP 9122D), supports: monochrome or color graphics, HP Mouse, touch screen and requires 1.25 megabytes of RAM (CPU expansion). See the “HP-CAL” section of this catalog for complete details on software features and capabilities.

27000 Series Calibration Systems

SYSTEM 27000ACS	Components PC-CAL or HP-CAL BASED 2701C, 2703, 2724A, 2500EP, 2790B TEST PANEL Options 2705, 2720GS, 2555A, TEK CG5001,
27010 METERS	2730GS, HP 3458A Options 2555A
27020 SCOPES ONLY	TEK CG5001 Optional HP 8656B
27030 METER & SCOPES	2730 GS, TEK CG5001, HP 3458A Options HP 8656B, TEK AA5001

USER’S GROUP CALIBRATION PROCEDURES—120 different models of precision DVMs, hand-held DMMs, oscilloscopes, decade resistance boxes and more are **included** with either “HP-CAL” or “PC-CAL” software package at no extra charge. Valhalla’s engineering staff has reviewed all the donated procedures and coded them by category or type. The user’s group calibration procedures are coded for being procedurally correct; matching manufacturer’s tolerances, calibration with adjustment procedures and verify/specification check procedures. A partial list of available procedures may be found in the calibration software section of this catalog.

SOFTWARE DRIVER MODULES—Expanding Valhalla **PC-CAL** or **HP-CAL** system automation capabilities with non-Valhalla manufactured items (ie., Tektronix CG5001 Oscilloscope Calibrator) requires the additional purchase of the appropriate software driver module.

A software driver module for a given instrument added to the Valhalla system incorporates English Style Calibration term specifiers with built-in interpretive GPIB command control routines. A software driver module automates or systemizes the given instrument (makes it part of the Valhalla Calibration System) and should not be confused with a calibration procedure. Refer to the calibration software section of this catalog for a detailed description and listing of currently available software driver modules.



Automated Systems Capabilities



Variety of Controller Packages

For "HP-CAL" based requirements, Valhalla Automatic Calibration Systems are available with the most popular HP9000 series instrument controllers with options. A turnkey HP200 series (i.e., HP9816S, HP9836A) or HP300 series color controller with HP mouse, touchscreen bezel, printer and disk drive configured around your storage requirements are available with any Valhalla calibration system.

For "PC-CAL" based requirements, Valhalla can provide a customer with almost any preferred manufacturer of IBM XT or AT compatible (ie., HP Vectra, Compaq Deskpro series) instrument controller software, for any Valhalla calibration system.

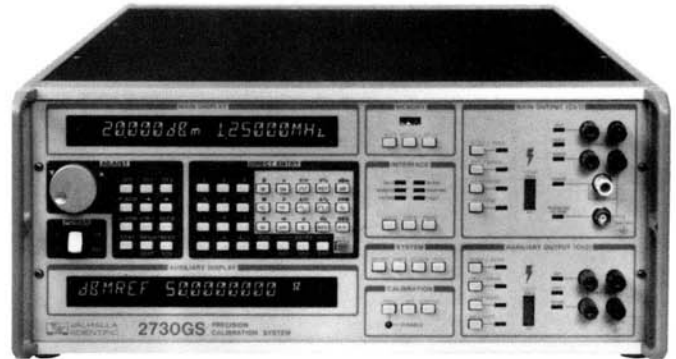

The Next Frontier in Mobile Calibration

The Valhalla 2730GS not only provides 'closed loop' GPIB control, the four digital interface slots in the rear provide plug-in calibration procedures on a card (PRO-2) and complete remote communication (RS232C) interfacing capability.

Valhalla optionally offers a modem-link RS232C modem communication interface package (PC-CAL based) for use with the 2730GS calibrator.

Valhalla's 'PC-CAL' procedures may be downloaded via modem-link into the non-volatile memory of the 2730GS calibrator.

Following the actual calibration of the device under test (DUT), the **calibration results** may be printed on-site, stored in 2730GS non-volatile memory (RES-5), or uploaded via modem-link back to the PC based computer for file maintenance, print out or archival storage purposes.

Unless the calibrator you're considering has the remote data handling power of the Valhalla 2730GS, completely automated mobile calibration will only be a fluke.

Valhalla's new 'PC-CAL' software revision 4.0 is additionally designed to provide completely documented calibration data in **compliance to MIL-STD-45662A** (August 1988). The flexible calibration procedure writer provides the operator with preadjustment calibration verification (data printouts), physical analog adjustment, or via GPIB, digital correction factor adjustment capability, followed with post adjustment calibration verification with **complete data documentation**. The 'PC-CAL' calibration report even references the type of standards used and their respective calibration status (expiration date).

3



Mobile Calibration or Standards Labs Use

Valhalla's 'PC-CAL' based systems let you chose where you want to locate your calibration system. A complete PC-CAL based meter/oscilloscope calibration system such as the 27030 (including the 286RC Instrument Controller, 2730GS Calibrator, TEK CG5001) along with several add-on options can easily stand alone on a benchtop. You may wish to rack mount the entire system on a mobile cart with shock isolated casters (MCC-1) and take it 'on site'.

Option "MCC-1" single bay Mobile Calibration Cart complete with high-strength shock isolated wheels, pop-up locking/collapsible work surface, retractable power cord, rear steering handle grip bar, removable/locking plexiglass front door and pre-punched holes on top rear area for monitor and auxiliary cabling (ie., printer). In addition, "MCC-1" has a built-in power panel with GPIB connector for external use and has 31½" available for rack space.

Option "HCC-1", "HCC-2" and "HCC-3" modular horizontal laboratory benchtop rack cabinets. Each section accommodates 18" for rack mounting purposes. "HCC-1" is a single, horizontal bay, while "HCC-3" is a three horizontal bay cabinet as pictured on page 8.



10

27000 Automated Calibration System



27000 Automated Calibration System

The basic 27000 consists of the 2701C DC Voltage Standard, the 2703 AC Voltage Standard, the 2724A Fully Variable Resistance Standard, the 2500EP, 12 Amp AC-DC current Calibrator and the 2790B Modular Systems Interface Console—all fully tested, integrated and contained in the systems ducted and cooled benchtop rack enclosure.

1.6 PPM or 10 PPM 30 Day DC Accuracy- The Choice is Yours

As the system's programmable DC Standard, the 2701C provides bi-polar outputs in 1ppm increments from 1 microvolt on the 1.2 volt range, up to 1200 volts. The basic accuracy of the 2701C is 10ppm. For calibration requirements demanding even more precision, the 27000 is optionally available with the new Model 2720GS Direct Voltage System. The 2720GS is the world's most accurate programmable DC standard, providing a 30 day measurement and stimulus accuracy of ± 1.6 ppm over a 12°C temperature span.

2703/05-Providing a New Phase in AC Performance

For the precision generation of AC voltage the 27000 utilizes the 2703 Programmable AC Voltage Standard. The 2703 digitally produces crystal pure sinewaves with rock-solid amplitude and frequency stability. The basic ninety day uncertainty of the 2703 is $\pm 0.02\%$ to 30KHz and $\pm 0.03\%$ to 100 KHz. This micro-computer based AC standard provides voltage outputs in 10ppm increments from its 120mV full scale range to a maximum output of 1200 volts RMS available through its built-in kilovolt amplifier. For automated phase and watts calibration, the 2705 AC Voltage/Phase Standard is optionally available.

1PPM Resolution, Fully Variable Resistance Standard Also Tackles Conductance

The 27000 takes full advantage of Valhalla's 2724A to eliminate the hit-and-miss approach of cardinal point resistance calibration. The 2724A is the world's first and only fully variable, microprocessor based programmable resistance standard. The 2724A generates over 10 million values of precision resistance from 100 micro-ohm increments on it's 120 ohm full scale range up to a maximum output of 11 gigohms. The basic ninety day accuracy of the 2724A is 7 ppm. Automatic 2-terminal compensation and a "fast" mode with 3KHz bandwidth are standard features. "CPR" is optionally available for use in calibrating spike generating ohms converters. For semi-automated calibration of low resistance ohmmeters and current sources, the 2575A is optionally available.

12Amp Direct Output Calibrates High Current DMMs, Wattmeters, Shunts

Almost every handheld DMM features direct measurement to 10 amps, yet only the 27000 offers the capability to calibrate this range with its basic system configuration. In fact, the 2500EP Programmable AC-DC Current Calibrator delivers precise constant current from 100 microamps full scale to a maximum output of 12 amps. If additional output current is needed, the Model 2555A is optionally available to provide up to 100 amperes DC or RMS AC.

Universal Calibration Interface Panel

It is fitting that the 27000 ACS, a flexible system composed of integrated modules, utilizes the 2790B automated interface console. The 2790B Universal Calibration Interface console ergonomically switches all the separate calibration stimulus outputs and measurement devices (auxiliary channel) to a 4-wire based set of output terminals. See pp. 22 for complete description on 2790B system capabilities.

Valhalla's "PC-CAL" or "HP-CAL" Computer Automated Calibration Software Package

Valhalla offers automatic calibration software for use with the Valhalla 27000 ACS. For automated use with an IBM compatible PC/XT or AT compatible instrument controller order the 'PC-CAL' software package. For automated use with a HP 200 series, or HP 300 series instrument controller order the 'HP-CAL' software package.

27000 Automated Calibration System Calibrators, Standards & Systems



27000 Specifications (Abbreviated)

DC Voltage—2701C performance	
Ranges	Accuracy (ppm of setting \pm uV)
100mV-1200V	30 days 8ppm \pm 20uV
	90 days 15ppm \pm 20uV

DC Voltage—2720GS System Upgrade—performance	
Ranges	Accuracy (ppm of setting \pm uV)
650mV-1200V	30 days 1.4ppm \pm 1.75uV
	90 days 2.0ppm \pm 1.8uV

Resistance—2724A Resistance Standard	
Ohms	Accuracy (ppm of setting \pm m Ω)
0 to 11Gohms	30 days 7ppm \pm 2m Ω
	90 days 17ppm \pm 2m Ω

AC Voltage—2703 AC Voltage Standard	
Ranges	90 day Accuracy \pm (setting \pm %range \pm 520uV)
120mV-1200V	0.02% \pm 0.01% to 30kHz

AC-DC Current—2500EP Current Calibrator	
Ranges	90 day Accuracy \pm (% of setting \pm % of range)
200uA-12A	0.01% \pm 0.02%-DCI
	0.05% \pm 0.05%-ACI

*Accuracies are relative to national standards.

27000 Options

Automated Calibration Software "PC-CAL" or "HP-CAL"

Valhalla's powerful and comprehensive laboratory automation software package 'HP-CAL' is for use with the HP 200 series or HP 300 series instrument controllers. 'PC-CAL' is for use with an IBM PC/XT or PC/AT compatible instrument controller. Includes full operating software, user's group calibration procedures, software support and documentation for the basic 27000 ACS and any system options exercised at the time of order. 'PC-CAL' requires the 'VSI-488' GPIB card option.

Ultra-Precision Direct Voltage System Option "ACS-2720":
Substitutes the Valhalla 2720GS DC System in lieu of the standard 2701C. Provides for DC stimulus and measurement accuracy of \pm 1.6ppm. Increases sourcing capability to 100mA. The 2720GS is fully integrated, tested and calibrated with the 27000.

High Current Output Option "ACS-2555":
version of the Valhalla 2555A 100 Ampere AC-DC current Calibrator, a high current plug-in module for the 2790B and full systems integration and calibration. Requires "ACS-70" or "ACS-32" rack expansion options.

Full Rack Cabinet Option "ACS-70":
benchtop rack enclosure to a full height rack enclosure with approximately 70" of useable rack space.

Twin Benchtop Rack Cabinet Option "ACS-32":
additional 32" of rack space for systems expansion capability. This unitized dual-rack cabinet option keeps all systems modules above the bench within easy reach.

Automated Oscilloscope Calibration Module "ACS-5001":
Allows the 27000 to accomplish rapid automated calibration on oscilloscopes as well as meters. Includes a systems tested and integrated Tektronix CG5001/TM5006 with remote variable, oscilloscope interface plug-in for 2790B and software driver module. Requires "ACS-100" and either "ACS-70" or "ACS-32".

24-Hour Module Support Program "ACS-24":
hour turn-around on repair and calibration of any Valhalla manufactured system standards and interface console for one full year. In the event of catastrophic damage, a loaner unit will be made available on a no-charge basis.

Advanced Systems Training Option "AST-2"
Comprehensive two day instructional program designed to optimize operator efficiency. Courses are conducted in Valhalla's new high-tech training center located at Valhalla's corporate headquarters, San Diego, California, U.S.A. Training materials and lunches are included.

Ordering Information

27000 Bundled Calibration System includes: 2701C, 2724A, 2703, 2500EP, 2790B, Rack integration and PC-CAL or HP-CAL	\$26,945.00
Option "ACS-2720" Upgrade Standard 2701C to 2720GS Ultra-Precision Direct Voltage Calibrator	7,995.00
Valhalla "286RC" Rackmount Controller	3,995.00
Valhalla "286CBT" Color Controller	3,895.00
Option "HP310" Bundled HP Controller Package	9,995.00
Option "ACS-2555" High Current Output (100A)	5,495.00
Option "ACS-2705" AC Voltage/Phase Standard	6,795.00
Option "MCU-1" Mobile Cal Work Surface and Shock Isolated Casters Cabinet Upgrade	995.00
Option "DB-32" Dual Benchtop Rack Cabinet	1,495.00
Option "H3B" Horizontal 3 Bay Rack Cabinet	1,495.00
Option "AST-2" 2 Days Advanced Systems Training	695.00
Option "ACS-24" 24-Hour Support Program	1,995.00
Additional Set Systems & Software Documentation	395.00

27010 Automated Meter Calibration System



The powerful and compact 27010 bench cluster calibration system provides the speed, versatility and accuracy to slash through calibration backlog on items from 3½ to 8½ digit DMM's, analog meters, power supplies, shunts, C.T.S., amplifiers and more!

For starters the 2730GS is a calibration system within a system. It's standard capabilities include: direct voltage to 1100V with 3 ppm basic accuracy, alternating voltage to 1.25 MHz with 65 ppm mid-band uncertainty, a built-in K.V. amp capable of generating in excess of 5 X 10⁷ VHz product, current to 12 amps and resistance to 100M ohms. On top of that there's optional capability of 20, 30 or 50 MHz wideband output, (or add a second channel to accomplish) phase to 1 millidegree or wattmeter calibration. Then there's optional 7½ digit AC and 8½ digit DC voltage measurement capability and even a built-in, fully automatic thermal RMS measurement option. For a complete listing of standard and optional capabilities and performance specifications, see the 2730GS section of this catalog.

To complement the 2730GS, Valhalla has selected Hewlett Packard's new 3458A 8½ digit DMM which features world class accuracy combined with a blazing speed of up to 100,000 readings per second. Contact Valhalla Scientific for detailed performance specifications on the HP3458A.

The computational and control aspect of the 27010 system is provided by Valhalla's 286CBT IBM AT compatible GPIB controller. Standard features such as brilliant EGA color monitor, 10 MHz \emptyset wait state operation, 20 MB hard disk, 1.2 MB Floppy, 1 MB RAM, GPIB, RS232C, parallel interfaces and a mouse combine to make the 286CBT uniquely qualified to round out the 27010 hardware package.

Valhalla's PC-CAL is truly the Rolls Royce of the calibration software industry. Others may claim that their software is as powerful, flexible and easy to use as PC-CAL. So, give us a call to arrange a "test drive", and don't forget to bring your racing gloves. For details on PC-CAL consult the color portion of this catalog. The 27010 System includes the necessary PC-CAL software driver modules for the 2730GS and the 3458A.

PC-CAL™ Automated Calibration Software

By popular demand, Valhalla now offers our powerful computer-aided calibration software package in an MS-DOS compatible format. Written in Microsoft Quick BASIC, this modular and expandable software package helps cut through calibration backlog for meters, scopes and general purpose test equipment. Enhanced color graphics increase operator throughput and aid in computer prompted repair routines. The Calibration Management/Workload Projection Module is compiled Database III+ for maximum power and flexibility.

Ordering Information

Valhalla 27010 Calibration Station	\$27,495.00
'PC-CAL' or 'HP-CAL', automated software included	N/C
Valhalla '286-RC' PC based rack mount controller	\$3,995.00
Valhalla '286-CBT' PC based color benchtop controller	\$3,895.00
Option 'BCC-1' Benchtop Rack	\$1,695.00
Option 'MCC-1' Mobile Cabinet	\$2,495.00
Option 'ACS-70' Full height rack enclosure	\$1,790.00
Option 'VS-488' Valhalla's PC-CAL compatible GPIB card	\$595.00
Option 'AST-2' 2 days Advanced Systems Training	\$695.00

Valhalla 27020 Automatic Oscilloscope Calibration System

Computer Aided Calibration



27020 Automated Oscilloscope Calibration System

- Tektronix CG5001 Oscilloscope Calibrator, Pulse Head, and TM5003 Power Supply included as standard
- Streamlines manual oscilloscope calibration
- Valhalla's 'PC-CAL' software is also included
- Multiple oscilloscope calibration procedures included
- Easily expandable to include an HP 8656B Signal Generator for bandwidth verification, and more.

The Valhalla 27020 is a fully tested and integrated automated calibration system package for rapid and accurate calibration of a wide variety of oscilloscopes. It also tests and calibrates scope plug-ins, probes, amplifiers, and a variety of scope accessory devices.

With the Valhalla 27020 system comes the Tektronix CG5001 Programmable Oscilloscope Calibrator plus Valhalla's powerful "PC-CAL" Automated Calibration software package. The Tek CG5001 comes with the TM5003 power supply and the Pulse Head accessory as standard items in the Valhalla 27020 package. In addition, the 27020 package includes calibration procedures for oscilloscopes which you can use as they are, modify them to fit your needs, or easily write new procedures of your own. Not only are all 'PC-CAL' procedures onward compatible with future software offerings from Valhalla, the 27020 is upwardly expandable. For calibrating the bandwidth on 300 MHz or higher frequency oscilloscopes, the 27020 system can optionally include the HP8656B (option "ACS-8656B") Signal Generator.

The heart of the 27020 system is the TEK CG5001 scope calibrator with output capabilities which include all of the following: A voltage standard output (**amplitude mode**) to calibrate vertical display accuracy with ranges from 40uV to 200V (1-2-5 steps with multiplier). The current standard (**amplitude mode**) is used to calibrate current probes, with ranges from 1mA to 100MA (1-2-5 steps). Low distortion pulses in **edge mode** are used to test oscilloscope input amplifier and attenuator compensation (ranges from 20mV to 100V). **Timing markers** are used to calibrate scope time bases (ranges 10ns to 5 seconds). Slowed edges (**timing mode**) are used to calibrate very fast time base range scopes (ranges 0.4ns to 100ns). In addition the **Pulse Head**

accessory is used to generate fast rise, low distortion pulses for testing higher bandwidth vertical amplifiers.

The standard 27020 system consists of the following items:

- Valhalla 'PC-CAL' computer-aided meter/oscilloscope calibration software
- Tektronix CG5001 Oscilloscope Calibrator with:
 - Output cable assembly (Tek #012-0884-00)
 - Comparator head (Tek #015-0310-01)
 - TM5003 mainframe power supply (Tek #016-0195-03)
 - plus 3 each: 1 meter GPIB cables (Valhalla option 'GP-1')

A variety of system options are available with the 27020 meter/oscilloscope station.

Option "ACS-8656B" A systemized HP 8656B Programmable Signal Generator for oscilloscope bandwidth calibration to 990 MHz (1 each GP-1 cable included).

Option "BCC-1" Benchtop Rack Cabinet enclosure for the 27020 based instrumentation. Cabinet includes power panel, fan, ventilated rear door (32" available) and shelving support.

Ordering Information

Valhalla 27020 Calibration Station	\$20,845.00
'PC-CAL' or 'HP-CAL', automated software included	N/C
Valhalla '286 RC' PC based rack mount controller	\$3,995.00
Valhalla '286 CBT' PC based color benchtop controller	\$3,895.00
Option 'ACS-8656B' HP8656B Signal Generator	\$8,395.00
Option 'BCC-1' Benchtop Rack	\$1,695.00
Option 'MCC-1' Mobile Cabinet	\$2,495.00
Option 'ACS-70' Full height rack enclosure	\$1,790.00
Option 'VS-488' Valhalla's PC-CAL compatible GPIB card	\$595.00
Option 'AST-2' 2 days Advanced Systems Training	\$695.00

Computer Aided Calibration



The Valhalla 27030 Automatic Meter/Oscilloscope Calibration Station adds Tektronix CG5001 oscilloscope calibration capability to the already impressive host of capabilities of the Valhalla 2730GS calibrator and HP 3458A DMM benchtop cluster. The 27030 station provides calibration and verification capability of oscilloscope vertical gain, horizontal timing and gain, vertical pulse characteristics, probe accuracy and compensation, plus all the measurement capabilities of the world class HP 3458A 8½ digit DMM.

The Valhalla 27030 system automation capability includes "PC-CAL"™ PC based color calibration software for use with almost any desktop IBM XT compatible controller (i.e., Valhalla 286RC rack controller or Valhalla 286CBT color benchtop controller package).

The 27030 meter/oscilloscope calibration station gives you **high current** 12 Ampere AC-DC output capability from the Valhalla 2730GS as a standard configuration. Additional 2730GS options and capabilities may be ordered as normal 2730GS options. The 27030 station gives you multi-function meter calibration capability with a basic 90 day direct voltage uncertainty of 2 ppm and alternating voltage uncertainty of 65 ppm. In addition, for oscilloscope amplitude calibration you get 40uV to 200V, timing markers from 400pS to 5S, a rise-time less than 200pS, square wave amplitude generation and more. See the 27020 oscilloscope calibration station on pp 14 for more detailed information.

Valhalla's 'PC-CAL' software includes the software driver modules for all associated calibrators configured in the 27030 Meter/Oscilloscope Calibration System.

The standard 27030 system consists of the following items:

- Valhalla 'PC-CAL' computer aided meter/oscilloscope calibration software
- Valhalla 2730GS with HC-12 (12 Amps) and IEEE-488 interface

- HP 3458A DMM with IEEE-488 interface
- Tektronix CG5001 Oscilloscope Calibrator with:
Pulse head (Tek #015-0311-01)
Output cable assembly (Tek #012-0884-00)
Comparator head (Tek #015-0310-01)
TM5003 mainframe power supply (Tek #016-0195-03)
plus 3 each 1 meter GPIB cables (Valhalla option 'GP-1')

A variety of system options are available with the 27030 meter/oscilloscope station.

Bandwidth Calibration Expansion Capability

Option "ACS-8656B" expands the 27030 station capability to include the HP 8656B Programmable Signal Generator (100KHz to 990 MHz). The HP 8656B is ideal for calibrating the bandwidth on any oscilloscope to 990 MHz.

Option "BCC-1" Benchtop Rack Cabinet enclosure for the 27030 based instrumentation. Cabinet includes power panel, fan and ventilated rear door (32" available), shelving supports also included.

Option "MCC-1" Mobile Calibration Cabinet complete with shock isolated casters. See picture on pp 10 along with a complete description.

See page 20 for additional accessories available with the Valhalla 27030 Automatic Calibration System.

Ordering Information

Valhalla 27030 Calibration Station	\$45,950.00
'PC-CAL' or 'HP-CAL', automated software included	N/C
Option 'ACS-8656B' HP8656B Signal Generator	\$8,395.00
Option 'BCC-1' Benchtop Cabinet	\$1,695.00
Option 'MCC-1' Mobile Cabinet	\$2,495.00
Valhalla '286 RC' PC based rack mount controller	\$3,695.00
Valhalla '286 CBT' PC based color benchtop controller	\$3,895.00
Option 'ACS-70' Full height rack enclosure	\$1,790.00
Option 'VSI-488' Valhalla's PC-CAL compatible GPIB card	\$595.00
Option 'ACS-2400 BPS' remote communication package	\$1,995.00

Computer Aided Calibration

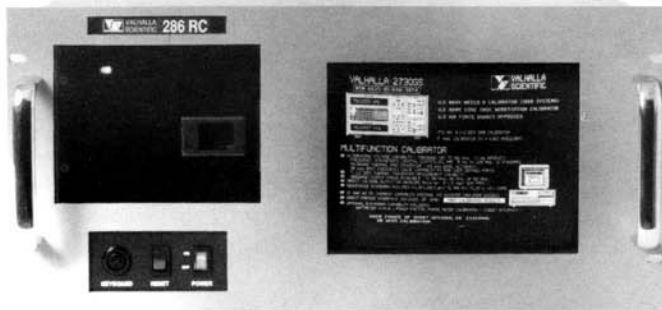

Valhalla now offers a ruggedized and MIL-T-28800C tested IBM-AT compatible instrument controller, the Valhalla 286RC. The commercial version of the Valhalla 286RC controller is virtually identical to the militarized model Valhalla is supplying the U.S. Army along with 236 each 2730GS calibrators. This industrialized PC based rack mountable instrument controller **Valhalla '286RC'** comes with the following features and capabilities as standard:

- Built-in 9" monochrome monitor
- 20 Mbyte hard drive, 3 1/2" micro-floppy
- Detachable IBM-AT (101 keys) style keyboard
- 80286 based microprocessor architecture
- One 'VS-488' IEEE-488 Interface card
- One serial and one parallel port
- Compatible with standard 19" rack enclosure

The Valhalla 286RC is hardware compatible with Valhalla's 'PC-CAL' and 'PC-WATTS' application software. In addition you may order the Valhalla 286RC simply for general instrument control applications. In either case the Valhalla 286RC is reliable, powerful and affordable.

Variety of Rack Enclosures

Valhalla offers a variety of rack cabinet enclosure options. Everything from horizontal laboratory benchtop rack cabinets as seen on page 8 to mobile calibration carts with shock isolated wheels (p 10). For a complete description of available enclosure options refer to page 15 in this catalog.

For general laboratory benchtop instrument control use, the **Valhalla 286CBT** color benchtop PC based (p.20) controller is ideal. The Valhalla 286CBT comes with the following features and capabilities as standard:

- Built-in 13" color-EGA monitor
- 20 Mbyte hard drive, 5 1/4" floppy
- Detachable IBM-AT (101) keys style keyboard
- 80286 based microprocessor architecture
- One 'VS-488' IEEE-488 Interface card
- One serial and one parallel port

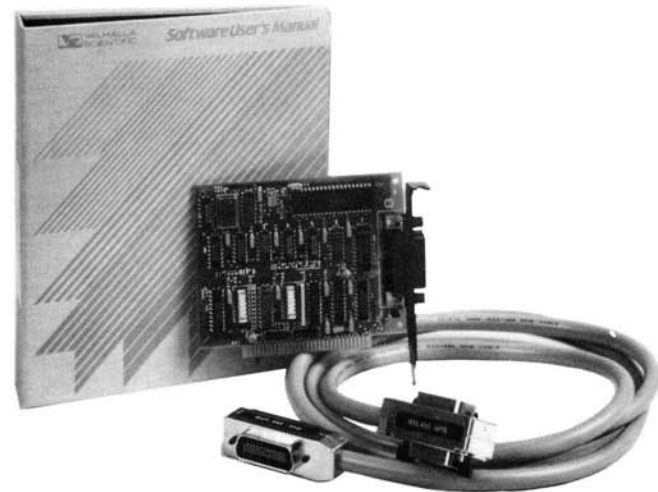

High Speed IEEE-488 PC Interface "VS-488"

Valhalla's VS-488 PC based IEEE-488 Interface makes it easy to integrate personal computer-based test and measurement systems. Up to 15 devices may be attached to each VS-488 board. The VS-488 GPIB card is available with an **optional GPIB cable** (GP1). In addition the VS-488 can occupy a short I/O slot, has data transfer speeds to 450 Kbytes/sec with DMA, and has complete IEEE-488 controller and Talker/Listener capability.

Ordering Information

Valhalla '286RC' PC based rack mount controller	.. \$3,995.00
Valhalla '286CBT' PC based color benchtop controller \$3,895.00
Option 'VS-488' Valhalla's PC-CAL compatible GPIB card \$595.00
Option 'BCC-1' Benchtop Rack \$1,695.00
Option 'MCC-1' Mobile Cabinet \$2,495.00
Option 'ACS-70' Full height rack enclosure \$1,790.00
Option 'AST-2' 2 days Advanced Systems Training	... \$695.00

Computer Aided Calibration

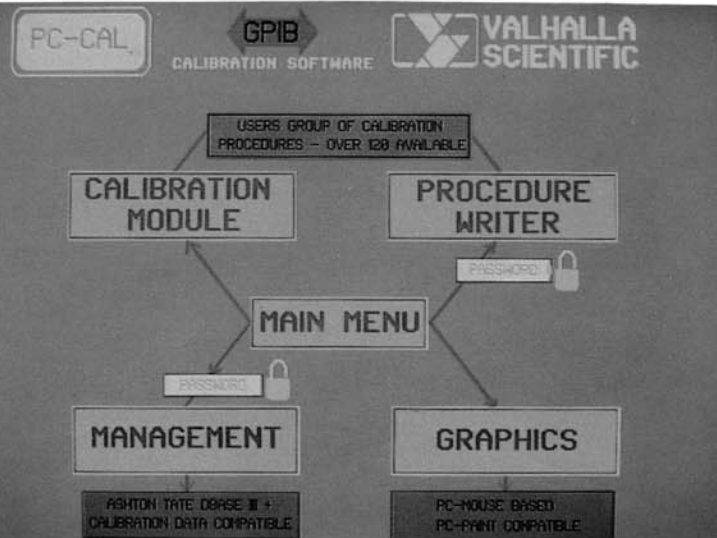

Sun). "PC-CAL" operates mainly in Microsoft Quick Basic™, with some enhanced sub-routines written in "C". "PC-CAL" requires a hard disk drive with at least 1.5 megabytes free storage for PC-CAL, PC-PAINT™ and Valhalla's clipped Ashton-Tate compatible Dbase III + and calibration management recall utilities.

Both "HP-CAL" and "PC-CAL" have many cosmetically identical screens and similarities. An operator familiar with either "HP-CAL" or "PC-CAL" would become almost immediately fluent on both software packages because of the similarities. As a matter of fact, Valhalla can provide a converter program for going to and from calibration procedures written with "HP-CAL" to "PC-CAL" as both calibration procedures are stored as ASCII files.

The password protected "Procedure Writer Module" is the heart of both "HP-CAL" and "PC-CAL" packages. Valhalla's calibration procedure writer with pop-up windows, mouse driven cursor control routines and built-in "Help" screens is extremely user friendly. When in the procedure writer mode, the system operator has continuous access to built-in software documentation and instruction via the "Help" window. Activation of the red colored "Help" window automatically brings up complete definitions, explanations, listings and instructions to ensure the optimum use of the given field of interest.

Each step of the calibration procedure may be independently generated on the multi-purpose screen. The direction of each step is defined by the "Action Code" field. Using the mouse to select the "Help" window automatically brings up the following message:

Unmatched Productivity

To achieve maximum laboratory productivity, Valhalla's modular automatic calibration software approach optimizes user efficiency in four key areas: Calibrator procedure writing, Automated calibration and testing, Calibration data analysis and, for the first time ever, the many benefits of Operator prompting, using mouse generated high resolution color graphics.

Introduction to "HP-CAL"

"HP-CAL" is Valhalla's driver module based automatic calibration system software for automating the use of Valhalla's calibration standards with HP200 series (HP9816S, HP9836A) or HP300 series instrument controllers. The "HP-CAL" software package is menu driven and includes over 120 calibration procedures provided by Valhalla's system users group for DMMs, oscilloscopes, decade resistance boxes, power supplies, phase angle voltmeters, handheld DMMs with 10 Amp measurement capability, wattmeters and more.

The HP310 version of "HP-CAL" has several operator advantages and enhancements over the HP200 series controller version. These advantages include the "HP-CAL" use of the HP Mouse as a remote variable to slew the output of a calibrator or draw custom, high resolution color diagrams (ie., repair adjustment notes for PC board component locations).

Valhalla's "HP-CAL" software package uses the mouse with the calibration procedure writer to select the calibration device to control, or even to select "action codes" with no keyboard keystrokes required. The benefit is a streamlined ergonomic calibration procedure writer that is 2-3 times faster than any of our competitors who have non-mouse based automatic calibration systems.

Valhalla's "PC-CAL"™ software is MS-DOS based and runs on most IBM XT or IBM AT compatible instrument controllers (ie., Compaq, Leading Edge, AST, HP Vectra,

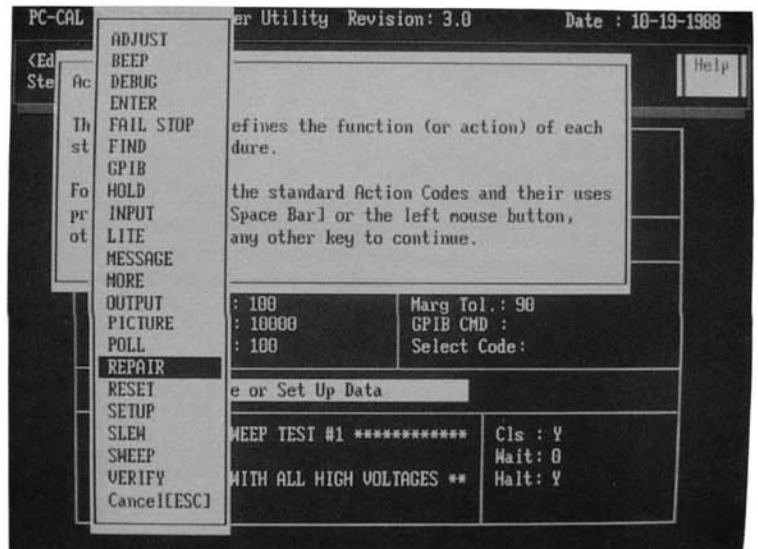

To eliminate the need for constant referral to look-up tables, all Valhalla action codes are plain calibration terms which relate directly to their function. By pressing the continue button, a new-to-the-system user can quickly step through a clear and concise definition of each action code.

GPIB

3

Computer Aided Calibration

GPIB

Abbreviated definitions of a few key action codes are listed below:

- MESSAGE:** Used to display information in the message/set-up field to the operator during calibration process.
- ADJUST:** Used to display adjustment/repair messages if the preceding step is out-of-tolerance.
- OUTPUT:** Causes desired systems standard to generate an output stimulus. Magnitude is determined by nominal value field.
- GPIB:** Permits control of IEEE-488 based instruments which are outside of or new to the system. Used for "closed loop" calibration of GPIB programmable DVM's.
- SWEEP:** Automatically tests AC response at a given amplitude by sweeping the frequency range identified by the fields:

1. Start Frequency
2. Stop Frequency
3. Step Frequency

All input and output action codes are directed to the measurement or stimulus source identified in the device label field (ie., 2730GS). HP-CAL and PC-CAL can be expanded to address a maximum of 15 device labels per GPIB card by incorporating additional Valhalla configured software driver modules.

Calibration Module

To enter the calibration module, simply select by mouse or press the corresponding soft key shown on the main menu. When initially entering this mode, the system automatically performs a full system GPIB self-test and displays configuration status.

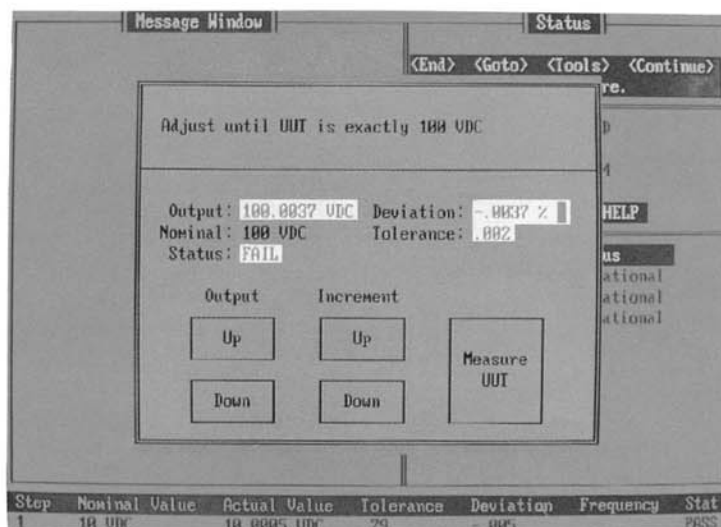

Both HP-CAL and PC-CAL software packages provide a variety of ways to get nominal levels and adjustable stimulus output levels (ie., 750 VAC at 100 kHz) from the system calibration standard of choice.

Using the mouse as a remote variable, the Valhalla system operator may adjust system outputs as desired to get the unit under test (UUT) to measure/display the nominal value. A color monitor has the added advantage of **color prompting for calibration pass/fail status**. The Valhalla color system user is less likely to make a fatigue based calibration error because the **system color alerts** the user like a traffic light to the exact UUT calibration pass/fail status. Along with an audible tone, a Valhalla system user would observe the color **green for pass, yellow for marginal tolerance and red for out-of-tolerance status**. Valhalla's color-based system software alerts the system operator who might not otherwise notice UUT tolerance status on a monochrome display.

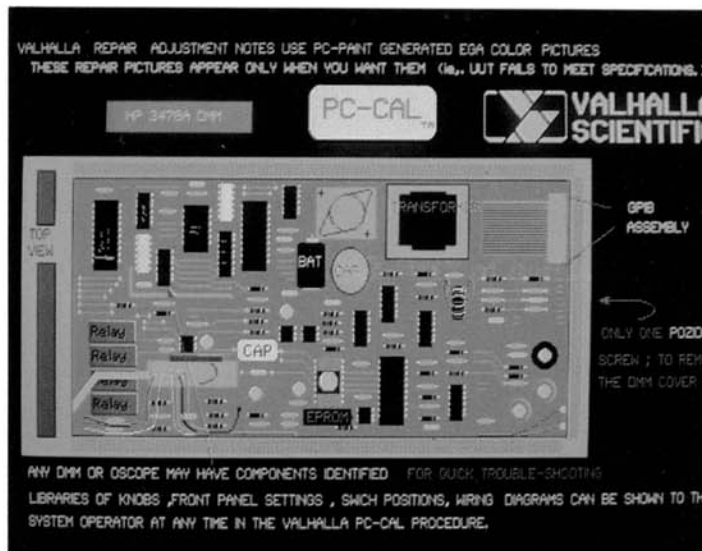

Unless the calibration system software you are considering has color graphics (preferably mouse generated), it cannot be easily used for automated repair and adjustment. If you have ever had trouble finding a component, such as a trim cap or resistor referenced by an instrument maintenance manual, you know a color picture of the PCB is worth a thousand words.

Mouse generated color graphics and diagrams may be simple or highly detailed. Valhalla's PC-CAL and HP-CAL color diagrams can appear at any time during a calibration procedure for technician instructional use, or on a conditional basis (ie., UUT failed last test) as an adjustment note. The Valhalla color system user has the ability to integrate graphics with text, including a library of components and knobs. The Valhalla color system user can be prompted with color front panel diagrams, PCB diagrams, knobs, buttons or arrows with text emphasizing the component of interest.

Computer Aided Calibration

Mouse generated color graphics and diagrams significantly enhance the user friendliness of Valhalla's calibration module. Operator prompting is provided to request the desired calibration procedure and diagram complete set-up instructions prior to beginning calibration.

The mouse generated color graphics of Valhalla's "HP-CAL" and "PC-CAL" allows an unskilled system operator to become immediately productive in the calibration laboratory environment.

Valhalla's "PC-CAL" is four color (CGA) or 16 color (EGA) compatible. Mouse generated "PC-PAINT"™ pictures are easy to draw. The sixteen color EGA version provides much better clarity and definition for PCB component identification purposes. "PC-PAINT" utilities allow a novice to draw, erase, shade, magnify, cut, paste, copy, fill colors, change colors, change patterns, even modify text sizes and font styles. Predefined routines allow a novice user of "PC-PAINT" to draw any size circle, square, rectangle and arc. The "PC-PAINT"™ cut and paste utilities allow any library of previously drawn items (i.e., resistors, ICS, EPROMs, FETS, etc.) to be lifted and copied into a new custom picture in seconds. When you are done with the picture, give it a name and recall it by that name when running the calibration procedure.

Valhalla's "HP-CAL" uses a similar mouse generated graphics edit. The zoom feature allows for final detail.

The password protected management software allows the manager to search, sort, retrieve and report a UUT's calibration history based upon a model number, manufacturer, serial number, user number, repair charge account or customer name. By entering the period of interest (i.e., next month), the PC-CAL or HP-CAL user accesses all instruments in the database due for calibration during that month. In addition, the projected manhours required for repair and calibration of the equipment due is also provided.

CPIB

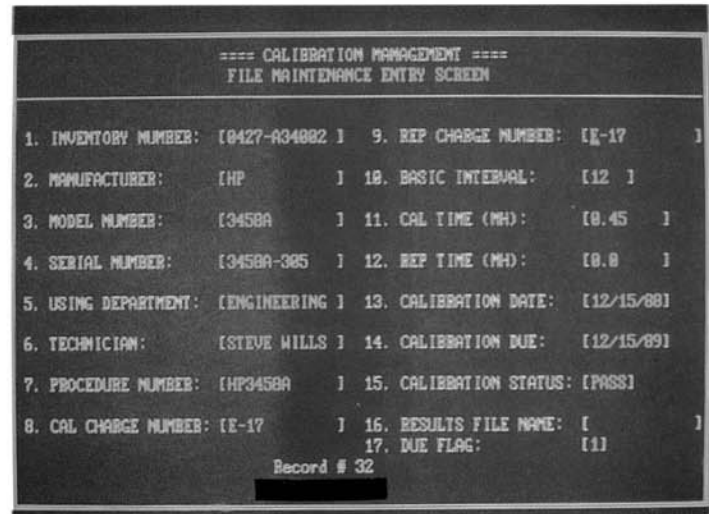

3

The password protected file maintenance section of "HP-CAL" and "PC-CAL" allows the laboratory manager to add, delete, search, sort, modify any item or record of interest.

This allows items that were not even calibrated by the Valhalla system to become part of your inventory database tracking recall system. Records may be added or deleted and search/sorted based upon inventory number, manufacturer, model number, serial number, user's department, repair charge number, calibration charge number, calibration due date and more.

PC-CAL Database is Dbase III + Compatible
 Valhalla's "PC-CAL" software, in particular, all the calibration data fields are Ashton-Tate Dbase III + compatible. Unless the PC-based management software package you are considering is Dbase III + compatible, you are missing out on the most commonly used database management software on the market. The Valhalla "PC-CAL" Dbase III + may be used for record keeping/sharing purposes, with management data (i.e. serial number, model number, user's department, calibration due date, etc.) communicated through a network or to a mainframe system, saving in-house system specialists untold months of file conversion headaches. Customizing "PC-CAL" management reports and calibration results is made tremendously easier by having "PC-CAL" file structure Ashton-Tate Dbase III + compatible.

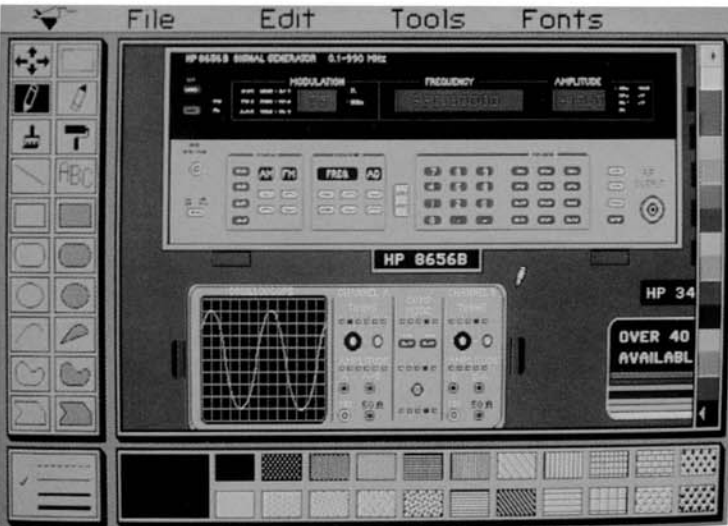

Handling the calibration workload, printing instrument recall reports, predicting peak demand calibration periods and scheduling technician overtime can be the most difficult task of managing a test equipment pool or calibration lab. Both PC-CAL and HP-CAL management software provide the needed reports, record retrieval and data reduction to help make timely and accurate management decisions.

Automated Calibration System Computer Aided Calibration

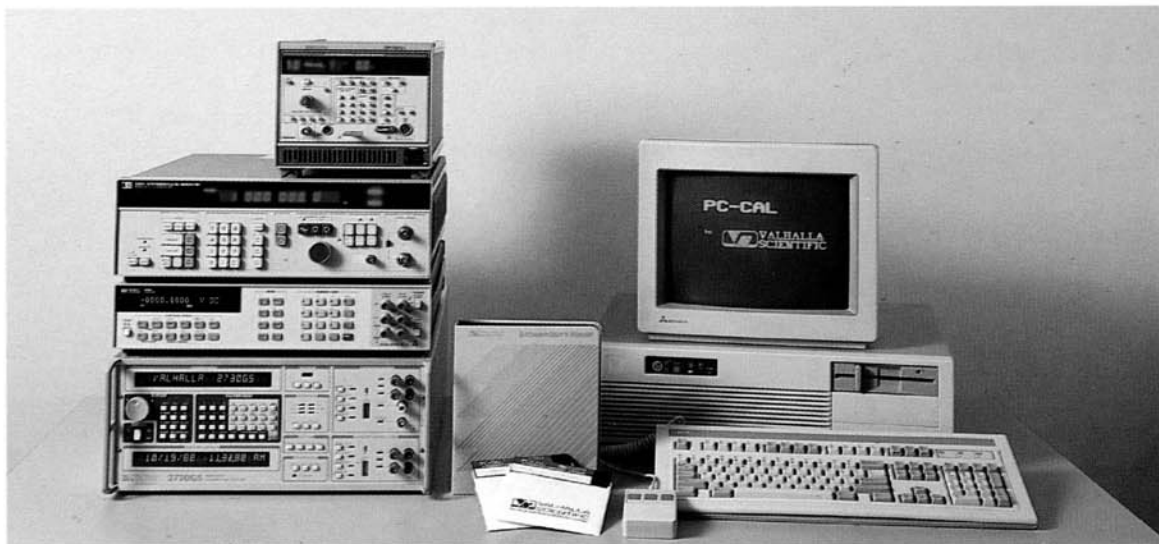

3

System Support

When it comes to system support, Valhalla backs its system users all the way. Our multi-faceted system support program includes: in-depth systems training at Valhalla's new high-tech training center or on site, continuous applications assistance from our skilled staff of system engineers, a 24-hour module support program and a full one year no-charge update program for all software and documentation enhancements. At Valhalla, we've built the best system support program available. You can count on it!

Systems Documentation

Valhalla's Automated Calibration System documentation is divided into two volumes. Volume I consists of the combined operating and maintenance manuals for each hardware module installed in the system. Volume II covers system integration and software documentation. The software documentation includes clear, concise, step-by-step, screen-by-screen instructions, as well as a generous listing of calibration procedures.

Advanced Systems Training Option 'AST-2'

is a comprehensive 2 day instructional program designed to optimize operator efficiency. Courses are conducted in Valhalla's new high-tech training center located at Valhalla's corporate headquarters, San Diego, California, U.S.A.

Automated Oscilloscope Calibration Module 'ACS-5001'

Allows a PC-CAL system user to accomplish rapid automated calibration on oscilloscopes. Includes a systems tested and integrated Tektronix CG5001/TM 5003, with pulse-head and remote variable.

Automated System Digital Multimeter 'ACS-3458A'

Provides a 'PC-CAL' based system user with a systemized HP 3458A precision 8½ digit multimeter.

High Current Output Option 'ACS-2555A':

Includes a systems version of the Valhalla 2555A 100 ampere AC-DC current calibrator.

System Controller Options

Option "ACS-310P" consisting of HP 310 Instrument Controller, HP 9122D 3½" micro-floppy disk drive, HP touchscreen bezel, HP Mouse, HP Thinkjet printer, includes Valhalla's "HP-CAL" software package and user's group calibration procedures.

Option "ACS-2225" consists of the HP Thinkjet Printer package with built-in GPIB compatible connector.

Option "ACS-2400 BPS" Valhalla's calibration procedure results modem link remote communication utility package. This remote site software utility package is "PC-CAL" compatible, includes two Hayes 2400 baud rate modems for downloading procedures or uploading results when using a Valhalla 2730GS Multi-Function Calibrator with an IBM XT or AT compatible controller.

Ordering Information

"HP-CAL" Calibration Software Package	\$2,995.00
"PC-CAL" Calibration Software Package	\$2,995.00
Option 'ACS-2400BPS' Remote Communication Package	\$1,995.00
Valhalla '286RC' Rackmount Controller	\$3,995.00
Valhalla '286CBT' Color Benchtop Controller	\$3,895.00
Option 'ACS-310P' Bundled HP 310 Package	*
Option "ACS-2225" HP Thinkjet Printer	\$695.00
Option 'MCC-1' Mobile Calibration Cabinet	\$1,495.00
Option 'HCC-1' Single Bay Horizontal Cabinet	\$1,695.00
Option 'HCC-2' Double Horizontal Cabinet	\$2,195.00
Option 'HCC-3' Three Bay Horizontal Cabinet	\$2,795.00
Option 'BCC-1' Benchtop Rack Cabinet	\$1,995.00
Option 'ACS-5001' Tek CG5001 Oscilloscope Calibrator	\$18,035.00
Option 'ACS-3458A' HP 3458A System Multimeter	\$6,495.00
Option 'ACS-2555A' 100 Amp AC-DC Current Output	\$5,495.00
Option 'AST-2' 2 Days Advanced System Training	\$695.00
Option 'ACS-24' 24-Hour Support Program	*
Additional Set Systems & Software Documentation	\$395.00

*Consult the factory for recommendation and pricing

20

Calibration Procedures



What is a Driver Module?

Driver Modules are software modules containing a database of commands used by the main program to control the various calibration instruments (i.e., standards, signal generators, distortion analyzers, DMM's, etc.) Expanding Valhalla calibration system automation capabilities with non-Valhalla manufactured items (i.e., Tektronix CG5001 Oscilloscope Calibrator) requires the additional purchase of the appropriate software driver module.

A software driver module for a given instrument added to the Valhalla system incorporates English style calibration

term specifiers with built-in GPIB command control routines. A software driver module automates or systemizes the given instrument (makes it part of the Valhalla Calibration System) and should not be confused with a calibration procedure. If the software driver module is for use with a source (i.e., HP8656B Signal Generator) then knob, mouse or keyboard control/ adjustment of the instrument's amplitude and frequency levels are additionally incorporated into the system's command set of "action codes". The software driver modules for Valhalla instrumentation (i.e., 2730GS) are already included in either the HP-CAL or PC-CAL software package.

Manufacturer Model Description					
Datron	1082 Multimeter	HP	3456A Multimeter	HP	8903B Audio Analyzer
Datron	4000A DC Standard	HP	436A RF Power Analyzer	HP	3458A Multimeter
Datron	4200A AC Standard	HP	438A RF Power Analyzer	Keithley	181 Nanovoltmeter
Fluke	5440 A/B DC Voltage Standard	HP	5335A Frequency Counter	Keithley	220 DC Voltage Source
Fluke	5442A DC Voltage Standard	HP	5334A Frequency Counter	Keithley	230 DC Current Source
Fluke	5450A Resistance Standard	HP	5384A Frequency Counter	Keithley	706 Scanner
Fluke	8505A Multimeter	HP	5385A Frequency Counter	Solartron	7062 Multimeter
Fluke	8506A Multimeter	HP	5386A Frequency Counter	Solartron	7071 Multimeter
Fluke	8840A Multimeter	HP	3325A Frequency Synthesizer	Solartron	7081 Multimeter
Fluke	8842A Multimeter	HP	8656B RF Signal Generator	Tektronix	CG5001 Oscilloscope Calibrator
Fluke	5100 Calibrator	HP	8662A RF Signal Generator	Tektronix	AA5001 Distortion Analyzer

This software driver module listing is only a sample of the most popular instruments already developed. Valhalla's

systems engineers are constantly adding more driver modules to the existing "HP-CAL" and "PC-CAL" library.

HP-CAL AND PC-CAL USER GROUP OF CALIBRATION PROCEDURES

Procedure Description	Notes	Procedure Description	Notes	Procedure Description	Notes
Datron DMM 1082	VV,S	Fluke Handheld DMM 8020A-1	UG	TEK O'Scope with DM44 465DN	VV,S
Gen Rad Decade Resistor 1432-B	VV,S	Fluke Handheld DMM 8021B	UG	TEK O'Scope 475	VV,S
Gen Rad Decade Resistor 1432-F	VV,S	Fluke Handheld DMM 8024A	UG	Racal-Dana DMM 5003	VV,C,S
TEK O'Scope 221	VV,S	Fluke Handheld DMM 8026A	UG	Racal-Dana DMM 5004	UG
TEK O'Scope Horizontal 2465-H	VV,S	Fluke DMM 8040A	UG	Racal-Dana DMM 6000	UG
TEK O'Scope Trigger 2465-T	VV,S	Fluke DMM 8050A	UG	Racal-Dana DMM6002	UG
TEK O'Scope Vertical 2465-V	VV,S	Fluke Handheld DMM 8062A	UG	Fluke Handheld DMM 77	UG
Simpson VOM 260-3	VV,S	Fluke DMM 8200A	VV,S	TEK 7000 Series Plug In	VV,S
Simpson VOM 260-5	VV,S	Fluke DMM 8300A	VV,S	TEK 7000 Series Plug In 7A24	VV,S
B&K Precision DMM 283	UG	Fluke Voltmeter 8375A	UG	Keithley Handheld DMM KE130	VV,S
TEK Time/Mark Gen. 2901	UG	Fluke DMM 8400A	VV,S	Keithley Handheld DMM KE131	VV,S
Beckman DMM 3010	UG	Fluke DMM 8505A	VV,S	Keithley DMM KE155	VV,S
HP 3420B DVM	UG	Fluke DMM 8506A	VV,S	Keithley Portable DMM KE169	VV,S
HP3437A DVM	UG	Fluke DMM 8600A	VV,C,S	Keithley DMM KE173A	VV,S
HP3442A HP 3440A Plug In	UG	Fluke Diff. Voltmeter 873A	UG	Keithley DMM KE177	VV,S
HP 3443A HP 3440A Plug In	UG	Fluke DMM 8800A	UG	Keithley DMM KE191	VV,S
HP3455A DMM	UG	Fluke DMM 8840CAL	VC,S	Keithley Programmable DMM KE169	VV,S
HP3456A DMM	UG	Fluke Wideband DVM 8920A	UG	Keithley Programmable DMM KE197	VV,S
HP3465A DMM	UG	Fluke Wideband DVM 8922A	UG	Gen Rad Decade Resistor RDS64A	UG
HP3466A DMM	UG	Fluke DMM 8000A	UG	Triplet VOM T4000	UG
HP3467A Logging DMM	UG	Fluke DMM 8012A	UG	Solartron DMM 7061	VV,S
HP3468A DMM	UG	HP DVM 427A	UG	Solartron DMM 7062	VV,S
HP34702A DMM	UG	Dana DVM 4430-210	VV,S	Solartron DMM 8071	VV,S
HP3476B DMM	UG	Dana DVM4430-212	VV,S	Solartron DMM 7081	VV,S
HP3478A DMM	VC,S	Dana DVM 4430-220	VV,S	TEK DMM DM44	VV,S
HP3478CAL DMM	VC,C	Dana DVM 4430-230	VV,S	TEK DMM DM501A	VV,S
HP3490A DMM	UG	TEK O'Scope 465	VV,S	Keithley Handheld DMM KE128	VV,S

Notes:
UG —Procedures from the 27000 ACS User's Group. These procedures were written by Valhalla 27000 Users so you may need to verify the procedures for correctness and to see if they correspond to your calibration philosophy.
VC —These procedures were written by Valhalla's engineering staff and are procedurally correct while matching the manufacturer's specifications.

VV —These procedures were also written by 27000 Users, but have been verified by Valhalla for procedural correctness. Valhalla does not guarantee that the tolerances match the manufacturer's specifications.
C —Indicates a Calibration Procedure.
S —Indicates a Specification Procedure.

Calibrators, Standards & Systems



What is a System Interface Console?

The Valhalla 2790B allows the user to accomplish "closed-loop" DMM calibration when plugged into the 2790B's front terminals without having to stop for an operator to switch test leads from one source to another. As part of any automated system application (ie., DMM calibration), the Valhalla 2790B Universal Calibration Interface Console routes individual instrument signals (stimulus or measurement) to a singular set of front panel terminals. With the UUT (unit under test) connected to the front terminals of the 2790B, individual calibration standard outputs (ie., AC voltage) may be switched to the UUT via GPIB software command or manual selection at the touch of a button.

Automate Calibration Standards You Already Own

Any manufacturer or model of AC voltage standard, DC voltage standard, transconductance amplifier (ie., Fluke 5220A), resistance standard and auxiliary device may be connected to the 2790B's rear terminals. When Current mode is selected for use with a transconductance amplifier, the Valhalla 2790B also automatically routes the system's AC and DC reference voltages.

Open Circuit Isolation/Safety

The dual fail-safe 2790B switching logic dictates an open circuit isolation sequence (break before make) for all system instruments from each other and the front terminals of the 2790B. Should a previous system output sequence have charged the 2790B front terminals and associated lead cabling with high voltage, the switching sequence discharges residual floating potentials to low levels prior to switching from a safety standpoint, and open circuit isolation protects every instrument connected to the 2790B rear terminals during switching. This prevents a given calibration standards output (ie., 1100VAC) from accidentally being injected into an adjacent calibration standard.

Low Thermal EMF/4-Wire Remote Sensing

We are often asked, "Aren't system cabling losses, internal relay switching, contact resistance and associated thermal EMFs a problem?". The 2790B circuitry is all 4-wire compensated and routed to the front terminals as the given calibrator stimulus is selected. By calibrating the given stimulus levels using remote sensing at the front terminals of the Valhalla 2790B, thermal EMF offsets, internal relay contact resistances and even system cabling losses are almost completely compensated (calibrated) out as stimulus level error sources.

To minimize thermal EMF offsets even further, the highest

quality gold plated copper tellurium terminals available are used as a standard part of the Valhalla 2790B construction.

Auxiliary Device Provides System Flexibility

The Valhalla 2790B Universal Calibration System Interface additionally allows any auxiliary device (ie., system DMM) to become part of the automated calibration application. Any device (UUT) connected to the 2790B front terminals may have its analog potentials measured by the auxiliary system instrument.

In addition, the 2790B provides system "short or open" mode selectability and includes rack mount adapters as standard.

Valhalla Software Support HP-CAL/PC-CAL

The Valhalla 2790B System Interface GPIB software commands are already incorporated into all of Valhalla's automated calibration software packages, such as "PC-CAL" and "HP-CAL". In addition, Valhalla offers automated software driver modules for many non-Valhalla manufactured calibrators and system DMMs. Refer to the automated calibration software section of this catalog.

Optional Equipment Items

OPTION DESCRIPTION

- AP-1** Auxiliary power panel (two AC power outlets, ie., 120VAC 60Hz)
- HC-1** High current panel (100 Amp terminals for use with Valhalla 2555A)
- OCS-1** Oscilloscope calibration interface panel for use with signal generators, synthesizers and function generators

Specifications

- Thermal EMF:** 1.5uV
- Output Impedance:** 250mΩ + 2uV
- Source Load Capacitance:** 150pF
- Leakage Current:** 5pA
- Size:** 89mm H x 432mm W x 432mm D (3.5" x 17" x 17")
- Weight:** 8.2 KG (18 lbs. net) 11.4 Kg (25 lbs.) shipping weight.

Ordering Information

Valhalla 2790B Universal Calibration Console	\$2,995.00
Option "AP-1" Auxiliary Power Panel	95.00
Option "HC-1" High Current Panel	150.00
Option "OSC-1" Oscilloscope Calibration Interface . .	250.00
Option "GP-1" 1 Meter GPIB Cable	95.00
Option "SL-48" 48 Inch Low Thermal Gold Copper-Tellurium Cable Set	95.00
Option "RX3" Rack Mount Adapter	Std

Calibrators, Standards & Systems

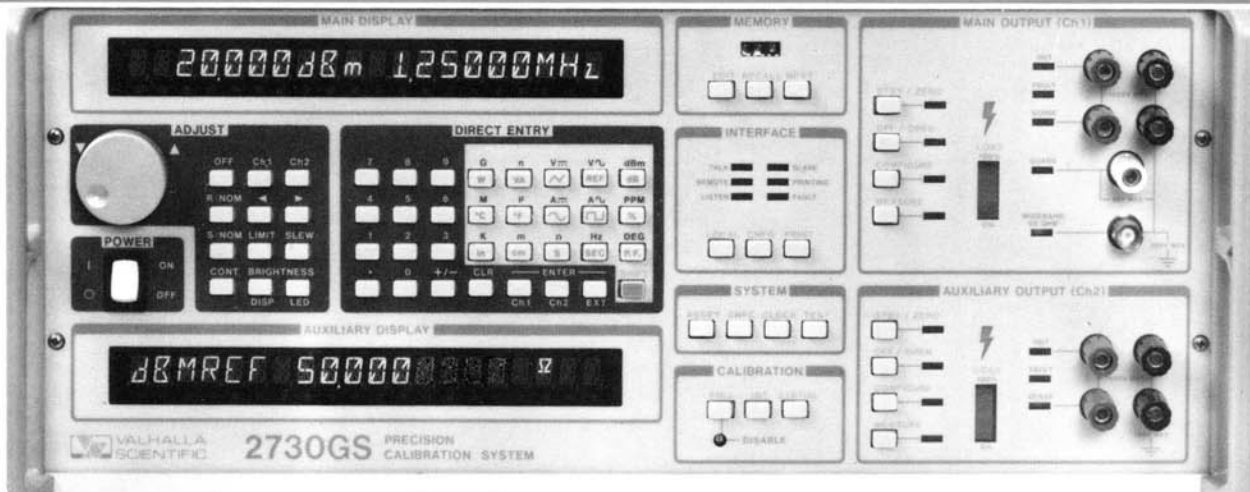

NSN 6625-01-040-9874

AC Thermal RMS Converter

Valhalla engineering has pioneered an extremely high accuracy AC sensing circuit for the 2730GS with the introduction of our solid-state AC Thermal RMS Converter. Midband alternating voltage accuracies of 65 PPM provide the capability of calibrating high accuracy AC voltmeters. In addition, AC accuracy can be further enhanced 2-3 fold by "spot-calibration". The 2730GS AC voltage output may be externally calibrated with up to 500 user defined voltage frequency combinations.

The significant advantage offered by the 2730GS is the elimination of the tedious manual transfer method of making high accuracy AC/DC transfer measurements or outputs. The 7½ digit 2730GS features a state-of-the-art thermal converter for precise AC measurements (option RMS) or outputs with speed and interfaceability. With a single key-press of the 'direct voltage' or 'alternating voltage' key, the 2730GS operator may output the same amplitude level for either function. This unique feature provides for rapid and extremely precise AC/DC Thermal RMS transfer or level comparison capabilities. The 90-day AC specification for this calibrator is 65 ppm without 'spot calibration' enhancement over a temperature range of 18°C to 28°C, allowing it's precision to be utilized in any production environment.

The Valhalla 2730GS Calibrator is designed to cover the widest workload range of any multifunction meter/calibrator. The standard built 2730GS Calibrator outputs extremely accurate levels of alternating and direct voltage, alternating and direct current (12 Amps) and precision resistances in 1Ω, 10Ω decade values.

In 1981 Valhalla introduced a major breakthrough in AC Voltage Standards. The Valhalla 2703 was the world's first (micro-processor based) synthesized sinewave AC calibrator with such features as front panel "covers-on" calibration capability. The synthesized sinewave design approach not only provides solid amplitude stability, but allows for excellent crystal-controlled frequency accuracy. The Valhalla 2730GS AC Voltage Calibrator design comes as an engineered enhancement from years of manufacturing hundreds of 2703 AC Voltage Standards.

The basic 2730GS provides alternating voltage from 100uV to 1100V, with frequencies from 10Hz to 1.25MHz. AC voltage amplitude is knob adjustable with 7½ digit resolution. The 2730GS uses a crystal controlled frequency oscillator design with 6½ digit frequency resolution. Frequency accuracy of 100 PPM/yr can be further improved to 10 PPM/yr with option "UP1".

Proven Direct Voltage Stability

Direct voltage is available to 1200VDC. In addition, 8½ digit resolution backed with the same ultra zener diode references used in the 2720GS Ultra-Precision DC Voltage System provides 5 PPM/yr stability. The 2730GS uses Valhalla's proven digital to analog conversion technique for a direct voltage output linearity of 0.2 PPM. The 2730GS option "VM1" provides a high accuracy, fast settling 8½ digit DC Voltage measurement, in fact it can measure to within 0.5 PPM of the final value in three seconds.

Expandable AC/DC Current Levels

Alternating and direct current is provided to 12 Amps with outputs available on various ranges from 10 Hz to 20 kHz. The high level AC-DC current calibrator card expanding 2730GS output to 12 Amps to 5 kHz is now available as standard. Virtually every handheld DMM has 10 Amp-2 kHz frequency response measurement capability. With no strap-on 12 Amp boost chassis to contend with, the 2730GS has 12 Amps internal capability making it truly a versatile multi-function calibrator.

Resistance capability includes a low ohm short and offers 1Ω to 100MΩ points in decade value increments. The actual or characterized value of the selected resistor is displayed in 2-wire or 4-wire mode. In addition, a second resistance standard instrument card (x 1.9 values) or special value resistances may be optionally fitted in the 2730GS.

Calibrators, Standards and Systems



Fully Tested for MIL-T-28800D

The Valhalla 2730GS has received the largest contract ever awarded a multifunction meter calibrator by the U.S. Navy. It is the only multifunction calibrator fully tested for environmental, maintainability and reliability to MIL-T-28800D. The Valhalla 2730GS is the new generation multifunction calibrator and as part of the MECCA II program, will be replacing the U.S. Navy's older, less accurate meter calibrators.

New Phase in Calibration

Your phase calibration workload may seem small, only a few items a couple times a month. It may however, require several hours of preparation and set-up with large bulky instrumentation. The optional phase capability of 2730GS is completely internal, no additional bench space needed and instantly available at the touch of a button.

The second channel output of 2730GS can provide a phase controlled sinewave from the first channel. The midband 2730GS phase accuracy is 0.008° , and is quite usable to 1 MHz. This high accuracy phase output is ideal for calibrating phase angle voltmeters and resolvers. The 2730GS derives its high accuracy phase from the NBS digital sinewave synthesis technique.

Wattmeter, VAR and Power Factor Meter Calibrator

The "watts" option provides a 2730GS with wattmeter, Volt-Amp-Watts calibration capability. The second channel AC current (12 Amps max.) may be output at any power factor from zero to unity. The channel 1 output provides the phase controlled alternating voltage (1100 VAC max.).

The 2730GS comes with one IEEE-488 interface as standard, a second GPIB card may be optionally fitted in the rear without removing the covers. By using the menu driven configuration, the 2730GS may be fully setup to be a GPIB instrument controller. Entire calibration procedures may be downloaded into the 2730GS memory for remote site use. The system's non-volatile controller memory allows it to send specific ASCII commands to GPIB based DMMs (i.e. function, range, trigger commands), wait a specified setting time interval, then request the amplitude reading from the meter under test. The 2730GS will then compare the GPIB meter reading against the nominal value, determine deviation from nominal, and decide pass/fail tolerance based upon the limits specified in the procedure.

The built-in printer interface will automatically print calibration results for the meter under test on a GPIB compatible printer (i.e. HP Thinkjet). In addition, the optional RS232C interface may be used to load procedures, download results-via modem link-to an IBM PC, XT or AT compatible instrument controller with Valhalla's "PC-CAL" software package.

External Channel Expansion Capability

All commercial 2730GS calibrators have 4 rear terminals (Hi-Low source, Hi-Low sense) which will automatically be switched to the front terminals of the 2730GS via the external channel 'ext' key. This feature expands 2730GS system capabilities to include integration and/or control of a wide variety of additional stimulus or measurement (system DMM, frequency counter, variable resistance, signal generation and more) instrumentation.

The Calibrator That Calibrates Itself

Valhalla's proprietary ASIC technology combined with the solid state RMS converter allows (at the operator's discretion) 'internal calibration' of all Alternating Voltage levels and frequencies against known Direct Voltage Levels with the "AC-DC Transfer" internal calibration routine.

You have the choice of using a few artifact calibration standards (ie 2734A) on the 2730GS for a typical 2 year calibration interval, or verify and adjust at 500 user defined 'spot calibration' points for all 2730GS capabilities.

User Choice of External Calibration

By externally calibrating the Valhalla 2730GS with a Valhalla 2734A Direct Voltage Reference Bank (1.0 and 10.0 VDC -4 cells), all 2730GS direct voltage ranges and on board voltage dividers are automatically internally 'characterized' or calibrated.

On Board Trouble Shooting Diagnostics

The 2730GS Calibrator's internal diagnostics troubleshoot error faults to board level. The "one function per board" design approach allows board level exchange repairs to take place on-site without returning the 2730GS Calibrator to any service center. With internal calibration capability, the 2730GS takes only minutes to realign product performance to new conditions (i.e. ambient temperature) and circumstances.

The Valhalla 2730GS has a major reliability design enhancement never before seen in a multifunction calibrator. By using EPLD or erasable programmable logic device technology, hundreds of TTL components have been eliminated. By reducing the component count and using ATE to insure every component on every board is functioning correctly, the 2730GS reliability is designed in from the ground floor up.

Calibrators, Standards and Systems

The versatility of a single printed circuit board per function or "one card per calibrator" makes the Valhalla 2730GS calibrator ideal for application flexibility, expansion, and maintenance. Optional calibrator capabilities are shown with blue squares.



Direct Voltage Standard Card

5 ppm/yr. stability
0.2 ppm linearity
8½ digit resolution (0.01 ppm)
Ultra-zener diode based (VS 2720 Type)

Alternating Voltage Standard Card

65 ppm, amplitude accuracy to 30 kHz
Solid State AC-DC thermal converter
10 Hz to 1.25 MHz bandwidth
500 VAC at 100 kHz bandwidth

High Level AC-DC Current Calibrator Card

12 Ampere output to 5 kHz
Calibrates the 10 Amp handheld DMMs
Extremely stable for inductive loads
No "boost-on" chassis expansion required

Multiple Waveform Output Card

Selectable square wave, duty cycle and triangle waveforms to 1.25 MHz
Verify TRMS converting DMMS
Amplitude oscilloscope calibration

Alternating/Direct Current Calibrator Card

0 -2.2 Amps AC or DC output
30 ppm/yr. direct current accuracy
7 Volts compliance/ front panel bar graph
20 kHz ACI bandwidth

Resistance Standard Card

Passive, cardinal point resistances
Short, 1.0 Ohm to 100 Mohms decades
High-precision aged resistors
2 wire-4 wire displayed value

IEEE-488 Controller Card

Performs closed loop calibration on GPIB based DMMs, UUTs
Built-in printer interface for calibration results

Option "R19A" Second Resistance Standard Card

15 ppm accuracy
1.9 Ohms to 19 MΩ values
Unique ohms values available (9 maximum)
DMM reading entry determines deviation

Option "IO2" Dual Analog Output Card

For use with strip chart, xy recorders
User specifies high/low output span

Option "Phase" Second Channel AC Phase Control Card

0.008° accuracy from 10 Hz to 5 KHz
Usable to 1 MHz
Calibrates phase angle voltmeters
NBS digital phase synthesis design

Option "RMS" AC-DC Voltage Measurement Card

Solid state AC-DC thermal converter
65 ppm amplitude accuracy
0.1 ppm resolution (7½ digits)
10 Hz to 1.25 MHz bandwidth

Option "RS232" RS232C Interface Card (2 Max)

Transmit memory contents (modem-link)
Download test procedures
Send calibration results to printer

Option "IEEE-488" Additional IEEE-488 Interface Card

UUT can be any GPIB address
Dedicated printer interface if desired

Options "WB-20", "WB-30" and "WB-50" Wideband AC Calibrator Output Card

Bandwidth from 10 Hz to 20 MHz (WB-20), 30 MHz (WB-30), or 50 MHz (WB-50)
Wide output range from -60dBm to +23dBm
Calibrates wideband AC voltmeters, power meters
50 MHz-HP power meters calibration reference frequency

Option "JF5100" Fluke 5100/5101B GPIB Command Card

JF 7411A System software compatible
No software program changes required
Use existing Fluke 5100 procedures, software

Option "DT4700" Datron 4700 Series GPIB Command Card

Datron 4101B System software compatible
No software program changes required

The 2730GS will continue to offer new capabilities in the future; including oscilloscope calibration, bandwidth beyond 500MHz and more. Field retrofits and upgrades are made easy with the Valhalla 2730GS "Calibrator-on-a-Card" design approach.

2730GS DC Voltage (Generation or Measurement)

Accuracy (note 1)

Range	Resol.	Standard 2730GS			2730GS with Option "UP1"		
		24hr ± 1°C Relative	90day ± 5°C Absolute	1year ± 5°C Absolute	24hr ± 1°C Relative	90day ± 5°C Absolute	1year ± 5°C Absolute
22mV**	10nV	2.2ppm ± 0.4uV	6.5ppm ± 0.4uV	9.0ppm ± 0.4uV	1.0ppm ± 0.4uV	3.6ppm ± 0.4uV	5.0ppm ± 0.4uV
220mV	10nV	2.2ppm ± 0.4uV	6.5ppm ± 0.5uV	9.0ppm ± 0.5uV	1.0ppm ± 0.4uV	3.6ppm ± 0.5uV	5.0ppm ± 0.5uV
2.2V	10nV	2.2ppm ± 0.8uV	6.5ppm ± 1.0uV	9.0ppm ± 1.0uV	1.0ppm ± 0.8uV	3.6ppm ± 1.0uV	5.0ppm ± 1.0uV
11V	100nV	0.9ppm ± 2.0uV	4.3ppm ± 2.4uV	6.8ppm ± 2.4uV	0.7ppm ± 2.0uV	3.3ppm ± 2.4uV	4.8ppm ± 2.4uV
22V	100nV	2.1ppm ± 3.8uV	5.5ppm ± 4.5uV	8.0ppm ± 4.5uV	1.0ppm ± 3.8uV	3.6ppm ± 4.5uV	5.0ppm ± 4.5uV
275V	1uV	2.3ppm ± 40uV	5.7ppm ± 50uV	8.2ppm ± 50uV	1.2ppm ± 40uV	3.7ppm ± 50uV	5.2ppm ± 50uV
1200V	10uV	2.6ppm ± 200uV	6.0ppm ± 300uV	8.5ppm ± 300uV	1.7ppm ± 200uV	4.1ppm ± 300uV	5.5ppm ± 300uV

**Generation only

Stability, Linearity, Drive Capability and Noise (note 2)

Range	24 Hour Stability		Linearity	Temperature Coefficient 10-40°C	Drive	Noise 0.01-10Hz Peak-to-Peak
	Standard Unit	Option "UP1"				
22mV	0.8ppm ± 0.3uV	0.35ppm ± 0.3uV	0.1uV	0.5ppm ± 0.05uV/°C	9.08Ω Zo	0.25uV
220mV	0.8ppm ± 0.3uV	0.35ppm ± 0.3uV	0.15uV	0.4ppm ± 0.05uV/°C	8.26Ω Zo	0.25uV
2.2V	0.8ppm ± 0.5uV	0.35ppm ± 0.3uV	0.25uV	0.2ppm ± 0.1uV/°C	70mA peak	0.35uV
11V	0.4ppm ± 1.5uV	0.3ppm ± 0.3uV	1.2uV	0.1ppm ± 0.2uV/°C	70mA peak	1uV
22V	0.8ppm ± 3uV	0.35ppm ± 0.3uV	2.5uV	0.2ppm ± 0.4uV/°C	70mA peak	2uV
275V	0.8ppm ± 25uV	0.35ppm ± 0.3uV	35uV	0.2ppm ± 3uV/°C	70mA peak	20uV
1200V	0.9ppm ± 150uV	0.4ppm ± 0.3uV	200uV	0.3ppm ± 30uV/°C	70mA peak*	100uV

*Reduces linearly above 35°C to 40mA peak at 50°C Ambient.

DC Current

Accuracy (note 1, 3)

Range	Resol.	24hr ± 1°C	90day ± 5°C	1year ± 5°C	Temp. Coeff.
220uA	100pA	15ppm ± 2nA	25ppm ± 2nA	50ppm ± 2nA	3ppm ± 200pA/°C
2.2mA	1nA	8ppm ± 7nA	20ppm ± 10nA	40ppm ± 10nA	3ppm ± 1.5nA/°C
22mA	10nA	8ppm ± 70nA	20ppm ± 100nA	40ppm ± 100nA	3ppm ± 10nA/°C
220mA	100nA	8ppm ± 700nA	20ppm ± 1uA	40ppm ± 1uA	4ppm ± 80nA/°C
2.2A	1uA	13ppm ± 15uA	50ppm ± 20uA	80ppm ± 20uA	8ppm ± 500nA/°C
12A	10uA	80ppm ± 150uA	100ppm ± 200uA	200ppm ± 200uA	15ppm ± 5uA/°C

DC Current

Stability, Linearity, Drive Capability and Noise (note 2)

Range	Stability	Linearity	Compliance Voltage	0.01-10 peak-pe
220uA	6ppm ± 500pA	100pA	10V peak	200pA
2.2mA	4ppm ± 3nA	1nA	10V peak	1nA
22mA	3ppm ± 25nA	15nA	9V peak	10nA
220mA	4ppm ± 250nA	200nA	7V peak	80nA
2.2A	6ppm ± 2.5uA	4uA	3V peak	800nA
12A	10ppm ± 50uA	100uA	2V peak	100uA

Resistance 2730GS with Option "UP-1"

Accuracy (note 5)

Nominal Value	Deviation from Nom.	Max. Current	90 days ± 5°C	1 year ± 5°C	Voltage Offset	Temp. Coef.	Power Coef.	24 Hour Stability ± 1°C
Short	500uΩ	500mA	50uΩ	50uΩ	1.5uV	5ppm/°C	0.5ppm/mW	25ppm
1Ω	500uΩ	500mA	70ppm	90ppm	1.5uV	3ppm/°C	0.3ppm/mW	23ppm
10Ω	5mΩ	160mA	35ppm	45ppm	1.5uV	2ppm/°C	0.2ppm/mW	12ppm
100Ω	25mΩ	50mA	17ppm	25ppm	1.5uV	1.5ppm/°C	0.15ppm/mW	6ppm
1KΩ	100mΩ	16mA	12ppm	15ppm	1.5uV	1.5ppm/°C	0.15ppm/mW	4ppm
10KΩ	1Ω	5mA	10ppm	13ppm	1.5uV	1.5ppm/°C	0.15ppm/mW	6ppm
100KΩ	25Ω	1.6mA	10ppm	13ppm	2uV	3ppm/°C	0.5ppm/mW	8ppm
1MΩ	500Ω	300uA	20ppm	30ppm	6uV	5ppm/°C	1ppm/mW	15ppm
10MΩ	5KΩ	30uA	35ppm	45ppm	50uV	10ppm/°C	10ppm/mW	30ppm
100MΩ	100KΩ	3uA	95ppm	120ppm	500uV			

2730GS AC Voltage (Generation or Measurement)

Accuracy

Accuracies are for the temperature range shown, from the previous 2730GS calibration temperature and are **absolute specifications**. It should be noted that these figures include the

effects of load and line regulation, linearity, noise and temperature coefficient. These accuracy figures also assume the use of the 2730GS Internal Calibration function at least every 90 days.

Range	Resolution	Frequency	24hr ± 1°C	90day ± 5°C	1year ± 5°C
22mV*	10nV	10-30Hz 30-50Hz 50Hz-30kHz 30-100kHz 100-300kHz 300-600kHz 600-1250kHz	220ppm ± 5uV 120ppm ± 5uV 100ppm ± 5uV 120ppm ± 8uV 400ppm ± 15uV 0.1% ± 30uV 0.2% ± 35uV	235ppm ± 5uV 135ppm ± 5uV 115ppm ± 5uV 135ppm ± 8uV 450ppm ± 15uV 0.15% ± 30uV 0.3% ± 35uV	250ppm ± 5uV 150ppm ± 5uV 130ppm ± 5uV 150ppm ± 8uV 465ppm ± 15uV 0.15% ± 30uV 0.3% ± 35uV
220mV*	10nV	10-30Hz 30-50Hz 50Hz-30kHz 30-100kHz 100-300kHz 300-600kHz 600-1250kHz	210ppm ± 8uV 110ppm ± 8uV 90ppm ± 8uV 110ppm ± 10uV 400ppm ± 15uV 0.1% ± 30uV 0.2% ± 35uV	225ppm ± 8uV 125ppm ± 8uV 105ppm ± 8uV 125ppm ± 10uV 450ppm ± 15uV 0.15% ± 30uV 0.3% ± 35uV	240ppm ± 8uV 140ppm ± 8uV 120ppm ± 8uV 140ppm ± 10uV 465ppm ± 15uV 0.15% ± 30uV 0.3% ± 35uV
2.2V(22V)	100nV(1uV)	10-30Hz 30-50Hz 50-30kHz 30-100kHz 100-300kHz 300-600kHz 600-1250kHz	200ppm ± 20uV(± 150uV) 90ppm ± 20uV(± 150uV) 50ppm ± 20uV(± 150uV) 100ppm ± 30uV(± 250uV) 250ppm ± 100uV(± 1mV) 0.1% ± 200uV(± 2mV) 0.2% ± 400uV(± 4mV)	215ppm ± 20uV(± 150uV) 105ppm ± 20uV(± 150uV) 65ppm ± 20uV(± 150uV) 125ppm ± 30uV(± 250uV) 300ppm ± 100uV(± 1mV) 0.15% ± 200uV(± 2mV) 0.25% ± 400uV(± 4mV)	230ppm ± 20uV(± 150uV) 120ppm ± 20uV(± 150uV) 80ppm ± 20uV(± 150uV) 140ppm ± 30uV(± 250uV) 315ppm ± 100uV(± 1mV) 0.15% ± 200uV(± 2mV) 0.25% ± 400uV(± 4mV)
220V	10uV	10-30Hz 30-50Hz 50Hz-30kHz 30-100kHz 100-300kHz 300-600kHz 600-1250kHz	200ppm ± 800uV 90ppm ± 800uV 60ppm ± 800uV 150ppm ± 1.5mV 350ppm ± 5mV 0.25% ± 10mV 0.5% ± 20mV	215ppm ± 800uV 105ppm ± 800uV 75ppm ± 800uV 200ppm ± 1.5mV 500ppm ± 5mV 0.4% ± 10mV 0.85% ± 20mV	230ppm ± 800uV 120ppm ± 800uV 90ppm ± 800uV 215ppm ± 1.5mV 515ppm ± 5mV 0.4% ± 10mV 0.85% ± 20mV
1100V	100uV	10-30Hz 30-50Hz 50Hz-30kHz 30-100kHz 100-300kHz 300-1000kHz	200ppm ± 4mV 100ppm ± 4mV 80ppm ± 4mV 110ppm ± 10mV 120ppm ± 6mV 400ppm ± 10mV	215ppm ± 4mV 115ppm ± 4mV 100ppm ± 4mV 125ppm ± 10mV 160ppm ± 6mV 500ppm ± 10mV	230ppm ± 4mV 130ppm ± 4mV 115ppm ± 4mV 140ppm ± 10mV 175ppm ± 6mV 515ppm ± 10mV

AC Current

Accuracy

The accuracies shown below are for the temperature range shown, from the temperature at which the 2730GS was previously calibrated, and are absolute specifications. It should be noted that these figures include the effects of load and line regulation, linearity, noise and temperature coefficient, and also

assume the use of the Internal Calibration function of the 2730GS at least every 90 days.

Drive Capability and Noise

The distortion figures given below are measured at a nominal 0.5V compliance using a current shunt having a passive response to at least 1MHz, and are measured using a 10HZ to 100KHz bandwidth.

Range	Resol.	Frequency	24hr ± 1°C	90day ± 5°C	1year ± 5°C	Compliance Voltage	Distortion
220uA	1nA	10-30Hz 30Hz-10kHz 10-30kHz*	200ppm ± 6nA 150ppm ± 10nA 500ppm ± 50nA	250ppm ± 6nA 200ppm ± 10nA 550ppm ± 50nA	300ppm ± 6nA 250ppm ± 10nA 600ppm ± 50nA	10V peak 10V peak	0.1% ± 50nA 0.15% ± 50nA
2.2mA	10nA	10-30Hz 30Hz-10kHz 10-30kHz*	120ppm ± 10nA 80ppm ± 10nA 300ppm ± 50nA	170ppm ± 10nA 130ppm ± 10nA 350ppm ± 50nA	220ppm ± 10nA 180ppm ± 10nA 400ppm ± 50nA	10V peak 9V peak	0.1% ± 12nA 0.18% ± 120nA
22mA	100nA	10-30Hz 30Hz-10kHz 10-30kHz*	100ppm ± 100nA 70ppm ± 100nA 200ppm ± 200nA	150ppm ± 100nA 120ppm ± 100nA 250ppm ± 200nA	200ppm ± 100nA 170ppm ± 100nA 300ppm ± 200nA	9V peak 8V peak*	0.1% ± 1uA 0.2% ± 1uA
220mA	1uA	10-30Hz 30Hz-10kHz 10-30kHz*	125ppm ± 1uA 100ppm ± 1uA 300ppm ± 5uA	175ppm ± 1uA 150ppm ± 1uA 350ppm ± 5uA	225ppm ± 1uA 200ppm ± 1uA 400ppm ± 5uA	7.5V peak 7V peak 5V peak*	0.1% ± 10uA 0.35% ± 100uA 0.25% ± 10uA
2.2A	10uA	10-30Hz 30Hz-10kHz 3-10kHz* 10-20kHz*	225ppm ± 10uA 200ppm ± 10uA 250ppm ± 20uA 500ppm ± 50uA	275ppm ± 10uA 250ppm ± 10uA 300ppm ± 20uA 550ppm ± 50uA	325ppm ± 10uA 300ppm ± 10uA 350ppm ± 20uA 600ppm ± 50uA	3V peak 2.5V peak 1.5V peak	0.15% ± 100uA 0.35% ± 100uA 0.8% ± 100uA
12A	100uA	10-30Hz 30Hz-1kHz 1-5kHz* 1-5kHz* 5-10kHz*	500ppm ± 100uA 450ppm ± 100uA 650ppm ± 500uA 0.1% ± 1mA 0.4% ± 5mA	600ppm ± 100uA 550ppm ± 100uA 750ppm ± 500uA 0.12% ± 1mA 0.4% ± 5mA	650ppm ± 100uA 850ppm ± 500uA 0.13% ± 1mA 0.4% ± 5mA	3V peak 2.5V peak 1V peak	0.25% ± 1mA 0.5% ± 1mA 0.8% ± 1mA

*Denotes Option "UP-1"

2730GS Calibrator Abbreviated Specifications

Distortion AC Voltage

The distortion figures below are measured with a 10Hz to 10MHz bandwidth and are for loads less than 10% of the maximum allowed.

Frequency	Standard 2730GS 22mV through 22V Ranges	220V Range	Option "UP1" 22mV through 22V Ranges	220V Range
10-30Hz	0.05% of output + 0.01% of range + 10mV	0.05% of output + 25mV	0.04% of output + 0.01% of range + 10uV	0.04% of output + 25mV
30Hz-5KHz	0.035% of output + 0.01% of range + 10mV	0.035% of output + 25mV	0.01% of output + 0.01% of range + 10uV	0.01% of output + 25mV
5-20KHz	0.035% of output + 0.01% of range + 15mV	0.035% of output + 25mV	0.01% of output + 0.01% of range + 15uV	0.01% of output + 25mV
20-50KHz	0.05% of output + 0.01% of range + 15mV	0.05% of output + 25mV	0.04% of output + 0.01% of range + 15uV	0.04% of output + 25mV
50-100KHz	0.08% of output + 0.01% of range + 20mV	0.1% of output + 25mV	0.08% of output + 0.01% of range + 20uV	0.1% of output + 25mV
100-300KHz	0.3% of output + 0.025% of range + 30mV	0.5% of output + 50mV	0.3% of output + 0.025% of range + 30uV	0.5% of output + 50mV
300-1250KHz	1.1% of output + 0.05% of range + 35mV	1.5% of output + 50mV	1.1% of output + 0.05% of range + 35uV	1.5% of output + 50mV

Measurement Technique (Option "RMS")

The displayed value is obtained by an AC-DC thermal comparator (for frequencies above 40Hz) and is thus the true RMS value of the applied waveform. The user may enter the nominal amplitude and frequency data, both will be measured by the 2730GS and displayed. The user may optionally (mandatory if the input frequency is below 40Hz) select for an RMS scaled amplitude measurement.

Input Impedance (Measurement Option "RMS" only)	
Range	Impedance
2.2V	5KΩ in parallel with 100pF
22V	50KΩ in parallel with 100pF
220V	500KΩ in parallel with 100pF
1100V	5MΩ in parallel with 100pF

Minimum and Maximum Output Levels

The minimum output level is 100uV at all frequencies, the maximum output level into 50Ω is 3.5V RMS or 10⁷VHz, whichever is smaller.

AC (Wideband) Voltage

Accuracy (10Hz to 1.25MHz)

The accuracies shown below are for the temperature range shown, from the temperature at which the 2730GS was previously calibrated and are absolute

specifications. It should be noted that these figures all include the effects of load and line regulation, linearity, noise and temperature coefficient. These accuracy figures also assume the use of the Internal Calibration function of the 2730GS at least every 90 days. These figures assume the use of a 50Ω termination and the use of the supplied coaxial cable set.

dBm Range	dBm Resolution	Volt Range	Volt Resolution	Accuracy		
				24hr ± 1°C	90day ± 5°C	1year ± 5°C
-47dBm	0.001dBm	1mV	1nV	0.2% ± 2uV	0.3% ± 2uV	0.3% ± 2uV
-37dBm	0.001dBm	3.5mV	10nV	0.2% ± 3uV	0.3% ± 3uV	0.3% ± 3uV
-27dBm	0.001dBm	10mV	10nV	0.2% ± 5uV	0.3% ± 5uV	0.3% ± 5uV
-17dBm	0.001dBm	35mV	100nV	0.2% ± 8uV	0.3% ± 8uV	0.3% ± 8uV
-7dBm	0.001dBm	100mV	100nV	0.2% ± 40uV	0.3% ± 40uV	0.3% ± 40uV
+ 3dBm	0.001dBm	350mV	1uV	0.2% ± 100uV	0.3% ± 100uV	0.3% ± 100uV
+ 13dBm	0.001dBm	1V	1uV	0.15% ± 300uV	0.2% ± 300uV	0.2% ± 300uV
+ 24dBm	0.001dBm	3.5V	10uV	0.1% ± 500uV	0.15% ± 500uV	0.15% ± 500uV

Amplitude Flatness and Distortion

The figures shown below are referenced to a 1kHz reference level obtained into a 50Ω termination at the end of the supplied coaxial cable set, and apply for temperatures within ± 5°C of the calibration temperature, and for a period of 1 year following calibration. The harmonic distortion figures are measured using a spectrum analyzer over a 50MHz bandwidth (Options "WB20" and "WB30" or 100MHz (Option "WB50").

Amplitude	Option	Frequency	Flatness	Harmonic Distortion
100uV-35mV	WB-20 WB-30 WB-50	10Hz-1.25MHz	0.15% ± 1.5uV	-40dB
		1.25-10MHz	0.2% ± 3uV	-40dB
		10-20MHz	0.4% ± 8uV	-40dB
		20-30MHz	0.9% ± 15uV	-34dB
35mV-100mV	WB-20 WB-30 WB-50	10Hz-1.25MHz	0.1%	-40dB
		1.25-10MHz	0.15%	-40dB
		10-20MHz	0.35%	-40dB
		20-30MHz	0.75%	-34dB
100mV-1V	WB-20 WB-30 WB-50	10Hz-1.25MHz	0.08%	-40dB
		1.25-10MHz	0.12%	-40dB
		10-20MHz	0.3%	-40dB
		20-30MHz	0.65%	-34dB
1-3.5V	WB-20 WB-30 WB-50	10Hz-1.25MHz	0.08%	-40dB
		1.25-10MHz	0.1%	-40dB
		10-20MHz	0.25%	-40dB
		20-30MHz	0.6%	-34dB
		30-50MHz	1.5%	-28dB

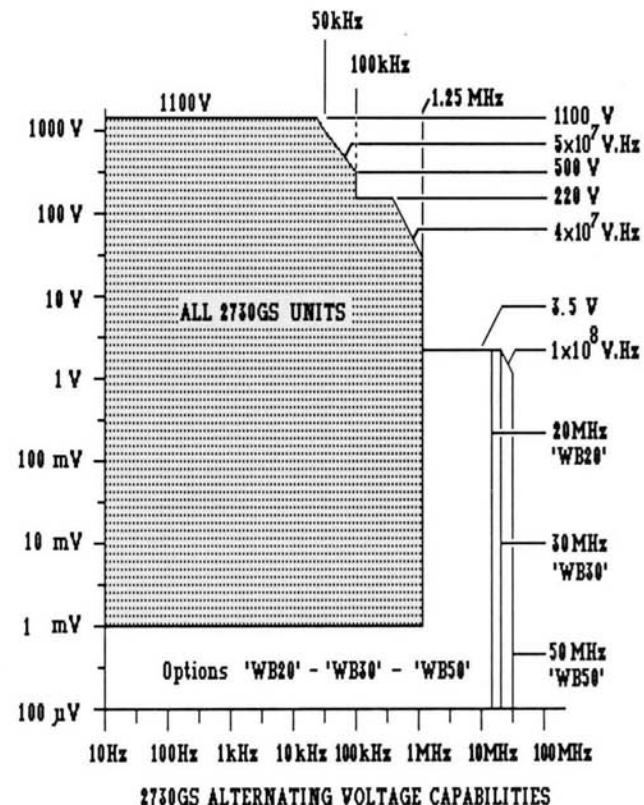

2730GS Calibrator Abbreviated Specifications

Phase (Voltage and/or Current)

One or more channels may be 'phase slaved' to a single 'master channel' to produce an output at the same frequency as the 'master channel' but at a controlled phase from it. This phase relationship may be between a pair of voltage outputs, a pair of current outputs, or between a voltage and a current output. It is also possible for each of the two channels to be either in the same unit or within separate units. It should be noted that the two channels within a single unit MUST be phase locked (i.e., one master and one slave, or both slaves to an external master). The overall accuracy of the phase relationship between the two outputs is given by the addition of each channels' accuracies shown below, these are valid for temperatures within $\pm 5^{\circ}\text{C}$ of the Internal Calibration temperature, and within 24 hours of an Internal Calibration.

External Phase Sync. (either master or slave)	$0.005^{\circ} \pm 0.003^{\circ}/\text{kHz}$
Voltage Output (22V)	$0.003^{\circ} \pm 0.0005^{\circ}/\text{kHz}$
Voltage Output (220V)	$0.003^{\circ} \pm 0.0015^{\circ}/\text{kHz}$
Voltage Output (1100V)	$0.003^{\circ} \pm 0.002^{\circ}/\text{kHz}$
Current Output (220uA)	$0.003^{\circ} \pm 0.008^{\circ}/\text{kHz}$
Current Output (22mA)	$0.003^{\circ} \pm 0.002^{\circ}/\text{kHz}$
Current Output (220mA)	$0.003^{\circ} \pm 0.005^{\circ}/\text{kHz}$
Current Output (2.2A)	$0.003^{\circ} \pm 0.008^{\circ}/\text{kHz}$
Current Output (12A)	$0.003^{\circ} \pm 0.0015^{\circ}/\text{kHz}$

Resolution

The resolution with which the phase shift may be set is 0.001° at any frequency/phase. The phase and amplitude may be set by means of any combination of data units which allows the extraction of both amplitude and phase data.

Note 1:

The accuracies shown are for the temperature range shown from the temperature at which the 2730GS was previously calibrated. The 24 hour figures are relative to the calibration standards used, while the 90 day and 1 year figures are **absolute specifications**. It should be noted that these figures all include the effects of load and line regulation, linearity, noise and temperature coefficient.

Note 2:

The stability figures are for a 24 hour period following stabilization, at a constant line voltage and load, and in a constant environment within $\pm 1^{\circ}\text{C}$, with no Internal Calibration functions used. The **Linearity figures** are the deviation from a "straight line" between the actual full-scale and zero values on the given range. The temperature coefficient does not apply unless the 2730GS is operating more than $\pm 5^{\circ}\text{C}$, and also assumes the use of the Internal Calibration function.

Note 3:

These accuracy figures also assume the use of the 2730GS Internal Calibration function at least every 90 days (Option "UP1") or 7 days (Standard 2730GS).

Note 4:

All Voltage functions may be calibrated using the Internal Calibration function of the 2730GS, additionally up to 500 external calibration points may be added by the user. At within 0.1% of any of these calibration points the above accuracy figures may be reduced by 50% (0.4 ppm for D.C. Voltage) of the figures shown (plus any additional absolute traceability errors due the calibration equipment used).

Note 5:

The accuracies shown are for the temperature range shown, from the temperature at which the 2730GS was previously calibrated, and are absolute specifications for measurement currents below 10% of the indicated maximum current. It should be noted that these figures all include the effects of load and line regulation, noise and temperature coefficient. The specifications shown are for the values provided by the standard unit and for Option "R19A" (or "R19S"), other values are also available, contact Valhalla Scientific Inc. for details and specifications. The specifications shown are for use in 4-wire mode, separate calibration data is obtained for 2-wire mode which may include the users cables, the displayed value will thus indicate the actual 2-wire or 4-wire value as required. Add an additional $5\text{m}\Omega$ to the accuracy figures when operating in the 2-wire mode.

Input Impedance (Measurement Options "RMS" only)

Range	Impedance
2.2V	$10^{11}\ \Omega$
11V	$10^{11}\ \Omega$
22V	$100\text{K}\ \Omega$
275V	$2.35\text{M}\ \Omega$
1200V	$5\text{M}\ \Omega$

Terminals

Selectable 2-wire or 4-wire operation, selectable internally or externally driven Guard terminal. AC Voltages below 1.25MHz optionally available from a $50\ \Omega$ output type 'N' connector, outputs above 1.25MHz available from an optional $50\ \Omega$ standard type 'N' connector. Driven guard outputs are available for both output terminals in DC and AC current output modes to reduce the effect of cable leakage and capacitance. Active terminals and connectors are indicated by LED illumination. The externally driven Guard may be up to 20V peak from the SENSE LO terminal, SENSE LO and/or BNC shield connections may be up to 100V peak from chassis ground.

General

Power: 105-130V or 210 to 260V RMS AC 45 to 65Hz @ 400VA

Temperature: 0 to 50°C (Operating), -40 to $+75^{\circ}\text{C}$ (Storage)

Dimensions: 7" (height) x 17.9" (width) x 25" (depth)

Weight: 65lbs.

Safety: Designed to UL 1244 and IEC348 (BS4743) standards

Warranty: 1 year (full), 3 years (limited)

Output Terminals: Selectable 2-wire or 4-wire operation, with selectable internal or externally driven Guard. AC voltage also available from floating $50\ \Omega$ output. Driven Guard outputs available in Current output modes for cable capacitance and leakage guarding.

Vibration: Meets MIL-T-28800D Class V, Style E

E.M.I.: Meets MIL-T-28800D requirements for Class V equipment.

Interfacing: IEEE-488 (standard)—RS232C optional
Valhalla VSIB optional.

Ordering Information

2730GS	Precision Multi-Function Calibrator	\$17,995
Option "UP1"	Ultra Precision Performance Package (2 ppm DC, 10 ppm frequency, 30 KHz, Wideband current)	3,995
Option "Watts"	Wattmeter Calibration Capability (0-12A)	4,995
Option "Phase"	Phase Angle Calibration (220V max. Ch. 2)	5,995
Option "WB-20"	20MHz Wideband Output	2,995*
Option "WB-30"	30MHz Wideband Output	3,495*
Option "WB-50"	50MHz Wideband Output	3,995*
Option "R19A"	Adds 1.9 Value Decade Resistors	1,495*
Option "R19S"	Substitutes 1.9 Decade Resistors for 1.0 Values	N/C
Option "APD"	Simultaneous AC & DC Output Capability	995
Option "RMS"	Precision AC/DC Thermal RMS Measurement	1,995

INTERFACES

(rear panel, plug-in accepts up to 4 at a time)		
Option "IEEE"	Additional IEEE-488 Talk/Listen/controller	395
Option "JF5100"	Fluke 5100 GPIB Command Translator	695
Option "DT 4700"	Datron 4700 Series GPIB Command Translator	695
Option "RS232"	RS232C Interface	395
Option "VSIB"	High noise immunity Valhalla Scientific Interface	395
Option "PAR"	Parallel (Centronics) Printer Interface	295
Option "PRO-2"	"Memory Step" extension (200 steps)	295
Option "RES-5"	Non-volatile Test Results Storage (500 tests)	495
Option "EXT-1"	Inter-unit phase lock interface (single channel)	1,295
Option "EXT-2"	Inter-unit phase lock interface (dual channel)	595
Option "IO-2"	Dual Analog Output (variable span)	495
Option "TCA-1"	Transconductance Amplifier Interface (0-2V)	395

ACCESSORIES

Option "LTB-48"	Low Thermal EMF Banana Leads	75
Option "SL-48"	Low Thermal EMF Spade Lug Leads	55
Option "R7"	Rack Mount adaptor kit	70
Option "RH-2"	Extra set of handles (front or rear)	25
Option "SP-2"	Two year spares kit	750
Manual	(Additional)	195

*Not compatible with Option "Watts" or "Phase"

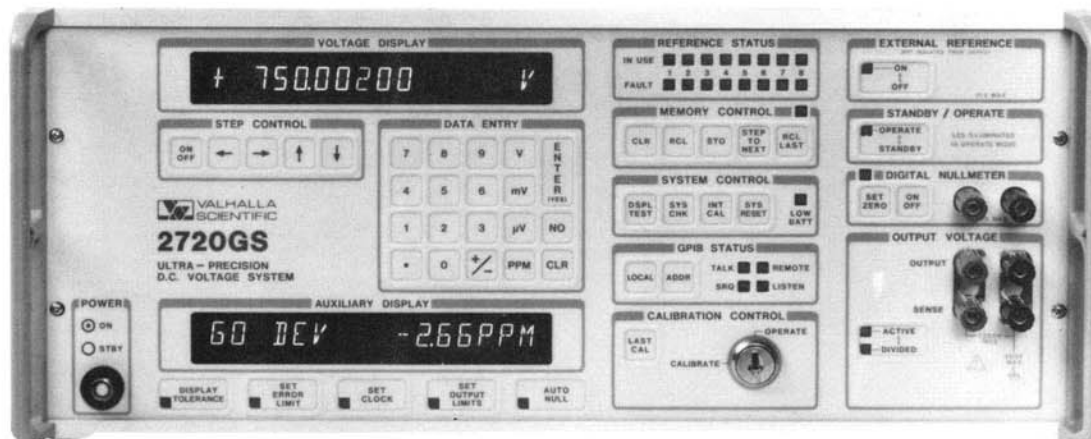

NSN 6625-01-209-2129

U.S. Navy Accepted MECCA II Direct Voltage Standard

The Valhalla 2720GS has been approved and fully accepted as the U.S. Navy MECCA II Direct Voltage Standard. In 1987 Valhalla provided five first article 2720GS DC Systems to the U.S. Navy for compliance testing to MIL-T-28800C for EMI, RFI, accuracy, maintainability and 60 days of vibration failure analysis. Not only were all five units fully approved, but since 1987 Valhalla has shipped over 125 systems which the U.S. Navy accepted for the MECCA II program.

Valhalla's 2720GS- The Calibrator's Calibrator

The 2720GS delivers the performance required to calibrate the world's most accurate 7½ and 8½ digit DVM's yet does even more. It also contains an on-board autoranging digital nullmeter which permits the 2720GS to directly calibrate our competition's best DC voltage calibrators. With our built-in Auto Null™ function, one touch is all that is required for the 2720GS to achieve a null with the DC source being calibrated. In the Auto-Null™ mode the 2720GS auxiliary read-out simultaneously displays the error of the unit under test (UUT) out to 0.01 PPM as well as the UUT's pass/fail status.

The 2720GS offers the best accuracy of any DC calibrator on the market, but we didn't stop there; our demanding internal divider design has resulted in the lowest temperature coefficient of any DC Standard anywhere. So low in fact, that our 1.6ppm thirty day accuracy is specified for ±6°C from the calibration temperature.

Direct 2720GS Calibration Routine Reduces Traceability Uncertainty

The calibration of the 2720GS requires only one external instrument (a 1V/10V reference standard). This simplification of the calibration process and resulting reduction in traceability uncertainty is made possible through the use of the system's internal reference divider and on-board digital null detector. No other DC system offers this level of performance and support in one package.

To conquer drift against time, the 2720GS utilizes an internal real time clock and an ingenious on-board multi-reference monitoring system. The system's internal 30 bit A to D converter continually monitors each of the eight internal highly stabilized reference zeners. Each reference module contains its own non-volatile memory which stores calibration and drift rate data.

2720GS Configuration Guide

- Autoranging Digital Nullmeter
- 1 Touch Auto-Null™ Function
- IEEE-488 Interface
- Multi-reference Monitoring System
- Real Time Clock (12/24 hr)
- Dual Alpha-numeric Displays
- Step Control with Auto-Repeat
- Display Tolerance Function
- UUT Deviation
- Divided Output
- Local and Remote Sensing
- Vari-Safe™ Output Format
- Front-Panel Calibration Keylock
- 30 Day Internal Cal
- Covers-On External Cal
- Built-In 550 Step Memory Control System
- Bipolar Output 10nV to 1200V
- 30 Day Accuracy: 1.6 PPM
- 24 Hour Stability: 0.25 PPM
- Linearity: ±0.3 PPM
- Accuracy Valid ±6°C from Calibration Temperature
- 100mA Current Sourcing
- Resolution: 0.01 PPM
- Automatic Output Ranging
- Self-Diagnostics
- Front-Panel GPIB Address Selection and Display
- Selectable Current Limits
- GPIB Status Indicators
- UUT Error Limit
- UUT Calibration Status
- Display Test
- Time Since Last Cal
- Twin Microprocessors
- Optional Reference System Battery Back-up
- Optional External Reference Modules



2720GS Abbreviated Specifications



Performance Characteristic Table

The accuracy specifications are valid for $\pm 6^{\circ}\text{C}$ from the calibration temperature within 10 to 35°C . The values stated below include the effects of line, load and temperature

variations within the above window and require the use of Internal Calibration every 30 days. To derive absolute accuracies relative to the National Bureau of Standards add 1.5ppm for Valhalla Scientific's traceability and transfer uncertainty.

2720GS Accuracy (ppm of setting \pm uV)					Settling Time		
Range	30day	90day	180day	1year	10ppm	5ppm	2ppm
650mV*	2.0+0.2	2.3+0.2	2.8+0.2	3.7+0.2	500mS	2 Sec.	10 Sec.
1300mV*	2.2+0.3	2.5+0.3	3.0+0.3	3.9+0.3	500mS	2 Sec.	10 Sec.
0.65V	2.0+0.3	2.3+0.3	2.8+0.3	3.7+0.3	500mS	2 Sec.	8 Sec.
1.3V	2.2+0.4	2.5+0.4	2.0+0.4	3.9+0.4	500mS	2 Sec.	8 Sec.
6.5V	1.4+1.2	1.7+1.2	2.2+1.2	3.0+1.2	300mS	1 Sec.	5 Sec.
13V	1.6+2.3	1.9+2.3	2.4+2.3	3.2+2.3	300mS	1 Sec.	5 Sec.
26V	2.1+5.0	2.4+5.0	2.9+5.0	3.7+5.0	600mS	3 Sec.	10 Sec.
13V	1.6+2.3	1.9+2.3	2.4+2.3	3.2+2.3	600mS	3 Sec.	10 Sec.
65V	2.2+15	2.5+15	3.0+15	3.9+15	600mS	3 Sec.	10 Sec.
130V	2.4+30	2.7+30	3.2+30	4.1+30	600mS	3 Sec.	10 Sec.
600V	2.4+150	2.7+150	3.2+150	4.1+150	800mS	3 Sec.	10 Sec.
1200V	2.7+300	3.0+300	3.5+300	4.4+300	800mS	3 Sec.	10 Sec.

*Divided output ($Z_o = 450\text{ohm}$)

For range and/or polarity change, add 1 second.

Digital Nullmeter/Measurement Performance Table

The measurement accuracy is the overall 90 day $\pm 6^{\circ}\text{C}$ specification of a 2720GS when used to measure an unknown

voltage using "AUTO NULL" with the division ratio entered as 0.5 (see 4.1). The Linearity of the 2720GS is defined as the maximum allowable deviation from a straight line between the zero and full-scale outputs on each range.

Range	Resolution	Measurement Accuracy	Maximum Current	Wideband Noise 10Hz-10KHz	Linearity
650mV	10nV	2.9ppm + 0.3uV	---	10uV RMS	0.14uV
1300mV	10nV	3.1ppm + 0.4uV	---	10uV RMS	0.26uV
0.65V	10nV	2.9ppm + 0.4uV	100mA	30uV RMS	.22uV
1.3V	10nV	3.1ppm + 0.5uV	100mA	30uV RMS	0.32uV
6.5V	10nV	2.0ppm + 1.3uV	100mA	30uV RMS	0.9uV
13V	100nV	2.2ppm + 2.4uV	100mA	30uV RMS	1.8uV
26V	100nV	2.7ppm + 5.1uV	100mA	50uV RMS	3.6uV
65V	100nV	3.1ppm + 15uV	100mA	150uV RMS	10uV
130V	1nV	3.3ppm + 30uV	100mA	150uV RMS	18uV
600V	1nV	3.3ppm + 150uV	30mA	300uV RMS	85uV
1200V	10nV	3.5ppm + 300uV	30mA	300uV RMS	165uV

*Add 20uV RMS if a current limit $>15\text{mA}$ is selected

Real Time Clock/Calendar

Accuracy: 2 ppm ($0^{\circ} - 50^{\circ}$)
Format: 12 or 24 hr., Mo/Day/Yr or Day/Mo/Yr user selectable
Battery Back-up: 5000 hours with no power applied
Daylight Savings Time: User selectable

General

Warm-up Time: 5 minutes to within 5 ppm of final value, (times 2 if battery back-up not used).
IEEE-488 Configuration: SH1AH1T6TE6L4LE4SR1RL1PP2C1DT1C0 (Talk/listen sub-addressable)
Power: 115/230 VAC 50-400 Hz, 125 VA
Size: 178mm H x 432mm W x 483mm D (7"x17"x19")
Weight: 23KG/48 lbs. net, 25KG/55 lbs. shipping
Environmental: MIL-T-28800C tested and approved.

Ordering Information

Model 2720GS	Direct Voltage System	\$10,995.00
Option "54-4T"	Lower Cost/Reduced Performance	(-2000.00)
Option "BAT"	Battery Back-up System	595.00
Option "RP-20"	Rear Panel I/O Terminals	195.00
Option "EXR1"	1V External Reference Module	995.00
Option "EXR10"	10V External Reference Module	995.00
Option "GP-1"	1 Meter GPIB Cable	95.00
Option "GP-2"	2 Meter GPIB Cable	115.00
Option "RX7"	Rack Mount Kit	60.00
Option "BBL"	Dual Banana Shielded Leads	25.00
Option "SL-48"	Gold Surfaced Spade Lug Leads	55.00
Option "SP-2"	2 Year Spare Parts Kit	395.00
Additional	Operating/Maintenance Manual	65.00

Primary Direct Voltage Reference Standard

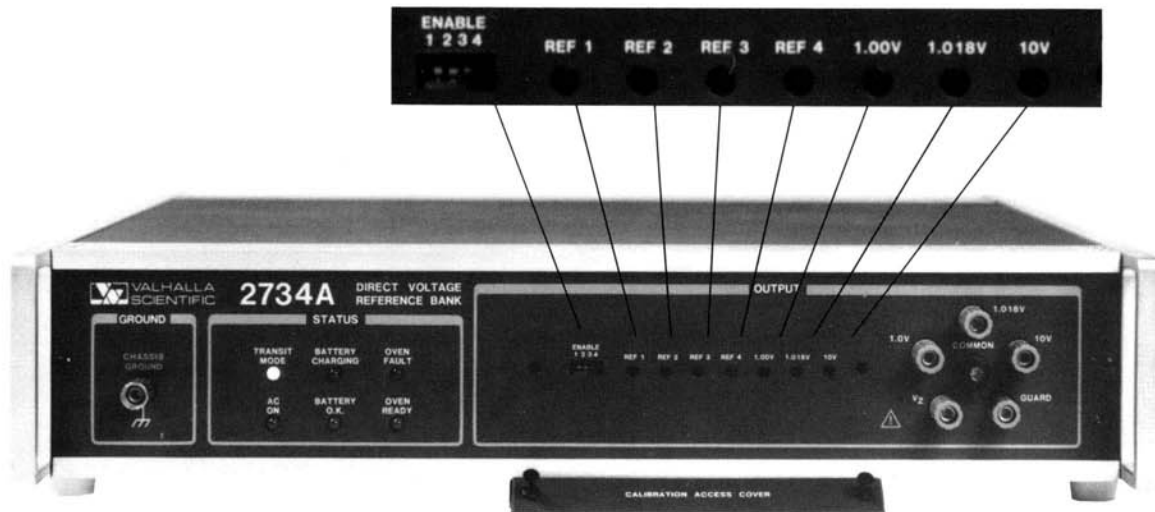

When Valhalla Scientific set out to build a better direct voltage reference standard, we started with the U.S. National Bureau of Standards and other world renowned metrologists to find out the shortcomings of existing technologies. The overwhelming response was two resounding concerns.

First was the need for absolute integrity, achievable only through a multi-cell configuration which is independently verifiable. Secondly was a need for ultra-low noise zener diodes to reduce transfer uncertainties and permit meaningful, repeatable measurements to occur in the sub 0.1 ppm region. To accomplish this objective, a team of the top U.S. semiconductor design engineers was assembled and a new breed of ultra-low noise zener diode was created. We call this semiconductor technology the "ULTRA-ZENER"[™], and it's the heart of our new 2734A Direct Voltage Reference Bank.

Higher Resolution, Lower Noise and Easier to Use Than Standard Cells

By providing the higher 7V and 10V outputs, the effects of noise and thermal E. M. F.'s are reduced by a factor of 10:1. The 1V and 1.018V outputs provide lower voltage calibration convenience and compatibility with standard cell levels. All output binding posts are constructed of gold plated tellurium copper for ultra low thermal E.M.F. performance.

Front Panel Reference Selection is as Easy as 1, 2, 3, 4

The superior performance of the 2734A makes it ideal for direct replacement of saturated standard cells. Yet, like the standard cell bank, the 2734A provides four independent cells, so that the precise status of each reference can be easily verified through intercomparison. **Any combination of references may be conveniently selected from the front panel.** High resolution front panel calibration of each range (0.02ppm adjustability) is achieved via precision Vishay potentiometers.

The Valhalla 2734A is a solid state, direct voltage reference bank which offers significant performance improvements in stability, ruggedness, and

transportability. It's 10V output provides better resolution, lower noise, and simpler handling and operation than saturated standard cells.

The 2734A may be shorted, even for extended periods of time, without damage and recovers without loss of stability.

The internal references use an oven in an oven or double thermal barrier design. This approach provides a high thermal gain which allows full rated accuracy to be specified over an operating range of $23^{\circ}\text{C} \pm 5^{\circ}\text{C}$.

Automated Drift Analysis Available

By ordering option "2734A-90", a new 2734A will be provided with calibrated output levels and a characterized drift rate before shipment from Valhalla. Your new 2734A will be tested for both output voltage and drift rate by comparison against traceable standards for a period of 90 days in the Valhalla Primary Standards Laboratory. With an established drift rate, the total uncertainty as a function of time is much reduced.

Option number	Transfer uncertainty	Maximum deviation from established drift rate		
		30 days	90 days	1 year
2734A-90	0.5 ppm	0.35 ppm	0.5 ppm	1.5 ppm

Problems Associated With a Single DV Reference

It is a fact that the Fluke 732A is a single DV reference design. There is an inherent risk associated with using any manufacturer's single reference Direct Voltage Standard. A single reference may be stable for years, aged, computer selected, etc., however when it comes time to receive it at your facility, unforeseen events can occur.

Single referenced DV manufacturers often claim, "Don't worry, our reference doesn't drift, and we can ship you, hot, another single reference as a comparison." Again, one **assumes** the fresh, new single reference unit is ok, or is it?

Primary Direct Voltage Reference Standard



Valhalla's 2734A production evaluation tests are measured in an environmentally controlled primary standard laboratory. Literally hundreds of measurements are ratiometrically intercompared against Valhalla's multi-banked, multi-referenced primary standard array. This

automated system takes one hundred readings per hour, 24 hours a day for several months-worth of drift history analysis on every Valhalla 2734A.

Solutions Associated With Multiple DV References

The Valhalla 2734A has four independent references (not four zeners in some averaging circuit). The advantages of multiple references can be seen from data shown on a sample 2734A calibration analysis report.

The random chance or probability of two or more references shifting to different values is significantly lower or less likely to happen than the chances of such an event occurring with a single reference. The beauty of a multiple reference system is that of "detectability"; detecting a given reference changing value is clearly measurable by inter-comparison between each of the four independent references contained in the Valhalla 2734A. Any combination of Valhalla 2734A references 1 + 4, 2 + 3, 1 + 2 and 3 + 4 may be enabled behind the calibration access cover and measured at the 2734A front terminals.

What are the advantages of a single DV Reference over a multiple referenced based system such as the Valhalla 2734A? **There are none** other than the opportunity the single referenced standard manufacturer has to sell you more than one of them.

The single reference standard had one value when it left your national standards laboratory or the manufacturer, but it has a different value (unknown) after shipping (i.e., transportation shock) to your facility. To overcome this limitation, the single referenced manufacturers will recommend that you purchase three or four more single reference based Direct Voltage Standards for comparison.

After it is all said and done, the only way to **avoid the mistake of assuming a single referenced standard has the same value** before it is shipped as after you receive it, requires another reference standard. If there is a discrepancy between the two references which one is correct? A third reference would seem in order to settle the measurement dispute. Throw in a fourth reference for even more multiple reference comparison integrity and the engineered result is the Valhalla 2734A. What they are all getting at is: for absolute trustworthy, direct voltage accuracy, the multiple referencing integrity approach is the way to go.

The 2734A-The Direct Voltage Standard for People on the Move

The basic accuracy is specified over a wide 10°C range, so changes in environment have little or no effect on the output. The 2734A has been proven to meet tough MIL-T-28800C vibration requirements, so it can handle all the punishment of surface or air transportation with ease. And, the 2734A is very forgiving about loading or short-circuiting. Recovery is virtually instantaneous. With all this going for it, it's easy to see how the 2734A can deliver primary standards accuracies right out to the production floor.

For mobile or remote applications, 2734A's built-in rechargeable battery system provides 18 hours of continuous operation free from line power. The instrument's unique transit mode allows for extended periods (up to 36 hours) of battery back-up during transportation. By utilizing the optional transit case "TC-34" with self-contained battery pack and charger, the auxiliary power is boosted to 72 hours.

Sample 2734A Report

	Actual 1V	Actual 1.018	Vz	10V	\bar{x} Mean	PPM Dev
Reference #1	1.0000001	1.0180001	7.000002	10.000002	10.000015	0.05
Reference #2	1.0000000	1.0180001	7.000001	10.000001		0.05
Reference #3	1.0000001	1.0180000	7.000001	10.000002		0.05
Reference #4	1.0000002	1.0180003	7.000003	10.000002		0.05

2734A Direct Voltage Reference Bank-Specifications



When it Comes to Direct Voltage Performance, Valhalla Delivers

The 2734A is shipped hot, in the transit mode, from Valhalla Scientific, Inc. in San Diego, CA. The initial adjustments made by Valhalla achieve a traceable maximum uncertainty against the U.S. National volt of 1.0ppm. Additionally, all 2734A's are shipped with actual values of the outputs stated on the certificate with a resolution of 0.1ppm.

Stability (18°C to 28°C)

Output	30 days	90 days	180 days	1 year
1.000V	1.0ppm	2.0ppm	3.0ppm	5.0ppm
1.018V	1.0ppm	2.0ppm	3.0ppm	5.0ppm
7.000V	0.4ppm	1.0ppm	2.0ppm	3.0ppm
10.00V	0.5ppm	1.5ppm	2.5ppm	3.0ppm

Figures given above assume continuous application of power (either internal batteries or external AC). Maximum change in output due to power loss is 0.1ppm non-cumulative.

Temperature Coefficient (0°C to 18°C & 28°C to 40°C)

Output	Temperature Coefficient
1.000V	0.1ppm/°C
1.018V	0.1ppm/°C
7.000V	0.002ppm/°C
10.00V	0.05ppm/°C

Temperature coefficients are applicable following a 15 minute stabilization to new ambient conditions. Temperature shocks (changes in ambient temperature in excess of 10°C per minute) will cause a non-cumulative change in output of no greater than 0.01ppm per °C.

Output Noise

Output	0.01 to 10Hz	10Hz to 20KHz
1.000V	0.1uV peak	3uV RMS
1.018V	0.1uV peak	3uV RMS
7.000V	1uV peak	10uV RMS
10.00V	1uV peak	10uV RMS

Note: The 10Hz to 20KHz figures above are valid while operating from the internal batteries, double these figures if operating from 50/60 Hz line voltage. The 0.01 to 10Hz figures apply to either line or battery operation.

Output Protection: Any (or all) outputs may be shorted indefinitely and all outputs are protected against the application of up to 1200V transients and may continuously source or sink up to 100mA of current without damage.

Minimum Battery Life (hours)

Ambient Temperature	Internal Only		Internal + TC-34	
	Normal	Transit	Normal	Transit
0°C	10	20	20	40
25°C	18	36	36	72
40°C	36	72	72	144

Internal Battery Type: Sealed Lead-Acid Cells

Battery Switch-over: Automatic, transient free switch-over to internal battery power occurs when AC voltage drops below 85% of nominal line value.

Battery Charging Time: The battery charging system in the 2734A will automatically charge the internal batteries when low. Allow 36 hours maximum (18 hours typical) if batteries have been discharged.

Output Characteristics

Output	Adjustability		Output Impedance
	Range	Resolution	
1.000V	±5uV	0.02uV	857.14 ohm ± 0.005%
1.018V	±50uV	0.2uV	869.96 ohm ± 0.005%
7.000V	±1mV	4uV	0.05ohm max/3mA
10.00V	±50uV	0.2uV	0.005ohm max/15mA

General Specifications

Line Power: 115/230VAC ± 10%, 45 to 440Hz, 25VA normal mode (100VA while charging)

Line Regulation: Maximum change in output due to line voltage fluctuation (low line to high line) is 0.05ppm.

Front Panel Indicators: AC on, Transit Mode, Battery Charging, Battery O.K., Oven Ready, Oven Fault.

Temperature Range: Operating 0 to 40°C
Storage -10 to 60°C

Humidity Range: 0 to 95% RH at 35°C
0 to 70% RH at 40°C

Altitude: -5000 to +10,000 ft. operating

Vibration: Per MIL-T-28800, Type III, Class 5, Style E

Size: 89mm H x 432mm W x 432mm D (3.5" x 17" x 17")

Weight: 11Kg (25 Lbs.) net, 14 Kg (30 Lbs.) shipping

Ordering Information

2734A	Direct Voltage Reference Standard . . .	\$3,695.00
2734-90A	Drift Characterized 2734A	\$4,695.00
"TC-34"	Transit Case with Built-in Battery Pack and Charger	\$895.00
"RX3"	Rack Mount Adapter	\$60.00
"SL-48"	Low Thermal Lead Set	\$50.00
"BBL"	Dual Banana Lead Set	\$30.00
Additional	Operating/Maintenance Manual	\$40.00

Programmable Direct Voltage/Current Standard

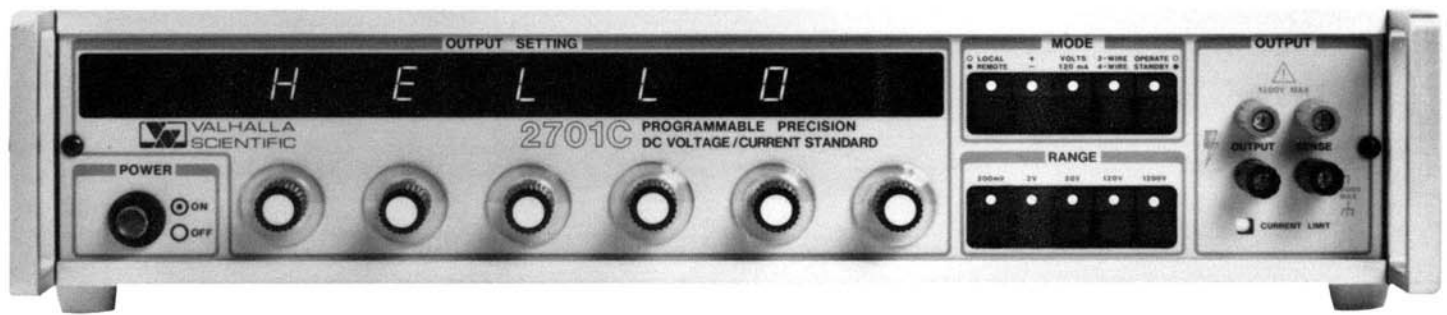

GPIB

The 2701C-1PPM 24 Hr. Stability 8 PPM 30 Day Accuracy

Valhalla Scientific's 2701C Programmable Precision DC Voltage/Current Calibrator utilizes innovative technology to deliver ultra-precision, ultra-stable DC Voltage and Current from 100 nanovolts to 1200 Volts. Designed to meet the most critical calibration laboratory requirements, the 2701C is at home on the production line or in the field. This lightweight, rugged, line powered instrument requires only 15 seconds warm-up.

Performance That Leads the Way

When something really outstanding comes along, it's going to gain a lot of attention. That's been the case of the 2701 since we originally introduced it back in 1979. We're flattered that other instrument manufacturers have tried to imitate our innovative features and design techniques. But, while others have been busy trying to imitate the 2701, we've been busy improving it. Dozens of design enhancements and three models later, we're proud to introduce the 2701C with standard features like:

- "Covers-on" Automatic Calibration
- 100% Overrange
- Automatic Bi-polar Output
- Built-in Kilovolt Amplifier
- One Touch Local and Remote Sensing
- 200mV Full Scale Divided Output Range
- All Outputs Available through Two Terminals
- Basic Accuracy Specified $\pm 5^\circ\text{C}$ from Cal Temp
- 25mA Current Sourcing All Active Ranges
- Micro-processor Enhanced Reliability
- 5 Voltage Ranges (200mV through 1200V)
- Front and Rear Terminals
- Illuminated High Voltage Warning
- 0.5 PPM Resolution
- Optional 120mA Current Range

Innovation in Attenuation

The digital attenuator is the design key to long term stability, reliability and interfaceability. Because the crystal controlled attenuator is digital, it can't drift like the conventional Kelvin Varley divider approach. Also, the switch contact resistance no longer becomes a maintenance headache as it is removed from the accuracy determining circuit.

Ultra-Low Noise 2701LC Version Available

For applications such as analog to digital converter testing, where low noise output is extremely desirable, **option "LNF" provides this enhancement** to the Valhalla 2701C.

Deleting the kilovolt amplifier provides a major improvement in low noise performance. Additionally, by substituting a toroidal transformer stage with 40 VDC maximum output, a significant noise reduction is attained while maintaining a low level safe output

.1 MicroVolt to 1.2KV Direct Output-Standard

The 2701C has a built-in kilovolt amplifier which delivers up to 1200.000 volts with a full 25mA drive current capability. The 2701C is also short-circuit damage proof on all ranges, and features a 200mV divided output range with 100 nanovolt resolution.

Guaranteed Long Term Stability and "Covers-on" Automatic Calibration Capability

The long term stability of the 2701C is good; so good in fact that we specify the accuracy for a full three years. However, when the time finally does come around to re-calibrate your 2701C, it's a snap because the microprocessor prompted automatic calibration routine requires only five decade value calibration points. There are no screws to remove, as all correction factors are permanently stored in on-board non-volatile memory.

System Capability

Designed from the ground up for systems interfaceability, the 2701C offers unmatched user convenience for systems installation. To start with, all output stimuli are available from two terminals on the front and rear panels, so once you've plugged in there's no fumbling around to get to a separate divider or high voltage connector. Also, if remote sensing is required a touch of a button engages the 4-wire output mode. The optional microprocessor controlled IEEE-488 talk/listen interface, "TL-3", is extremely user-friendly, and provides a six channel relay driver port for remote range selection on the 2500EP AC-DC Current Calibrator.

For the added convenience of handling both direct voltage and current calibration requirements in one unit, the 2701C offers an optional 120mA current range. The option "IT-2" provides from 100 nano-amps to 120mA of precise constant current for the calibration of 4-20mA/10-50mA current loops as well as multimeter calibration and general purpose lab work.

3

35



Calibrators, Standards & Systems



Performance Specifications

Accuracy

The accuracy specifications are valid for $\pm 5^\circ\text{C}$. The values stated below include the effects of line and temperature

2701 (ppm of setting + μV)

Range	30 days	90 days	180 days	1 year	3 years
200mV	15 + 1	20 + 1	25 + 1	30 + 2	50 + 3
2V	10 + 3	15 + 4	20 + 5	25 + 6	40 + 10
20V	8 + 20	13 + 30	17 + 40	22 + 50	35 + 80
120V	9 + 150	14 + 250	18 + 350	23 + 400	38 + 750
1200V	10 + 1.5mV	15 + 2.5mV	19 + 3.5mV	24 + 4mV	40 + 7.5mV

Stability and Noise

The 24 hour stability and noise specifications below apply for constant line, load and temperature (within 1°C).

Range	Noise 0.1-10Hz	24hr Stability DC-0.2Hz
200mV	1 μV	1 μV
2V	2 μV	0.5ppm + 2 μV
20V	15 μV	0.5ppm + 10 μV
120V	150 μV	0.5ppm + 100 μV
1200V	1.5mV	0.5ppm + 1 μV

Temperature Coefficient:

The temperature coefficient adder is applicable only when outside of the $\pm 5^\circ\text{C}$ window of the calibration temperature.

Range	ppm of Setting + $\mu\text{V}/1^\circ\text{C}$
200mV	2.5ppm + 0.1
2V	1.5ppm + 0.6
20V	1.5ppm + 6
120V	1.5ppm + 30
1200V	1.5ppm + 300

General Performance Characteristics

*200mV range has a 450 ohm output resistance. The 2, 20, 120 and 1200V ranges will exhibit a maximum of 10ppm of range change in output from no load to a 25mA load.

Range	Resolution	Maximum Current	Wideband Noise 10Hz-10KHz	Linearity
200mV	0.1 μV	*	25 μV RMS	0.5 μV
2V	1 μV	25mA	80 μV RMS	1 μV
20V	10 μV	25mA	130 μV RMS	10 μV
120V	100 μV	25mA	500 μV RMS	100 μV
1200V	1mV	25mA	800 μV RMS	1mV

Output Settling Time

The table above gives the maximum allowable error remaining after the given time following a change in output voltage. The errors are given in ppm of output voltage change.

Range	0.5 second	1 second	10 seconds
20V and below	20ppm	5ppm	1ppm
120V	30ppm	7ppm	2ppm
1200V	50ppm	10ppm	5ppm

For a decrease in output on the 1200V range, add 3ms per volt of change. For a range change, add 0.5s + 3ms per volt of previous setting.

variations within the above window. To derive absolute accuracies relative to the National Bureau of Standards add 1.5ppm for Valhalla Scientific's traceability and transfer uncertainty.

Warmup Time: 15 seconds to within 15ppm of final value
30 minutes to rated specification

Option TL-3 IEEE-488 Interface: Compliance with IEEE-488 (1978) with subsets SH1AH1T6TEOLRLEOSR1RL1PP2DC1DT1CO

Power: 115/230V $\pm 10\%$ at 45 to 65Hz at 80VA

Size: 89mm (3.5") high x 432mm (17") wide x 432mm (17") deep

Weight: 11Kg (24lbs) net, 13Kg (29 lbs) shipping

Operating Temperature Range: 0 to 50°C

Storage: - 30 to 70°C

Humidity: 70% RH max at 40°C (non-condensing)

Specification Options IT-2 (120mA Current Source)

Range: 0-120mA

Resolution: 0.8 ppm of range/100nA

Accuracy: (ppm of setting + μA , $\pm 5^\circ\text{C}$ from calibration temperature)

30 days	90 days	180 days	1 year	3 years
50 + 0.6	60 + 0.9	70 + 1.2	80 + 1.6	140 + 2.5

Temperature Coefficient: (outside $\pm 5^\circ\text{C}$ from calibration temperature) 3.5 ppm of setting + 100nA/ $^\circ\text{C}$ from 0 to 50°C

Ordering Information

2701C	Direct Voltage Standard	\$2,995.00
Option "IT-2"	120mA Current Range	295.00
Option "TL-3"	GPIB Interface with IRP	395.00
Option "LNF"	Low Noise Filter	295.00
Option "RX-3"	Rack Mount Adapter	30.00
Option "SL-48"	Low Thermal EMF Lead Set	55.00
Option "BBL"	48" Dual Banana Lead Set	25.00
Option "GP-1"	1 Meter GPIB Cable	95.00
Option "GP-2"	2 Meter GPIB Cable	115.00
Option "SP-2"	Two Year Spare Parts Kit	145.00
Additional	Operating/Maintenance Manual	35.00

3

36

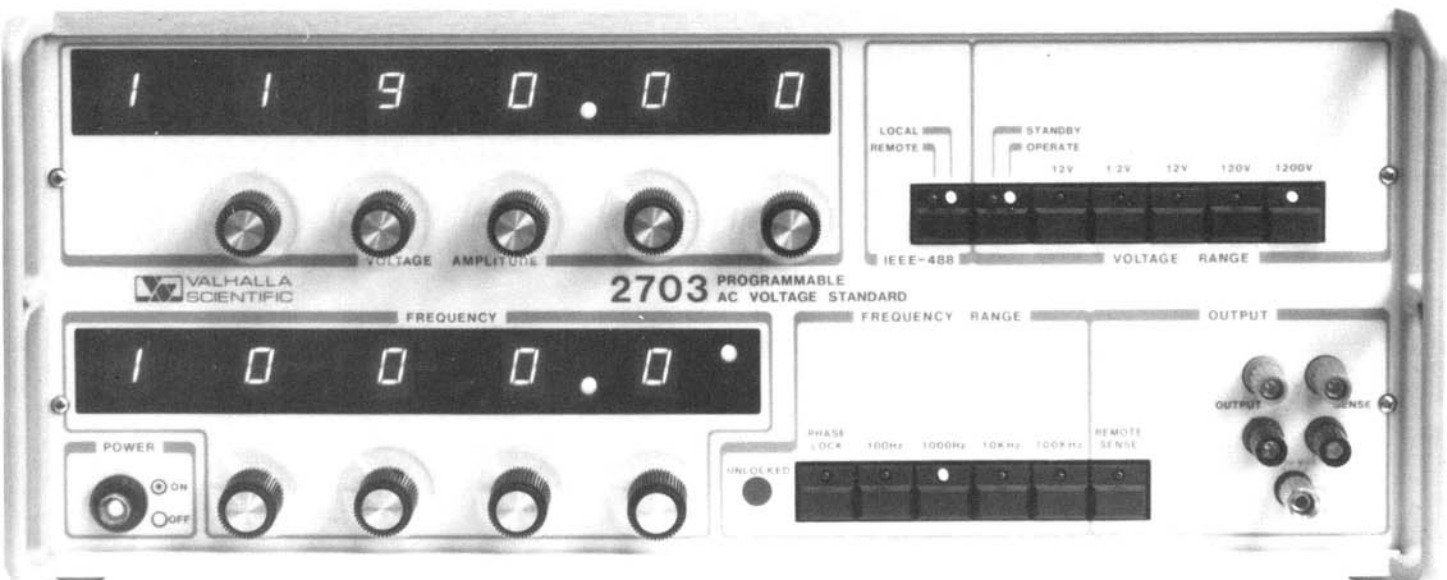

3

The 2703-5ppm/15ppm Thirty Day Frequency and Amplitude Stability

Valhalla Scientific's Model 2703 AC Voltage Standard represents a major breakthrough in precision AC voltage technology. The 2703 is the first AC voltage standard to harness the power of the microprocessor and we've taken full advantage of its on-board intellect. Valhalla's digital design approach allows the 2703 to accomplish multi-tasking capability and provide solid performance unattainable using traditional analog design techniques. User benefits include rock-solid amplitude stability, low waveform distortion, microprocessor enhanced operating reliability, crystal controlled frequency accuracy and covers on Auto-Cal.

"Cover on" Auto-Cal

When it comes to convenience, the 2703 has all other AC Standards beat hands down. The 2703 is the first AC Standard in the world to incorporate "Auto-Cal". This means no disassembly required and no laborious pot tweaking during its calibration. Calibration correction data may be entered from the front panel or over the IEEE-488 interface bus where it is stored internally in non-volatile RAM, not just battery back-up. Non-volatile memory insures infinite Cal data retention whereas battery back-up memory designs are limited by the shelf life of batteries. The 2703's calibration integrity is secured via a keylock switch which prevents unauthorized access to the microprocessor prompted calibrate mode.

Built-In Kilovolt Amplifier and Intelligent Microvolt Output Divider

The 2703 is a full range, high resolution AC Voltage Standard with available outputs from .01 microvolts. The divided output 120mV range utilizes a unique microprocessor based sensing circuit to deliver an accurate, active four terminal output voltage to low impedance loads (as low as 75 ohms). When it comes to beef the 2703 delivers, providing up to 100 milliamps RMS sourcing capability on it's 1.2V, 12 and 120V ranges at frequencies from 10 Hertz to 100 Kilohertz. As an added benefit, the 2703 features a built-in "Kilovolt Amplifier" which provides solid-state outputs up to 1200 volts RMS.

One Touch Remote Sense and Built-In Operator Protection

With features like built-in local or remote sensing, it is easy to see why the 2703 is rapidly becoming the world's most popular programmable AC Standard, but we didn't just stop there. We put the microprocessor to work monitoring the output, so if an operator inadvertently leaves the remote sense terminals "open", the 2703 safely returns to standby as soon as the output voltage exceeds 20% over nominal. As an additional safety feature, the 2703 automatically illuminates a high voltage warning signal whenever the output exceeds 30 volts. To preclude inadvertant activation of the 1200 volt range, the unit automatically switches to "standby" whenever this range is initially selected.

Calibrators, Standards & Systems

2703 Phase Master-For 1 ϕ & 3 ϕ Wattmeter and Phase Angle Calibration Systems

The 2703 AC Voltage Standard is additionally designed to function as both a phase and frequency master in wattmeter calibration applications. The unit generates extremely precise phase and frequency signals to control power factor, current amplitude (up to 100 amps) and reference voltages in 1 ϕ and 3 ϕ wattmeter calibration requirements.

The 2703 master applies a digital phase reference to a 2705 AC Voltage/Phase Standard via its microprocessor output port (multiple 2705's in 3 ϕ applications). The 2703/2705, coupled with a Valhalla current source, forms a most accurate, flexible, modular and efficient wattmeter calibration system. For expanded detailed information on this high resolution digital phase shift capability, please consult the model 2705 AC Voltage/Phase Standard Technical data immediately following the 2703 specifications.

Specifications

AC Voltage: Output Characteristics Table

Range RMS	1.2mV*	12mV*	120mV	1.2V	12V	120V	1200V
Resolution	10nV	100nV	1 μ V	10 μ V	100 μ V	1mV	10mV
Sourcing	(EMF Source)	.4mA	100mA	100mA	100mA	100mA	7mA

*Using 2704 Precision Wideband Divider

Amplitude Accuracy:

	10Hz	1KHz	10KHz	30KHz	100KHz
Range					
0.12V			0.03 + 0.02	0.05 + 0.05	
1.2V		0.01 + 0.01		0.03 + 0.03	
12.V			0.02 + 0.01	0.03 + 0.03	
120.V				0.03 + 0.05	
1200.V	0.03 + 0.03				

Amplitude accuracy is for ninety days at 22°C to 28°C following a thirty-minute warm-up time. The percentages in the table are \pm % of setting and \pm % of range \pm 20 μ V and are relative to NBS traceable standards. The specifications are valid above 1% of range.

Amplitude Stability:

	10Hz	1KHz	10KHz	30KHz	100KHz
Range					
0.12V			15ppm + 10ppm	25ppm + 25ppm	
1.2V		10ppm + 5ppm		15ppm + 15ppm	
12.V				15ppm + 25ppm	
120.V					
1200.V	15ppm + 15ppm				

Stability specifications are 30 days (PPM of setting + PPM of range) + 1 μ V.

Amplitude Temperature Coefficient: 0.05% of specification per °C.

Load capacitance: Maximum load capacitance is 500 pf within output current limitations.

Load Regulation: Less than 0.01% change from no load to full load.

Distortion and Noise:

Frequency	THD + N
10 Hz-4 KHz	0.015% + 0.01% range + 30 μ V
4 KHz-10 KHz	0.045% + 0.01% range + 50 μ V
10 KHz-50 KHz	0.2% + 0.02% range + 80 μ V
50 KHz-100 KHz	0.4% + 0.03% range + 150 μ V

At full load measured with a 10 Hz to 1 MHz bandwidth.

Frequency and Setability:

Range	Resolution	Setability
100 Hz	100.00 Hz	0.01 Hz
1000 Hz	1000.0 Hz	0.1 Hz
10 KHz	10.000 KHz	1 Hz
100 KHz	100.00 KHz	1 KHz

Frequency Accuracy: \pm 0.01% of setting for 1 year over entire temperature range.

Frequency Stability: \pm 0.0005% of setting per month, \pm 0.0001% of setting per °C.

External Phase Lock Capability: Output frequency may be locked to an external signal over a range of \pm 40% of the frequency selected on the front panel. A front panel LED indicates out of lock condition.

General Specifications

Operating Temperature: 0°C to 50°C

Terminal Configuration: Local or remote sensing, front and rear terminals standard.

Size: 178mm H x 432mm W x 432mm D (7" x 17" x 17")

Weight: 23KG/48 lbs. Net, 25KG/55 lbs. Shipping

Power: 115/230 VAC \pm 10%, 50-60 or 400 Hz \pm 5%, 180 watts maximum

Ordering Information

Model 2703	AC Voltage Standard	\$6,795.00
Model 2704	Precision Divider	450.00
Option "TL-2"	Talk/Listen GPIB Interface	395.00
Option "RX7"	Rack Mount Kit	60.00
Option "BBL"	Dual Banana Lead Set	25.00
Option "GP-1"	1 Meter GPIB Cable	95.00
Option "GP-2"	2 Meter GPIB Cable	115.00
Option "SP-2"	2 Year Spare Parts Kit	395.00
Option "XB03"	Extender Board Kit	495.00
Additional	Operating/Maintenance Manual	50.00

2705 Programmable AC Voltage/Phase Standard Calibrators, Standards & Systems

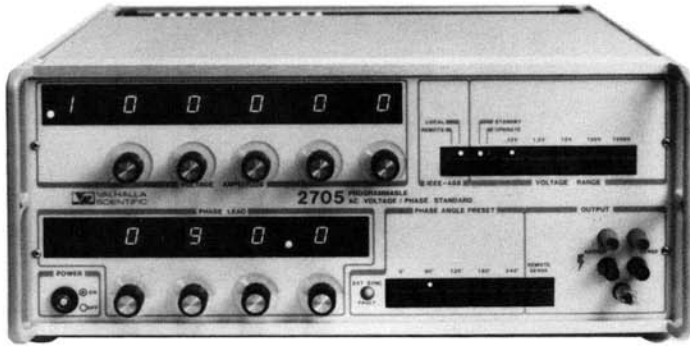
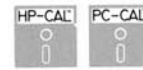

Powerful, Precise and Fast

When combined with the 2703 and a Valhalla current calibrator (Model 2500, 2500E/EP or 2555A) a fast and efficient wattmeter calibration system is formed capable of delivering from zero to 120 Kilowatts of calibrated power. Prior to commercial availability, this new system has undergone extensive testing on Valhalla's Digital Power Analyzer production calibration line. The proven efficiency results are: reduced calibration time of our single phase Model 2100 from thirty minutes to five minutes and reduction in calibration time on our 3 ϕ Model 2300 from six hours to just over one hour.

The 2705-A New Phase in High Technology AC Performance

Valhalla's 2705 AC Voltage/Phase Standard has been engineered to keep you in phase with today's power, energy and phase angle calibration requirements. From a design and construction standpoint the 2705 is identical to our Model 2703 AC Voltage/Frequency Standard with one simple exception. A microprocessor based, plug-in digital phase control board on the 2705 replaces the digital frequency generator board of the 2703. The two units operate in harmony as a frequency master unit (2703) and a selectable slave unit (2705) to form the basis of an efficient and expandable wattmeter calibration system.

Phase control on the 2705 is accomplished in precise 0.1 degree increments from 0° to 360° via four dial front panel entry or over the GPIB. Preset phase settings of 0°, 90°, 120°, 180°, and 240° are instantly available at the touch of a fingertip.

3 ϕ Wattmeter Calibration

The block diagram shown below illustrates the use of the 2703/2705 and current calibrators to establish a modular 3 ϕ wattmeter/watthour meter calibration system. As a master unit the 2703 is capable of driving two slave units. Each phase is fully independent (0° to 360°) from the master phase and each phase can be independently set at any given power factor.

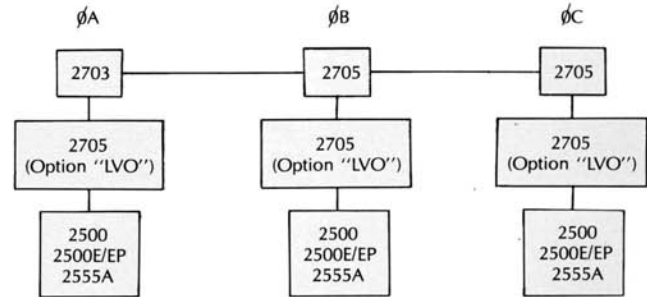

2705 Performance Specifications

Specifications of the 2705 AC Voltage/Phase Standard are identical to that of the 2703 AC Voltage Standards with the following exceptions:

Phase Accuracy:	10 Hz-1000Hz \pm .25° 1 kHz - 10 kHz \pm 1.5°
Phase Noise:	10 Hz-1000 Hz \pm .14° 1 kHz - 10 kHz \pm .7°
Phase Settability:	10 Hz-1000 Hz \pm .1° (0-360°) 1 kHz - 10 kHz \pm 1° (0-360°)

Voltage Output Specifications: Same as 2703 + 0.02% of setting below 30 Hz and above 4 KHz. Minimum output of both master and slave 5% of range or 10mV, whichever greater.

Master-Slave Common Mode Voltage: 100V peak—A maximum of two slaves can be driven from one master.

Front Panel Controls:

Voltage: Standby/Operate, Local, Remote Sense and range select.

Phase: Rotary Switches—Continuous Phase Adjustment.

Preset Phase Settings: 0°, 90°, 120°, 180°, 240°.

Option "LVO": Limits output voltage to a 12 volt RMS maximum for use in driving transconductance amplifiers (current calibrators) in wattmeter calibration systems. The 12V maximum output provides cost savings through the elimination of the 2705's high voltage output system.

Ordering Information

Model 2705	AC Voltage/Phase Standard ..	\$6,795.00
Models 2703/05	Purchased Together	12,995
Option "LVO"	12V Max. Output for 2705	(-600.00)
Option "TL-2"	Talk/Listen GPIB Interface	395.00
Option "RX7"	Rack Mount Kit	60.00
Option "BBL"	Dual Banana Lead Set	25.00
Option "GP-1"	1 Meter GPIB Cable	95.00
Option "GP-2"	2 Meter GPIB Cable	115.00
Option "SP-2"	2 Year Spare Parts Kit	395.00
Option "XB03"	Extender Board Kit	495.00
Additional	Operation/Maintenance Manual ..	50.00

2724A Ultra-Precision 6½ Digit Resistance Standard Calibrators, Standards & Systems

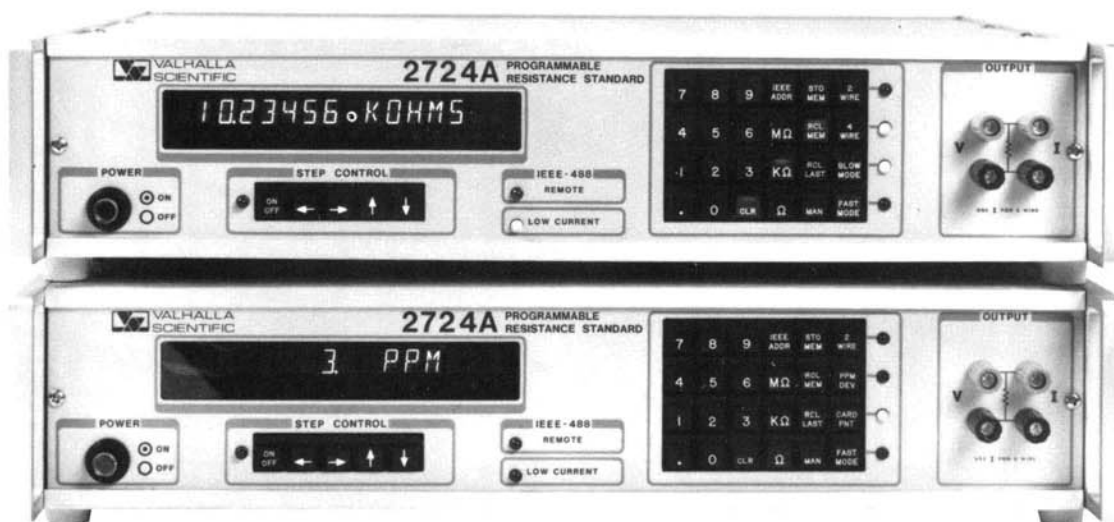

3

The 2724 A-1 PPM Resolution, Fully Variable Programmable Resistance Standard

Valhalla's 2724A Programmable Precision Resistance Standard has created a whole new "State-of-the-Art" in resistance calibration methodology. Valhalla has the first and only fully variable, microprocessor based resistance synthesizer in the world. At last, metrologists are free from the hit and miss approach of calibrating resistance at discrete cardinal points only and can now test full resistance linearity in increments as low as 1 PPM either manually or over the GPIB. Don't be fooled by products that look like Valhalla's 2724A High Resolution Resistance Standard; unless you can actually increment the output it's probably just a whale's tale.

The 2724A provides over 10 million lab standard resistance values ranging from 100 micro-ohm increments on the 120 ohm full scale range up to 11 gigohms maximum output. This vast array of precision resistance is made possible through the 2724A's synthesized output format which has been exhaustively field tested for full compatibility with virtually all types of digital and analog

multimeters and ohmmeters. The 2724A is also ideal for automatic in-circuit precision resistance substitution.

2PPM/10PPM 24 Hour and 1 Year Stability

The 7ppm basic accuracy of the 2724A is good, good enough to calibrate resistance on virtually all 4½, 5½, and 6½ digit multimeters, even after one full year. However, the inherent stability and digital setability of the 2724A is so great that the 2724A can be calibrated to local standards to provide traceable accuracy good enough to calibrate the best 7½ digit DMMs available.

Covers On "Auto-Cal" With Built-In Diagnostics

The 2724A is fully loaded with user conveniences. To start with, calibration of the 2724A is accomplished with the covers on via front panel data entry or over the GPIB. Calibration correction data is stored in NOVRAM memory and is fully protected from unauthorized entry via a rear panel mounted calibration keylock switch. Extensive diagnostics capability is standard on the 2724A including a full accompaniment of user prompting error codes which assist in fault diagnosis to the assembly or component level.

2-Wire/4-Wire, Fast or Filtered

All are standard operating modes available on the 2724A. True four wire input is recommended on DVM's having this facility to totally eliminate lead wire resistance errors. The two wire compensation mode is available as a calibration constant to eliminate internal two wire resistance errors or even a prescribed amount of lead resistance. In the fast mode, the 2724A is capable of synthesizing resistance at frequencies up to 3KHz. The filtered mode provides maximum resolution and accuracy with a minimum amount of noise.

Option "CPR"

For applications requiring the utmost accuracy and full compatibility with spiking and switching type current sources (i.e., JF 8502A) the option "CPR" is recommended. "CPR" stands for cardinal point resistance and is available in decade values from 100 ohms to 10 megohms. The "CPR" option includes UUT error computation capability as displayed on the lower of the two units shown above. Maximum current sink capability is reduced to 15 mA in the active mode with CPR installed.

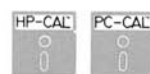

Calibrators, Standards & Systems

Specifications



Accuracies below are relative to NBS traceable standards and are valid at ± 5°C from calibration temperature within 15°C to 30°C.

2724A Standard Mode Operation

Resistance (Ohms)	Current		Accuracy (for 90 days ± 5°C)	Stability (DC to 1Hz)		Temperature Coefficient (ppm/°C)	Settling Time (seconds)	
	Min.	Max.		24 Hr.	1 Year		Change in Current	Change in Value
0 to 120	500uA	120mA	7ppm + 2mΩ	2ppm	10ppm	1.5	2	2
120 to 1.2K	50uA	12mA	7ppm + 7mΩ	2ppm	10ppm	1.5	2	2
1.2K to 12K	5uA	1.2mA	7ppm + 50mΩ	2ppm	10ppm	1.5	2	2
12K to 120K	500nA	120µA	7ppm + 500mΩ	2ppm	10ppm	1.5	2	2
120K to 1.2M	50nA	12µA	12ppm + 5Ω	2ppm	10ppm	3	2	2
1.2M to 12M	5nA	1.2µA	20ppm + 50Ω	2ppm	15ppm	5	3	2
12M to 120M	500pA	120nA	40ppm + 1KΩ	500Ω	50ppm	15	4	2
120M to 1.2G	50pA	12nA	0.1% + 50KΩ	50KΩ	0.05%	15	6	3
1.2G to 11G	5pA	1.2nA	0.1% + 5MΩ	5MΩ	0.05%	15	15	5

2724A Fast Mode Operation

Resistance (Ohms)	Current pk. max.	One Year Absolute Accuracy (Ohms)	Temperature Coefficient (Ohms/°C)	Settling Time (milliseconds)		0.05% Error Frequency
				Change in Current	Change in Value	
0 to 120	120mA	0.04	0.006	0.1	5	3KHz
120 to 1.2K	12mA	0.4	0.06	0.1	5	3KHz
1.2K to 12K	1.2mA	4	0.6	0.1	5	3KHz
12K to 120K	120uA	40	6	0.2	5	2KHz
120K to 1.2M	12µA	400	60	1	5	500Hz
1.2M to 12M	1.2uA	6K	600	10	10	50Hz
12M to 120M	120nA	60K	6K	500	100	—
120M to 1.2G	12nA	600K	60K	5 Sec.	2 Sec.	—
1.2G to 11G	1.2nA	6M	600K	15 Sec.	5 Sec.	—

2724A CPR Mode Operation

Resistance (Ohms)	Current Max.	Accuracy (for 90 days ± 5°C)	Stability (DC to 1Hz)		Temperature Coefficient (ppm/°C)	Settling Time (milliseconds)	
			24 Hr.	1 Year		Fast Mode Std.	Mode
100	120mA	7ppm + 2mΩ	2ppm	10ppm	1.5	0.1	100
1K	12mA	7ppm + 7mΩ	2ppm	10ppm	1.5	0.1	100
10K	1.2mA	7ppm + 50mΩ	2ppm	10ppm	1.5	0.1	100
100K	120µA	7ppm + 500mΩ	2ppm	10ppm	1.5	0.1	100
1M	12µA	12ppm + 5Ω	2ppm	10ppm	3	0.3	1 Sec.
10M	1.2µA	20ppm + 50Ω	2ppm	15ppm	5	3	5 Sec.

Output Configuration: 2-wire/4-wire, front and rear terminals standard.

Leakage Current: ± 2pA ± 0.2pA/°C.

Resolution: 0.8ppm standard, 1ppm CPR, 8ppm fast mode

Power Coefficient: 0.15ppm/mW

Noise and Thermals: (DC to 10Hz, 4-terminal)

- CPR Mode ± 2uV Maximum
- Standard Mode ± 4uV Maximum
- Fast Mode ± 30uV Maximum
- 2 terminal mode ± 20uV Maximum

Maximum Input: 25V peak or 120mA (if option CPR installed 15mA max in active modes)

Operating Temperatures: 0°C to 50°C

Warm-up Time: 15 minutes to within 5ppm of final value

Size: 89mm H × 432mm W × 432mm D (3.5" × 17" × 17")

Weight: 8.2 Kg (18 lbs.) net, 11.4 Kg (25 lbs.) shipping

Power: 115/230 VAC ± 10%, 50-60Hz, 30 Watts

Ordering Information

Model 2724A	Precision Resistance Standard . . .	\$3,995.00
Option "CPR"	Cardinal Point Resistance Mode	195.00
Option "TL-1"	Talk/Listen GPIB Interface	395.00
Option "RX3"	Rack Mount Kit	30.00
Option "BBL"	Low Leakage Dual Banana Leads	25.00
Option "GP-1"	1 Meter GPIB Cable	95.00
Option "GP-2"	2 Meter GPIB Cable	115.00
Option "SP-2"	2 Year Spare Parts Kit	195.00
Option "M24"	Calibration Kit	345.00
Additional	Operation/Maintenance Manual	35.00

Introduction 2500 Series AC-DC Current Calibrators

Calibrators, Standards & Systems

Precision AC & DC Current Calibrators

Bandwidth up to 10kHz

Outputs from 10 Pico-amperes to 100 Amperes

The 2500 Series

Valhalla Scientific offers a complete line of five precision AC-DC current calibrators covering fourteen decades of current from 10 pico-amp resolution to 100 amperes full scale. Each model uses a patented* technologically advanced differentially coupled transconductance amplifier configuration to provide ultra-stable, accurate, wideband constant current.

Input Reference Voltage

By taking advantage of existing multi-dial, precision voltage calibrators the 2500 series offers an economical solution to accurate current calibration. The output current amplitude is directly proportional to the applied input voltage reference.

100 Kilo-Ohm/10 megohm Input Impedance

The high impedance "front-end" design drastically reduces circuit loading of the reference source. For applications requiring more than 100 kilo-ohms of input impedance the model 2500EN offers 10 megohm input impedance. The higher level of impedance virtually

assures compatibility with even the lightest duty portable voltage calibrators.

Wideband AC Response, 10Hz & Up

For unbeatable AC performance look to Valhalla's 2500 series current calibrators. Each unit features an inherent low distortion, instantaneous responding AC amplifier. Basic accuracy on most models is $\pm .05\%$ with bandwidth specified to 10KHz on the model 2500. Stable and repeatable outputs are available well beyond the specified bandwidths.

Output Compliance Voltage Indicator

Each unit is equipped with a warning light system to status the operator of the output compliance condition at all times. The illumination of the red lamp indicates that the compliance voltage compatibility has been exceeded and that a possible non-linear operating condition exists. The green lamp indicates that the unit is well within its linear constant current mode.

Standby/Operator Selector Switch

This convenient built-in feature eliminates the need to insert an input shorting plug when the reference voltage is removed. Engaging the standby switch prior to removing the input reference avoids a potential maximum output

condition and possible damage to the unit under test. The standby/operate switch is standard equipment on the models 2500EP, 2500EN and 2555A.

Reduce Calibration Time While Eliminating Error Sources

The 2500 series calibrators have literally reduced the required calibration time for five ranges of AC & DC current on a typical multimeter to less than five minutes. In addition, the accuracy is vastly improved over awkward laboratory test set-ups requiring external resistors, monitors, etc....

Guaranteed Long Term Accuracy

Long term accuracy is achieved by use of highly stable, non-inductive resistance elements and precision operational amplifiers in the accuracy determining sections of the instrument. Certificates of traceability are available upon request at no extra charge.

Handy Precision Buffer Amplifier

Valhalla's 2009 Precision Buffer Amplifier is a self-contained unit which satisfies many laboratory requirements for high impedance circuit measurement. The unit's input impedance is 10 gigohms with a low input capacitance of only a few pf. The low noise unity amplification output is less than 1 ohm in impedance, accepts up to 3V DC or peak AC inputs and features a bandwidth of 10KHz.

Calibrators, Standards & Systems



The 2500

The Model 2500 represents Valhalla's lowest range AC-DC current calibrator. The unit is capable of delivering up to 2 amps of precision constant current or as little as 1 microamp full scale. This wide range current source provides seven pushbutton selectable ranges with resolution down to 10 picoamps. Like all of the 2500 Series AC-DC Current Calibrators, the 2500 utilizes Valhalla's patented dual differential transconductance amplifier* technology to provide superb performance at an economical price. The 2500 is packaged in a heavy duty extruded

aluminum enclosure to promote convection cooling; no fans are required.

The 2500 is ideal for calibrating AC and DC current on DMMs, VOMs, ammeters and wattmeters. Additionally, its low current range is useful in making high resistance measurements and for calibrating dose processing units on ion implantation equipment. Up to 10 volts of compliance is available on all ranges of the 2500 to insure that constant current is delivered.

Should the output be presented with a high impedance circuit compliance voltage (in excess

of 10V) the overload indicator will illuminate.

Bandwidth to Spare

The wideband output stage of the 2500 is fully specified to 10KHz, but it doesn't stop there. In fact, the 2500 is still delivering stable, repeatable wideband constant current well above the 30KHz mark. The wideband design characteristics of the 2500 allows the output current to closely track the input reference voltage in terms of amplitude, frequency, phase and waveshape. Each range of the 2500 features zero to 200% dynamic response capability.

*U.S. Patent No. 4091333

Specifications

Range	1µA	10µA	100µA	1mA	10mA	100mA	1A
Resolution	10pA	100pA	1nA	10nA	100nA	1µA	10µA

Dynamic Range: 0 to 200% of range, DC or RMS AC, up to maximum rated output.

Maximum Output Current: 2 amps DC or peak AC

DC Accuracy: (180 days 25°C ± 5°C) ± .01% of output ± .01% of F.S.

AC Accuracy: (180 days 25°C ± 5°C) ± .05% of output ± 0.1% of F.S. to 1KHz, ± 0.5% of F.S. to 10KHz

Input Impedance: 100 Kilo-ohms

Compliance Voltage: 10 volts DC or Peak AC

Input/Output Ratio: 2.00000 volt input produces full scale output (200% of range)

Maximum Input: 3 volts DC or Peak AC

Output Protection: Fuse protected at 3 amps

Response Time: 1 millisecond to within ± 0.01% of final value following input amplitude or frequency change

Maximum Isolation Voltage: ± 200 VDC or Peak AC

Input Common Mode Rejection Ratio: 60db @ D.C. linearly decreasing to 40db @ maximum frequency

Temperature Range: 0°C to 50°C

Temperature Coefficient: ± .001% of output ± .002% of range/°C for DC, below 20°C and above 30°C, double above for AC

Power: 115/230 VAC ± 10% 50-60Hz

Size: 299mm/9" L x 381mm/15" W x 64mm/2.5" H

Weight: 7 Kg/15 lbs. Net 9 Kg/20 lbs. Shipping

Ordering Information

Model 2500	AC-DC Current Calibrator \$1295.00
Model 2009	Precision Buffer Amplifier 195.00
Option "R1"	Rack Mount Kit 75.00
Option "BBL"	Low Leakage Dual Banana Cable Set	.. 25.00
Option "SP-2"	2-Year Spare Parts Kit 135.00
Additional	Operating/Maintenance Manual 20.00

Calibrators, Standards & Systems

The 2500EP & 2500EN*

The 2500 EP and its sister version constitute our most popular current calibrator. The ranges of the 2500EP and EN are compatible with virtually all analog and digital multimeters; 100 microamps to 10 amps. The 100 microamp range provides 1 nanoamp resolution for multimeters with low current measurement capability while the 10 amp range accommodates the increasingly popular 10 amp direct measurement capability of today's handheld and benchtop DMMs. In addition to calibrating multimeters, the units are ideal for calibrating ammeters, C.T.s, shunts and wattmeters. The fast response characteristics of these transconductance amplifiers allow the output current to closely track the input reference voltage in terms of amplitude, frequency, phase and waveshape. Each range features zero to 200% dynamic response capability (up to maximum output).

10 Volt Compliance

Compliance voltage to a current calibrator is what drive current is to a voltage source. It is the ability to tolerate high series resistance (up to

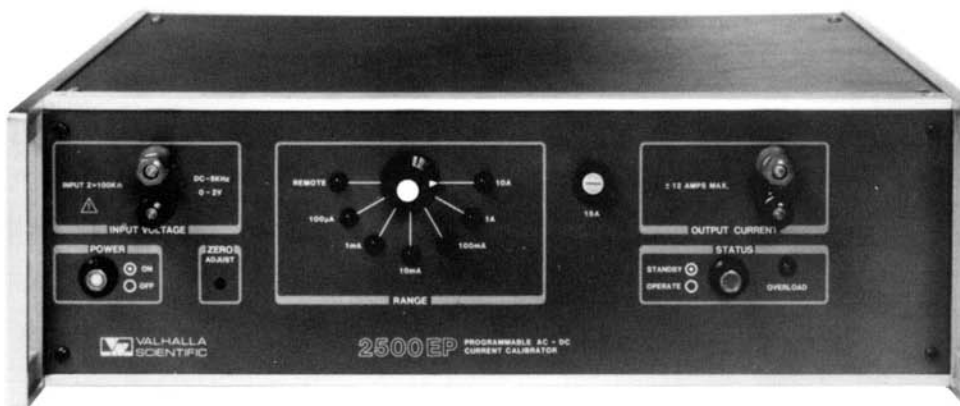

a 10V drop) and still deliver stable, constant current. The 2500 series current calibrators all feature healthy compliance capability to deliver constant current long after competitive units have dropped off. Built-in compliance indicators inform the operator of the compliance voltage status at all times.

The 2500EP-Systems Interfaceable

For automated calibration, the 2500EP provides remote range

selection capability. The desired output range is selected by applying a positive 5 volt signal to the corresponding rear panel connector pin. For IEEE-488 interfacing, this signal is available from the model 2701C Precision Programmable DC Voltage Calibrator, or via the 'IRP' outputs from the 2790B interface panel. The model 2500EP features L.E.D. range indicators to show the remotely engaged range. Manual range selection on the 2500EP can be accomplished by setting the rotary knob to the desired range.

*Protected by U.S. Patent No. 4091333

2500EP Specifications

Range Resolution	100µA	1mA	10mA	100mA	1A	10A
	1nA	10nA	100nA	1µA	10µA	100µA

Dynamic Range: 0 to 200% of range, DC or RMS AC, up to maximum rated output.

Maximum Output Current: 12 amps DC or RMS AC

DC Accuracy: (180 days 25°C ± 5°C) ±.01% of output ±.02% of F.S.

AC Accuracy: (180 days 25°C ± 5°C) ±.05% of output ±.05% of F.S. to 5KHz for 2500EP, to 500Hz for 2500EN

Input Impedance: 100 Kilo-ohms except 10 megohms on 2500EN

Compliance Voltage: 10 volts DC or Peak AC

Input/Output Ratio: 2.00000 volt input produces full scale output, 20 volts for model 2500EN (200% range)

Maximum Input: 3 Volts DC or Peak AC, 30 volts DC or peak AC Model 2500EN

Output Protection: Fuse protected at 15 amps

Response Time: 1 millisecond to within ±0.01% of final value following input amplitude or frequency change

Maximum Isolation Voltage: ±200 VDC or peak AC

Input Common Mode Rejection Ratio: 60db @ DC linearly decreasing to 40db @ maximum frequency

Temperature Range: 0 to 50°C

Temperature Coefficient: ±.001% of output ±.002% of range/°C for DC, below 20°C and above 30°C, double above for AC

Power: 115/230 VAC ±10% 50-60Hz

Size: 381mm/15" L x 432mm/17" W x 133mm/5.23" H

Weight: 14 Kg/30 lbs. Net 18 Kg/40 lbs. Shipping.

Ordering Information

Model 2500EP	Current Calibrator (Programmable)	2,395.00
Model 2500EN	Current Calibrator (High Impedance)	2,495.00
Model 2009	Buffer Amplifier	195.00
Option "MRP"	Manual/Remote Range Panel	295.00
Option "R2"	Rack Mount Kit	30.00
Option "BBL"	Dual Banana Cable Set	25.00
Option "SP-2"	2-Year Spare Parts Kit	145.00
Additional	Operation & Maintenance Manual	25.00

Calibrators, Standards & Systems

The 2555A is the world's leading 100 Ampere AC-DC Current Standard. The 2555A has earned this position through ten years of proven rock-solid reliability and unmatched performance. Our satisfied and discriminating customers include the U.S. Army, Navy, Air Force and the National Bureau of Standards, as well as an impressive list of hundreds of other proud 2555A owners around the world that reads like the Who's Who of metrology. So, when you're in the market for a 100 Ampere AC-DC Current Calibrator, don't settle for a cheap imitation that just looks like the 2555A, it won't measure up to our standards.

Capable of delivering from 1mA to 100 amps DC or RMS AC of precise constant current, the 2555A is ideal for direct calibration of ammeters, wattmeters, DMM's, shunts, current transformers and Hall effect devices. The superb stability of Valhalla's patented transconductance amplifier* technology allows the 2555A to be used for transfer measurements on .001 ohm primary resistance standards. Applications for the 2555A outside of the field of metrology include component



testing on fuses, circuit breakers, relays and high current connectors.

The 2555A supplies four volts of compliance in order to drive heavy burden loads and still deliver constant current. The output compliance is continually monitored by the units' internal voltmeter. Compliance status is displayed at all times on the 2555A's compliance indicators. To insure that the compliance voltage is available to drive the load (and not the leads), Valhalla offers two heavy duty six foot 100 amp cable sets. The "HMF" set is terminated in 2" opening, 500 amp rated,

injection molded clamps, while the "HC" version is terminated in no. 4 copper ring lugs.

The 2575A AC-DC Active Current Shunt

The 2575A AC-DC Active Current shunt is a valuable addition to any metrology lab. The 2555A and 2575A work hand-in-hand in the precision generation and measurement of AC and DC current from 1mA full scale to 100A. Detailed information on the 2575A can be located on the next page.

*Protected by U.S. Patent No. 4091333

2555A Specifications

Range: 100A 10A 1A 100mA 10mA 1mA

Dynamic Range: 0 to 200% of range up to maximum rated output.

Maximum Output Current: 100A DC or RMS AC

DC Accuracy: (180 days 25°C ± 5°C) ±.03% of output ±.03% of range

AC Accuracy: (180 days 25°C ± 5°C) ±.15% of output ±0.1% of range to 100Hz, ±0.2% of output ±0.2% of range to 400Hz, ±0.3% of output ±0.3% of range to 1KHz

Input Impedance: 100 Kilo-ohms

Input/Output Ratio: 2.00000 volt input produces full scale output (200% range)

Maximum Input: 3 volts DC or Peak AC

Maximum Isolation Voltage: ± 200 VDC or Peak AC

Input Common Mode Rejection Ratio: 60db @ DC linearly decreasing to 40db @ maximum frequency

Load Regulation: Output current changes less than ±.002%

Temperature Range: 0°C to 50°C

Temperature Coefficient: ±.002% of output ±.004% of range/°C for DC, below 20°C and above 30°C (double above for T.C. for AC)

Compliance Voltage: 4 Volts

Size: 432mm/17" L x 432mm/17" W x 267mm/10.5" H

Weight: 45 Kg/100 lbs. Net 66 Kg/140 lbs. Shipping

Power: 115/230 VAC ± 10% 50-60Hz 2000 watts

Ordering Information

Model 2555A	100A Current Calibrator	\$4795.00
Model 2575A	100A AC-DC Shunt	1795.00
Model 2009	Precision Buffer Amplifier	195.00
Option "R3"	Rack Kit for 2555A	60.00
Option "HC"	100 A Cable Set	100.00
Option "HMF"	100 A Cable Set	150.00
Option "BBL"	Shielded Dual Banana Cable Set	25.00
Option "SP-2"	2-Year Spare Parts Kit	395.00
Additional	Operating/Maintenance Manual	25.00

Calibrators, Standards & Systems



The 2575A

The 2575A Precision AC-DC Active Current Shunt is truly a hard working and versatile instrument designed for the calibration laboratory. The unit doubles as a measurement tool for AC and DC current as well as a working standard for low level resistance calibration requirements. In addition, the 2575A now features an improved built-in precision gain of 10 chopper stabilized buffer amplifier.

What's Wrong With Using DC Resistors to Certify AC Current?

Plenty! To start with most lab standard resistors are designed to permit close trimming to a nominal DC value. These DC resistors contain inductive components,

which even though very small, can result in significant error (especially in the lower resistance values). To this end, each range of the 2575A utilizes a specially designed non-inductive resistance element which insures a flat frequency response to 10KHz.

AC & DC Current Measurement to 100 Amps

In the current measurement mode the 2575A offers six independent switch selectable ranges from 1 milliamp full scale to 100 amperes. All but the maximum range feature 100% overrange capability. The 100A, 10A and 1A range shunt resistors are fan cooled to minimize heat rise and thereby maximize thermal stability.

Four-Terminal Performance You Can Bank On

When used as a lab standard resistance bank, the 2575A provides six decade value, 4-terminal resistors from .001 ohm to 100 ohms. Each range of the 2575 is independently adjustable.

Built-In Chopper Stabilized Amplifier

The full scale voltage drop across the shunt is 100.00 millivolts at rated current. A precision gain of 10.000 wideband chopper amplifier is incorporated to provide a higher level output, capable of driving thermal transfer standards. The amplifier is available for use with external inputs and features an input impedance of 10,000 megohms.

General Specifications

Amplifier Characteristics

Amplitude Gain: 10.000

Gain Accuracy: $\pm 0.01\% \pm 10\mu\text{V RTI @ DC}$

Frequency Response: $\pm 0.05\%$ to 10 KHz

Input Resistance: Greater than $10^{10}\Omega$

Output Resistance: Less than $.1\Omega$

General Specifications

Temperature Range: 0 to 50°C

Temperature Coefficient: Less than 0.001% per °C

Voltage Drop (before amplifier): 100.00 mV for full scale input current

Power: 115/230 VAC 50-60 Hz 12 Watts (230 VAC Special Order)

Size: 3.5" H x 17" W x 10" D (8.9cm x 43.2cm x 25cm)

Weight: 8 lbs. (3.6KG) Net 13 lbs. (5.9 KG) Shipping

Range	Shunt Value	DC Accuracy*	AC Accuracy *		Max Input DC/RMS AC
			1 KHz	10KHz	
100A	.001 Ω	$\pm .05\%$	Not Specified	$\pm .5\%$	100A
10A	.01 Ω	$\pm .02\%$			20A
1A	.1 Ω	$\pm .02\%$			2A
100mA	1 Ω	$\pm .01\%$	$\pm .1\%$.2A
10mA	10 Ω	$\pm .01\%$.02A
1mA	100 Ω	$\pm .01\%$.002A

*(180 days 25°C \pm 3°C)

Ordering Information

Model 2575A	AC-DC Active Current Shunt	\$1795.00
Option "HC"	2555A to 2575 100A 6' Cable Set	100.00
Option "BBL"	48" Shielded Cable Dual Banana to Dual Banana	25.00
Option "RX3"	3.5" x 19" Rack Mount Adaptor	30.00
Additional	Operation/Maintenance Manual	25.00

Digital Ohmmeters

Affordable 4½ Digit Resistance Measurement from 100 Nano-Ohms to 200 Megohms

Digital Ohmmeters

Valhalla's line of Digital Ohmmeters have been designed to tackle a wide variety of tough resistance measurement applications. At the heart of each unit lies Valhalla's patented constant current technology. Combining this ultra-stable constant current source with a 4½ digit integrating A/D converter provides for a low noise, fast responding, 4 terminal resistance measurement. LSI construction minimizes parts count while 100% burn-in insures maximum reliability.

Long term accuracy is achieved by use of highly stable semiconductor reference elements and precision, aged, stabilized resistors in the accuracy determining portions of the instrument. You can count on accurate measurements for longer time periods and big savings in calibration costs.

Kelvin 4-Wire Compensation

Errors normally caused by test lead and contact resistance are eliminated by use of a 4-terminal configuration on all Valhalla Digital Ohmmeters. In many applications the contact resistance can exceed the value of the load by several orders of magnitude. Valhalla bypasses this potential error source by providing two terminals of constant current and an additional two terminals for high impedance voltage measurement. The diagram above illustrates how the 4-wire principle is used to eliminate lead wire and contact resistances as potential error sources.

The internal current source inherently overcomes all series resistance (within compliance

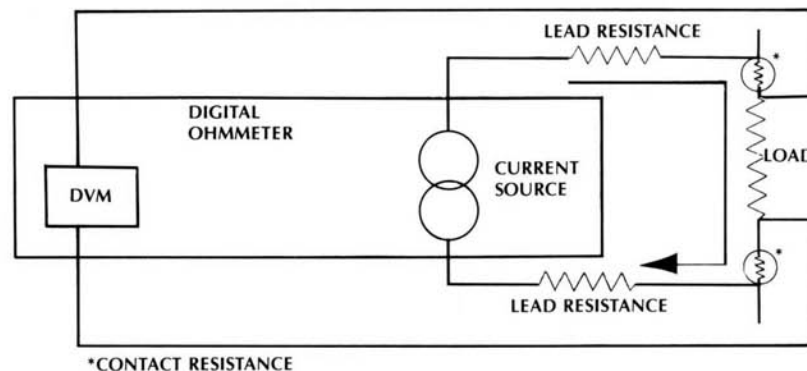

voltage limits) and delivers stable constant current. The high impedance DVM senses the voltage drop across the load. There is no contact and lead resistance error created by the voltage measurement because there is essentially no current flow in the voltage sense leads. All cable accessories offered by Valhalla are 4-wire Kelvin configured.

ATC—Automatic Temperature Compensation

Available on the Models 4100ATC, 4150ATC and 4300B, this feature simulates a constant ambient temperature chamber for materials which are normally subject to varying ambient temperatures. When in the ATC mode, the temperature sensor automatically senses the ambient temperature and compensates the reading to indicate what the actual resistance value should be in a controlled 20°C environment. Materials such as copper and aluminum will exhibit approximately a 4% change in resistance for a 10°C change in temperature.

Prior to Valhalla's introduction of Automatic Temperature Compensation, users were required to note ambient temperatures and manually correct readings back to a predetermined referenced temperature (usually 20°C). This

tedious, time consuming and error prone process of manual compensation is totally eliminated through the implementation of Valhalla's A.T.C. feature. Without temperature compensation, materials can easily be erroneously classified during the process of acceptance testing. Valhalla uses 3931 ppm/°C and 4030 ppm/°C for copper and aluminum respectively, referenced to 20°C. Other material coefficients and reference temperatures are available on special order.

Systems Capability

The lightweight and rugged design characteristics of all Valhalla Digital Ohmmeters makes them ideal for use in the field, on a benchtop or installed in a rack. Each of these instruments offer an optional data interface package either in binary coded decimal format (BCD) or IEEE-488 (4300B and 4650 only).

The BCD data output option permits the digital ohmmeter to be used in conjunction with a printer, data logger or data acquisition system. When used with our model 1248 Dual Limit Digital Comparator, a high speed "GO/NO-GO" test system can be set up for a surprisingly low cost. The combined talk/listen capability of the 4300B with IEEE-488 can be utilized to form a powerful automatic or semi-automatic resistance test system.

Digital Ohmmeters

GP1B

Heat Rise Determination for Motors and Transformers

Engineers and technicians are commonly required to determine the temperature rise due to self heating of motors, transformers, Solenoids, coils, etc. The internal power losses associated with the I^2R of the device results in self heating which manifests itself by increasing the operating temperature of the unit above the ambient surroundings. In most cases it is both impractical and inconvenient to instrument the test article with thermocouples or temperature sensors....enter the change in resistance method.

The majority of the above magnetic devices use either copper or aluminum wire in their construction. The wire has a precise temperature coefficient (TC). By proper resistance measurement and calculation as in equation (1) below, temperature rise determination becomes a simple process.

$$(1) \quad \Delta T = \frac{R_{\text{Hot}} - R_{\text{Cold}}}{R_{\text{Cold}} \times T.C.}$$

Using a motor, as an example, it is desired to determine its internal temperature rise after 8 hours of driving a rated load. The motor uses copper wire for its field winding. Copper wire has a T.C. of 3931 ppm/°C. Using a Valhalla Model 4100ATC Digital Ohmmeter on the 2 Ω range, the ambient temperature winding resistance is measured as 1.2367 Ω . After eight hours of operating under full load, the motor winding resistance, after powering down, was measured as 1.6211 Ω .

The heat rise computation is shown below.

$$\Delta T = \frac{1.6211 - 1.2367}{1.2367 \times .003931} = 78.45^\circ\text{C}$$

The above example made no allowance for possible changes in ambient temperature which could have drastic effects on the test result. To insure measurement validity, Automatic Temperature Compensation should be used.

Contact Resistance Measurement

Manufacturers and users of switches and connectors are concerned with the proper measurement technique in testing contact resistance. The "dry" contact resistance of switch contacts or mated connector pins represents a figure of merit condition for the resistance quality of the mated surfaces.

Prior to the application of any voltage across a closed set of contacts, a dry contact resistance condition exists. Upon the application of a potential exceeding approximately 500 millivolts, the dry contact resistance state becomes altered due to the attraction of the molecules on the surface of the contacts. The resistance is significantly decreased under this condition.

The measurement of the dry contact resistance must be approached with caution. A given multimeter or test set up might use only 20mV to 200mV for measurement purposes, however the open circuit voltage at the test leads could be 5 volts or higher as a function of the particular internal power supply design. As the test leads are attached to make the measurement, the dry contact resistance is dramatically changed due to the excessive potential. After the test leads are attached, the open circuit voltage is instantly

reduced to a few millivolts as required to regulate constant current for the test, but the results are no longer valid.

Valhalla developed the Models 4165 and 4165-1344 Digital Ohmmeters to satisfy these test conditions as defined by MIL-S-83504, MIL-S-227100, and MIL-STD-1344. There is an active electronic clamp across the output terminals of the 4165. The clamp voltage may be selected as either 50mV or 2 volts. The maximum measurement potential is 20mV while the maximum open circuit voltage is either 50mV or 2 volts. The 2 volt test condition will cause molecular attraction to occur while the 50mV will insure that it does not. These test conditions satisfy Paragraph 4.7.6 of MIL-S-83504 and Paragraph 4.7.2 of MIL-S-227100.

Low Level Resistance Measurement Applications

Winding resistance on: motors, generators, transformers, coils, solenoids, relays, ballasts.

Bonding resistance measurement: weld joints, crimp lug connections for cables and power lines, bolted joint resistance on bus bars

Contact resistance measurement on: switches, connectors, utility switchgear, relay contacts, circuit breakers

Component testing, matching and sorting: Resistors, pots, shunts, strain gauges, I.C. substrates, thick film circuits, small motors and transformers, chokes, thermistors, fuses, extruded copper wire, squibs, heating elements, printed circuit board clad resistance, plated through holes, plating thickness, plating hook resistance.

Digital Ohmmeters

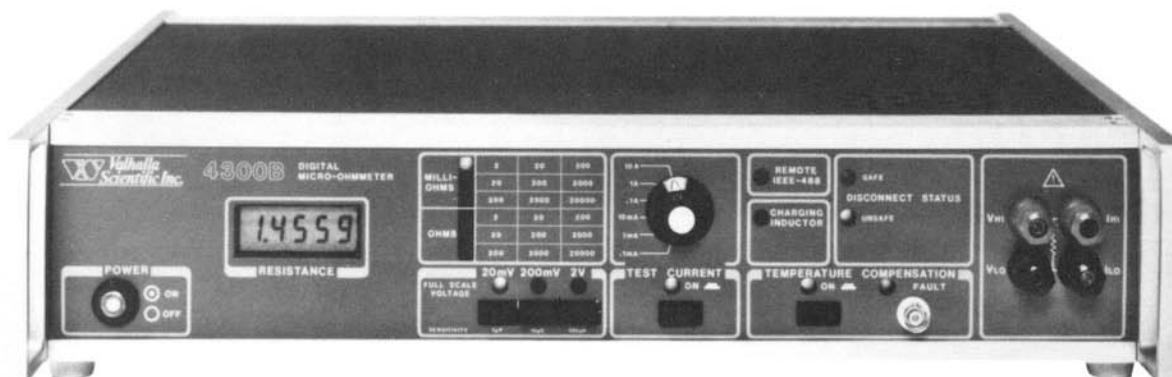
 GPIB

4300B-Performance That Conquers Any Resistance

Valhalla Scientific's new 4300B Digital Micro-Ohmmeter quickly and accurately measures a wide variety of low resistance devices ranging in value from 100 nano-ohms to 20 kilo-ohms. The flexible measurement format of the 4300B provides six ranges of user selectable test current (from .1mA to 10A) and three voltage sensitivity settings (20mV, 200mV and 2V). The unit's 4½ digit resistance readings are displayed on a razor-sharp, high-contrast L.C.D. display and are optionally available via BCD or GPIB interface. Built-in performance features of the 4300B

include: four-terminal compensation, a fast-settling charge inductor mode, safety disconnect status indicators, automatic temperature compensation, a basic accuracy of $\pm 0.03\%$ and a "dry-circuit" current on/off selector.

The 4300B is the perfect instrument for tackling ultra-low resistance testing requirements associated with motors, transformers, fuses, connectors, breakers, bonding/weld resistance and many other applications. For rapid testing of inductive loads the 4300B's charge-inductor mode provides in excess of 20V compliance. This new model

reduces settling time by a factor of 5:1 on inductive loads. The net result is valid readings in minutes instead of hours when testing 400 megawatt utility transformers. A solid-state "Crow-Bar" design provides front-end protection for up to 500 amps of peak induced current.

For IEEE-488 based systems installation or rugged field use, the 4300B is optionally available with positive mating, rear-panel mounted "Bendix" connectors. The rear terminal option is designated "JB-2" and is compatible with the heavy duty, four-wire "KC" lead set.

Specifications

Resistance Ranges	Resolution	Test Current		
		F.S.Volts: 20mV	200mV	2V
2mΩ	0.1μΩ	10A	—	—
20mΩ	1μΩ	1A	10A	—
200mΩ	10μΩ	100mA	1A	10A
2Ω	100μΩ	10mA	100mA	1A
20Ω	1mΩ	1mA	10mA	100mA
200Ω	10mΩ	100μA	1mA	10mA
2KΩ	100mΩ	—	100μA	1mA
20KΩ	1Ω	—	—	100μA

Accuracy: (180 days 24°C \pm 2°C) \pm .03% of reading \pm 2 digits (\pm 2 digits on 20mV range \pm .01% of reading on 10 amp range)

CMR Ratio: 60db at DC, 50Hz & 60Hz

Display: 4½ digit (19999) LCD

Overload Indication: Display Flashes

Terminal Configuration: Four-wire Kelvin. Front terminals standard, rear Bendix terminals optional

Maximum Input: 500 amps peak induced current

Temperature Range: 5°C to 50°C

Temperature Coefficient: (5°C to 24°C and 26°C to 50°C) \pm .005% of reading per °C.

Conversion Rate: Approximately 2.5/sec.

Compliance Voltage: 7.5 VDC nominal at 10A resistive, 20 VDC nominal while charging inductor

Size: 432mm/17" L x 432mm/17" W x 89mm/3.5" H

Weight: 9.1 KG/20 lbs NET, 11.8 KG/26 lbs Shipping

Ordering Information

Model 4300B	Digital Micro-Ohmmeter	\$2,595.00
Option "AL"	Temperature Compensator	150.00
Option "BCD-1"	BCD Data Output	100.00
Option "CU"	Temperature Compensator	150.00
Option "CK"	Compensator Extension Cable	25.00
Option "JAWS"	Heavy Duty Kelvin Clip Set	50.00
Option "JB-2"	Rear Panel Bendix Terminals	50.00
Option "K"	4-Wire Kelvin Lead Set	89.00
Option "KC"	4-Wire Bendix Lead Set	35.00
Option "KCS"	Gold Plated Kelvin Clip Set	35.00
Option "KK"	4-Wire Kelvin Lead Set	100.00
Option "KL"	Heavy Duty Kelvin Lead Set	150.00
Option "MP-1"	Kelvin Micro-Probe Set	125.00
Option "MP-2"	Kelvin Mini-Probe Set	125.00
Option "MP-4"	Kelvin Surface Probe Set	295.00
Option "MP-5"	Kelvin Surface Probe Set	295.00
Option "RX3"	Rack Mount Adaptor	30.00
Option "SP-2"	Two Year Spares Kit	125.00
Option "TL-488"	IEEE-488 Talk/Listen Interface	495.00
Option "M4300B"	Additional Operating/Maint. Manual	50.00



4100ATC Low Level Digital Ohmmeter

The Valhalla Scientific Model 4100ATC Digital Ohmmeter represents an economical solution for low level resistance measurement applications. Built-in features like Automatic Temperature Compensation, four terminal input, inductive kick-back protection, and a high intensity 4½ digit LED display make the 4100ATC ideal for a wide variety of applications including small and medium sized motors and transformers.

On its 200 milliohm full scale, the 4100ATC provides a resolution of 10 micro-ohms. All ranges utilize a fixed 200mV sensitivity. The 200mV pre-amp sensitivity permits rock solid measurement capability even in high noise environments. Six ranges of selectable constant current are available from 1 amp on the 200 milliohm range to 10 microamps on the 20KΩ range.

Housed in a tough but handsome extruded aluminum enclosure with built-in kickstand/bail, the 4100ATC is well suited for benchtop and

factory floor use. Available rackmount kit, Option "R1" easily converts this benchtop unit into a 19" RETMA compatible rack configuration. The 4100ATC is also available with "BCD" outputs for GO/NO-GO testing or data acquisition applications. Consult the end of this section for complete details on digital ohmmeter accessories.

Specifications

Range	200 mΩ	2 Ω	20 Ω	200 Ω	2KΩ	20KΩ
Resolution	10 μΩ	100 μΩ	1 mΩ	10 mΩ	100 mΩ	1 Ω
Test Current	1 A	100mA	10mA	1mA	100μA	10μA

Voltage Sensitivity: 200mV full scale

Accuracy: (180 days 25°C ± 10°C)
± .02% reading ± 2 digits

CMR Ratio: 60db at DC, 50Hz & 60Hz

Display: 4½ digit (19999) L.E.D.

Overload Indication: Display Flashes

Terminal Configuration: Four-wire
Kelvin

Maximum Input: 10 amps peak

Operating Temperature Range: 0°C to
50°C

Temperature Coefficient: ± .002% / °C
(from 0°C to 15°C and 35°C to 50°C)

Conversion Rate: Approximately 3/sec.

Temperature Sensors: ("AL" & "CU")
Add ± .05% of reading to instrument
accuracy. T.C. is accurate to
± 10ppm/°C.

Compliance Voltage: 5 VDC nominal

Power: 115/230 VAC ± 10% 50-60Hz

Size: 230 mm/9" L × 350 mm/15" W/
64 mm/2.5" H

Weight: 5.4 KG/12 lbs Net, 6.5KG/15 lbs
Shipping

Ordering Information

Model 4100ATC	Digital Ohmmeter	\$1295.00
Option "AL"	Aluminum Compensator	150.00
Option "BCD"	Data Outputs	100.00
Option "CU"	Copper Compensator	150.00
Option "CK"	Compensator Extension Cable	25.00
Option "JAWS"	Heavy Duty Kelvin Clips	50.00
Option "KCS"	Kelvin Clip Set	35.00
Option "K"	Kelvin Clip Cable Set (with KCS)	89.00
Option "KK"	Kelvin Clip Set (with JAWS)	100.00
Option "MP-1"	Kelvin Micro-probes	125.00
Option "MP-2"	Kelvin Mini-probes	125.00
Option "R1"	Rack Mount Adaptor	75.00
Option "SP-2"	Two Year Spares Kit	125.00
Additional	Operation/Maintenance Manual	40.00

Digital Ohmmeters



4150ATC Digital Micro-Ohmmeter

When you need the added measurement assurance of one micro-ohm resolution, the 4150 ATC is an excellent choice. It's 20mV pre-amp sensitivity permits high resolution resistance measurement with a minimum amount of test current. Thermistor, strain gauge and contact resistance testing are just a few of the many applications where the 4150 ATC low power dissipation in the test sample is needed to maintain measurement integrity.

The 4150 ATC provides six pushbutton selectable resistance ranges from 20 milliohms full scale to 2000 ohms. The 4½ digit integrating ADC provides .005% resolution which equates to one microvolt per digit. The built-in patented constant current source provides low noise, stable output current from 1 ampere to 10 microamperes. Up to five volts can be dropped across the load and associated series resistance while maintaining constant current output status.

As on all Valhalla ATC models, the 4150 ATC features Automatic Temperature Compensation to eliminate the effects of varying ambient temperature on high T.C. materials. Optional compensating sensors referenced to 20°C are available from stock for copper and aluminum. Consult Valhalla for availability on other T.C.s and reference points. The 4150 ATC utilizes a 4-wire Kelvin input configuration and is available with a host of 4-wire probes, lead sets and clips.

Specifications

Range	20 mΩ	200mΩ	2Ω	20Ω	200 Ω	2KΩ
Resolution	1μΩ	10μΩ	100μΩ	1mΩ	10mΩ	100mΩ
Test Current	1 A	100mA	10mA	1mA	100μA	10μA

Voltage Sensitivity: 20mV full scale

Accuracy: (180 days 25°C ± 10°C)
± .02% of reading ± 3 digits

CMR Ratio: 60db at DC, 50Hz & 60Hz

Display: 4½ digit (19999) L.E.D.

Overload Indication: Display Flashes

Terminal Configuration: Four-wire Kelvin

Maximum Input: 10 amps peak

Operating Temperature Range: 0°C to 50°C

Temperature Coefficient: ± .002% /°C (from 0°C to 15°C and 35°C to 50°C)

Conversion Rate: Approximately 3/sec.

Temperature Sensors: ("AL" & "CU")

Add ± .05% of reading to instrument accuracy. T.C. is accurate to ± 10ppm/°C.

Power: 115/230 VAC ± 10% 50-60Hz

Size: 230 mm/9" L × 350 mm/15" W/
64 mm/2.5" H

Weight: 5.4 KG/12 lbs NET 6.5KG/15 lbs Shipping

Ordering Information

Model 4150ATC	Digital Micro-ohmmeter	\$1795.00
Option "AL"	Aluminum Compensator	150.00
Option "BCD"	Data Outputs	100.00
Option "CU"	Copper Compensator	150.00
Option "CK"	Compensator Extension Cable	25.00
Option "JAWS"	Heavy Duty Kelvin Clips	50.00
Option "KCS"	Kelvin Clip Set	35.00
Option "K"	Kelvin Clip Cable Set (with KCS)	89.00
Option "KK"	Kelvin Clip Set (with JAWS)	100.00
Option "MP-1"	Kelvin Micro-probes	125.00
Option "MP-2"	Kelvin Mini-probes	125.00
Option "R1"	Rack Mount Adaptor	75.00
Option "SP-2"	Two Year Spares Kit	125.00
Additional	Operation/Maintenance Manual	40.00

Digital Ohmmeters



4165 and 4165-1344 Contact Resistance Ohmmeters

The model 4165 and 4165-1344 have been specifically engineered to tackle the difficult application of contact resistance measurement. A detailed application note on the topic of contact resistance measurement is located at the front of this section.

Manufacturers and users of switches, connectors and relays are all concerned with the mating quality of the contact surfaces. The most critical test method for verifying this mating quality is the "dry" contact resistance measurement. The 4165 and 4165-1344 preserve the inherent "Dry" circuit status by means of an active electronic clamp across the output terminals of the built in constant current source. Each unit also offers a 2V minimum compliance mode to facilitate resistance measurement of the contacts in the "non-dry" condition. The 4165-1344 also features a polarity reversal switch to allow the user to check for the presence of thermal E.M.F.s in the measurement circuit.

Both units provide six pushbutton selectable resistance ranges from 200 milliohms to 20Kohms. All ranges use fixed 20mV full scale voltage sensitivity. Constant current output is available in decade increments from 100 milliamperes to 1 microamp. Clamp voltage on the 4165 is 50mV while the 4165-1344 is set at 20mV. Either unit is ideal for testing to MIL-S-83504 and MIL-S-22710 and the 4165-1344 goes on to meet the more rigorous demands of MIL-STD-1344.

Specifications

Range	200mΩ	2 Ω	20 Ω	200 Ω	2K Ω	20K Ω
Resolution	10μΩ	100μΩ	1mΩ	10mΩ	100mΩ	1Ω
Test Current	100mA	10mA	1mA	100μA	10μA	1μA

Voltage Sensitivity: 20 millivolts full scale

Accuracy: (180 days 25°C ± 10°C)
± .02% of reading ± 3 digits

Display: 4½ digit (19999) LED

Overload Indication: Display flashes when display register capability has been exceeded.

Overrange: Both units include 100% overrange (19999) in all modes except the 20mV clamp mode of the 4165-1344 which is 20% overrange (120.00mΩ maximum) on the 200mΩ range and 50% overrange on all other ranges.

Terminal Configuration: 4-wire Kelvin

Operating Temperature Range: 0°C to 50°C

Temperature Coefficient: ± .002% /°C (from 0°C to 15°C and 35°C to 50°C)

CMR Ratio: 60db at DC, 50Hz & 60Hz

Conversion Rate: 300 millisecond nominal

Compliance Voltage: Greater than 2V in the 2V mode, 50mV max and 20mV max for the 4165 and 4165-1344 respectively in the clamping mode.

Polarity Reverse: Front panel selectable 4165-1344 only.

Power: 115/230 VAC ± 10% 50-60Hz

Size: 230 mm/9" L x 350 mm/15" W / 64 mm/2.5" H

Weight: 5.4 KG/12 lbs NET, 6.5KG/15 lbs Shipping

Ordering Information

Model 4165	Contact Resistance Ohmmeter	\$1995.00
Option 4165-1344	Contact Resistance Ohmmeter	2145.00
Option "BCD"	Data Outputs	100.00
Option "JAWS"	Heavy Duty Kelvin Clips	50.00
Option "KCS"	Kelvin Clip Set	35.00
Option "K"	Kelvin Clip Cable Set (with KCS)	89.00
Option "KK"	Kelvin Clip Set (with JAWS)	100.00
Option "MP-1"	Kelvin Micro-probes	125.00
Option "MP-2"	Kelvin Mini-probes	125.00
Option "R1"	Rack Mount Adaptor	75.00
Option "SP-2"	Two Year Spares Kit	125.00
Additional	Operation/Maintenance Manual	35.00

Digital Ohmmeters

4020 Digital Ohmmeter

The 4020 is Valhalla's most economical digital ohmmeter. Although the 4020 is available at a surprisingly low cost, this unit is packed with features you'd expect to find only on instruments priced two to three times higher. To start with the 4020 is built around a low noise, high resolution analog to digital converter. The measurement is then displayed from 1 milliohm resolution to 2 megohms full scale on a high intensity, 4½ digit, L.E.D. readout. As with all Valhalla ohmmeters, the 4020 uses a four-terminal output configuration to eliminate lead wire and contact resistance errors. This means no more pot twiddling to compensate for lead resistance. The 4020's four-terminal measurement technique provides for stable and repeatable low resistance readings. This kind of measurement performance cannot be obtained with a typical two-wire meter.

This tough benchtop instrument features a high impact injection molded case with a handy tilt bail/handle that is easily adjusted to the perfect viewing angle. The 4020 comes standard with "no hassle" AC power capability and a detachable line cord. As an added convenience in portable applications, the 4020 is available with an optional heavy duty rechargeable battery pack. A 6 VDC battery charger/eliminator is recommended with the battery pack option and is designated as Option "A".

For applications requiring data output the 4020 is available with "BCD". The "BCD" talk only interface is fully compatible with our Model 1248 Dual Limit Comparator and is mutually exclusive with the battery pack option. As with all Valhalla digital ohmmeters, the 4020 is available with a host of 4-wire probes and cable sets. Consult the end of this section for complete information on digital ohmmeter accessories.



Specifications

Range	20 Ω	200 Ω	2K Ω	20K Ω	200K Ω	2M Ω
Resolution	1m Ω	10m Ω	100m Ω	1 Ω	10 Ω	100 Ω
Test Current	10mA	1mA	100μA	10μA	1μA	100nA

Accuracy: (180 days 25°C ± 5°C)
± 0.05% of reading ± 2.5 digits

Voltage Sensitivity: 200mV full Scale, all ranges

CMR Ratio: 60db at DC, 50Hz & 60Hz

Display: 4½ digit (19999) L.E.D.

Terminal Configuration: 4-wire Kelvin

Overload Indication: Display Flashes

Maximum Input: 250 VDC or peak AC

Operating Temperature Range: 0°C to 50°C

Temperature Coefficient: ± .002% /°C
(from 0°C to 15°C and 35°C to 50°C)

Conversion Rate: Approximately 300m seconds

Power: 115/230 VAC ± 10% 50-60Hz

Size: 235 mm/9" L x 216 mm/8.5" W/
x 64 mm/2.5" H

Weight: 1.6 KG/3.5 lbs NET, 3 KG/6.5 lbs Shipping

Ordering Information

Model 4020	Digital Ohmmeter	\$449.00
Option "A"	Battery Charger/Eliminator	15.00
Option "BCD"	Data Outputs	100.00
Option "CC4"	Meter and Accessory Carrying Case	35.00
Option "HDB"	Rechargeable Battery Pack	65.00
Option "JAWS"	Heavy Duty Kelvin Clips	50.00
Option "KCS"	Kelvin Clip Set	35.00
Option "K"	Kelvin Clip Cable Set (with KCS)	89.00
Option "KK"	Kelvin Clip Set (with JAWS)	100.00
Option "MP-1"	Kelvin Micro-probes	125.00
Option "MP-2"	Kelvin Mini-probes	125.00
Option "R4"	Rack Mount Adaptor	50.00
Option "SP-2"	Two Year Spares Kit	50.00
Additional	Operation/Maintenance Manual	20.00

Digital Ohmmeters

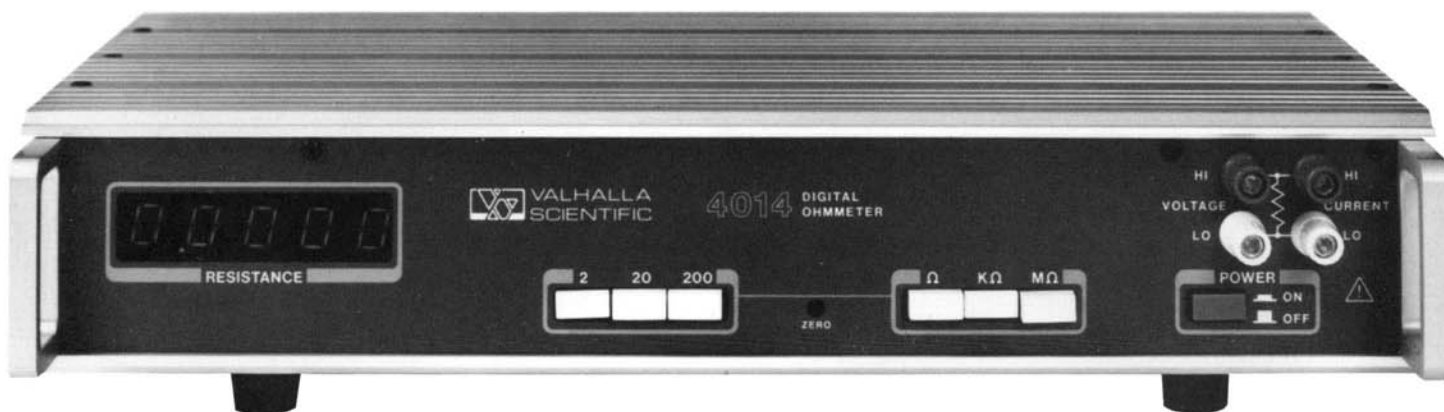

4014 Wide Range Digital Ohmmeter

The 4014 is Valhalla Scientific's widest range digital ohmmeter. Its measurement capability spans thirteen decades of resistance from 100 micro-ohm resolution to 200 megohms full scale. The wide dynamic measurement capability of the 4014 makes it ideal for a great variety of low level and general purpose resistance applications.

The human engineered front panel range selection format permits the operator to easily select one of nine resistance ranges. The proper range is called up by engaging one of the function switches (Ω , $K\Omega$ or $M\Omega$) and one of the range multiplier switches (2, 20, 200). All ranges include a 100% overrange capability and like all Valhalla ohmmeters, the readings are instantaneous and automatic, no manual balancing or fractional scale interpolation. The 4014 uses a 200mV pre-amp sensitivity when operating in the ohm and Kohm modes. In order to maximize reading stability in the megohm ranges, a two volt full scale sensitivity is utilized.

Packaged in a sturdy, extruded aluminum enclosure, the 4014 is tough and built to last. LSI construction minimizes parts count and enhances long term reliability. Four-terminal input configuration on the 4014 eliminates lead wire and contact resistance error. The

4½ digit high intensity L.E.D. display provides excellent readability in normal and low ambient light conditions. The 4014 is available with an optional "BCD"

output for use with Valhalla's Model 1248 Dual Limit Comparator. See Section 5 for complete information on the Model 1248 and accessories.

General Specifications

Range	2 Ω	20 Ω	200 Ω	2K Ω	20K Ω	200K Ω	2M Ω	20M Ω	200M Ω
Resolution	100 $\mu\Omega$	1m Ω	10m Ω	100m Ω	1 Ω	10 Ω	100 Ω	1K Ω	10K Ω
Test Current	100mA	10mA	1mA	100 μ A	10 μ A	1 μ A	1 μ A	100nA	10nA
Full Scale	← 200mV →						← 2V →		

Accuracy: (180 days 25°C ± 10°C)
 ± .02% of reading ± 1 digit for 2 ohm range through 200Kohm range, ± .02% of reading ± 3 digits, on 2Mohm range, ± 0.1% of reading ± 10 digits on 20Mohm range, ± 1% of reading ± 100 digits on 200Mohm range

CMR Ratio: 60db at DC, 50Hz & 60Hz

Display: 4½ digit (19999) L.E.D.

Terminal Configuration: Four-wire Kelvin

Overload Indication: Display Flashes

Maximum Input: 250 VDC or peak AC

Operating Temperature Range: 0°C to 50°C

Temperature Coefficient: ± .002% /°C (from 0°C to 15°C and 35°C to 50°C)

Conversion Rate: Approximately 3/sec.

Power: 115/230 VAC ± 10% 50-60Hz

Size: 230 mm/9" L × 350 mm/15" W/64 mm/2.5" H

Weight: 5.4 KG/12 lbs NET 6.5 KG/15 lbs Shipping

Ordering Information

Model 4014	Digital Ohmmeter	\$995.00
Option "BCD"	Data Outputs	100.00
Option "JAWS"	Heavy Duty Kelvin Clips	50.00
Option "KCS"	Kelvin Clip Set	35.00
Option "K"	Kelvin Clip Cable Set (with KCS)	89.00
Option "KK"	Kelvin Clip Set (with JAWS)	100.00
Option "MP-1"	Kelvin Micro-probes	125.00
Option "MP-2"	Kelvin Mini-probes	125.00
Option "R1"	Rack Mount Adaptor	75.00
Option "SP-2"	Two Year Spares Kit	125.00
Additional	Operation/Maintenance Manual	40.00

Digital Ohmmeters

4314 Series Digital Igniter Testers

The 4314 Series Digital Igniter Testers are portable digital ohmmeters which have been specifically designed for ultra-safe resistance testing on explosive devices.

There are a variety of critical military, aerospace and industrial applications which utilize squibs and other blasting devices. In each case, it is extremely important that these devices detonate when required. It is equally important that these devices do not detonate while being tested for coil integrity. To this end, Valhalla equips each instrument with a redundant, dual fail-safe current limiting network to insure that the instrument test currents cannot exceed the specified amount. Even in the unlikely event of a worst case component failure, the output current limiting network is still in effect. To prove that this level of safety is intact in every unit we ship, a worst case component failure is simulated during final test with the resulting output recorded and attached to the unit. Obviously, this high degree of safety engineering is not available on any general purpose test and measurement equipment.

The 4314's utilize a four-wire Kelvin input configuration to eliminate lead wire and contact resistance error. The units are battery powered with a heavy duty rechargeable ni-cad pack for portability and line isolation purposes. An AC adaptor type battery charger is standard. For added convenience and safety, the 4314's feature an internal switching configuration which automatically disables the battery charging circuit when in the operate mode. Alternatively, all power is removed from the output circuitry when in the off/charging mode. The instrument enclosure is a high impact injection molded case with a convenient tilt bail/handle that



adjusts to the perfect viewing angle. When ordered with the "BCD-MX" option, the 4314's may be used

with Valhalla's 1248 Dual Limit Comparator without compromising safety or line isolation.

General Specifications

4314A Ranges	20Ω	200Ω	2KΩ	20KΩ			
4314B Ranges		200Ω	2KΩ	20KΩ			
4314AN Ranges	20Ω	200Ω				2MΩ	20MΩ
4314BN Ranges		200Ω			200KΩ		
Resolution	1mΩ	10mΩ	100mΩ	1Ω	10Ω	100Ω	1KΩ
Test Current	10mA	1mA	100μA	10μA	1μA	100nA	10nA
Fail Safe	15mA	1.5mA	150μA	15μA	5μA	5μA	5μA

Accuracy: (180 Days, 25°C ± 10°C)
 ± 0.02% of reading ± 0.02% of range for 20Ω through 200KΩ ranges. ± 1.0% of reading ± 0.2% of range for 2MΩ range. ± 2.0% of reading ± 0.2% of range for 20MΩ range.

Display: 4½ digit (19999) L.E.D.

Terminal Configuration: Four-wire Kelvin

Overload Indication: Display Flashes

Maximum Input: 250 VDC or peak AC without damage

Operating Temperature Range: 0°C to 50°C

Temperature Coefficient: ± .002% /°C (from 0°C to 15°C and 35°C to 50°C)

Conversion Rate: Approximately 3/sec.

Power: Rechargeable Ni-Cad batteries and charger (115 VAC ± 10% 50-60Hz)

Size: 235 mm/9" L × 216 mm/8.5" W/64 mm/2.5" H

Weight: 1.6 KG/3.5 lbs NET 3 KG/6.5 lbs Shipping

Ordering Information

Model 4314A	Digital Igniter Tester	\$ 1,295.00
Model 4314B	Digital Igniter Tester	1,295.00
Model 4314AN	Digital Igniter Tester	1,395.00
Model 4314BN	Digital Igniter Tester	1,395.00
Option "BCD-MX"	Data Outputs	200.00
Option "CC4"	Meter & Accessory Carrying Case	35.00
Option "HDB"	Spare Battery Pack	65.00
Option "JAWS"	Heavy Duty Kelvin Clips	50.00
Option "KCS"	Kelvin Clip Set	35.00
Option "K"	Kelvin Clip Cable Set (with KCS)	89.00
Option "KK"	Kelvin Clip Set (with JAWS)	100.00
Option "MP-1"	Kelvin Micro-probes	125.00
Option "MP-2"	Kelvin Mini-probes	125.00
Option "R1"	Rack Mount Adaptor	75.00
Option "SP-2"	Two Year Spares Kit	50.00
Additional	Operation/Maintenance Manual	40.00



4650A Programmable Digital Igniter Tester

Valhalla Digital Igniter Testers have been accepted as the industry safety standard for testing explosive devices since the early 1970s. Since that time, some fourteen models have evolved to satisfy the multitude of applications demanding absolute, safe non-destructive testing of various igniter elements.

The Valhalla 4650A Programmable Digital Igniter Tester is the latest in engineering technology for ultra-safe, high accuracy resistance testing on explosive squibs and other blasting devices. The **battery powered** 4650A igniter tester offers a wide variety of capabilities such as galvanically isolated measurement circuitry with true ohms measurement capability, GPIB (IEEE-488) interface, 6 digit resolution (249999 counts) with 0.008% basic accuracy and uncompromising safety.

Any one of the previous fourteen versions of the 4314 series may be replaced by the new micro-processor based Valhalla 4650A.

Multiple Levels of Fail Safe Circuitry

The heart of the Valhalla 4650A design and operation is the **Passive fail-safe system circuitry**. The 4650A is not reliant on any active circuitry (ie., optical isolation) to maintain current limiting protection. Independent of the microprocessor (Motorola 68000) and all active circuitry, the 4650A igniter tester is constructed such that it cannot exceed any fail-safe specified current levels even upon switching power on or off. Using **current limiting** networks is just the beginning of the Valhalla 4650A fail-safe design scheme.

Again, like the Valhalla 4314A igniter tester, the battery charging circuitry has, for safety considerations, internal switching which automatically disables the battery charging circuit when in power on/operate mode. Alternately, all power is removed from the output terminals when in the off/charging mode. For additional safety, the 4650A **measurement circuitry is fully floating** from chassis potentials and the battery charging circuitry. This means it is safe to measure any device with the cord plugged into line power from an isolation standpoint.

The Valhalla 4650A operation includes a **complete microprocessor-based fail-safe test routine**, with fail-safe active diagnostic indication on a bright, easy to read 1/2" 20 character vacuum fluorescent display. If a fault in the 4650A circuitry does occur, the internal diagnostics displays the fault, even though the unit maintains fail-safe current limiting.

Full isolation between the measuring circuitry, the battery, the GPIB circuitry and the 4650A Igniter Tester power supply prevents a component or circuit failure in one section from affecting the isolation and protection schemes that limit the fail-safe current levels at the output terminals.

For added safety, the 4650A igniter tester is resistance range configured/limited upon ordering from Valhalla, so an operator can only select a desired number of ranges (up to 4) along with the associated fail-safe current levels. Refer to the range selection table on the next page for more detailed information.

Digital Ohmmeters

Feature Packed for System Applications

The Valhalla 4650A is the first igniter tester to offer a talk/listen IEEE-488 interface. Galvanic isolation of the measurement circuitry from the GPIB circuitry prevents electrical spikes from other system instruments being transferred to the 4650A measurement circuitry.

When used in GPIB mode, the 4650A can make up to 6 measurements per second, with selectable integration rates. The 4650A microprocessor intelligence even prompts the operator with front panel LEDs as to which terminals should be used for 2-wire vs. 4-wire hookup.

The intelligent 4650A has on-board test diagnostics. By selecting the test mode via keypress or GPIB command, the 4650A measures several internal reference resistors (depending upon the ranges installed) and informs the user as to the unit's operational integrity status.

High Accuracy True Ohms Measurements

The basic 80ppm accuracy of the Valhalla 4650A is attained through elimination of thermal EMF offset errors via "true ohms" circuitry. The **elimination of thermal EMFs** is attained by turning the test current off and measuring the voltage offset, then turning the current on and measuring the voltage potential again.

In "true ohms" mode, the test current is only on one-tenth (1/10) of the time compared to the constant mode. Even when the current is on in "true ohms mode", all current limiting circuitry is fully enabled. Since the test

current is off 90 percent of the time in true ohms mode, this significantly lowers power dissipation levels across the explosive element (ie, squib) under test, which provides an additional margin of safety.

By limiting the open circuit voltage (ie, clamping) on the 4650A a true ohms **dry contact resistance** measurement may also be performed. The compliance voltage of the Valhalla 4650A is **fully clamped at 50mV** up to the 20K Ω range and 500mV on all higher ranges. The Valhalla 4650A open circuit voltage clamping avoids a common source of error encountered with most meters whose open circuit voltage is too high to measure "dry-contact" resistance.

Front Panel "Covers-On" Calibration

The Valhalla 4650A has two levels of calibration integrity, both performed with accuracy and ease in mind. First, the 4650A user has front panel access to the short "internal-calibration" routine. The "internal-calibration" compensates for ambient temperature differences (ie., rack cabinet), internal amplifier offsets and other minor circuit alignment errors the 4650A may encounter.

Secondly, the Valhalla 4650A may be completely calibrated externally with the instrument covers on via the front panel or using the GPIB option. There are no trim pots to adjust during the external calibration sequence. The intelligent 4650A uses internal non-volatile memory (ie., NOVRAM) to digitally store correction offsets. Leaving the cover on during the external calibration means no open lid ambient temperature effects upon any internal components.

Specifications

Range	2 Ω	20 Ω	200 Ω	2K Ω	20K Ω	200K Ω	2M Ω	20M Ω
Accuracy	.015%	.008%	.008%	.008%	.008%	.008%	.015%	.05%
Test Current	5mA	500uA	50uA	5uA	500nA	500nA	50nA	5nA
Fail Safe*	7.5mA	750uA	750uA	750uA	750uA	750uA	750uA	750uA
Voltage Limit	50mV	50mV	50mV	50mV	50mV	500mV	500mV	500mV
Order Range#	1	2	3	4	5	6	7	8

For Example. A Valhalla 4650A 1 3 6 7 would specify the 4650A ohmmeter equipped with 2 Ω , 200 Ω , 200K Ω , 2m Ω ranges. For specifying cases where less than four ranges are needed, use "0" for no range; example: 4650-2 5 0 0 would come equipped with 20 Ω and 20k Ω ranges only.

*Fail Safe Current for all ranges is 7.5mA when 2 Ω range is fitted.

COMMON MODE: 77dB @ 50/60 Hz (CMRR)

NORMAL MODE: 35dB @ 50/60 Hz (NMRR)

POWER: 45-65 Hz @ 105-130V or 210-260V

SIZE: 3 1/2" H x 17" W x 17" D (89mm x 432mm x 432mm)

WEIGHT: 20 Lbs. net, 27 Lbs. shipping (9Kg, 12.5Kg)

VIBRATION: Per MIL-T-28800C, Type III, Class 5, Style E

Ordering Information

Valhalla 4650A Digital Igniter Tester	\$3,795.00
Option "RX-3" Rack Mount Adapter	60.00
Option "K" Kelvin Clip Cable Set	89.00
Option "KK" Kelvin Clip Set (with JAWS)	100.00
Option "GP-1" 1 Meter GPIB Cable	95.00
Option "MP-1" Kelvin Micro-Probes	125.00
Option "MP-2" Kelvin Mini-Probes	125.00
Option "SP-2" Two Year Spare Parts Kit	185.00
Additional Operation/Maintenance Manual	50.00

Digital Micro-Ohmmeter Accessories

Digital Ohmmeter Accessories

- 1. "A"—Battery Charger:** (Standard on 4314; optional on 4020) This AC adaptor provides DC current for recharging ni-cad batteries in the portable ohmmeters.
- 2. "AL"/"CU"—Temperature Compensators:** (For all ATC models) For aluminum the "AL" (4030ppm/°C) and for copper the "CU" (3931ppm/°C) provide a 20°C reference. Other coefficients and reference temperatures available upon request.
- 3. "BCD"/"BCD-MX"—Data Outputs:** BCD is available with all AC powered models. 1-2-4-8 parallel, binary coded decimal, positive "1" state. BCD-MX is a multiplexed format and is available with the 4314s only.
- 4. "CC4"—Meter & Accessory Carrying Case:** Accommodates either the 4314s or the 4020 with extra room for test leads, probes, manuals, etc...
- 5. "CK"—Shielded Extender Cable:** Allows options "AL" and "CU" to be placed in closer proximity to ambient of test sample.
- 6. "HDB"—Heavy Duty Rechargeable Ni-Cads:** Provides battery power for models 4020 and 4314 for approximately 20 hours. Requires option "A" for overnight recharging. Standard on 4314, optional on 4020.
- 7. "JAWS"—Heavy Duty Kelvin Clip Set:** 2" opening for use on large bushings, transformers and motors. Provides true 4-wire measurement. Can accommodate up to 150 amps.
- 8. "JB-2"—Rear Terminal Heavy Duty Connectors:** Available on 4300B only, this option provides rear-mounted Bendix connectors for positive mating in systems or rugged field applications.



- 9. "KCS"—Light Weight Gold Plated Kelvin Clip Set:** For 4-wire measurement on smaller components and loads. Opens to ½" and can accommodate up to 10 amps of test current.
- 10. "K"—4-Wire Kelvin Lead Set:** 48" shielded cable terminated in "KCS". Recommended lead set for 4 terminal Valhalla Digital Ohmmeters.
- 11. "KK"—4-Wire Kelvin Lead Set:** 48" shielded cable terminated in "JAWS". (All models).
- 12. "KC"/"KL"—4-Wire 10' Heavy Duty Kelvin Lead Set:** Constructed of heavy gauge lead wire for 10 Amp compatibility. Terminated in "JAWS" for quick, reliable load connection and either positive mating Bendix connectors ("KC") or banana plugs ("KL"). Both sets available in custom lengths up to 50 feet. "KC" requires "JB-2" rear terminal option on 4300B.
- 13. "MP-1"—Kelvin Micro-Probes:** 48" shielded cables terminated in spring loaded steel tips with .05" separation.
- 14. "MP-2"—Kelvin Mini-Probes:** 48" shielded cables terminated with stainless steel tips, separation is .18".
- 15. "MP-4"/"MP-5"—4-Wire Kelvin Surface Probes:** Engineered to support the B-1 Bomber program, these probes permit rapid, repeatable bonding testing on a variety of screened or flat surfaces. Test current is evenly distributed through the probe base while potential sensing is accomplished via spring loaded center contact. For constant results with smaller target areas the "MP-5" offers a reduced surface diameter of .5".
- 16. "TL-488"—IEEE-488 GPIB Talk-Listen:** For model 4300B only. Allows control through the IEEE-488 Bus for automatic ranging and resistance measurement data accumulation.
- 17. "R1"/"R4"/"RX3"—Rack Mount Adaptor:** 19" x 3½". R1 is for models 4014, 4100, 4150 and 4165. R4 accommodates models 4314 and 4020. RX3 provides rack mounting for the 4300B.
- 18. "Model 1248"—Dual Limit Comparator:** For use with BCD output for hi/lo limit testing. Relay output optional, detailed information may be located in the comparator section of this catalog.

Digital Wattmeters



Digital Power Analyzers

Valhalla Scientific has been designing and manufacturing Digital Power Analyzers (DPAs) or Digital Wattmeters since 1973. Our customer's requirements in both the areas of increased frequency response and improved accuracy at extremely low Power Factors have driven our design engineers to develop the 2100 Series and 2300 Series DPA meters we have today.

Digital Power Analyzers are being utilized in increasing numbers in a variety of general purpose, industrial and research applications. Compared to analog power measurement equipment, Digital Power Analyzers provide quick, direct readout capability for volts, amps and watts. In addition, Valhalla's family of DPAs offer higher resolution, increased measurement accuracy, more bandwidth and a wider power factor response capability than can be obtained with typical analog wattmeters.

General Capabilities

Valhalla's comprehensive line of Digital Power Analyzers range from inexpensive single phase benchtop units to multichannel GPIB system wattmeters. Each of our Digital Power Analyzers has been designed to measure and display V-A-W. This digital information is available from a choice of 4 1/2 digit models with two and three simultaneous display readouts. Besides our IEEE-488 interfaceable system's DPAs, Valhalla has a host of other models available with optional BCD and analog outputs.

Valhalla's Digital Wattmeters provide a direct readout of **True Watts**, **True RMS Current** and the **True RMS Voltage** applied to the load. Because of our broad bandwidth performance, our high accuracy and resolution, our ability to accommodate a wide range of power factors and our ability to provide data outputs for recording purposes, the Valhalla series of Digital Power Analyzers have been accepted as the standard of the industry.

Valhalla's DPAs, because of their 20 KHz bandwidth and their ability to directly display WATTS-VOLTS-AMPS, have several distinct advantages over analog wattmeters. Typical analog wattmeters do not respond to and often miss the energy levels associated with higher frequency harmonic components, such as color burst signals in televisions and high frequency energy in switching power supplies. Because of Valhalla's higher bandwidth, these high frequency energy levels are not overlooked.

Fundamentals of Power Measurement

Examine the relationship current and voltage play in defining a power or watts measurement.

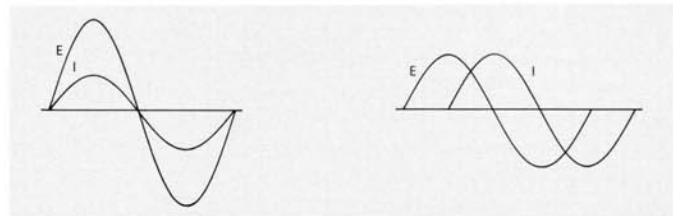

Figure A. Voltage and current in phase Figure B. Voltage is leading current

In an AC power measurement, the true power (P) is the product of the voltage (E) and current (I) modified by power factor which is the cosine of the phase shift angle between the voltage and current. For Sine wave loads:

$$P = EI \cos\phi$$

or

$$\text{True Watts} = \text{Volts} \times \text{Amps} \times \cos\phi$$

With a pure resistive load, both the current and voltage are in phase, and the phase shift angle ϕ is 0 degrees.

$$\text{If } \phi = 0^\circ \text{ Then } \cos 0^\circ = 1 = \text{P.F.}$$

As loads vary from pure inductive through resistive to capacitive, the phase angle varies from -90° to 0° to $+90^\circ$ and the power factor varies from zero to unity.

With an ideal resistive load, the sinusoidal current and voltage are in phase (angle = 0°), the cosine is 1 and the true power (watts) will be the voltage times the current. As loads vary from being inductive, reactive, capacitive or resistive, the phase shift (cos ϕ) of E to I can vary from zero to 1.

Watts Converter

The success of the Valhalla wattmeter design is centered around a four quadrant multiplier. The significance of the four quadrant theory is to provide a proper

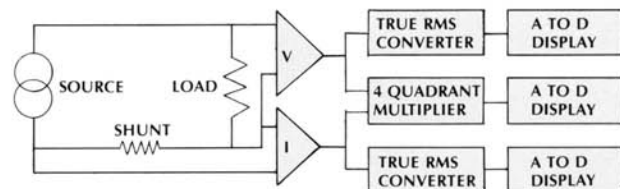

Digital Power Analyzer Block Diagram

Digital Power Analyzers

computation for watts under any phase relation between voltage and current to insure that indeed $EI \cos \phi$ or true power consumption is being measured. That is, the four quadrant multiplier takes the instantaneous product of both E and I. Valhalla uses a proprietary wideband VLSI multiplier design to capture high order harmonics and thereby ensure an accurate watts product. Once the multiplicative watts product is achieved, it is in turn filtered, passed through the A to D converter and displayed.

True RMS AC & DC Current Measurement

All of Valhalla's Digital Power Analyzers feature True Root-Mean-Square (TRMS) current measurement capability. There are less expensive measurement techniques available, but Valhalla uses only True RMS AC converters to consistently provide accurate results even in the presence of highly distorted waveforms. Most loads consume current in an extremely non-linear manner as encountered in SCR controllers, full wave rectified input stages, fluorescent lamp ballasts, and switching mode regulated power supplies. To accurately determine power factor and VA, it is imperative to accurately measure the TRMS value of the waveforms associated with the power measurement. The TRMS value of an AC signal is equivalent to the amount of DC signal required to produce the same heating effect in the same load.

$$V_{rms} = (\text{average of } V^2)^{1/2}$$

Built-In Wideband Current Shunt

Our Digital Wattmeters use a low impedance resistive transducer element (current shunt) to derive a voltage signal proportional to the current flowing through the load. A unique non-inductive shunt configuration maintains a flat frequency response in our wideband units. The proportional signal is amplified and presented directly to the four quadrant analog multiplier. Additionally, this signal is processed separately through a True RMS converter, where it is digitized and displayed. The Valhalla 2100 and 2300 Series DPAs feature a direct coupled front end design to permit accurate measurement on DC loads as well.

True RMS AC & DC Voltage Measurement

All Valhalla Wattmeters use a DC coupled **True RMS** converter to provide valid data regardless of waveshape. Peak overload indication is implemented for voltage as well as current on all designs. The direct coupled front end design of the 2100 and 2300 Series provides the capability of measuring volts, amps and watts for DC as well as AC circuits in the presence of DC signals.

A waveform containing 10% distortion in the form of asymmetrical signals such as duty cycle variations, high harmonic content, zero offset, and variable amplitude

modulation, will have approximately a 3% difference between the average and the TRMS value of the waveform. The Valhalla design approach assures the use of more creditable results because of the incorporation of the more accurate TRMS converter technique.

Power Factor (p.f.)

The single phase (ϕ) power factor of a load is a function of the true power ($EI \cos \phi$) and the apparent power (EI or volt-amps). In sinusoidal applications, power factor is related to the phase angle between voltage and current.

$$\text{Power Factor} = \frac{\text{True Watts}}{\text{Volts} \times \text{Amps}} \text{ or } \frac{EI (\cos \phi)}{EI}$$

Valhalla's Wattmeters provide the operator with a true watts ($EI \cos \phi$) direct measurement. In addition, simultaneous display of selectable VA parameters allows a simple calculation of Power Factor as W/VA.

$$\text{P.F.} = \frac{\text{WATTS}}{\text{VOLTS} \times \text{AMPS}}$$

Power factor can range in value from 1 to zero depending upon load circuitry being resistive, inductive or capacitive. In non-sinusoidal applications, power factor values provide more insight into the nature of the load circuit than does phase angle. Phase angle, of course, is mainly useful with sinusoidal load circuits.

Valhalla's "PC-Watts" software package allows the 2300 Series Wattmeters to display power factor, VARS, Kilowatt Hours, 3 Phase Power Factor, and Phase Angle on IBM-PC-compatible instrument controllers.

Crest Factor

Crest Factor (C.F.) is a specification which governs the input amplitude excursion conditions under which the instrument will produce accurate measurement results without peak clipping or limiting. Simply stated:

$$\text{C.F.} = \frac{\text{Amplitude Peak Value}}{\text{Amplitude TRMS Value}}$$

The C.F. specification allows the user to ensure the compatibility of an instrument to accurately resolve the TRMS value of the waveform. Valhalla specifies a C.F. of 50:1 for a minimum input signal decreasing to 2.5:1 for a full scale input on the Valhalla Model 2100 DWM. For example, a TRMS signal, measured on the 2 amp range can accurately be resolved with a peak excursion of 5 amps. Measured on the 20 amp range, the signal peak may be increased to 50 amps peak.

$$\text{C.F. Sine Wave} = 1.414$$

$$\text{C.F. Triangular Wave} = 1.73$$

$$\text{C.F. Square Wave} = 1.00$$

Digital Wattmeters

Current Transformers (CTs)

Current transformers allow the Valhalla Digital Power Analyzers to be used in higher current applications than for which they were designed. Commercially available CTs commonly have a high primary current transformer coupled down to 5 amperes in the secondary. The two CTs, option I-150 and I-1000 are designed to step 150 amps down to 150 ma and 1000 amps down to 1 amp respectively. The secondary of the CT supplies the stepped down current through the Wattmeter's current shunt. The resulting watts displayed on the Power Analyzer must be multiplied by the CT's current ratio. CTs are also used to isolate the Wattmeter from the potentials associated with the primary current. Both fixed and clamp-on type CTs are available. Fixed types are normally used for permanent installation where the load current conductor is passed through the center of a toroid type CT. Clamp-on type CTs are faster and easier to use in that they do not require the load conductor to be disconnected and reconnected.

CTs have a normal accuracy of about $\pm 2\%$. Because the Valhalla Wattmeters are much more accurate, it may be desirable in critical applications to correct for the CT's error by measuring the actual turns ratio. For maximum accuracy, the primary current which supplies the core loss may be taken into account. The magnetizing current is normally quite low and may be ignored in most applications. CTs are low frequency devices in general and are best suited for 50Hz to 400Hz applications. In higher frequency applications, the magnetizing currents become more dominant and contribute phase shift error in the power measurement. Since CTs are used to step the current down, they automatically step the voltage up; consequently, the secondary should never be open while the CT is energized as the open circuit potentials can be excessively high.

VALHALLA DIGITAL POWER ANALYZER

Multiply Measurements By:
Current: CT Ratio
Voltage: PT Ratio

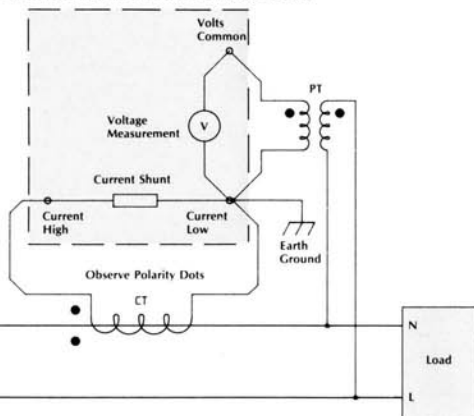

Current Transformer/Potential Transformer Connections

Potential Transformer (PTs)

Potential Transformers (PTs) are used to both scale down high voltages and provide isolation for the Valhalla Power Analyzer. Convenient ratios are 10:1 and 100:1 with accuracies of typically $\pm 2\%$ and bandwidths of 50-400Hz.

Three Phase Power

Three phase power is distributed in 3 ϕ -3 wire and 3 ϕ -4 wire configurations. Valhalla manufactures three phase Digital Power Analyzers to accommodate both configurations. Three phase four-wire loads are normally "wye" and utilize a neutral connection. An unbalanced load condition results in current flow in the neutral or fourth wire. Power instrumentation as shown in Figure 2 measures the individual phase power and total 3 ϕ power ($W_A + W_B + W_C$) independent of load unbalance. The wattmeter illustrated in Figure 2 is three independent wattmeters which may be used individually as three single phase units or as one three phase unit.

For 3 ϕ -3 wire systems, more economical solutions for power measurements are available, in that only two wattmeters are required rather than three, as illustrated in Figure 3. In this connection, ϕB is arbitrarily used as a neutral. Current is measured in Line A and Line C and voltages from A to B and C to B. For load power factors above .5 the total 3 ϕ power is the sum of the two individual power readings.

If the load power factor in the 3 ϕ -3 wire system is below .5, one wattmeter would indicate negative power as the current flow through the shunt relative to the phase voltage creates a negative sign. The total 3 ϕ power is then the difference between the two individual wattmeter readings. The model 2300 automatically accommodates this condition in determining total power.

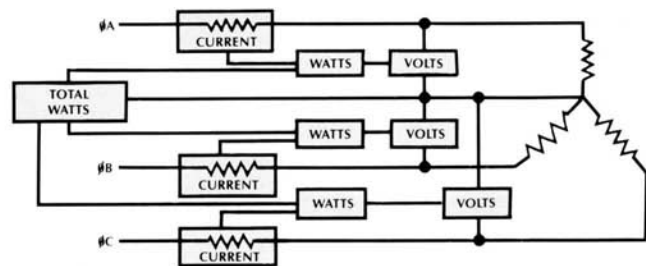

Typical 3 ϕ 4-Wire Load Connection—Figure 2

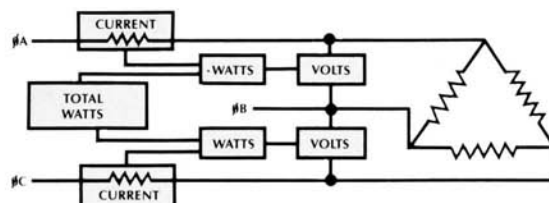

Two Wattmeter Method of 3 ϕ 3-Wire Power Measurement in Accordance with Blondel's Theorem—Figure 3

Digital Power Analyzers



The 2100 & 2101

These two benchtop single-phase Digital Power Analyzers are fully loaded with measurement features you'd expect to find on instruments costing three times the price. Both units boast twin high resolution digital displays, DC to 20kHz frequency response, true power measurement, true RMS voltage and current and built-in peak overload indicators.

True Power Measurement DC to 20kHz Response

When it comes to making tough power measurements, Valhalla's 2100 and 2101 Digital Power analyzers are as tough as they come. The wideband direct-coupled, front-end design of these models permits them to make accurate power measurements, even in the most difficult applications. Switching power supplies, SCR controlled circuits and pulsed DC devices are just a few of the applications requiring the true power measurement capability of Valhalla's 2100 series.

Analog induction-type wattmeters and low-band digital wattmeters simply lack the frequency response capability to accurately capture the true wideband power components of the watts waveform.

True RMS Voltage and Current

High accuracy, large scale integrated circuits are used to convert the True RMS value of a waveform to a proportional DC voltage. This LSI computes the instantaneous square of the input signal, averages it and takes the square root of the result to produce a proportional DC voltage. The TRMS value of current and voltage are extremely useful in computing VA for apparent power factor determinations. The TRMS converters are not involved in deriving WATTS in the power measurement mode.

Chopper Stabilized Front End

A high sensitivity, 1 microvolt, chopper stabilized amplifier features high gain, wideband performance and excellent DC stability to provide internal full scale ranges of 2mV, 20mV and 200mV for high accuracy measurements on low level signals. The result yields optimum resolution on power measurements for nine range combinations of voltage and current.

DC-Wideband Response, Up to 120 kHz

Continuous instantaneous four-quadrant multiplication featuring DC coupling with excellent bandwidth allows accurate power measurements on sinusoidal or non-sinusoidal waveforms. Representative typical load waveforms are illustrated below.

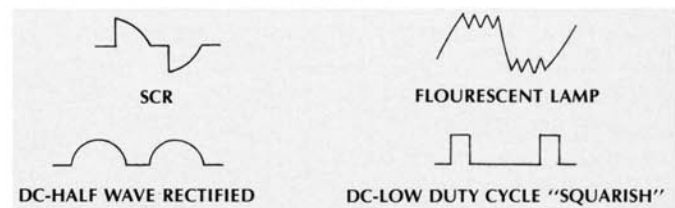

Current/Voltage Peak Overload Indication

These units offer both current and voltage peak crest factor caution/overload indicators. This convenient built-in feature alerts the operator to the presence of peak signal power conditions. The LED indicators illuminate for peaks of 2.5 times the full scale range (i.e. 5 amp peak on the 2 amp RMS range). Should a peak condition exist, simply uprange to gain additional peak response capability.

Single or Dual Channel BCD or Analog Output

To aid in data acquisition applications, the 2100 series DPAs are now available with optional data outputs. The "DMX" option provides raw non-isolated data to one of four available data conditioning units.

The 2190S and D provide isolated single or dual channel 0-5 VDC analog output, while the 2191S and D offer single or dual channel isolated BCD output capability.

Reliability Built-In From the Ground Up

Valhalla Digital Wattmeters are tough and built to last. LSI construction minimizes parts count. The high impact injection molded case has a handy tilt bail/handle that adjusts for the perfect viewing angle and folds to protect the human engineered front panel during storage. All components are high quality "off the shelf", no private label parts to impede local service should it become necessary.

Digital Wattmeters

Improved Product Reliability With Power Analysis

Valhalla's 2100 series wattmeters are commonly used for quality assurance production testing for a wide variety of electrical products. Power efficiency is an excellent quality indicator of a products' performance, especially when compared to identical products. Whether the load is an electronic instrument, an electric motor or power supply, consider the product reliability opportunity for production personnel using low line voltage tests while simultaneously examining power consumption. A given product under test may be meeting it's specifications yet consuming 10% more power than normal. The explanation for increased power consumption could be a faulty or wrong value component, a faulty input transformer, or a binding gear or motor bearing which has not yet failed. Power analysis detects otherwise invisible secondary product problems so you can avoid more costly product field failures and improve your products' reliability reputation.



Rear view of a Valhalla 2100 Series Wattmeter with accessories. Item 1 is the option "X21" load extension cord. Item 2 is the option "I-150" 150 Amp clamp-on C.T. item 3 is the option "I-1000" 1000 Amp Transformer.

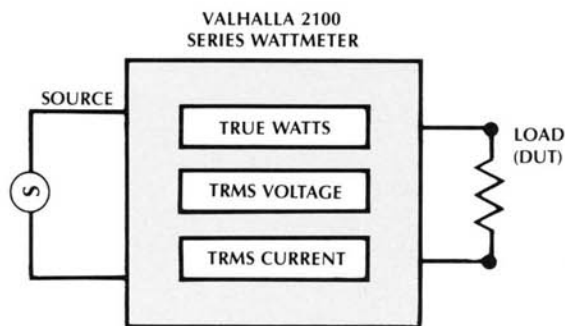

Wattmeter Wiring Diagram—Configured for Monitoring Power (V-A-W) Drawn by the Load (Device Under Test).

Products Typically Improved with Power Analysis

Load monitoring and efficiency determination applications are limitless. Several of the applications served by the Valhalla Digital Power Analyzer include:

- Appliances
- Compressors
- Gyros
- Lamp Ballasts
- Lamps
- Linear Mode Power Supplies
- Medical Instruments
- Motors
- Switching Mode Power Supplies
- Test Instruments
- Transformer Power Loss

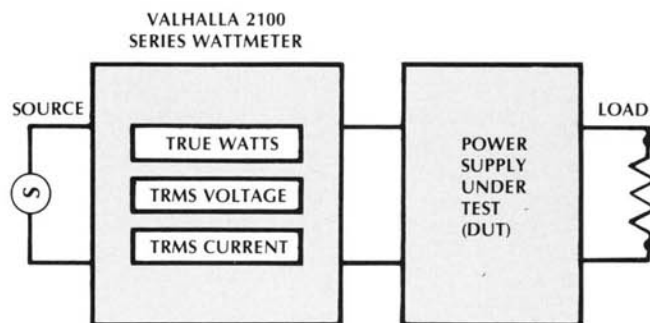

Power Input Measurement of a Device Under Test (DUT) Fig. 1

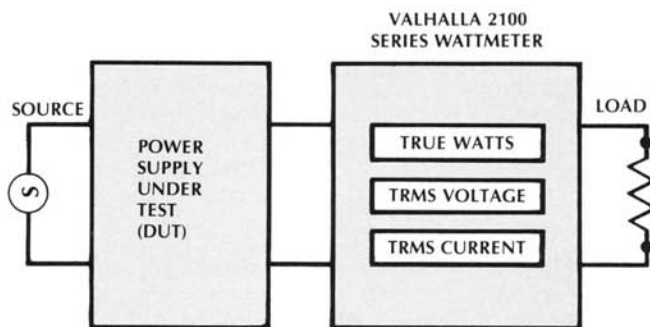

Power Output Measurement of a Device Under Test (DUT) Fig. 2

The Valhalla 2100 series wattmeters do more than determine true power ($EI \cos \phi$) drawn by a load. By taking the difference in power readings from figure 1 and 2 above, the wattmeter can determine the efficiency of the device under test. In this example the device under test can be a transformer, power supply or power source.

Digital Power Analyzers

Specifications

Model 2100 Range/Resolution Table

True RMS Voltage	True RMS Current		
	.2000A	2.000A	20.00A
150.00V	30.00W	300.0W	3000W
300.0V	60.00W	600.0W	6000W
600.0V	120.00W	1200.0W	12000W
True WATTS			

Model 2101 Range/Resolution Table

True RMS Voltage	True RMS Current		
	.2000A	2.000A	20.00A
30.00V	6.000W	60.00W	600.0W
150.00V	30.00W	300.0W	3000W
300.0V	60.00W	600.0W	6000W
True WATTS			

Performance Specifications (Both Models)

AC/DC CURRENT (True RMS)

Crest Factor Response: 50:1 for Minimum RMS input, linearly decreasing to 2.5:1 for full scale RMS input.

Peak Indicator: Illuminates at 2.5 x full scale

Minimum Input: 5% of range

Maximum Input: 35A peak, 20A DC or RMS; 100A DC or RMS for 16mS without damage.

Overrange: 150% of full scale for DC, up to maximum input

AC/DC VOLTAGE (True RMS)

Crest Factor Response: 50:1 for minimum RMS input, linearly decreasing to 2.5:1 for full scale RMS input.

Minimum Input: 5% of range

Maximum Input: 600V DC or RMS AC, 1500V peak

Maximum Common Mode: 1500V peak, neutral to earth

Peak Indicator: Illuminates at 2.5 x full scale

WATTS (True Power-EI cos φ)

Power Factor Response: Unity to zero leading or lagging

Accuracy: (V-A-W 25°C ± 5°C, 1 Year)

DC & 40Hz to 5KHz: ± 0.25% of reading ± 6 digits

5KHz to 10KHz: ± 0.5% of reading ± 0.5% of range

10KHz to 20KHz: ± 1% of reading ± 1% of range (2A range only)

General Specifications

Displays: Dual 4½ digit large, high intensity, 7 segment L.E.D.

Operating Temperature Range: 0°C to 50°C

Temperature Coefficient: ± .025% of range per °C from 0°C to 20°C and 30°C to 50°C

Conversion Rate: Approximately 600mS (1 per second)

Power: 115/230 VAC ± 10%, 50-60Hz, 5 Watts

Size: 23.5cm L x 21.6cm W x 6.4cm H (9.25" x 5" x 8.5" x 2.5")

Weight: 2.3kg (5 lbs) Net, 4.5kg (10 lbs) Shipping

Load Connection: 4 Terminal heavy duty binding posts

Option Specifications

Clamp-on Current Transformer **Option "I-150"**: Extends AC current Measurement capability on the 2100 and 2101 to 150 amps RMS. The 1000:1 output ratios is 2% accurate from 50Hz to 400Hz. The unit accommodates up to ½" diameter conductors.

Clamp-on Current Transformer **Option "I-1000"**: Extends AC current measurement capability to 1000 amps RMS. The 1000:1 ratio CT is 2% accurate from 50Hz to 400Hz.

Data Output Port **Option "DMX"**: Provides non-isolated, multiplexed data input to the 2190S/D or 2191S/D Data Conditioners. The option "DMX" is no charge when ordered in conjunction with a 2100 series DPA and a 2190/2191 Data Conditioner.

Load Power Adaptor Cord **Option "X21"**: Approximately three feet in length for each half, this convenient adaptor cord plugs directly into a standard 115V AC power outlet and mates with the 2100 or 2101 via heavy duty banana jacks. Female half provides for quick and easy load connect or disconnect capability.

Ordering Information

Model 2100	Digital Power Analyzer	\$1,095.00
Model 2101	Digital Power Analyzer	1,095.00
Option "DMX"	Data Output Port	50.00
Model 2190S	Single Channel Analog Output	495.00
Model 2190D	Dual Channel Analog Output	695.00
Model 2191S	Single Channel BCD Output	395.00
Model 2191D	Dual Channel BCD Output	595.00
Option "I-150"	Clamp-on 150A C.T.	125.00
Option "I-1000"	Clamp-on 1000A C.T.	350.00
Option "CC4"	Meter & Accessory Carrying Case	35.00
Option "X21"	115 VAC Load Power Cord	35.00
Option "R4"	Rack Mount Adapter	50.00
Option "SP-2"	Two Year Spare Parts Kit	85.00
Additional	Operating/Maintenance Manual	25.00

Digital Wattmeters

2300 Series Systems Power Analyzers

The 2300 Series Digital Power Analyzers are the automatic choice for a broad range of power measurement applications. Each unit features a 4½ digit tri-mode information readout system which simultaneously displays true RMS voltage, true RMS current and true power. The 2300 series DPA's are loaded with high performance features, which make 1 ϕ and 3 ϕ power measurement as easy as 1-2-3. An optional IEEE-488 interface provides full talk/listen capability for automated systems applications. Single and 11 channel analog output options provide proportional DC voltages for strip-chart recording and data logging applications.

1 ϕ or 3 ϕ Power Measurement — The Choice is Yours

The 2300 and the 2300L Three Phase Digital Power Analyzers are capable of making single phase, two phase (split phase), three phase 3-wire delta and three phase 4-wire wye power measurements. These units may monitor up to three separate single phase loads with V-A-W information for the desired channel available at the touch of a fingertip. Additionally, efficiency of AC power supplies can easily be tested by connecting input and output power to two respective channels of the three phase models.

For dedicated single phase applications, the 2301 and 2301L offer the full range measurement capability of the 2300/2300L, but provide additional cost savings through the elimination of the two extra measurement channels.

True Power Measurement — Zero to Unity Power Factor

Whether you're working at zero or unity power factor and anywhere in between, the proprietary wideband multiplier design of the 2300 Series Digital Power Analyzers guarantees an accurate watts product. In fact, the power measurement integrity of the 2300 remains intact even on tough high frequency switching applications which analog wattmeters and lesser bandwidth digitals just can't handle.

Over one hundred single and three phase power measurement ranges on the 2300 combine to provide readings from one milliwatt resolution, on the ten watt range all the way up to 180 kilowatts direct. This expansive measurement range can be extended even further with the implementation of external current and potential transformers. Power factor calculations can easily be made using the W/VA formula. All necessary data to perform this computation is available from one glance at the instrument's tri-mode display front panel or via the optional IEEE-488 interface, or via Valhalla's "PC-WATTS" software package.



True RMS Current 100 μ A to 100A

The super wide range of input current that the 2300 series is capable of handling directly, spans from 100 micro-amp resolution on the 200 milli-amp range, all the way up to 100 amperes RMS. The nine current ranges covered by the 2300 Series Digital Power Analyzers are made possible through a network of three wideband shunts per phase. The three shunts utilized in each phase represent the results of an extensive engineering study to optimize thermal stability and minimize series inductance, insuring stable wideband performance.

Valhalla employs the use of high bandwidth true RMS AC converter technology to capture and display the true root-mean value of the current waveform, regardless of waveshape. You can count on accurate results long after conventional watt-ammeter readings have dropped off.

DC or True RMS AC Voltage 1mV to 600V

The voltage ranges of the 2300 and 2301 are set up for conventional AC power measurement applications. The four pushbutton selectable voltage ranges cover 50.00V RMS full scale with 10 millivolt resolution up to 600 volts RMS. For special dedicated low voltage applications, such as three phase gyro motor testing, or transformer core loss testing, the 2300L and 2301L provide full-scale voltage ranges of 5.000 volts to 60.00 volts RMS.

The displayed voltage measurement utilizes the same wideband true RMS AC converter technology as that of the current measurement channels. Crest factor response capability is 50:1 for minimum RMS inputs, linearly decreasing to 2.5:1 for full scale RMS inputs.

Digital Power Analyzers



Power Factor Available with "PC-Watts" Software

Valhalla's 2300 Series Wattmeters with IEEE-488 interface (Option "TL-4") now offer **VARs, Power Factor, Volt-Amps (VA's), Kilowatt Hours** and **3-Phase P.F.** computation with the "P.C.-Watts" software utility package. Our menu-driven "P.C. Watts" software package is ideal for use with IBM-PC, XTs, ATs and other compatible instrument controllers. In addition, current transformer ratios and potential transformer ratios are easily accommodated with "PC-Watts".

Valhalla's "P.C. Watts" software operates under Microsoft BASIC, and with pop-up help windows explaining the test generator, the user does not have to write a single line of BASIC code. In addition, actual sample 2300 Series Power Analyzer test programs are included for complete wattmeter data acquisition purposes.

Option "PC-1" software package includes the comprehensive documentation manual and is command compatible with the HP P/N 82990A IEEE-488 PC interface card.

Option "PC-2" software package includes documentation and is command compatible with National Instruments P/N 776-113-01 IEEE-488 PC interface card.

Option PC-3" is the Valhalla "PC-Watts" software package with manual and includes IEEE-488 compatible PC interface card (see GP1 for cable).

Measure Transformer Loss with 2300

When the 2300 is connected for source power measurement, the power display has a negative polarity. The three phase, three wire display sums the power measurements of channel A and C. The result is the 2300 displays the difference between the power drawn by the transformer and the power sourced by the transformer. This difference is less, or the amount of power dissipated by the transformer.

Measure Phase Currents in 3-Wire Systems

The standard three phase, three wire connections allow for display of the Phase A and phase C currents directly. The phase B current is usually measured with an external ammeter. The 2300 can easily be reconnected to measure the phase B current as well.

VAs, WATTS, VARs and PF

The relationship between VAs, WATTS, VARs and PF can best be described in a graphical manner. Figure 1 illustrates these relationships. VAs are determined by multiplying the true RMS voltage and true RMS current measurements of the digital power analyzer. Power factor is the cosine of the angle between VAs and WATTS and can be easily calculated. VARs are easily calculated from VAs and WATTS using the Pythagorean theorem.

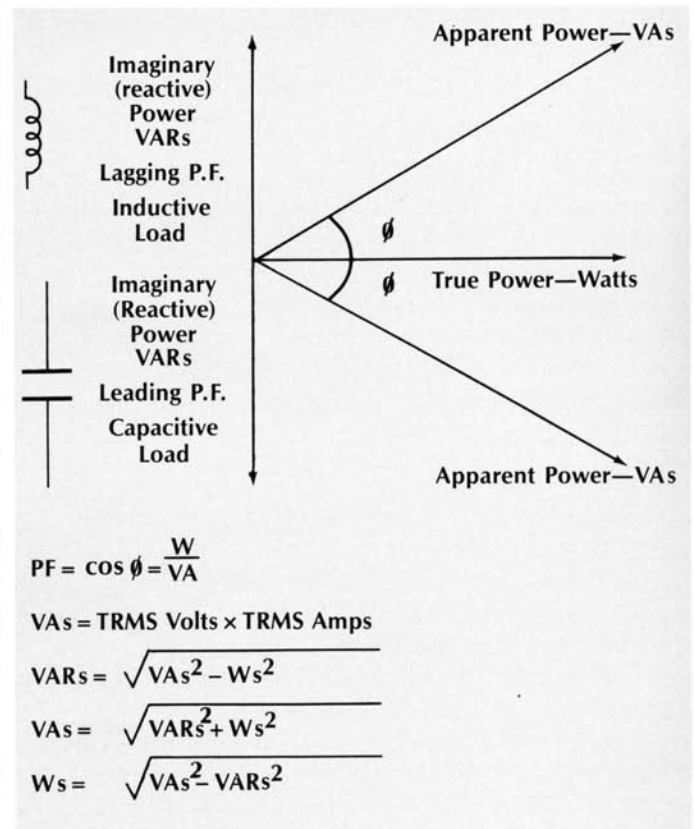

Figure 1: Watts, VAs, VARs and PF

Digital Wattmeters

Built-In Overload Protection

The 2300's are tough and built to last. All measurement connections are made through the instrument's recessed and hinged-cover protected input terminal compartment. Built-in overload protection prevents damage to the instrument for a minimum of 500% overload on current and up to 3000V peak-to-peak on voltage.

The six channel, peak overload monitoring system warns the operator of the presence of peak signals which exceed the crest factor response capability of the RMS converters. Additional peak response capability can easily be gained by selecting the next range up. No other power analyzers offer this level of built-in measurement integrity.

2300 Series Specifications

TRUE RMS CURRENT

Ranges	0.2A, 0.5A, 1.0A	2.0A, 5.0A, 10.0A	20.0A, 50.0A, 100.0A
Resolution	100uA	1mA	10mA
Shunt	0.1Ω	0.01Ω	0.001Ω
Bandwidth	Low Shunt 20Hz-10KHz	Medium Shunt 10Hz-5KHz	High Shunt 20Hz-1KHz
Overload	2A continuous, 5A 1000 mSec	20A continuous, 50A 100 mSec	150A continuous, 500A 100 mSec

Accuracy: (One Year, 25°C ± 5°C): ± 0.25% of reading ± 0.25% of range

Crest Factor: 50:1 for minimum RMS input linearly decreasing to 2.5:1 for full scale RMS input

Minimum input: 5% of range

Peak Overload: Illuminates at 2 × range

TRUE RMS VOLTAGE

Model 2300 & 2301 Range/Resolution Table

Ranges (VAC RMS)	50.00	150.00	300.0	600.0
Resolution	10mV	10mV	100mV	100mV
Impedance	1 megohm all ranges			

Model 2300L & 2301L Range/Resolution Table

Ranges (VAC RMS)	5.000	15.000	30.00	60.00
Resolution	1mV	1mV	10mV	10mV
Impedance	100kilo-ohm all ranges			

Accuracy: (One Year, 25°C ± 5°C): ± 0.25% of reading ± 0.25% of range from 20Hz to 10KHz

Crest Factor: 50:1 for minimum RMS input linearly decreasing to 2.5:1 for full scale RMS input

Minimum Input: 5% of range

Peak Overload: illuminates at 2 × range

Maximum Input: 1000V RMS/1500V peak (150V RMS/650V peak for "L" models)

Maximum Common Mode: 1500V peak, neutral to earth

POWER (WATTS)

Single Phase Power Range/Resolution Table*

Ranges	Low Shunt			Medium Shunt			High Shunt		
	0.2A	0.5A	1.0A	2.0A	5.0A	10.0A	20.0A	50.0A	100.0A
50V	10.000	25.00	50.00	100.00	250.0	500.0	1000.0	2500	5000
150V	30.00	75.00	150.00	300.0	750.0	1500.0	3000	7500	15000
300V	60.00	150.00	300.0	600.0	1500.0	3000	6000	15000	30.00KW
600V	120.00	300.0	600.0	1200.0	3000	6000	12000	30.00KW	60.00KW

The 2300 and 2300L have 3 independent, single phase input channels, while the 2301 and 2301L have only 1 single phase channel.

Three Phase 3-Wire Total Power Range/Resolution Table*

Ranges	Low Shunt			Medium Shunt			High Shunt		
	0.2A	0.5A	1.0A	2.0A	5.0A	10.0A	20.0A	50.0A	100.0A
50V	20.00	50.00	100.00	200.0	500.0	1000.0	2000	5000	1000
150V	60.00	150.00	300.00	600.0	1500.0	3000	6000	15000	30.00KW
300V	120.00	300.0	600.0	1200.0	3000	6000	12000	30.00KW	60.00KW
600V	240.0	600.0	1200.0	2400	6000	12000	24.00KW	60.00KW	120.00KW

Three Phase 4-Wire Total Power Range/Resolution Table*

Ranges	Low Shunt			Medium Shunt			High Shunt		
	0.2A	0.5A	1.0A	2.0A	5.0A	10.0A	20.0AKW	50.0A	100.0A
50V	30.00	75.00	150.00	300.0	750.0	1500.0	3000	7500	15000
150V	90.00	225.0	450.0	900.0	2250	4500	9000	22.50KW	45.00KW
300V	180.00	450.0	900.0	1800.0	4500	9000	18000	45.00KW	90.00KW
600V	360.0	900.0	1800.0	3600	9000	18000	36.00KW	90.00KW	180.00KW

*The voltage and power range of the 2300L and 2301L are reduced by a factor of 10:1 over those given for the 2300 and 2301 in the above tables.

Accuracy: (One Year, 25°C ± 5°C): ± 0.25% of reading ± 0.25% of range

Power Factor Response Capability: Zero to unity power factor leading or lagging with no degradation in watts accuracy.

General Specifications

Displays: 3 simultaneous displays V-A-W featuring 5 L.E.D.s each

Operating Temperature Range: 0°C to 50°C

Size: 178mm/432mm/483mm (7" H x 17" W x 19" D)

Weight: 15KG/33 lbs Net, 19KG/41 lbs Shipping

Power: 115/230 ± 10% 50 to 60Hz 40VA

Load Connections: Floating Insulated to 1500V Peak to Chassis

Range Selection: Manual Push Button -IEEE-488 Optional

Warm-Up Time: 30 minutes to specifications

Display A/D Conversion Rate: 3 readings/second

Option Specifications

IEEE-488 Interface Option "TL-4": Microprocessor based talk/listen GPIB interface. Allows full remote ranging capability, plus data output for V-A-W on all channels, plus an on-board integrator to provide continuous watt-hour computation and output.

Single Channel Analog Output Option "I01": Proportionally scaled 0-5 VDC output corresponding to watts input. Available via a rear panel mounted BNC connector.

V-A-W Analog Output Option "I03": Proportionally scaled 0-5 VDC output corresponding to the voltage, current and watts input.

11 Channel Simultaneous Analog Output Option "IOX": Permits simultaneous monitoring of V-A-W for each phase plus three phase 3-wire and 4-wire total power. These proportionally scaled 0-5 VDC signals are available at a 24 pin connector located on the rear panel. IOX is not compatible with Option "TL-4".

Ordering Information

Model 2300	3Ø Digital Power Analyzer	\$4,795.00
Model 2301	1Ø Digital Power Analyzer	2,795.00
Model 2300L	3Ø Digital Power Analyzer	4,495.00
Model 2301L	1Ø Digital Power Analyzer	2,895.00
Option "TL-4"	GPIB KWHR Interface	495.00
Option "PC-Watts"	Software Package	
Option "PC-1"	HPIB Card Compatible	495.00
Option "PC-2"	National Instruments Compatible	495.00
Option "PC-3"	Includes GPIB Card	895.00
Option "I01"	Single Channel Watts Output	100.00
Option "I03"	V-A-W Analog Output	295.00
Option "IOX"	11 Channel Analog Output	495.00
Option "I-150"	150A Clamp-on C.T.	125.00
Option "I-1000"	1000A Clamp-on C.T.	275.00
Option "RX7"	Rack Mount Adapter	60.00
Option "SP-2"	2-Year Spares Kit (3Ø)	295.00
Option "SP-2"	2-Year Spares Kit (1Ø)	195.00
Additional	Operating/Maintenance Manual	45.00

Data Conditioners



The Data Conditioners

Designed specifically to provide isolated data output capability for Valhalla's 2100 and 2101 Digital Power Analyzers, these four new data conditioners are ideal for taming any non-isolated multiplexed BCD output.

The 2190S and 2190D

The 2190 transforms byte serial data into an isolated 0-5V DC output. This proportionally scaled analog format is required for many applications such as data logging and strip-chart recording. The 2190S provides a single channel of analog output (watts only when used with the 2100 or 2101), while the "D" version offers dual channel output capability.

The 2191S and 2191D

Like the 2190, the 2191 also accepts non-isolated, byte serial data from the "DMX" port of a 2100 series Digital Power Analyzer or any 20,000 count byte serial bit parallel device. The 2191 optically isolates and demultiplexes the input data to produce a fully stored parallel BCD output for printing and data reduction applications. The "S" and "D" version indicates single or dual channel BCD output capability respectively. For use with the 2100 series Digital Power Analyzers, the 2191S provides watts only BCD output, while the 2191D offers one channel for watts and another for volts and amps, dependant upon the 2100 display selection.

Specifications

Digital Inputs

Format: Bit parallel, byte serial multiplexed BCD

Logic Level: Less than .8V = 0, greater than 2.4V = 1

Loading: 1 LS TTL load

Connector: Male 25 pin subminiature D

Isolation

Input to Output: 1500 Volts peak

Output to Earth: 1500 Volts peak

Analog Output (2190 only)

Scale Factor: 20,000 counts = 5 Volts

Accuracy: (1 year, 20°C to 30°C) $\pm 0.1\%$ of output $\pm 100\mu\text{V}$

Temperature Coefficient: $\pm 0.01\% \pm 20\mu\text{V}/^\circ\text{C}$

Output Current: 10mA

Connector: Female BNC

Parallel BCD Output (2191 only)

Logic Level: Less than .8V = 0, greater than 2.4V = 1

Drive: 2 TTL loads each

Connector: Female 50 pin Amphenol 57 series

General

Power: 115/230 VAC $\pm 10\%$, 50-60Hz, 15VA

Operating Temperature: 0 to 50°C

Humidity: Up to 70% RH at 45°C non-condensing

Size: 235mm L x 216mm W x 64mm H (9.25" x 8.5" x 2.5")

Weight: 1.6Kg (3.5 lbs.) Net, 2.3Kg (5 lbs.) Shipping

Ordering Information

Model 2190S	Single Channel Data Conditioner	\$695.00
Model 2190D	Dual Channel Data Conditioner	695.00
Model 2191S	Single Channel BCD Conditioner	595.00
Model 2191D	Dual Channel BCD Conditioner	595.00
	Additional Manual	40.00

Digital Comparators



A GO/NO-GO Decision Maker

This compact light weight unit is designed to be used in conjunction with all Valhalla Scientific test instruments and other manufacturer's instruments which have fully parallel BCD or bit parallel digit serial BCD outputs. Programmed by hand, it provides a GO/NO-GO, In-Tolerance/Out-of-Tolerance indication. All input readings are checked to see if they lie between the "LO" and "HI" limits set by individual thumbwheel switches on the front panel. Any value lower than the "LO" limit or higher than the "HI" limit will trigger the respective "LO"/"HI" indicator and turn the "GO" indicator off.

The 1248

The beauty of the 1248 Dual Limit Digital Comparator is that it eliminates operator interpretation of meter readings. Operator error and fatigue are significantly reduced while realizing an increase in testing efficiency of up to 70%. The 1248 helps reduce labor costs and frees valuable technical personnel to perform higher level tasks. Once a test engineer has computed the tolerances for the device under test and entered them into the comparator, testing can be accomplished automatically or semi-automatically with non-skilled labor.

Controller Applications

Option "RC" provides relay closure outputs which can be used to implement an automated batch sorting system for components or products, operate counters, sound alarms or shut off a process. Multiple comparators with incremented limits may be connected in parallel to provide an unlimited number of sorting limits. Resistors, transformers, strain gauges, thermocouples and thermistors are a few items which could be individually toleranced in this manner for matching purposes.

Two normally open sets of relay contacts separately actuate as either preset limit is reached or exceeded. The contacts are rated for a maximum of 100V at 100mA.

Simplicity of Operation

A common application is receiving inspection of precision resistors by unskilled operators using a Valhalla Model 4014 Digital Ohmmeter in combination with a Model 1248 comparator. If, for example, the resistors to be inspected and tested are 1 Kohm $\pm 0.1\%$, the upper limit would be set at 10010, and the lower limit to 09990. If the measured resistance is within these limits, the GREEN indicator will remain illuminated, indicating a within tolerance condition. If either RED indicator is illuminated, that respective limit has been exceeded and the test sample should be rejected.

Five decades of separate and easy-to-use thumbwheel switches are provided to preset the desired lower and upper limits, in base 10 format. Each thumbwheel switch displays the threshold in white numbers on a black faceplate for maximum wide angle visibility.

Digital Comparators

Specifications

Input Code: Five decades binary coded decimal (BCD) 1-2-4-8 parallel date or five decades BCD 1-2-4-8 bit parallel digit serial, positive "1" state.

Input Logic: Standard CMOS level, TTL, Compatible, True "1" State = +3 to 5VDC "0" = 0 to +1 VDC

Upper and Lower Limit Set: Five thumbwheel switches settable 00000 to 99999

In-Limit Indication: Illumination of a single Green LED, no relay contact closure with relay option.

Out of Limit Indication: Illumination of appropriate red LED for either upper or lower limit exceeded. Relay contact closure for appropriate limit exceeded supplied with relay option.

Real Panel Connector: 50 pin Amphenol P/N 57-40500

Size: 152mm L x 152mm W x 63mm H (6"x6"x2.5")

Weight: 1.4kg/3 lbs NET 2kg/5 lbs Shipping

Power: ± 5 VDC, 50mA (available on all Valhalla BCD outputs except model 4300B) AC power supply optional

Input Connection Table

Pin	Input	Pin	Input	Pin	Input	Pin	Input	Pin	Input
1	1's	6	10's	11	100's	16	1000's	21	10000's
2	2's	7	20's	12	200's	17	2000's	22	20000's
3	4's	8	40's	13	400's	18	4000's	23	40000's
4	8's	9	80's	14	800's	19	8000's	24	80000's
26	+5VDC@10ma for external load			50	Common				
45-46	Upper Limit Relay Closure			47-48	Lower Limit Relay Closure				
Latch Inputs									
29	1's	30	10's	31	100's	32	1000's	33	10000's

A "1" (+3V to +5V) latch input allows data inputs to be continuously transferred to comparators. A "0" (0 to +1V) latch input stores data input present previous to "1" to "0" latch transition. The input latches may be used to demultiplex BCD input data by paralleling like data inputs and sequentially driving the latch inputs as digit selectors.

Option Specifications

AC Power Supply Option "AC-1": Provides internal 115 VAC ± 10% 50-60Hz power supply and rear panel mounted 6' power cord.

AC Power Supply Option "AC-2": Provides internal 230 VAC ± 10% 50-60Hz power supply and rear panel mounted 6' power cord.

Input Data Cable Option "IDC": Universally compatible pin to pin 3' cable. Compatible with all Valhalla BCD outputs except 4300B; use "IDC-2" if Option "RC" is required.

Input Data Cable Option "IDC-2": Same as "IDC" except compatible with "RC" Option.

Input Data Cable Option "IDC-3": Similar to "IDC" and "IDC-2" but is compatible with 4300B. Works with or without Option "RC".

Mating Connector Option "MC": 50 pin Amphenol 57-30500 style connector for the fabrication of custom interface cables.

Relay Contact Closure Option "RC": Provides relay contact closure when corresponding high or low limit is exceeded. Contact rated at 100V, 100mA, maximum.

Valhalla Scientific Test Instruments Compatible with Model 1248

Model Number	Description
2100/2101	Digital Power Analyzer
4014	9 Range Digital Ohmmeter
4020	6 Range Digital Ohmmeter
4100 Series	Multiple & Fixed Range Digital Ohmmeters
4300 B	8 Range Digital Micro-Ohmmeter
4314 Series	Igniter Digital Ohmmeter (Fail Safe)

Ordering Information

Model 1248	Dual Limit Comparator	\$395.00
Option "AC-1"	115 VAC Power Supply	25.00
Option "AC-2"	230 VAC Power Supply	25.00
Option "IDC"	Input Data Cable	75.00
Option "IDC-2"	Input Data Cable	75.00
Option "IDC-3"	Input Data Cable	75.00
Option "MC"	Mating Connector	18.00
Option "RC"	Relay Contact Closure	50.00
Additional	Operating/Maintenance Manual	15.00

Sales Offices

Domestic Telephone Numbers

Alabama	(205) 536-1506 Currie, Peak & Frazier
Alaska	(503) 283-0132 Westcon, Inc.
Arizona	(602) 955-2955 Barnhill Associates
Arkansas	(214) 231-2573 Barnhill Associates
California (S)	(619) 268-3500 Mesa Engineering
California (C)	(213) 324-7360 Cutlass Electronics
California (N)	(408) 988-6006 Applied Systems
Colorado	(303) 741-3844 Barnhill Associates
Connecticut	(508) 435-2151 Eastern Systems
Delaware	(215) 224-1663 Robert Myers Associates
Washington, D.C.	(301) 731-8080 Sel-Tronics
Florida	(407) 855-0843 Currie, Peak & Frazier
Georgia	(404) 449-7662 Currie, Peak & Frazier
Hawaii	Contact Factory
Idaho (E)	(801) 226-1239
Idaho (W)	(503) 283-0132
Illinois (NC)	
Illinois (S)	(314) 839-0033 Delltron
Indiana	(317) 253-1681 Comtel
Iowa	(314) 839-0033 Delltron, Inc.
Kansas	(816) 436-6445 Delltron, Inc.
Kentucky (W)	(317) 253-1681 Comtel
Kentucky (E)	(205) 536-1506 Currie, Peak & Frazier
Louisiana	(713) 444-1733 Barnhill Associates
Maine	(508) 435-2151 Eastern Systems
Maryland	(301) 731-8080 Sel-Tronics
Massachusetts	(508) 435-2151 Eastern Systems
Michigan	(313) 477-7700 Carter, McCormic and Peirce
Minnesota	(612) 593-1809 Sector Engineering
Mississippi	(205) 536-1506 Currie, Peak & Frazier
Missouri	(314) 839-0033 Delltron, Inc.
Montana	(503) 283-0132 Westcon, Inc.
Nebraska	(314) 839-0033 Delltron, Inc.
Nevada (N)	(408) 988-6006 Applied Systems
Nevada (S)	(602) 955-2955 Barnhill Associates
New Hampshire	(508) 435-2151 Eastern Systems
New Jersey (N)	(516) 781-7400 Bytec Associates
New Jersey (S)	(215) 224-1663 Robert Meyers Associates
New Mexico	(505) 299-7658 Barnhill Associates
New York City	(516) 781-7400 Bytec Associates
New York (N)	(315) 455-7314 Labtronics
North Carolina	(919) 373-0380 Currie, Peak & Frazier
Ohio (N)	(216) 826-0400 Carter, McCormic & Peirce
Ohio (S)	(513) 836-0951 Carter, McCormic & Peirce
Oklahoma	(214) 231-2573 Barnhill Associates
Oregon	(503) 283-0132 Westcon, Inc.
Pennsylvania	(412) 826-3800 Carter, McCormic & Peirce
Pennsylvania (E)	(215) 224-1663 Robert Myers Associates
Rhode Island	(508) 435-2151 Eastern Systems
South Carolina	(919) 373-0380 Currie, Peak & Frazier
Tennessee	(205) 536-1506 Currie, Peak & Frazier
Texas (E)	(214) 231-2573 Barnhill Associates
Texas (S)	(713) 444-1733 Barnhill Associates
Texas (C)	(512) 451-0217 Barnhill Associates
Utah	(801) 226-1239 Barnhill Associates
Vermont	(508) 435-2151 Eastern Systems
Virginia	(301) 731-8080 Sel-Tronics
West Virginia	(412) 826-3800 Carter, McCormic & Peirce
Wisconsin (S)	(414) 544-6042 Comtel
Wyoming	(303) 741-3844 Barnhill Associates

International Telephone Numbers

A/S MAXETA—Norway	PHO: 45-3-553090 TLX: 856 21409 FAX: 45-3-597940
DELO—Italy	PHO: 39-2-907-22-441 TLX: 843-325885 FAX: 39-2-90722742
DUNCAN—Canada	PHO: 416-742-4448 TLX: 389-06527271 FAX: 416-749-5053
ELECTRONICS CONT—India	PHO: 366665 TLX: 953-08458256
ELMEASCO—Australia	PHO: 61-2-736-2888 TLX: 790-025887 FAX: 61-2-736-3005
INTERCONT. SERVICES—Belgium	PHO: 32-2-660-1356 TLX: 846-21990 FAX: 32-2-660-8124
JOD—France	PHO: 33-1-34-891174 TLX: 842-689485 FAX: 33-1-34-898117
KALIBER—Sweden	PHO: 46-8-380350 TLX: 854-14077 FAX: 46-8-380503
KESTRONICS—Hong Kong	PHO: 852-3-7705055 TLX: 780-51279 FAX: 852-3-7705000
KESTRONICS—Singapore	PHO: 65-2786211 TLX: 786-51039 FAX: 65-2741896
KESTRONICS—Taiwan	PHO: 886-35-263191 FAX: 886-35-255008
KONTRON—W. Germany	PHO: 49-8165-77-526 TLX: 841-526719 FAX: 49-8165-77512
KOREA INDUSTRIAL—Korea	PHO: 82-2-584-2311 TLX: 787-27228 FAX: 82-2-548-2313
MEXITEK—Mexico	PHO: 525-575-9929, 9981, 0312, 0269 TLX: 383-1773239 FAX: 525-575-9981
NORTHROP—New Zealand	PHO: 64-4-856658 TLX: 791-3380 FAX: 64-4-857276
PPM—United Kingdom	PHO: 44-483-301333 TLX: 851-859181 FAX: 44-483-300862
PACISA—Spain	PHO: 39-402-7060 TLX: 831-23014 FAX: 39-402-8938
PRECITEK—Switzerland	PHO: 41-1-7130900 TLX: 845-826763 FAX: 41-1-7130294
SIMAC—Netherlands	PHO: 31-40-582911 TLX: 844-51037 FAX: 31-40-582707
SISTRONICS—Brazil	PHO: 55-11-247-5588 TLX: 391-1157155 FAX: 55-11-523-8457
TECTRA—E. Europe	PHO: 41-55-951212 TLX: 845-875027 FAX: 41-55-954940

Ordering Information

General

All prices quoted are F.O.B Ex Factory, San Diego, CA. Minimum order is \$20.00 for spare parts and \$35.00 for options or instruments.

U.S. terms are net 30 days on approved credit. Unless credit has already been established, shipment will be made on receipt of cash in advance or C.O.D. To establish an open account please contact Valhalla's Credit Department.

Terms for orders from other countries are cash in advance or Irrevocable Letter of Credit confirmed on and payable at a California bank with all banking charges for the account of the buyer.

Upon request, formal quotations and proforma invoices will be furnished by your Valhalla representative or Valhalla Scientific Inc.

U.S.A. Orders

Orders for Valhalla products should be made out to Valhalla Scientific Inc. or Valhalla Scientific Inc. c/o your local representative listed on page 71 of this catalog. Confirming purchase orders are required for shipment and should include: terms, unit ordered with pricing, F.O.B. point and shipping instructions.

Standard shipment in the U.S. for units under 70 pounds will be via United Parcel Service on either a prepay and add or C.O.D. basis. Other shipping methods will be accepted on a "freight charges collect" basis only.

All shipments over 70 pounds, including systems, will be on a "freight collect" basis.

International Orders

Please contact the nearest Valhalla Distributor in the countries listed on page 71 of this catalog for full ordering information. For countries not listed, please contact the International Department at Valhalla Scientific.

Orders for Valhalla products should be made out as instructed by the appropriate distributor. All Valhalla International Distributors have full repair and support capability and provide in-country warranty on units purchased through their offices as well as applications and technical assistance.

All international shipments will be via airfreight. Orders specifying Ocean freight cannot be accepted and will require written modification prior to shipment.

Shipments made on Letters of Credit will be shipped via a "Direct IATA" waybill and insured for full value unless the Letter of Credit designates no insurance and or the acceptability of a freight forwarder's house way bill. All freight charges on international shipments are on a "Freight Collect" basis.

Repairs or Calibration Services

Please contact the Repair Department of Valhalla Scientific for a "Return Material Authorization" number prior to shipment of any units to the factory. Use of the "RMA" number will expedite the repair and return of your instrument.

Valhalla Scientific, Inc.

9955 Mesa Rim Road
San Diego, CA 92121
619/457-5576

Direct Telephone Ordering

TELEX: 181750 VALHALLA SDG
Or Call Toll Free:
1-800-621-0852, ext. 396

FAX: 619/457-0127

Licenses and Trademarks

IBM is a registered trademark of International Business Machines Corporation.

IBM PC XT and AT are trademarks of International Business Machines Corporation.

MS-DOS and PC-DOS are registered trademarks of Microsoft Corporation.

MOUSE SYSTEMS PC PAINT is a trademark of Mouse Systems Corporation.

Dbase III + is a trademark of Ashton-Tate Corporation.

I'm interested in the following Valhalla Scientific Test/Calibration Instruments and would like more information:

- | | | | |
|--|--|--|--|
| <input type="checkbox"/> Automated Calibration Systems | <input type="checkbox"/> Resistance Standards & Calibrator | <input type="checkbox"/> Multifunction Calibrators | <input type="checkbox"/> Digital Ohmmeters |
| <input type="checkbox"/> AC & DC Voltage Calibrators | <input type="checkbox"/> Digital Igniter Testers | <input type="checkbox"/> Digital Power Analyzers | <input type="checkbox"/> Digital Comparitors |
| <input type="checkbox"/> AC & DC Current Calibrators | <input type="checkbox"/> Reference Standards | | |

- Send more information on products checked above.
- Arrange "No Charge" demonstration on products checked above.
- I'd like a Valhalla Instrument Catalog of my own.

Name & Title _____

Company _____ Phone (____) _____

Address _____

City _____ State _____ Zip _____

For immediate requirements contact your local representative listed on the previous page or call the sales department at 619/457-5576. Or call Valhalla FREE

1-800-824-9029 (dial tone) ext. 825, (outside California).

I'm interested in the following Valhalla Scientific Test/Calibration Instruments and would like more information:

- | | | | |
|--|--|--|--|
| <input type="checkbox"/> Automated Calibration Systems | <input type="checkbox"/> Resistance Standards & Calibrator | <input type="checkbox"/> Multifunction Calibrators | <input type="checkbox"/> Digital Ohmmeters |
| <input type="checkbox"/> AC & DC Voltage Calibrators | <input type="checkbox"/> Digital Igniter Testers | <input type="checkbox"/> Digital Power Analyzers | <input type="checkbox"/> Digital Comparitors |
| <input type="checkbox"/> AC & DC Current Calibrators | <input type="checkbox"/> Reference Standards | | |

- Send more information on products checked above.
- Arrange "No Charge" demonstration on products checked above.
- I'd like a Valhalla Instrument Catalog of my own.

Name & Title _____

Company _____ Phone (____) _____

Address _____

City _____ State _____ Zip _____

For immediate requirements contact your local representative listed on the previous page or call the sales department at 619/457-5576. Or call Valhalla FREE

1-800-824-9029 (dial tone) ext. 825, (outside California).

I'm interested in the following Valhalla Scientific Test/Calibration Instruments and would like more information:

- | | | | |
|--|--|--|--|
| <input type="checkbox"/> Automated Calibration Systems | <input type="checkbox"/> Resistance Standards & Calibrator | <input type="checkbox"/> Multifunction Calibrators | <input type="checkbox"/> Digital Ohmmeters |
| <input type="checkbox"/> AC & DC Voltage Calibrators | <input type="checkbox"/> Digital Igniter Testers | <input type="checkbox"/> Digital Power Analyzers | <input type="checkbox"/> Digital Comparitors |
| <input type="checkbox"/> AC & DC Current Calibrators | <input type="checkbox"/> Reference Standards | | |

- Send more information on products checked above.
- Arrange "No Charge" demonstration on products checked above.
- I'd like a Valhalla Instrument Catalog of my own.

Name & Title _____

Company _____ Phone (____) _____

Address _____

City _____ State _____ Zip _____

For immediate requirements contact your local representative listed on the previous page or call the sales department at 619/457-5576. Or call Valhalla FREE

1-800-824-9029 (dial tone) ext. 825, (outside California).



NO POSTAGE
NECESSARY
IF MAILED
IN THE
UNITED STATES

BUSINESS REPLY MAIL

FIRST CLASS PERMIT NO. 175 SAN DIEGO, CA

POSTAGE WILL BE PAID BY ADDRESSEE

VALHALLA SCIENTIFIC, INC.
9955 Mesa Rim Road
San Diego, CA 92121

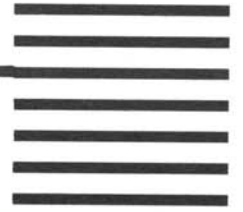

NO POSTAGE
NECESSARY
IF MAILED
IN THE
UNITED STATES

BUSINESS REPLY MAIL

FIRST CLASS PERMIT NO. 175 SAN DIEGO, CA

POSTAGE WILL BE PAID BY ADDRESSEE

VALHALLA SCIENTIFIC, INC.
9955 Mesa Rim Road
San Diego, CA 92121



NO POSTAGE
NECESSARY
IF MAILED
IN THE
UNITED STATES

BUSINESS REPLY MAIL

FIRST CLASS PERMIT NO. 175 SAN DIEGO, CA

POSTAGE WILL BE PAID BY ADDRESSEE

VALHALLA SCIENTIFIC, INC.
9955 Mesa Rim Road
San Diego, CA 92121



Warranty

Valhalla Scientific warrants to its Customers that the instruments it manufactures and sells will be free from defects in materials and workmanship for a period of thirteen months* from date of shipment. In order to obtain service under this warranty, Customer must notify Valhalla of the defect before the expiration of the warranty period and make suitable arrangements with the factory for performance of the service.

This warranty shall not apply to any defect, failure or damage caused by improper use or improper or inadequate maintenance and care. Valhalla shall have no obligation to

provide service under this warranty if a product has been altered, modified or integrated with other products when the effect of such modification or integration increases the time or difficulty of servicing the product; or to repair damage resulting from improper use or connection to incompatible equipment; or damage as a result of repair attempts by non-Valhalla personnel.

If an instrument proves defective during the applicable warranty period, Valhalla Scientific at its option, will repair the defective instrument without charge for parts and labor or will provide a replacement instrument in exchange for the defective instrument.

This warranty is given by Valhalla in lieu of any other warranties, expressed or implied. Valhalla disclaims any implied warranties of fitness for a particular purpose. Repair or replacement of defective instruments is the sole and exclusive remedy provided to the customer and Valhalla will not be liable for any indirect, special, incidental or consequential damages irrespective of whether Valhalla has advance notice of the possibility of such damages.

***See ordering information for full particulars on warranty period.**



VALHALLA
SCIENTIFIC

9955 Mesa Rim Road, San Diego, California 92121, U.S.A.
(619) 457-5576 TLX 181750 Valhalla SDG FAX (619) 457-0127

