

USER'S HANDBOOK

Model 9100

Universal Calibration System

Volume 1 — Operation

Final Width = 215mm

User's Handbook

For

The Model 9100 Universal Calibration System

Volume 1 — Operation

*(for Remote Operation, Instrument Specification, Specification Verification, Routine Maintenance and Calibration
refer to Volume 2 — Performance)*

© 2005 Fluke Corporation. All rights reserved.

All product names are trademarks of their respective companies.



This product complies with the requirements of the following European Community Directives:
89/336/EEC (Electromagnetic Compatibility) and **73/23/EEC (Low Voltage)**
as amended by **93/68/EEC (CE Marking)**.

However, noisy or intense electromagnetic fields in the vicinity of the equipment can disturb the measurement circuit. Users should exercise caution and use appropriate connection and cabling configurations to avoid misleading results when making precision measurements in the presence of electromagnetic interference.

Contents

Page

Volume 1 — Operation *(This Volume)*

Section 1 The Model 9100 Multifunction Calibrator

1.1	About Section 1	1-1
1.2	Introduction to the Model 9100	1-2
1.3	Model 9100 Options and Associated Products	1-6
1.4	UUT Calibration Procedure Library	1-7
1.5	Printer Support	1-8
1.6	UUT Calibration Certificates	1-8
1.7	Inventory Management	1-8
1.8	Documentation	1-8

Section 2 Installing the Model 9100

2.1	About Section 2	2-1
2.2	Lifting and Carrying the Model 9100	2-2
2.3	Unpacking and Inspection	2-2
2.4	Storage	2-3
2.5	Preparation for Shipment	2-3
2.6	Calibration Enable Switch	2-3
2.7	Preparation for Operation	2-4
2.8	Connectors and Pin Designations	2-10

Section 3 Model 9100 Controls

3.1	About Section 3	3-1
3.2	Introduction to the Front Panel	3-2
3.3	Modes of Operation	3-4
	3.3.1 Mode Selection	3-4
	3.3.2 Configuration Mode	3-6
3.4	Working with Front Panel Controls — Tutorials	3-32

	Page
Section 4 Using the Model 9100 — Manual Mode	
4.1 About Section 4	4.1-1
4.2 Interconnections	4.2-1
Functions:	
4.3 DC Voltage	4.3-1
4.4 AC Voltage	4.4-1
4.5 DC Current	4.5-1
4.6 AC Current	4.6-1
4.7 Resistance	4.7-1
4.8 Conductance	4.8-1
4.9 Frequency	4.9-1
4.10 Mark/Period	4.10-1
4.11 % Duty	4.11-1
4.12 Auxiliary Functions	4.12-1
4.13 Capacitance	4.13-1
4.14 Thermocouple Temperature	4.14-1
4.15 RTD Temperature	4.15-1
4.16 Logic-Pulses	4.16-1
4.17 Logic-Levels	4.17-1
4.18 Insulation/Continuity	4.18-1
4.19 DC Power	4.19-1
4.20 AC Power	4.20-1
4.21 AC Harmonics	4.21-1
Section 5 Using the Model 9100 — Procedure Mode	
5.1 About Section 5	5.1-1
5.2 Procedure Mode — Safety and General Notes	5.2-1
5.3 Procedure Mode — Access Guide	5.3-1
5.4 Procedure Mode — 'Adjustment Only' Procedure	5.4-1
5.5 Procedure Mode — '1 Year Verification' & 'ISO9000 Verify' Procedures	5.5-1
5.6 Procedure Mode — 'Verify Pass/Fail' & 'ISO9000 Pass/Fail' Procedures	5.6-1

See Volume 2 — Performance

Section 6 Remote Interfaces

Section 7 Model 9100 Specifications

Section 8 Model 9100 — Routine Maintenance and Test

Section 9 Model 9100 — Specification Verification

Section 10 Model 9100 — Calibration



**DANGER
HIGH VOLTAGE**



**THIS INSTRUMENT IS CAPABLE OF DELIVERING
A LETHAL ELECTRIC SHOCK !**

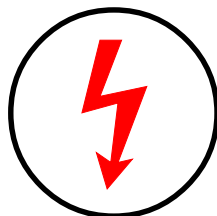

Model 9100: I+, I-, Hi, Lo, sHi and sLo Terminals
Model 9105: H (Red), sH (Red), sL (Black) LI- (Black)
and I+20 (Yellow) Leads carry the Full Output Voltage

THIS CAN KILL !



Avoid damage to your instrument !

Refer to User's Handbook, Volume 2, Section 7; for
Maximum Output Voltages and Currents.

Final Width = 215mm

Unless **you** are **sure** that it is **safe** to do so,
DO NOT TOUCH ANY of the following:
Model 9100: I+ I- Hi Lo sHi or SLo leads and terminals
Model 9105: H sH sL LI- or I+20 leads

DANGER

Section 1 The Model 9100 Universal Calibration System

1.1 About Section 1

Section 1 introduces the Model 9100 Universal Calibration System. It is divided into the following sub-sections:

- 1.2 Introducing the Model 9100
 - 1.2.1 Functions
 - 1.2.2 Operating Modes
 - 1.2.3 System Operation
- 1.3 Model 9100 Options and Associated Products
- 1.4 UUT Calibration Procedure Library
- 1.5 Printer Support
- 1.6 Calibration Certificates
- 1.7 Inventory Management
- 1.8 Documentation

Final Width = 215mm

1.2 Introduction to the Model 9100

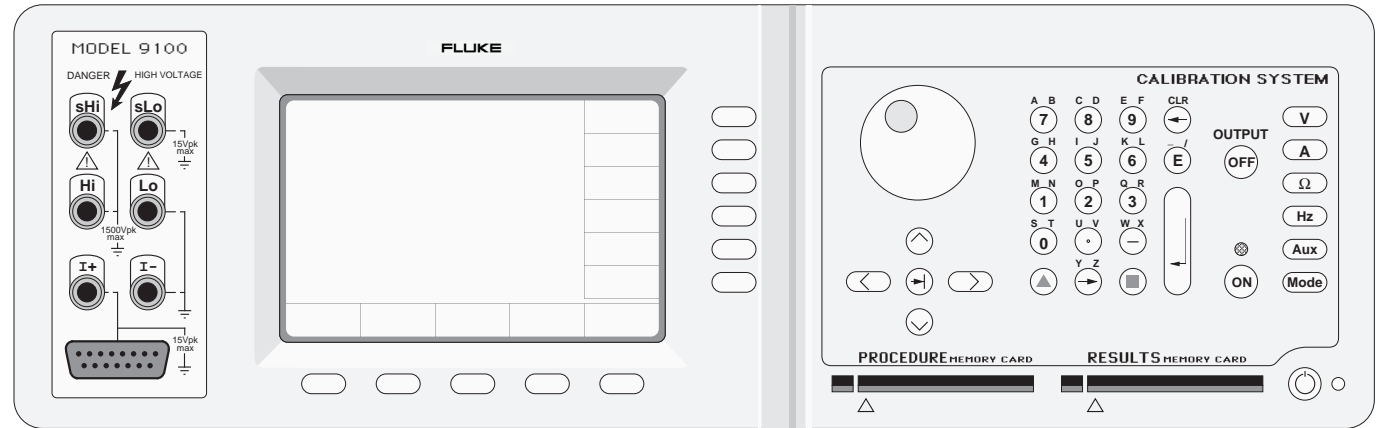

1.2.1 Functions

The Model 9100 is a state-of-the-art calibrator offering multimeter test capabilities, providing wide functionality from a single source. It can calibrate:

Final Width = 215mm

- DC Voltage: 0V to ± 1050 V
- AC Voltage: 0V to 1050V *10Hz to 100kHz*
Waveshapes: *Sinusoidal, Square, Impulse, Triangular and Trapezoidal*
- DC Current: 0A to ± 20 A (*1000A with Option 200*)
- AC Current: 0A to 20A *10Hz to 30kHz* (*1000A with Option 200*)
Waveshapes: *Sinusoidal, Square, Impulse, Triangular and Trapezoidal*
- Resistance: 0Ω to 400M Ω
- Frequency (1:1 Square Wave): 0.5Hz to 10MHz
Voltage Levels (LF): -32V to +32V (HF): -6.5V to +6.5V
- Phase: $\pm 180^\circ$ on ACV and ACI functions
- Mark/Period Ratio: $2.5 \times 10^{-8} : 1$ to $0.999995 : 1$
Pulse widths: 0.05 μ s to 1999.99ms Repetition Intervals: 0.1 μ s to 2000.00ms
Voltage Levels (LF): -32V to +32V (HF): -6.5V to +6.5V
- Per Cent Duty Cycle: 00.05% to 99.95% (2 decimal places)
Repetition Intervals: 0.1 μ s to 2000.00ms
Voltage Levels (LF): -32V to +32V (HF): -6.5V to +6.5V
- Capacitance: 500pF to 40mF
- Conductance: 2.5nS to 2.5mS
- Thermocouple Simulation: Types: B, C, E, K, L, J, N, R, S and T. Temp. Scales: *IPTS-68 & ITS-90.*
Range depends on thermocouple type: *Refer to Section 4, Paras 4.14.*
- RTD Temperature Simulation: 'PT385' (Euro) curve: -200°C to +850°C; or 'PT392' (USA) curve: -200°C to +630°C
Temp. Scales: *IPTS-68 & ITS-90.*
- Logic Stimulus: Pulsed Logic: TTL, CMOS, ECL
Pulse widths: 0.05 μ s to 1999.99ms Repetition Intervals: 0.1 μ s to 2000.00ms
- Logic Stimulus: DC Levels: TTL, CMOS, ECL

1.2.2 Operating Modes

In order to be able to calibrate a wide range of different UUTs, the 9100 has had flexibility built into its design. There are five modes, only two of which, 'Manual' and 'Procedure' determine the everyday use of the instrument. The other three are concerned with system configuration, 9100 calibration and 9100 selftest.

1.2.2.1 Manual Mode

In 'Manual' Mode: the 9100 is operated entirely from the front panel. The operator is in complete charge of the calibration procedure, usually interpreted locally from the UUT manufacturer's calibration data.

1.2.2.2 Procedure Mode

'Procedure' Mode involves the use of a memorized calibration procedure. The manufacturer's data for the UUT will have been interpreted into a series of calibration operations, which are programmed on to a memory card. When the card is inserted into the 'PROCEDURE' slot in the front panel, the 9100 will move from operation to operation, switching the 9100 controls automatically, and issuing a series of requests for the operator to change UUT switching and connections.

1.2.2.3 Configuration Mode

This mode provides access for the user-selectable configuration options. These include:

Direct Access

- Change the viewing angle of the LCD screen display.

Password Access

- Set the instrument to power-up in either Manual or Procedure mode.
- Change the IEEE-488 bus address.
- Enable or disable the use of an external printer (Procedure mode only).
- Enable or disable the use of a data card in the 'RESULTS' slot (Procedure mode only).
- Adjust the threshold for high voltage warning.
- Determine the percentage of UUT measurement tolerance beyond which a 'Borderline' result is called (Procedure mode only).
- Clear the displayed list of Procedure mode users.
- Alter the memorized date and time, and its format of presentation.
- Select the type of certificate required to be printed, alter some of the certificate details, and re-format its pages (Procedure mode only).
- Alter the passwords required for entry to Configuration and Calibration modes.
- Set User language (Procedure mode only).

Final Width = 215mm

Final Width = 215mm

1.2.2.4 Calibration Mode

Calibration of the 9100 itself cannot proceed until two security measures have been satisfied:

1. The rear panel 'CAL' switch must be set to its 'ENABLE' position.

Note: The switch is recessed behind a small hole — at shipment this hole is covered by a paper seal which should not be broken except for an authorized recalibration. A broken seal is regarded as invalidating the previous calibration.

2. An acceptable password must be entered on the screen.

Once into Calibration mode, There are three types of calibration available:

- **'Special'** calibration, enabling automatic calibration of the main A-D converter. This should be used only under supervision — if it is suspected that such calibration may be required, contact your Fluke Service Center.
- **'Factory use only'** is an initial calibration which is not available to users, requiring a second password.
- **'Standard Calibration'** will initiate manual calibration procedures for those functions for which recalibration is required. These are: DC Voltage, AC Voltage, DC Current, AC Current and Resistance

Re-compensation of the Capacitance function is performed automatically on transfer to Capacitance function from another function, only if 20 minutes has elapsed from power on, *and* only if one or more of three conditions are satisfied since the most-recent re-compensation:

- 24 hours has elapsed.
- or* Internal temperature has changed by $\pm 5^{\circ}\text{C}$.
- or* The Resistance function has been externally calibrated.

Those 9100 calibration sequences which are user-accessible are detailed in *Section 10*. If it is suspected that some other calibration may be required, contact your Fluke Service Center.

1.2.2.5 Test Mode

Three main variants of self test are available for user initiation:

- **Fast Test**: This is the same test as is carried out at power-on, checking power supplies, etc., and is intended to give an indication whether the instrument is sufficiently alive to attempt to use.
- **Full Test**: The full test is run to completion. The 9100 will keep a list of all test failures, including the number of the test and its result. Any failures can then be recalled using screen keys.
- **Interface Test**: This can be used to check the operation of the display and its memory, the keyboard, and/or a printer connected to the instrument, and a blank memory card inserted in either slot on the front panel (*WARNING!: the stored contents of any memory card subjected to this test will be over-written!*).

It is possible to print out a set of results of selftests. A printer can be connected directly to the 25-way Centronics™ printer port on the rear panel. The printer can be enabled from within Configuration mode.

Test procedures and error-code descriptions are given in *Volume 2, Section 8*. In the case of a reported or suspected failure, consult your Fluke Service Center.

Final Width = 215mm

1.2.3 System Operation

1.2.3.1 Remote Interface

The instrument can form part of an automated system by means of the IEEE-488 standard digital interface. The interface has been included both for automatic calibration of UUTs, and for automatic calibration of the 9100 itself. In normal operation, the degree of automation available will generally be determined by the manual operation characteristics of the UUT. The method of connecting to the system controller and the IEEE-488.2 SCPI command codes are described in *Volume 2, Section 6*.

1.2.3.2 Portocal II and 9010

The 9100 is included in the number of calibrators accessible through Portocal II and 9010, which can be used to calibrate UUTs remotely.

Final Width = 215mm

1.3 Model 9100 Options and Associated Products

The available options for the 9100 are as follows:

- Option 10 Blank 256kByte, Flash memory.
- Option 30 Blank 256kByte, Static RAM (SRAM), battery backed.
- Option 60 Soft Carry Case.
- Option 70 NAMAS Calibration Certificate traceable to National Standards.
- Option 90 Rack Mounting Kit.
- Option 100 High Stability Crystal Reference.
- Option 200 10- and 50-Turn Current Coils.
- Option 250 250MHz Oscilloscope Calibrator Module.
- or*
- Option 600 600MHz Oscilloscope Calibrator Module.
- Line Voltage: The 9100 is configured for use at the correct voltage at the shipment point.

In addition, the following associated products are available:

- PLC-XXX Procedure Library Cards (*Sub-section 1.4*).
- Model 9105 Comprehensive Lead Set.
- Portocal II Windows Automated Calibration Software and ISO 9000 Database Manager includes full networking capabilities and procedure library, CD-ROM, user's handbook and R & R Report Writer™ package.
- 9010 Windows Procedure Generator and Inventory Management Software offers automated calibration using the 9000, 9100 and 9500 calibrators via the IEEE-488 interface, and the capability to program procedure cards for the 9000, 9100 and 9500 calibrators. 9010 also includes full networking capabilities and procedure library, CD-ROM, user's handbook and R & R Report Writer™ package.

1.4 UUT Calibration Procedure Library

In 'Procedure' Mode, UUT calibration procedures are driven from memorized sequences. These are supplied on FLASH memory cards, each usually holding up to three manufacturer models with three procedure types. The procedures: '1 Year Verification', 'Adjustment' and 'Verify Pass/Fail' contain information based on the manufacturer's published specifications, and are correct at the time of publication. (Users can, of course, generate their own versions of procedures using Portocal II, or 9010.)

The library contains procedures for some of the equipment available from manufacturers worldwide. For a complete updated listing of the Fluke Procedure Library, contact your local sales representative or Fluke Service Center.

For a list of some of the procedures available, refer to the current Procedure Library document.

1.5 Printer Support

9010 and Portocal II software both support around 170 different models of printer. Paper sizes and margins are programmable, allowing text and data to be positioned anywhere on a page.

Final Width = 215mm

1.6 UUT Calibration Certificates

1.6.1 Procedure Mode Results Printouts

ISO 9000 requires that calibration records be maintained for later inspection. Whether or not 9010 / Portocal II is purchased, the Model 9100 Procedure Mode supports two formats for recording results. For a basic certificate of results, or a simple pass-fail format for each test, a printer can be connected directly to the 25-way Centronics™ printer port on the rear panel. The printer is configured from the screen menu.

1.6.2 9010 and Portocal II Custom Certificates

With 9010 and Portocal II, custom certificates can be generated by transferring results to a memory card (SRAM only) inserted in the front-panel 'RESULTS' slot. This card can be read to a personal computer running 9010 or Portocal II software, via a memory card reader. To design a custom certificate, the software uses the R&R Report Writer™ application to control layout, type and graphics.

9010 and Portocal II software also contain pre-designed calibration certificates.

Note about Formatting SRAM Cards as Results Cards:

Before a new SRAM card can be used to store results, it must first be formatted for the purpose. This can be carried out by the Model 9100 in Test mode, as part of the 'Card Slot Test' procedure.

(Refer to Volume 2 of this handbook, Section 8, paras 8.3.4.5).

Final Width = 215mm

1.7 Inventory Management

9010 and Portocal II software both include an inventory database which need not be limited to handheld Multimeters: any item requiring periodic calibration or maintenance can be added.

Database information can be retrieved in several different ways: location, calibration-due date, form of certificate etc.

1.8 Documentation

For reasons of size, the 9100 User's Handbook is divided into three volumes:

This Volume 1 (pt. no. 850300) relates to the basic operation of the 9100, whereas Volume 2 (pt. no. 850301) deals with basic 9100 performance, containing information related to: IEEE-488/SCPI remote command performance, 9100 specifications, routine maintenance, specification verification and calibration. Volume 3 (pt. no. 850306) is concerned entirely with Oscilloscope Calibration using Option 250 (up to 250MHz) and Option 600 (up to 600MHz), and is formatted to include both operation and performance information.

Portocal II and 9010 are documented in the form of a User's Handbook (pt. no. 850315).

Section 2 Installing the Model 9100

2.1 About Section 2

Section 2 contains information and instructions for unpacking and installing the Model 9100 Universal Calibration System. It is divided into the following sub-sections:

- 2.2 Lifting and Carrying the Model 9100
- 2.3 Unpacking and Inspection
- 2.4 Storage
- 2.5 Preparation for Shipment
- 2.6 Calibration Enable Switch
- 2.7 Preparation for Operation
 - 2.7.1 Power Input
 - 2.7.2 Power Cable
 - 2.7.3 Line Voltage
 - 2.7.4 Power Fuse
 - 2.7.5 Mounting
- 2.8 Connectors and Pin Designations
 - 2.8.1 IEEE-488 Input/Output Socket J101
 - 2.8.2 Parallel Port J103
 - 2.8.3 Serial Port J102
 - 2.8.4 Signal Output J109
 - 2.8.5 Phase Lock Connections
 - 2.8.6 'TRIG OUT' and 'SIG OUT' Connections

Final Width = 215mm

Final Width = 215mm

Note about Transportation:

If the 9100 is to be transported, please consider the use of Option 60, which is a soft carry case.

2.2 Lifting and Carrying the Model 9100

Caution! *The 9100 weighs in excess of 18kg, so take special care when lifting and carrying the instrument.*

2.2.1 Lifting and Carrying from Bench Height

1. Disconnect and remove any cables from the rear panel.
2. Tilt the 9100 so that it is standing vertically on its rear panel, with the feet towards you. Pull the instrument towards you at the edge of the bench.
3. Grasp the instrument at the bottom (rear panel) corner furthest away from you, and tilt it slightly to rest against you. Take the weight and carry it vertically at the same height, making sure that it remains resting against you.
4. Place the 9100 down at the same level by setting it vertically on to the surface, then swivel it so that it can be tilted back on to its feet.

2.2.2 Lifting and Putting Down at Low Level

1. Always bend your knees, not your back, when going down. Keep your back as straight and as vertical as possible.
2. Use the same technique (2.2.1 above) to hold the instrument's center of gravity close to you (most of its weight is at the rear).

2.3 Unpacking and Inspection

Every care is taken in the choice of packing materials to ensure that your equipment will reach you in perfect condition.

If the equipment has been subject to excessive mishandling in transit, the fact will probably be visible as external damage to the shipping container and inner carton. In the event of damage, the shipping container, inner carton and cushioning material should be kept for the carrier's inspection.

Carefully unpack the equipment and check for external damage to the case, sockets, controls, etc. If the shipping container and cushioning material are undamaged, they should be retained for use in subsequent shipments. If damage is found notify the carrier and your sales representative immediately.

Standard accessories supplied with the instrument should be as described in Section 1.

2.4 Storage

The instrument should be stored under cover. The shipping container provides the most suitable receptacle for storage, as it provides the necessary shock isolation for normal handling operations.

Place the instrument with an active desiccant sachet inside a sealed bag. Fit the bag into the cushioning material inside the inner carton, place this within the corner cushioning blocks inside the outer shipping container, and locate the whole package within the specified storage environment.

2.5 Preparation for Shipment

The instrument should be transported under cover. The original (double) shipping container should be used to provide shock isolation for normal handling operations. Any other container should be double-cushioned, providing similar shock isolation to the following approximate internal packing dimensions:

	Length	Width	Depth
Outer Box	785mm	675mm	440mm
Inner Box	675mm	565mm	315mm
Cushioned to	550mm	430mm	145mm

Final Width = 215mm

Place the instrument with an active desiccant sachet inside a sealed bag. Fit the bag into the cushioning material inside the inner carton, place this within the corner cushioning blocks inside the outer shipping container, and secure the whole package.

2.6 Calibration Enable Switch

CAUTION

This two-position, 'CAL' switch on the rear panel protects the instrument calibration memory. The instrument was initially calibrated at the factory, so under no circumstances should the switch be operated, until immediate recalibration is intended.

For Recalibration:

If Calibration Mode is entered while the switch is in the 'DISABLE' position, the following warning message is placed on the screen:

Calibration switch not enabled!

2.7 Preparation for Operation

Note: Refer to the Model 9100 General Specifications, including Environmental Conditions: *Volume 2* of this handbook, *Section 7, sub-section 7.1*.

Before preparing the Model 9100 calibrator for operation, note the danger warning:



THIS INSTRUMENT IS CAPABLE OF DELIVERING A LETHAL ELECTRIC SHOCK. THE FRONT PANEL TERMINALS ARE MARKED WITH THE ABOVE 'FLASH' SYMBOL TO WARN USERS OF THIS DANGER.

UNDER NO CIRCUMSTANCES TOUCH ANY INSTRUMENT TERMINAL UNLESS YOU ARE FIRST SATISFIED THAT NO DANGEROUS VOLTAGE IS PRESENT.

Caution: *If the equipment is used in a manner not specified by the manufacturer, the protection provided by the equipment may be impaired.*

Other than the main output terminals and the D-type signal output socket, the connections to the 9100 are via the rear panel:

Final Width = 215mm

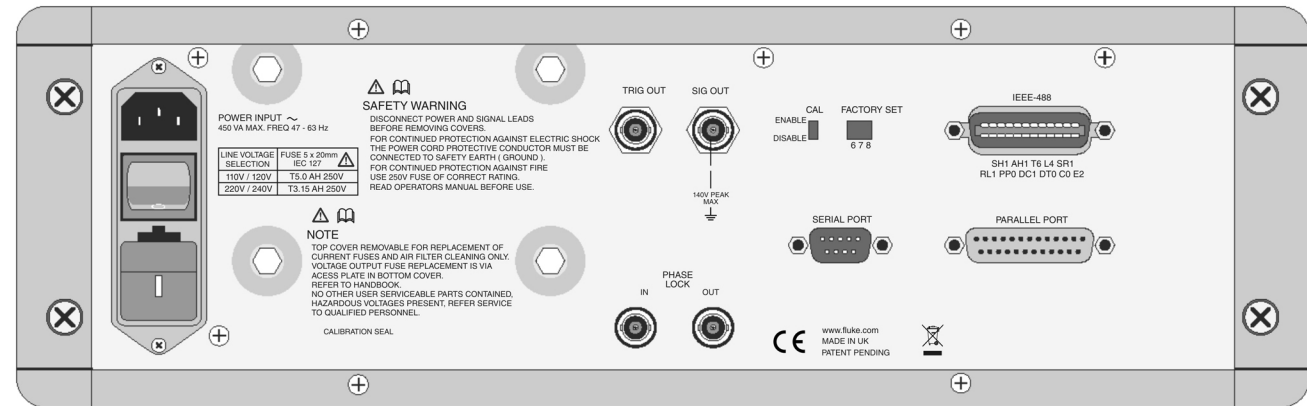

9100 Rear Panel

2.7.1 Power Input

The recessed **POWER INPUT** plug, **POWER FUSE**, **POWER SWITCH** and **LINE VOLTAGE SELECTOR** are contained in an integral filtered module on the left of the rear panel (looking from behind the unit).

A window in the fuse drawer allows the line voltage selection to be inspected. To inspect the fuse rating the fuse drawer must be taken out (*Refer to sub-section 2.7.4. First switch off and remove the power cable*).

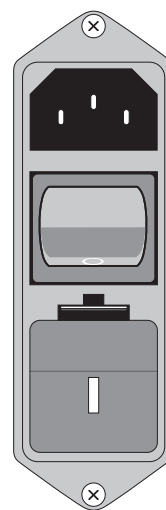

POWER INPUT

POWER FUSE (IEC 127)

100/120 - T 5.0A HBC

220/240 - T 3.15A HBC

POWER 450VA

FREQUENCY 48-63Hz

Final Width = 215mm

2.7.2 Power Cable

The detachable supply cable, comprising two meters of 3-core PVC sheath cable permanently moulded to a fully-shrouded 3-pin socket, fits in the **POWER INPUT** plug recess, and should be pushed firmly home.

The supply lead must be connected to a grounded outlet ensuring that the ground lead is connected. Connect Black lead to Line, White lead to Neutral and Green lead to Ground. (European: Brown lead to Line, Blue lead to Neutral, and Green/Yellow lead to Ground). (The UK power plug internal fuse rating is 5A.)

Final Width = 215mm

2.7.3 Line Voltage

The 9100 is operative for line voltages in the ranges: 100/120/220/240V, 48-63Hz.

To accommodate these ranges, a small voltage selector block is housed behind the **POWER FUSE** drawer.

2.7.3.1 Selection of Operating Line Voltage

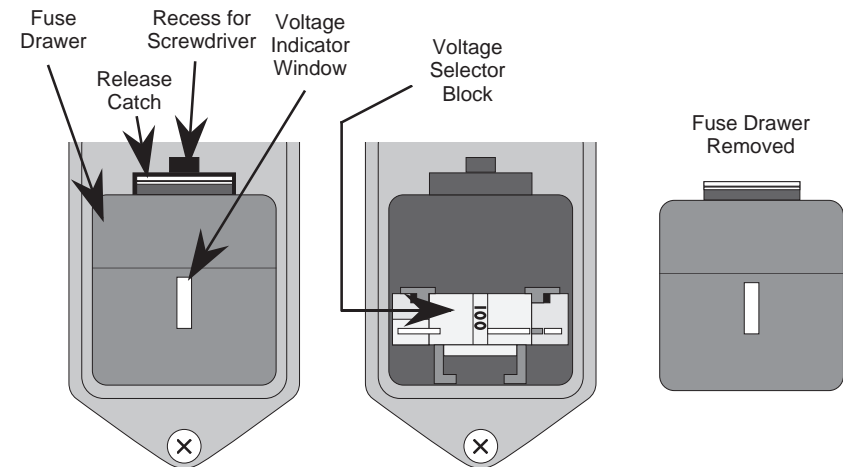

Ensure that the POWER CABLE is removed.

1. Insert a small screwdriver blade in the narrow recess above the catch over the fuse drawer; lever the screwdriver handle gently upwards until the catch releases. Pull the drawer out to reveal the grey voltage selector block.
2. Hook a small finger into the block in the square recess in its base; pull to disengage its contacts, and remove from the module cavity.
3. Rotate the voltage selector board until the desired voltage faces outward.
4. Ensure that the block is upright. Reinsert the block firmly into its cavity in the module.
5. Check the fuse if required (*see paras 2.7.4*), then insert the fuse drawer into the module and press until the catch is heard to click into place.
6. Check that the desired voltage is visible in the cutout in the fuse drawer.

2.7.4 Power Fuse

The fuse rating is:

T 3.15A HBC, 250V, IEC127 for 220/240V line supply

T 5.0A HBC, 250V, IEC127 for 100/120V line supply

It is fitted into the reverse side of the Fuse Drawer, in the Power Input module on the rear panel, and **must** be of **High Breaking Capacity**.

WARNING

MAKE SURE THAT ONLY FUSES WITH THE REQUIRED RATED CURRENT AND OF THE SPECIFIED TYPE ARE USED FOR REPLACEMENT.

THE USE OF MENDED FUSES AND THE SHORT CIRCUITING OF FUSE-HOLDERS ARE TO BE AVOIDED; THESE PRACTICES WILL RENDER THE WARRANTY VOID.

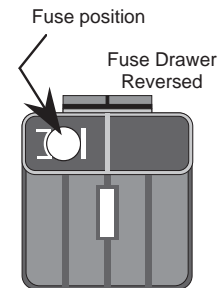

Final Width = 215mm

2.7.4.1 Power Fuse Replacement

Warning! *Fuse replacement should be carried out by a suitable skilled and competent person.*

When the power fuse is to be replaced, proceed as follows:

1. **Ensure that the POWER CABLE is removed.** Insert a small screwdriver blade in the narrow recess above the catch over the fuse drawer; lever the screwdriver handle gently upwards until the catch releases. Pull the drawer out, and reverse it to see the fuse.
2. Check the fuse and replace if required.
3. Check that the desired voltage is visible at the front of the voltage selector block inside the power module cavity.
4. Insert the fuse drawer into the module and press until the catch is heard to click into place.

2.7.5 Mounting

2.7.5.1 Bench Mounting

The instrument is fitted with four plastic feet and a tilt stand. It can stand flat on a bench, positioned so that the cooling-air inlet on the right side and exhaust apertures on the left side are not obstructed. It is recommended that at least 30cm (12 inches) of free space be allowed on both sides. The front can be tilted upward for ease of viewing.

2.7.5.2 Rack Mounting (Option 90)

For a Model 9100 Calibrator supplied with Option 90 Rack Mounting Kit, the following fixing instructions must be observed in order to ensure a successful installation:

Preliminaries

N.B. The Calibrator must *not* be rack-mounted into a totally-enclosed, unventilated cabinet. The internal cooling air intake is on the right side about halfway to the rear; the air is exhausted from the left side. There must be sufficient clearance between each calibrator ventilator port, and its adjacent solid cabinet sidewall (at points X), of at least 6cm.

Fixing the Mounting Tray to the Cabinet

1. Secure the strengthening channel bars to the bottom of the tray as shown, using the eight M4 countersunk screws provided.
2. Measure the depth of the cabinet from front to rear attachment strips.
3. Set the depth of the mounting tray (A - D) to fit the cabinet, fixing the rear attachment brackets to the sides of the tray. Use the eight M4 pozipan screws (B) on the inside and M4 nylock nuts (C) on the outside, through holes in the tray sides and slots in the brackets, to secure the brackets as shown. For cabinets with very shallow depth, the brackets may be reversed (with caution).
4. Offer up the tray into the cabinet (it may be necessary to tilt the tray sideways) and attach the brackets at D and front flange at A to the cabinet strips using the eight M6 pozipan screws, washers and cage nuts provided (for some types of cabinet, it may be necessary to use the appropriate cabinet screws).
Do not, under any circumstances, attach the tray only at the front flange.

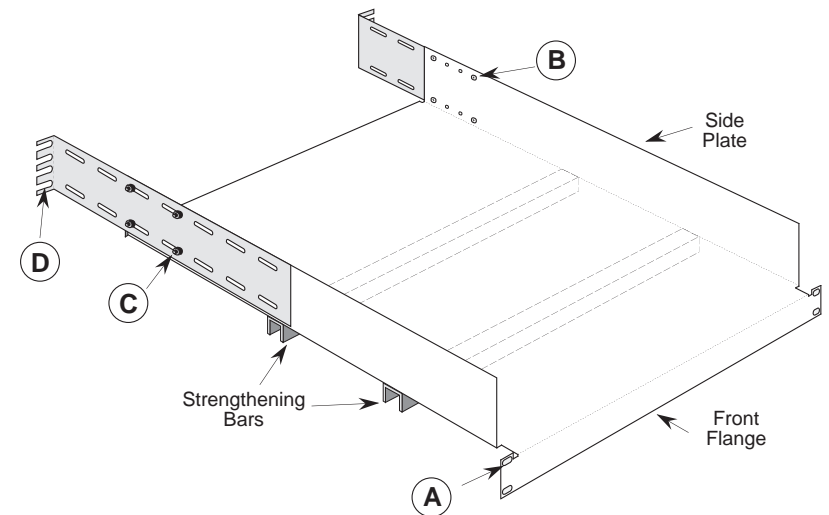

5. Adjust the position of the tray laterally to equalize the clearance between the tray sides and the cabinet sidewalls. Secure the cabinet screws at A and D.

Final Width = 215mm

Setting the Calibrator on the Mounting Tray

1. Ensure that the feet (Z) are still fixed to the bottom of the calibrator case (this provides the necessary airflow path).
2. Slide the calibrator on to the tray, lining up the front panel with the front of the cabinet.
3. Equalize the lateral clearances (Y) between the calibrator and the tray sides.

Indication of Inadequate Cooling Airflow

In the event of the internal temperature rising to a point at which the calibrator specification may be invalidated, a warning message will appear on the screen: "Over temperature".

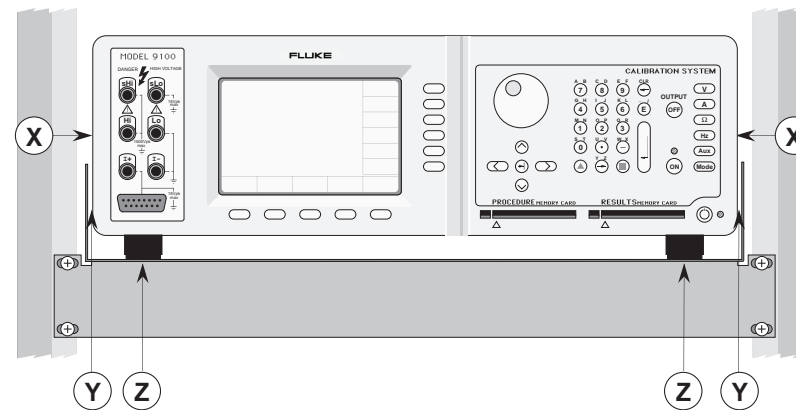

Final Width = 215mm

2.8 Connectors and Pin Designations

2.8.1 IEEE-488 Input/Output Socket J101 (Rear Panel)

This 24-way input/output connector on the rear panel, which is labelled IEEE-488, is directly compatible with the IEEE-488 and IEC-625 Interface Bus standards.

Pin Layout

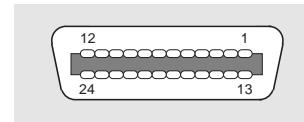

Pin Designations

Pin No.	Name	Description
1	DIO 1	Data Input Output Line 1
2	DIO 2	Data Input Output Line 2
3	DIO 3	Data Input Output Line 3
4	DIO 4	Data Input Output Line 4
5	EOI	End or Identify
6	DAV	Data Valid
7	NRFD	Not ready for Data
8	NDAC	Not Data Accepted
9	IFC	Interface Clear
10	SRQ	Service Request
11	ATN	Attention
12	SHIELD	Screening on cable (connected to Safety Ground)
13	DIO 5	Data Input Output Line 5
14	DIO 6	Data Input Output Line 6
15	DIO 7	Data Input Output Line 7
16	DIO 8	Data Input Output Line 8
17	REN	Remote Enable
18	GND 6	Ground wire of twisted pair with DAV
19	GND 7	Ground wire of twisted pair with NRFD
20	GND 8	Ground wire of twisted pair with NDAC
21	GND 9	Ground wire of twisted pair with IFC
22	GND 10	Ground wire of twisted pair with SRQ
23	GND 11	Ground wire of twisted pair with ATN
24	0V_F	Logic Ground (Internally associated with Safety Ground)

Final Width = 215mm

2.8.2 Parallel Port J103 (Rear Panel)

This 25 way D-Type socket is located beneath the IEEE-488 connector on the rear panel. Its connections are similar to the 25-way printer port on PCs, carrying control and data for an external printer as designated in the table.

Pin Layout



Pin Designations

9100 Pin No.	9100 Signal Name	9100 I/O	Description or Common Meaning
1	STROBE_L	Output	1µs pulse to cause printer to read one byte of data from data bus DO1 — DO8.
2	DO1	Output	Data bit 1
3	DO2	Output	Data bit 2
4	DO3	Output	Data bit 3
5	DO4	Output	Data bit 4
6	DO5	Output	Data bit 5
7	DO6	Output	Data bit 6
8	DO7	Output	Data bit 7
9	DO8	Output	Data bit 8
10	ACKNLG_L	Input	Pulse to indicate that the printer has accepted a data byte, and is ready for more data.
11	BUSY_H	Input	Printer is temporarily busy and cannot receive data.
12	P_END_H	Input	Printer is out of paper.
13	SLCT_H	Input	Printer is in online state, or connected.
14	AUTO_FEED_L	Output	Paper is automatically fed 1 line after printing. This line is fixed _H (high) by the 9100 to disable autofeed.
15	ERROR_L	Input	Printer is in 'Paper End', 'Offline' or 'Error' state.
16	INIT_L	Output	Commands printer to reset to power-up state, and in most printers to clear its print buffer.
17	SLCT_IN_L	Output	Commands some printers to accept data. This line is fixed _L (low) by the 9100.
18-25	0V_F	Output	Digital Common

_H ≡ Logic-1 active; _L ≡ Logic-0 active.

Final Width = 215mm



**DANGER
HIGH VOLTAGE**



**THIS INSTRUMENT IS CAPABLE OF DELIVERING
A LETHAL ELECTRIC SHOCK !**

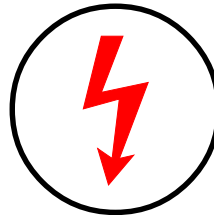

Model 9100: I+, I-, Hi, Lo, sHi and sLo Terminals
Model 9105: H (Red), sH (Red), sL (Black) LI- (Black)
and I+20 (Yellow) Leads carry the Full Output Voltage

THIS CAN KILL !

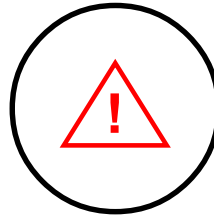

Avoid damage to your instrument !

Refer to User's Handbook, Volume 2, Section 7; for
Maximum Output Voltages and Currents.

Unless **you** are **sure** that it is **safe** to do so,
DO NOT TOUCH ANY of the following:
Model 9100: I+ I- Hi Lo sHi or SLo leads and terminals
Model 9105: H sH sL LI- or I+20 leads

DANGER

Final Width = 215mm

2.8.3 Serial Port J102 (Rear Panel)

This 9-way D-Type socket is located to the left and below the IEEE-488 connector on the rear panel. Its connections are RS232-compatible; carrying control and power supplies for, and receiving data from, a serial mouse.

Pin Layout



Pin Designations

Pin No.	Name	Description
1	---	Not used
2	RXD0_L	Serial Data: Mouse → 9100
3	TXD0_L	Serial Data: 9100 → Mouse
4	DTR0_H	Data Terminal Ready
5	0V_F	Digital Common
6	DSR0_H	Data Set Ready
7	RTS0_H	Request to Send
8	CTS0_H	Clear to Send
9	---	Not used

_H ≡ Logic-1 active; _L ≡ Logic-0 active.

2.8.4 Signal Output J109 (Front Panel)

This 15 way D-Type socket is located beneath the main output terminals on the front panel, providing a guard-screened connection for low-current outputs; extension connections for thermocouple simulation output; and lines to identify cable options.

Pin Layout

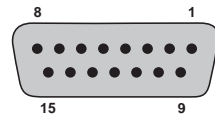

Pin Designations

Pin No.	Name	Description
1	---	Not used
2	---	Not used
3	---	Not used
4	ID0_L	Cable Option Ident
5	ID2_L	Cable Option Ident
6	---	Not used
7	I_GU	Guard Screen
8	LO_+	Low Current Output
9	THERM_DRV	Junction Temperature Sense
10	TC_POS	Thermocouple Output +
11	ID1_L	Cable Option Ident
12	0V	Ident Common
13	---	Not used
14	TC_NEG	Thermocouple Output -
15	THERM_OP	Junction Temperature Sense

_H ≡ Logic-1 active; _L ≡ Logic-0 active.

Final Width = 215mm

Final Width = 215mm

2.8.5 Phase Lock Connections (Rear Panel)

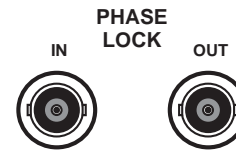

These two BNC sockets are located at the lower center of the rear panel, providing a reference phase output (PHASE LOCK OUT) or synchronizing phase input (PHASE LOCK IN) so that any 9100 can be used either as the source, or the recipient, of a phase reference.

The 9100 can be used in both roles simultaneously, being phase-synchronized to an external input signal while passing on the phase of its analog output to another 9100.

Internal controls are provided (via front-panel keys or via the IEEE-488 / SCPI interface) to adjust the phase-shift of the 9100 analog output and 'Phase Lock Out' signal with respect to the incoming synchronizing 'Phase Lock In' signal.

Signal levels and loading are discussed in *Section 4, Paras 4.4.3.5 (ACV) and Paras 4.6.3.5 (ACI)*.

2.8.6 'TRIG OUT' and 'SIG OUT' Connections (Rear Panel)

These two BNC sockets are located at the upper center of the rear panel, providing signal and trigger outputs for the Oscilloscope Calibration Options 250 and 600.

Further details are discussed in *Volume 3 of this handbook*.

Section 3 Model 9100 Controls

3.1 About Section 3

Section 3 is a detailed description of the 9100 operating controls; starting with a general description of the front panel. A brief description of Mode selection operations is given, followed by a more detailed treatment of 'Configuration' mode. Finally a course of tutorials gives practice in manipulating the controls in 'Manual' mode.

Section 3 is divided into the following sub-sections:

	page
3.2 Introduction to the Front Panel	
3.2.1 Local and Remote Operation	3-2
3.2.2 Front Panel Features	3-3
3.3 Modes of Operation	
3.3.1 Mode Selection	3-4
3.3.2 Configuration Mode	3-6
3.4 Working with Front Panel Controls — 'Manual' Mode Tutorials	
3.4.1 Output Controls	3-30
3.4.2 Manual Mode — Typical Menu Screen	3-31
3.4.3 Edit Facilities — Introduction	3-32
3.4.4 Digit Edit Facility	3-32
3.4.5 Direct Edit Facility	3-44
3.4.6 Combined Practice: Digit Edit and Direct Edit	3-48
3.4.7 Continuous Dynamic Range	3-52
3.4.8 Screen Keys	3-56
3.4.9 Summary of the Introductory Tutorials	3-57

Final Width = 215mm

3.2 Introduction to the Front Panel

3.2.1 Local and Remote Operation

3.2.1.1 Manual Calibration of UUT Meters and Multimeters

Because the main role of the 9100 is to calibrate instruments (UUTs) which are themselves manually operated, most users will find it convenient to control the 9100 at the same level. The front panel presents the operating interface necessary for manual control of the 9100 output.

3.2.1.2 Remote Calibration of the 9100 Itself

The 9100 itself must periodically be verified or calibrated against suitable traceable standards. These processes are available manually (*Sections 9 & 10— Volume 2*), but to gain the advantages of simplicity and throughput provided by automated procedures, the 9100 also incorporates a remote interface (IEEE-488.2/SCPI protocol). Its main use is to communicate with programmable standards such as the Model 4950 Multifunction Transfer Standard, under the direction of external MTS Control Software. The remote interface is described in *Section 6 (Volume 2)*.

For the purposes of this section, the remote interface can be ignored.

3.2.1.3 General Arrangement of Front Panel Controls

Final Width = 215mm

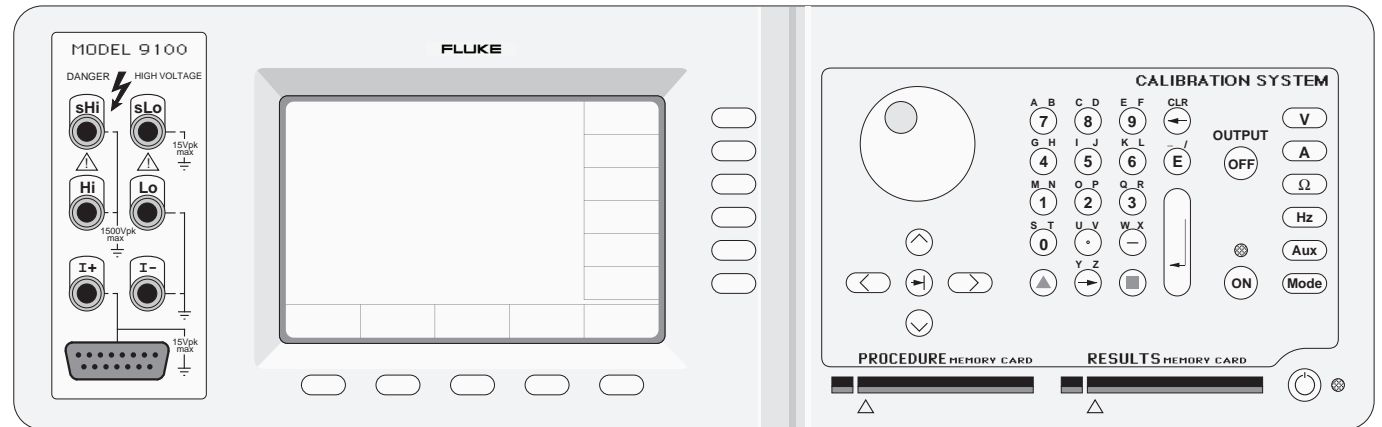

The front panel is divided into three main areas:

Center: A 'Menu' and 'Output Display' LCD screen, with grouped soft keys.

Right: A control panel, used to select and adjust operational Functions and Modes, with two slots to accept memory cards.

Left: Output Terminals, with a 'D-type' connector for functions with special guarding, screening and material requirements.

These features are described in the following paragraphs.

3.2.2 Front Panel Features

3.2.2.1 Liquid Crystal Display and Screen Keys

The 9100 communicates with the operator by presenting essential information on the LCD screen. For example: the output value appears in large characters just above the center of the screen, accompanied by its units. An operator can move through a series of menu screens, choosing options from those presented on the screen.

Eleven soft keys (referred to as 'screen' keys) are grouped below and to the right of the screen. These are labelled by characters or symbols representing menu choices, which appear in reserved display areas on the screen next to the keys. Main functions are selected by buttons on the 'Calibration System' panel; some screen keys select sub-functions, others allow different choices to be made.

3.2.2.2 'CALIBRATION SYSTEM' Panel

This panel carries the main controls used to select the operational functions and modes of the calibrator, and to determine the output variables:

- a. **Major Function** keys are used mainly in Manual mode (*Section 4*) and Calibration mode (*Section 10*). They are arranged down the right edge:
 - V:** DC or AC Voltage (select DCV or ACV using screen keys).
 - A:** DC or AC Current (select DCI or ACI using screen keys).
 - Ω:** Resistance or Conductance.
 - Hz:** Rectangular Waveform (select Frequency, Mark/Space Ratio, or Duty Cycle using screen keys).
 - Aux:** Auxiliary Functions (select Capacitance, Temperature simulation or Logic Stimulus using screen keys).
- b. **Mode** Key, the bottom key under the Function keys. The modes are: 'Procedure', 'Manual', 'Configuration', 'Calibration' and 'Test' (*refer to sub-section 3.3*).
- c. **OUTPUT OFF** and **ON** keys, with an 'ON' state indicator LED, in a separate column due to their importance.
- d. **Alpha-numeric** keypad, used for various purposes, to be described later.
- e. **The ⊞ (Tab) key, Cursor keys and Spinwheel:** These select and increment or decrement numeric quantities displayed on the LCD screen.

Final Width = 215mm

3.2.2.3 Output Terminals

The six safety output terminals and the D-type output socket are located on the left of the panel. Connections to these terminals, for each of the functions, are described in *Section 4*.

3.2.2.4 'Procedure' and 'Results' Memory Card Slots

These slots are included mainly for Procedure mode, although there are secondary uses. Procedure mode operations are introduced in *Section 5*.

3.3 Modes of Operation

3.3.1 Mode Selection

The Mode key is highlighted in *Fig. 3.3.1*, below:

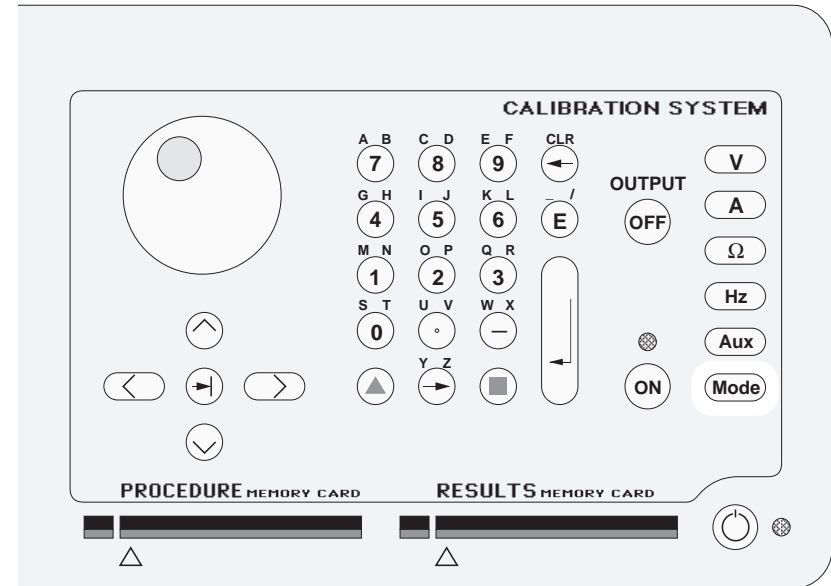

Fig. 3.3.1 'Mode' Key

Final Width = 215mm

3.3.1.1 Mode Overview

The Mode key sets up a special menu display, offering selection from five primary modes. This menu can be exited **only** by pressing one of the five screen keys.

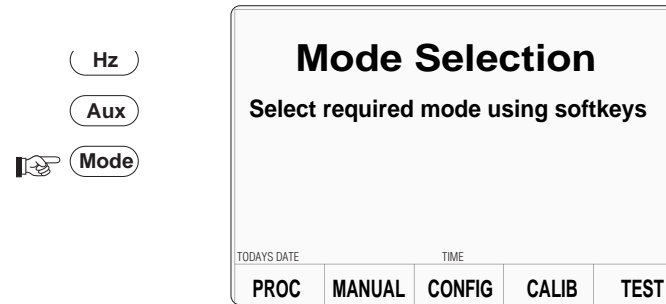

Fig. 3.3.2 Mode Selection Menu

Four of the modes are described in later sections, but because of its wide-ranging effects, Configuration Mode is dealt with in this section. The five modes are:

PROC = Procedure Mode:

For calibration of a specific type of UUT, the sequence of 9100 output selections is determined by a 'Procedure' memory card, placed in the left-hand slot beneath the panel outline. Results can be printed, or recorded in a second 'Data' card, placed in the right-hand 'RESULTS' slot. Refer to *Section 5*.

MANUAL = Manual Mode:

The output is selected and adjusted entirely from the front panel. Refer to *Section 4*.

CONFIG = Configuration Mode:

On entry to Configuration mode, an operator can change the LCD *Viewing Angle* without a password. Other parameters are protected by password. These include: *Power-On default mode (Manual or Procedure modes)*; *Present Time and Date*; *Enable Printing*; *Reformat Printed Certificates*; etc. Refer to *Sub-section 3.3.2*.

CALIB = Calibration Mode:

This mode is protected by switch and password. On entry to Calibration mode, the operator can process the calibration of the 9100 itself. Calibration can be controlled from the front panel, or via the IEEE-488 Interface. Refer to *Volume 2; Section 10*.

TEST = Test Mode:

This mode permits an operator to initiate and interact with any of a series of tests as follows: 'Fast'; 'Full'; or 'Interface'. Refer to *Volume 2; Section 8*.

Final Width = 215mm

Final Width = 215mm

3.3.2 Configuration Mode

Configuration Mode is used to change the settings of those parameters which have been placed under user control.

N.B. A password is required for access to change settings other than viewing angle.

When changing configuration, start as follows:

1. Press the **Mode** key on the right of the front panel to obtain the 'Mode Selection' menu screen

Hz

Aux

Mode

2. Press the **CONFIG** screen key at the center of the bottom row to progress into 'Configuration' mode. The 9100 will transfer to the 'Configuration' menu screen

3. The screen shows the present settings of some of the parameters which can be changed in Configuration mode.

3.3.2.1 Viewing Angle

1. Changing the viewing angle of the screen does not require a password. Press the **VIEW** screen key on the left of the bottom row. The 9100 will transfer to the 'Modify viewing angle' screen
2. Adjust the viewing angle by selectively pressing the **arrow** screen keys until the screen shows blue lettering on the whitest background possible.
3. **'EXIT'** reverts to the previous screen.

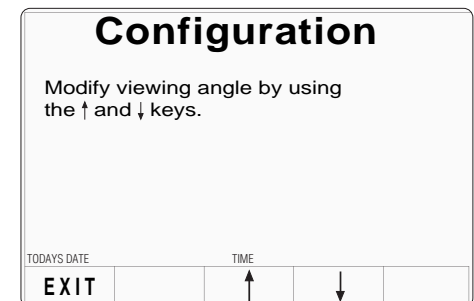
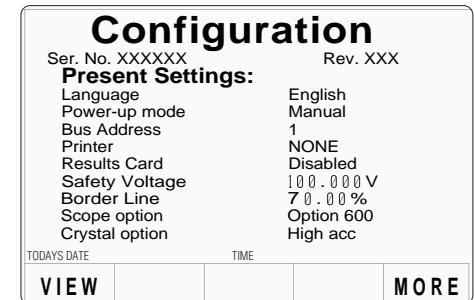
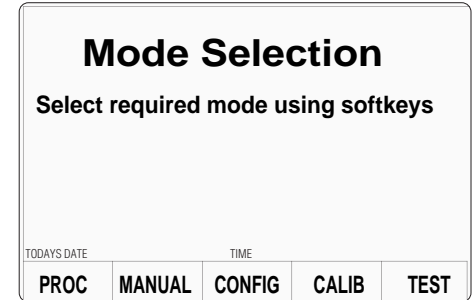

Passwords and Access

1. All Configuration mode selections, other than the viewing angle, require a password. When the 9100 is shipped from new, the password requirement is enabled to avoid unauthorized access.
2. *It is recommended that both passwords be changed, for security purposes, at the earliest opportunity.*
3. The shipment 'Configuration' password is **12321** (as typed on the front panel keypad when the Password Entry screen for Configuration mode is showing). It is stated here to allow entry to Configuration mode by personnel *authorized by local management*, and permit subsequent access to the means of altering the password itself. The necessary process is detailed later in this sub-section.
4. A second (different) password will be required to allow entry to Calibration mode *as authorized by local management*. The shipment version of the Calibration mode password is **2→3→5→7** (as typed on the front panel keypad when the Password Entry screen for Calibration mode is showing) The necessary process for changing *this* password is also detailed later in this sub-section.

3.3.2.2 'MORE' Configuration

1. To gain access to other Configuration mode options, a password will be required. (Refer to the arrangements made for 'shipment' passwords described in the column on the left.)
2. The password requirement will be invoked by pressing the **MORE** screen key on the right of the bottom row. The 9100 will transfer to the 'Password Entry' screen .
3. When you enter your password using the alpha-numeric keypad, security icons will appear on the screen as you type. Finally press the ↵ key.

If the password is incorrect: an error message will be given and the security icons will be removed, enabling a new attempt to enter the password.

The **'EXIT'** screen key acts to escape, back to the previous screen.

3. The correct password, followed by ↵, will provide entry to the main 'Configuration' menu screen, which shows the present settings of the parameters which can be changed using screen keys whose labels now appear on the display .

If it desired to revert to the initial Mode Selection display, press the front panel **'Mode'** key.

Configuration			
Ser. No. XXXXXX		Rev. XXX	
Present Settings:			
Language	English		
Power-up mode	Manual		
Bus Address	1		
Printer	NONE		
Results Card	Disabled		
Safety Voltage	100.000V		
Border Line	70.00%		
Scope option	Option 600		
Crystal option	High acc		
TODAYS DATE		TIME	
VIEW			MORE

Password Entry			
For Configuration			
Enter password : ☺☺☺☺☺☺			
TODAYS DATE		TIME	
EXIT			

Configuration				SELECT LANG
Ser. No. XXXXXX		Rev. XXX		POWER UP MODE
Present Settings:				BUS ADDRESS
Language	English			PRINTER
Power-up mode	Manual			RESULTS CARD
Bus Address	1			CLEAR USER LIST
Printer	NONE			
Results Card	Disabled			
Safety Voltage	100.000V			
Border Line	70.00%			
Scope option	Option 600			
Crystal option	High acc			
TODAYS DATE		TIME		
VOLTAGE LIMIT	DATE TIME	BORDER LINE		MORE

Final Width = 215mm



Language Considerations

1. The 9100 default language is English. It is possible to change the language used in Procedure mode, but not in any of the other modes.
2. For Procedure mode the language of the introductory screens can be changed (these are stored within the 9100 itself).
3. The language used in a procedure card is determined and registered on the card, within the procedure header, at the time that the procedure is created (Model 9010 performs this function). When the procedure card is used in the Model 9100, the language cannot be changed.
4. Ensure that any procedure cards purchased are in the desired language — and then change the introductory screens, using the procedure in the column on the right.

Final Width = 215mm

3.3.2.3 'SELECT LANGUAGE'

This facility allows users to alter the language used in the introductory screens of Procedure mode (see the notes in the column on the left).

1. On the 'Present Settings' screen, to transfer to the 'The current language' screen, press the **SELECT LANG** screen key 
2. To change the Procedure mode language, press the required language screen key on the right 
3. Press **EXIT** to return to the 'Present Settings' screen 

The new language will be used the next time that Procedure mode is entered.

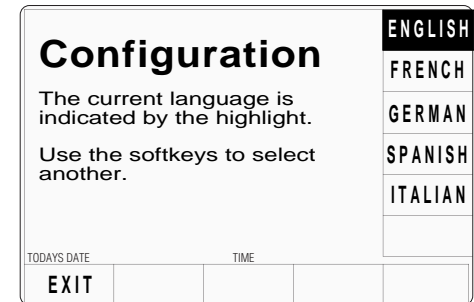
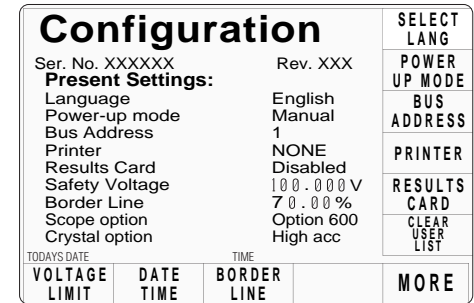

Mode Selection at Power-on

1. Users can determine which mode will be selected automatically at power-on, choosing between Procedure mode and Manual mode. The 9100 cannot be made to power-up in any other mode.
2. To set the power-up default mode use the procedure in the column on the right.

3.3.2.4 'POWER UP MODE'

This facility allows users to alter the mode to be entered at Power On (see the notes in the column on the left).

1. For access to change the default mode, press the **POWER UP MODE** screen key on the 'Present Settings' screen 

Configuration			SELECT LANG
Ser. No. XXXXXX	Rev. XXX		POWER UP MODE
Present Settings:			BUS ADDRESS
Language	English		PRINTER
Power-up mode	Manual		RESULTS CARD
Bus Address	1		CLEAR USER LIST
Printer	NONE		
Results Card	Disabled		
Safety Voltage	100.000 V		
Border Line	70.00 %		
Scope option	Option 600		
Crystal option	High acc		
TODAYS DATE	TIME		
VOLTAGE LIMIT	DATE TIME	BORDER LINE	MORE

2. This transfers to a 'Configuration' screen designed for changing 'The default power-on mode' 

3. To change the default, press the required screen key on the right 

4. Press EXIT to return to the 'Present Settings' screen 

The new default will be incorporated into the list. Next time the line power is turned from Off to **ON**, the 9100 will power-up in the selected mode.

Configuration			PROC
The default power-on mode is indicated by the highlight.			MANUAL
Use the softkeys to select another.			
TODAYS DATE	TIME		
EXIT			



Final Width = 215mm

Remote Operation via the IEEE-488 interface — Addressing the 9100

1. When the 9100 is set for remote operation, control is removed from the front panel and given to an external controller, which is programmed to carry out the procedure for the required application.
2. Communication is set up between the 9100 and its controller via the IEEE-488 bus, connected into an interface within the 9100 through J101 on the rear panel (*refer to Section 2, Sub-section 2.8.1*).
3. Commands from the controller are addressed specifically to the 9100 using an address code, which can be a number in the range 0-30. For the 9100 to respond, this number must be matched by the same number programmed into the 9100 using the procedure given in the column on the right.
4. Remote operation of the 9100 via the IEEE-488 interface, using the IEEE-488.2 and SCPI protocols, is fully described in *Section 6* of this Handbook (*Volume 2*).

Final Width = 215mm

3.3.2.5 'BUS ADDRESS'

1. The 9100 IEEE-488 bus address can be set to any number within the range 0 to 30. For access from the 'Present Settings' screen, press the **BUS ADDRESS** screen key on the right 
2. The 9100 transfers to the 'Change the address' screen 
3. Use Digit edit or Direct edit to set the required bus address number. If using Direct edit, type the number on the keypad, then press the ↵ key.
4. Press EXIT to return to the 'Present Settings' screen 

The new number will be registered in the interface, and the 9100 will respond to IEEE-499.2 commands bearing that address code.

Configuration			SELECT LANG
Ser. No. XXXXXX	Rev. XXX		POWER UP MODE
Present Settings:			BUS ADDRESS
Language	English		PRINTER
Power-up mode	Manual		RESULTS CARD
Bus Address	1		CLEAR USER LIST
Printer	NONE		
Results Card	Disabled		
Safety Voltage	100.000V		
Border Line	70.00%		
Scope option	Option 600		
Crystal option	High acc		
TODAY'S DATE	TIME		
VOLTAGE LIMIT	DATE TIME	BORDER LINE	MORE

Configuration		
Change the address by using digit or direct editing.		
Bus address = 22		
TODAY'S DATE	TIME	
EXIT		

Printer Operation (Procedure Mode and Test Mode only)

- Using the direct print facility of Procedure mode, the 9100 can deliver one of two forms of printed certificate. The certificate style is determined by a selection made elsewhere in Configuration mode.
- After selecting a printer type, with the printer connected and 'on line', the 9100 will go into direct printing state. During a procedure, results will be fed to print a certificate of the required style. With the printer not connected, or not on line, the procedure will not run, so if direct printing is not required, it is better to disable direct printing.
- In Test mode, test results can also be printed — in a pre-determined format. The results are not printed as the test proceeds, but are stored until the print command is given after the test is over. The results are then downloaded to the printer whether or not any printer type is selected. The printer does not need to be selected in Configuration mode, unless the results print is required to conform to the layout of a particular type of printer.
- The printer is set up only when an attempt is made to print, following two types of occasion:
 - printer type is changed in Configuration mode;
 - 9100 is powered on.

3.3.2.6 'PRINTER'

- For access to select and enable a particular printer type (or one using the same formatting), press the **PRINTER** screen key on the 'Present Settings' screen
- This transfers to a 'Configuration' screen designed for changing 'The current printer type'
- Use the screen keys to select the type of printer on the interface, or to disable direct printing. Power-on default is **DISABLE**.
- EXIT** returns to the 'Present Settings' menu screen
- If the initialisation control codes for the type of printer you are using do not conform to one of those listed, press the **USER DEFINED** screen key. This transfers to a 'Configuration' screen designed to enter the initialisation control codes for your printer
- Obtain the initialisation control codes from your printer's operating manual. If necessary, convert the codes to decimal. Use the 9100 keypad to type the decimal codes, separated by spaces (→), then press the ↵ key
- EXIT** returns to the 'The current printer type' screen

During a Procedure mode print run, certain printer information will be returned to the 9100, which will respond by halting the procedure and placing an error message on the screen (such as 'Printer out of paper' or 'Printer is not responding').

Configuration			SELECT LANG
Ser. No. XXXXXX	Rev. XXX		POWER UP MODE
Present Settings:			BUS ADDRESS
Language	English		PRINTER
Power-up mode	Manual		RESULTS CARD
Bus Address	1		CLEAR USER LIST
Printer	NONE		
Results Card	Disabled		
Safety Voltage	100.000 V		
Border Line	70.00%		
Scope option	Option 600		
Crystal option	High acc		
TODAYS DATE	TIME		MORE
VOLTAGE LIMIT	DATE TIME	BORDER LINE	

Configuration			DISABLE
The current printer type is indicated by the highlight.			EPSON
Use the softkeys to select another.			BUBBLE JET
			DESKJET
			USER DEFINED
TODAYS DATE	TIME		
EXIT			

Configuration		
Enter the initialisation control codes in decimal and confirm with enter.		
Current string: 27 116 1 18 15		
New String:		
TODAYS DATE	TIME	
EXIT		

Final Width = 215mm

Formatting Results Memory Cards (Procedure Mode only)

- Using Procedure mode to calibrate or verify a UUT, the 9100 can deliver the results of the procedure to a memory card inserted into the 'RESULTS' slot in the front panel (refer to Section 5 of this Handbook).
- Note that only SRAM cards can be used in the RESULTS drive.
- Before a new SRAM card can be used to store results, it must first be formatted for the purpose. Formatting can be carried out in Test mode, as part of the 'Card Slot Test' procedure (refer to Section 8 in Volume 2 of this Handbook; paras 8.3.4.5), or within the Model 9010 software.

Caution!

During the formatting process, the Card Slot Test will overwrite all data stored on the card in the slot, and set up a new 'Results card header'.

Note:

It is not necessary to re-format a used card, with results already stored, for it to accept new data. New results data from Procedure mode runs will be concatenated with existing data until the card memory is full. Erasure of card contents should be done using the Model 9010.

3.3.2.7 'RESULTS CARD'

- For access to enable Procedure mode results to be downloaded to a SRAM memory card in the front panel 'RESULTS' slot, press the **RESULTS CARD** screen key on the 'Present Settings' screen 

- The 'RESULTS CARD' screen key transfers to 'The rslt card requirement' menu screen 

The power-on default is **DISABLE**.

- To enable or disable the facility, press the required screen key on the right of the screen. If enabled without a results card inserted in the 'RESULTS' slot, the selected procedure will not run.
- EXIT** returns to the 'Present Settings' menu screen.

Configuration				SELECT LANG
Ser. No. XXXXXX	Rev. XXX			POWER UP MODE
Present Settings:				BUS ADDRESS
Language	English			PRINTER
Power-up mode	Manual			RESULTS CARD
Bus Address	1			CLEAR USER LIST
Printer	NONE			
Results Card	Disabled			
Safety Voltage	100.000 V			
Border Line	70.00%			
Scope option	Option 600			
Crystal option	High acc			
TODAYS DATE		TIME		
VOLTAGE LIMIT	DATE TIME	BORDER LINE		MORE



Configuration				DISABLE
The rslt card requirement is indicated by the highlight.				ENABLE
Use the softkeys to select another.				
TODAYS DATE		TIME		
EXIT				

Final Width = 215mm

Procedure Mode User List

1. A list of users is presented on the opening menu screen of Procedure mode, where the user's name can be selected to appear on the certificate. New names can be added to the screen at the same time.
2. Names cannot be removed from the list without knowing the Config mode password, which must be used to access the 'Clear user list' facility.

3.3.2.8 'CLEAR USER LIST'

1. For access to allow the Procedure mode user list to be cleared, press the **CLEAR USER LIST** screen key on the 'Present Settings' screen 
2. The 'CLEAR USER LIST' screen key on the 'Present Settings' menu transfers to the confirmation screen 
3. **OK** removes all names from the list.
4. **EXIT** returns to the 'Present Settings' menu screen.

Configuration			SELECT LANG
Ser. No. XXXXXX		Rev. XXX	
Present Settings:			POWER UP MODE
Language	English	BUS ADDRESS	
Power-up mode	Manual	PRINTER	
Bus Address	1	RESULTS CARD	
Printer	NONE	CLEAR USER LIST	
Results Card	Disabled		
Safety Voltage	100.000 V		
Border Line	70.00 %		
Scope option	Option 600		
Crystal option	High acc		
TODAYS DATE		TIME	
VOLTAGE LIMIT	DATE TIME	BORDER LINE	MORE

Configuration		
C F BARNES		
F J BLOGGS		
J K FLIPFLOP		
Press OK to clear the list		
TODAYS DATE		TIME
EXIT		OK



Final Width = 215mm

Final Width = 215mm

High Voltage Warnings — Warning and Interlock

1. In the interests of safety, to avoid electric shock, the 9100 incorporates a high-voltage warning and interlock system for both DC and AC Voltage functions. The limit can be set to any voltage from 10V to 110V. The default warning threshold value (100V) can be changed in Configuration mode. The active threshold value is stored in non-volatile memory.
2. When the output is on in DCV or ACV function, the warning will sound when the output voltage setting is raised to or above the threshold value. The output will not change from its previous value until the user confirms the new voltage by re-pressing the OUTPUT ON button.

3.3.2.9 'VOLTAGE LIMIT'

1. For access to allow the high voltage warning threshold to be altered, press the **VOLTAGE LIMIT** screen key on the 'Present Settings' screen 
2. This transfers to a configuration screen designed for changing the 'Voltage Limit'. In our representation, the default value is shown 
3. Use Digit edit or Direct edit to set the required high voltage warning limit. If using Direct edit, after typing the value press the \downarrow key on the keypad (the Direct edit 'V' screen key in the right-hand column will perform the same action).

The 'DEFAULT 100V' screen key on the right can be used if 100V is the required level.
4. Press the **EXIT** screen key to return to the 'Present settings' menu screen. The new high voltage threshold value appears on the 'Present Settings' list.

Note: Out-of-Range Indication

The valid range of limit values is from 10V to 110V. When values outside this range are entered, an error message will appear on the screen, and the 'EXIT' screen key label will be replaced by 'OK'. By pressing 'OK' the original value is reinstated and the message disappears, for a second attempt.



Configuration				SELECT LANG
Ser. No. XXXXXX		Rev. XXX		POWER UP MODE
Present Settings:				BUS ADDRESS
Language	English	Manual	1	PRINTER
Power-up mode	NONE	Disabled		RESULTS CARD
Bus Address	100.000 V	70.00%		CLEAR USER LIST
Printer	Option 600	High acc		
Results Card				
Safety Voltage				
Border Line				
Scope option				
Crystal option				
TODAYS DATE	DATE	TIME	BORDER LINE	MORE
VOLTAGE LIMIT				

Configuration				DEFAULT 100V
The high voltage warning limit can be changed by using digit or direct editing.				
The maximum value is 110V				
Limit = 100.000 V				
TODAYS DATE	DATE	TIME		
EXIT				

Date and Time Settings

A real-time clock, supported by an internal battery for occasions when line power is off, presents the date and time at the bottom of many screens. It is also used to generate the date which will appear on direct-printing certificates in Procedure mode. Users have access via Configuration mode to correct the date and time (for instance: to accommodate daylight saving changes, and crossing time-zones).

3.3.2.10 'DATE TIME'

- For access to allow the date and time to be altered, press the **DATE TIME** screen key on the 'Present Settings' screen 
- This transfers to a configuration screen designed for changing the date and time. Our representation shows the current date from a previous setting 
- Press the appropriate right screen key to set the required date format.
- To correct the date, use the alpha-numeric keypad to enter the present date: *in the same format as shown by the highlighted screen key.*
- To correct the time, press the **CHANGE TIME** screen key to transfer to the 'Change the time' screen, then use the alpha-numeric keypad to enter the present time 
- Pressing the 'CHANGE DATE' screen key reverts to the screen for changing the date.
- Press the **EXIT** screen key to return to the 'Present settings' menu screen. The *corrected* date and time, updated by the real-time clock, will appear wherever they are used.

Configuration		SELECT LANG
Ser. No. XXXXXX	Rev. XXX	POWER UP MODE
Present Settings:		BUS ADDRESS
Language	English	PRINTER
Power-up mode	Manual	RESULTS CARD
Bus Address	1	CLEAR USER LIST
Printer	NONE	
Results Card	Disabled	
Safety Voltage	100.000 V	
Border Line	70.00 %	
Scope option	Option 600	
Crystal option	High acc	
TODAYS DATE	TIME	
VOLTAGE LIMIT	DATE TIME	BORDER LINE
		MORE

Configuration		D-M-Y
The selected date format is indicated by the highlight.		M-D-Y
Change the date by using direct editing only.		Y-M-D
21/07/1995		
TODAYS DATE	TIME	
EXIT	CHANGE DATE	CHANGE TIME

Configuration	
Change the time by using direct editing only.	
09-37	
TODAYS DATE	TIME
EXIT	CHANGE DATE
	CHANGE TIME

Final Width = 215mm

Test Point Specifications — 'Borderline' Reporting

For users who wish to know when a UUT is drifting towards the limits of (while still within) the manufacturer's specification, it is useful to provide some 'borderline' indication. This can be expressed as a percentage of the manufacturer's specification for each test point, beyond which the indication will be given.

In the figure, the pass, borderline and fail regions of the specification tolerance are indicated *at the test point*.

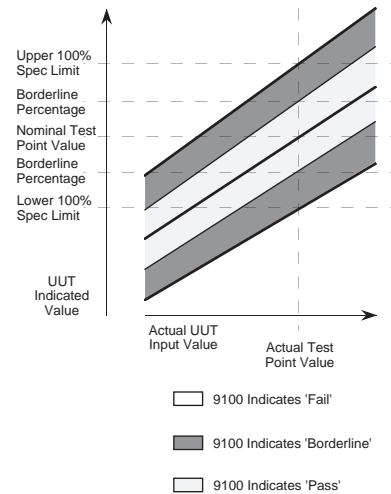

When in Procedure mode, the direct-printing certificate (Style 1), and the data on the 'Results' card, will report 'Borderline' test results. Users have access via Configuration mode to set the percentage for borderline reporting.

3.3.2.11 'BORDER LINE'

1. For access to allow the borderline reporting threshold to be altered, press the **BORDER LINE** screen key on the 'Present Settings' screen
2. This transfers to a configuration screen designed for changing the threshold. In our representation, the default value is shown
3. Use Digit edit or Direct edit to set the required percentage of specification tolerance. Results which lie between this percentage and 100% of tolerance will be reported as 'Borderline'.
4. Press the **EXIT** screen key to return to the 'Present settings' menu screen

Configuration		SELECT LANG
Ser. No. XXXXXX	Rev. XXX	POWER UP MODE
Present Settings:		BUS ADDRESS
Language	English	PRINTER
Power-up mode	Manual	RESULTS CARD
Bus Address	1	CLEAR USER LIST
Printer	NONE	
Results Card	Disabled	
Safety Voltage	1000.000 V	
Border Line	70.00%	
Scope option	Option 600	
Crystal option	High acc	
TODAYS DATE	TIME	
VOLTAGE LIMIT	DATE TIME	BORDER LINE
		MORE

Configuration	
The percentage of UUT specification tolerance beyond which a "borderline" is reported can be adjusted by using digit or direct editing.	
Borderline =	70.00
TODAYS DATE	TIME
EXIT	

Subsequently, during each '1 Year Verification' in Procedure mode, the 9100 will detect its own slewed output and place the UUT measurement error into the 'Pass', 'Borderline' or 'Fail' category. When a (Style 1) certificate is printed, and on any active results card, each test point will indicate a 'Pass', 'Borderline' or 'Fail' result.

Notes about Results Certificates and Data Cards:

Printed Certificates:

Three styles of certificate can be printed. Certificate style, format and some details are user-configurable in Config mode (*details appear on the following pages*). Other details are obtained automatically from data held in the 9010 software, or from the Procedure memory card inserted in the PROCEDURE slot.

Results Memory Cards

Simultaneously, results data can be written to a SRAM memory card, inserted in the RESULTS slot. The style and format for results cards are not user-configurable in Config mode. Some details stored in the card (such as temperature, humidity, borderline threshold and UUT serial number) are derived automatically from data held in the 9100 software or from the Procedure memory card inserted in the PROCEDURE slot.

3.3.2.12 'MORE' Parameters

On the main 'Present Settings' menu screen, one of the screen keys is labelled 'MORE'. Pressing this key will access some more configurable parameters.

1. On the main 'Present Settings' menu screen, press the **More** screen key on the bottom row 

This transfers to a second 'Present Settings' screen, which indicates the settings in use for the remaining parameters 

The Serial and Software Revision numbers are given for information only. They are derived directly from the installed software, and cannot be changed.

The parameters available for change are selectable using the screen keys on the right.

2. The **EXIT** screen key reverts to the first 'Present Settings' screen.

Configuration				SELECT LANG
Ser. No. XXXXXX		Rev. XXX		POWER UP MODE
Present Settings:				BUS ADDRESS
Language	English			PRINTER
Power-up mode	Manual			RESULTS CARD
Bus Address	1			CLEAR USER LIST
Printer	NONE			MORE
Results Card	Disabled			
Safety Voltage	100.000 V			
Border Line	70.00 %			
Scope option	Option 600			
Crystal option	High acc			
TODAYS DATE		TIME		
VOLTAGE LIMIT	DATE TIME	BORDER LINE		

Configuration				CERT DETAILS
Ser. No. XXXXXX		Rev. XXX		ENG NOTES
Present Settings:				NEW PASSWRD
Certificate Style	Style 1			FLUKE LEAD CAP
Engineers Notes	Disabled			USER LEAD CAP
Fluke Lead Cap	28.50 pF			
User Lead Cap	0.00 pF			
TODAYS DATE		TIME		
EXIT				

Final Width = 215mm

Results Certificates

In Procedure mode, three styles of printed certificate are available:

Style 1

This provides full information about each point tested, including applied and target values, spec limits and UUT error, % error pass/fail and test uncertainty ratio between 9100 and UUT.

Style 2

This is a shorter form of certificate, showing only the applied and target values, and the 9100 absolute uncertainty.

Style 3

This certificate is similar to Style 1, and has been added to accommodate the wider spec limits encountered during oscilloscope calibration, expressed in percentages rather than ppm.

Users are given the facility, in Configuration mode, to change the style of certificate to be printed.

Final Width = 215mm



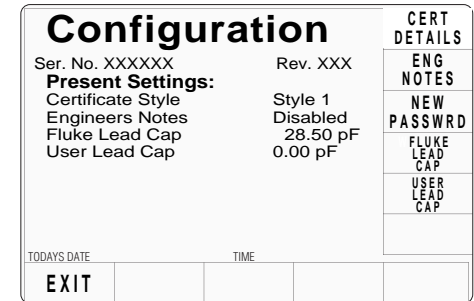

3.3.2.13 'CERT DETAILS'

1. For access to allow the certificate formatting to be altered, press the **CERT DETAILS** screen key on the 'MORE' 'Present Settings' screen 



2. This transfers to what we shall refer to as a 'CERT DETAILS' screen (see below), which allows users to design a certificate by adjusting or selecting characteristics via screen keys on the right (*refer to paras 3.3.2.14*).
3. The **EXIT** screen key reverts to the 'MORE' - 'Present Settings' screen.

3.3.2.14 'CERT STYLE'

1. For access to select the certificate style, press the **CERT STYLE** screen key on the 'CERT DETAILS' screen 
2. This transfers to 'The certificate type' screen, which allows the style of certificate to be selected 
3. Press the key on the right which represents the required style of certificate 
4. Press the **EXIT** screen key to revert to the CERT DETAILS screen 

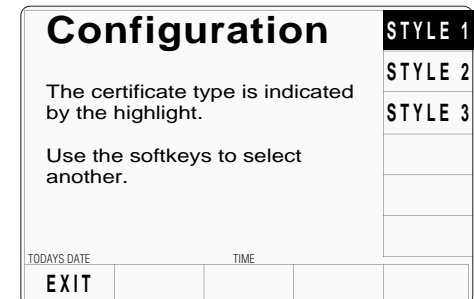
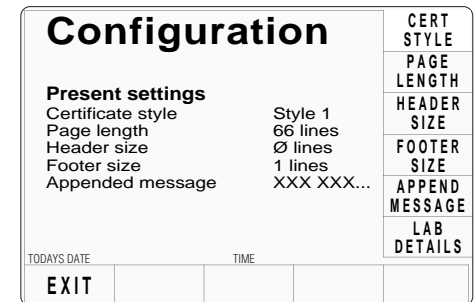

3.3.2.15 'PAGE LENGTH'

Users are given the facility to change the page length of the printed certificates.

1. On the CERT DETAILS menu screen, press the **PAGE LENGTH** screen key 

Configuration		CERT STYLE
Present settings		PAGE LENGTH
Certificate style	Style 1	HEADER SIZE
Page length	66 lines	FOOTER SIZE
Header size	0 lines	APPEND MESSAGE
Footer size	1 lines	LAB DETAILS
Appended message	XXX XXX...	
TODAYS DATE	TIME	
EXIT		

This transfers to 'The current page length' screen 

2. If required, use the numeric keypad to enter a new certificate page length.
3. Press the **EXIT** key to revert to the CERT DETAILS screen 

Configuration	
The current page length is 66 lines.	
Enter new length:	
TODAYS DATE	TIME
EXIT	

Final Width = 215mm

Final Width = 215mm

3.3.2.16 'HEADER SIZE'

Users are given the facility to change the header size on the printed certificates.

1. On the CERT DETAILS menu screen, press the **HEADER SIZE** screen key 

This transfers to 'The current header size' screen 

2. If required, use the numeric keypad to enter a new header size on the certificate.
3. Press the **EXIT** key to revert to the CERT DETAILS screen 

3.3.2.17 'FOOTER SIZE'

Users are given the facility to change the footer size on the printed certificates.

1. On the CERT DETAILS menu screen, press the **FOOTER SIZE** screen key.

This transfers to 'The current footer size' screen 

2. If required, use the numeric keypad to enter a new footer size on the certificate.
3. Press the **EXIT** key to revert to the CERT DETAILS screen 

Configuration		CERT STYLE
Present settings		PAGE LENGTH
Certificate style	Style 1	HEADER SIZE
Page length	66 lines	FOOTER SIZE
Header size	Ø lines	APPEND MESSAGE
Footer size	1 lines	LAB DETAILS
Appended message	XXX XXX...	
TODAYS DATE	TIME	
EXIT		

Configuration	
The current header size is Ø lines.	
Enter new header size:	
TODAYS DATE	TIME
EXIT	

Configuration	
The current footer size is 1 lines.	
Enter new footer size:	
TODAYS DATE	TIME
EXIT	

Laboratory Name

Users should enter the name of their laboratory for the printed certificates.

Final Width = 215mm

3.3.2.20 'LAB NAME'

1. On the LAB DETAILS menu screen, press the **LAB NAME** screen key on the right 

This transfers to 'The current lab name' screen 

2. Use the alpha-numeric keypad to enter a new laboratory name.
3. Press the **EXIT** key to revert to the LAB DETAILS screen 

Configuration		LAB NAME
Present settings		LAB TEMP
Lab name	Fluke L . . .	LAB HUMID.
Lab temp.	21°C ±10°C	
Lab humid.	30% ±10%	
TODAYS DATE	TIME	
EXIT		

Configuration	
The current lab name is:	
Enter a new name:	
TODAYS DATE	TIME
EXIT	

Laboratory Temperature

Users should enter the official temperature of their laboratory for the results card and the printed certificates.

3.3.2.21 'LAB TEMP'

1. On the LAB DETAILS 'Present Settings' menu screen, press the **LAB TEMP** screen key on the right. This transfers to 'The current temperature setting' screen 
2. Use the alpha-numeric keypad to enter the laboratory temperature: (2 characters and ↵); then the temperature tolerance: (2 characters and ↵).

[Backspace (←) deletes the entered characters one at a time.
CLR (■ then ←) will return to the LAB DETAILS screen.]

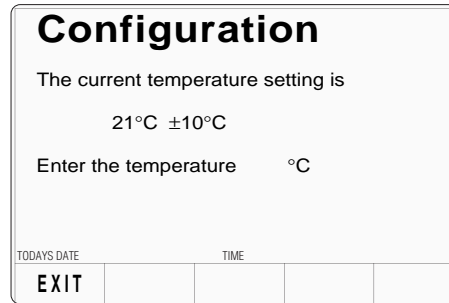

Configuration

The current temperature setting is

21°C ±10°C

Enter the temperature °C

TODAYS DATE TIME

EXIT

Completed entries will have been transferred to the 'Present Settings' list; the parameters of incompleted entries will remain unchanged.

3. To revert to the LAB DETAILS screen, press the **EXIT** key.

Laboratory Humidity

Users should enter the official humidity of their laboratory for results cards and printed certificates.

3.3.2.22 'LAB HUMID'

1. On the LAB DETAILS 'Present Settings' menu screen, press the **LAB HUMID** screen key on the right. This transfers to 'The current humidity setting' screen 
2. Use the alpha-numeric keypad to enter the laboratory humidity: (2 characters and ↵); then the humidity tolerance: (2 characters and ↵)

Backspace (←) deletes the entered characters one at a time.
CLR (■ then ←) will return to the LAB DETAILS screen.

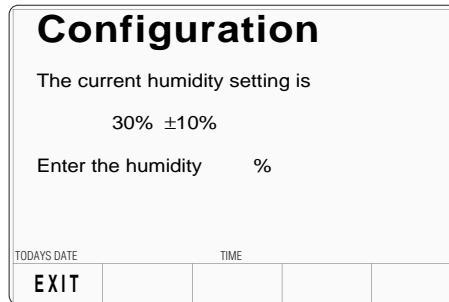

Configuration

The current humidity setting is

30% ±10%

Enter the humidity %

TODAYS DATE TIME

EXIT

Completed entries will have been transferred to the 'Present Settings' list; the parameters of incompleted entries will remain unchanged.

3. Press the **EXIT** key to revert to the LAB DETAILS screen.

Final Width = 215mm

Engineer's Notes

1. When a certificate is being prepared in Procedure mode, sometimes it will be desirable to insert additional information about special conditions, pertinent to the procedure which was carried out.

For instance: if the procedure was performed on a plug-in module of an oscilloscope, it may be desired to add the serial number of the oscilloscope mainframe, as well as the module's serial number.

2. If, in CONFIG mode, the 'Engineers Notes' are enabled, then an extra field will be added to the certificate entitled 'Additional Notes' in which any engineer's information can be entered. It will appear between the 'Calibration Standard' and 'Measurement Type' blocks.

The additional notes can be added on a screen which will be shown in Procedure mode when 'Engineers Notes' are enabled.

Final Width = 215mm

3.3.2.23 'ENGINEERS NOTES'

To Enable Engineers Notes

1. On the 'MORE — Present Settings' menu screen, press the **ENG NOTES** screen key on the right.

This transfers to the 'The eng notes requirement' screen 

2. Press the **ENABLE** screen key on the right. The **DISABLE** key reverses the process.
3. The **EXIT** screen key reverts to the 'MORE — Present Settings' screen.

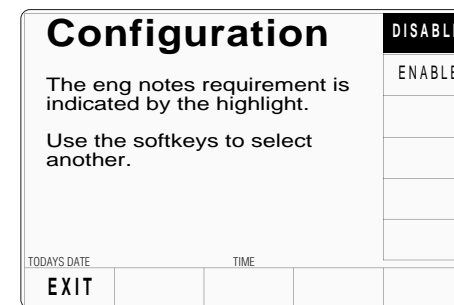

Passwords and Access

1. All Configuration mode selections, other than the viewing angle, require a password. When the 9100 is shipped from new, the password requirement is enabled to avoid unauthorized access.
2. *It is recommended that both passwords be changed, for security purposes, at the earliest opportunity.*
3. The shipment 'Configuration' password is **12321** (as typed on the front panel keypad when the Password Entry screen for Configuration mode is showing).
4. A second (different) password will be required to allow entry to Calibration mode *as authorized by local management*. The shipment version of the Calibration mode password is **2→3→5→7** (as typed on the front panel keypad when the Password Entry screen for Calibration mode is showing).

Changing the Passwords

Two passwords are allocated (they can be the same or different):

- for entry to Configuration mode (other than for setting the viewing angle);
- to enter Calibration mode (for calibration of the 9100 itself).

The passwords can be changed once access has been gained to Configuration mode.

3.3.2.24 'NEW PASSWORD'

To change either the CALIB or CONFIG password

1. On the 'MORE — Present Settings' menu screen, press the **NEW PASSWORD** screen key on the right.

This transfers to the 'Select the Password' screen 

2. Select the password to be changed, using a screen key on the right. See overleaf for the details of changing individual passwords.
3. The **EXIT** screen key reverts to the 'MORE — Present Settings' screen.

Configuration		CERT DETAILS
Ser. No. XXXXXX	Rev. XXX	ENG NOTES
Present Settings:		NEW PASSWRD
Certificate Style	Style 1	FLUKE LEAD CAP
Engineers Notes	Disabled	USER LEAD CAP
Fluke Lead Cap	28.50 pF	
User Lead Cap	0.00 pF	
TODAYS DATE	TIME	
EXIT		

Configuration		CALIB
Select the Password to be changed using the softkeys.		CONFIG
TODAYS DATE	TIME	
EXIT		

Final Width = 215mm

Final Width = 215mm

3.3.2.25 'CALIB'

To Change the Calibration Mode Password

1. On the 'Select the password' screen, press the **CALIB** screen key on the right.

This transfers to the 'Enter new calib password' screen 

(To cancel an attempt, press the EXIT key. This will revert to the 'Select the password' screen.)

2. Type the new password using the alpha-numeric keyboard, and finish with ↵. The 9100 will ask for the password to be entered again, to confirm it.
3. Retype the same password; finish with ↵. If the second password is different from the first, the 9100 will reject both, and the process must be repeated. If both passwords are the same, the 9100 will accept the new password, and revert to the 'Select the password' screen.

Configuration				CALIB
Select the Password to be changed using the softkeys.				CONFIG
TODAYS DATE				TIME
EXIT				

Configuration				
Enter new calib password				
<input type="text"/>				
TODAYS DATE				
TIME				
EXIT				

3.3.2.26 'CONFIG'

To Change the Configuration Mode Password

1. On the 'Select the password' screen, press the **CONFIG** screen key on the right.

This transfers to the 'Enter new config password' screen 

(To cancel an attempt, press the **EXIT** key. This will revert to the 'Select the password' screen.)

3. Type the new password using the alpha-numeric keyboard, and finish with ↵. The 9100 will ask for the password to be entered again, to confirm it.
4. Retype the same password; finish with ↵. If the second password is different from the first, the 9100 will reject both, and the process must be repeated. If both passwords are the same, the 9100 will accept the new password, and revert to the 'Select the password' screen.

Configuration				CALIB
Select the Password to be changed using the softkeys.				CONFIG
TODAYS DATE				TIME
EXIT				

Configuration				
Enter new config password				
<input type="text"/>				
TODAYS DATE				
TIME				
EXIT				

Final Width = 215mm

Final Width = 215mm

'Lead Capacitance Compensation'

The 9100 is designed for use with the Comprehensive Lead Set Model 9105, which is shipped as standard with the instrument. However, users are at liberty to use their own leads, so long as they are of high enough quality.

For Capacitance function (refer to *Section 4, sub-section 4.13*), a lead compensation bridge ensures that the correct virtual capacitance is delivered at the UUT terminals. It is possible that users may need to accommodate leads other than those provided with Model 9105, and these may require further compensation. For this purpose, the 9100 also provides Lead Capacitance Compensation to be altered separately, for leads connected either at the 9105 workmat, or directly into the front panel terminals. These two adjustments are accessed via the 'MORE' Configuration screen, as shown below.

The 'Fluke Lead Cap' value of 28.5pF, shown on the screen, is the default value referring to compensation using the Model 9105, whereas the 'User Lead Cap' value is applied for connection directly to the front panel terminals.

3.3.2.27 Factory Lead Capacitance Compensation Adjustment

1. For access to alter the factory Lead Capacitance Compensation, press the **FLUKE LEAD CAP** screen key on the 'MORE' 'Present Settings' screen 
2. This transfers to the 'Fluke leadset' screen, which allows users to adjust the compensation for a known lead capacitance value (refer to para 3.3.2.29).
3. The **EXIT** screen key reverts to the 'Present Settings' screen.

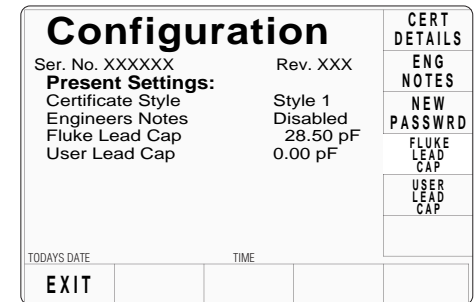

3.3.2.28 Factory Lead Compensation Adjustment Screen

1. Use Digit edit or Direct edit to adjust the compensation, by adding the extra value of lead capacitance to the default value.
2. The **EXIT** screen key reverts to the 'MORE' - 'Present Settings' screen.

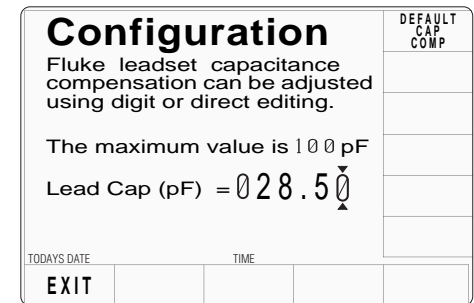

3.3.2.29 'User Lead Capacitance Compensation Adjustment'

1. For access to alter the User Lead Capacitance Compensation, press the **USER LEAD CAP** screen key on the 'MORE' 'Present Settings' screen 
2. This transfers to the 'UserLeadset' screen, which allows users to adjust the compensation for a known lead capacitance value (refer to paras 3.3.2.31).
3. The **EXIT** screen key reverts to the 'Present Settings' screen.

Configuration		CERT DETAILS
Ser. No. XXXXXX	Rev. XXX	ENG NOTES
Present Settings:		NEW PASSWRD
Certificate Style	Style 1	FLUKE LEAD CAP
Engineers Notes	Disabled	USER LEAD CAP
Fluke Lead Cap	28.50 pF	
User Lead Cap	0.00 pF	
TODAYS DATE	TIME	
EXIT		

3.3.2.30 User Lead Compensation Adjustment Screen

1. Use Digit edit or Direct edit to adjust the compensation, by adding the extra value of lead capacitance to the default value.
2. The **EXIT** screen key reverts to the 'MORE' - 'Present Settings' screen.

Configuration		DEFAULT CAP COMP
User leadset capacitance compensation can be adjusted using digit or direct editing.		
The maximum value is 100 pF		
Lead Cap (pF) = 000.00		
TODAYS DATE	TIME	
EXIT		

Final Width = 215mm

Final Width = 215mm

3.3.2.31 'SCOPE OPTION'

Information only

This line of 'Present Settings' indicates whether 'Option 250' (250MHz Oscilloscope Calibration Facility), 'Option 600' (600MHz Oscilloscope Calibration Facility), or 'None' (neither), is fitted.

Configuration		SELECT LANG
Ser. No. XXXXXX	Rev. XXX	POWER UP MODE
Present Settings:		BUS ADDRESS
Language	English	PRINTER
Power-up mode	Manual	RESULTS CARD
Bus Address	1	CLEAR USER LIST
Printer	NONE	
Results Card	Disabled	
Safety Voltage	100.000 V	
Border Line	70.00%	
Scope option	Option 600	
Crystal option	High acc	
TODAYS DATE		TIME
VOLTAGE LIMIT	DATE TIME	BORDER LINE
		MORE

3.3.2.32 'CRYSTAL OPTION'

Information only

The bottom line of 'Present Settings' indicates whether Option 100 (0.25ppm stability clock crystal) is fitted.

If 'High acc' is shown, this means that the option is fitted. Without Option 100, the indication will be 'Normal', with clock crystal stability of 25ppm.

Configuration		SELECT LANG
Ser. No. XXXXXX	Rev. XXX	POWER UP MODE
Present Settings:		BUS ADDRESS
Language	English	PRINTER
Power-up mode	Manual	RESULTS CARD
Bus Address	1	CLEAR USER LIST
Printer	NONE	
Results Card	Disabled	
Safety Voltage	100.000 V	
Border Line	70.00%	
Scope option	Option 600	
Crystal option	High acc	
TODAYS DATE		TIME
VOLTAGE LIMIT	DATE TIME	BORDER LINE
		MORE

3.4 Working with Front Panel Controls — Tutorials

Final Width = 215mm

Final Width = 215mm

Tutorial Aid

Throughout the tutorials, you will see pointers (☞). Where these are found in the text, they identify instructions for you to follow, giving you manual practice. Arrows (➡) are used to indicate important points on diagrams etc. (see *Fig. 3.4.1* opposite).

3.4 Working with Front Panel Controls — Tutorials

3.4.1 Output Controls

The aim of these tutorials is to become familiar with the 9100 interactive display, and the manipulation of front-panel controls to alter variables, starting with those which affect output.

In the first tutorials (*paras 3.4.4 and 3.4.5*), we have chosen DC Voltage as a typical function for manipulation (it is also likely to be the most familiar to most new operators). This is not a full treatment of the DC Voltage function — that will appear in Section 4.

The chosen output value is presented just above the center of the display, accompanied by its units, in large characters.

We have already seen that there are two sets of front-panel controls which manipulate the output configuration, but briefly, to establish a base-line, here they are again:

1. Controls positioned in the right half of the front panel. They are:
 - a. **Major Function** keys, arranged in a column down the right edge:
 - b. Moving left, the **OUTPUT OFF** and **ON** keys, arranged in a separate column because of their importance.
 - c. **Alpha-numeric** Keypad.
 - d. **Cursor** Controls:
 - Cursor keys:** Control the screen cursor to select a digit for adjustment. Increment or decrement the digit selected by the cursor.
 - Tab key:** Moves the cursor around the screen, between relevant variables (in our early sessions with DC Voltage, we shall have no reason to use this key).
 - Spinwheel:** Increments or decrements the selected digit.
2. **Screen Keys** around the display itself, which are used to select sub-functions (identified in the areas used as screen key labels);

Before we proceed, we need to identify the components present on a typical menu screen. A representation of a DC Voltage display appears opposite.

Entry to Manual Mode

The tutorials are conducted in Manual mode, which you may not recognize at present. Refer to *paras 3.3.1.1* on *page 3-5*. To enter **MANUAL** mode:

- ☞ Press the front panel **Mode** key;
- ☞ Press the **MANUAL** screen key beneath the display.

3.4.2 Manual Mode — Typical Menu Screen

- ☞ Ensure that the 9100 is installed and switched on as detailed in Section 2. If, after selecting Manual mode, the display does not correspond to Fig. 3.4.1 below, press the **V** key in the top right corner of the front panel.
 - ☞ Familiarize yourself with Fig. 3.4.1. This is the default version of the DC Voltage menu screen, which will appear when you enter DCV Function for the first time (unless the default has been changed in Config Mode).
- N.B.** Inversions of symbols and fields show selected elements (DCV and Output OFF in this case)

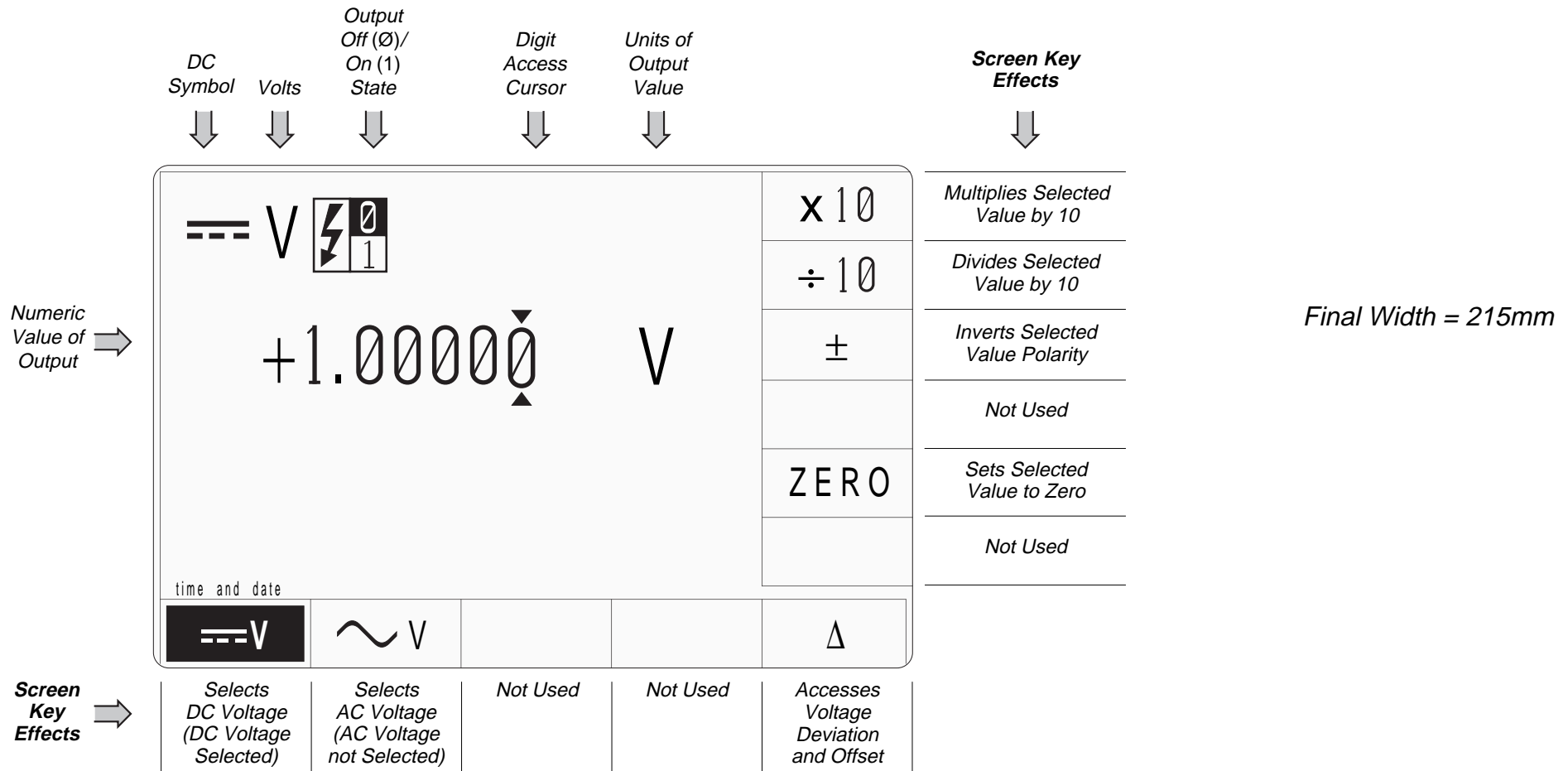

Fig. 3.4.1 DC Voltage Default Settings

3.4.3 Edit Facilities — Introduction

Before looking at displays for the other functions, we shall learn how to alter the values displayed on the screen. There are two main methods of changing values:

1. 'Digit Edit'; in which values can be changed digit by digit, using the 'digit access cursor' and associated controls.
2. 'Direct Edit'; where a complete new value is written in place of the existing value, using the numeric keypad.

We shall consider 'Digit Edit' first.

3.4.4 Digit Edit Facility

3.4.4.1 Digit Access Cursor

As we can see from *Fig. 3.4.1*, the numeric value of the 9100 output (whether OUTPUT is OFF or ON) is displayed in large characters just above the center of the screen. In Digit Edit, access to each digit is provided by a pair of enclosing triangles, called the 'Digit Access Cursor' (or just 'Cursor'). The cursor can be seen in *Fig. 3.4.1*, accessing the least-significant digit of the numeric value.

3.4.4.2 Cursor Controls

The main controls used to manipulate the cursor are: the \uparrow , \downarrow , \leftarrow and \rightarrow keys; the spinwheel, and the two shift keys on the numeric keypad. These are highlighted in *Fig. 3.4.2*, below.

Final Width = 215mm

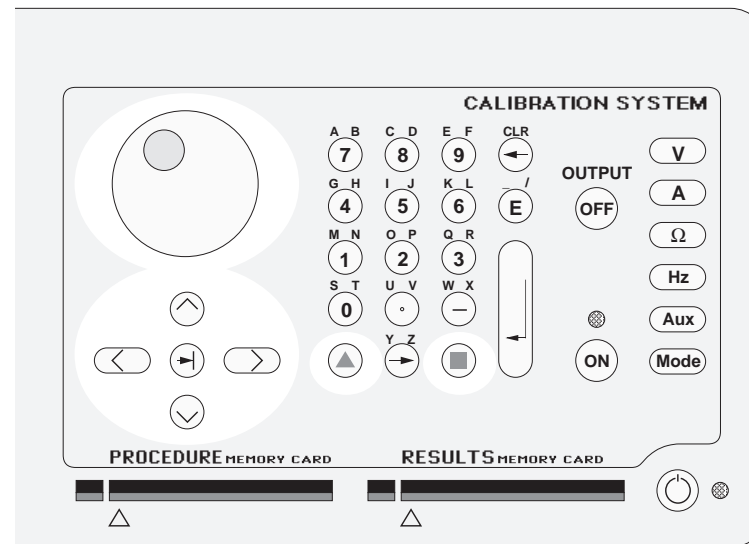
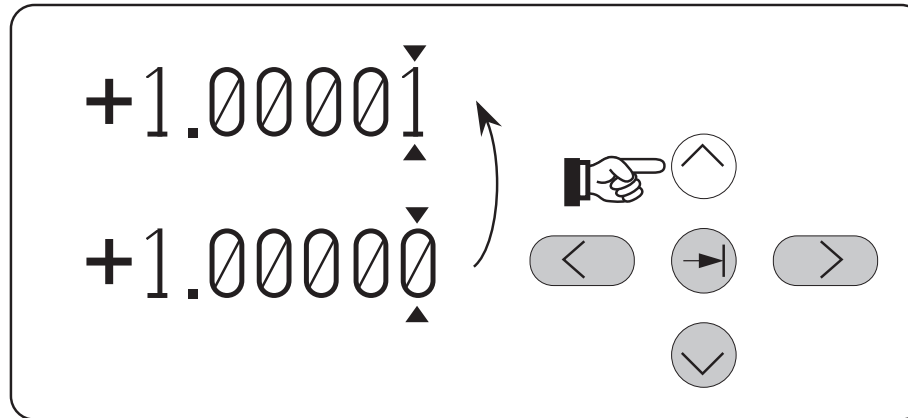

Fig. 3.4.2 Cursor Controls

3.4.4.3 Incrementing a Digit using the \wedge Key

 Press and release the \wedge Key. The marked digit increases by 1



3.4.4.4 Decrementing a Digit using the \vee Key

 Press and release the \vee Key. The marked digit decreases by 1

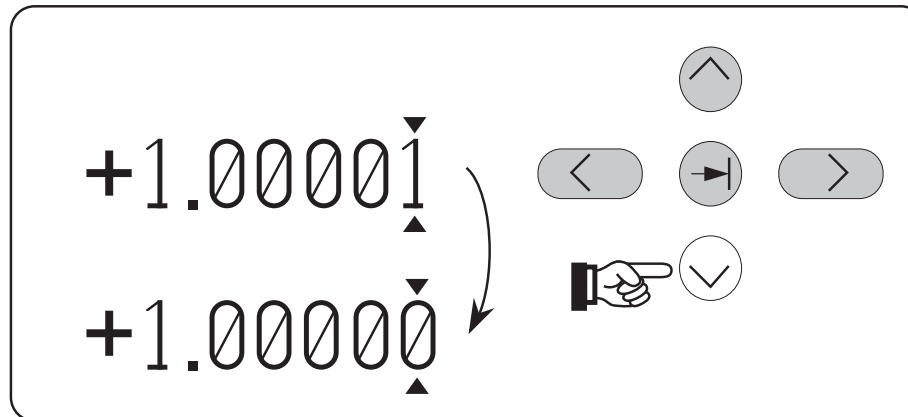

Final Width = 215mm

3.4.4.5 Increment/Decrement Auto-Repeat

For continuous automatic action, **press and hold** either of the above keys.

Note that the next (more significant) digit changes up as the increase passes from 9 to 0, and down as the decrease passes from 0 to 9.

 Leave the value set to +1.000000.

Final Width = 215mm

3.4.4.6 Incrementing a Digit using the Spinwheel

 Slowly rotate the Spinwheel **Clockwise**. The marked digit increases.

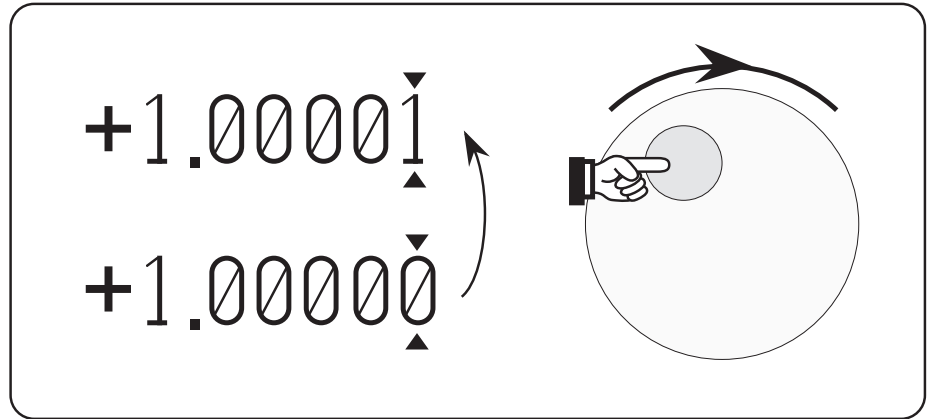

3.4.4.7 Decrementing a Digit

 Slowly rotate the Spinwheel **Counter-Clockwise**. The marked digit decreases.

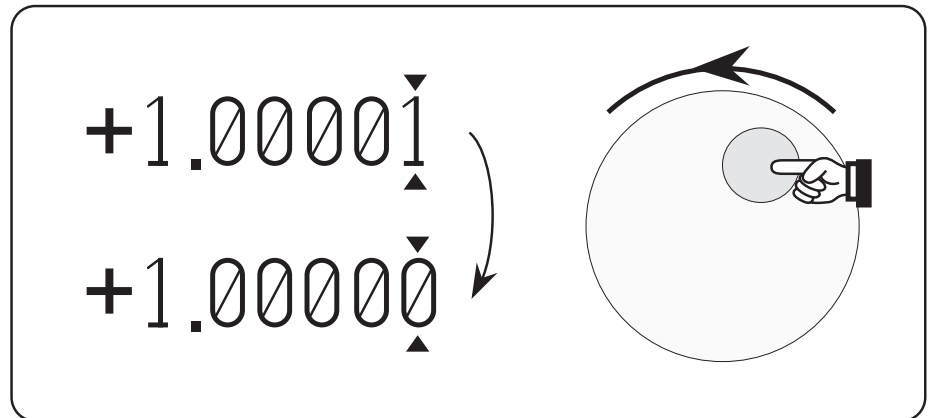



3.4.4.8 Continuous Increment/Decrement

For continuous automatic action, keep rotating the Spinwheel in the required direction. **Note** that the next (more significant) digit changes up as the increase passes from 9 to 0, and down as the decrease passes from 0 to 9.



 Leave the value set to + 1.000000.

3.4.4.9 Moving the Cursor Left

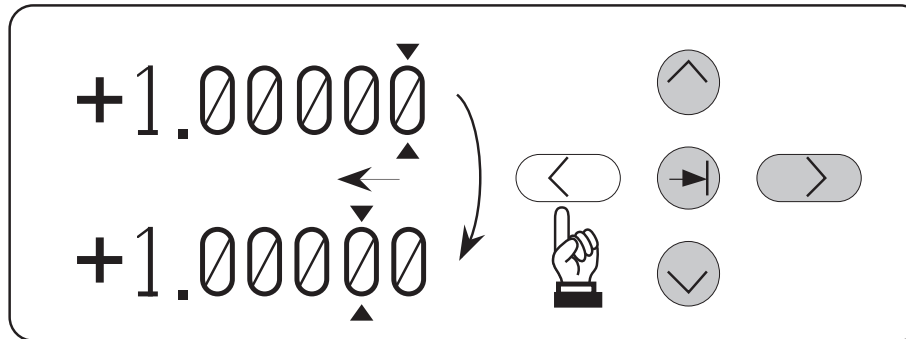
 Press and release the  Key. The cursor steps **left** to the next digit.



3.4.4.10 Moving the Cursor Right

 Press and release the  Key. The cursor steps **right** to the next digit.

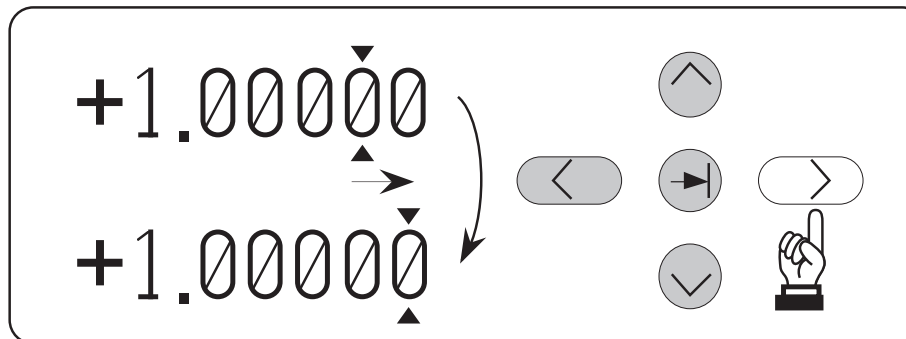

Final Width = 215mm

Setup for next tutorial stage.

3.4.4.11 Increment/Decrement at the new digit

Once the new digit is accessed, it can be incremented and decremented as before.

 Increment the value to 1.000005 V



3.4.4.12 Repeat Stepping

There is no auto-repeat built into the digit stepping keys. Stepping is repeated by successive key presses.



Note that there are limits to the above stepping. See *overleaf*.

Final Width = 215mm

3.4.4.13 Decreasing Resolution using the Cursor

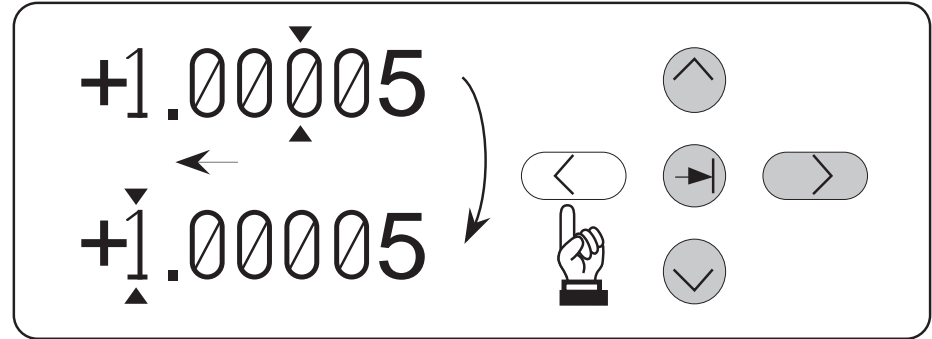
 **Keep Pressing and releasing** the  Key until the cursor reaches the most significant digit (the figure 1).



 **Press and release** the  Key twice more.

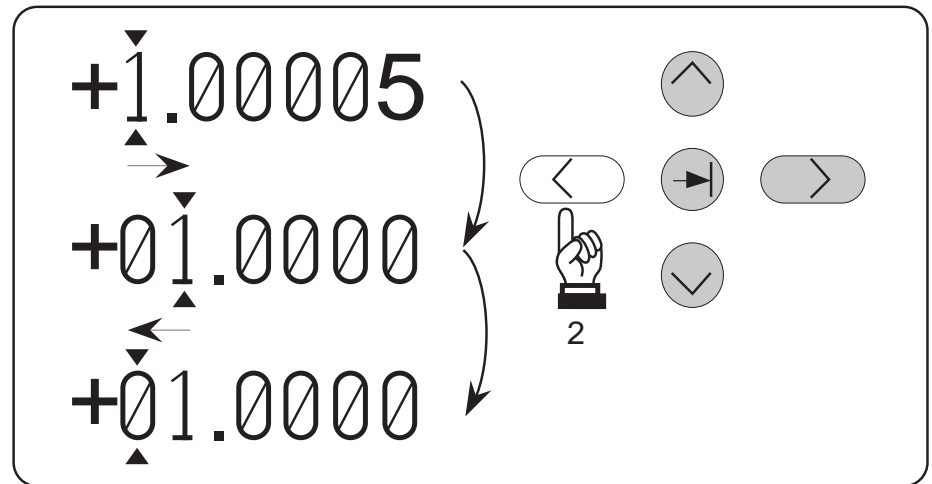

Note that two presses are required to reduce the resolution and reach the most-significant digit position:

- The first press just reduces the resolution from five decimal places to four, while the cursor moves right with its marked digit. The value is not rounded, but truncated — the '5' digit is lost and cannot be recovered except by incrementing after the original resolution has been restored;
- The second press moves the cursor left to reach the most-significant digit position.

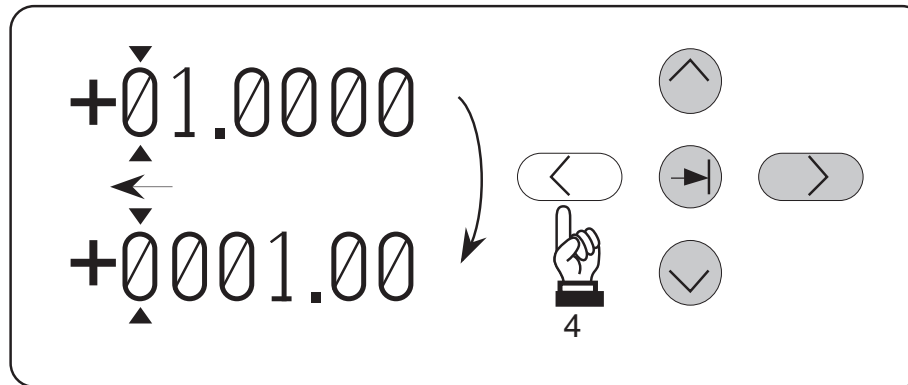

3.4.4.14 Resolution Change and Truncation of Display

 Press and release the  Key another four times.



Note that the resolution is now reduced to two decimal places, the lowest available in DCV function, but capable of displaying the highest voltage available from the 9100.

3.4.4.15 End-stop Recognition

 Press and release the  Key once again.

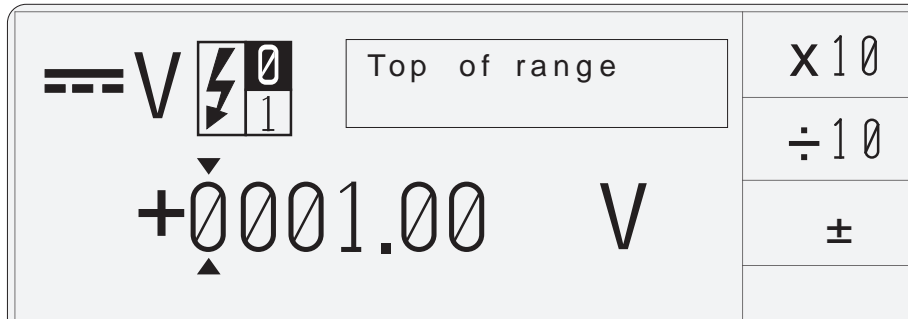

Once the value has reached the lowest resolution, it cannot be decreased further. Users are reminded of this by an error message in the top right corner of the screen, accompanied by an audible 'beep'. The cursor can be moved right as described in paras 3.4.4.10, finally increasing resolution until the opposite endstop is recognized, when another error message ('Reached lower boundary') will be presented.

Final Width = 215mm

Setup for next tutorial stage.

 Leave the value as shown above: +0001.00 V

Final Width = 215mm

3.4.4.16 Increasing Resolution using Shift-Right

This is a short cut method of changing resolutions:

 **Press and release either the ▲ Key or the ■ Key.** Note that an ikon representing the shift key appears on the bottom right corner of the screen.

 **Press and release the > Key.**

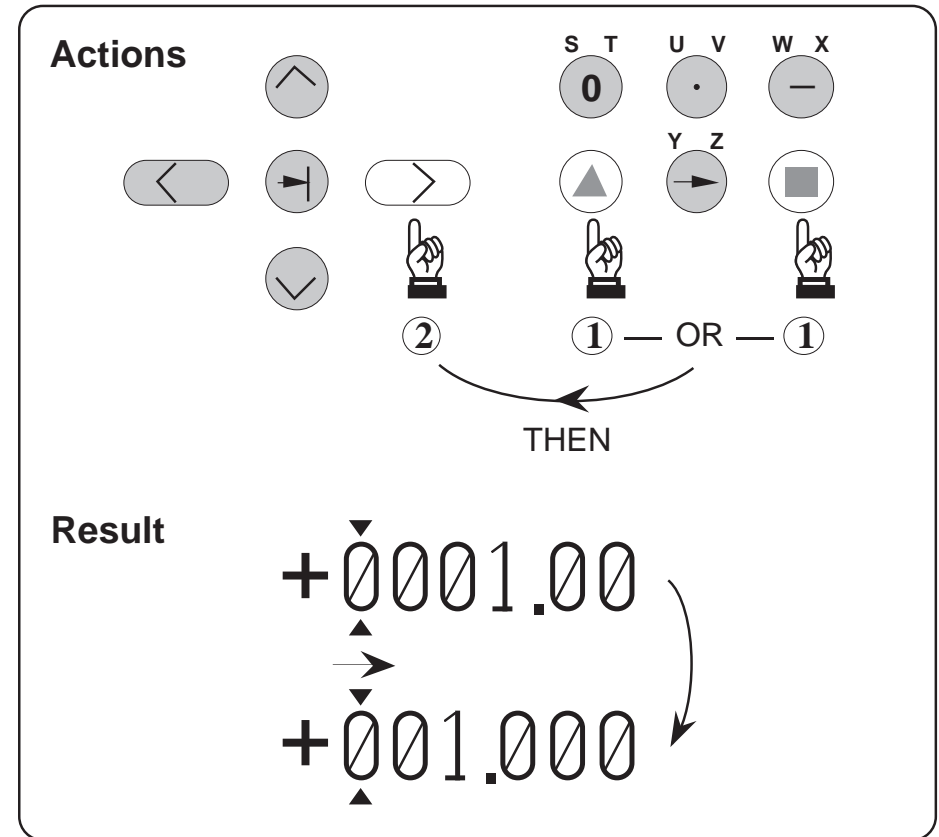

Note that the cursor will remain with its marked digit unless it is forced to move (as shown above) to the *new* most-significant digit.

Repeating shift-right actions will increase resolution to its higher limit (+1.000000 V), where the lowest voltages can be displayed. The 'Reached lower boundary' message is then displayed.

3.4.4.17 Decreasing Resolution using Shift-Left

This is the reverse process of changing resolution:

☞ Press and release *either* the ▲ Key *or* the ■ Key. Note that an ikon representing the shift key appears on the bottom right corner of the screen.

☞ Press and release the ◀ Key.

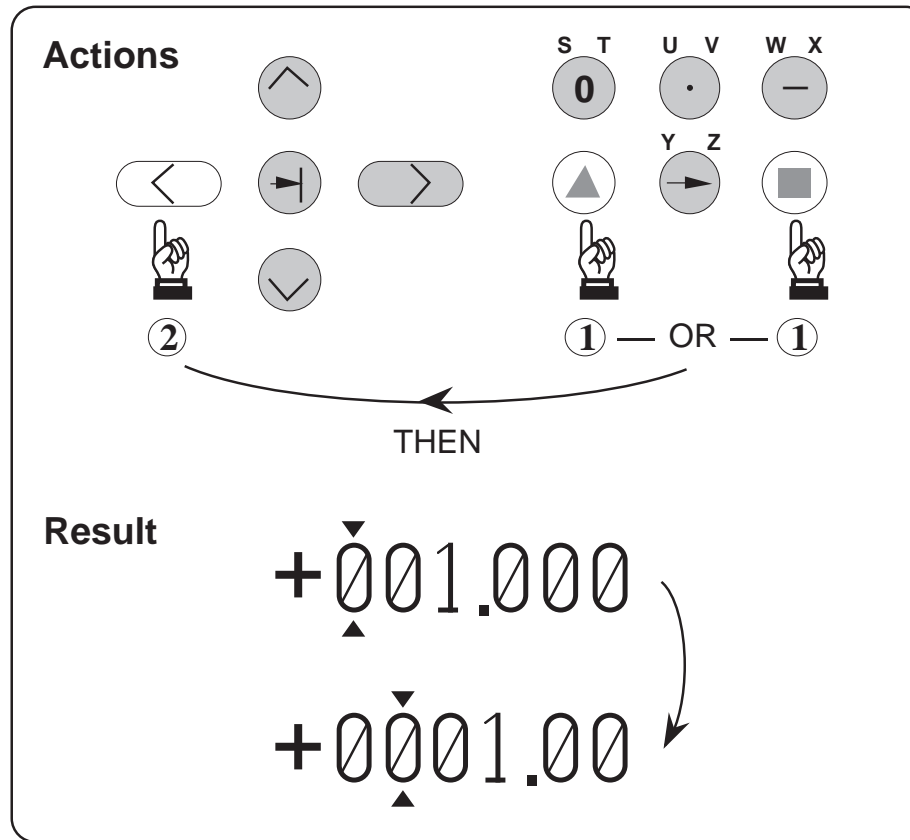

Final Width = 215mm

Note that the cursor will remain with its marked digit (as shown above) unless it is forced to move to the *new* least-significant digit.

Repeating the shift-left actions will decrease resolution to its lower limit. The 'Top of range' message is then displayed.

3.4.4.18 Use of the Δ Key to Access Voltage Deviation and Offset

So far, we have had only one value field on the screen — the target output voltage. There are many occasions when more than one value field will be present, for instance when in AC Voltage function a frequency value is presented on the display. In our present example of DC Voltage, we can place two more values on the display by pressing the deviation and offset screen keys:

 **Press and release** the Δ (Deviation and Offset access) Screen key.

The result will be as shown in Fig. 3.4.3, below:

Final Width = 215mm

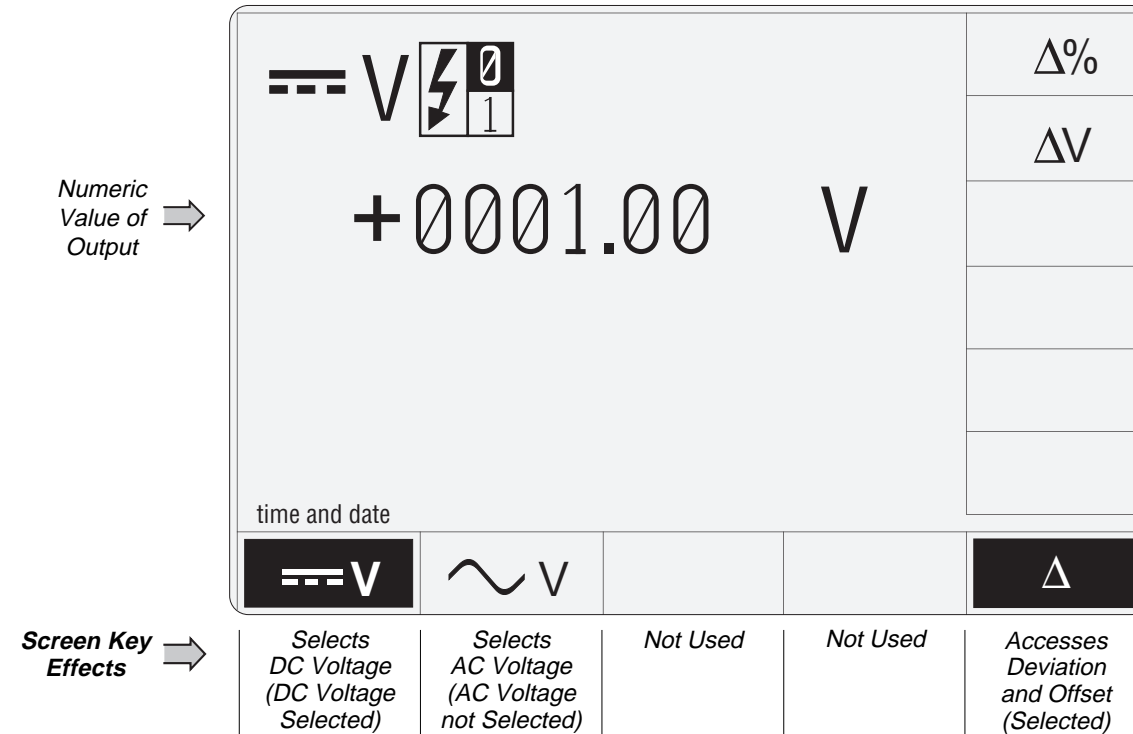

Fig. 3.4.3 DC Voltage Screen with Δ Selected

Summary of Deviation and Offset Selection:



Pressing the ' Δ ' key (bottom row) presents a screen with $\Delta\%$ and ΔV labelling the two top right screen keys:

Pressing the ' $\Delta\%$ ' screen key adds the 'Percentage Deviation' value to the lower left of the display presentation and the screen reverts to the main DC Voltage display. The Deviation value is limited to $\pm 10\%$ of the Output value.

Pressing the ' ΔV ' screen key adds the 'DC Voltage Offset' value to the lower right of the display presentation and the screen reverts to the main DC Voltage display.

3.4.4.19 Use of the Tab Key to Transfer between Value Fields

Now we can place more than one value field on the screen:

-  **Press and release** the $\Delta\%$ (Percentage Deviation) Screen key. The screen reverts to the main DC Voltage display, but with the deviation value (and the digit-edit cursors) appearing in the bottom left corner.
-  **Press and release** the Δ Screen key again to obtain the deviation and offset selection screen.
-  **Press and release** the ΔV (Voltage Offset) Screen key. The screen reverts to the main DC Voltage display, but with the offset value also appearing, in the bottom right corner. The digit-edit cursors have followed to the offset value.

The result will be as shown in Fig. 3.4.4, below:

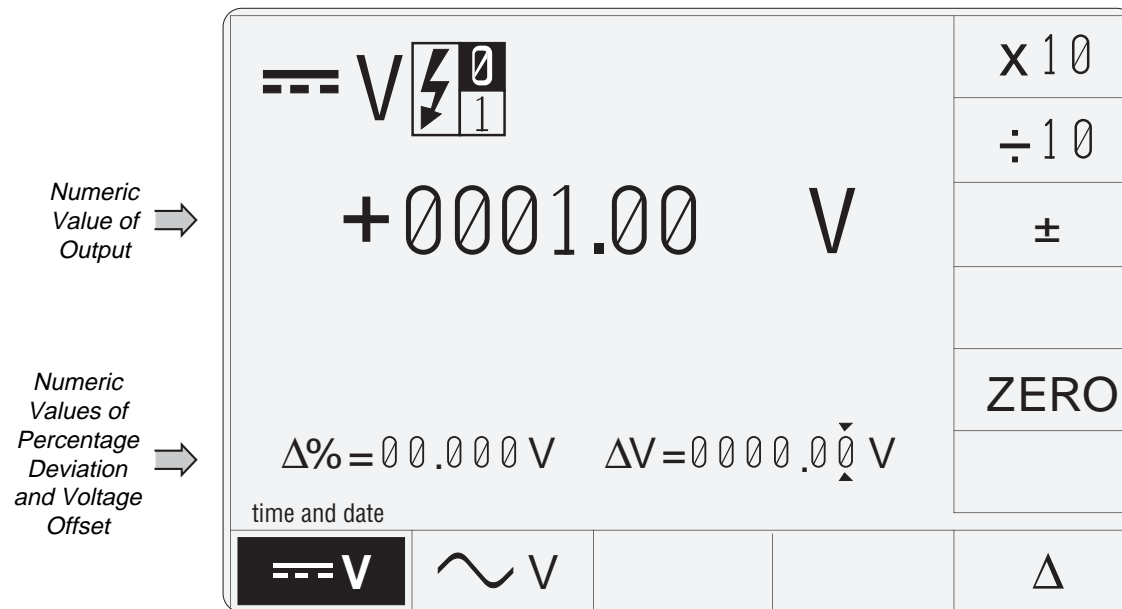

Fig. 3.4.4 DC Voltage Screen with Deviation and Offset Selected

Note that the cursor will always move to the value field for the latest selection. In this case, it moved to the ΔV value field, because we pressed the **Offset** screen key last.

3.4.4.19 Use of the Tab Key to Transfer between Value Fields (Contd.)

Note: The cursor always passes to the least-significant digit in its new value field.

Final Width = 215mm

 Press and release the Tab  key.

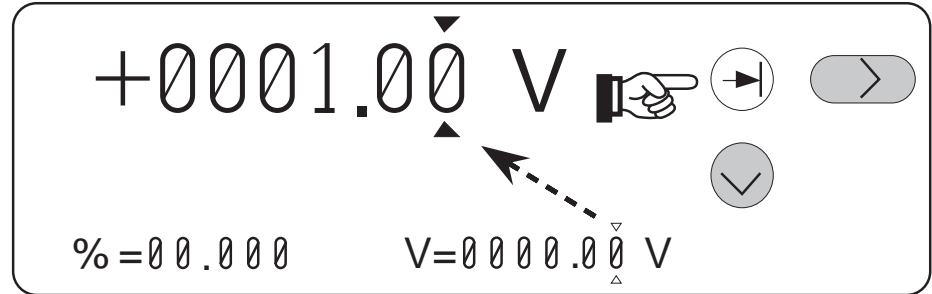

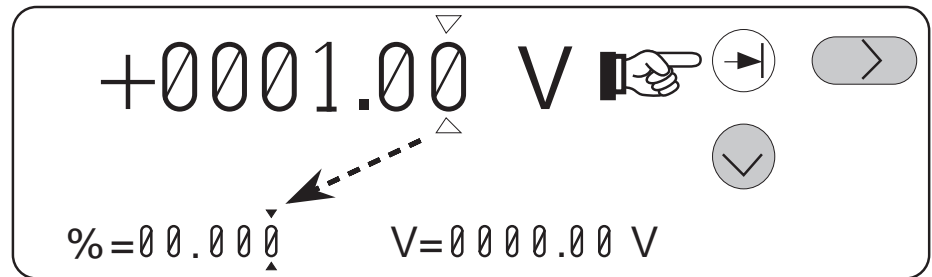

The methods already described for movements between digits, changing value resolutions (if allowed) and incrementing/decrementing digits can be used at the new value.

 Press and release the Tab  key again.



Notice the directions of movement. The general rule is that the cursor will move first down and left, then from left to right.

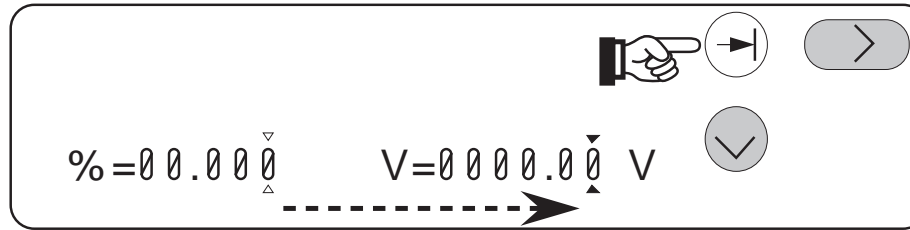

 **Press and release** the Tab  key a third time.



The cursor returns to the offset value.

Note: As the cursor moves to another field, the labels of the screen key change to indicate the available options (in this case the 'ZERO' key on the right side is available for the new main Voltage value, but not for deviation or offset).

Setup for next tutorial stage.

 **Press and release** the Tab  key again to place the cursors on the main output value field.

Final Width = 215mm

Final Width = 215mm

3.4.5 Direct Edit Facility

Having dealt with the Digit Edit facility, we shall now go on to consider the alternative Direct Edit facility.

Direct Edit is not a default state. Digit Edit will always be forced at power-on, and when changing modes and functions.

Each method has its own advantages, which will become apparent with experience of using the front panel controls.

Direct Edit facility employs the numeric keypad to enter whole values, where this is more convenient than operating on individual digits in 'Digit Edit' facility.

3.4.5.1 Value Entry Box

As we saw before from *Fig. 3.4.1*, the numeric value of the 9100 output is normally displayed in large characters just above the center of the screen. Once the Direct Edit facility has been invoked, an enclosed area (box) is provided on the screen, below a reduced-size version of the value to be changed. The box can be seen in *Fig. 3.4.7*.

3.4.5.2 Direct Edit Controls

The main means of controlling Direct Edit are the numeric keys of the alpha numeric keypad, highlighted in *Fig. 3.4.5*, below.

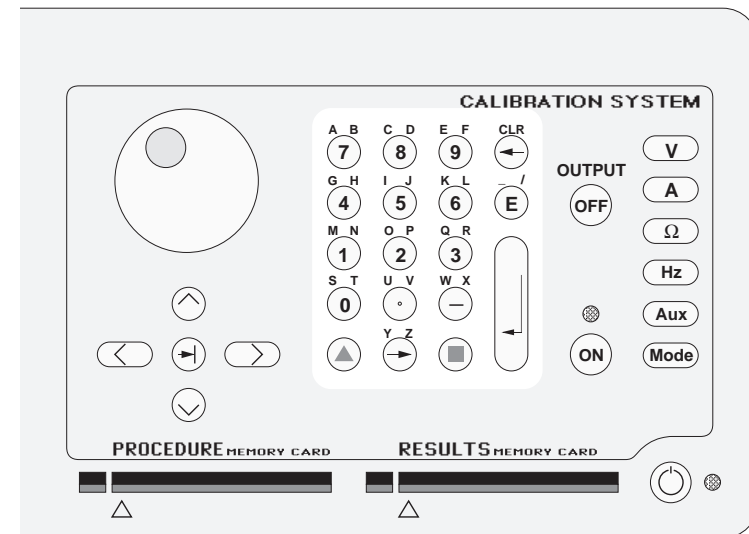

Fig. 3.4.5 Direct Edit Controls

3.4.5.3 Starting Point

When we finished the 'Digit Edit' tutorial, we left the front panel screen as shown in *Fig. 3.4.6*, below.

- ☞ If things have changed since then, please use Digit Edit to manipulate the screen to conform with *Fig. 3.4.6*. Ensure that the cursor is as shown on the Output Value.

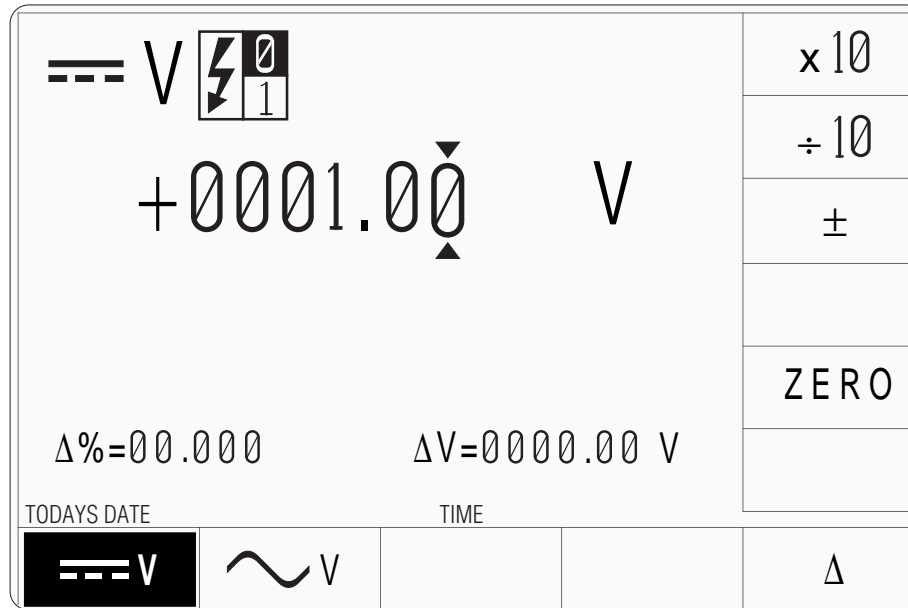



Fig. 3.4.6 Starting Point for 'Direct' Editing

Next, we shall see the effects of using the numeric keypad.

Final Width = 215mm

3.4.5.4 Use the Numeric Keypad to Set a New Value

 Type the number '10' on the numeric keypad:

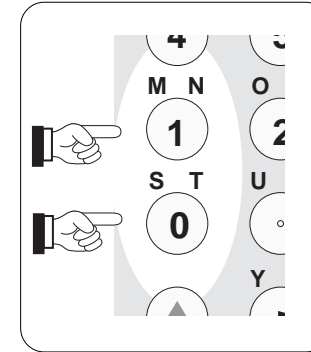

 Observe the change in output value presentation.

 Observe the change in screen key labels.

Note:

The screen keys on the right of the display have been re-labelled.

The new keys act as equivalents of the ↵ key on the numeric keypad, when scaling of the entered value is required.

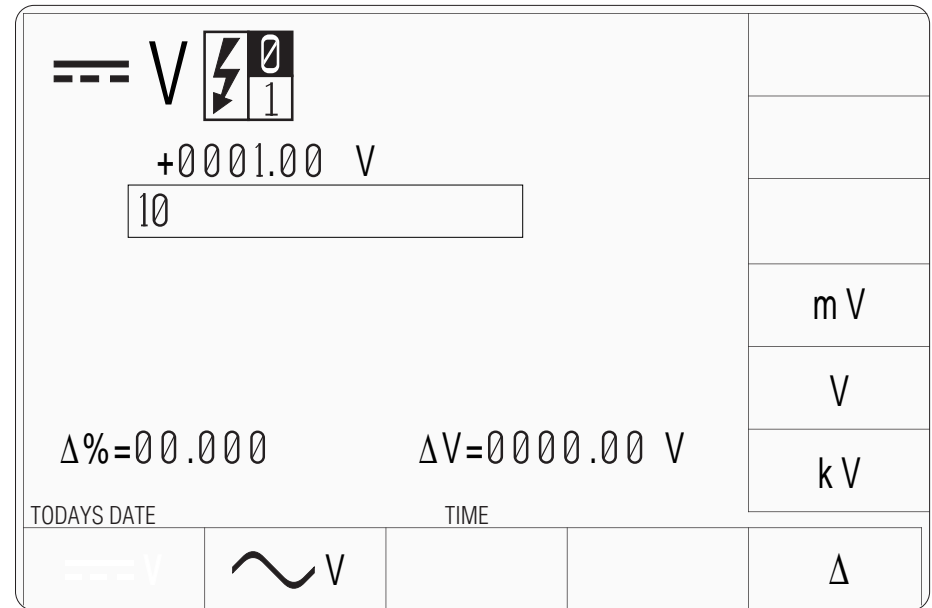



**Fig. 3.4.7 'Direct' Editing —
Effect on Output Value and Screen Key Labels**

3.4.5.5 Enter the New Value

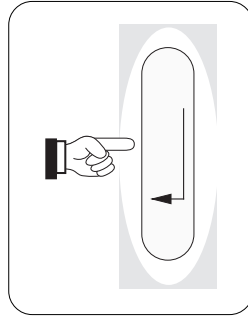
 Press the 'Enter' key on the numeric keypad:



 Note that the box has disappeared, the screen key labels have reverted and the display is back in 'Digit Edit', with cursor.

 Note that the resolution has increased to four decimal places, both for the output value and the offset value.

Note:

There is no '+' key on the keypad. When you type values with no sign, this implies 'positive'. For 'negative' values, type the keypad hyphen.

Rule:

When any Direct Edit value is entered, using the ↵ key, the display reverts to Digit Edit.

Rule:

When reverting from Direct Edit to Digit Edit, the new value is presented with its best resolution. The cursor will, of course, mark the least-significant digit

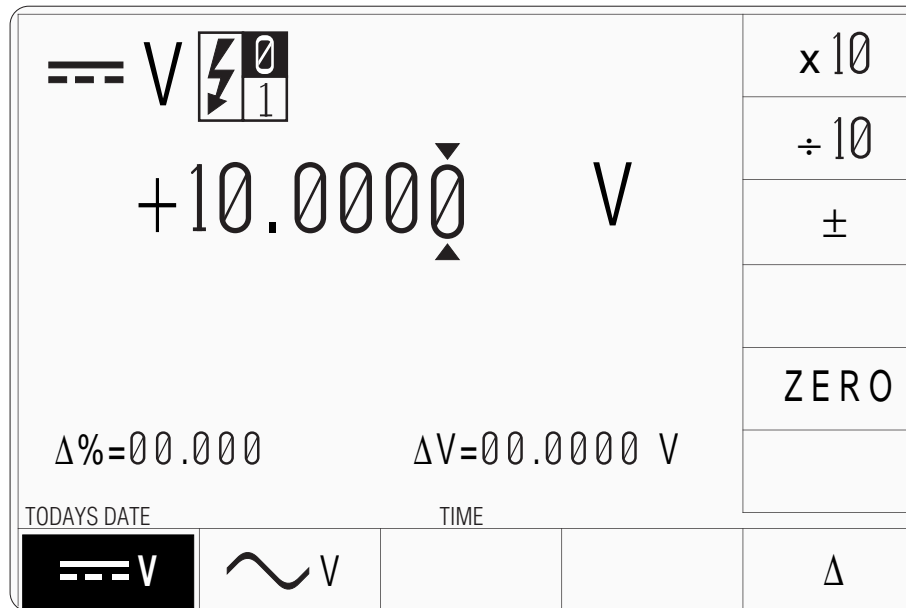

Fig. 3.4.8 Result of Pressing the 'Enter' Key

Final Width = 215mm

Note:

The screen keys on the right of the display have been re-labelled. The new '%' key is merely the equivalent of the ↵ key on the numeric keypad. No scaling of the Deviation % figure is available.

3.4.6 Combined Practice using Digit Edit and Direct Edit Facilities

Now we have seen both methods of moving around the screen and changing values, we can use them to investigate other features. We shall start from the point at which we left the tutorial.

☞ If things have changed since then, please use Digit Edit to manipulate the screen to conform with *Fig. 3.4.8*. Ensure that the cursor is as shown on the Output Value.

3.4.6.1 Editing Deviation Values

☞ Press the Tab (⇨) key. The cursor moves to the deviation value.

☞ Type the number '0.5' using the numeric keypad. The edit box will appear with 0.5 inside it (values of deviation are limited to a maximum of ±10%):

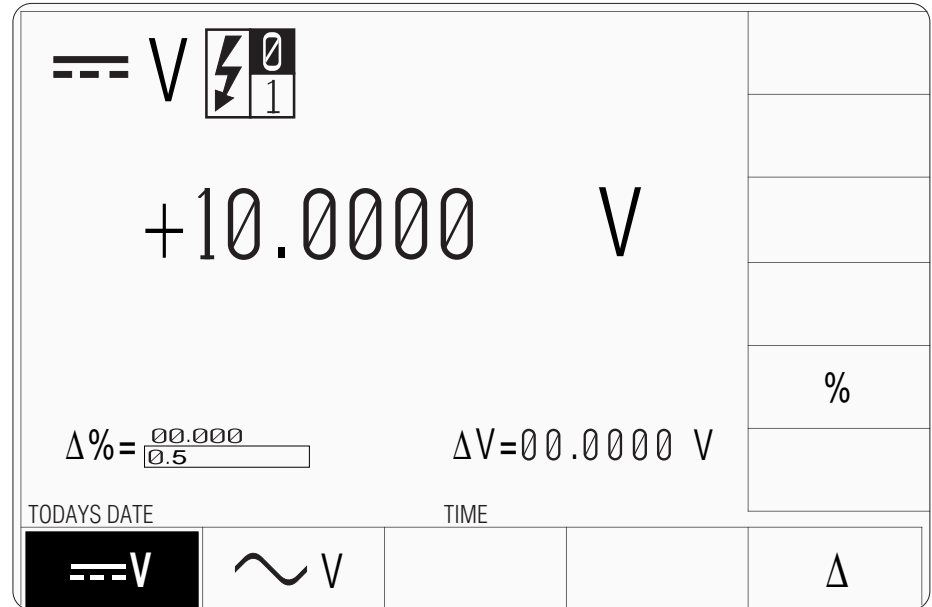

Fig. 3.4.9 Form of Display for Direct Edit of Deviation Value

☞ Press the screen key, on the right side of the display, labelled '%'. This is equivalent to pressing the Enter (↵) key on the numeric keypad. The box disappears, and its contents become the new deviation value, whose size on the screen is restored. The new value adapts to the fixed deviation resolution:

$$\Delta\% = 00.500$$

3.4.6.2 Editing Offset Values

Press the Tab key. The cursor moves to the offset value.

This time we shall enter a positive offset of 100mV:

Type the number '100' using the numeric keypad (the + sign is not available on the numeric keypad). The edit box will appear with 100 inside it:

Note:

The screen keys on the right of the display have been re-labelled.

The new keys act as equivalents of the \downarrow key on the numeric keypad, when scaling of the entered value is required.

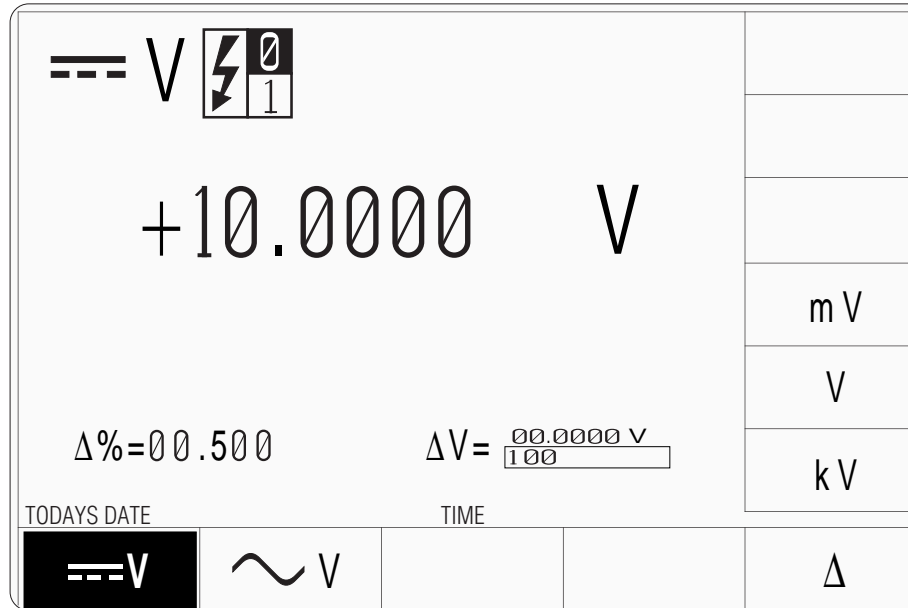

Final Width = 215mm

Rule:

The resolutions of the Output and Offset Values must be identical. When entering a new Output Value or Offset Value, if the resolutions of the two values are different, the firmware will seek the best resolution to satisfy both values. The new values which appear when the Direct Edit box is removed will generally be fixed at the lowest resolution of the two.

Press the screen key, on the right side of the display, labelled 'mV'. This fixes the new offset value at 100mV, but because the resolutions of offset and output values are different, the firmware will seek the best resolution which satisfies both values. In this case, the best available resolution is that of the output value of 10.0000 V, so the new value which appears when the box is removed (remember the 'mV' screen key is also the equivalent of the \downarrow key) becomes 00.1000 V.

$$\Delta V = +00.1000 \text{ V}$$

Final Width = 215mm

3.4.6.3 Editing Large Offset Values

In calibrators with 'Floating' outputs, the permitted offset value is usually limited, because the output Lo can float to large values. However, for safety reasons, the 9100 output is 'Earthy' (i.e. the Lo and I- terminals are tied to analog Ground) and it is necessary to permit values of offset which approach the maximum available output value, in order to match possible offsets of the UUT.

In the following exercise, a very large offset is entered to illustrate the effect on the tied resolutions of the two values.

Please be very careful: Ensure that the OUTPUT remains OFF throughout the whole of the exercise.

After the previous exercise, the cursor has remained on the offset value.

This time we shall enter a negative offset of 1000V:

 Type the number '-1' using the numeric keypad. The edit box will appear with the number '-1' inside it:

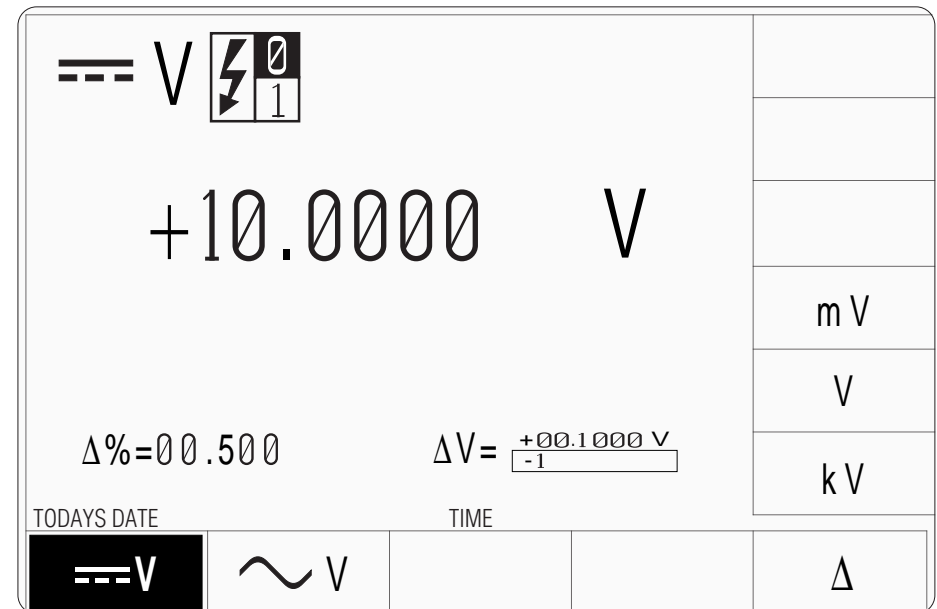

- ☞ Press the screen key, on the right side of the display, labelled 'kV'. This fixes the new offset value at -1kV, but again, because the resolutions of offset and output values are different, the firmware will seek the best resolution which satisfies both values. In this case, the best available resolution is that of the offset value of -1kV, so the new value which appears when the box is removed (remember the 'kV' screen key is also the equivalent of the \downarrow key) becomes -1000.00 V.
- ☞ Now observe the output value. Notice that the resolution of the +10V is now adapted to that of the -1kV offset, i.e. +0010.00.

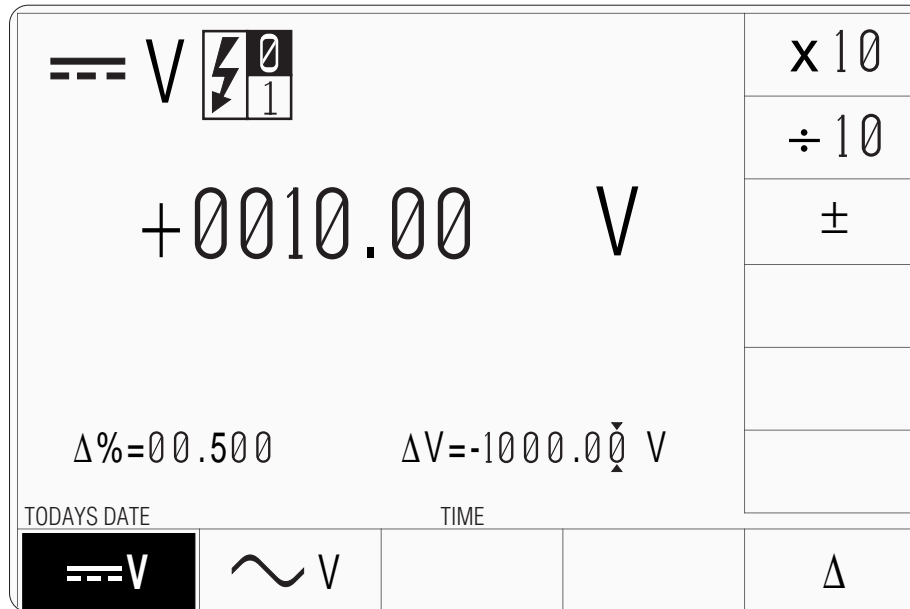



















Final Width = 215mm

3.4.7 Continuous Dynamic Range









3.4.7.1 Six Significant Digits — Restriction of Maximum Output Values

In this sequence, we shall see how the output value is restricted by the present level of absolute resolution with six significant figures available. We shall start at the point we had reached in the Offset Editing tutorial on *page 3-53*, then transfer to maximum resolution of 1µV increments, to discover the span of output values. After the exercise, we shall discuss the results.

Start where we finished the Offset Editing tutorial (*p3-53*).

Action	Result	Comment
1. We will concentrate on manipulations of the Output Value, and must first transfer the cursor from the Offset value to the Output value. Do this by cancelling both Offset and Deviation displays:		
 Press Δ then ΔV	+ 0010.00 V	As the Offset display disappears, the cursor moves to the least-significant digit of the Output Value. This would also have happened if you had cancelled $\Delta\%$ first.
 Press Δ then $\Delta\%$	+ 0010.00 V	The Deviation display disappears.
2. Use Direct Edit to transfer to the maximum resolution.		
 Type 100 and Press mV	+ 100.000 V	This is the maximum resolution possible — 1µV increments.
3. Choose the digit to be changed:		
 Press  five times	+ <u>1</u> 00.000 mV	The cursor moves to the most-significant digit
4. Does the output value pass through zero at this resolution?		
 Press  once	<u>0</u> 00.000 mV	The output value reduces to Zero at maximum resolution
5. Does the output have negative values at this resolution?		
 Press  once	- <u>1</u> 00.000 mV	This negative value can be as large as -320mV
6. Let us look for the largest positive output at maximum resolution:		
 Press  four times	+ <u>3</u> 00.000 mV	We are aiming towards +320mV
 Press  once	+ 3 <u>0</u> 0.000 mV	The cursor must be in the correct place
 Press  twice	+ 3 <u>2</u> 0.000 mV	This is the largest possible value at maximum resolution, but we can try to increase it by the smallest increment of 1µV:
 Press  four times	+ 320. <u>0</u> 00 mV	The cursor moves to the 1µV 'units' digit:
 Press  once	+ 320.0 <u>0</u> 0 mV	No change in output value, but you should hear a warning tone, and see an error message (Up range required).

Final Width = 215mm

Action	Result	Comment
To increase the value, while still using six significant digits, we must reduce the absolute resolution to 10μV:		
Press  then 	+ 0.32000 V	Instead of shift-left, we could have just pressed  six times, but this would displace the cursor six places to the left also.
Press  once	+ 0.32001 V	With this level of reduced resolution we can increase the value beyond the earlier limit (as far as ±3.20000V if we wish).
Press  once	+ 0.32000 V	At this resolution, we could also go down to zero.
7. Now let us introduce the action of the X10 screen key while looking for the largest positive output value at the present (10μV) resolution:		
Press the X10 screen key	+ 3.20000 V	If you look at the decimal point, you will see that we are still at the same resolution (10μV). The X10 screen key has had the effect of multiplying the output value by ten (but isn't that just what we expected?). Let us now try to increase the value by incrementing:
Press  once	+ 3.20000 V	No change in output value, but you should hear the warning tone, and see the error message.
To increase the value, while still using six significant digits, we must reduce the absolute resolution to 100μV:		
Press  then 	+ 03.2000 V	Same effect as before: the present value is available at lower resolution.
Press  once	+ 03.2001 V	With this level of reduced resolution we can increase the value beyond the earlier limit (as far as ±32.0000V if we wish).

Final Width = 215mm

Let us consolidate the exercise we have just completed, by stating the rules which govern the movement across thresholds as we increase the value by incrementing. It appears, so far, that for each absolute resolution, there is a limited span of output values. The span seems to increase by a factor of ten as we reduce to the next lower resolution. This is, in fact, the case, except for the largest output values, where the span is limited to ±1050V by other means, at the lowest resolution of 10mV increments (attempts to exceed 1050V will fail, and elicit a message: 'Target too big').

But why choose to switch resolutions at values featuring '32', and not '10'? Over the range of UUT instruments, calibration points are least likely to occur at values featuring '32'. So by switching at '32', life will not be complicated by having to switch resolutions close to the calibration values (featuring '10' or '30') where operators may be slewing the source.

On the next page, you will find a table which shows the spans of all DCV outputs for each of the resolutions as we discuss further the features of the 9100's continuous dynamic range.

Final Width = 215mm

3.4.7.2 Smooth Increments — No Range Switching

The 9100 provides a continuous dynamic range for its functions. As far as possible, this is made available by smooth increments, and no range switching is implemented. However, two main characteristics of such a wide dynamic range impose themselves upon the practical achievement of this aim. To illustrate their implications, we have chosen DC Voltage as an example.

3.4.7.3 DC Voltage Example

The DC Voltage output is variable in steps from $1\mu\text{V}$ up to 1,050V.

Scale Length

It is extremely unlikely that users will ever wish to adjust voltages in the order of 1000V at the maximum possible resolution of $1\mu\text{V}$ (this would require a scale length of 1000.000000!).

For efficient operation at the levels of DC Voltage accuracy required of the 9100, a scale length of six significant digits is more than adequate, so this has been implemented. Five spans of DC Voltage exist within the full DC Voltage dynamic range, each with its own constant absolute resolution. In the following table, the extent of each span is related to its resolution:

Absolute Resolution	Span of Values	Nominal Span Value
$1\mu\text{V}$	-320.000 mV to +320.000 mV	300mV
$10\mu\text{V}$	-3.20000 V to +3.20000 V	3V
$100\mu\text{V}$	-32.0000 V to +32.0000 V	30V
1mV	-320.000 V to +320.000 V	300V
10mV	-1050.00 V to +1050.00 V	1000V

The span thresholds have been fixed at the above values, as explained earlier, to avoid the need to cross thresholds during normal slewing operations around calibration points.

Internal Hardware Configurations

Over such a wide range of values, several different analog hardware configurations are necessary. This only makes an operating difference when output is on, as it must be turned off in order to reconfigure, then back on again for the new value. As far as is possible, the configuration boundaries are arranged to occur at the resolution thresholds, and the interruption is very brief.

Rules of passage across thresholds are incorporated into the internal firmware to minimize interruptions to smooth operation.

3.4.7.4 Resolutions — Crossing Thresholds

Increasing Output Voltage

When increasing output or offset value using the \odot (increment) key in Digit Edit facility; if the new value is too large for the present span of values, then an audible warning will be given, with a reminder on the screen. The operator must change to the next lower resolution using the \odot key. The next lower resolution will be activated with a larger span of values. This rule applies whether OUTPUT is OFF or ON.

When increasing output or offset value using either the X10 screen key or the Direct Edit facility; if the new value is too large for the present resolution, then the appropriate lower resolution will be activated with a larger span of values. No warning will be given. This rule applies whether OUTPUT is OFF or ON.

Decreasing Output Voltage

When decreasing output or offset value using Digit Edit; positive and negative values down to zero can be obtained within the present span. However, if the required value lies between increments of the present resolution, then the user must increase the resolution, also reducing the value span. This rule applies whether OUTPUT is OFF or ON.

When decreasing output or offset value using either the $\div 10$ screen key or the Direct Edit facility; if the required value lies between increments of the present resolution, then the appropriate greater resolution will be activated with reduced span. No warning will be given. This rule applies whether OUTPUT is OFF or ON.

Final Width = 215mm

3.4.7.5 Reconfiguring Hardware

Output OFF

When increasing or decreasing output voltage, using any method: if the new value is too large or small for the present hardware configuration, then if OUTPUT is OFF there will be no noticeable effect as the hardware reconfigures.

Output ON

If OUTPUT is ON, it will be temporarily turned OFF so that the hardware can reconfigure, then ON again at the new voltage. No warning will be given. This interruption should cause little disturbance to the reading on any UUT.

3.4.7.6 DC Voltage Function — Low and High Voltage States

Our example is given in terms of DC Voltage function, which incorporates a safety measure to avoid inadvertent application of high voltages to the output terminals (also incorporated in AC Voltage function). Rules, built into firmware, govern transit between Low and High Voltage states. These rules are discussed in *Sections 4.3 and 4.4*.

Final Width = 215mm

3.4.8 Screen Keys

3.4.8.1 Bottom Screen Keys

The soft keys along the bottom of the LCD screen are provided to alter functionality. For instance, the $\sim V$ screen key transfers from DC Voltage output to AC Voltage output, and the Δ screen key allows us to add the 'Percentage Deviation' and 'Offset Voltage' value to the display presentation.

3.4.8.2 Right Side Screen Keys

The soft keys along the right side of the LCD screen generally perform operations on the values which are marked by the cursor. For instance, when the output value is marked by the cursor, the \pm screen key will reverse output polarity. When using Direct Edit facility to alter the DC Voltage Offset value, pressing the **mV** key will express the figure in the editing box as millivolts and the DCV offset will be one thousandth of the value it would have been if the **V** key had been pressed. The **mV** key also acts instead of the numeric keyboard \downarrow key, to close the editing box.

Now let us look at the **X10** and $\div 10$ keys.

3.4.8.3 Using the X10 and $\div 10$ Screen Keys

The two multiplier screen keys are present in the menu screens of most functions when using Digit Edit facility. Their action is to multiply or divide, by a factor of ten, the Output, Deviation or Offset value marked by the cursor (Deviation value limited to $\pm 10\%$). They do not have auto-repeating action. Neither are available when using Direct Edit facility.

X10

When multiplying, the new value is accommodated and activated within the present resolution, or placed in a lower resolution and activated, subject to the rules governing any thresholds which will be crossed. Refer to *paras 3.4.7*.

$\div 10$

When dividing, the new value is accommodated and activated within the present resolution, or placed in a higher resolution and activated, subject to the rules governing any thresholds which will be crossed. Refer to *paras 3.4.7*.

3.4.9 Summary of the Introductory Tutorials

3.4.9.1 Manipulation Practice

During the tutorials, we have encouraged you to manipulate the front panel controls to encounter some of their primary features, and have some practice. With experience, you will increase the ease and confidence with which you can set parameters of output.

3.4.9.2 Index of Tutorials and Discussions

	<i>Page</i>
Changing Resolution Left/Right Keys	3-38/39
Configuration Mode	3-6
Continuous Dynamic Range	3-54
Crossing Resolution Thresholds	3-57
Cursor	3-33/34
Digit Edit Facility	3-34
Direct Edit Facility	3-46
Editing Deviation Values	3-50
Editing Offset Values	3-51
Front Panel Features	3-3
Function Keys	3-3
General Arrangement of Front Panel Controls	3-2
Implications of Six Significant Digits	3-54/56
Increasing and Decreasing Resolution using Shift-Left & Shift-Right	3-40/41
Incrementing/Decrementing Digits: Cursor Keys	3-35
Incrementing/Decrementing Digits: Spinwheel	3-36
Left/Right Selection of Digits	3-37
Manual Mode	3-32
Mode Overview	3-5
Mode Selection	3-4
Output Controls (General)	3-32
Spans of Values	3-56
Reconfiguring Hardware	3-57
Screen Keys	3-58
Transfer between Values using the Tab Key	3-43/45
Typical Menu Screen	3-33

3.4.9.3 Looking Forward to Section 4

We have not yet covered all of the ground, and will continue in Section 4 to consider each of the 9100 functions in greater depth.

Final Width = 215mm

Section 4 Using the Model 9100 — Manual Mode

4.1 About Section 4

Section 3 should have given you practice at manipulating the front-panel controls. In Section 4 we shall guide you, in a general way, through the phases of operating the 9100 from the front panel, to calibrate a manually-operated measuring instrument. For a guide to using memory cards in Procedure Mode, please turn to *Section 5*.

Section 4 is divided into 'Functions' (DC Voltage, AC Voltage etc.) in the following sub-sections:

- | | | | |
|-----|------------------|------|----------------------------|
| 4.2 | Interconnections | 4.10 | Mark/Period |
| 4.3 | DC Voltage | 4.11 | % Duty |
| 4.4 | AC Voltage | 4.12 | Auxiliary Functions |
| 4.5 | DC Current | 4.13 | Capacitance |
| 4.6 | AC Current | 4.14 | Temperature — Thermocouple |
| 4.7 | Resistance | 4.15 | Temperature — RTD |
| 4.8 | Conductance | 4.16 | Logic Pulses |
| 4.9 | Frequency | 4.17 | Logic Levels |

Final Width = 215mm

E-M Interference:

Noisy or intense electric, magnetic or electromagnetic fields close to instruments or connectors can disturb the measurement circuit.

Some typical sources are:

- Proximity of large electric fields
- Fluorescent lighting
- Inadequate screening, filtering or grounding of power lines
- Transients from local switching
- Induction and radiation fields of local E-M transmitters
- Excessive common mode voltages between source and load

The disturbances may be magnified by the user's hand capacitance. Electrical interference has greatest effect in high impedance circuits. Separation of leads and creation of loops in the circuit can intensify the disturbances.

4.2 Interconnections

4.2.1 Introduction

This sub-section deals with the leads used to connect the 9100 to UUTs, and suggests the advantages of using the Model 9105 Lead Set for external connections.

4.2.2 External Leads — Specification Degradation

The 9100 Accuracy Specification is delivered at the front panel terminals.

Degradation of the specification at the UUT can occur if care is not taken to select the correct type, length and terminations for the external leads. This applies particularly to the outputs of HF AC Voltage at milliamp levels and HF AC Current. In addition, for accurate thermocouple simulation, extension leads of the correct materials must be used to avoid spurious junctions, although this also applies with the use of the 9105 leadset.

4.2.3 Model 9105 Lead Set

The design of the Model 9105 optimizes the connections between 9100 and UUT, in order to deliver the specification for the outputs of all functions at the input terminals of all UUTs. It also provides a convenient screened work mat which permits easy connection to the UUT using leads of defined short length, which are also provided.

It is highly recommended that the 9105 Lead Set be used for all hand-held UUTs.

N.B. The 10-turn and 50-turn current coils, which are used to calibrate clamp meters at high DC and AC current values, should not be placed on the work mat, as this incorporates a steel core.

Final Width = 215mm

Final Width = 215mm

4.2.3.1 Lead Set Description

General

As can be seen from *Fig 4.2.1*, the 9105 plugs into the 9100 front panel terminals and D-type socket, and provides a connection unit (which is fitted beneath the work mat) from which short leads pass through slots in the mat, to plug into the UUT safety terminals. A set of adaptors is provided which can be used for UUTs which do not use safety terminals.

Thermocouple Connection

A 15-pin D-type socket is fitted on the end of the connection unit, to accommodate a Thermocouple Adapter. This includes two reference junctions mounted on an isothermal block. Two short extension leads (K-type and J-Type) are provided with the kit. The blade sockets in the end of the adapter conform to the standard thermocouple fitting.

As an alternative, in the absence of a 9105 lead kit, the Thermocouple Adapter can be used by plugging directly into the D-type socket on the front panel of the 9100.

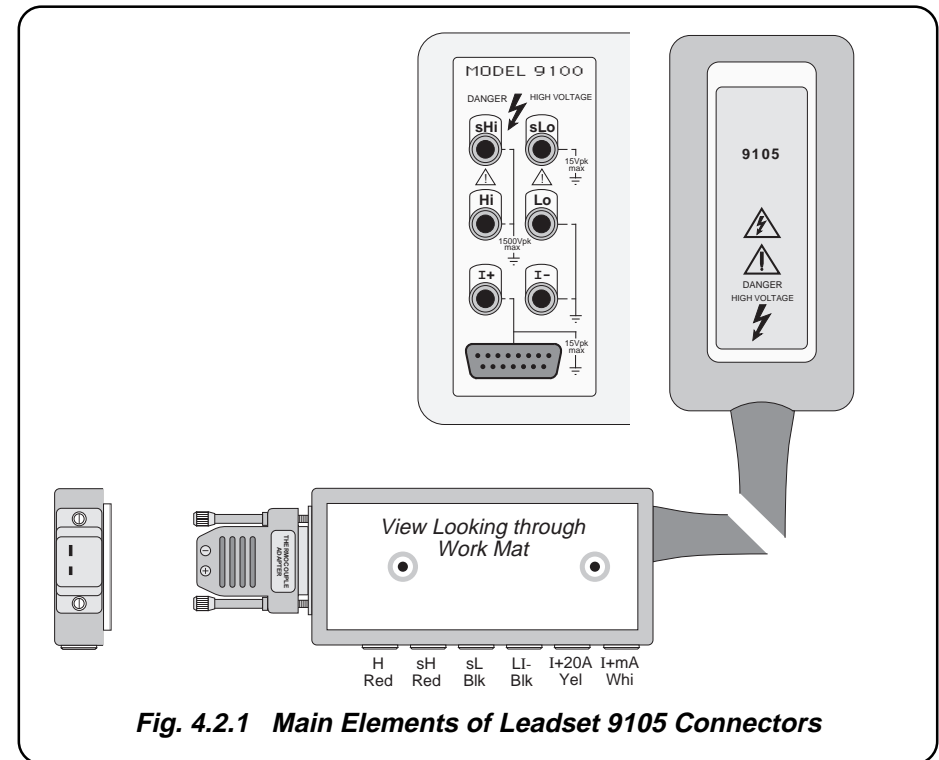

Fig. 4.2.1 Main Elements of Leadset 9105 Connectors

4.2.3.2 Work Mat Facilities

Layout and Connections

The layout of the 9105 Work Mat is shown in *Fig 4.2.2*. The connecting leads would not all be connected at the same time, but the relevant connections for each Function (ACV, DCI, thermocouple etc.) are given with the procedures for individual functions in the corresponding sub-sections of *Section 4*.

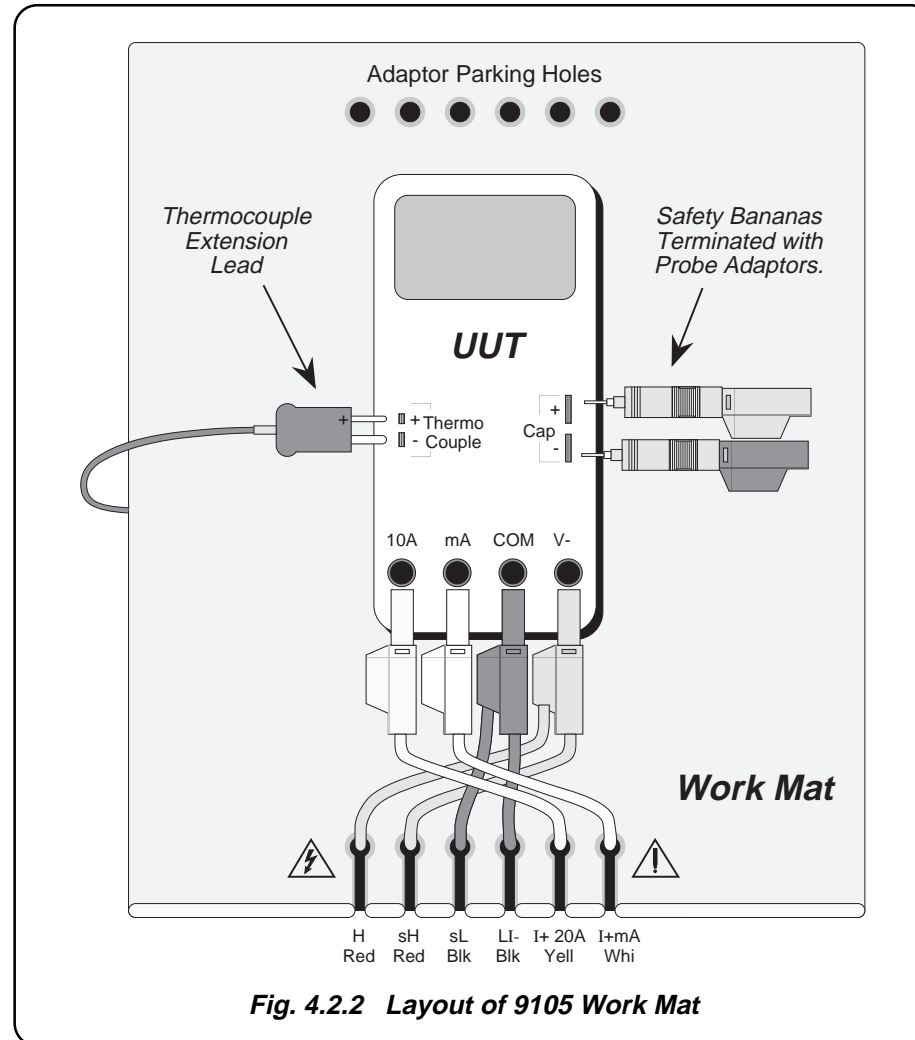

Fig. 4.2.2 Layout of 9105 Work Mat

Final Width = 215mm

Caution:

The ⚠ symbol, shown on elements of the 9105 leadset, draws attention to information contained in this handbook regarding maximum output voltages and currents.

For details, refer to *Volume 2* of this handbook: *Section 7—Specifications; page 7-1*.

4.2.4 Lead Types when the 9105 is not Used

If it is decided not to use the 9105, reductions in the degradation of specification can still be achieved, using appropriate connections on short leads of the correct type. To assist in this, *Fig. 4.2.3* shows the internal connections in the 9105, and the cross section of the 9105 main cable shows how the leads are laid out. The lead types are also described.

Final Width = 215mm

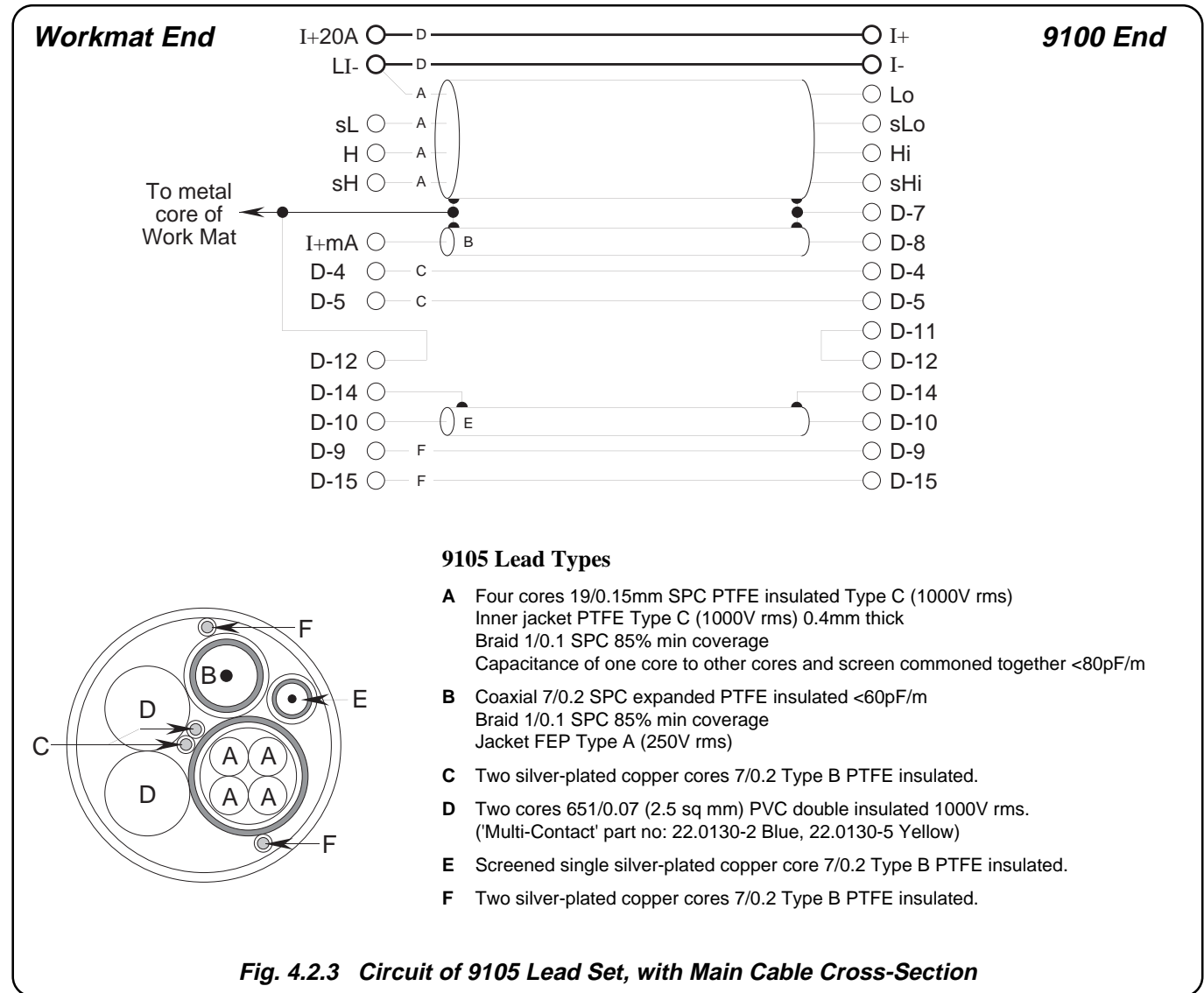

4.3 DC Voltage Function — Operation

4.3.1

This sub-section is a guide to the use of the 9100 for generating a required DC Voltage output. The following topics are covered:

- 4.3.2 Selection of DC Voltage Function.
 - 4.3.2.1 'V' Key.
 - 4.3.2.2 Default Settings.
- 4.3.3 Screen Keys.
 - 4.3.3.1 Bottom Screen Keys.
 - 4.3.3.2 Right Side Screen Keys.
 - 4.3.3.3 Introducing Deviation and Offset Values.
- 4.3.4 Value Editing.
 - 4.3.4.1 Output, Offset and Deviation.
- 4.3.5 Crossing Thresholds.
 - 4.3.5.1 Voltage Resolution Thresholds.
 - 4.3.5.2 Hardware Configurations.
 - 4.3.5.3 Low and High Voltage States.
 - 4.3.5.4 To Reconfigure High Voltage State Thresholds.
- 4.3.6 DC Voltage Routines for Calibrating UUTs.
 - 4.3.6.1 Interconnections
 - 4.3.6.2 Using the 9100 as a Fixed Source
 - 4.3.6.3 Using the 9100 as an Adjustable Source

Final Width = 215mm

In this sub-section, we deal with the full range of DCV facilities, in a concise way. For those who require more detailed instructions for manipulating the front panel controls, the DC Voltage function was used as an example for the general familiarization tutorials in *Section 3*, and this may provide an introduction to the function.

Final Width = 215mm

4.3.2 Selection of DC Voltage Function

(Manual Mode selected)

4.3.2.1 'V' Key

Voltage is selected by pressing the 'V' key at the top right of the 'CALIBRATION SYSTEM' panel.

4.3.2.2 Default Settings

At power-on and each time the 'V' key is pressed, the system defaults into DC Voltage function.

If AC Voltage is already active, then the DC Voltage menu screen is opened by pressing the  V screen key on the bottom row.

Whenever the DC Voltage menu screen is opened, except on recovery from a standby period, it will appear with the following default settings:

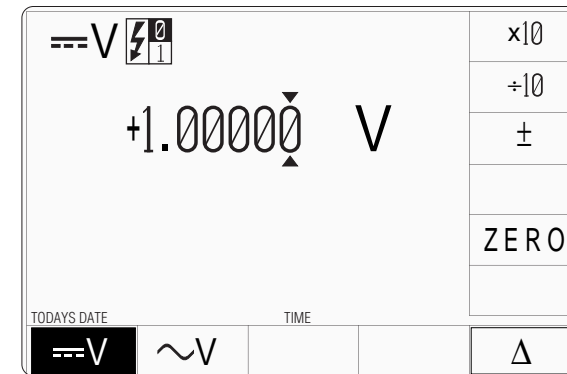

4.3.3 Screen Keys

4.3.3.1 Bottom Screen Keys

- $\text{==} \text{V}$ Selects DC Voltage Function when AC Voltage Function is active.
- $\sim \text{V}$ Selects AC Voltage Function when DC Voltage Function is active.
- Δ Accesses the 'Percentage Deviation' and 'DC Voltage Offset' displays to add to the screen presentation. *Refer to paras 4.3.3.3 and 4.3.4.1.*

4.3.3.2 Right Side Screen Keys

A. Digit Edit Facility Keys operate on the value marked by the cursor.

- $\times 10$ Multiplies the marked value by ten.
- $\div 10$ Divides the marked value by ten.
- \pm Reverses the polarity of the marked value.
- ZERO Sets the marked value to zero.

B. Direct Edit Facility Right side screen keys operate on the value in the edit box, and acting in place of the \leftarrow key, exit from Direct Edit back to Digit Edit; then set the value as evaluated in the box.

i. Output Value and Offset Value

- mV** Evaluates the number in the box in **Millivolts**.
- V** Evaluates the number in the box in **Volts**.
- kV** Evaluates the number in the box in **Kilovolts**.

ii. Deviation Value

- %** Evaluates the number in the box in **Percentage Deviation**.
The Deviation value is limited to $\pm 10\%$ of the Output value.

Output and Offset values are set into the same resolution. All values are set into the highest resolution available to their magnitude.

Final Width = 215mm

Final Width = 215mm

4.3.3 Screen Keys (Contd.)

4.3.3.3 Introducing Deviation and Offset Values

Pressing the ' Δ ' key (bottom row) presents a screen with $\Delta\%$ and ΔV labelling the two top right screen keys:

Pressing the ' $\Delta\%$ ' screen key adds the 'Percentage Deviation' value to the lower left of the display presentation and the screen reverts to the main DC Voltage display as shown below. The Deviation value is limited to $\pm 10\%$ of the Output value.

Pressing the ' ΔV ' screen key adds the 'DC Voltage Offset' value to the lower right of the display presentation and the screen reverts to the main DC Voltage display as shown below.

Note that as each of the ' Δ ' keys is pressed to show its value on the screen, the cursors will move to the latest selection.

The main DC Voltage display is shown here with both $\Delta\%$ and ΔV additions in place. This would require two separate operations of the Δ key on the bottom row, as after each selection, the screen reverts to the main display, the cursors following the new selection. After reversion, the cursors can be transferred to any of the displayed values for editing, here shown on the main output display. Otherwise, the operation of the editing keys is unchanged (paras 4.3.3.2), and direct editing can also be used

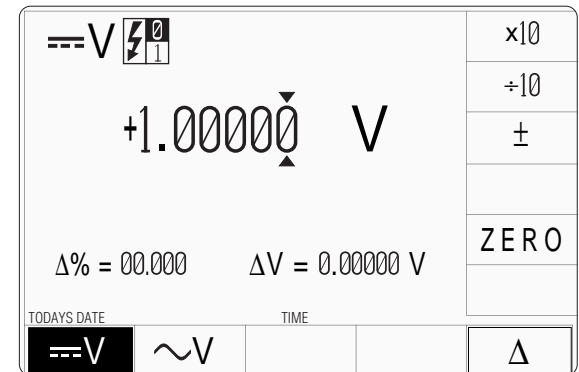
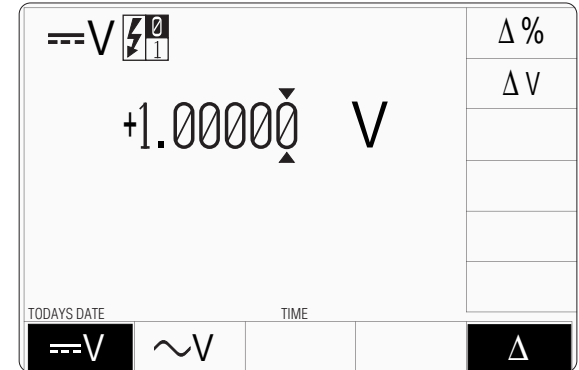

4.3.4 Value Editing

4.3.4.1 Output, Offset and Deviation

The Output, Offset and Deviation values can be changed using 'Digit' and 'Direct' edit facilities as described in *Section 3*.

Offset Values

The effect of introducing a non-zero offset value is to change all set values of the output by that of the offset. A positive offset will make the output value more positive, and a negative offset will make the output value more negative.

For example:

- a. A set Output Value of +10V with a +1V Offset will be output as +11V.
- b. A set Output Value of -40V with a +10V Offset will be output as -30V.
- c. A set Output Value of +100V with a -300V Offset will be output as -200V.

Deviation Percentage Values

The effect of introducing a non-zero deviation value is to change all set values of the output by the fraction expressed by the deviation. A positive deviation will increase, and a negative deviation will reduce, the output value.

For example:

- a. An Output Value of 10V set on the display, will be increased to 10.5V by a +5% Deviation.
- b. An Output Value of 50V set on the display, will be decreased to 45V by a -10% Deviation.

Combined Deviation Percentage and Offset

Deviation and Offset values are combined by first applying the deviation, then the offset, to the output value in the form $y = (1 + m/100)x + c$, where:

y is the terminal voltage; **x** is the set output voltage; **m** is the set deviation percentage; **c** is the set offset voltage.

For example:

- a. Set Values: Output = 10V; Deviation = +5%; Offset = +3V.
Terminal Voltage will be:
$$[(1 + 5/100) \times 10V] + (+3V) = [1.05 \times 10] + 3V = +13.5V$$
- b. Set Values: Output = +40V Deviation = -10% Offset = -50V.
Terminal Voltage will be:
$$[(1 - 10/100) \times 40V] + (-50V) = [0.9 \times 40] - 50V = -14V$$

Final Width = 215mm

Final Width = 215mm

4.3.5 Crossing Thresholds

4.3.5.1 Voltage Resolution Thresholds

The different resolutions are distinguished by two characteristics:

- Maximum and minimum values available.
- Absolute resolution of the least-significant digit.

The following table shows the spans of output values for the DC Voltage function, against their associated resolutions.

Absolute Resolution	Span of Values	Nominal Span Value
1 μ V	-320.000 mV to +320.000 mV	300mV
10 μ V	-3.20000 V to +3.20000 V	3V
100 μ V	-32.0000 V to +32.0000 V	30V
1mV	-320.000 V to +320.000 V	300V
10mV	-1050.00 V to +1050.00 V	1000V

Rules, built into firmware, govern passage across thresholds between resolutions:

Increasing Output or Offset Voltage

Using the \odot key in Digit Edit facility; an audible warning will be given if the new value is too large for the present span of values, with a reminder ('Up range required') on the screen. The user must change to the next lower resolution, with a larger span of values, using the \langle key. This rule applies whether OUTPUT is OFF or ON.

When using either the X10 screen key or the Direct Edit facility; if the new value is too large for the present resolution, a lower resolution will be activated with a larger span of values. No warning will be given. This rule applies whether OUTPUT is OFF or ON.

Decreasing Output or Offset Voltage

Using Digit Edit; values down to zero lie within all spans. If the required value lies between steps of the present resolution, the user must increase resolution using the \rangle key, also reducing the span of values. This rule applies whether OUTPUT is OFF or ON.

Using either the $\div 10$ screen key or Direct Editing; if the required value lies between increments of the present resolution, a greater resolution will be activated with reduced span. No warning will be given. This rule applies whether OUTPUT is OFF or ON.

4.3.5.2 Hardware Configurations

Voltage Changes

When increasing or decreasing output voltage, using any method: if the new voltage is too large or small for the present hardware configuration, then if OUTPUT is OFF there will be no noticeable effect as the hardware reconfigures.

If OUTPUT is ON, it will be temporarily turned OFF so that the hardware can reconfigure, then ON again at the new voltage. No warning is given. This interruption should cause little disturbance to the reading on any UUT.

4.3.5.3 Low and High Voltage States

In the interests of safety, to avoid electric shock, the 9100 incorporates a high-voltage interlock system for both DC and AC Voltage functions. The interlock threshold voltage can be chosen by the user. A default threshold value is set unless another is set by the user, and the active threshold value is stored in non-volatile memory.

The whole 9100 voltage range is divided into two: Low Voltage (LV) state and High Voltage (HV) state. Any voltage within LV state can be output without hindrance, but voltages greater than the defined limit of LV state cannot be output without the system being in HV state. Deliberate action has to be taken to enter HV state, and once entered, a continuous audible signal acts as a reminder that HV state is active.

The system exits from HV state when the output voltage is brought down below HV state's lower limit. This is always 10% less than the upper limit of LV state, allowing some adjustment of output without the irritation of having to change states.

Each threshold value is related to the value set on the screen, including any Offset or Deviation. The default state boundaries are shown in *Fig. 4.3.1*. The values given in the figure translate to DC volts in DCV function, and RMS volts in ACV function.

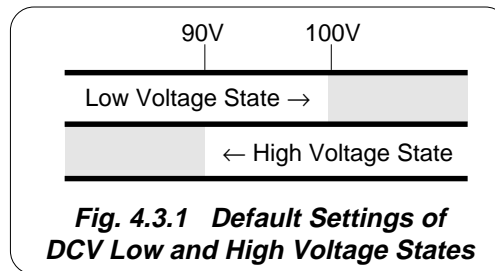

Final Width = 215mm

Continued Overleaf →

Final Width = 215mm

4.3.5.3 Low and High Voltage States *(Contd.)*

Transit Rules

Rules, built into firmware, govern transit across thresholds between the two states. The 'upper' threshold is active only when in LV state, whereas the 'lower' threshold operates only when in HV state, as indicated in the figure.

Within certain limits, these boundaries can be repositioned in 'Config.' Mode (see *paras 4.3.5.4*) by adjusting the upper threshold value. This also changes the lower threshold, which always remains at 90% of the upper threshold value, and cannot be altered independently.

Increasing Output Voltage into High Voltage State

When increasing output or offset value using any method; if the new value will be greater than the upper threshold and OUTPUT is OFF, HV state will be activated but no effect will be observed. If OUTPUT is ON, it will remain ON at its latest LV state value. The operator will be prompted, by audible warning and error message, to confirm that HV State is required. This is done by pressing the OUTPUT ON key again; then, after a short delay, the output voltage will be raised to the new voltage in HV state.

While OUTPUT is ON in HV state, a distinctive, pulsing tone is emitted. Once in HV state, OUTPUT can be turned ON and OFF with no need to confirm.

Decreasing Output Voltage out of High Voltage State

When decreasing output or offset value using any method; if the new value will be less than the lower limit of HV State, then the LV state will be activated. No warning will be given, except that the pulsing tone will cease. This rule applies whether OUTPUT is OFF or ON.

Indication of Potentially Dangerous Output Voltages

When Output is ON and the set output voltage (including deviation and/or offset elements) exceeds 32V, then the OUTPUT ON LED will flash (regardless of whether the voltage is in High or Low Voltage State) to show that a potentially-dangerous voltage exists at the terminals.

Passwords and Access

1. All Configuration mode selections, other than the viewing angle, require a password. When the 9100 is shipped from new, the password requirement is enabled to avoid unauthorized access.
2. *It is recommended that both passwords be changed, for security purposes, at the earliest opportunity.*
3. The shipment 'Configuration' password is **12321** (as typed on the front panel keypad when the Password Entry screen for Configuration mode is showing). It is stated here to allow entry to Configuration mode by personnel *authorized by local management*, and permit subsequent access to the means of altering the password itself. The necessary process is detailed in *Section 3 Paras 3.3.2.23 and 3.3.2.25*.

4.3.5.4 To Reconfigure High Voltage State Thresholds

N.B. A password will be required for access when changing thresholds.

The High Voltage State thresholds have default values as given in *Paras 4.3.5.3*. These values can be changed locally by entering a menu in Configuration Mode. When changing values, the following procedure should be used:

1. Press the **Mode** key on the right of the front panel to obtain the 'Mode Selection' menu screen

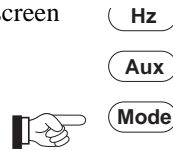

2. Press the **CONFIG** screen key at the center of the bottom row to progress into 'Configuration' mode. The 9100 will transfer to the open 'Configuration' menu screen

The present DC/RMS 'Safety Voltage' value is given in the list (default value shown).

3. 'VOLTAGE LIMIT' changes require a password. Press the **MORE** screen key on the right of the bottom row. The 9100 will transfer to the 'Password Entry' screen

4. When entering the password via the alpha-numeric keyboard, security icons appear on the screen as you type. Finally press the ↵ key.

If the password is incorrect: an error message will be given and the security icons will be removed, enabling a new attempt to enter the password.

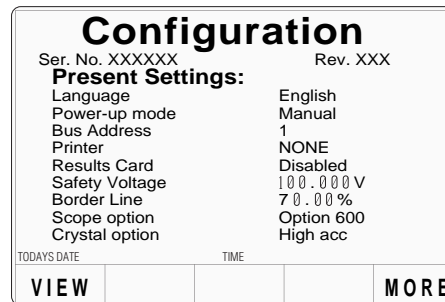
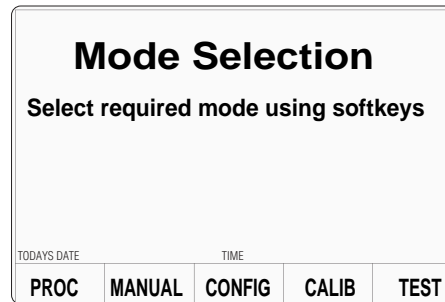



Final Width = 215mm

Continued Overleaf →

Final Width = 215mm

4.3.5.4 To Reconfigure High Voltage State Thresholds (Contd.)

5. The correct password, followed by ↵, will provide entry to the main 'Configuration' menu screen, showing the present setting of the 'Safety Voltage' (always the upper threshold value) 
6. To change the Safety Voltage, press the **VOLTAGE LIMIT** screen key at the left of the bottom row. This transfers to a configuration screen designed for changing the 'Voltage Limit'. In our representation, the default value is shown 
7. Use Digit edit or Direct edit to set the required high voltage warning limit (UPPER threshold). If using Direct edit, after typing the value press the ↵ key (or press the Direct edit 'V' screen key in the right-hand column).

The 'DEFAULT 100V' screen key can be used for a level of 100V.

Note: Out-of-Range Indication

The valid range of limit values is from 10V to 110V. When values outside this range are entered, a message will appear on the screen to indicate the permitted range, and the 'EXIT' screen key label will be replaced by 'OK'. By pressing 'OK' the original value is reinstated and the message disappears, for a second attempt.

Return to DC Voltage Function

8. Press the **EXIT** screen key to return to the 'Configuration' menu screen. The new high voltage threshold value appears on the 'Current Settings' list.
9. Press the **Mode** key at the right of the front panel to return to the 'Mode Selection' menu screen.
10. Press the **MANUAL** screen key to return to Manual mode and the DC Voltage function. The new value of High Voltage state threshold is now active.

Configuration				SELECT LANG
Ser. No. XXXXXX	Rev. XXX			POWER UP MODE
Present Settings:				BUS ADDRESS
Language	English			PRINTER
Power-up mode	Manual			RESULTS CARD
Bus Address	1			CLEAR USER LIST
Printer	NONE			
Results Card	Disabled			
Safety Voltage	100.000 V			
Border Line	70.00%			
Scope option	Option 600			
Crystal option	High acc			
TODAY'S DATE	TIME			
VOLTAGE LIMIT	DATE TIME	BORDER LINE		MORE

Configuration				DEFAULT 100V
The high voltage warning limit can be changed by using digit or direct editing.				
The maximum value is 110V				
Limit = 100.000 V				
TODAY'S DATE	TIME			
EXIT				

4.3.6 DC Voltage Routines for Calibrating UUTs

4.3.6.1 Interconnections

The general connection scheme for UUT calibration is illustrated in *Fig. 4.3.2*.

For UUTs without *safety* banana sockets, use appropriate adaptors.

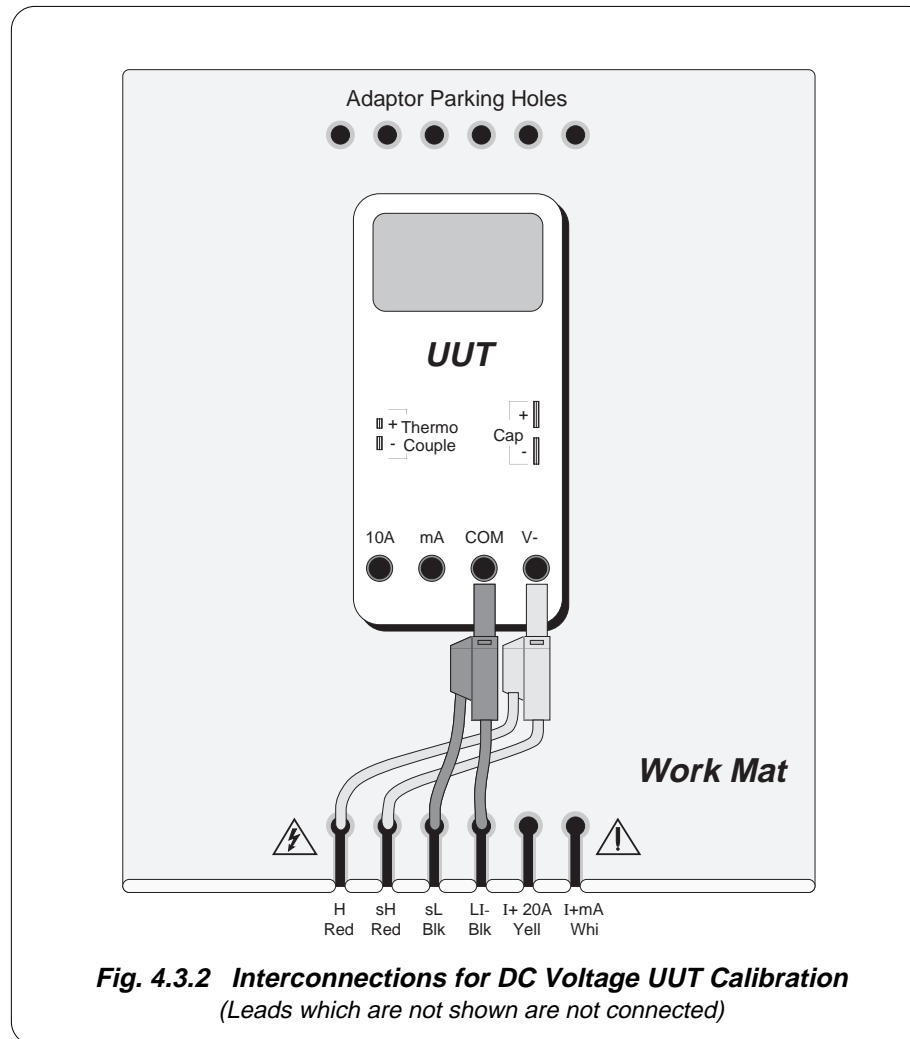

Final Width = 215mm

Final Width = 215mm

4.3.6.2 Using the 9100 as a Fixed Source

The following procedure assumes that the instrument is in Manual Mode. In the case of difficulty, re-read *Section 3; sub-section 3.3.1*. Familiarity with the methods of editing screen values is also assumed (*Section 3*).

9100 and UUT Setup

1. **Connections** Connect the 9100 to the UUT as shown in *Fig. 4.3.2*, and ensure that both instruments are powered ON and warmed up.
2. **UUT** Select DC Voltage function.
3. **9100** Ensure that the 9100 is in DC Voltage Function with Output OFF. If in any other function, press the 'V' key on the right of the front panel.

Sequence of Operations

Refer to the table or list of UUT calibration points in the *Manufacturer's Calibration Guide* for the UUT.

Follow the correct sequence of calibration stages as directed by the guide, and carry out the following operations (1) to (5) at each stage.

1. **9100** Use the front panel controls to set the 9100 Output voltage to the UUT cal point value, entering High Voltage State if the cal point has been assigned to that state. The default High Voltage State boundaries are shown in *Fig. 4.3.1*.
2. **UUT** Select the correct range for the cal point.
3. **9100**
 - a. Set Output **ON**.
 - b. Note the UUT reading.
4. **UUT**
 - a. If a UUT calibration adjustment is provided, adjust the UUT reading to be equal to that on the 9100 screen, as detailed in the *UUT Manufacturer's Calibration Guide*.
 - b. If no adjustment is provided on the UUT, record the UUT reading at the calibration point as detailed in the *UUT Manufacturer's Calibration Guide*.
5. **9100** Set Output **OFF**.

4.3.6.3 Using the 9100 as an Adjustable Source

The following procedure assumes that the instrument is in Manual Mode. In the case of difficulty, re-read *sub-section 3.3.1*. Familiarity with the methods of editing screen values is also assumed (*Section 3*).

Calibration Setup

1. **Connections** Connect the 9100 to the UUT as shown in *Fig. 4.3.2*, and ensure that both instruments are powered ON and warmed up.
2. **UUT** Select DC Voltage function.
3. **9100** Ensure that the 9100 is in DC Voltage Function with Output OFF. If in any other function, press the 'V' key on the right of the front panel.

Sequence of Operations

Refer to the table of UUT calibration points in the *UUT Manufacturer's Calibration Guide*. Follow the correct sequence of calibration stages as directed by the guide, and carry out the following operations (1) to (5) at each stage.

1. **9100** Use the front panel controls to set the 9100 Output voltage to the UUT cal point value, entering High Voltage State if the cal point has been assigned to that state. The default High Voltage State boundaries are shown in *Fig. 4.3.1*.
2. **UUT** Select the correct range for the cal point.
3. **9100**
 - a. Set Output **ON**.
 - b. Slew the DC Voltage Output reading until the UUT reading is equal to the calibration point value.
4. **UUT** Record the 9100 screen output value as detailed in the *UUT Manufacturer's Calibration Guide*.
5. **9100** Set Output **OFF**.

Final Width = 215mm

4.4 AC Voltage Function — Operation

4.4.1

This sub-section is a guide to the use of the 9100 for generating a required AC Voltage output. The following topics are covered:

- 4.4.2 Selection of AC Voltage Function.
 - 4.4.2.1 'V' Key.
 - 4.4.2.2 Default Settings.
- 4.4.3 Screen Keys.
 - 4.4.3.1 Bottom Screen Keys.
 - 4.4.3.2 Right Side Screen Keys.
 - 4.4.3.3 Introducing Deviation Values.
 - 4.4.3.4 Selecting Other Waveshapes.
 - 4.4.3.5 Phase-Locking Facilities.
- 4.4.4 Value Editing.
 - 4.4.4.1 Output and Deviation.
 - 4.4.4.2 Frequency Editing.
 - 4.4.4.3 'Out of Range'.
- 4.4.5 Crossing Thresholds.
 - 4.4.5.1 AC Voltage Resolution Thresholds.
 - 4.4.5.2 Frequency Resolution Thresholds.
 - 4.4.5.3 Hardware Configurations.
 - 4.4.5.4 Low and High Voltage States.
 - 4.4.5.5 To Reconfigure High Voltage State Thresholds.
- 4.4.6 Volt-Hertz Limits.
 - 4.4.6.1 Volt-Hertz Profile
- 4.4.7 AC Voltage Routines for Calibrating UUTs.
 - 4.4.7.1 Interconnections
 - 4.4.7.2 Using the 9100 as a Fixed Source
 - 4.4.7.3 Using the 9100 as an Adjustable Source

Final Width = 215mm

In this sub-section, we deal with the full range of ACV facilities, in a concise way. For those who require more detailed instructions for manipulating the front panel controls, the DC Voltage function was used as an example for the general familiarization tutorials in *Section 3*.

Final Width = 215mm

4.4.2 Selection of AC Voltage Function

(Manual Mode selected)

4.4.2.1 'V' Key

Voltage is selected by pressing the 'V' key at the top right of the 'CALIBRATION SYSTEM' panel.

4.4.2.2 Default Settings

At power-on and each time the 'V' key is pressed, the system defaults into DC Voltage function.

If DC Voltage is already active, then the AC Voltage menu screen is opened by pressing the $\sim V$ screen key on the bottom row.

Whenever the AC Voltage menu screen is opened, except on recovery from a standby period, it will appear with the following default settings:

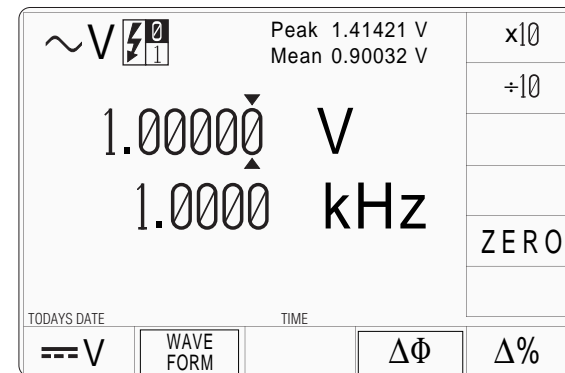

4.4.3 Screen Keys

4.4.3.1 Bottom Screen Keys

- == V** Selects DC Voltage Function when AC Voltage Function is active.
- ~ V** Selects AC Voltage Function when DC Voltage Function is active.
- Δ%** Adds the 'AC Voltage Deviation' value to the display presentation.
Refer to paras 4.4.3.3.
- WAVE FORM** Gives access to change the waveshape of the output voltage.
Refer to paras 4.4.3.4.
- ΔΦ** Gives access to the phase-locking facility.
Refer to paras 4.4.3.5.

4.4.3.2 Right Side Screen Keys

A. Digit Edit Facility Keys operate on the value marked by the cursor.

- X10** Multiplies the marked value by ten.
- ÷10** Divides the marked value by ten.
- ±** Reverses the polarity of the marked value. The ± key is only available when the cursor is marking the Deviation value
- ZERO** Sets the marked value to zero. ZERO is available only when the cursor is marking the Output value.

B. Direct Edit Facility Right side screen keys operate on the value in the edit box, and acting in place of the ↵ key, exit from Direct Edit back to Digit Edit; then set the value as evaluated in the box.

i. Output Value

- mV** Evaluates the number in the box in **Millivolts**.
- V** Evaluates the number in the box in **Volts**.
- kV** Evaluates the number in the box in **Kilovolts**.

ii. Frequency

- Hz** Evaluates the number in the box in **Hertz**.
- kHz** Evaluates the number in the box in **Kilohertz**.

iii. Deviation Value

- %** Evaluates the number in the box in **Percentage Deviation**.
The Deviation value is limited to ±10% of the Output value.

All values are set into the highest resolution available to their magnitude.

Final Width = 215mm

4.4.3 Screen Keys (Contd.)

4.4.3.3 Introducing Deviation Values

Pressing the ' $\Delta\%$ ' screen key adds the 'Percentage Deviation' value to the lower left of the display presentation. The Deviation value is limited to $\pm 10\%$ of the Output value.

Note that as the ' $\Delta\%$ ' key is pressed to show its value on the screen, the cursors will move to the added value.

The AC Voltage display is shown here with the $\Delta\%$ addition in place, but with the cursors transferred to the main output value for digit editing as described in Section 3. Otherwise, the operation of the editing keys is unchanged (*paras 4.4.3.2*), and direct editing can also be used.

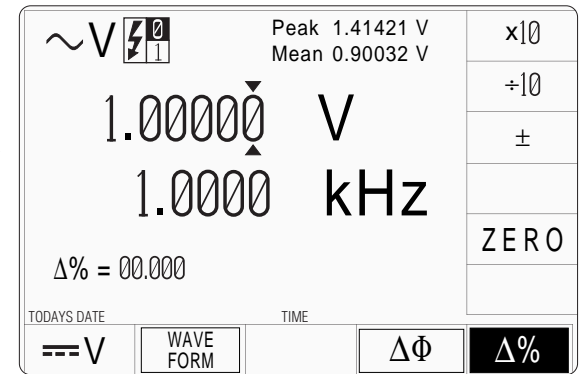

Final Width = 215mm

4.4.3.4 Selecting Other Waveshapes

Pressing the 'WAVE FORM' key (bottom row) presents a screen with five waveshapes shown against the right screen keys:

Pressing the appropriate 'waveshape' screen key (e.g. 'square') sets the internal parameters to create the selected waveform.

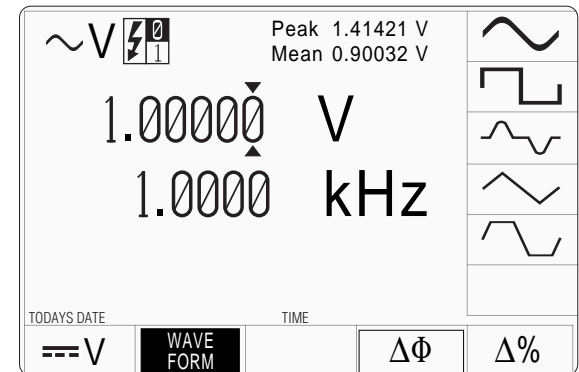

The screen reverts to the main AC Voltage display, but with the selected waveform identifier ('square' shown) transferred to the top left corner:

The operation of the editing keys is unchanged (*paras 4.4.3.2*).

The five waveshapes are shown below, in their relative phase positions (although, of course, only one waveshape can exist at a time).

A frequency limit of 1kHz is placed on all outputs with non-sinusoidal waveshapes. Each waveshape's form factor results in its own mean/RMS and peak/RMS ratio, so for the same RMS output value, the peak and mean readings at the top of the screen will change between waveforms.

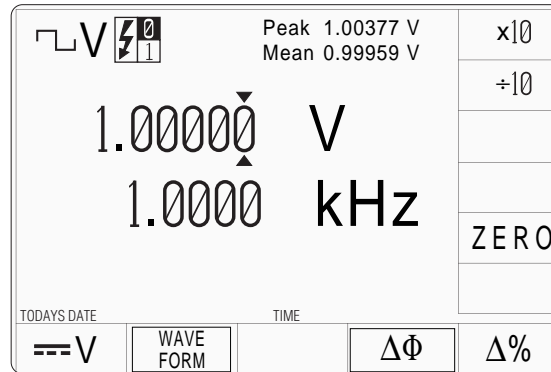

Final Width = 215mm

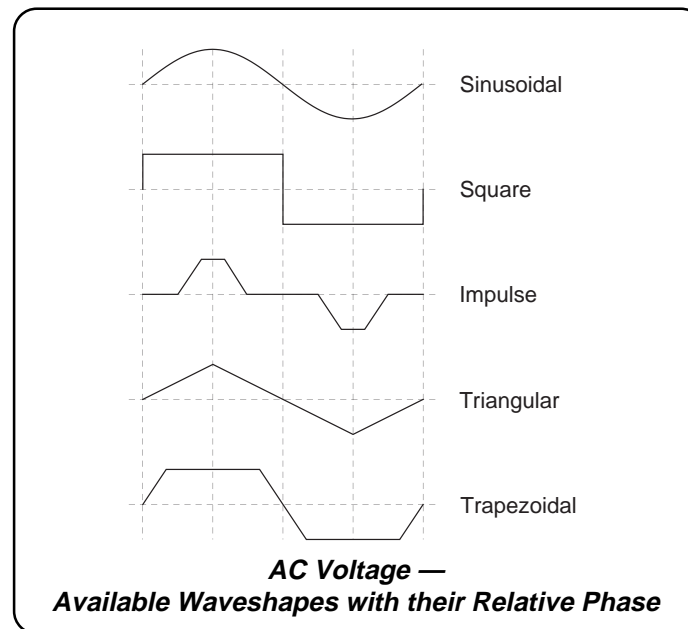

4.4.3.5 Phase-Locking Facilities

Access:

Pressing the ' $\Delta\Phi$ ' key (bottom row) presents a screen with alternative roles shown against the two top right screen keys:

Phase Lock Role:

(Refer also to the illustration of the rear panel in Section 2, sub-section 2.7.)

Pressing the right-side ' $\Delta\Phi$ ' screen key permits the unit's output to be phase-locked to a received external synchronizing signal of the same frequency ('PHASE LOCK IN' on the rear panel). The phase of the 9100 output, relative to the synchronization point, can be altered over a range of $\pm 180^\circ$.

After the ' $\Delta\Phi$ ' key is pressed, the screen reverts to the main AC Voltage display, but with the addition of a ' $\Delta\phi$ ' field, used to alter the phase-shift of the output relative to the received external reference.

The cursors can be transferred to the $\Delta\phi$ field in *Digit Edit* to edit the value. *Direct Edit* can also be used as described in Section 3.

Reference Output Role:

Pressing the 'REF OUTPUT' screen key produces a synchronizing TTL signal at 'PHASE LOCK OUT' on the rear panel, in the same phase as the 'PHASE LOCK IN' input. This can be transmitted as a reference signal for phase-locking the outputs of up to five other 9100 units.

Combined Use

The 9100 can be used in both roles simultaneously: producing a reference output signal in phase with the 'PHASE LOCK IN' input from a master reference, while generating its own synchronized output signals. However, a 'fan-out' system is preferred, with one 'Master' unit providing the reference for up to five other 'Slaves'.

The Phase-Locking Facility Applies to All Waveforms

Phase-locking is not dependent on the type of waveform, but on underlying timing, and so applies to all output waveforms illustrated in the figure opposite.

Type of Reference Signal Input

When being phase-locked to an external signal, the *synchronization point* is the *negative-going* edge of the synchronizing signal (negative-going zero-crossing in the case of a sinewave reference signal). To this is added the $\Delta\phi$ phase-shift value registered on the screen, determining the phase of the *positive-going* crossover of the output AC Voltage relative to the *synchronization point*. This inversion means that with a request for 0° shift, the output signal appears to lag by 180° on the synchronizing signal phase.

Relative Phase-Shift Magnitude and Direction

The zero phase-shift point is taken as the *synchronization point* illustrated opposite. On the screen, at values other than zero, the direction of phase shift $\Delta\phi$ is indicated by a '+' sign if the output is advanced on the reference input, and a '-' sign if the output is delayed. $\Delta\phi$ is resolved in steps of 0.01° as shown on the screen, at any value in the range -180° to $+180^\circ$.

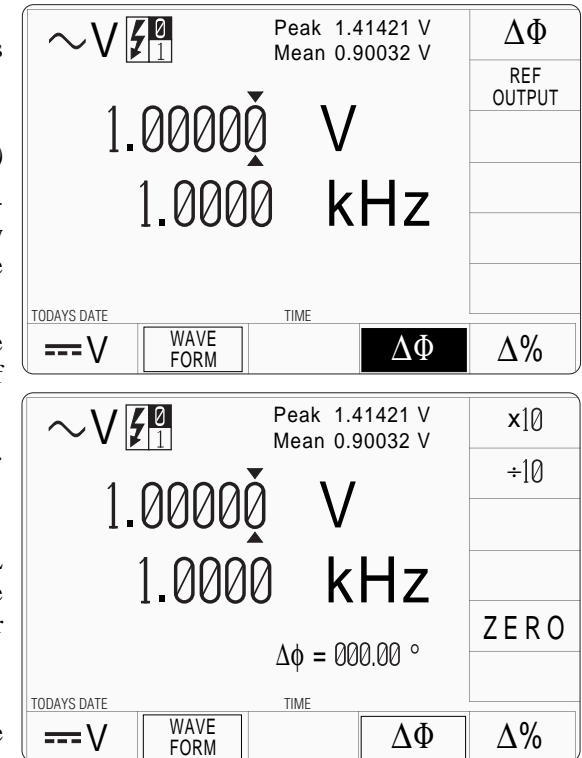

Final Width = 215mm

Reference Signal Output

The reference signal produced by a 9100 is a wide pulse, compatible with TTL, between the levels +0.5V and +4.5V, with its negative-going edge coincident with the *synchronization points*. (i.e. in phase with the 'PHASE LOCK IN' input, when applied).

4.4.3.6 Conditions for Operation

Same Frequency

For any two 9100 units (Master and Slave), both *must be set to the same frequency* of 1kHz or lower, *before* the output of the Driven unit is turned on.

Good Practice

In general, a slave unit will be well-behaved if the synchronizing pulse is interrupted. However, as the voltage increases above a few hundred volts, and the frequency decreases below 100Hz, synch. pulse interruptions or shifts may cause transients which result in operation of the protection circuitry in the slave unit, automatically turning its output off.

To avoid this, if one unit *must* be run at HVAC and LF, it should be assigned as Master unit if at all possible (e.g. in a system where one unit outputs 250V AC at 60Hz, and another outputs 10A at 60Hz, then the latter should be assigned to the slave role). If units *must* be run as slaves at HVAC and LF (such as in a six-unit 3-phase system), observe the precautions described in the following paragraphs.

Change of Function — Reference 9100 Unit

If the Reference unit's function is changed from ACV, its reference output will go low. This will cause the Driven unit to unlock and free-run, being most unlikely to remain in phase with the Reference unit. External control will be re-established when the Reference unit is returned to ACV function (or placed in ACI function). At this time the Driven unit's phase will be switched rapidly, creating transient disturbances in the output AC voltage unless it is switched off. The Driven unit's output must therefore *be turned OFF* before the reference unit is returned to any AC function, (ACV or ACI).

Disconnection of Reference Cable

Disconnection of the cable from the Reference input ('PHASE LOCK IN' on the rear panel) will also cause the Driven unit to free-run, with resultant phase-shift of its output and possible transients when reconnected. Again, the Driven unit's output *must be turned OFF* before the cable is reconnected.

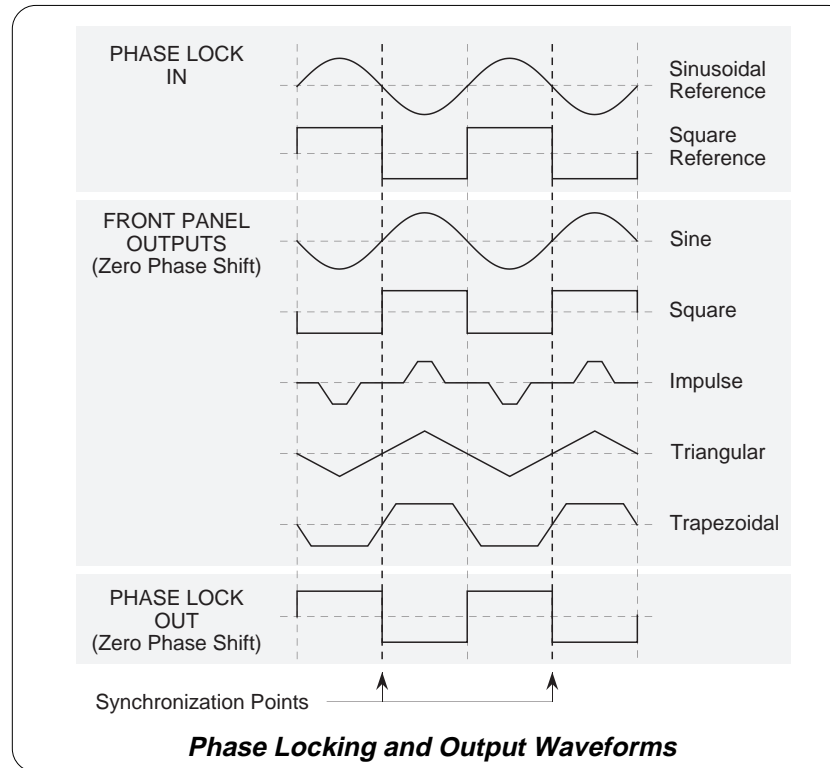

Final Width = 215mm

Help Available!

Section 3 Editing Tutorials page 3-6.

Final Width = 215mm

4.4.4 Value Editing**4.4.4.1 Output and Deviation**

Output, Frequency, Deviation and Phase-Shift values can be changed using 'Digit' and 'Direct' edit facilities as described in *Section 3*.

Deviation Percentage Values

The effect of introducing a non-zero deviation value is to change all set RMS values of the output by the fraction expressed by the deviation. A positive deviation will increase, and a negative deviation will reduce, the output RMS value.

For example:

- a. An Output Value of 10V RMS set on the display, will be increased to 10.5V RMS by a +5% Deviation.
- b. An Output Value of 50V RMS set on the display, will be decreased to 45V RMS by a -10% Deviation.

4.4.4.2 Frequency Editing

Frequency values can be changed using 'Digit' and 'Direct' edit facilities. The editing processes are not described in *Section 3*, but follow the same general rules as for editing voltages.

The resolution of frequency values is set at six significant digits, leading to four frequency spans of constant resolution.

The thresholds between resolutions of frequency are given in *paras 4.4.5.2*.

Hardware configurations for frequency change are given in *paras 4.4.5.3*.

4.4.4.3 'Out of Range'

Any attempt to select a combination of voltage and frequency (including the application of deviations and/or offsets) outside the constraints of the Volt-Hertz profile will not be enabled.

An audible warning will be given, accompanied by the screen message: '**Out of range**'.

Refer to *Sub-section 4.4.6*.

4.4.5 Crossing Thresholds

4.4.5.1 AC Voltage Resolution Thresholds

The different voltage resolutions are distinguished by two characteristics:

- Maximum and minimum values available.
- Absolute resolution of the least-significant digit.

The following table shows the spans of output values in the AC Voltage function, for 'sinusoidal' waveshape only, against their associated resolutions:

Absolute Resolution	Span of Values	Nominal Span Value
1 μ V	000.000 mV to 320.000 mV	300mV
10 μ V	0.00000 V to 3.20000 V	3V
100 μ V	00.0000 V to 32.0000 V	30V
1mV	000.000 V to 320.000 V	300V
10mV	0000.00 V to 1050.00 V	1000V

Rules, built into firmware, govern passage across thresholds between resolutions:

Increasing Output Voltage

Using the \odot key in Digit Edit facility; an audible warning will be given if the new value is too large for the present span of values, with a reminder ('Up range required') on the screen. The user must change to the next lower resolution, with a larger span of values, using the \langle key. This rule applies whether OUTPUT is OFF or ON.

When using either the X10 screen key or the Direct Edit facility; if the new value is too large for the present resolution, a lower resolution will be activated with a larger span of values. No warning will be given. This rule applies whether OUTPUT is OFF or ON.

Decreasing Output Voltage

Using Digit Edit; values down to zero lie within all spans. An attempt to set a negative value will not be enabled, and an audible warning will be given, accompanied by a reminder ('Minimum value') on the screen. If the required value lies between steps of the present resolution, the user must increase resolution using the \odot key, also reducing the span of values. This rule applies whether OUTPUT is OFF or ON.

Using either the $\div 10$ screen key or Direct Editing; if the required value lies between increments of the present resolution, a greater resolution will be activated with reduced span. No warning will be given. This rule applies whether OUTPUT is OFF or ON.

'Out of Range'

Refer to *Sub-Section 4.4.6*.

Final Width = 215mm

Final Width = 215mm

4.4.5.2 Frequency Resolution Thresholds



The different frequency resolutions are distinguished by two characteristics:

- Lowest and highest frequencies available.
- Absolute resolution of the least-significant digit.

The following table shows the spans of output frequencies in the AC Voltage function, for 'sinusoidal' waveshape only, against their associated resolutions. Non-sinusoidal waveshapes are limited to frequencies up to 1kHz.

Absolute Resolution	Span of Frequencies	Nominal Frequency
1mHz	010.000 Hz to 320.000 Hz	300Hz
10mHz	0.01000 kHz to 3.20000 kHz	3kHz
100mHz	00.0100 kHz to 32.0000 kHz	30kHz
1Hz	000.010 kHz to 100.000 kHz	100kHz

Increasing Frequency

Using the  key in Digit Edit facility; an audible warning will be given if the new value is too large for the present span of frequencies, with a reminder ('Up range required') on the screen. The user must change to the next lower resolution, with a larger span of frequencies, using the  key. This rule applies whether OUTPUT is OFF or ON.

When using either the X10 screen key or the Direct Edit facility; if the new frequency is too large for the present resolution, a lower resolution will be activated with a larger span of frequencies. No warning will be given. This rule applies whether OUTPUT is OFF or ON.

Decreasing Frequency

Using Digit Edit for values up to 105V; frequencies down to 10Hz lie within all voltage spans. Any attempt to set a frequency below 10Hz for these voltages will not be enabled, and an audible warning will be given, accompanied by a reminder ('Minimum value') on the screen.

If the required frequency lies between steps of the present frequency resolution, then the user must increase resolution using the  key (this also reduces the span of frequencies). This rule applies whether OUTPUT is OFF or ON.

Using either the +10 screen key or Direct Editing; if the required frequency lies between increments of the present resolution, a greater resolution will be activated with reduced span. No warning will be given. This rule applies whether OUTPUT is OFF or ON.

'Out of Range'

Refer to *Sub-Section 4.4.6*.

4.4.5.3 Hardware Configurations

Voltage or Frequency Changes

When increasing or decreasing output voltage or frequency, using any method: if the new voltage or frequency is too large or small for the present hardware configuration, then if OUTPUT is OFF there will be no noticeable effect as the hardware reconfigures.

If OUTPUT is ON, it will be temporarily turned OFF so that the hardware can reconfigure, then ON again at the new voltage. No warning is given. This interruption should cause little disturbance to the reading on any UUT.

4.4.5.4 Low and High Voltage States

In the interests of safety, to avoid electric shock, the 9100 incorporates a high-voltage interlock system for both DC and AC Voltage functions. The interlock threshold voltage can be chosen by the user. A default threshold value is set unless another is set by the user, and the active threshold value is stored in non-volatile memory.

The whole 9100 voltage range is divided into two: Low Voltage (LV) state and High Voltage (HV) state. Any voltage within LV state can be output without hindrance, but voltages greater than the defined limit of LV state cannot be output without the system being in HV state. Deliberate action has to be taken to enter HV state, and once entered, a continuing audible pulse acts as a reminder that HV state is active.

The system exits from HV state when the output voltage is brought down below HV state's lower limit. This is always 10% less than the upper limit of LV state, allowing some adjustment of output without the irritation of having to change states.

Each threshold value is related to the value set on the screen, including any Deviation. The default state boundaries are shown in *Fig. 4.4.1*. The values given in the figure translate to DC volts in DCV function, and RMS volts in ACV function.

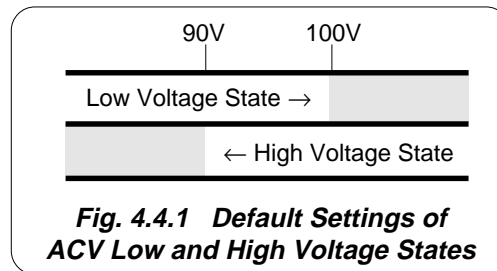

Fig. 4.4.1 Default Settings of ACV Low and High Voltage States

Final Width = 215mm

Continued Overleaf →

Final Width = 215mm

4.4.5.4 Low and High Voltage States *(Contd.)*

Transit Rules

Rules, built into firmware, govern transit across thresholds between the two states. The 'upper' threshold is active only when in LV state, whereas the 'lower' threshold operates only when in HV state, as indicated in the figure.

Within certain limits, these boundaries can be repositioned in 'Config.' Mode (see *paras 4.4.5.5*) by adjusting the upper threshold value. This also changes the lower threshold, which always remains at 90% of the upper threshold value, and cannot be altered independently.

Increasing Output Voltage into High Voltage State

When increasing output value using any method; if the new value will be greater than the upper threshold and OUTPUT is OFF, HV state will be activated but no effect will be observed. If OUTPUT is ON, it will remain ON at its latest LV state value. The operator will be prompted, by audible warning and error message, to confirm that HV State is required. This is done by pressing the OUTPUT ON key again; then, after a short delay, the output voltage will be raised to the new voltage in HV state.

While OUTPUT is ON in HV state, a distinctive, pulsing tone is emitted. Once in HV state, OUTPUT can be turned ON and OFF with no need to confirm.

Decreasing Output Voltage out of High Voltage State

When decreasing output value using any method; if the new value will be less than the lower limit of HV State, then the LV state will be activated. No warning will be given, except that the pulsing tone will cease. This rule applies whether OUTPUT is OFF or ON.

Indication of Potentially Dangerous Output Voltages

When Output is ON and the set output voltage (including a deviation element) exceeds 32V, then the OUTPUT ON LED will flash (regardless of whether the voltage is in High or Low Voltage State) to show that a potentially-dangerous voltage exists at the terminals.

Passwords and Access

1. All Configuration mode selections, other than the viewing angle, require a password. When the 9100 is shipped from new, the password requirement is enabled to avoid unauthorized access.
2. *It is recommended that both passwords be changed, for security purposes, at the earliest opportunity.*
3. The shipment 'Configuration' password is **12321** (as typed on the front panel keypad when the Password Entry screen for Configuration mode is showing). It is stated here to allow entry to Configuration mode by personnel *authorized by local management*, and permit subsequent access to the means of altering the password itself. The necessary process is detailed in *Section 3 Paras 3.3.2.23 and 3.3.2.25.*

4.4.5.5 To Reconfigure High Voltage State Thresholds

N.B. A password will be required for access when changing thresholds.

The High Voltage State thresholds have default values as given in *Paras 4.4.5.4.* These values can be changed locally by entering a menu in Configuration Mode. When changing values, the following procedure should be used:

1. Press the **Mode** key on the right of the front panel to obtain the 'Mode Selection' menu screen

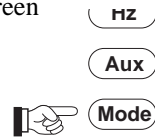

2. Press the **CONFIG** screen key at the center of the bottom row to progress into 'Configuration' mode. The 9100 will transfer to the open 'Configuration' menu screen

The present DC/RMS 'Safety Voltage' value is given in the list (default value shown).

3. 'VOLTAGE LIMIT' changes require a password. Press the **MORE** screen key on the right of the bottom row. The 9100 will transfer to the 'Password Entry' screen

4. When entering the password via the alpha-numeric keyboard, security icons appear on the screen as you type. Finally press the ↵ key.

If the password is incorrect: an error message will be given and the security icons will be removed, enabling a new attempt to enter the password.

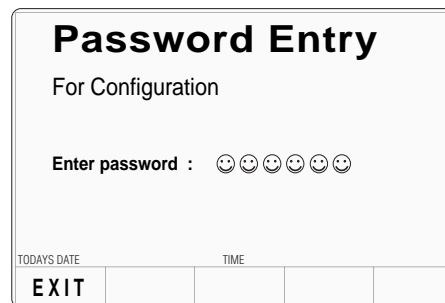
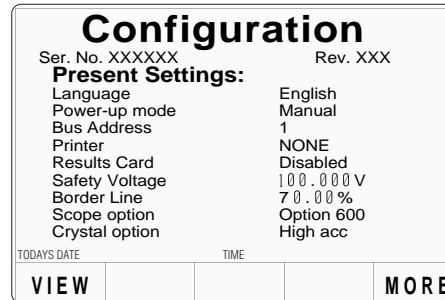
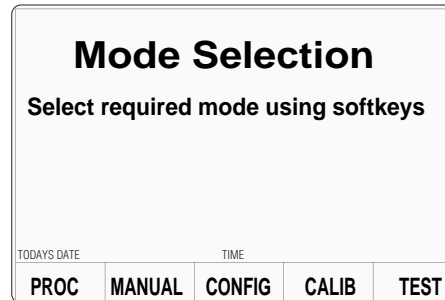



Final Width = 215mm

Continued Overleaf →

Final Width = 215mm

4.4.5.5 To Reconfigure High Voltage State Thresholds (Contd.)

5. The correct password, followed by ↵, will provide entry to the main 'Configuration' menu screen, showing the present setting of the 'Safety Voltage' (always the upper threshold value) 
6. To change the Safety Voltage, press the **VOLTAGE LIMIT** screen key at the left of the bottom row. This transfers to a configuration screen designed for changing the 'Voltage Limit'. In our representation, the default value is shown 
7. Use Digit edit or Direct edit to set the required high voltage warning limit (UPPER threshold). If using Direct edit, after typing the value press the ↵ key (or press the Direct edit 'V' screen key in the right-hand column).

The 'DEFAULT 100V' screen key can be used for a level of 100V.

Configuration				SELECT LANG
Ser. No. XXXXXX	Rev. XXX			POWER UP MODE
Present Settings:				BUS ADDRESS
Language	English			PRINTER
Power-up mode	Manual			RESULTS CARD
Bus Address	1			CLEAR USER LIST
Printer	NONE			
Results Card	Disabled			
Safety Voltage	100.000 V			
Border Line	70.00%			
Scope option	Option 600			
Crystal option	High acc			
TODAY'S DATE	TIME			
VOLTAGE LIMIT	DATE TIME	BORDER LINE		MORE

Configuration				DEFAULT 100V
The high voltage warning limit can be changed by using digit or direct editing.				
The maximum value is 110V				
Limit = 100.000 V				
TODAY'S DATE	TIME			
EXIT				

Note: Out-of-Range Indication

The valid range of limit values is from 10V to 110V. When values outside this range are entered, a message will appear on the screen to indicate the permitted range, and the 'EXIT' screen key label will be replaced by 'OK'. By pressing 'OK' the original value is reinstated and the message disappears, for a second attempt.

Return to AC Voltage Function

8. Press the **EXIT** screen key to return to the 'Configuration' menu screen. The new high voltage threshold value appears on the 'Current Settings' list.
9. Press the **Mode** key at the right of the front panel to return to the 'Mode Selection' menu screen.
10. Press the **MANUAL** screen key to return to Manual mode and the DC Voltage function.
11. Press the **~V** screen key to return to AC Voltage function. The new value of High Voltage state threshold is now active.

4.4.6 Volt-Hertz Limits

4.4.6.1 Volt-Hertz Profile (Sinusoidal Waveshape)

The combination of voltage and frequency of the sinewave output signal is enabled only within the Volt-Hertz product envelope shown in *Fig. 4.4.2*.

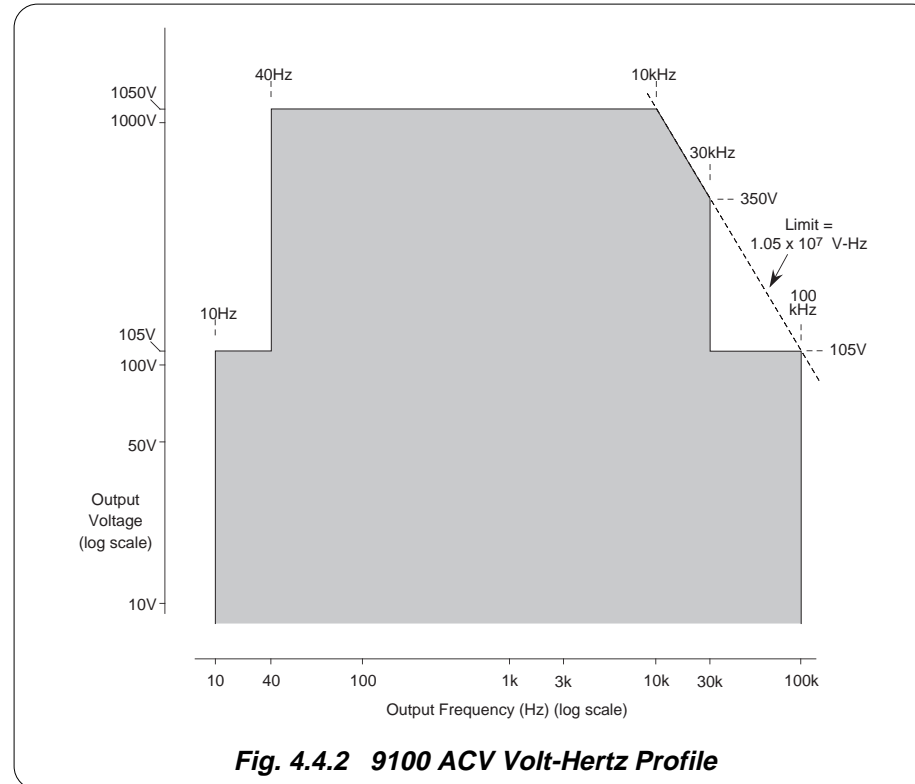

Any attempt to select a combination of voltage and frequency (including the application of deviation) outside these constraints will not be enabled. An audible warning will be given, accompanied by the screen message: **'Out of range'**.

If the abortive attempt involves the use of Direct Editing, then a further message **'Error!'** will be placed into the active editing box.

The other four waveshapes (*see paras 4.4.3.4*) have different limits:

1kHz maximum up to 150V peak (nominal);

45Hz-55Hz above 150V peak (nominal).

Final Width = 215mm

Final Width = 215mm

4.4.7 AC Voltage Routines for Calibrating UUTs

4.4.7.1 Interconnections

The general connection scheme for UUT calibration of AC Voltage Functions is illustrated in Fig. 4.4.3.

For UUTs without *safety* banana sockets, use appropriate adaptors.

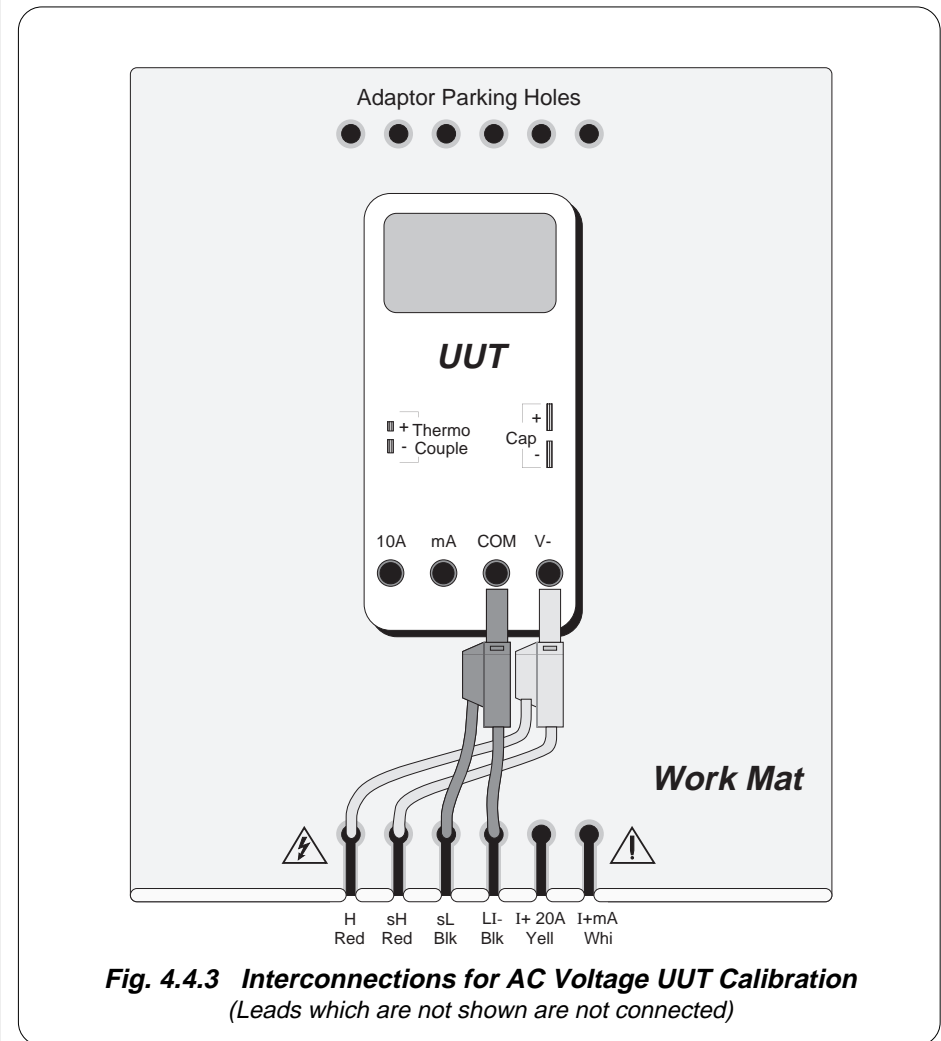

4.4.7.2 Using the 9100 as a Fixed Source

The following procedure assumes that the instrument is in Manual Mode. In the case of difficulty, re-read *Section 3; sub-section 3.3.1*. Familiarity with the methods of editing screen values is also assumed (*Section 3*).

9100 and UUT Setup

1. **Connections** Connect the 9100 to the UUT as shown in *Fig. 4.4.3*, and ensure that both instruments are powered ON and warmed up.
2. **UUT** Select AC Voltage function.
3. **9100** Ensure that the 9100 is in AC Voltage Function with Output OFF. If in any other function, press the 'V' key on the right of the front panel, then press the \sim V screen key.

Sequence of Operations

Refer to the table or list of UUT calibration points in the *UUT Manufacturer's Calibration Guide*.

Follow the correct sequence of calibration stages as directed by the guide, and carry out the following operations (1) to (5) at each stage.

1. **9100**
 - a. Use the front panel controls to set the 9100 Output to the UUT cal point frequency and voltage, entering High Voltage State if the cal point has been assigned to that state. The default High Voltage State boundaries are shown in *Fig. 4.4.1*.
 - b. Select the required waveform and phase-shift.
2. **UUT** Select the correct range for the cal point.
3. **9100**
 - a. Set Output **ON**.
 - b. Note the UUT reading.
4. **UUT**
 - a. If a UUT calibration adjustment is provided, adjust the UUT reading to be equal to that on the 9100 screen, as detailed in the *UUT Manufacturer's Calibration Guide*.
 - b. If no adjustment is provided on the UUT, record the UUT reading at the calibration point as detailed in the *UUT Manufacturer's Calibration Guide*.
5. **9100** Set Output **OFF**.

Final Width = 215mm

Final Width = 215mm

4.4.7.3 Using the 9100 as an Adjustable Source

The following procedure assumes that the instrument is in Manual Mode. In the case of difficulty, re-read *sub-section 3.3.1*. Familiarity with the methods of editing screen values is also assumed (*Section 3*).

Calibration Setup

1. **Connections** Connect the 9100 to the UUT as shown in *Fig. 4.4.3*, and ensure that both instruments are powered ON and warmed up.
2. **UUT** Select AC Voltage function.
3. **9100** Ensure that the 9100 is in AC Voltage Function with Output OFF. If in any other function, press the 'V' key on the right of the front panel, then press the \sim V screen key.

Sequence of Operations

Refer to the table of UUT calibration points in the *UUT Manufacturer's Calibration Guide*. Follow the correct sequence of calibration stages as directed by the guide, and carry out the following operations (1) to (5) at each stage.

1. **9100**
 - a. Use the front panel controls to set the 9100 Output to the UUT cal point frequency and voltage, entering High Voltage State if the cal point has been assigned to that state. The default High Voltage State boundaries are shown in *Fig. 4.4.1*.
 - b. Select the required waveform and phase-shift.
2. **UUT** Select the correct range for the cal point.
3. **9100**
 - a. Set Output **ON**.
 - b. Slew the AC Voltage Output reading until the UUT reading is equal to the calibration point value.
4. **UUT** Record the 9100 screen output value as detailed in the *UUT Manufacturer's Calibration Guide*.
5. **9100** Set Output **OFF**.

4.5 DC Current Function — Operation

4.5.1

This sub-section is a guide to the use of the 9100 for generating a required DC Current output. The following topics are covered:

- 4.5.2 Selection of DC Current Function.
 - 4.5.2.1 'A' Key.
 - 4.5.2.2 Default Settings.
- 4.5.3 Screen Keys.
 - 4.5.3.1 Bottom Screen Keys.
 - 4.5.3.2 Right Side Screen Keys.
 - 4.5.3.3 Introducing Deviation and Offset Values.
- 4.5.4 Value Editing.
 - 4.5.4.1 Output, Offset and Deviation.
- 4.5.5 Crossing Thresholds.
 - 4.5.5.1 Current Resolution Thresholds.
 - 4.5.5.2 Hardware Configurations.
- 4.5.6 Select Output
 - 4.5.6.1 Normal Output.
 - 4.5.6.2 Auxiliary Output.
 - 4.5.6.3 Option 200: 10- and 50-Turn Current Coils.
 - 4.5.6.4 10-Turn Coil.
 - 4.5.6.5 50-Turn Coil.
- 4.5.7 DC Current Routines for Calibrating UUTs.
 - 4.5.7.1 Interconnections
 - 4.5.7.2 Using the 9100 as a Fixed Source
 - 4.5.7.3 Using the 9100 as an Adjustable Source

Final Width = 215mm

In this sub-section, we deal with the full range of DCI facilities, in a concise way. For those who require more detailed instructions for manipulating the front panel controls, the DC Voltage function was used as an example for the general familiarization tutorials in *Section 3*, and this may provide an introduction to the function.

Final Width = 215mm

4.5.2 Selection of DC Current Function

(Manual Mode selected)

4.5.2.1 'A' Key

Current is selected by pressing the 'A' key at the right of the 'CALIBRATION SYSTEM' panel.

4.5.2.2 Default Settings

At power-on the system defaults to DC Voltage function. Each time the 'A' key is pressed, the system defaults into DC Current function.

If AC Current is already active, then the DC Current menu screen is opened by pressing the **==A** screen key on the bottom row.

Whenever the DC Current menu screen is opened, except on recovery from a standby period, it will appear with the following default settings:

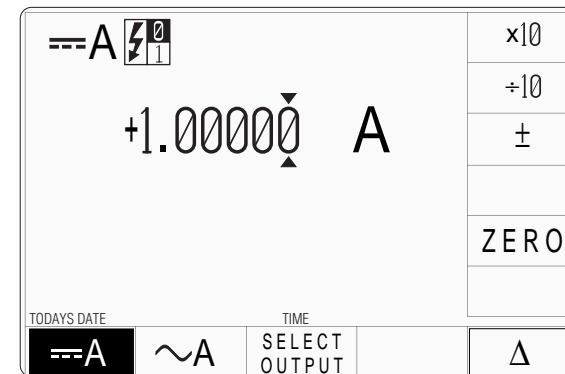

4.5.3 Screen Keys

4.5.3.1 Bottom Screen Keys

- ≡ A** Selects DC Current Function when AC Current Function is active.
- ~ A** Selects AC Current Function when DC Current Function is active.
- SELECT OUTPUT** Permits Connection of output currents up to 1A, via the guarded 'D-type' socket, instead of the main terminals, on the front panel. Also Permits Connection of output currents via the 10- and 50-turn coils (Option 200). *Refer to paras 4.5.6.*
- Δ** Accesses the 'Percentage Deviation' and 'DC Current Offset' displays to add to the screen presentation. *Refer to paras 4.5.3.3 and 4.5.4.1.*

4.5.3.2 Right Side Screen Keys

A. Digit Edit Facility Keys operate on the value marked by the cursor.

- ×10** Multiplies the marked value by ten.
- ÷10** Divides the marked value by ten.
- ±** Reverses the polarity of the marked value.
- ZERO** Sets the marked value to zero.

B. Direct Edit Facility Right side screen keys operate on the value in the edit box, and acting in place of the ↵ key, exit from Direct Edit back to Digit Edit; then set the value as evaluated in the box.

i. Output Value and Offset Value

- μA** Evaluates the number in the box in **Microamps**.
- mA** Evaluates the number in the box in **Milliamps**.
- A** Evaluates the number in the box in **Amps**.

ii. Deviation Value

- %** Evaluates the number in the box in **Percentage Deviation**.
The Deviation value is limited to ±10% of the Output value.

Output and Offset values are set into the same resolution. All values are set into the highest resolution available to their magnitude.

Final Width = 215mm

Final Width = 215mm

4.5.3 Screen Keys (Contd.)

4.5.3.3 Introducing Deviation and Offset Values

Pressing the ' Δ ' key (bottom row) presents a screen with $\Delta\%$ and ΔA labelling the two top right screen keys:

Pressing the ' $\Delta\%$ ' screen key adds the 'Percentage Deviation' value to the lower left of the display presentation and the screen reverts to the main DC Current display as shown below. The Deviation value is limited to $\pm 10\%$ of the Output value.

Pressing the ' ΔA ' screen key adds the 'DC Current Offset' value to the lower right of the display presentation and the screen reverts to the main DC Current display as shown below.

Note that as each of the ' Δ ' keys is pressed to show its value on the screen, the cursors will move to the latest selection.

The main DC Current display is shown here with both $\Delta\%$ and ΔA additions in place. This would require two separate operations of the Δ key on the bottom row, as after each selection, the screen reverts to the main display. After reversion, the cursors can be transferred to any of the displayed values for editing, here shown on the main output display. Otherwise, the operation of the editing keys is unchanged (*paras* 4.5.3.2), and direct editing can also be used.

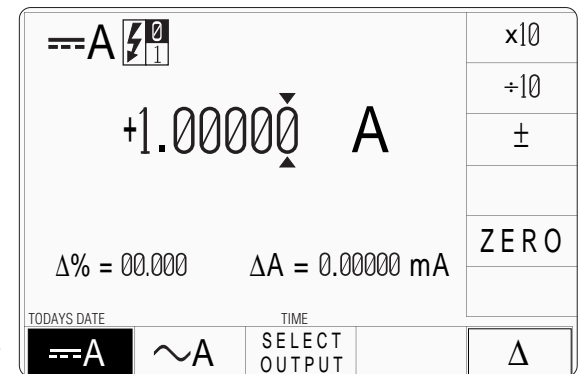
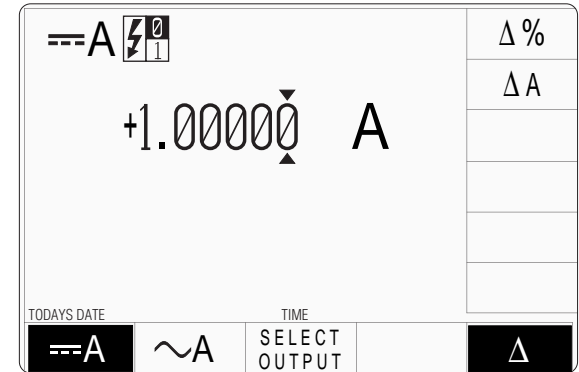

4.5.4 Value Editing

4.5.4.1 Output, Offset and Deviation

The Output, Offset and Deviation and values can be changed using 'Digit' and 'Direct' edit facilities as described in *Section 3*.

Offset Values

The effect of introducing a non-zero offset value is to change all set values of the output by that of the offset. A positive offset will make the output value more positive, and a negative offset will make the output value more negative.

For example:

- a. A set Output Value of +10mA with a +1mA Offset will be output as +11mA.
- b. A set Output Value of -40mA with a +10mA Offset will be output as -30mA.
- c. A set Output Value of +100mA with a -300mA Offset will be output as -200mA.

Deviation Percentage Values

The effect of introducing a non-zero deviation value is to change all set values of the output by the fraction expressed by the deviation. A positive deviation will increase, and a negative deviation will reduce, the output value.

For example:

- a. An Output Value of 10A set on the display, will be increased to 10.5A by a +5% Deviation.
- b. An Output Value of -50mA set on the display, will be decreased to -45mA by a -10% Deviation.

Combined Deviation Percentage and Offset

Deviation and Offset values are combined by first applying the deviation, then the offset, to the output value in the form $y = (1 + m/100)x + c$, where:

y is the terminal current; **x** is the set output current; **m** is the set deviation percentage; **c** is the set offset current.

For example:

- a. Set Values: Output = +10A Deviation = +5% Offset = +3A.
Terminal Current will be:
 $[(1 + 5/100) \times 10A] + (+3A) = [1.05 \times 10] + 3A = +13.5A$
- b. Set Values: Output = +40mA Deviation = -10% Offset = -50mA.
Terminal Current will be:
 $[(1 - 10/100) \times 40mA] + (-50mA) = [0.9 \times 40] - 50mA = -14mA$

Final Width = 215mm

4.5.5 Crossing Thresholds

4.5.5.1 Current Resolution Thresholds

The different resolutions are distinguished by two characteristics:

- Maximum and minimum values available.
- Absolute resolution of the least-significant digit.



The following table shows the spans of output values for the DC Current function, against their associated resolutions.

Absolute Resolution	Span of Values	Nominal Span Value
1nA	-320.000 μ A to +320.000 μ A	300 μ A
10nA	-3.20000 mA to +3.20000 mA	3mA
100nA	-32.0000 mA to +32.0000 mA	30mA
1 μ A	-320.000 mA to +320.000 mA	300mA
1 μ A	-3.20000 A to +3.20000 A	3A
10 μ A	-20.0000 A to +20.0000 A	10A

Final Width = 215mm

Rules, built into firmware, govern passage across thresholds between resolutions:

Increasing Output or Offset Current

Using the  key in Digit Edit facility; an audible warning will be given if the new value is too large for the present span of values, with a reminder ('Up range required') on the screen. The user must change to the next lower resolution, with a larger span of values, using the  key. This rule applies whether OUTPUT is OFF or ON.

When using either the X10 screen key or the Direct Edit facility; if the new value is too large for the present resolution, a lower resolution will be activated with a larger span of values. No warning will be given. This rule applies whether OUTPUT is OFF or ON.

Decreasing Output or Offset Current

Using Digit Edit; values down to zero lie within all spans. If the required value lies between steps of the present resolution, the user must increase resolution using the  key, also reducing the span of values. This rule applies whether OUTPUT is OFF or ON.

Using either the +10 screen key or Direct Editing; if the required value lies between increments of the present resolution, a greater resolution will be activated with reduced span. No warning will be given. This rule applies whether OUTPUT is OFF or ON.

4.5.5.2 Hardware Configurations

When increasing or decreasing output current, using any method: if the new current is too large or small for the present hardware configuration, then if OUTPUT is OFF there will be no noticeable effect as the hardware reconfigures.

If OUTPUT is ON, it will be temporarily turned OFF so that the hardware can reconfigure, then ON again at the new current. No warning will be given. This interruption should cause little disturbance to the reading on any UUT.

Final Width = 215mm

Final Width = 215mm

4.5.6 SELECT OUTPUT

On the DC Current display, a screen key labelled 'SELECT OUTPUT' is located at the center of the bottom row. After pressing this key, a menu is presented against the right-side screen keys, giving selection from 'Normal Output', 'Auxiliary Output', '10 Turn Coil' and '50 Turn Coil'.

Pressing one of these keys will make the relevant connections and impose the appropriate internal parameters for the selected output.

The screen returns to the main DC Current presentation. No indication is given on the screen as to the selected output form. 'SELECT OUTPUT' must be used to determine which form of output is active.

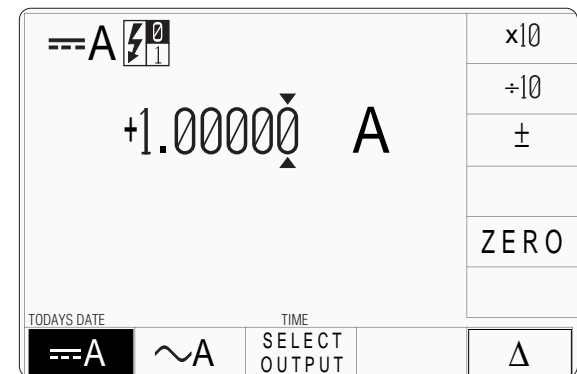
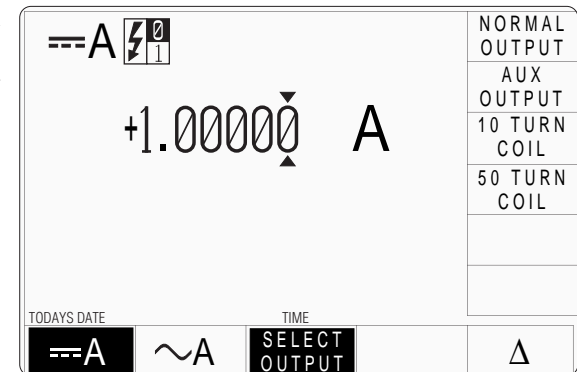

4.5.6.1 'NORMAL OUTPUT'

'NORMAL OUTPUT' is the the default condition, also selectable by the top key on the 'Select Output' menu. DC Current is output via the I+ and I- terminals, with no provision to guard the output. The maximum span of DC Currents (-20A to +20A) is available from these terminals.

If the magnitude of the total DCI output (including deviation and offset) is not greater than 10.5A, the 9100 will provide a continuous output.

For a total DCI output with magnitude greater than 10.5A, the length of time that the output can remain 'ON' is limited by an algorithm:

The total output value is continuously monitored, and the time is counted during which the output is greater than 10.5A. The maximum time that the output can remain on and greater than 10.5A is 2 minutes, then its value is reduced by half, and a limit of 10.5A is imposed. Subsequently, after four times the earlier >10.5A 'ON' time, the current can once again be raised above 10.5A.

4.5.6.2 'AUXILIARY OUTPUT'

'AUX OUTPUT' is the second key from the top. This allows access to a guarded I+ output to the UUT, from the 15-way D-Type socket underneath the front terminals, instead of using the main I+ terminal. Where such guarding is required, any external guard screen for I+ should also be connected to the socket. The UUT I- connection must always be returned to the main I- terminal.

DC Current I+ is output via pin 8 of the D-Type socket, with a provision to guard I+ by connecting an external guard screen to pin 7 of the socket. The UUT I- or Lo must be returned via the main I- terminal.

To protect internal wiring, the maximum (-20A to +20A) span of DC Currents is **not** available from these pins. The guarded output is limited to a span of -1A to +1A.

4.5.6.3 10- and 50-Turn Current Coils (Option 200) (Fig. 4.6.1)

Option 200 comprises two coils for use with current clamps or clamp-on ammeters. Effective current step-up ratios of X10 and X 50 are selected by connections to the 10-turn and 50-turn primaries. The 9100 I+ connects to either a '10 TURN' or a '50 TURN' terminal, and the I- terminal is connected to the 'COMMON' terminal on the same coil.

The sensor clamp passes through the center air space of the selected coil — manufacturers' precautions should be observed as to the positioning of the clamp within the coil — refer also to the notes with Fig 4.5.4/5/6 on page 4.5-14.

Final Width = 215mm

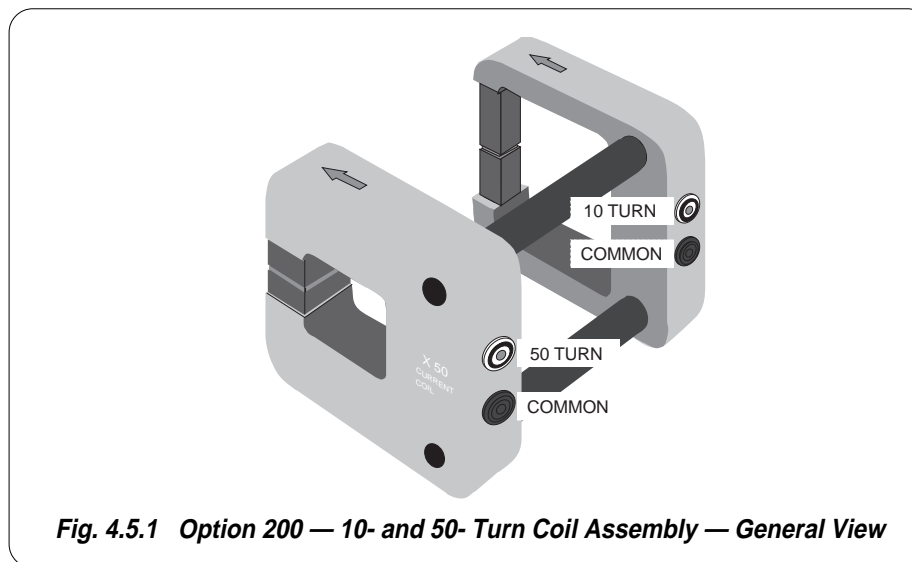

Final Width = 215mm

4.5.6 SELECT OUTPUT *(Contd.)*

4.5.6.4 '10 TURN COIL'

This is the third key from the top. DC Current is output, as in 'Normal Output', via the I+ and I- terminals, with no provision to guard the output.

The facility is intended for use with Option 200: 10- and 50-Turn Current Coils. It is convenient to use the coils in conjunction with the Lead Kit, Model 9105; but it is possible to connect the coils directly to the front panel I+ and I- terminals. For the 9100 '10 TURN' selection, connect the 9100 I- (9105 'LI-' black lead) to the coils 'COM', and the 9100 I+ (9105 'I+ 20A' yellow lead) to the coils '10 TURN'.

The demanded output must be $>320\text{mA}$ at the point of selecting the 10-turn coil output for the 9100 to accept the selection.

If the 9100 output terminals are open-circuited, then a compliance error will be reported.

If the magnitude of the total DCI output from the 10-turn coil (including deviation and offset) is not greater than 105A, the 9100 will provide a continuous output.

For a total DCI output with magnitude greater than 105A, the length of time that the output can remain 'ON' is limited by an algorithm:

The total output value is continuously monitored, and the time is counted during which the output is greater than 105A. The maximum time that the output can remain on and greater than 105A is 2 minutes, then its value is reduced by half, and a limit of 105A is imposed. Subsequently, after four times the earlier $>105\text{A}$ 'ON' time, the current can once again be raised above 105A.

Resolution Thresholds

The 9100 firmware will prevent entry to 10-turn coil operation unless the active span is either: between -3.2A and -200A; or between +3.2A and +200A.

The following table shows the spans of output current values against their associated resolutions, using the 10-turn coil:

Absolute Resolution	Span of Values	
	Negative	Positive
100 μA	-32.0000 A to -03.2001 A	+03.2001 A to +32.0000 A
1mA	-200.000 A to -003.201 A	+003.201 A to +200.000 A

The same rules governing passage across thresholds and hardware configurations apply as for the normal output.

4.5.6.5 '50 TURN COIL'

This is the bottom key. DC Current is output, as in 'Normal Output', via the I+ and I- terminals, with no provision to guard the output.

The facility is intended for use with Option 200: 10- and 50-Turn Current Coils. It is convenient to use the coils in conjunction with the Lead Kit, Model 9105; but it is possible to connect the coils directly to the front panel I+ and I- terminals. For the 9100 '50 TURN' selection, connect the 9100 I- (9105 'LI-' black lead) to the coils 'COM', and the 9100 I+ (9105 'I+ 20A' yellow lead) to the coils '50 TURN'.

The demanded output must be >320mA at the point of selecting the 50-turn coil output for the 9100 to accept the selection.

If the 9100 output terminals are open-circuited, then a compliance error will be reported.

If the magnitude of the total DCI output from the 50-turn coil (including deviation and offset) is not greater than 525A, the 9100 will provide a continuous output.

For a total DCI output with magnitude greater than 525A, the length of time that the output can remain 'ON' is limited by an algorithm:

The total output value is continuously monitored, and the time is counted during which the output is greater than 525A. The maximum time that the output can remain on and greater than 525A is 2 minutes, then its value is reduced by half, and a limit of 525A is imposed. Subsequently, after four times the earlier >525A 'ON' time, the current can once again be raised above 525A.

Final Width = 215mm

Resolution Thresholds

The 9100 firmware will prevent entry to 50-turn coil operation unless the active span in is either: between -16A and -1000A; or between +16A and +1000A.

The following table shows the spans of output current values against their associated resolutions, using the 50-turn coil:

Absolute Resolution	Span of Values	
	Negative	Positive
100µA	-32.0000 A to -16.0010 A	+16.0010 A to +32.0000 A
1mA	-320.000 A to -016.001 A	+016.001 A to +320.000 A
10mA	-1000.00 A to -0016.01 A	+0016.01 A to +1000.00 A

The same rules governing passage across thresholds and hardware configurations apply as for the normal output.

Final Width = 215mm

4.5.7 DC Current Routines for Calibrating UUTs

4.5.7.1 Interconnections

The general connection schemes for UUT calibration of DC Current Function are illustrated in *Figs. 4.5.2, 4.5.3 and 4.5.4.*

For UUTs without *safety* banana sockets, use appropriate adaptors.

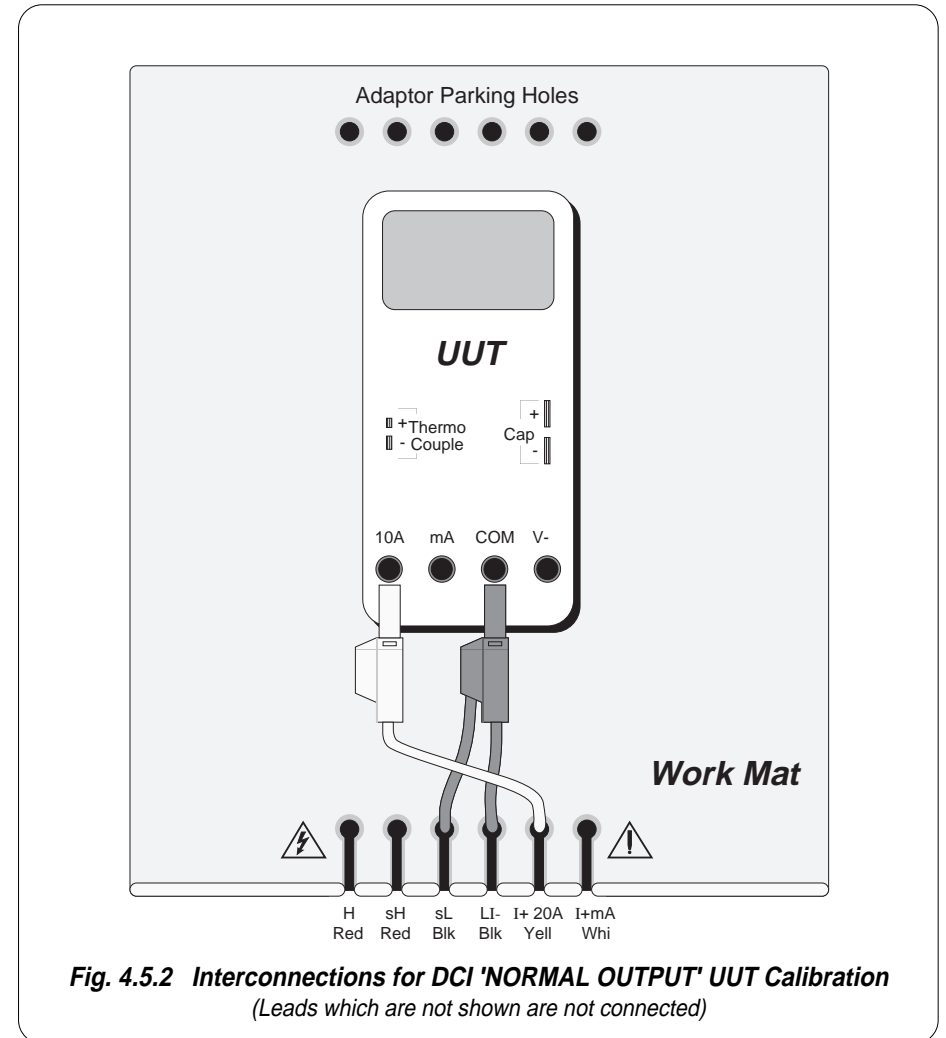

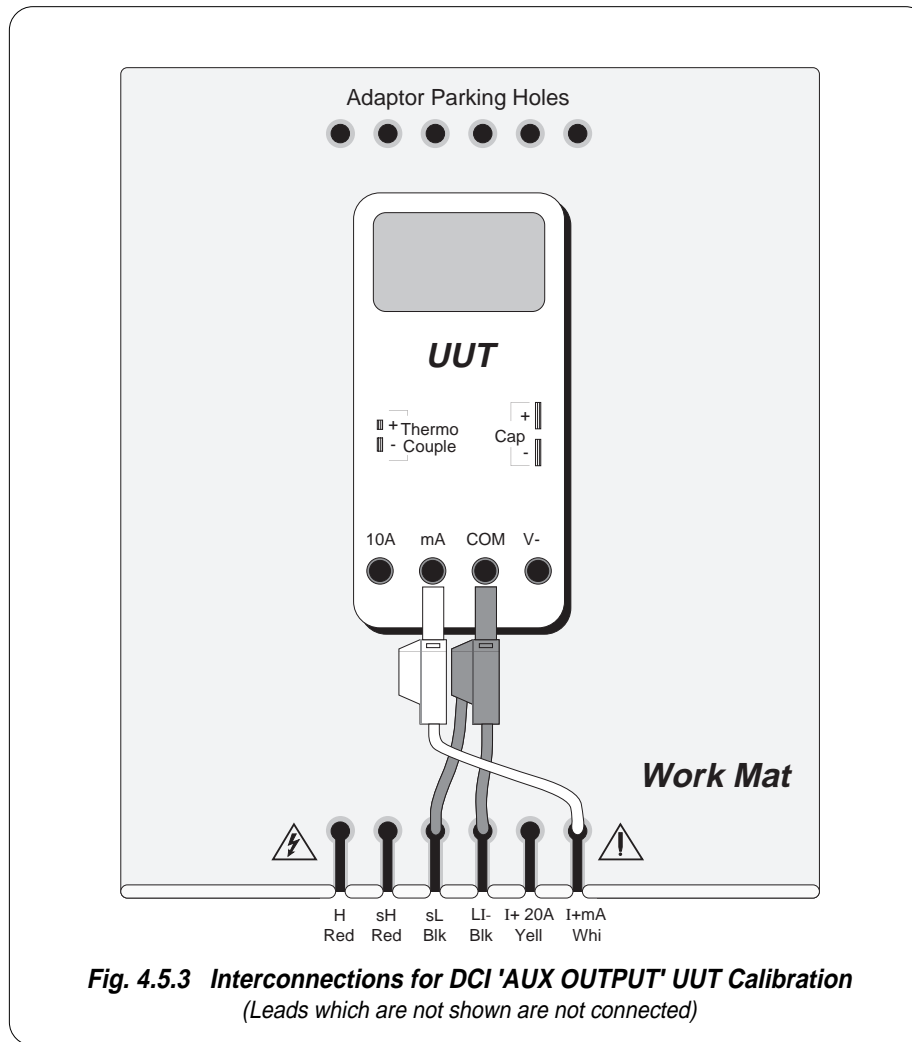

Fig. 4.5.3 Interconnections for DCI 'AUX OUTPUT' UUT Calibration
(Leads which are not shown are not connected)

Final Width = 215mm

Final Width = 215mm

Notes about positioning the current sensing clamp in the center air space of the coils:

The two coils on the assembly have been optimally designed to reduce the effects of stray magnetic fields at the pick-up position for sensor clamps. The design gives characteristics which would normally be associated with central air spaces of much larger area, more closely simulating single-conductor pick-ups.

However, there are several types of clamp meter; some having different requirements for placing the clamp around the pick-up conductor. Manufacturers normally give instructions for aligning the clamp or meter with respect to the conductor. When the meter is clamped to any conductor, errors may arise whose magnitude is similar to the uncertainty of the meter if precautions are not observed, so the manufacturer's instructions should be strictly followed when using the 9100 to calibrate the clamp meter.

To obtain consistent results, in the absence of manufacturer's instructions, the following guidelines should be observed:

- Fig 4.5.5. With the coils located on a non-magnetic surface (not the work mat, as it has a steel core), place the clamp in position so that it surrounds the vertical arm of the coil. Keep the clamp mid-way up the vertical arm, and away from the corners.
- Fig 4.5.6. Place the vertical arm of the coil, as far as is possible, in the center of the air space of the clamp. Align the center axis of the meter along the plane of the coil itself.
- During later normal measurements using the clamp meter, place the clamp in the same position with respect to the pick-up conductor as it was when being calibrated.

4.5.7 DC Current Routines for Calibrating UUTs (Contd.)

4.5.7.1 Interconnections (Contd.)

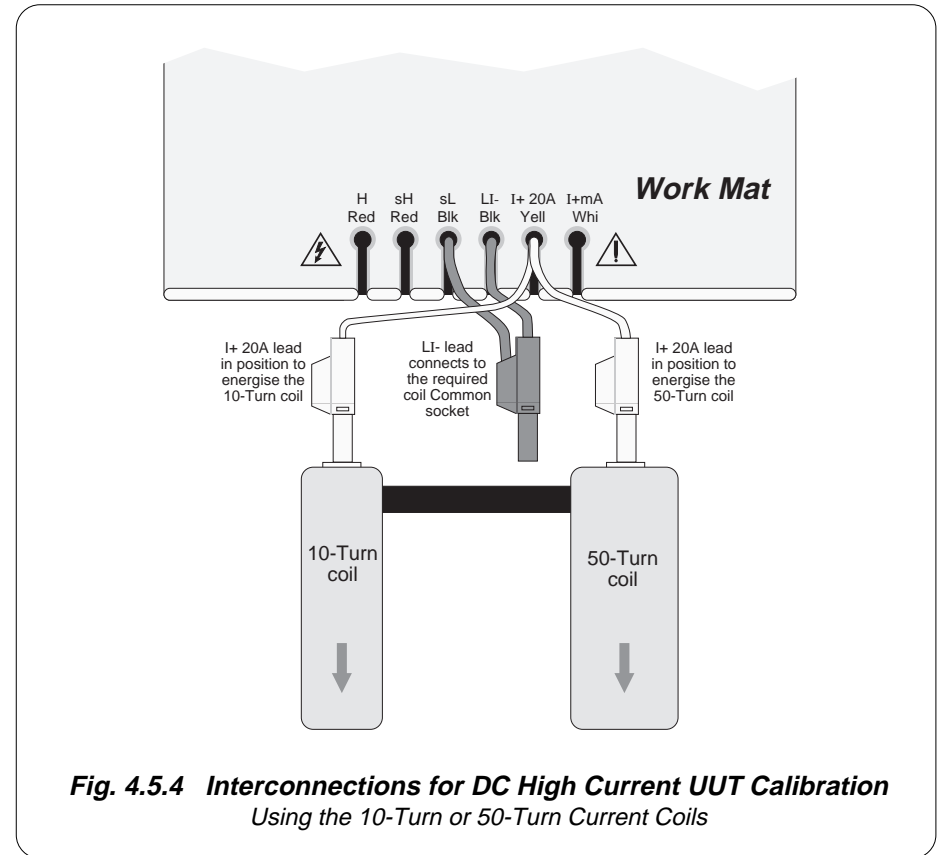

Fig. 4.5.4 Interconnections for DC High Current UUT Calibration
Using the 10-Turn or 50-Turn Current Coils

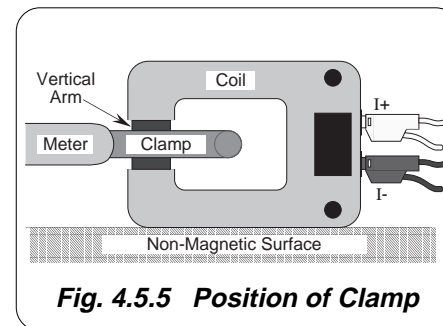

Fig. 4.5.5 Position of Clamp

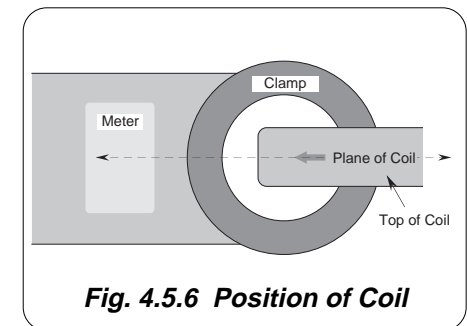

Fig. 4.5.6 Position of Coil

4.5.7.2 Using the 9100 as a Fixed Source

The following procedure assumes that the instrument is in Manual Mode. In the case of difficulty, re-read *Section 3; sub-section 3.3.1*. Familiarity with the methods of editing screen values is also assumed (*Section 3*).

9100 and UUT Setup

1. **Connections** Connect the 9100 to the UUT as shown in *Fig. 4.5.2* (Normal Output), *Fig. 4.5.3* (Aux Output) or *Fig. 4.5.4* (Current Coil Output), and ensure that both instruments are powered ON and warmed up.
2. **UUT** Select DC Current function.
3. **9100** Ensure that the 9100 is in DC Current Function with Output OFF. If in any other function, press the 'A' key on the right of the front panel.

Sequence of Operations

Refer to the table or list of UUT calibration points in the *UUT Manufacturer's Calibration Guide*.

Final Width = 215mm

Follow the correct sequence of calibration stages as directed by the guide, and carry out the following operations (1) to (5) at each stage.

1. **9100** Use the front panel controls to set the 9100 Output current to the UUT cal point value, and select the form of output (SELECT OUTPUT key). Reconnect (*Fig. 4.5.2, 4.5.3 or 4.5.4*) as required.
2. **UUT** Select the correct range for the cal point.
3. **9100**
 - a. Set Output **ON**.
 - b. Note the UUT reading.
4. **UUT**
 - a. If a UUT calibration adjustment is provided, adjust the UUT reading to be equal to that on the 9100 screen, as detailed in the *UUT Manufacturer's Calibration Guide*.
 - b. If no adjustment is provided on the UUT, record the UUT reading at the calibration point as detailed in the *UUT Manufacturer's Calibration Guide*.
5. **9100** Set Output **OFF**.

Final Width = 215mm

4.5.7.3 Using the 9100 as an Adjustable Source

The following procedure assumes that the instrument is in Manual Mode. In the case of difficulty, re-read *sub-section 3.3.1*. Familiarity with the methods of editing screen values is also assumed (*Section 3*).

9100 and UUT Setup

1. **Connections** Connect the 9100 to the UUT as shown in *Fig. 4.5.2* (Normal Output), *Fig. 4.5.3* (Aux Output) or *Fig. 4.5.4* (Current Coil Output), and ensure that both instruments are powered ON and warmed up.
2. **UUT** Select DC Current function.
3. **9100** Ensure that the 9100 is in DC Current Function with Output OFF. If in any other function, press the 'A' key on the right of the front panel.

Sequence of Operations

Refer to the table of UUT calibration points in the *UUT Manufacturer's Calibration Guide*. Follow the correct sequence of calibration stages as directed by the guide, and carry out the following operations (*1*) to (*5*) at each stage.

1. **9100** Use the front panel controls to set the 9100 Output current to the UUT cal point value, and select the form of output (SELECT OUTPUT key). Reconnect (*Fig. 4.5.2, 4.5.3 or 4.5.4*) as required.
2. **UUT** Select the correct range for the cal point.
3. **9100**
 - a. Set Output **ON**.
 - b. Slew the DC Current Output reading until the UUT reading is equal to the calibration point value.
4. **UUT** Record the 9100 screen output value as detailed in the *UUT Manufacturer's Calibration Guide*.
5. **9100** Set Output **OFF**.

4.6 AC Current Function — Operation

4.6.1

This sub-section is a guide to the use of the 9100 for generating a required AC Current output. The following topics are covered:

- 4.6.2 Selection of AC Current Function.
 - 4.6.2.1 'A' Key.
 - 4.6.2.2 Default Settings.
- 4.6.3 Screen Keys.
 - 4.6.3.1 Bottom Screen Keys.
 - 4.6.3.2 Right Side Screen Keys.
 - 4.6.3.3 Introducing Deviation Values.
 - 4.6.3.4 Selecting Other Waveshapes.
 - 4.6.3.5 Phase-Locking Facilities.
- 4.6.4 Value Editing.
 - 4.6.4.1 Output and Deviation.
 - 4.6.4.2 Frequency Editing.
 - 4.6.4.3 'Out of Range'.
- 4.6.5 Crossing Thresholds.
 - 4.6.5.1 AC Current Resolution Thresholds.
 - 4.6.5.2 Frequency Resolution Thresholds.
 - 4.6.5.3 Hardware Configurations.
- 4.6.6 Select Output
 - 4.6.6.1 Normal Output.
 - 4.6.6.2 Auxiliary Output.
 - 4.6.6.3 Option 200: 10- and 50-Turn Current Coils.
 - 4.6.6.4 10-Turn Coil.
 - 4.6.6.5 50-Turn Coil.
- 4.6.7 Amp-Hertz Limits.
 - 4.6.7.1 Amp-Hertz Profile
- 4.6.8 AC Current Routines for Calibrating UUTs.
 - 4.6.8.1 Interconnections
 - 4.6.8.2 Using the 9100 as a Fixed Source
 - 4.6.8.3 Using the 9100 as an Adjustable Source

Final Width = 215mm

In this sub-section, we deal with the full range of ACI facilities, in a concise way. For those who require more detailed instructions for manipulating the front panel controls, the DC Voltage function was used as an example for the general familiarization tutorials in *Section 3*.

Final Width = 215mm

4.6.2 Selection of AC Current Function

(Manual Mode selected)

4.6.2.1 'A' Key

Current is selected by pressing the 'A' key at the top right of the 'CALIBRATION SYSTEM' panel.

4.6.2.2 Default Settings

At power-on the system defaults to DC Voltage function. Each time the 'A' key is pressed, the system defaults into DC Current function.

If DC Current is already active, then the AC Current menu screen is opened by pressing the \sim A screen key on the bottom row.

Whenever the AC Current menu screen is opened, except on recovery from a standby period, it will appear with the following default settings:

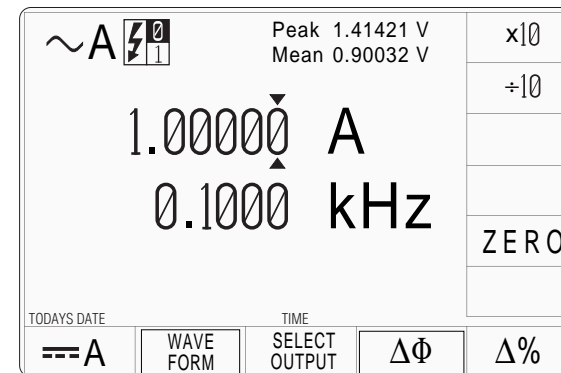

4.6.3 Screen Keys

4.6.3.1 Bottom Screen Keys

- == A** Selects DC Current Function when AC Current Function is active.
- ~ A** Selects AC Current Function when DC Current Function is active.
- SELECT OUTPUT** Permits connection of output currents up to 1A, via the guarded 'D-type' socket, instead of the main terminals, on the front panel. Also permits connection of output currents via the 10- and 50-turn coils (Option 200). *Refer to paras 4.6.6.*
- Δ%** Adds the 'Percentage Deviation' value to the display presentation. *Refer to paras 4.6.3.3.*
- WAVE FORM** Gives access to change the waveshape of the output current. *Refer to paras 4.6.3.4.*
- ΔΦ** Gives access to the phase-locking facility. *Refer to paras 4.6.3.5.*

4.6.3.2 Right Side Screen Keys

- A. Digit Edit Facility** Keys operate on the value marked by the cursor.
- X10** Multiplies the marked value by ten.
- ÷10** Divides the marked value by ten.
- ±** Reverses the polarity of the marked value. The ± key is only available when the cursor is marking the Deviation value
- ZERO** Sets the marked value to zero. ZERO is available only when the cursor is marking the Output value.
- B. Direct Edit Facility** Right side keys operate on the value in the edit box, and acting in place of the ↵ key, exit from Direct Edit back to Digit Edit; then set the value as evaluated in the box.
- i. Output Value**
- μA** Evaluates the number in the box in **Microamps**.
- mA** Evaluates the number in the box in **Milliamps**.
- A** Evaluates the number in the box in **Amps**.
- ii. Frequency**
- Hz** Evaluates the number in the box in **Hertz**.
- kHz** Evaluates the number in the box in **Kilohertz**.
- iii. Deviation Value**
- %** Evaluates the number in the box in **Percentage Deviation**. The Deviation value is limited to ±10% of the Output value.

All values are set into the highest resolution available to their magnitude.

Final Width = 215mm

Final Width = 215mm

4.6.3 Screen Keys (Contd.)

4.6.3.3 Introducing Deviation Values

Pressing the ' $\Delta\%$ ' screen key adds the 'Percentage Deviation' value to the lower left of the display presentation. The Deviation value is limited to $\pm 10\%$ of the Output value.

Note that as the ' $\Delta\%$ ' key is pressed to show its value on the screen, the cursors will move to the added value.

The AC Current display is shown here with the $\Delta\%$ addition in place, but with the cursors transferred to the main output value for digit editing as described in Section 3. Otherwise, the operation of the editing keys is unchanged (*paras* 4.6.3.2), and direct editing can also be used.

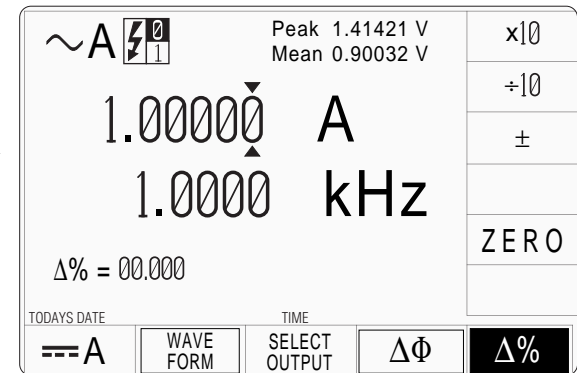

4.6.3.4 Selecting Other Waveshapes

Pressing the 'WAVE FORM' key (bottom row) presents a screen with five waveshapes shown against the right screen keys:

Pressing the appropriate 'waveshape' screen key (e.g. 'square') sets the internal parameters to create the selected waveform.

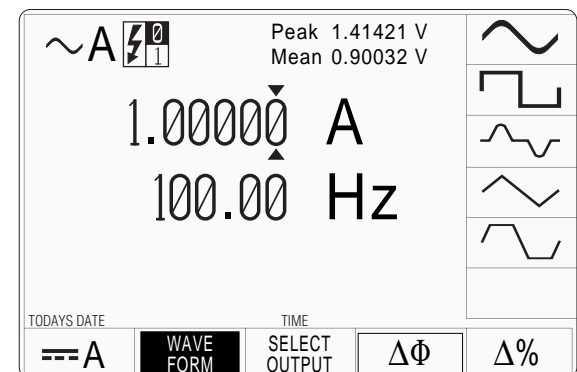

The screen reverts to the main AC Current display, but with the selected waveform identifier ('square' shown) transferred to the top left corner:

The operation of the editing keys is unchanged (*paras 4.6.3.2*).

The five waveshapes are shown below, in their relative phase positions (although, of course, only one waveshape can exist at a time).

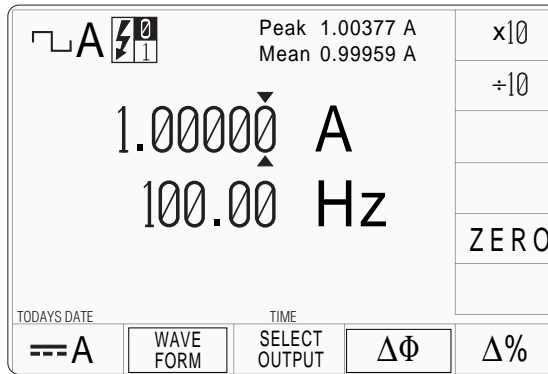

A frequency limit of 1kHz is placed on all outputs with non-sinusoidal waveshapes, which are specified only at frequencies up to 100Hz if Option 200 (10- and 50-turn current coils) is in use.

Each waveshape's form factor results in its own mean/RMS and peak/RMS ratio, so for the same RMS output value, the peak and mean readings at the top of the screen will change between waveshapes.

Final Width = 215mm

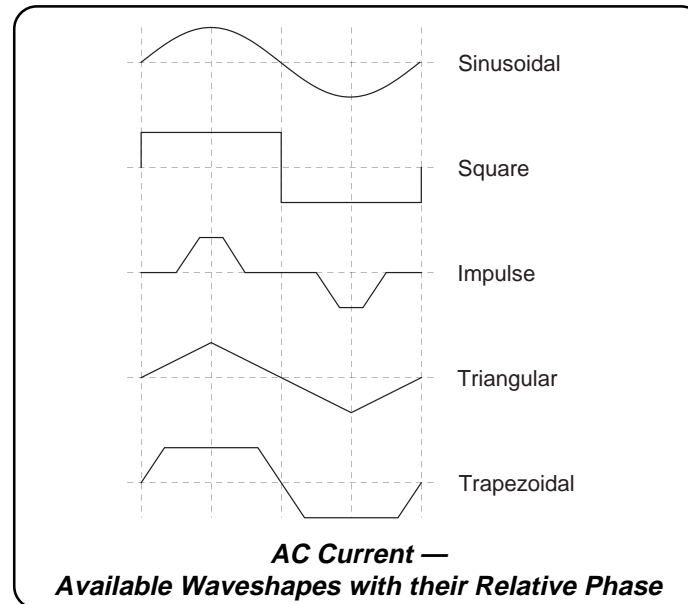

4.6.3.5 Phase-Locking Facilities

Access:

Pressing the ' $\Delta\Phi$ ' key (bottom row) presents a screen with alternative roles shown against the two top right screen keys:

Phase Lock Role:

(Refer also to the illustration of the rear panel in Section 2, sub-section 2.7.)

Pressing the right-side ' $\Delta\Phi$ ' screen key permits the unit's output to be phase-locked to a received external synchronizing signal of the same frequency ('PHASE LOCK IN' on the rear panel). The phase of the 9100 output, relative to the synchronization point, can be altered over a range of $\pm 180^\circ$.

After the ' $\Delta\Phi$ ' key is pressed, the screen reverts to the main AC Current display, but with the addition of a ' $\Delta\phi$ ' field, used to alter the phase-shift of the output relative to the received external reference.

The cursors can be transferred to the $\Delta\phi$ field in *Digit Edit* to edit the value. *Direct Edit* can also be used as described in Section 3.

Reference Output Role:

Pressing the 'REF OUTPUT' screen key produces a synchronizing TTL signal at 'PHASE LOCK OUT' on the rear panel, in the same phase as the 'PHASE LOCK IN' input. This can be transmitted as a reference signal for phase-locking the outputs of up to five other 9100 units.

Combined Use

The 9100 can be used in both roles simultaneously: producing a reference output signal in phase with the 'PHASE LOCK IN' input from a master reference, while generating its own synchronized output signals. However, a 'fan-out' system is preferred, with one 'Master' unit providing the reference for up to five other 'Slaves'.

The Phase-Locking Facility Applies to All Waveforms

Phase-locking is not dependent on the type of waveform, but on underlying timing, and so applies to all output waveforms illustrated in the figure opposite.

Type of Reference Signal Input

When being phase-locked to an external signal, the *synchronization point* is the *negative-going* edge of the synchronizing signal (negative-going zero-crossing in the case of a sinewave reference signal). To this is added the $\Delta\phi$ phase-shift value registered on the screen, determining the phase of the *positive-going* crossover of the output AC Current relative to the *synchronization point*. This inversion means that with a request for 0° shift, the output signal appears to lag by 180° on the synchronizing signal phase.

Relative Phase-Shift Magnitude and Direction

The zero phase-shift point is taken as the *synchronization point* illustrated opposite. On the screen, at values other than zero, the direction of phase shift $\Delta\phi$ is indicated by a '+' sign if the output is advanced on the reference input, and a '-' sign if the output is delayed. $\Delta\phi$ is resolved in steps of 0.01° as shown on the screen, at any value in the range -180° to $+180^\circ$.

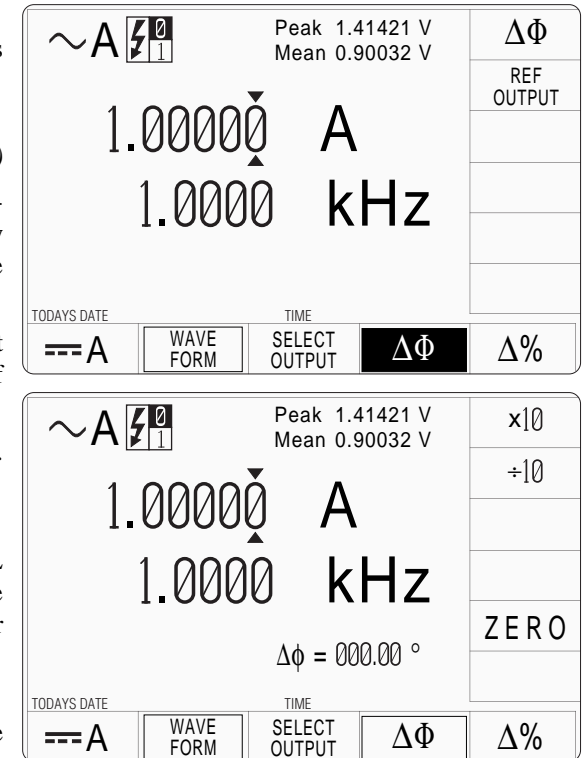

Final Width = 215mm

Reference Signal Output

The reference signal produced by a 9100 is a wide pulse, compatible with TTL, between the levels +0.5V and +4.5V, with its negative-going edge coincident with the *synchronization points*. (i.e. in phase with the 'PHASE LOCK IN' input, when applied).

4.6.3.6 Conditions for Operation

Same Frequency

For any two 9100 units (Master and Slave), both *must be set to the same frequency* of 1kHz or lower, *before* the output of the Driven unit is turned on.

Good Practice - Combined Use - HVAC and ACI Outputs

In general, a slave unit will be well-behaved if the synchronizing pulse is interrupted. However, as the voltage increases above a few hundred volts, and the frequency decreases below 100Hz, synch. pulse interruptions or shifts may cause transients which result in operation of the protection circuitry in the slave unit, automatically turning its output off.

To avoid this, if one unit *must* be run at HVAC and LF, it should be assigned as Master unit if at all possible (e.g. in a system where one unit outputs 250V AC at 60Hz, and another outputs 10A at 60Hz, then the latter should be assigned to the slave role).

If units *must* be run as slaves at HVAC and LF (such as in a six-unit 3-phase system), observe the precautions described in the following paragraphs.

Change of Function — Reference 9100 Unit

If the Reference unit's function is changed from ACI, its reference output will go low. This will cause the Driven unit to unlock and free-run, being most unlikely to remain in phase with the Reference unit. External control will be re-established when the Reference unit is returned to ACI function (or placed in ACV function). At this time the Driven unit's phase will be switched rapidly, creating transient disturbances in the output AC current unless it is switched off. The Driven unit's output must therefore *be turned OFF* before the reference unit is returned to any AC function, (ACV or ACI).

Disconnection of Reference Cable

Disconnection of the cable from the Reference input ('PHASE LOCK IN' on the rear panel) will also cause the Driven unit to free-run, with resultant phase-shift of its output and possible transients when reconnected. Again, the Driven unit's output *must be turned OFF* before the cable is reconnected.

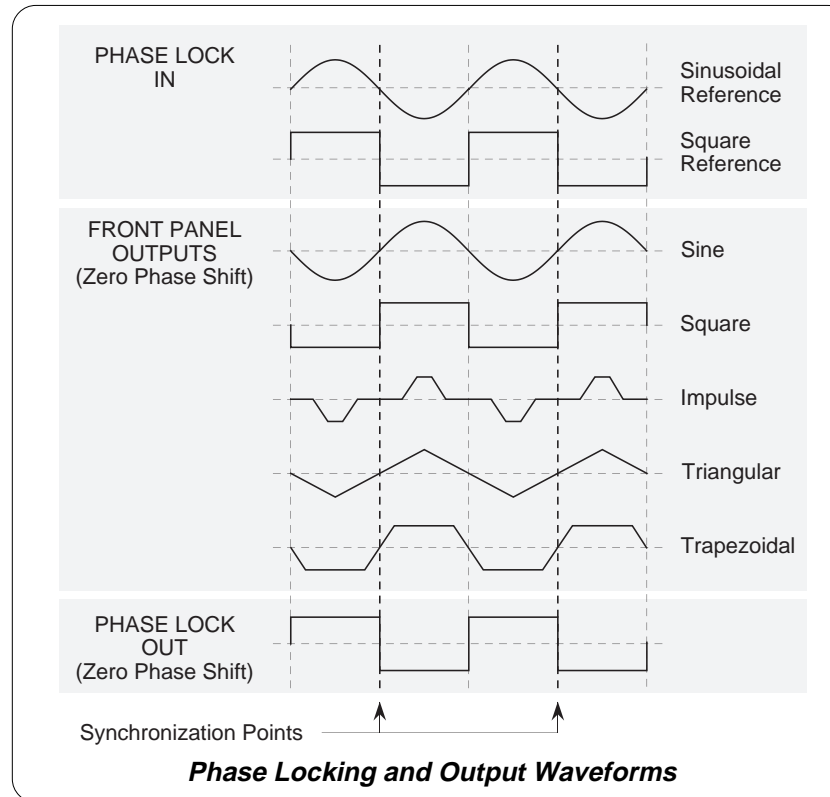

Final Width = 215mm

Help Available!

Section 3 Editing Tutorials.

Final Width = 215mm

4.6.4 Value Editing**4.6.4.1 Output and Deviation**

Output and Deviation values can be changed using 'Digit' and 'Direct' edit facilities as described in *Section 3*.

Deviation Percentage Values

The effect of introducing a non-zero deviation value is to change all set RMS values of the output by the fraction expressed by the deviation. A positive deviation will increase, and a negative deviation will reduce, the output RMS value.

For example:

- a. An Output Value of 10A RMS set on the display, will be increased to 10.5A RMS by a +5% Deviation.
- b. An Output Value of 50mA RMS set on the display, will be decreased to 45mA RMS by a -10% Deviation.

4.6.4.2 Frequency Editing

Frequency values can be changed using 'Digit' and 'Direct' edit facilities. The editing processes are not described in Section 3, but follow the same general rules as for editing Currents.

The resolution of frequency values is set at six significant digits, leading to three frequency spans of constant resolution.

The thresholds between resolutions of frequency are given in *paras 4.6.5.2*.

Hardware configurations for frequency change are given in *paras 4.6.5.3*.

4.6.4.3 'Out of Range'

Any attempt to select a combination of current and frequency (including the application of deviations and/or offsets) outside the constraints of the Amp-Hertz profile will not be enabled.

An audible warning will be given, accompanied by the screen message: '**Out of range**'.

Refer to *Sub-section 4.6.7*.

4.6.5 Crossing Thresholds

4.6.5.1 AC Current Resolution Thresholds

The different current resolutions are distinguished by two characteristics:

- Maximum and minimum values available.
- Absolute resolution of the least-significant digit.

The following table shows the spans of output values in the AC Current function, for 'sinusoidal waveshape only, against their associated resolutions.

Absolute Resolution	Span of Values (RMS)	Nominal Span Value
1nA	000.000 μ A to 320.000 μ A	300 μ A
10nA	0.00000 mA to 3.20000 mA	3mA
100nA	00.0000 mA to 32.0000 mA	30mA
1 μ A	000.000 mA to 320.000 mA	300mA
1 μ A	0.00000 A to 3.20000 A	3A
10 μ A	00.0000 A to 20.0000 A	10A

Rules, built into firmware, govern passage across thresholds between resolutions.

Increasing Output Current

Using the \odot key in Digit Edit facility; an audible warning will be given if the new value is too large for the present span of values, with a reminder ('Up range required') on the screen. The user must change to the next lower resolution, with a larger span of values, using the \langle key. This rule applies whether OUTPUT is OFF or ON.

When using either the X10 screen key or the Direct Edit facility; if the new value is too large for the present resolution, a lower resolution will be activated with a larger span of values. No warning will be given. This rule applies whether OUTPUT is OFF or ON.

Decreasing Output Current

Using Digit Edit; values down to zero lie within all spans. An attempt to set a negative value will not be enabled, and an audible warning will be given, accompanied by a reminder ('Minimum value') on the screen. If the required value lies between steps of the present resolution, the user must increase resolution using the \rangle key, also reducing the span of values. This rule applies whether OUTPUT is OFF or ON.

Using either the +10 screen key or Direct Editing; if the required value lies between increments of the present resolution, a greater resolution will be activated with reduced span. No warning will be given. This rule applies whether OUTPUT is OFF or ON.

'Out of range'

Refer to *Sub-section 4.6.7*.

Final Width = 215mm

Final Width = 215mm

4.6.5.2 Frequency Resolution Thresholds

The different frequency resolutions are distinguished by two characteristics:



- Lowest and highest frequencies available.
- Absolute resolution of the least-significant digit.

The following table shows the spans of output frequencies in the AC Current function, for 'sinusoidal waveshape only, against their associated resolutions.

A frequency limit of 1kHz is placed on all outputs with non-sinusoidal waveshapes, which are specified only at frequencies up to 100Hz if Option 200 (10- and 50-turn current coils) is in use.

Absolute Resolution	Span of Frequencies	Nominal Frequency
1mHz	010.000 Hz to 320.000 Hz	300Hz
10mHz	0.01000 kHz to 3.20000 kHz	3kHz
100mHz	00.0100 kHz to 30.0000 kHz	30kHz

Increasing Frequency

Using the  key in Digit Edit facility; an audible warning will be given if the new value is too large for the present span of frequencies, with a reminder ('Up range required') on the screen. The user must change to the next lower resolution, with a larger span of frequencies, using the  key. This rule applies whether OUTPUT is OFF or ON.

When using either the X10 screen key or the Direct Edit facility; if the new frequency is too large for the present resolution, a lower resolution will be activated with a larger span of frequencies. No warning will be given. This rule applies whether OUTPUT is OFF or ON.

Decreasing Frequency

Using Digit Edit; frequencies down to 10Hz lie within all current spans. Any attempt to set a frequency below 10Hz for these currents will not be enabled, and an audible warning will be given, accompanied by a reminder ('Minimum value') on the screen.

If the required frequency lies between steps of the present frequency resolution, then the user must increase resolution using the  key (this also reduces the span of frequencies). This rule applies whether OUTPUT is OFF or ON.

Using either the +10 screen key or Direct Editing; if the required frequency lies between increments of the present resolution, a greater resolution will be activated with reduced span. No warning will be given. This rule applies whether OUTPUT is OFF or ON.

'Out of range'

Refer to *Sub-section 4.6.7.*

4.6.5.3 Hardware Configurations

Current or Frequency Changes

When increasing or decreasing output current or frequency, using any method: if the new current or frequency is too large or small for the present hardware configuration, then if OUTPUT is OFF there will be no noticeable effect as the hardware reconfigures.

If OUTPUT is ON, it will be temporarily turned OFF so that the hardware can reconfigure, then ON again at the new current. No warning is given. This interruption should cause little disturbance to the reading on any UUT.

Final Width = 215mm

Final Width = 215mm

4.6.6 SELECT OUTPUT

On the AC Current display, a screen key labelled 'SELECT OUTPUT' is located at the center of the bottom row. After pressing this key, a menu is presented against the right-side screen keys, giving selection from 'Normal Output', 'Auxiliary Output', '10 Turn Coil' and '50 Turn Coil'.

Pressing one of these keys will make the relevant connections and impose the appropriate internal parameters for the selected output.

The screen returns to the main AC Current presentation. No indication is given on the screen as to the selected output form. 'SELECT OUTPUT' must be used to determine which form of output is active.

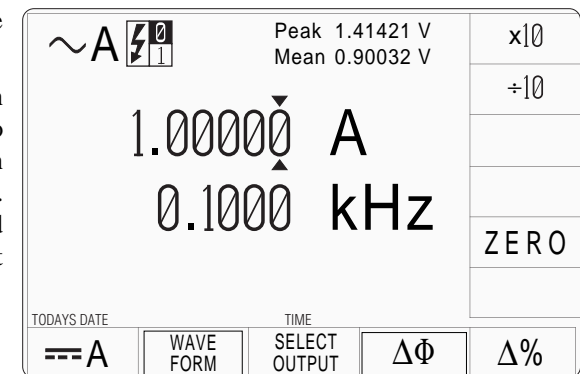
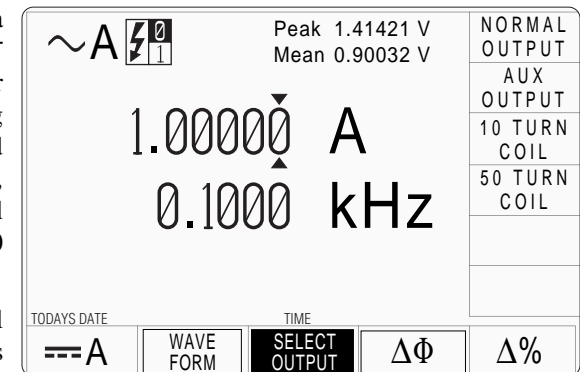

4.6.6.1 'NORMAL OUTPUT'

'NORMAL OUTPUT' is the the default condition, also selectable by the top key on the 'Select Output' menu. AC Current is output via the I+ and I- terminals, with no provision to guard the output. The maximum span of AC Currents (-20A to +20A) is available from these terminals.

If the magnitude of the total ACI output (including deviation and offset) is not greater than 10.5A, the 9100 will provide a continuous output.

For a total ACI output with magnitude greater than 10.5A, the length of time that the output can remain 'ON' is limited by an algorithm:

The total output value is continuously monitored, and the time is counted during which the output is greater than 10.5A. The maximum time that the output can remain on and greater than 10.5A is 2 minutes, then its value is reduced by half, and a limit of 10.5A is imposed. Subsequently, after four times the earlier >10.5A 'ON' time, the current can once again be raised above 10.5A.

4.6.6.2 'AUXILIARY OUTPUT'

'AUX OUTPUT' is the second key from the top. This allows access to a guarded I+ output to the UUT, from the 15-way D-Type socket underneath the front terminals, instead of using the main I+ terminal. Where such guarding is required, any external guard screen for I+ should also be connected to the socket. The UUT I- connection must always be returned to the main I- terminal.

AC Current I+ is output via pin 8 of the D-Type socket, with a provision to guard I+ by connecting an external guard screen to pin 7 of the socket. The UUT I- or Lo must be returned via the main I- terminal.

To protect internal wiring, the maximum (-20A to +20A) span of AC Currents is **not** available from these pins. The guarded output is limited to a span of -1A to +1A.

4.6.6.3 10- and 50-Turn Current Coils (Option 200) (Fig. 4.6.1)

Option 200 comprises two coils for use with current clamps or clamp-on ammeters. Effective current step-up ratios of X10 and X 50 are selected by connections to the 10-turn and 50-turn primaries. The 9100 I+ connects to either a '10 TURN' or a '50 TURN' terminal, and the I- terminal is connected to the 'COMMON' terminal on the same coil.

The sensor clamp passes through the center air space of the selected coil — manufacturers' precautions should be observed as to the positioning of the clamp within the coil — refer also to the notes with *Figs 4.6.5/6/7* on *page 4.6-19*.

Final Width = 215mm

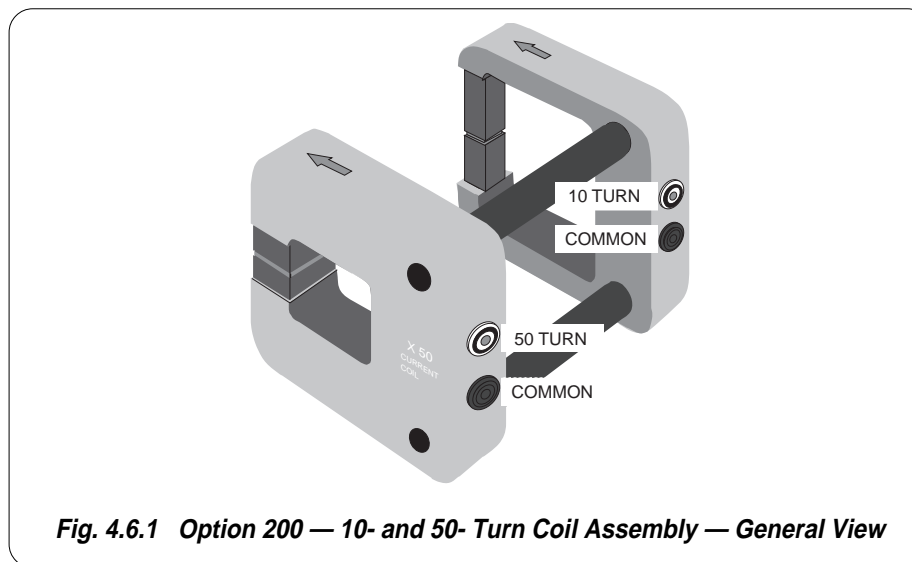

Fig. 4.6.1 Option 200 — 10- and 50- Turn Coil Assembly — General View

Final Width = 215mm

4.6.6 SELECT OUTPUT *(Contd.)*

4.6.6.4 '10 TURN COIL'

This is the third key from the top. AC Current is output, as in 'Normal Output', via the I+ and I- terminals, with no provision to guard the output.

The facility is intended for use with Option 200: 10- and 50-Turn Current Coils. It is convenient to use the coils in conjunction with the Lead Kit, Model 9105; but it is possible to connect the coils directly to the front panel I+ and I- terminals. For the 9100 '10 TURN' selection, connect the 9100 I- (9105 'LI-' black lead) to the coils 'COM', and the 9100 I+ (9105 'I+ 20A' yellow lead) to the coils '10 TURN'.

The demanded output must be >320mA at the point of selecting the 10-turn coil output for the 9100 to accept the selection.

If the 9100 output terminals are open-circuited, then a compliance error will be reported.

If the magnitude of the total ACI output from the 10-turn coil (including deviation and offset) is not greater than 105A, the 9100 will provide a continuous output.

For a total ACI output with magnitude greater than 105A, the length of time that the output can remain 'ON' is limited by an algorithm:

The total output value is continuously monitored, and the time is counted during which the output is greater than 105A. The maximum time that the output can remain on and greater than 105A is 2 minutes, then its value is reduced by half, and a limit of 105A is imposed. Subsequently, after four times the earlier >105A 'ON' time, the current can once again be raised above 105A.

Resolution Thresholds

The 9100 firmware will prevent entry to 10-turn coil operation unless the active span is between 3.2A and 200A.

The following table shows the spans of output current values against their associated resolutions, using the 10-turn coil:

Absolute Resolution	Span of Values Negative
100μA	03.2001 A to 32.0000 A
1mA	003.201 A to 200.000 A

The same rules governing passage across thresholds and hardware configurations apply as for the normal output.

4.6.6.5 '50 TURN COIL'

This is the bottom key. AC Current is output, as in 'Normal Output', via the I+ and I- terminals, with no provision to guard the output.

The facility is intended for use with Option 200: 10- and 50-Turn Current Coils. It is convenient to use the coils in conjunction with the Lead Kit, Model 9105; but it is possible to connect the coils directly to the front panel I+ and I- terminals. For the 9100 '50 TURN' selection, connect the 9100 I- (9105 'LI-' black lead) to the coils 'COM', and the 9100 I+ (9105 'I+ 20A' yellow lead) to the coils '50 TURN'.

The demanded output must be >320mA at the point of selecting the 50-turn coil output for the 9100 to accept the selection.

If the 9100 output terminals are open-circuited, then a compliance error will be reported.

If the magnitude of the total ACI output from the 50-turn coil (including deviation and offset) is not greater than 525A, the 9100 will provide a continuous output.

For a total ACI output with magnitude greater than 525A, the length of time that the output can remain 'ON' is limited by an algorithm:

The total output value is continuously monitored, and the time is counted during which the output is greater than 525A. The maximum time that the output can remain on and greater than 525A is 2 minutes, then its value is reduced by half, and a limit of 525A is imposed. Subsequently, after four times the earlier >525A 'ON' time, the current can once again be raised above 525A.

Final Width = 215mm

Resolution Thresholds

The 9100 firmware will prevent entry to 50-turn coil operation unless the active span is between 16A and 1000A.

The following table shows the spans of output current values against their associated resolutions, using the 50-turn coil:

Absolute Resolution	Span of Values Negative
100μA	16.0010 A to 32.0000 A
1mA	016.001 A to 320.000 A
10mA	0016.01 A to 1000.00 A

The same rules governing passage across thresholds and hardware configurations apply as for the normal output.

Notes about some Hall-effect Clamp Meters:

These coils have been designed for optimum accuracy and inductance for use with the Model 9100. With some Hall effect clamp meters the increase in inductance, due to the current clamp design, will limit the obtainable 9100 Current/Hertz profile. In some cases, 1000A cannot be reached at higher frequency.

Final Width = 215mm

4.6.7 Amp-Hertz Limits

4.6.7.1 Amp-Hertz Profile (Sinusoidal Waveshape)

The combination of current and frequency of the sinewave output signal is enabled only within the Amp-Hertz product envelope shown in *Fig. 4.6.2*.

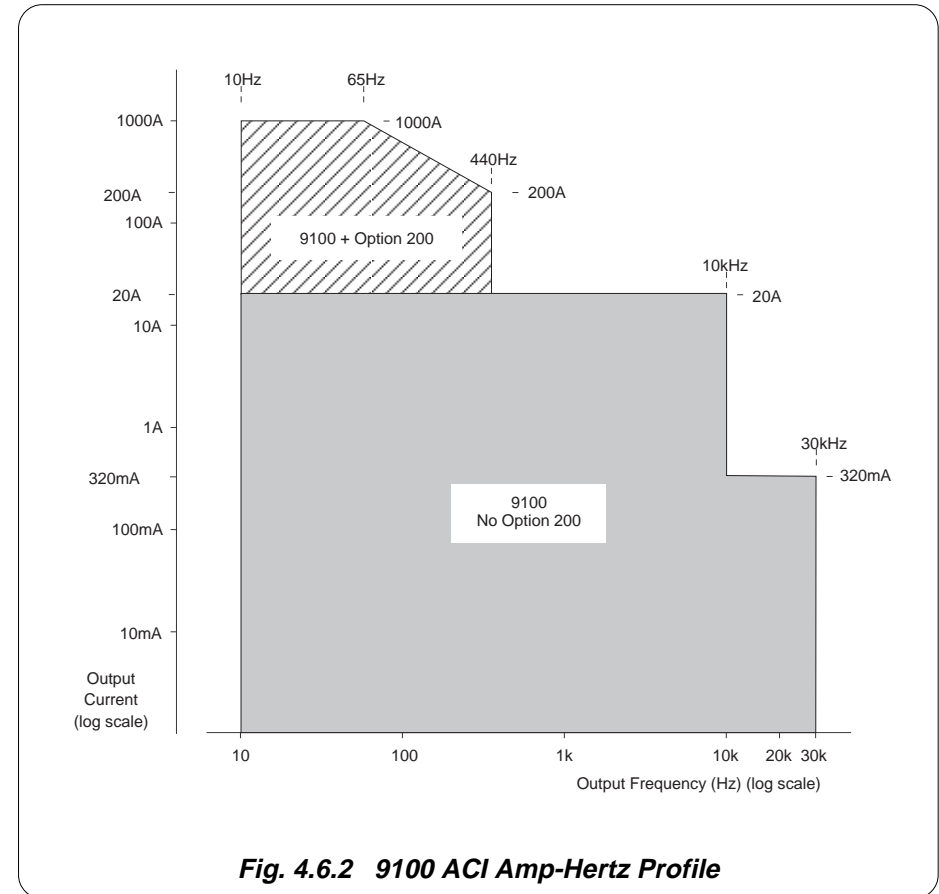

Any attempt to select a combination of current and frequency (including the application of deviations and/or offsets) outside these constraints will not be enabled. An audible warning will be given, accompanied by a screen message:

'Out of range', 'Target too big', or 'Frequency too big'.

If the abortive attempt involves the use of Direct Editing, then a further message **'Error!'** will be placed into the active editing box.

4.6.8 AC Current Routines for Calibrating UUTs

4.6.8.1 Interconnections

The general connection schemes for UUT calibration of AC Current Function are illustrated in *Figs. 4.6.3, 4.6.4 and 4.6.5.*

For UUTs without *safety* banana sockets, use appropriate adaptors.

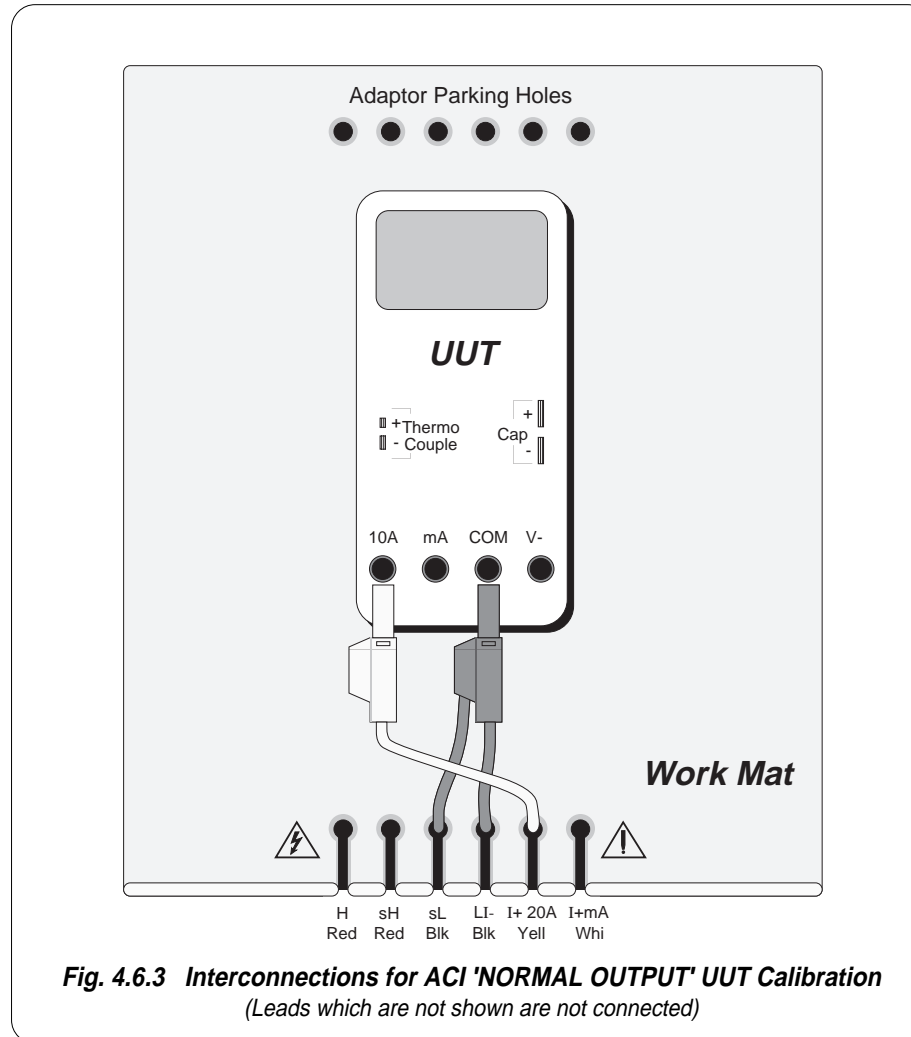

Fig. 4.6.3 Interconnections for ACI 'NORMAL OUTPUT' UUT Calibration
(Leads which are not shown are not connected)

Notes about positioning the current sensing clamp in the center air space of the coils:

The two coils on the assembly have been optimally designed to reduce the effects of stray magnetic fields at the pick-up position for sensor clamps. The design gives characteristics which would normally be associated with central air spaces of much larger area, more closely simulating single-conductor pick-ups.

However, there are several types of clamp meter; some having different requirements for placing the clamp around the pick-up conductor. Manufacturers normally give instructions for aligning the clamp or meter with respect to the conductor. When the meter is clamped to any conductor, errors may arise whose magnitude is similar to the uncertainty of the meter if precautions are not observed, so the manufacturer's instructions should be strictly followed when using the 9100 to calibrate the clamp meter.

To obtain consistent results, in the absence of manufacturer's instructions, the following guidelines should be observed:

- *Fig 4.6.6.* With the coils located on a non-magnetic surface (not the work mat, as it has a steel core), place the clamp in position so that it surrounds the vertical arm of the coil. Keep the clamp mid-way up the vertical arm, and away from the corners.
- *Fig 4.6.7.* Place the vertical arm of the coil, as far as is possible, in the center of the air space of the clamp. Align the center axis of the meter along the plane of the coil itself.
- During later normal measurements using the clamp meter, place the clamp in the same position with respect to the pick-up conductor as it was when being calibrated.

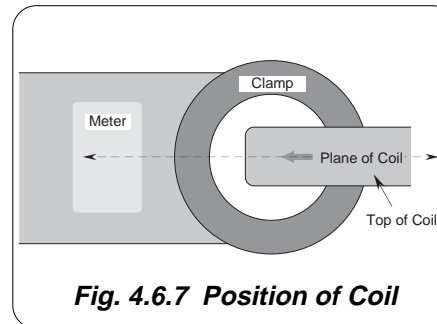
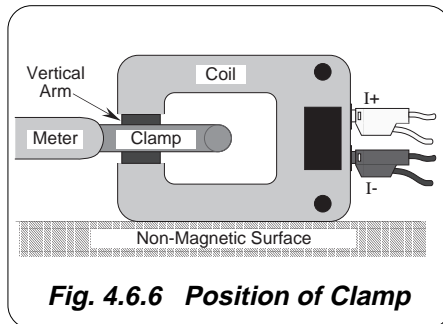
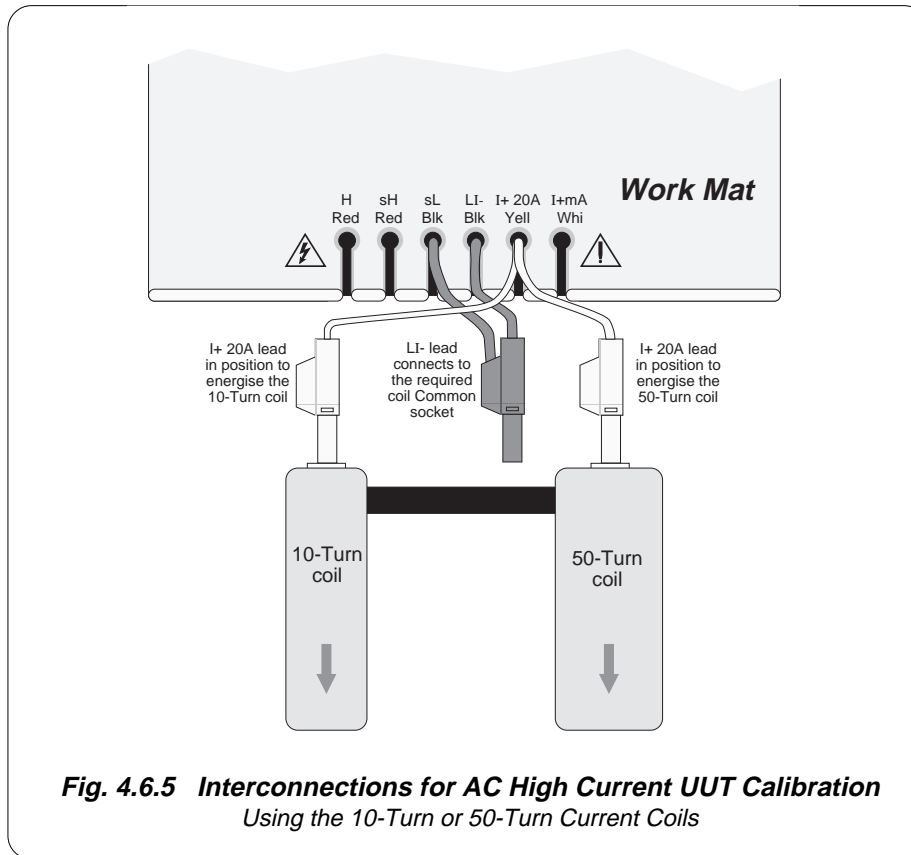

4.6.8.2 Using the 9100 as a Fixed Source

The following procedure assumes that the instrument is in Manual Mode. In the case of difficulty, re-read *Section 3; sub-section 3.3.1*. Familiarity with the methods of editing screen values is also assumed (*Section 3*).

9100 and UUT Setup

1. **Connections** Connect the 9100 to the UUT as shown in *Fig. 4.6.3* (Normal Output), *4.6.4* (Aux Output) or *4.6.5* (Current Coil Output), and ensure that both instruments are powered ON and warmed up.
2. **UUT** Select AC Current function.
3. **9100** a. Ensure that the 9100 is in AC Current Function with Output OFF. If in any other function, press the 'A' key on the right of the front panel, then press the  A screen key.

Sequence of Operations

Refer to the table or list of UUT calibration points in the *UUT Manufacturer's Calibration Guide*.

Follow the correct sequence of calibration stages as directed by the guide, and carry out the following operations (1) to (5) at each stage.

1. **9100** a. Use the front panel controls to set the 9100 Output to the UUT cal point frequency, current and output (SELECT OUTPUT key). Reconnect (*Fig. 4.6.3, 4.6.4 or 4.6.5*) as required.
b. Select the required waveform and phase-shift.
2. **UUT** Select the correct range for the cal point.
3. **9100** a. Set Output **ON**.
b. Note the UUT reading.
4. **UUT** a. If a UUT calibration adjustment is provided, adjust the UUT reading to be equal to that on the 9100 screen, as detailed in the *UUT Manufacturer's Calibration Guide*.
b. If no adjustment is provided on the UUT, record the UUT reading at the calibration point as detailed in the *UUT Manufacturer's Calibration Guide*.
5. **9100** Set Output **OFF**.

4.6.8.3 Using the 9100 as an Adjustable Source

The following procedure assumes that the instrument is in Manual Mode. In the case of difficulty, re-read *sub-section 3.3.1*. Familiarity with the methods of editing screen values is also assumed (*Section 3*).

Calibration Setup

1. **Connections** Connect the 9100 to the UUT as shown in *Fig. 4.6.3* (Normal Output), *4.6.4* (Aux Output) or *4.6.5* (Current Coil Output), and ensure that both instruments are powered ON and warmed up.
2. **UUT** Select AC Current function.
3. **9100** a. Ensure that the 9100 is in AC Current Function with Output OFF. If in any other function, press the 'A' key on the right of the front panel, then press the \sim A screen key.

Sequence of Operations

Refer to the table of UUT calibration points in the *UUT Manufacturer's Calibration Guide*. Follow the correct sequence of calibration stages as directed by the guide, and carry out the following operations (1) to (5) at each stage.

1. **9100** a. Use the front panel controls to set the 9100 Output to the UUT cal point frequency, current and output (SELECT OUTPUT key). Reconnect (*Fig. 4.6.3, 4.6.4 or 4.6.5*) as required.
b. Select the required waveform and phase-shift.
2. **UUT** Select the correct range for the cal point.
3. **9100** a. Set Output ON.
b. Slew the AC Current Output reading until the UUT reading is equal to the calibration point value.
4. **UUT** Record the 9100 screen output value as detailed in the *UUT Manufacturer's Calibration Guide*.
5. **9100** Set Output OFF.

4.7 Resistance Function — Operation

4.7.1

This sub-section is a guide to the use of the 9100 for generating a required Resistance output. The following topics are covered:

- 4.7.2 Selection of Resistance Function.
 - 4.7.2.1 'Ω' Key.
 - 4.7.2.2 Default Settings.
- 4.7.3 Screen Keys.
 - 4.7.3.1 Bottom Screen Keys.
 - 4.7.3.2 Right Side Screen Keys.
 - 4.7.3.3 Introducing Deviation and Offset Values.
- 4.7.4 Value Editing.
 - 4.7.4.1 Output, Offset and Deviation.
- 4.7.5 Crossing Thresholds.
 - 4.7.5.1 Resistance Resolution Thresholds.
 - 4.7.5.2 Hardware Configurations.
 - 4.7.5.3 Configuration for Resistance Measurement in UUTs.
 - 4.7.5.4 Configuration for Resistance Function in the 9100.
 - 4.7.5.5 4-Wire Connections for Resistance Function.
 - 4.7.5.6 2-Wire Connection
 - 4.7.5.7 Spans of Source Currents.
- 4.7.6 Resistance Routines for Calibrating UUTs.
 - 4.7.6.1 Interconnections
 - 4.7.6.2 Using the 9100 as a Fixed Source
 - 4.7.6.3 Using the 9100 as an Adjustable Source

Final Width = 215mm

In this sub-section, we deal with the full range of Ohms facilities, in a concise way. For those who require more detailed instructions for manipulating the front panel controls, the DC Voltage function was used as an example for the general familiarization tutorials in *Section 3*, and this may provide an introduction to the function.

4.7.2 Selection of Resistance Function

(Manual Mode selected)

4.7.2.1 'Ω' Key

Resistance is selected by pressing the 'Ω' key at the right of the 'CALIBRATION SYSTEM' panel.

4.7.2.2 Default Settings

At power-on, the system defaults into DC Voltage function. Each time the Ω key is pressed, the system defaults into Resistance function.

Whenever the Resistance menu screen is opened, except on recovery from a standby period, it will appear with the following default settings:

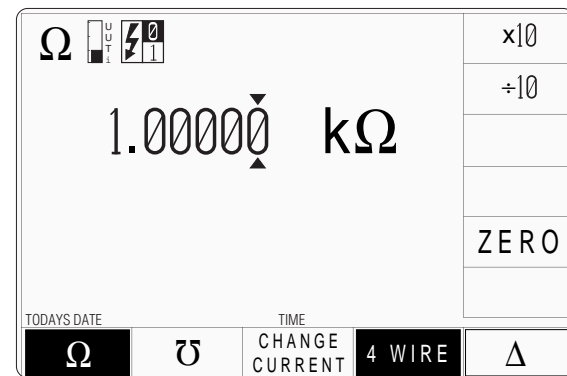

Final Width = 215mm

4.7.3 Screen Keys

4.7.3.1 Bottom Screen Keys

- Ω Selects Resistance function. The default condition accepts Low constant source currents with 4-wire connections.
- \Uparrow Selects Conductance function. *Refer to sub-section 4.8.*
- CHANGE CURRENT** Scales the analog circuitry to accept alternative constant source currents. *Refer to paras 4.7.5.7.*
- 4 WIRE** Connects the analog circuitry as a 4-wire source when selected, and a 2-wire source when deselected. Default condition is 'selected'. The screen key operates as toggle-on / toggle off. *Refer to paras 4.7.5.4 to 4.7.5.6.*
- Δ Accesses the 'Percentage Deviation' and 'Resistance Offset' displays to add to the screen presentation. *Refer to paras 4.7.3.3 and 4.7.4.1.*

4.7.3.2 Right Side Screen Keys

A. Digit Edit Facility Keys operate on the value marked by the cursor.

- X10** Multiplies the marked value by ten.
- $\div 10$** Divides the marked value by ten.
- ZERO** Sets the marked value to zero.
- \pm Inverts the polarity of the marked deviation or offset value.

B. Direct Edit Facility Right side keys operate on the value in the edit box, and acting in place of the \downarrow key, exit from Direct Edit back to Digit Edit and set the value as evaluated in the box.

i. Output Value and Offset Value

- Ω Evaluates the number in the box in **Ohms**.
- k Ω** Evaluates the number in the box in **Kilohms**.
- M Ω** Evaluates the number in the box in **Megohms**.

ii. Deviation Value

- %** Evaluates the number in the box in **Percentage Deviation**.
The Deviation value is limited to $\pm 10\%$ of the Output value.

Output and Offset values are set into the same resolution. All values are set into the highest resolution available to their magnitude.

Final Width = 215mm

Final Width = 215mm

4.7.3 Screen Keys (Contd.)

4.7.3.3 Introducing Deviation and Offset Values

Pressing the ' Δ ' key (bottom row) presents a screen with $\Delta\%$ and $\Delta\Omega$ labelling the two top right screen keys:

Pressing the ' $\Delta\%$ ' screen key adds the 'Percentage Deviation' value to the lower left of the display presentation and the screen reverts to the main Ohms display as shown below. The Deviation value is limited to $\pm 10\%$ of the Output value.

Pressing the ' $\Delta\Omega$ ' screen key adds the 'Resistance Offset' value to the lower right of the display presentation and the screen reverts to the main Ohms display as shown below.

Note that as each of the ' Δ ' keys is pressed to show its value on the screen, the cursors will move to the latest selection.

The main Ohms display is shown here with both $\Delta\%$ and $\Delta\Omega$ additions in place. This would require two separate operations of the Δ key on the bottom row, as after each selection, the screen reverts to the main display. After reversion, the cursors can be transferred to any of the displayed values for editing, here shown on the main output display. Otherwise, the operation of the editing keys is unchanged (*paras* 4.7.3.2), and direct editing can also be used.

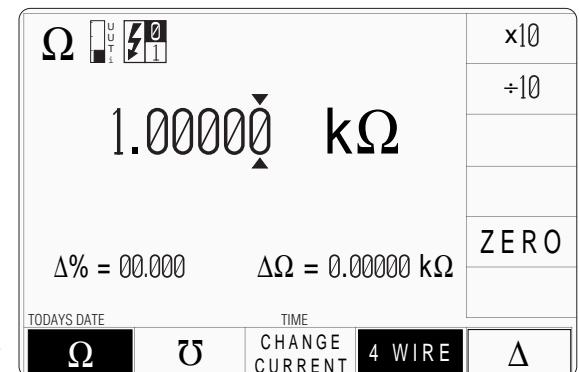
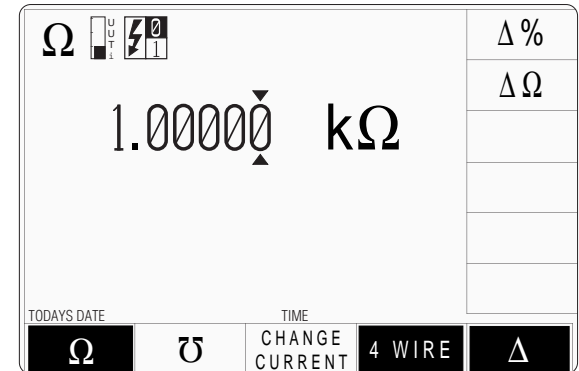

4.7.4 Value Editing

4.7.4.1 Output, Offset and Deviation

The Output, Offset and Deviation values can be changed using 'Digit' and 'Direct' edit facilities as described in *Section 3*. Selection of $\Delta\%$ and $\Delta\Omega$ is described in *paras 4.7.3.3*.

Offset Values

The effect of introducing a non-zero offset value is to change all set values of the output by that of the offset. A positive offset will increase the output resistance value, and a negative offset will decrease the output resistance value.

For example:

- a. A set Output Value of $10\text{k}\Omega$ with a $+1\text{k}\Omega$ Offset will be output as $11\text{k}\Omega$.
- b. A set Output Value of 40Ω with a -10Ω Offset will be output as 30Ω .
- c. A set Output Value of $100\text{k}\Omega$ with a $-300\text{k}\Omega$ Offset will not be enabled.

Deviation Percentage Values

The effect of introducing a non-zero deviation value is to change all set values of the output by the fraction expressed by the deviation. A positive deviation will increase, and a negative deviation will reduce, the output resistance value.

For example:

- a. An Output Value of $10\text{k}\Omega$ set on the display, will be increased to $10.5\text{k}\Omega$ by a $+5\%$ Deviation.
- b. A -10% Deviation will reduce an Output Value of $50\text{M}\Omega$ set on the display, to $45\text{M}\Omega$.

Combined Deviation Percentage and Offset

Deviation and Offset values are combined by first applying the deviation, then the offset, to the output value in the form $y = (1 + m/100)x + c$, where:

y is the terminal resistance; x is the set output resistance; m is the set deviation percentage; c is the set offset resistance.

For example:

- a. Set Values: Output = $10\text{k}\Omega$ Deviation = $+5\%$ Offset = $+3\text{k}\Omega$.
Terminal Resistance will be:
 $[(1 + 5/100) \times 10\text{k}\Omega] + (+3\text{k}\Omega) = [1.05 \times 10\text{k}\Omega] + 3\text{k}\Omega = 13.5\text{k}\Omega$
- b. Set Values: Output = 40Ω Deviation = -10% Offset = -30Ω .
Terminal Resistance will be:
 $[(1 - 10/100) \times 40\Omega] + (-30\Omega) = [0.9 \times 40\Omega] - 30\Omega = 6\Omega$

Final Width = 215mm

Final Width = 215mm

4.7.5 Crossing Thresholds

4.7.5.1 Resistance Resolution Thresholds

The different resolutions are distinguished by two characteristics:

- Maximum and minimum values available.
- Absolute resolution of the least-significant digit.

The following table shows the spans of output values for the Resistance function, against their associated resolutions.

Absolute Resolution	Span of Values	Nominal Span Value
0.1m Ω	00.0000 Ω to 40.0000 Ω	40 Ω
1m Ω	000.000 Ω to 400.000 Ω	400 Ω
10m Ω	0.00000 k Ω to 4.00000 k Ω	4k Ω
100m Ω	00.0000 k Ω to 40.0000 k Ω	40k Ω
1 Ω	000.000 k Ω to 400.000 k Ω	400k Ω
10 Ω	0.00000 M Ω to 4.00000 M Ω	4M Ω
100 Ω	00.0000 M Ω to 40.0000 M Ω	40M Ω
1k Ω	000.000 M Ω to 400.000 M Ω	400M Ω

Rules, built into firmware, govern passage across thresholds between resolutions:

Increasing Output or Offset Resistance

Using the \curvearrowright key in Digit Edit facility; an audible warning will be given if the new value is too large for the present span of values, with a reminder ('Up range required') on the screen. The user must change to the next lower resolution, with a larger span of values, using the \curvearrowleft key. This rule applies whether OUTPUT is OFF or ON.

When using either the X10 screen key or the Direct Edit facility; if the new value is too large for the present resolution, a lower resolution will be activated with a larger span of values. No warning will be given. This rule applies whether OUTPUT is OFF or ON.

Decreasing Output or Offset Resistance

Using Digit Edit; values down to zero lie within all spans. If the required value lies between steps of the present resolution, the user must increase resolution using the \curvearrowright key, also reducing the span of values. This rule applies whether OUTPUT is OFF or ON.

Using either the +10 screen key or Direct Editing; if the required value lies between increments of the present resolution, a greater resolution will be activated with reduced span. No warning will be given. This rule applies whether OUTPUT is OFF or ON.

4.7.5.2 Hardware Configurations

When increasing or decreasing output resistance, using any method: if the new resistance is too large or small for the present hardware configuration, then if OUTPUT is OFF there will be no noticeable effect as the hardware reconfigures.

If OUTPUT is ON, the new hardware will be reconfigured as quickly as possible to minimize the disturbance to autoranging UUTs.

When moving from one hardware configuration to another, the 9100 will automatically select the 'best' current setting for the new output value, based on the previous current setting.

4.7.5.3 Configuration for Resistance Measurement in UUTs

Instruments which measure resistance generally use a method which drives a 'pseudo-constant' current (I_r) through the test circuit (usually a resistor) and measures the voltage (V_r) developed across it. Internal circuits then calculate the resistance digitally, using a form of Ohm's Law:

$$R = V/I$$

The 9100 assumes that this form of measurement is employed by the UUT. A simplified illustration is shown in *Fig. 4.7.1*:

Final Width = 215mm

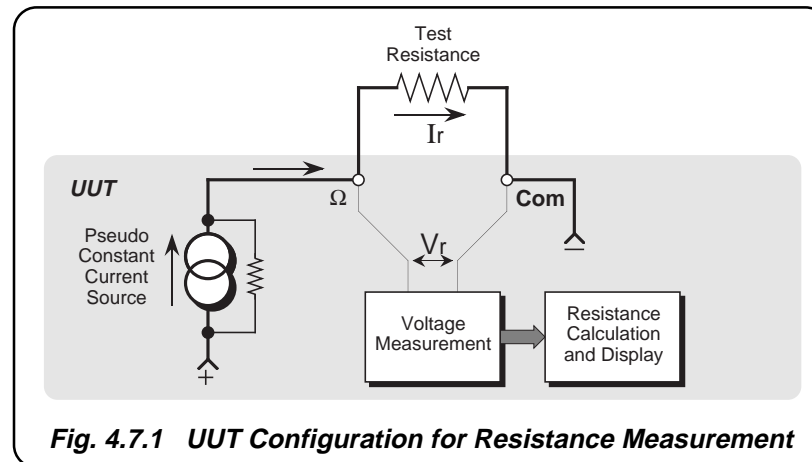

Fig. 4.7.1 UUT Configuration for Resistance Measurement

Note that because I_r passes through external test leads connecting the resistor to the terminals, the voltage sensed across the terminals will include the lead volts drops, so the result here will also include the resistance of the external leads.

Final Width = 215mm

4.7.5.4 Configuration for Resistance Function in the 9100

The 9100 uses 'Active Impedance' technology to output a 'Virtual Resistance'. The method relies on the UUT having a form of measurement illustrated by *Fig. 4.7.1*.

The 9100 will produce a DC voltage (V_R) in response to a DC current (I_R) being sourced from the UUT. The value of the voltage is derived electronically from the value of the I_R multiplied by the Total Resistance Demand value (R_T) set on the display (including the variation due to offset and deviation settings): $V_R = I_R \times R_T$.

The effect is that of placing a resistor of value R_T (Virtual Resistance) between the front panel Hi and Lo terminals of the 9100. The method is shown in *Fig. 4.7.2*.

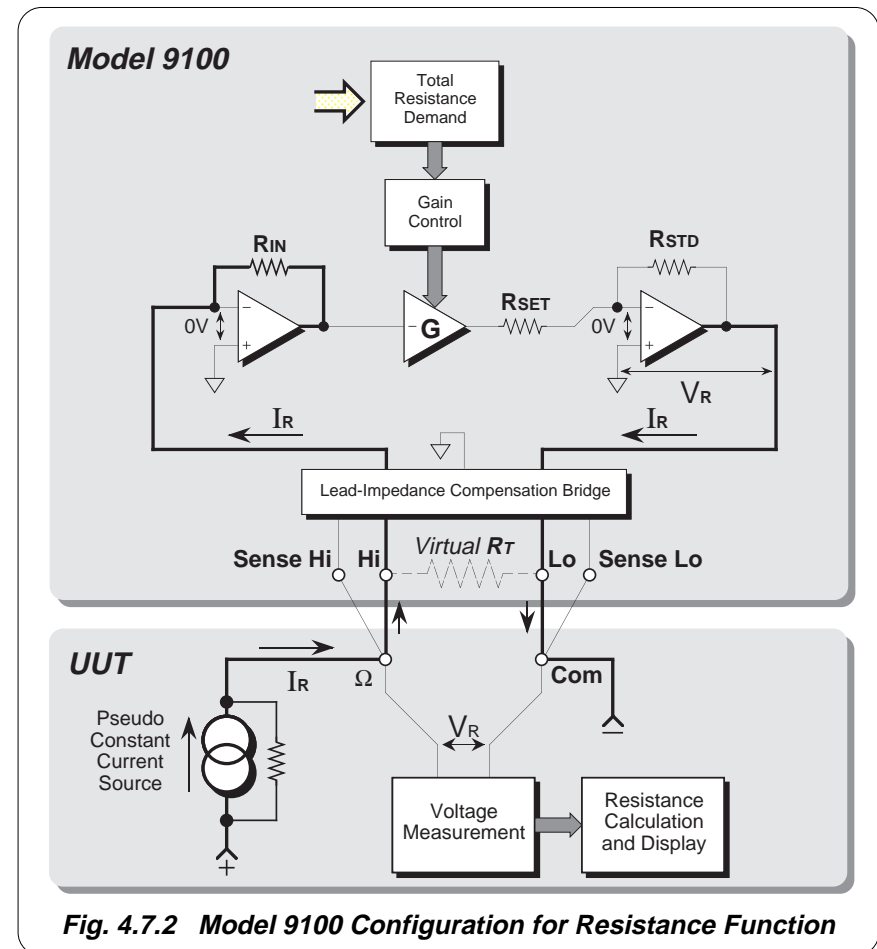

Fig. 4.7.2 Model 9100 Configuration for Resistance Function

Resistance Function Action

The UUT drives the current I_R through R_{IN} via the Hi terminal, and draws I_R out via the Lo terminal. The value of R_{IN} can be one of eight possible values, selected automatically to accommodate the value of current I_R . This first stage acts as a current-to-voltage converter, whose output is a negative DC voltage of value $I_R \times R_{IN}$, with respect to the virtual ground at the converter input. This voltage is presented as input to the gain-control amplifier '-G'.

The system gain is set by the Total Resistance Demand value (R_T) transferred by DAC to control the gain of amplifier '-G'. The final amplifier is switched by R_{STD} and R_{SET} in decade values. It generates a negative DC output voltage V_R , equal to $I_R \times R_T$, across the Hi and Lo terminals; while sourcing the current I_R drawn by the UUT from the Lo terminal.

The value of the virtual resistance R_T is given by: $R_T = R_{IN} \times G \times R_{STD} / R_{SET}$

4.7.5.5 4-Wire Connections for Resistance Function

In order to protect the 9100 output, fuses and low-value protection resistors are placed internally in series with each of the current-carrying wires. Also, as noted earlier, the external current-carrying wires have their own resistance. The Lead-Impedance Compensation Bridge is used to compensate for these impedances between the voltage V_R and the UUT input. The 9100 is protected against excessive current to ground. If this occurs the output is switched off.

In *Fig. 4.7.2*, the 9100 and UUT are shown in 4-wire connection. One pair of wires passes I_R (Hi and Lo at the 9100), while the second pair (Hi Sense and Lo Sense) senses the voltage at the UUT input terminals.

The bridge receives the sensed voltage from the UUT terminals. If this is not exactly the same as V_R , the bridge compensates for any volts drops in the protection circuitry and interconnecting leads, maintaining V_R at the UUT input.

It is **most important** that a four-wire connection be used for Resistance function. The Model 9105 leadset, supplied with the 9100, provides a four-wire connection. It is recommended that the leadset be fitted, using its four short banana leads, whenever the 9100 is being used in Resistance function.

When a four-wire connection is being used, the '**4 WIRE**' screen key beneath the 9100 LCD display should be selected (light characters on dark background). Four-wire operation is already selected in the default condition of Ω function.

Refer to *pages 4.7-2/3*.

Caution:

Unacceptable errors occur when 2-wire connections are being used, with 4-wire selected.

Final Width = 215mm

Final Width = 215mm

4.7.5.6 2-Wire Connection

If it is deemed absolutely necessary to use a two wire connection, the 9100 should be informed by de-selecting '4 WIRE'. As illustrated in Fig.4.7.3, the 9100 will then permanently short Hi to Hi Sense, and Lo to Lo Sense, so that at least the internal protection circuitry is compensated. Measurements made by the UUT will, of course, still include the resistance of the two interconnecting leads. *Do not use 2-wire connections when '4 WIRE' is selected on the 9100.*

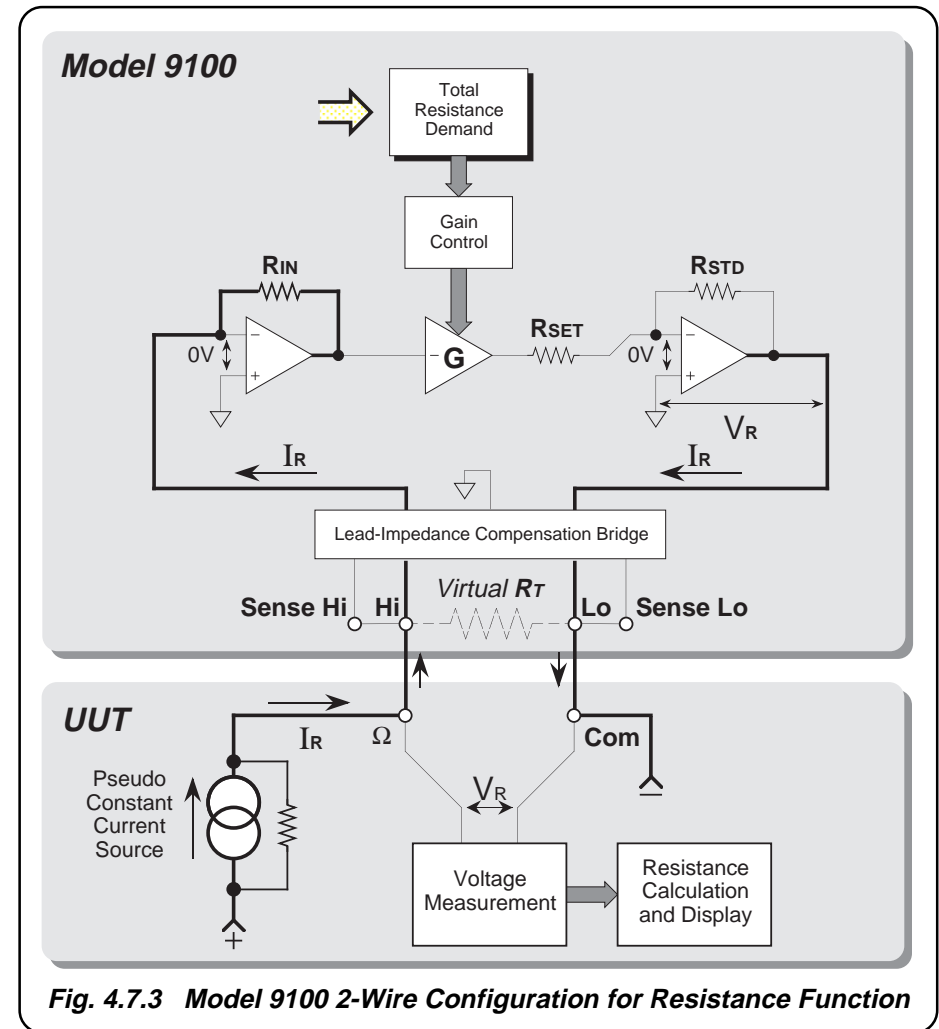

4.7.5.7 Spans of Source Currents

In the synthesized resistance technology used in the 9100, the constant current sourced from the UUT must fall within a maximum of three spans of values for each dialled resistance value. The spans of constant source currents acceptable to the 9100, are shown against their corresponding spans of output resistance in the following table:

Hardware Configuration Limits on Span of Output Resistance	Constant Source Current Limits		
	UUTi Low	UUTi High	UUTi Super
00.0000 Ω to 40.0000 Ω	250μA to 3.5mA	2.5mA to 35mA	25mA to 350mA
040.001 Ω to 400.000 Ω	25μA to 320μA	250μA to 3.5mA	2.5mA to 35mA
0.40001 kΩ to 4.00000 kΩ	25μA to 320μA	250μA to 3.5mA	2.5mA to 35mA
04.0001 kΩ to 40.0000 kΩ	2.5μA to 32μA	25μA to 350μA	250μA to 3.5mA
040.001 kΩ to 400.000 kΩ	250nA to 3.2μA	2.5μA to 35μA	25μA to 350μA
0.40001 MΩ to 4.00000 MΩ	25nA to 320nA	250nA to 3.5μA	2.5μA to 35μA
04.0001 MΩ to 40.0000 MΩ	8nA to 32nA	25nA to 350nA	250nA to 3.5μA
040.001 MΩ to 400.000 MΩ	4nA to 32nA	25nA to 200nA	N/A

When the Ohms function is entered from another function, the default resistance setting is 1kΩ, coupled with the default current span of 'UUTi Low'. As the resistance span is altered within Ohms function, the 9100 will default to the current span nearest to that previously in use. For instance, when using the X10 screen key to increase the output setting from 2kΩ — UUTi high current span (250μA to 3.5mA), the 9100 will automatically select 20kΩ — super current span (250μA to 3.5mA). If a different Current span is required, it will be necessary to select it manually by pressing the **CHANGE CURRENT** screen key until the chosen span is selected (*refer to pages 4.7-2/3*). The indications given on the screen for the three different spans are as follows:

Final Width = 215mm

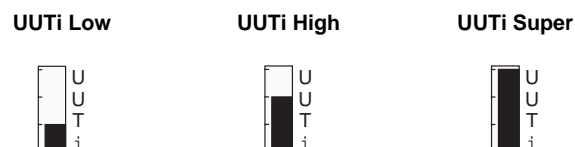

Output Voltage Limitation

At any UUTi span, the 9100 will seek a suitable configuration of hardware to accommodate both the value of source current within the limits, and the value of resistance set as Output Value. The maximum nominal output voltage is 10V, such that: $I_R \times R_T = \leq 10V$.

Any Resistance value within the total span can be selected. However, if the source current exceeds the upper limit of the selected span, the circuit will be saturated, and a warning will be given. Also, a warning will be given if the source current is less than the lower limit. When a warning appears, the instrument will still function, but the specification will be compromised. In the 0Ω to 40Ω configuration, low current warnings will not be given as this configuration may be used as a zero point for all Resistance configurations.

Always choose the lowest possible UUTi setting at which no 'Sense current high' warning appears; i.e. if a warning is given on a particular UUTi span, work up to use the first span at which the warning disappears. Normally the 9100 toggles between just two of the three possible settings. To force the third setting: turn the output off, make your selection, then turn the output back on.

Final Width = 215mm

4.7.6 Resistance Routines for Calibrating UUTs

4.7.6.1 Interconnections

The general connection scheme for UUT calibration is illustrated in *Fig. 4.7.4*. The use of either 4-wire remote sensing at the UUT terminals, or 2-wire local sensing at the 9100 terminals, is served by the same connections from the 9105 at the work mat. Selection of 2/4-wire is carried out on the 9100 front panel.

For UUTs without *safety* banana sockets, use appropriate adaptors.

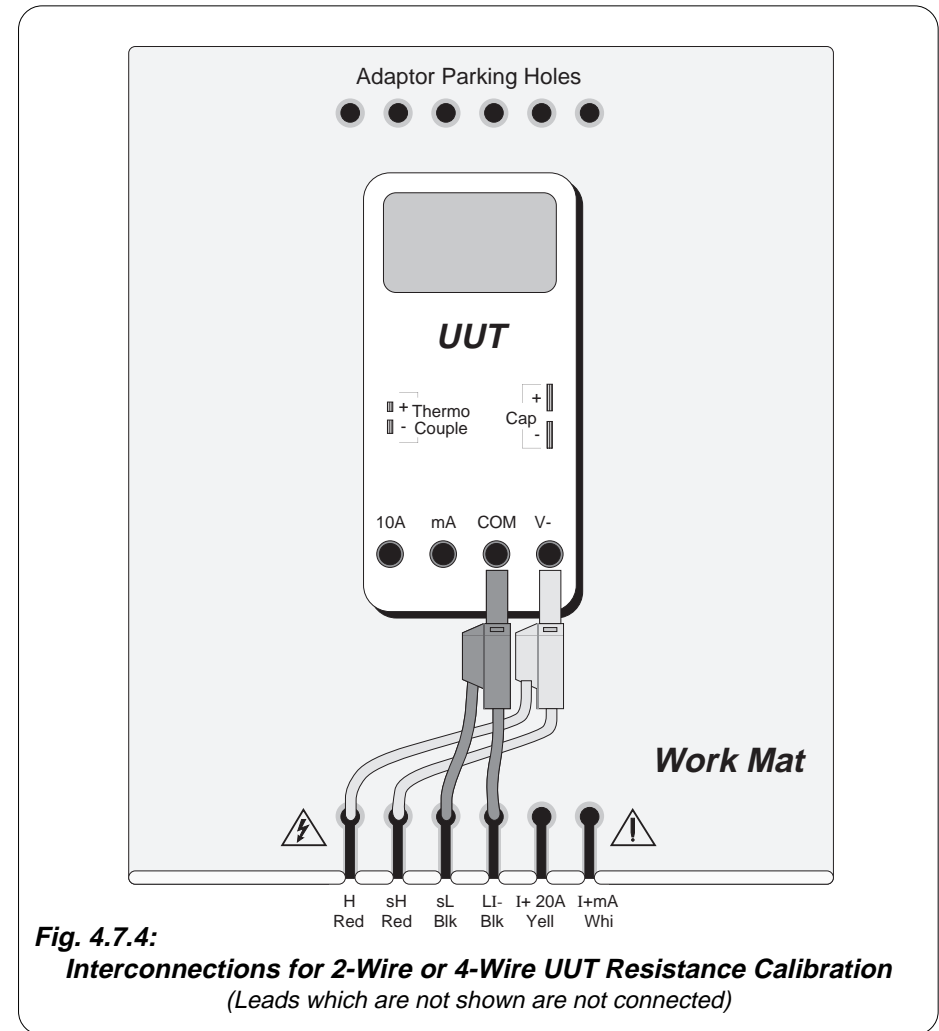

4.7.6.2 Using the 9100 as a Fixed Source

The following procedure assumes that the instrument is in Manual Mode. In the case of difficulty, re-read *Section 3; sub-section 3.3.1*. Familiarity with the methods of editing screen values is also assumed (*Section 3*).

9100 and UUT Setup

1. **Connections** Connect the 9100 to the UUT as shown in *Fig. 4.7.4*, and ensure that both instruments are powered ON and warmed up.
2. **UUT** Select Resistance function.
3. **9100** Ensure that the 9100 is in Resistance Function with Output OFF. If in any other function, press the Ω key on the front panel.

Sequence of Operations

Refer to the table or list of UUT calibration points in the *UUT Manufacturer's Calibration Guide* for the UUT.

Follow the correct sequence of calibration stages as directed by the guide, and carry out the following operations (1) to (5) at each stage.

1. **9100** Consult the *UUT Manufacturer's Calibration Guide* to determine the requirements for source current and 2/4 wire connection. Refer to the table in paras 4.7.5.7, and use the front panel controls to set the 9100 Output resistance to the UUT cal point value, selecting 2-Wire or 4-Wire and Source Current span as required.
2. **UUT** Select the correct range for the cal point.
3. **9100**
 - a. Set Output **ON**.
 - b. Note the UUT reading.
4. **UUT**
 - a. If a UUT calibration adjustment is provided, adjust the UUT reading to be equal to that on the 9100 screen, as detailed in the *UUT Manufacturer's Calibration Guide*.
 - b. If no adjustment is provided on the UUT, record the UUT reading at the calibration point as detailed in the *UUT Manufacturer's Calibration Guide*.
5. **9100** Set Output **OFF**.

Final Width = 215mm

Final Width = 215mm

4.7.6.3 Using the 9100 as an Adjustable Source

The following procedure assumes that the instrument is in Manual Mode. In the case of difficulty, re-read *sub-section 3.3.1*. Familiarity with the methods of editing screen values is also assumed (*Section 3*).

9100 and UUT Setup

1. **Connections** Connect the 9100 to the UUT as shown in *Fig. 4.7.4*, and ensure that both instruments are powered ON and warmed up.
2. **UUT** Select Resistance function.
3. **9100** Ensure that the 9100 is in Resistance Function with Output OFF. If in any other function, press the ' Ω ' key on the right of the front panel.

Sequence of Operations

Refer to the table of UUT calibration points in the *UUT Manufacturer's Calibration Guide*. Follow the correct sequence of calibration stages as directed by the guide, and carry out the following operations (**1**) to (**5**) at each stage.

1. **9100** Consult the *UUT Manufacturer's Calibration Guide* to determine the requirements for source current and 2/4 wire connection. Refer to the table in paras 4.7.5.7, and use the front panel controls to set the 9100 Output resistance to the UUT cal point value, selecting 2-Wire or 4-Wire and Source Current span as required.
2. **UUT** Select the correct range for the cal point.
3. **9100**
 - a. Set Output **ON**.
 - b. Slew the Resistance Output reading until the UUT reading is equal to the calibration point value.
4. **UUT** Record the 9100 screen output value as detailed in the *UUT Manufacturer's Calibration Guide*.
5. **9100** Set Output **OFF**.

4.8 Conductance Function — Operation

4.8.1

This sub-section is a guide to the use of the 9100 for generating a required Conductance output. The following topics are covered:

- 4.8.2 Selection of Conductance Function.
 - 4.8.2.1 'Aux' Key.
 - 4.8.2.2 Default Settings.
- 4.8.3 Screen Keys.
 - 4.8.3.1 Bottom Screen Keys.
 - 4.8.3.2 Right Side Screen Keys.
 - 4.8.3.3 Introducing Deviation and Offset Values.
- 4.8.4 Value Editing.
 - 4.8.4.1 Output, Offset and Deviation.
- 4.8.5 Crossing Thresholds.
 - 4.8.5.1 Conductance Resolution Thresholds.
 - 4.8.5.2 Hardware Configurations.
 - 4.8.5.3 Configuration for Conductance Measurement in UUTs.
 - 4.8.5.4 Configuration for Conductance Function in the 9100.
 - 4.8.5.5 4-Wire Connections for Conductance Function.
 - 4.8.5.6 Two-Wire Connection.
 - 4.8.5.7 Spans of Source Currents.
- 4.8.6 Conductance Routines for Calibrating UUTs.
 - 4.8.6.1 Interconnections.
 - 4.8.6.2 Using the 9100 as a Fixed Source.
 - 4.8.6.3 Using the 9100 as an Adjustable Source.

Final Width = 215mm

In this sub-section, we deal with the full range of Conductance facilities, in a concise way. For those who require more detailed instructions for manipulating the front panel controls, the DC Voltage function was used as an example for the general familiarization tutorials in *Section 3*, and this may provide an introduction to the function.

Final Width = 215mm

4.8.2 Selection of Conductance Function

(Manual Mode selected)

4.8.2.1 'Ω' Key

Conductance is associated with the 'Ohms' function. The Ohms menu screen is selected by pressing the 'Ω' key at the right of the 'CALIBRATION SYSTEM' panel. Conductance is selected by pressing the $\bar{\cup}$ screen key on the bottom row.

4.8.2.2 Default Settings

At power-on, the system defaults into DC Voltage function. Each time the 'Ω' key is pressed, the system defaults into Ohms function.

Whenever the Conductance menu screen is opened by pressing the $\bar{\cup}$ screen key on the Ohms menu screen, except on recovery from a standby period, it will appear with the following default settings:

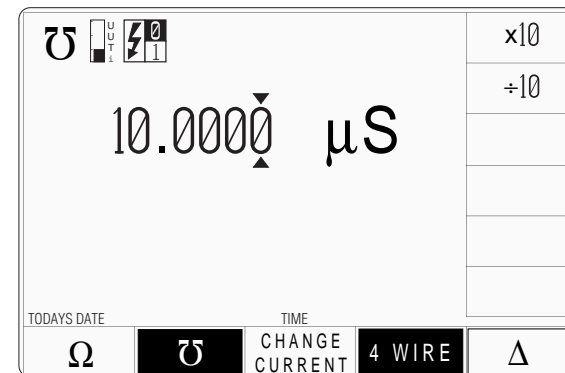

4.8.3 Screen Keys

4.8.3.1 Bottom Screen Keys

- $\bar{\cup}$ Selects Conductance function. The default condition accepts constant source currents with 4-wire connections.
- Ω Selects Resistance function. *Refer to sub-section 4.7.*

The following four keys operate as toggle-on / toggle off:

- CHANGE CURRENT** Scales the analog circuitry to accept alternative constant source currents. *Refer to paras 4.8.5.7.*
- 4WIRE** Connects the analog circuitry as a 4-wire source when selected, and a 2-wire source when deselected. Default condition is 'selected'. The screen key operates as toggle-on / toggle off. *Refer to paras 4.8.5.4 to 4.8.5.6..*
- Δ Accesses the 'Percentage Deviation' and 'Resistance Offset' displays to add to the screen presentation. *Refer to paras 4.8.3.3 and 4.8.4.1.*

4.8.3.2 Right Side Screen Keys

A. Digit Edit Facility Keys operate on the value marked by the cursor.

Final Width = 215mm

- X10** Multiplies the marked value by ten.
- $\div 10$** Divides the marked value by ten.
- \pm** Inverts the polarity of the marked deviation or offset value.

B. Direct Edit Facility Right side keys operate on the value in the edit box, and acting in place of the \downarrow key, exit from Direct Edit back to Digit Edit, setting the value as evaluated in the box.

i. Output Value and Offset Value

- nS** Evaluates the number in the box in **Nanosiemens**.
- μ S** Evaluates the number in the box in **Microsiemens**.
- mS** Evaluates the number in the box in **Millisiemens**.

ii. Deviation Value

- %** Evaluates the number in the box in **Percentage Deviation**. The Deviation value is limited to $\pm 10\%$ of the Output value.

Output and Offset values are set into the same resolution. All values are set into the highest resolution available to their magnitude.

Final Width = 215mm

4.8.3 Screen Keys (Contd.)

4.8.3.3 Introducing Deviation and Offset Values

Pressing the ' Δ ' key (bottom row) presents a screen with $\Delta\%$ and $\Delta\bar{U}$ labelling the two top right screen keys:

Pressing the ' $\Delta\%$ ' screen key adds the 'Percentage Deviation' value to the lower left of the display presentation and the screen reverts to the main Conductance display as shown below. The Deviation value is limited to $\pm 10\%$ of the Output value.

Pressing the ' $\Delta\bar{U}$ ' screen key adds the 'Conductance Offset' value to the lower right of the display presentation and the screen reverts to the main Conductance display as shown below.

Note that as each of the ' Δ ' keys is pressed to show its value on the screen, the cursors will move to the latest selection.

The main Conductance display is shown here with both $\Delta\%$ and $\Delta\bar{U}$ additions in place. This would require two separate operations of the Δ key on the bottom row, as after each selection, the screen reverts to the main display. After reversion, the cursors can be transferred to any of the displayed values for editing, here shown on the main output display. Otherwise, the operation of the editing keys is unchanged (*paras* 4.8.3.2), and direct editing can also be used.

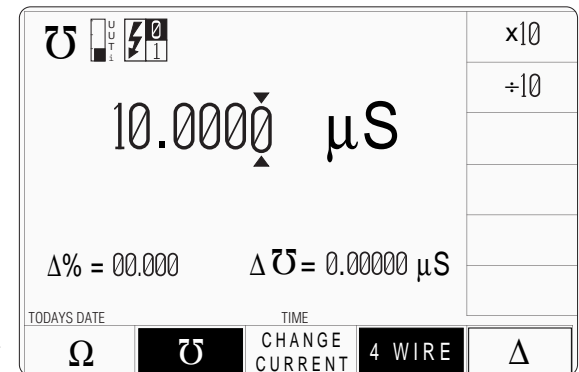
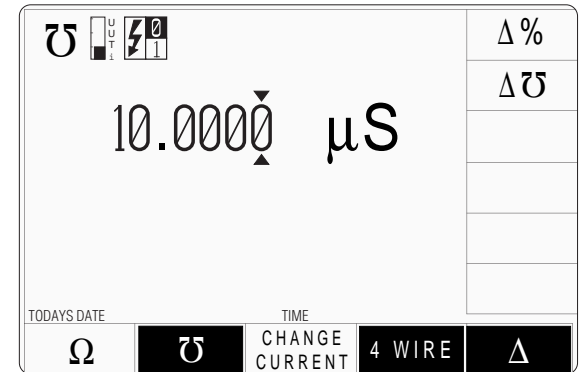

4.8.4 Value Editing

4.8.4.1 Output, Offset and Deviation

The Output, Offset and Deviation values can be edited using 'Digit' and 'Direct' edit facilities as described in *Section 3*.

Offset Values

The effect of introducing a non-zero offset value is to change all set values of the output by that of the offset. A positive offset will increase the output Conductance value, and a negative offset will reduce the output Conductance value.

For example:

- a. A set Output Value of 10 μ S with a +1 μ S Offset will be output as 11 μ S.
- b. A set Output Value of 400nS with a -100nS Offset will be output as 300nS.
- c. A set Output Value of 100nS with a -300nS Offset will not be enabled.

Deviation Percentage Values

The effect of introducing a non-zero deviation value is to change all set values of the output by the fraction expressed by the deviation. A positive deviation will increase, and a negative deviation will reduce, the output Conductance value.

For example:

- a. An Output Value of 10 μ S set on the display, will be increased to 10.5 μ S by a +5% Deviation.
- b. A -10% Deviation will reduce an Output Value of 50 μ S set on the display, to 45 μ S.

Combined Deviation Percentage and Offset

Deviation and Offset values are combined by first applying the deviation, then the offset, to the output value in the form $y = (1 + m/100)x + c$, where:

y is the terminal voltage; **x** is the set output voltage; **m** is the set deviation percentage; **c** is the set offset voltage.

For example:

- a. Set Values: Output = 10nS; Deviation = +5%; Offset = +3nS.
Terminal Voltage will be:
 $[(1 + 5/100) \times 10\text{nS}] + (+3\text{nS}) = [1.05 \times 10\text{nS}] + 3\text{nS} = 13.5\text{nS}$
- b. Set Values: Output = 40 μ S; Deviation = -10%; Offset = -30 μ S.
Terminal Voltage will be:
 $[(1 - 10/100) \times 40\mu\text{S}] + (-30\mu\text{S}) = [0.9 \times 40\mu\text{S}] - 30\mu\text{S} = 6\mu\text{S}$

Final Width = 215mm

Final Width = 215mm

4.8.5 Crossing Thresholds

4.8.5.1 Conductance Resolution Thresholds

The different resolutions are distinguished by two characteristics:

- Maximum and minimum values available.
- Absolute resolution of the least-significant digit.

The following table shows the spans of output values for the Conductance function, against their associated resolutions.

Absolute Resolution	Span of Values
0.1pS	02.5000 nS to 24.9999 nS
1pS	002.500 nS to 249.999 nS
10pS	0.00250 μ S to 2.49999 μ S
100pS	00.0025 μ S to 24.9999 μ S
1nS	000.003 μ S to 249.999 μ S
10nS	0.00001 mS to 2.49999 mS

Rules, built into firmware, govern passage across thresholds between resolutions.

Increasing Output or Offset Conductance

Using the \odot key in Digit Edit facility; an audible warning will be given if the new value is too large for the present span of values, with a reminder (Up range required) on the screen. The user must change to the next lower resolution, with a larger span of values, using the \langle key. This rule applies whether OUTPUT is OFF or ON.

When using either the X10 screen key or the Direct Edit facility; if the new value is too large for the present resolution, a lower resolution will be activated with a larger span of values. No warning will be given. This rule applies whether OUTPUT is OFF or ON.

Decreasing Output or Offset Conductance

Using Digit Edit; values down to the minimum of 2.5nS lie within all spans with resolution of 100pS or better. If the required value lies between steps of the present resolution, the user must increase resolution using the \rangle key, also reducing the span of values. This rule applies whether OUTPUT is OFF or ON.

Using either the $\div 10$ screen key or Direct Editing; if the required value lies between increments of the present resolution, a greater resolution will be activated with reduced span. No warning will be given. This rule applies whether OUTPUT is OFF or ON.

4.8.5.2 Hardware Configurations

When increasing or decreasing output conductance, using any method: if the new conductance is too large or small for the present hardware configuration, then if OUTPUT is OFF there will be no noticeable effect as the hardware reconfigures.

If OUTPUT is ON, the new hardware will be reconfigured as quickly as possible to minimize the disturbance to autoranging UUTs.

4.8.5.3 Configuration for Conductance Measurement in UUTs

Instruments which measure conductance generally use a method which drives a 'pseudo-constant' current (I_G) through the test circuit (usually a resistor) and measures the voltage (V_G) developed across it. Internal circuits then calculate the conductance digitally, using the Law:

$$\text{Conductance: } G = I/V$$

The 9100 assumes that this form of measurement is employed by the UUT. A simplified illustration is shown in *Fig. 4.8.1*:

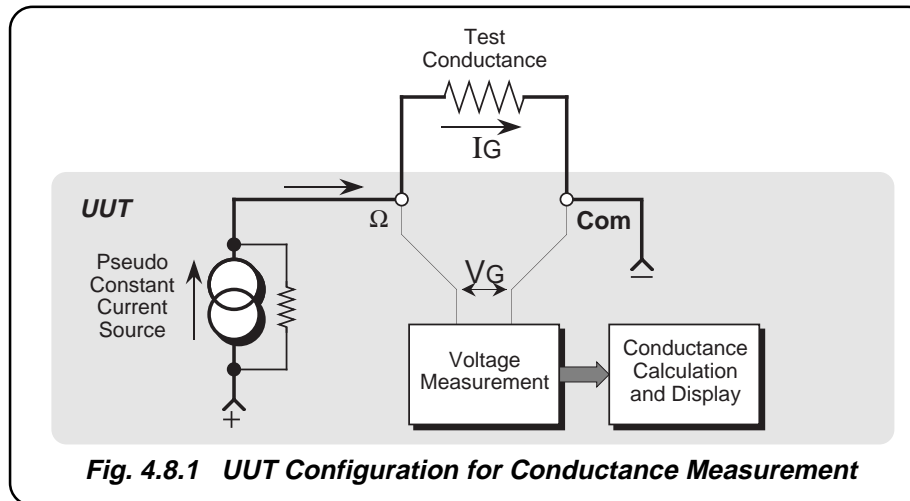

Note that because the current passes through external leads connecting the test conductance to the terminals, the voltage sensed across the terminals will include the lead volts drops, so the conductance result here will be reduced slightly due to the lead resistance.

Final Width = 215mm

Final Width = 215mm

4.8.5.4 Configuration for Conductance Function in the 9100

The 9100 uses 'Active Impedance' technology to output a 'Virtual Conductance' (G_T). The method relies on the UUT having a form of measurement illustrated by Fig. 4.8.1.

The 9100 will produce a DC voltage (V_G) in response to a DC current (I_G) being sourced from the UUT. The value of the voltage is derived electronically from the value of I_G multiplied by the Total Conductance Demand value (G_T) set on the display (including the variation due to offset and deviation settings): $V_G = I_G \times (1/G_T)$.

The effect is that of placing a conductance of value G_T (Virtual Conductance) between the front panel Hi and Lo terminals of the 9100. The method is shown in Fig. 4.8.2.

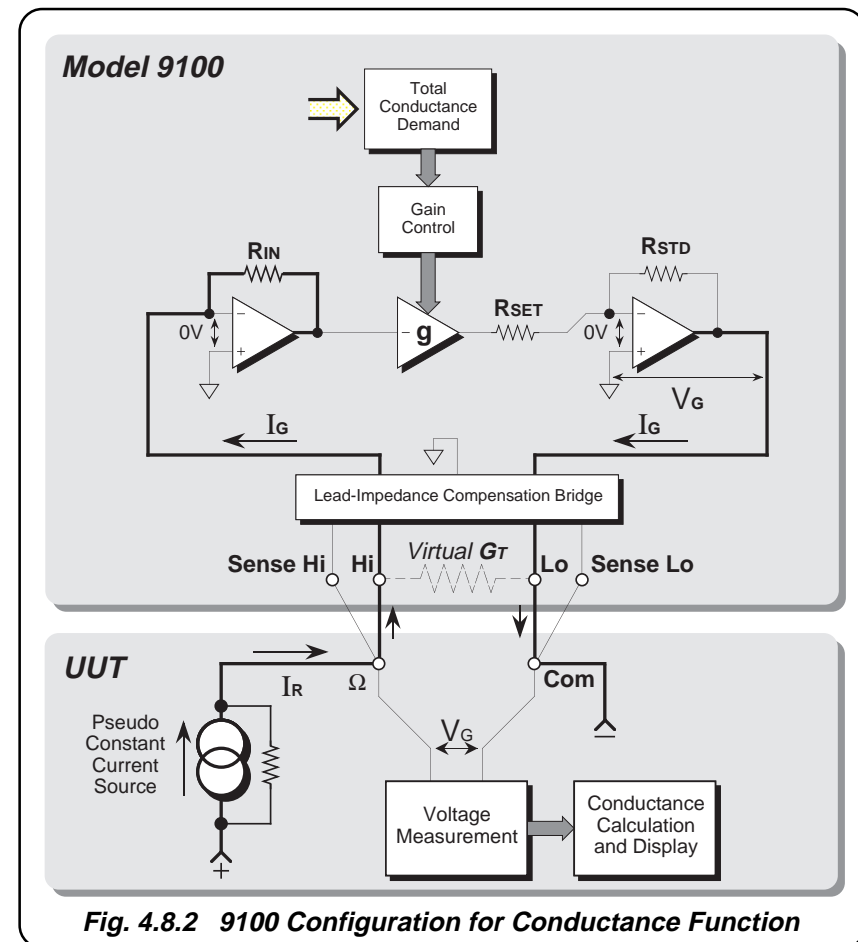

Fig. 4.8.2 9100 Configuration for Conductance Function

Conductance Function Action

The UUT drives the current I_G through R_{IN} via the Hi terminal, and draws I_G out via the Lo terminal. The value of R_{IN} can be one of six possible values, selected automatically to accommodate the value of current I_G . This first stage acts as a current-to-voltage converter, whose output is a negative DC voltage of value $I_G \times R_{IN}$, with respect to the virtual ground at the converter input. This voltage is presented as input to the gain-control amplifier '-g'

The system gain (**g**) is set by the Total Conductance Demand value (G_T) transferred by DAC to control the gain of amplifier '-g'. The final amplifier is switched by R_{STD} and R_{SET} in decade values. It generates a negative DC output voltage V_G , equal to $I_G \div G_T$, across the Hi and Lo terminals; while sourcing the current I_G drawn by the UUT from the Lo terminal.

The value of the virtual conductance G_T is given by:

$$G_T = [1 / (g \times R_{IN})] \times (R_{SET} / R_{STD})$$

4.8.5.5 4-Wire Connections for Conductance Function

In order to protect the 9100 output, fuses and low-value protection resistors are placed internally in series with each of the current-carrying wires. Also, as noted earlier, the external current-carrying wires have their own resistance. The Lead-Impedance Compensation Bridge is used to compensate for these impedances between the voltage V_G and the UUT input. The 9100 is protected against excessive current to ground. If this occurs the output is switched off.

In *Fig. 4.8.2*, the 9100 and UUT are shown in 4-wire connection. One pair of wires passes I_G (Hi and Lo at the 9100), while the second pair (Hi Sense and Lo Sense) senses the voltage at the UUT input terminals. The bridge receives the sensed voltage from the UUT terminals. If this is not exactly the same as V_G , the bridge compensates for any volts drops in the protection circuitry and connecting leads, maintaining V_G at the UUT input.

It is **most important** that a four-wire connection be used for Conductance function. The Model 9105 leadset, supplied with the 9100, provides a four-wire connection. It is recommended that the leadset be fitted, using its four short banana leads, whenever the 9100 is being used in Conductance function.

When a four-wire connection is being used, the **'4 WIRE'** screen key beneath the 9100 LCD display should be selected (light characters on dark background). The firmware will then place the 9100 into 4-wire mode at times when this is advantageous.

Refer to *pages 4.8.2/3*.

Caution:

The greatest error exists when 2-wire connections are being used, with 4-wire selected.

Final Width = 215mm

Final Width = 215mm

4.8.5.6 2-Wire Connection

If it is deemed absolutely necessary to use a two wire connection, the 9100 should be informed by de-selecting '4 WIRE'. As illustrated in Fig.4.8.3, the 9100 will then permanently short Hi to Hi Sense, and Lo to Lo Sense, so that at least the internal protection circuitry is compensated. Conductance measurements made by the UUT will, of course, still be slightly reduced due to the resistance of the two interconnecting leads. *Do not use 2-wire connections when '4 WIRE' is selected on the 9100.*

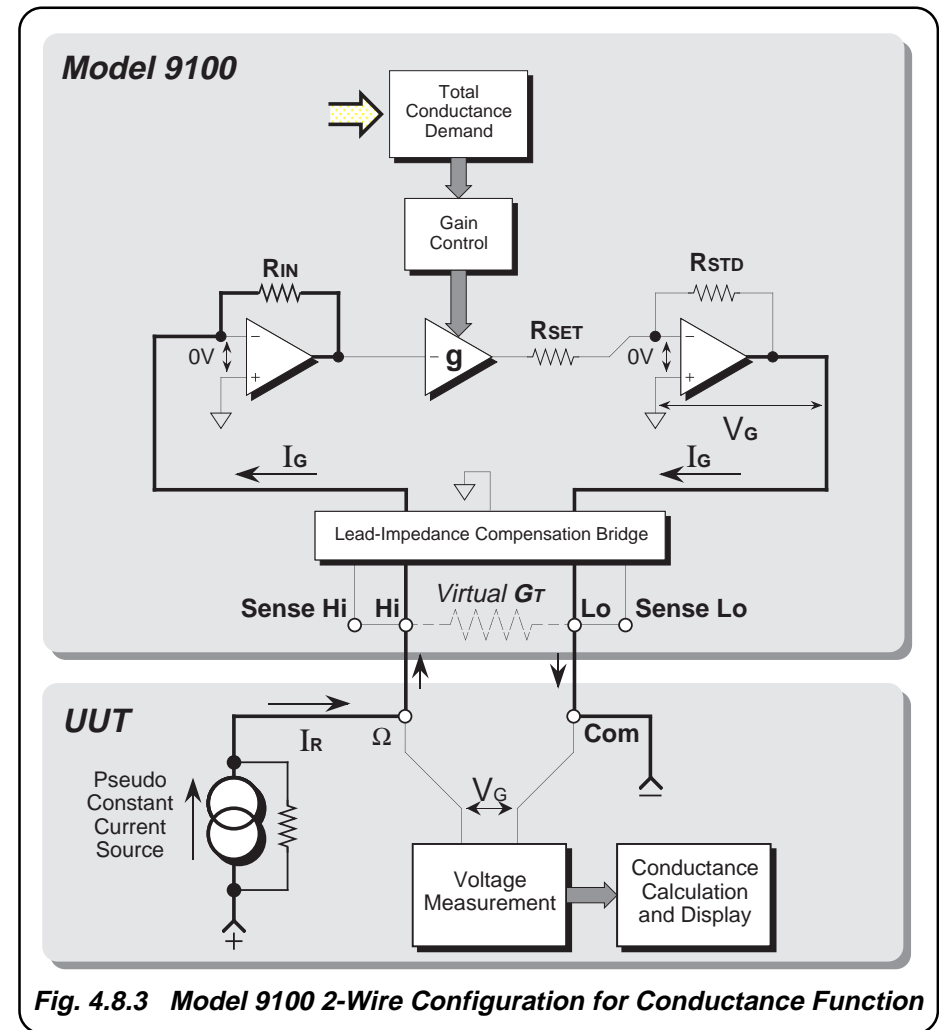

4.8.5.7 Spans of Source Currents

In the synthesized conductance technology used in the 9100, the constant current sourced from the UUT must fall within a maximum of three spans of values for each dialled conductance value. The spans of constant source currents acceptable to the 9100, are shown against their corresponding spans of output conductance in the following table:

Hardware Configuration Limits on Span of Output Conductance	Constant Current Source Limits		
	UUTi Low	UUTi High	UUTi Super
02.5000 nS to 25.0000 nS	4nA to 32nA	2.5nA to 200nA	N/A
025.001 nS to 250.000 nS	8nA to 32nA	25nA to 350nA	250nA to 3.5μA
0.25001 μS to 2.50000 μS	25nA to 320nA	250nA to 3.5μA	2.5μA to 35μA
02.5001 μS to 25.0000 μS	250nA to 3.2μA	2.5μA to 35μA	25μA to 350μA
025.001 μS to 250.000 μS	2.5μA to 32μA	25μA to 350μA	250μA to 3.5mA
0.25001 mS to 2.00000 mS	25μA to 320μA	250μA to 3.5mA	2.5A to 35mA

When the Conductance function is entered from another function, the default conductance setting is 10μS, coupled with the default current span of 'UUTi Low'. As the conductance span is altered within Conductance function, the 9100 will default to the current span nearest to that previously in use. For instance, when using the +10 screen key to decrease the output setting from 200μS — UUTi high current span (25μA to 350μA), the 9100 will automatically select 20μS — super current span (25μA to 350μA). If a different Current span is required, it will be necessary to select it manually by pressing the **CHANGE CURRENT** screen key until the chosen span is selected (*refer to pages 4.8-2/3*). The indications given on the screen for the three different spans are as follows:

Final Width = 215mm

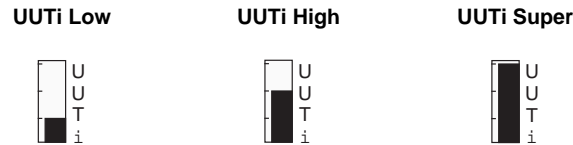

Output Voltage Limitation

At any UUTi span, the 9100 will seek a suitable configuration of hardware to accommodate both the value of source current within the limits, and the value of conductance set as Output Value. The maximum nominal output voltage is 10V, such that: $I_R \div G_T = \leq 10V$

Any Conductance value within the total span can be selected. However, if the source current exceeds the upper limit of the selected span, the circuit will be saturated, and a warning will be given. Also, a warning will be given if the source current is less than the lower limit. When a warning appears, the instrument will still function, but the specification will be compromised.

Always choose the lowest possible UUTi setting at which no 'Sense current high' warning appears; i.e. if a warning is given on a particular UUTi span, work up to use the first span at which the warning disappears. Normally the 9100 toggles between just two of the three possible settings. To force the third setting: turn the output off, make your selection, then turn the output back on.

Final Width = 215mm

4.8.6 Conductance Routines for Calibrating UUTs

4.8.6.1 Interconnections

The general connection scheme for UUT calibration is illustrated in *Fig. 4.8.4*. The use of either 4-wire remote sensing at the UUT terminals, or 2-wire local sensing at the 9100 terminals, is served by the same connections from the 9105 at the work mat. Selection of 2/4-wire is carried out on the 9100 front panel.

For UUTs without *safety* banana sockets, use appropriate adaptors.

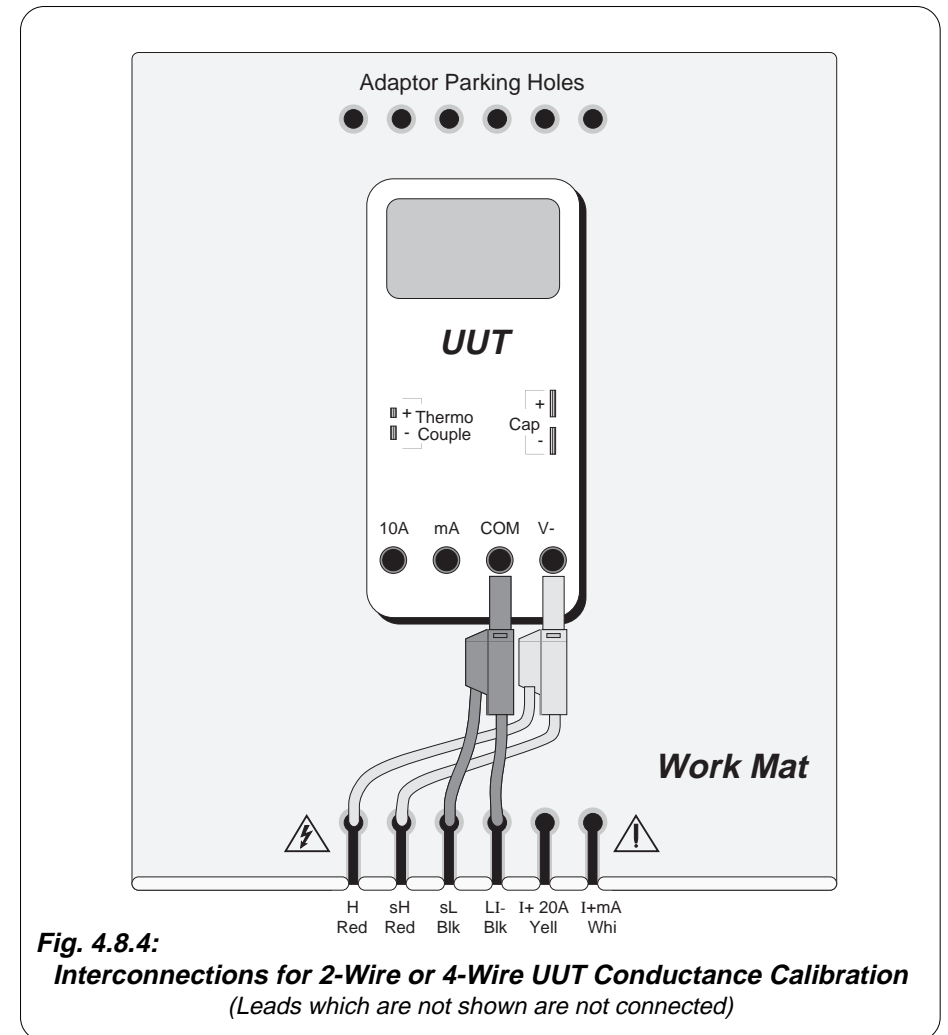

4.8.6.2 Using the 9100 as a Fixed Source

The following procedure assumes that the instrument is in Manual Mode. In the case of difficulty, re-read *Section 3; sub-section 3.3.1*. Familiarity with the methods of editing screen values is also assumed (*Section 3*).

9100 and UUT Setup

1. **Connections** Connect the 9100 to the UUT as shown in *Fig. 4.8.4*, and ensure that both instruments are powered ON and warmed up.
2. **UUT** Select Conductance function.
3. **9100** Ensure that the 9100 is in Conductance Function with Output OFF. If in any other function, press the Ω key on the right of the front panel, then the $\bar{\Omega}$ screen key on the bottom row.

Sequence of Operations

Refer to the table or list of UUT calibration points in the *UUT Manufacturer's Calibration Guide*.

Follow the correct sequence of calibration stages as directed by the guide, and carry out the following operations (1) to (5) at each stage.

1. **9100** Consult the *UUT Manufacturer's Calibration Guide* to determine the requirements for source current and 2/4 wire connection. Refer to the table in paras 4.8.5.7, and use the front panel controls to set the 9100 Output conductance to the UUT cal point value, selecting 2-Wire or 4-Wire and Source Current span as required.
2. **UUT** Select the correct range for the cal point.
3. **9100**
 - a. Set Output **ON**.
 - b. Note the UUT reading.
4. **UUT**
 - a. If a UUT calibration adjustment is provided, adjust the UUT reading to be equal to that on the 9100 screen, as detailed in the *UUT Manufacturer's Calibration Guide*.
 - b. If no adjustment is provided on the UUT, record the UUT reading at the calibration point as detailed in the *UUT Manufacturer's Calibration Guide*.
5. **9100** Set Output **OFF**.

Final Width = 215mm

Final Width = 215mm

4.8.6.3 Using the 9100 as an Adjustable Source

The following procedure assumes that the instrument is in Manual Mode. In the case of difficulty, re-read *sub-section 3.3.1*. Familiarity with the methods of editing screen values is also assumed (*Section 3*).

9100 and UUT Setup

1. **Connections** Connect the 9100 to the UUT as shown in *Fig. 4.8.4*, and ensure that both instruments are powered ON and warmed up.
2. **UUT** Select Conductance function.
3. **9100** Ensure that the 9100 is in Conductance Function with Output OFF. If in any other function, press the Ω key on the right of the front panel, then the $\overline{\text{U}}$ screen key on the bottom row.

Sequence of Operations

Refer to the table of UUT calibration points in the *UUT Manufacturer's Calibration Guide*. Follow the correct sequence of calibration stages as directed by the guide, and carry out the following operations (*1*) to (*5*) at each stage.

1. **9100** Consult the *UUT Manufacturer's Calibration Guide* to determine the requirements for source current and 2/4 wire connection. Refer to the table in paras 4.8.5.7, and use the front panel controls to set the 9100 Output conductance to the UUT cal point value, selecting 2-Wire or 4-Wire and Source Current span as required.
2. **UUT** Select the correct range for the cal point.
3. **9100**
 - a. Set Output **ON**.
 - b. Slew the Conductance Output reading until the UUT reading is equal to the calibration point value.
4. **UUT** Record the 9100 screen output value as detailed in the *UUT Manufacturer's Calibration Guide*.
5. **9100** Set Output **OFF**.

4.9 Frequency Function — Operation

4.9.1

This sub-section is a guide to the use of the 9100 for generating a required Frequency output. The following topics are covered:

- 4.9.2 Selection of Frequency Function.
 - 4.9.2.1 'Hz' Key.
 - 4.9.2.2 Default Settings.
- 4.9.3 Screen Keys.
 - 4.9.3.1 Bottom Screen Keys.
 - 4.9.3.2 Right Side Screen Keys.
- 4.9.4 Value Editing.
 - 4.9.4.1 Editing Output Frequency.
 - 4.9.4.2 Editing High and Low Voltage Levels.
- 4.9.5 Crossing Thresholds.
 - 4.9.5.1 Frequency Resolution Thresholds.
 - 4.9.5.2 Analog Hardware Configurations.
- 4.9.6 Frequency Routines for Calibrating UUTs.
 - 4.9.6.1 Interconnections
 - 4.9.6.2 Using the 9100 as a Fixed Source
 - 4.9.6.3 Using the 9100 as an Adjustable Source

Final Width = 215mm

In this sub-section, we deal with the full range of 'Hz' facilities, in a concise way. For those who require more detailed instructions for manipulating the front panel controls, the DC Voltage function was used as an example for the general familiarization tutorials in *Section 3*.

Final Width = 215mm

4.9.2 Selection of Frequency Function

(Manual Mode selected)

4.9.2.1 'Hz' Key

Frequency Function is selected by pressing the 'Hz' key at the right of the 'CALIBRATION SYSTEM' panel.

4.9.2.2 Default Settings

At power-on the system defaults into DC Voltage function. Each time the **Hz** key is pressed, the system defaults into Frequency function.

In cases when Frequency Function has been selected earlier, and either 'Mark/Period' or 'Duty Cycle' is already active, then the Frequency menu screen is opened by pressing the **Hz** screen key on the bottom row.

Whenever the Hz menu screen is opened, except on recovery from a standby period, it will appear with the following default settings:

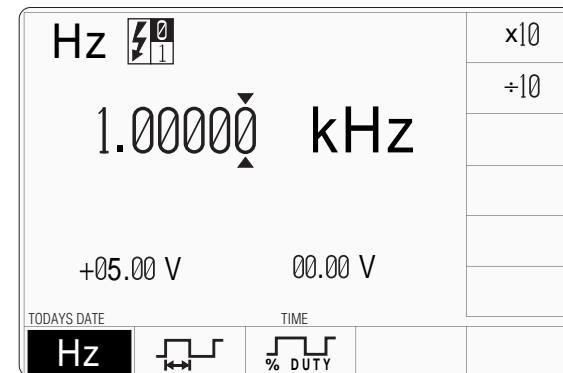

4.9.3 Screen Keys

4.9.3.1 Bottom Screen Keys

Hz Selects **Frequency** when Mark/Period or Duty Cycle is active.



Selects **Mark/Period** when Frequency or Duty Cycle is active.



Selects **Duty Cycle** when Frequency or Mark/Period is active.

4.9.3.2 Right Side Screen Keys

A. Digit Edit Facility Keys operate on the value marked by the cursor.

×10 Multiplies the marked value by ten.

÷10 Divides the marked value by ten.

± Reverses the polarity of the marked value. The **±** key is only available when the cursor is marking either the High or Low Level value.

B. Direct Edit Facility Right side keys operate on the value in the edit box, and acting in place of the **↵** key, exit from Direct Edit back to Digit Edit; then set the value as evaluated in the box.

i. Output Frequency

Hz Evaluates the number in the box in **Hertz**.

kHz Evaluates the number in the box in **Kilohertz**.

MHz Evaluates the number in the box in **Megahertz**.

All Frequency values are set into the highest resolution available to their magnitude.

ii. Selected High or Low Level Value

V Evaluates the number in the box in **Volts**.

The selected High Level value or Low Level value is set into a resolution of four significant digits with two decimal places.

Final Width = 215mm

Help Available!

Section 3 Editing Tutorials.

Final Width = 215mm

4.9.4 Value Editing

4.9.4.1 Editing Output Frequency

Frequency values can be changed using 'Digit' and 'Direct' edit facilities. The editing processes are not described in Section 3, but follow the same general rules as for editing voltages.

The resolution of frequency values is set at six significant digits, leading to six frequency spans of constant resolution.

The thresholds between resolutions of frequency are given in *paras 4.9.5.1.*

Hardware configurations for frequency change are given in *paras 4.9.5.2.*

4.9.4.2 Editing High and Low Voltage Levels

High Level and Low Level values can be changed using 'Digit' and 'Direct' edit facilities as described in *Section 3.* On the 'Hz' menu screen (illustrated on *page 4.9-2*) the high level value is placed on the left, beneath the output frequency value, with the low level value on the right.

Default Output Waveshape

The default output is a 1kHz symmetrical square wave (equal mark and space durations; i.e. 50% duty cycle) with its low level at 0 volts, and its high level at +5V, as shown below in *Fig 4.9.1:*

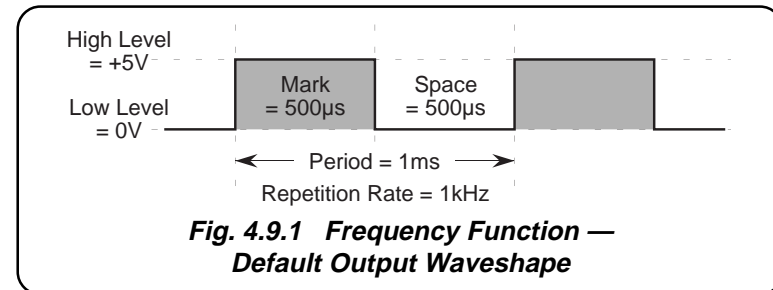

High and Low Signal Level Switching

The effect of changing the values, appearing in the High and Low Level positions on the screen, is to alter the voltages between which the rectangular output waveform switches.

High and Low Signal Level Limits

The high and low signal levels are respectively the most-positive and most-negative excursions of the output signal, and cannot be set outside the following limits:

Frequency Span	Signal Level	Span of Values
000.500Hz to 1.00000kHz	High	-29.98 V to +30.00 V
	Low	-30.00 V to +29.98 V
1.00001kHz to 10.0000MHz	High	-05.99 V to +06.00 V
	Low	-06.00 V to +05.99 V

In addition, the High Level cannot be set equal to or more negative than the Low Level.

Final Width = 215mm

4.9.5 Crossing Thresholds

4.9.5.1 Frequency Resolution Thresholds

The different frequency resolutions are distinguished by two characteristics:

- Lowest and highest frequencies available.
- Absolute resolution of the least-significant digit.

The following table shows the spans of output frequencies for the Frequency function, against their associated resolutions and output voltage limits.

Absolute Resolution	Span of Frequencies	Output Voltage	
		Up to $\pm 6.0V$	Up to $\pm 30V$
1mHz	000.500 Hz to 320.000 Hz	yes	yes
10mHz (0.00050 kHz to 1.00000 kHz	yes	yes
(1.00001 kHz to 3.20000 kHz	yes	no
100mHz	00.0005 kHz to 32.0000 kHz	yes	no
1Hz	000.001 kHz to 320.000 kHz	yes	no
10Hz	0.00001 MHz to 3.20000 MHz	yes	no
100Hz	00.0001 MHz to 10.0000 MHz	yes	no

Increasing Frequency

Using the \odot key in Digit Edit facility; an audible warning will be given if the new value is too large for the present span of frequencies, with a reminder ('Up range required') on the screen. The user must change to the next lower resolution, with a larger span of frequencies, using the $\langle \rangle$ key. This rule applies whether OUTPUT is OFF or ON.

When using either the X10 screen key or the Direct Edit facility; if the new frequency is too large for the present resolution, a lower resolution will be activated with a larger span of frequencies. No warning will be given. This rule applies whether OUTPUT is OFF or ON.

Decreasing Frequency

Using Digit Edit; frequencies down to 100Hz lie within all spans, but to select frequencies below this, one of the three lower spans of frequency must be used.

If the required frequency lies between steps of the present resolution, then the user must increase resolution using the \odot key, also reducing the span of frequencies. This rule applies whether OUTPUT is OFF or ON.

Using either the $\div 10$ screen key or Direct Editing; if the required frequency lies between increments of the present resolution, a greater resolution will be activated with reduced span. No warning will be given. This rule applies whether OUTPUT is OFF or ON.

Final Width = 215mm

4.9.5.2 Analog Hardware Configurations

Frequency Changes

When increasing or decreasing output frequency, using any method: if the new frequency is too large or small for the present hardware configuration, there will be no noticeable effect as the hardware reconfigures automatically.

Voltage Level Changes

There are two hardware configurations for output voltage: one (call it 'A') is used for outputs whose excursions are *between* $-6V$ or $+6V$; and the other ('B') deals with both positive and negative excursions *in excess of* $6V$.

If OUTPUT is ON, it remains on unless a change of hardware configuration is required for the new output voltage. The OUTPUT is temporarily turned OFF only if the demanded output calls for a change of configuration (from 'A' to 'B' or from 'B' to 'A'). After the hardware has reconfigured, OUTPUT is turned ON again automatically at the new voltage. No warning is given. This interruption should cause little disturbance to the reading or response on any UUT.

The resolution of each analog voltage output level is half that shown on the display: i.e. when incrementing the least-significant digit of either of the display voltage levels, the output voltage will increment only on alternate display increments. This is allowed for in the 9100 accuracy specification.

Final Width = 215mm

Final Width = 215mm

4.9.6 Frequency Routines for Calibrating UUTs

4.9.6.1 Interconnections

The general connection scheme for UUT calibration is illustrated in *Fig. 4.9.2*.

For UUTs without *safety* banana sockets, use appropriate adaptors.

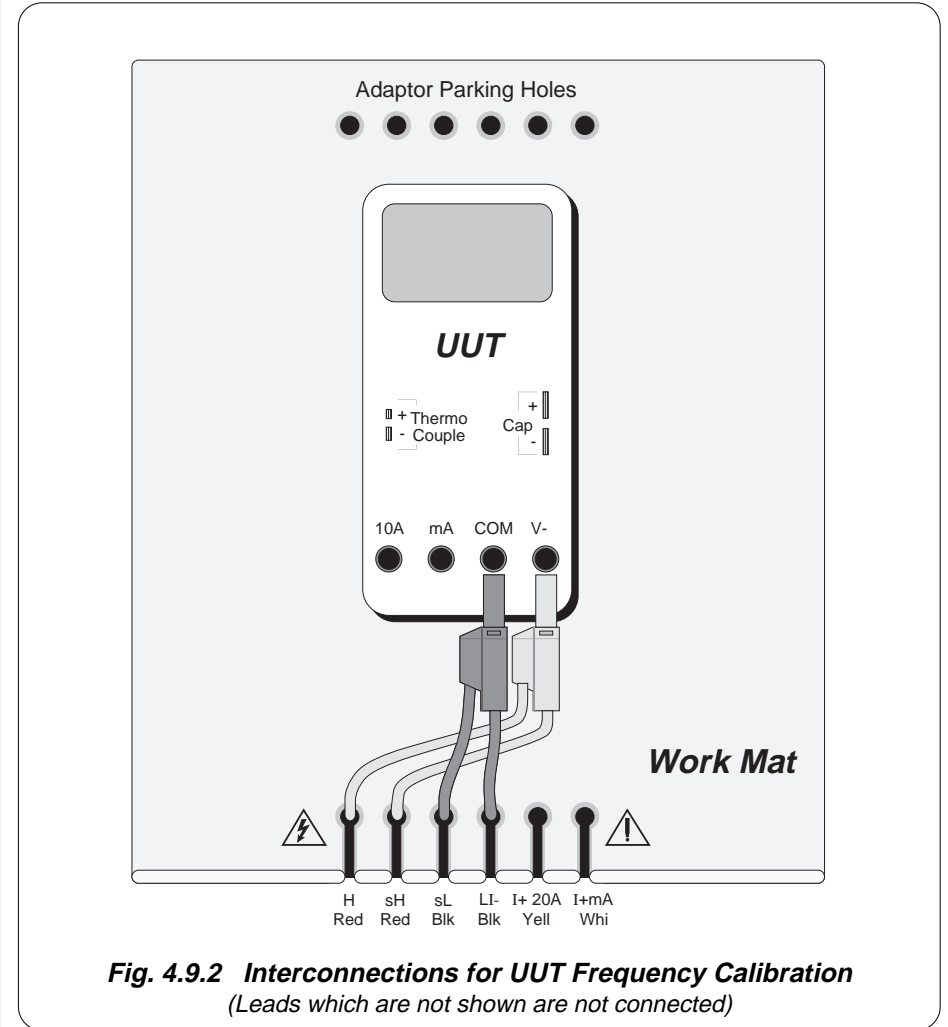

4.9.6.2 Using the 9100 as a Fixed Source

The following procedure assumes that the instrument is in Manual Mode. In the case of difficulty, re-read *Section 3; sub-section 3.3.1*. Familiarity with the methods of editing screen values is also assumed (*Section 3*).

9100 and UUT Setup

1. **Connections** Connect the 9100 to the UUT as shown in *Fig. 4.9.2*, and ensure that both instruments are powered ON and warmed up.
2. **UUT** Select Frequency function.
3. **9100** Ensure that the 9100 is in Frequency Function with Output OFF. If in any other function, press the '**Hz**' key on the right of the front panel, or the **Hz** screen key at the left of the bottom row.

Sequence of Operations

Refer to the table or list of UUT calibration points in the *UUT Manufacturer's Calibration Guide* for the UUT. Follow the correct sequence of calibration stages as directed by the guide, and carry out the following operations (*1*) to (*5*) at each stage.

1. **9100** Use the front panel controls to set the 9100 Output to the UUT cal point parameters:
 - Frequency
 - High signal level voltage.
 - Low signal level voltage.
2. **UUT** Select the correct range for the cal point.
3. **9100**
 - a. Set Output **ON**.
 - b. Note the UUT reading or response.
4. **UUT**
 - a. If a UUT calibration adjustment is provided, adjust the UUT reading or response to be appropriate to the settings on the 9100 screen, as detailed in the *UUT Manufacturer's Calibration Guide*.
 - b. If no adjustment is provided on the UUT, record the UUT reading or response at the calibration point as detailed in the *UUT Manufacturer's Calibration Guide*.
5. **9100** Set Output **OFF**.

Final Width = 215mm

Final Width = 215mm

4.9.6.3 Using the 9100 as an Adjustable Source

The following procedure assumes that the instrument is in Manual Mode. In the case of difficulty, re-read *sub-section 3.3.1*. Familiarity with the methods of editing screen values is also assumed (*Section 3*).

Calibration Setup

1. **Connections** Connect the 9100 to the UUT as shown in *Fig. 4.9.2*, and ensure that both instruments are powered ON and warmed up.
2. **UUT** Select Frequency function.
3. **9100** Ensure that the 9100 is in Frequency Function with Output OFF. If in any other function, press the '**Hz**' key on the right of the front panel, or the **Hz** screen key at the left of the bottom row.

Sequence of Operations

Refer to the table of UUT calibration points in the *UUT Manufacturer's Calibration Guide*. Follow the correct sequence of calibration stages as directed by the guide, and carry out the following operations (*1*) to (*5*) at each stage.

1. **9100** Use the front panel controls to set the 9100 Output to the UUT cal point parameters:
 - Frequency
 - High signal level voltage.
 - Low signal level voltage.
2. **UUT** Select the correct range for the cal point.
3. **9100**
 - a. Set Output **ON**.
 - b. Slew the required Output parameter reading until the UUT reading or response is appropriate to the 9100 settings.
4. **UUT** Record the 9100 screen output values as detailed in the *UUT Manufacturer's Calibration Guide*.
5. **9100** Set Output **OFF**.

4.10 Mark/Period Function — Operation

4.10.1

This sub-section is a guide to the use of the 9100 for generating a rectangular wave with required repetition rate and mark/period ratio. The following topics are covered:

- 4.10.2 Selection of Mark/Period function.
 - 4.10.2.1 'Hz' Key.
 - 4.10.2.2 Default Settings.
- 4.10.3 Screen Keys.
 - 4.10.3.1 Bottom Screen Keys.
 - 4.10.3.2 Right Side Screen Keys.
- 4.10.4 Value Editing.
 - 4.10.4.1 'Mark' and 'Period' Time-Intervals, High and Low Levels.
 - 4.10.4.2 'Mark' and 'Period' Time-Interval Editing.
- 4.10.5 Crossing Thresholds.
 - 4.10.5.1 Time-Interval Resolution Thresholds.
 - 4.10.5.2 Analog Hardware Configurations.
- 4.10.6 Mark/Period Routines for Calibrating UUTs.
 - 4.10.6.1 Interconnections
 - 4.10.6.2 Using the 9100 as a Fixed Source
 - 4.10.6.3 Using the 9100 as an Adjustable Source

Final Width = 215mm

In this sub-section, we deal with the full range of 'Mark/Period' facilities, in a concise way. For those who require more detailed instructions for manipulating the front panel controls, the DC Voltage function was used as an example for the general familiarization tutorials in *Section 3*.

Final Width = 215mm

4.10.2 Selection of Mark/Period Function

(Manual Mode selected)

4.10.2.1 'Hz' Key

Pressing the 'Hz' key at the right of the 'CALIBRATION SYSTEM' panel selects the Frequency Function.

4.10.2.2 Default Settings

At power-on the system defaults into DC Voltage function. Each time the **Hz** key is pressed, the system defaults into Frequency function.

When Frequency or % Duty is active, then the Mark/Period menu screen is opened by pressing the  screen key on the bottom row.

Whenever the  menu screen is opened, except on recovery from a standby period, it will appear with the following default settings:

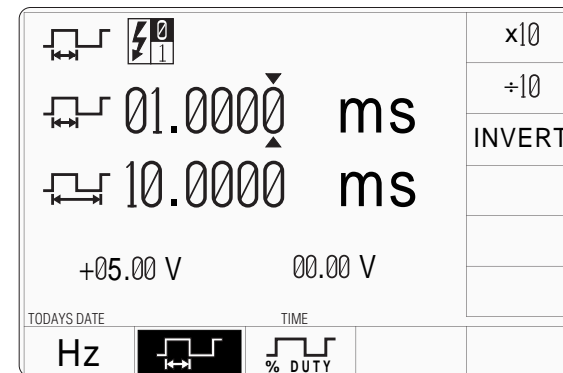

4.10.3 Screen Keys

4.10.3.1 Bottom Screen Keys

Hz Selects **Frequency** when Mark/Period or % Duty is active.



Selects **Mark/Period** when Frequency or % Duty is active.



Selects **% Duty** when Frequency or Mark/Period is active.

4.10.3.2 Right Side Screen Keys

A. Digit Edit Facility Keys operate on the value marked by the cursor.

×10 Multiplies the marked value by ten.

÷10 Divides the marked value by ten.

INVERT Inverts the Mark/Space ratio of the waveform. The **INVERT** key is only available when the cursor is selecting the Mark interval.

± Reverses the polarity of the marked value. The **±** key is only available when the cursor is marking either the High or Low Level value.

B. Direct Edit Facility Right side keys operate on the value in the edit box, and acting in place of the ↵ key, exit from Direct Edit back to Digit Edit; then set the value as evaluated in the box.

Final Width = 215mm

i. Mark or Period Intervals

μs Evaluates the number in the box in **Microseconds**.

ms Evaluates the number in the box in **Milliseconds**.

s Evaluates the number in the box in **Seconds**.

The selected Mark or Period interval value is set into the highest resolution available to its magnitude.

ii. Selected High or Low Level Value

V Evaluates the number in the box in **Volts**.

The selected High Level value or Low Level value is set into a resolution of four significant digits with two decimal places.

Help Available!

Section 3 Editing Tutorials.

Final Width = 215mm

4.10.4 Value Editing

4.10.4.1 'Mark' and 'Period' Time-Intervals, High and Low Voltage Levels

Mark and Period time-intervals, High Level and Low Level voltage values can be changed using 'Digit' and 'Direct' edit facilities as described in *Section 3*. On the 'Mark/Period' menu screen (illustrated on *page 4.10-2*) the high level value is placed beneath the period time interval value on the left, and the low level on the right.

Default Output Waveshape

The default output is a 100Hz rectangular wave (1:10 mark/period ratio; 1:9 mark/space ratio; i.e. 10% duty cycle) with its low level at 0 volts, and its high level at +5V, as shown below in *Fig 4.10.1*:

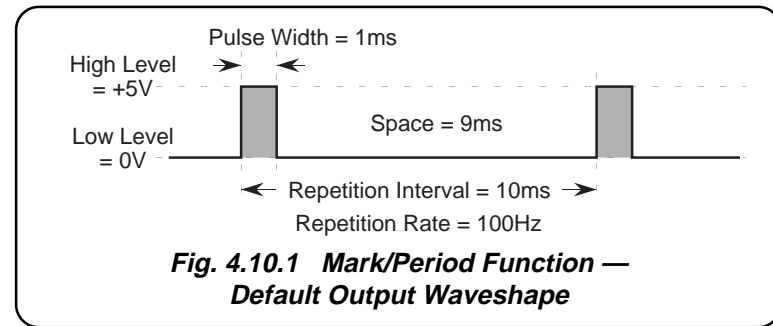

High and Low Signal Level Switching

The effect of changing the values, appearing in the High and Low Level positions on the screen, is to alter the voltages between which the rectangular output waveform switches.

High and Low Signal Level Limits

The high and low signal levels are respectively the most-positive and most-negative excursions of the output signal, and cannot be set outside the following magnitude limits:

Up to $\pm 6.0V$ Output:

$0.6\mu s \leq \text{Period}$; $0.30\mu s \leq \text{High Interval}$; $0.30\mu s \leq \text{Low Interval}$.

Up to $\pm 30V$ Output:

$1ms \leq \text{Period}$; $10\mu s \leq \text{High Interval}$; $10\mu s \leq \text{Low Interval}$.

In addition, the High Level cannot be set equal to or more negative than the Low Level.

4.10.4.2 'Mark' and 'Period' Time-Interval Editing

Mark and Period time-interval values can be changed using 'Digit' and 'Direct' edit facilities. The editing processes are not described in Section 3, but follow the same general rules as for editing voltages.

The resolution of time-interval values is set at six significant digits, except for the shortest span of intervals at four significant digits. This leads to four repetition period spans of constant resolution. The 'Mark' interval value must always be less than the 'Period' interval.

The thresholds between resolutions of Mark interval and of Period interval are given in *paras 4.10.5.1*.

Analog hardware configurations for time-interval change are given in *paras 4.10.5.2*.

Final Width = 215mm

4.10.5 Crossing Thresholds

4.10.5.1 Time-Interval Resolution Thresholds

The different time-interval resolutions are distinguished by two characteristics:

- Shortest and longest time-intervals available.
- Absolute resolution of the least-significant digit.

'Mark' Time-Intervals

The following table shows the spans of output **Mark** time-intervals for the Mark/Period function, against their associated resolutions.

Absolute Resolution	Span of Time-Intervals for -6.0V — +6.0V Output	Span of Time-Intervals for -30V — +30V Output
100ns	000.3 μ s to 999.9 μ s*	010.00 μ s to 999.9 μ s**
100ns	00.0003 ms to 99.9999 ms*	00.0100 ms to 99.9999 ms**
1 μ s	000.001 ms to 999.999 ms*	000.010 ms to 999.999 ms**
10 μ s	0000.01 ms to 1999.99 ms*	0000.01 ms to 1999.99 ms**

Notes * = Maximum interval must be at least 0.3 μ s less than that of the set period.

** = Maximum interval must be at least 10 μ s less than that of the set period.

'Period' Time-Intervals

The following table shows the spans of output **Period** time-intervals for the Mark/Period function, against their associated resolutions.

Absolute Resolution	Span of Time-Intervals for -6.0V — +6.0V Output	Span of Time-Intervals for -30V — +30V Output
100ns	000.6 μ s to 999.9 μ s	-----
100ns	00.0006 ms to 99.9999 ms	01.0000 ms to 99.9999 ms
1 μ s	000.001 ms to 999.999 ms	001.000 ms to 999.999 ms
10 μ s	0000.01 ms to 2000.00 ms	0001.00 ms to 2000.00 ms

Final Width = 215mm

Mark/Period Ratio Limits

The Mark and Period time-intervals can be adjusted over their ranges of values shown in the tables, provided that the Mark time-interval is shorter than the Period time-interval. An audible warning will be given if an attempt is made to set a Mark or Period time-interval which would produce a Mark/Period ratio of 1 or greater (also see the * and ** minimum difference limits shown beneath the table of pulse-widths above). The user must reset either the mark or the period to give a ratio less than 1. This rule applies whether OUTPUT is OFF or ON.

Increasing Mark or Period Time-Interval Value

Using the \odot key in Digit Edit facility; an audible warning will be given if the new value is too large for the present span of time-intervals, with a reminder on the screen. The user must change to the next lower resolution, with a larger span of intervals, using the \langle key. This rule applies whether OUTPUT is OFF or ON.

When using either the X10 screen key or the Direct Edit facility; if the new value is too large for the present resolution, a lower resolution will be activated with a larger span of time-intervals. No warning will be given. This rule applies whether OUTPUT is OFF or ON.

Decreasing Mark or Period Time-Interval Value

Using Digit Edit; time-intervals down to 0.01ms lie within all spans, but to select intervals shorter than this, one of the three lower spans of intervals must be used.

If the required time-interval lies between steps of the present resolution, then the user must increase resolution using the \rangle key, also reducing the span of intervals. This rule applies whether OUTPUT is OFF or ON.

Using either the $\div 10$ screen key or Direct Editing; if the required time-interval lies between increments of the present resolution, a greater resolution will be activated with reduced span. No warning will be given. This rule applies whether OUTPUT is OFF or ON.

Final Width = 215mm

Final Width = 215mm

4.10.5.2 Analog Hardware Configurations

Time-Interval Changes

Increments of the time intervals of analog output will follow those of the display, with the same resolution: i.e. when incrementing the least-significant digit of either the displayed mark or period interval, the corresponding analog output time interval will increment on each display increment.

When increasing or decreasing time-interval, using any method: if the new interval is too large or small for the present hardware configuration, there will be no noticeable effect as the hardware reconfigures.

Voltage Level Changes

There are two hardware configurations for output voltage: one (call it 'A') is used for outputs whose excursions are *between* -6V or +6V; and the other ('B') deals with both positive and negative excursions *in excess of* 6V.

If OUTPUT is ON, it remains on unless a change of hardware configuration is required for the new output voltage. The OUTPUT is temporarily turned OFF only if the demanded output calls for a change of configuration (from 'A' to 'B' or from 'B' to 'A'). After the hardware has reconfigured, OUTPUT is turned ON again automatically at the new voltage. No warning is given. This interruption should cause little disturbance to the reading or response on any UUT.

The resolution of each analog voltage output level is half that shown on the display: i.e. when incrementing the least-significant digit of either of the display voltage levels, the output voltage will increment only on alternate display increments. This is allowed for in the 9100 accuracy specification.

4.10.6 Mark/Period Routines for Calibrating UUTs

4.10.6.1 Interconnections

The general connection scheme for UUT calibration is illustrated in *Fig. 4.10.2*.

For UUTs without *safety* banana sockets, use appropriate adaptors.

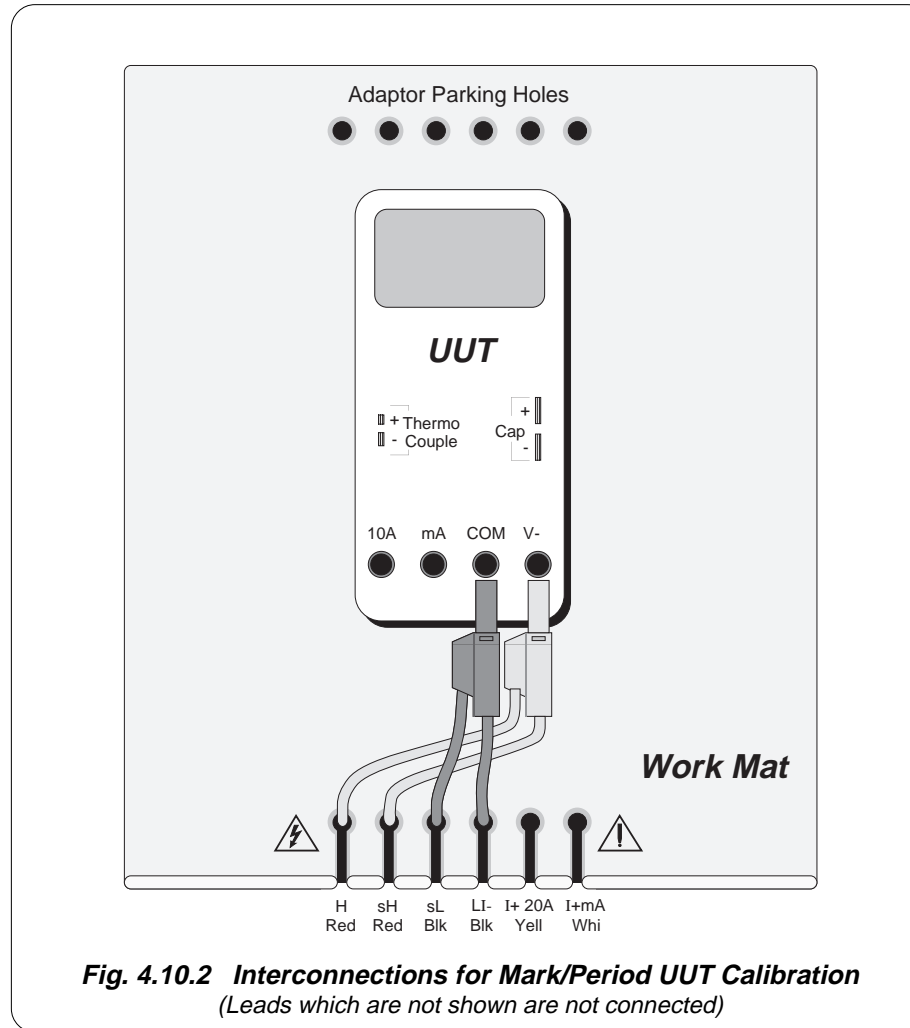

Final Width = 215mm

Final Width = 215mm

4.10.6.2 Using the 9100 as a Fixed Source

The following procedure assumes that the instrument is in Manual Mode. In the case of difficulty, re-read *Section 3; sub-section 3.3.1*. Familiarity with the methods of editing screen values is also assumed (*Section 3*).

9100 and UUT Setup

1. **Connections** Connect the 9100 to the UUT as shown in *Fig. 4.10.2*, and ensure that both instruments are powered ON and warmed up.
2. **UUT** Select Mark/Period function.
3. **9100** Ensure that the 9100 is in Mark/Period Function with Output OFF. If in any other function, press the 'Hz' key on the right of the front panel, then the  screen key on the bottom row.

Sequence of Operations

Refer to the table or list of UUT calibration points in the *UUT Manufacturer's Calibration Guide*.

Follow the correct sequence of calibration stages as directed by the guide, and carry out the following operations (*1*) to (*5*) at each stage.

1. **9100** Use the front panel controls to set the 9100 Output to the UUT cal point parameters:
 - Mark time-interval,
 - Period time-interval,
 - High signal level voltage.
 - Low signal level voltage.
2. **UUT** Select the correct range for the cal point.
3. **9100**
 - a. Set Output **ON**.
 - b. Note the UUT reading or response.
4. **UUT**
 - a. If a UUT calibration adjustment is provided, adjust the UUT reading or response to be appropriate to the settings on the 9100 screen, as detailed in the *UUT Manufacturer's Calibration Guide*.
 - b. If no adjustment is provided on the UUT, record the UUT reading or response at the calibration point as detailed in the *UUT Manufacturer's Calibration Guide*.
5. **9100** Set Output **OFF**.

4.10.6.3 Using the 9100 as an Adjustable Source

The following procedure assumes that the instrument is in Manual Mode. In the case of difficulty, re-read *sub-section 3.3.1*. Familiarity with the methods of editing screen values is also assumed (*Section 3*).

Calibration Setup

1. **Connections** Connect the 9100 to the UUT as shown in *Fig. 4.10.2*, and ensure that both instruments are powered ON and warmed up.
2. **UUT** Select Mark/Period function.
3. **9100** Ensure that the 9100 is in Mark/Period Function with Output OFF. If in any other function, press the 'Hz' key on the right of the front panel, then the  screen key on the bottom row.

Sequence of Operations

Refer to the table of UUT calibration points in the *UUT Manufacturer's Calibration Guide*. Follow the correct sequence of calibration stages as directed by the guide, and carry out the following operations (1) to (5) at each stage.

1. **9100** Use the front panel controls to set the 9100 Output to the UUT cal point parameters:
 - Mark time-interval,
 - Period time-interval,
 - High signal level voltage.
 - Low signal level voltage.
2. **UUT** Select the correct range for the cal point.
3. **9100**
 - a. Set Output ON.
 - b. Slew the required Output parameter until the UUT reading or response is appropriate to the 9100 settings.
4. **UUT** Record the 9100 screen output values as detailed in the *UUT Manufacturer's Calibration Guide*.
5. **9100** Set Output OFF.

Final Width = 215mm

4.11 % Duty Function — Operation

4.11.1

This sub-section is a guide to the use of the 9100 for generating a rectangular wave with required repetition rate and percentage duty cycle. The following topics are covered:

4.11.2 Selection of % Duty function.

4.11.2.1 'Hz' Key.

4.11.2.2 Default Settings.

4.11.3 Screen Keys.

4.11.3.1 Bottom Screen Keys.

4.11.3.2 Right Side Screen Keys.

4.11.4 Value Editing.

4.11.4.1 '% Duty Cycle' and 'Period' Time-Interval, High and Low Voltage Levels.

4.11.4.2 % Duty Cycle Editing.

4.11.4.3 'Period' Time-Interval Editing.

4.11.4.4 'Period' Time-Interval Ranges and Limits.

4.11.5 Crossing Thresholds.

4.11.5.1 No '% Duty Cycle' Resolution Thresholds.

4.11.5.2 'Period' Time-Interval Resolution Thresholds.

4.11.5.3 Analog Hardware Configurations.

4.11.6 % Duty Routines for Calibrating UUTs.

4.11.6.1 Interconnections

4.11.6.2 Using the 9100 as a Fixed Source

4.11.6.3 Using the 9100 as an Adjustable Source

In this sub-section, we deal with the full range of '% Duty' facilities, in a concise way. For those who require more detailed instructions for manipulating the front panel controls, the DC Voltage function was used as an example for the general familiarization tutorials in *Section 3*.

Final Width = 215mm

Final Width = 215mm

4.11.2 Selection of % Duty Function

(Manual Mode selected)

4.11.2.1 'Hz' Key

Pressing the 'Hz' key at the right of the 'CALIBRATION SYSTEM' panel selects the Frequency Function.

4.11.2.2 Default Settings

At power-on the system defaults into DC Voltage function. Each time the 'Hz' key is pressed, the system defaults into Frequency function.

If Frequency or Mark/Period is already active, then the % Duty menu screen is opened by pressing the  screen key on the bottom row.

Whenever the  menu screen is opened, except on recovery from a standby period, it will appear with the following default settings:

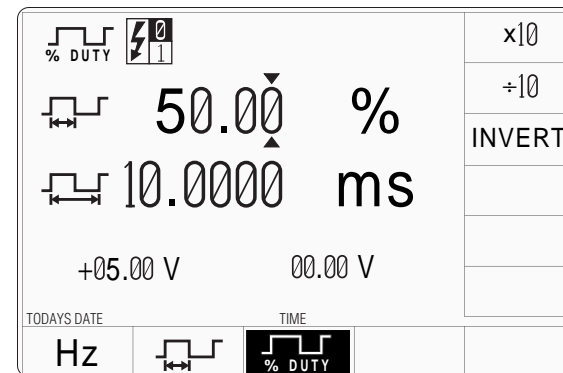

4.11.3 Screen Keys

4.11.3.1 Bottom Screen Keys

Hz Selects **Frequency** when Mark/Period or % Duty is active.



Selects **Mark/Period** when Frequency or % Duty is active.



Selects **% Duty** when Frequency or Mark/Period is active.

4.11.3.2 Right Side Screen Keys

A. Digit Edit Facility Keys operate on the value marked by the cursor.

X10 Multiplies the marked value by ten.

÷10 Divides the marked value by ten.

INVERT Inverts the Mark/Space ratio of the waveform. The **INVERT** key is available only if the cursor is marking the % Duty Cycle value.

± Reverses the polarity of the marked value. The **±** key is available only if the cursor is marking the High or Low Level value.

B. Direct Edit Facility Right side keys operate on the value in the edit box, and acting in place of the ↵ key, exit from Direct Edit back to Digit Edit; then set the value as evaluated in the box.

i. % Duty Cycle Value

% Evaluates the number in the box in **Duty Cycle Percentage**.

The selected Duty Cycle Percentage value is set into a resolution of four significant digits with two decimal places.

ii. Period Interval

μs Evaluates the number in the box in **Microseconds**.

ms Evaluates the number in the box in **Milliseconds**.

s Evaluates the number in the box in **Seconds**.

The selected Mark or Period interval value is set into the highest resolution available to its magnitude.

iii. Selected High or Low Level Value

V Evaluates the number in the box in **Volts**.

The selected High Level value or Low Level value is set into a resolution of four significant digits with two decimal places.

Final Width = 215mm

Help Available!

Section 3 Editing Tutorials.

Final Width = 215mm

4.11.4 Value Editing

4.11.4.1 '% Duty Cycle' and 'Period Time-Interval'; High and Low Voltage Levels

The Duty Cycle '%' value and Period time-intervals; High Level and Low Level voltage values can be changed using 'Digit' and 'Direct' edit facilities as described in *Section 3*. On the '% Duty Cycle' menu screen (illustrated on *page 4.11-2*) the high level value is placed beneath the period time interval value on the left, with the low level on the right.

Default Output Waveshape

The default output is a 100Hz symmetrical rectangular wave (50% duty cycle; i.e. 1:2 mark/period ratio; 1:1 mark/space ratio) with its low level at 0 volts, and its high level at +5V, as shown below in *Fig 4.11.1*:

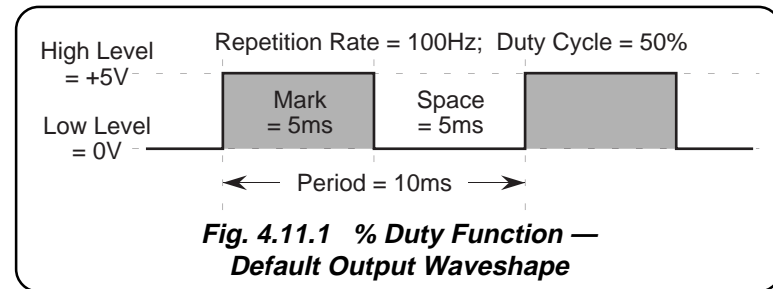

High and Low Signal Level Switching

The effect of changing the values, appearing in the High and Low Level positions on the screen, is to alter the voltages between which the rectangular output waveform switches.

High and Low Signal Level Limits

The high and low signal levels are respectively the most-positive and most-negative excursions of the output signal, and when the % duty is expressed in absolute values, cannot be set outside the following limits:

Up to $\pm 6.0V$ Output:

$100.0\mu s \leq \text{Period}; \quad 0.3\mu s \leq \text{High Interval}; \quad 0.3\mu s \leq \text{Low Interval}.$

Up to $\pm 30V$ Output:

$1ms \leq \text{Period}; \quad 10\mu s \leq \text{High Interval}; \quad 10\mu s \leq \text{Low Interval}.$

In addition, the High Level cannot be set equal to or more negative than the Low Level.

4.11.4.2 % Duty Cycle Editing

Duty Cycle percentage values can be changed using 'Digit' and 'Direct' edit facilities. The editing processes are not described in Section 3, but follow the same general rules as for editing voltages.

The resolution of '%' values is set at four significant digits. There is only one absolute level of resolution: 00.01%.

'% Duty' Value

The screen setting of the '% Duty' value is subject to the following limitations:

$$00.05\% \leq \% \text{ Duty} \leq 99.95\%$$

The actual setting is translated in software into a 'Mark' time-interval value, internally calculated to be the required percentage of the set 'Period' time-interval value. Because of the wide range of period values available, and the finite resolution of the 'Mark' time-interval counter, it is possible only to determine a 'Mark' time-interval which is 'rounded' to its nearest digit of resolution. The 9100 specification accommodates this rounding.

4.11.4.3 'Period' Time-Interval Editing

Period time-interval values can be changed using 'Digit' and 'Direct' edit facilities. The editing processes are not described in Section 3, but follow the same general rules as for editing voltages.

The resolution of duty cycle values is set at four significant digits, except that the minimum value is 00.05%, and the maximum is 99.95%. Between these two values is one span of constant resolution.

The resolution of time-interval values is set at six significant digits, except for the shortest span of intervals at four significant digits. This leads to four repetition period interval spans of constant resolution.

4.11.4.4 'Period' Time-Interval Ranges and Limits

The ranges of 'Period' time intervals are described in *paras 4.11.5.2*.

Analog hardware configurations for time-interval and voltage change are given in *paras 4.11.5.3*.

Final Width = 215mm

4.11.5 Crossing Thresholds

4.11.5.1 No '% Duty' Resolution Thresholds

As the '%' resolution is fixed at 4 significant digits, with absolute resolution of 00.01% between 00.05% and 99.95%, there are no resolution thresholds to cross.

4.11.5.2 Period Time-Interval Resolution Thresholds

The different time-interval resolutions are distinguished by two characteristics:

- Shortest and longest time-intervals available.
- Absolute resolution of the least-significant digit.

The following table shows the spans of output **Period** time intervals for the % Duty Cycle function, against their associated resolutions:

Absolute Resolution	Span of Time-Intervals for -6.0V — +6.0V Output	Span of Time-Intervals for -30V — +30V Output
100ns	100.0 μ s to 999.9 μ s	-----
100ns	00.1000 ms to 99.9999 ms	01.0000 ms to 99.9999 ms
1 μ s	000.100 ms to 999.999 ms	001.000 ms to 999.999 ms
10 μ s	0000.10 ms to 2000.00 ms	0001.00 ms to 2000.00 ms

Increasing Period Time-Interval Value

Using the \odot key in Digit Edit facility; an audible warning will be given if the new value is too large for the present span of time-intervals, with a reminder on the screen. The user must change to the next lower resolution, with a larger span of intervals, using the \langle key. This rule applies whether OUTPUT is OFF or ON.

When using the X10 screen key or the Direct Edit facility; if the new value is too large for the present resolution, a lower resolution will be activated with a larger span of time-intervals. No warning will be given. This rule applies whether OUTPUT is OFF or ON.

Decreasing Period Time-Interval Value

Using Digit Edit; time-intervals down to 0.01ms lie within all spans, but to select intervals shorter than this, one of the four lower spans of intervals must be used.

If the required time-interval lies between steps of the present resolution, then the user must increase resolution using the \langle key, also reducing the span of intervals. This rule applies whether OUTPUT is OFF or ON.

Using the $\div 10$ screen key or Direct Editing; if the required time-interval lies between increments of the present resolution, a greater resolution will be activated with reduced span. No warning will be given. This rule applies whether OUTPUT is OFF or ON.

Final Width = 215mm

4.11.5.3 Analog Hardware Configurations

Time-Interval Changes

When increasing or decreasing time-interval, using any method: if the new interval is too large or small for the present hardware configuration, there will be no noticeable effect as the hardware reconfigures.

Voltage Level Changes

There are two hardware configurations for output voltage: one (call it 'A') is used for outputs whose excursions are *between* -6V or +6V; and the other ('B') deals with both positive and negative excursions *in excess of* 6V.

If OUTPUT is ON, it remains on unless a change of hardware configuration is required for the new output voltage. The OUTPUT is temporarily turned OFF only if the demanded output calls for a change of configuration (from 'A' to 'B' or from 'B' to 'A'). After the hardware has reconfigured, OUTPUT is turned ON again automatically at the new voltage. No warning is given. This interruption should cause little disturbance to the reading or response on any UUT.

The resolution of each analog voltage output level is half that shown on the display: i.e. when incrementing the least-significant digit of either of the display voltage levels, the output voltage will increment only on alternate display increments. This is allowed for in the 9100 accuracy specification.

Final Width = 215mm

Final Width = 215mm

4.11.6 % Duty Routines for Calibrating UUTs

4.11.6.1 Interconnections

The general connection scheme for UUT calibration is illustrated in *Fig. 4.11.2*.

For UUTs without *safety* banana sockets, use appropriate adaptors.

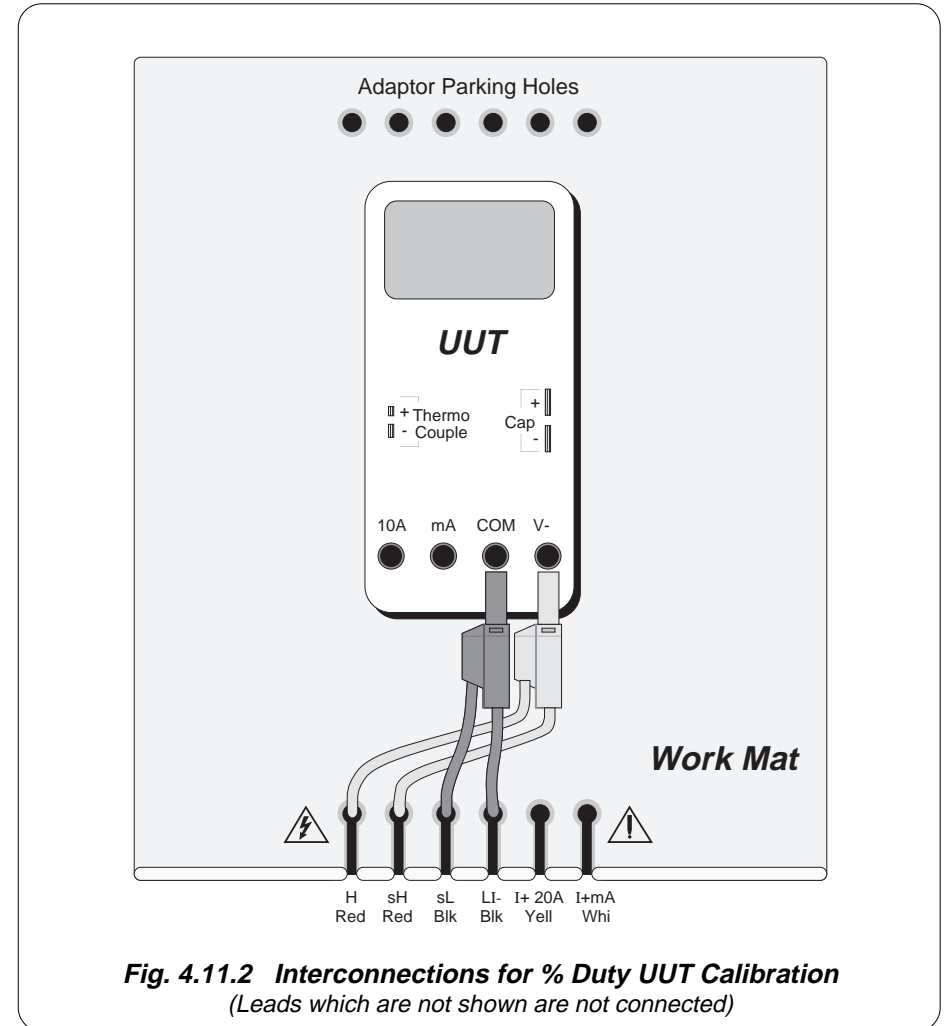

4.11.6.2 Using the 9100 as a Fixed Source

The following procedure assumes that the instrument is in Manual Mode. In the case of difficulty, re-read *Section 3; sub-section 3.3.1*. Familiarity with the methods of editing screen values is also assumed (*Section 3*).

9100 and UUT Setup

1. **Connections** Connect the 9100 to the UUT as shown in *Fig. 4.11.2*, and ensure that both instruments are powered ON and warmed up.
2. **UUT** Select % Duty function.
3. **9100** Ensure that the 9100 is in % Duty Function with Output OFF. If in any other function, press the 'Hz' key on the right of the front panel, then the  screen key at the left of the bottom row.

Sequence of Operations

Refer to the table or list of UUT calibration points in the *UUT Manufacturer's Calibration Guide*.

Follow the correct sequence of calibration stages as directed by the guide, and carry out the following operations (1) to (5) at each stage.

Final Width = 215mm

1. **9100** Use the front panel controls to set the 9100 Output to the UUT cal point parameters:
 - % Duty,
 - Period,
 - High signal level voltage.
 - Low signal level voltage.
2. **UUT** Select the correct range for the cal point.
3. **9100**
 - a. Set Output **ON**.
 - b. Note the UUT reading or response.
4. **UUT**
 - a. If a UUT calibration adjustment is provided, adjust the UUT reading or response to be appropriate to the settings on the 9100 screen, as detailed in the *UUT Manufacturer's Calibration Guide*.
 - b. If no adjustment is provided on the UUT, record the UUT reading or response at the calibration point as detailed in the *UUT Manufacturer's Calibration Guide*.
5. **9100** Set Output **OFF**.

Final Width = 215mm

4.11.6.3 Using the 9100 as an Adjustable Source

The following procedure assumes that the instrument is in Manual Mode. In the case of difficulty, re-read *sub-section 3.3.1*. Familiarity with the methods of editing screen values is also assumed (*Section 3*).

Calibration Setup

1. **Connections** Connect the 9100 to the UUT as shown in *Fig. 4.11.2*, and ensure that both instruments are powered ON and warmed up.
2. **UUT** Select % Duty function.
3. **9100** Ensure that the 9100 is in % Duty Function with Output OFF. If in any other function, press the 'Hz' key on the right of the front panel, then the  screen key at the left of the bottom row.

Sequence of Operations

Refer to the table of UUT calibration points in the *UUT Manufacturer's Calibration Guide*. Follow the correct sequence of calibration stages as directed by the guide, and carry out the following operations (1) to (5) at each stage.

1. **9100** Use the front panel controls to set the 9100 Output to the UUT cal point parameters:
 - % Duty,
 - Period,
 - High signal level voltage.
 - Low signal level voltage.
2. **UUT** Select the correct range for the cal point.
3. **9100**
 - a. Set Output **ON**.
 - b. Slew the required Output parameter until the UUT reading or response is appropriate to the 9100 settings.
4. **UUT** Record the 9100 screen output values as detailed in the *UUT Manufacturer's Calibration Guide*.
5. **9100** Set Output **OFF**.

4.12 Auxiliary Functions

4.12.1

This sub-section is a guide to selecting one of the auxiliary functions. The following topics are covered:

4.12.2 Selection of Auxiliary Functions.

4.12.2.1 'Aux' Key.

4.12.2.2 Default Settings.

4.12.3 Screen Keys.

4.12.3.1 Bottom Screen Keys.

4.12.3.2 No Right Side Screen Keys.

4.12.4 Result of Function Selection.

N.B. The functions of Option 250 or 600 (Oscilloscope Calibration Module) are 'Auxiliary' functions, and are added to the Auxiliary screen. For details of Option 250/600 functions, refer to the *Model 9100 User's Handbook, Volume 3, Section 14, Sub-section 14.3.*

4.12.2 Selection of Auxiliary Functions

(Manual Mode selected)

4.12.2.1 'Aux' Key

Auxiliary functions are accessed by pressing the 'Aux' key at the right of the 'CALIBRATION SYSTEM' panel.

4.12.2.2 Default Settings

Each time the 'Aux' key is pressed, the system shows the default Auxiliary menu screen for selection of one of the auxiliary functions: **Capacitance, Temperature, Logic Pulse/Logic Level or Insulation/Continuity** (if Option 135 is fitted)

If Option 250 or Option 600 (the 250MHz or 600MHz Oscilloscope Calibration Module) is *not* fitted, the following screen will appear:

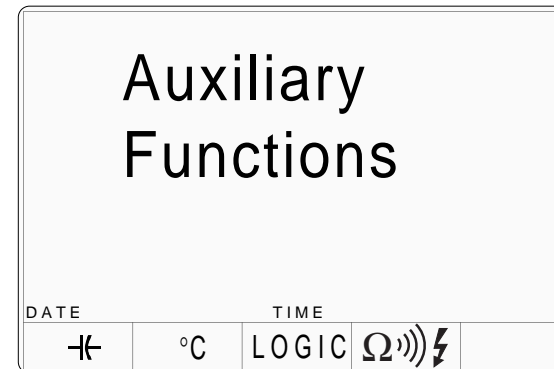

Only displayed if
Option 135 is fitted

If Option 250 or Option 600 *is* fitted, the Auxiliary screen will appear as shown below. For details of Option 250/Option 600 functions, refer to the *Model 9100 User's Handbook, Volume 3, Section 14, Sub-section 14.3*.

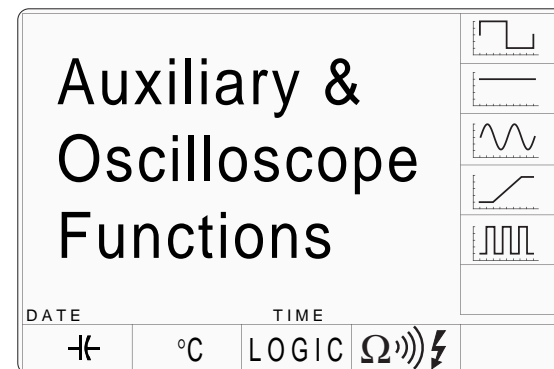

Only displayed if
Option 135 is fitted

4.12.3 Screen Keys

4.12.3.1 Bottom Screen Keys

 Selects 'Capacitance' Function.

°C Selects 'Temperature' Function.

LOGIC Selects 'Logic Pulse / Logic Level' Function.

 Selects 'Insulation / Continuity' Function (if Option 135 is fitted).

4.12.3.2 No Right Side Screen Keys

As this is a function selection menu only, none of the right side screen keys are used.

4.12.4 Result of Function Selection

As soon as a bottom screen key is pressed, the Auxiliary menu screen will disappear, to be replaced by the default screen of the selected function.

For further details refer to the following sub-sections:

This Volume 1	4.13	Capacitance
	4.14	Temperature (Thermocouple)
	4.15	Temperature (PRT)
	4.16	Logic Pulses
	4.17	Logic Levels
	4.18	Insulation/Continuity
Volume 3	14.3	'Auxiliary' Oscilloscope Functions

4.13 Capacitance Function — Operation

4.13.1

This sub-section is a guide to the use of the 9100 for generating a required Capacitance output. The following topics are covered:

- 4.13.2 Selection of Capacitance Function.
 - 4.13.2.1 'Aux' Key.
 - 4.13.2.2 Default Settings.
- 4.13.3 Screen Keys.
 - 4.13.3.1 Bottom Screen Keys.
 - 4.13.3.2 Right Side Screen Keys.
 - Note: Internal Compensation.
 - 4.13.3.3 Introducing Deviation and Offset Values.
- 4.13.4 Value Editing.
 - 4.13.4.1 Output, Offset and Deviation.
- 4.13.5 Crossing Thresholds.
 - 4.13.5.1 Capacitance Resolution Thresholds.
 - 4.13.5.2 Hardware Configurations.
 - 4.13.5.3 Configuration for Capacitance Measurement in UUTs.
 - 4.13.5.4 Configuration for Capacitance Function in the 9100.
 - 4.13.5.5 4-Wire Connections for Capacitance Function.
 - 4.13.5.6 Two-Wire Connection.
 - 4.13.5.7 Spans of Source Currents.
- 4.13.6 Capacitance Routines for Calibrating UUTs.
 - 4.13.6.1 Interconnections.
 - 4.13.6.2 Using the 9100 as a Fixed Source.
 - 4.13.6.3 Using the 9100 as an Adjustable Source.

Final Width = 215mm

In this sub-section, we deal with the full range of Capacitance facilities, in a concise way. For those who require more detailed instructions for manipulating the front panel controls, the DC Voltage function was used as an example for the general familiarization tutorials in *Section 3*, and this may provide an introduction to the function.

4.13.2 Selection of Capacitance Function

(Manual Mode selected)

4.13.2.1 'Aux' Key

Capacitance is an 'Auxiliary' function. The Auxiliary menu screen is selected by pressing the 'Aux' key at the right of the 'CALIBRATION SYSTEM' panel. Capacitance is selected by pressing the  screen key on the bottom row.

4.13.2.2 Default Settings

At power-on, the system defaults into DC Voltage function. Each time the 'Aux' key is pressed, the system defaults to the 'Auxiliary Functions' menu (*Sub-section 4.12*).

Whenever the Capacitance menu screen is opened by pressing the  screen key on the 'Auxiliary Functions' menu screen, except on recovery from a standby period, it will appear with the following default settings:

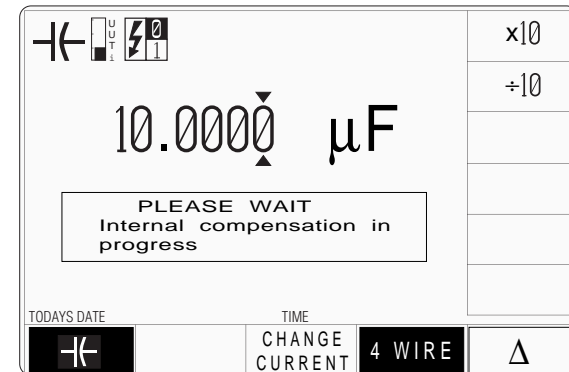

N.B. The 'compensation' message will not always appear — conditions for internal compensation are described in the left column of the page opposite.

Final Width = 215mm

Note: Internal Compensation

The accuracy of the 9100 Capacitance Function is maintained by an automatic process. This compares parameters of the function against those obtained from internal voltage and resistance references of higher stability, compensating automatically for drift due to time and temperature.

The compensation process is initiated only by a change of function into Capacitance function, and then only when certain conditions are satisfied:

The process cannot be carried out until the 9100 has been powered-up for 20 minutes, to avoid reacting to transient warm-up temperatures; and also:

One of the following three events must have occurred since the most-recent compensation:

- a. 24 hours has elapsed; or:
- b. The temperature, measured internally, has changed by $\pm 5^{\circ}\text{C}$; or:
- c. The Resistance Function has been externally calibrated.

During the process, a courtesy notice is placed on the screen to warn users that the function will not operate correctly. This is shown in the representation of the screen on the page opposite.

4.13.3 Screen Keys

4.13.3.1 Bottom Screen Keys



Indicates that Capacitance function is active. This key has no other purpose. The default condition accepts constant source currents with 4-wire connections.

**CHANGE
CURRENT**

Scales the analog circuitry to accept alternative constant source currents. Refer to paras 4.13.5.7.

4 WIRE

Connects the analog circuitry as a 4-wire source when selected, and a 2-wire source when deselected. Default condition is 'selected'. The screen key operates as toggle-on / toggle off. Refer to paras 4.13.5.4 to 4.13.5.6.



Accesses the 'Percentage Deviation' and 'Capacitance Offset' displays to add to the screen presentation. Refer to paras 4.13.3.3 and 4.13.4.1.

4.13.3.2 Right Side Screen Keys

A. Digit Edit Facility Keys operate on the value marked by the cursor.

$\times 10$

Multiplies the marked value by ten.

$\div 10$

Divides the marked value by ten.

\pm

Inverts the polarity of the marked deviation or offset value.

B. Direct Edit Facility Right side keys operate on the value in the edit box, and acting in place of the \downarrow key, exit from Direct Edit back to Digit Edit and set the value as evaluated in the box.

i. Output Value and Offset Value

nF

Evaluates the number in the box in **Nanofarads**.

μ F

Evaluates the number in the box in **Microfarads**.

mF

Evaluates the number in the box in **Millifarads**.

ii. Deviation Value

%

Evaluates the number in the box in **Percentage Deviation**. The Deviation value is limited to $\pm 10\%$ of the Output value.

Output and Offset values are set into the same resolution. All values are set into the highest resolution available to their magnitude.

Final Width = 215mm

Final Width = 215mm

4.13.3 Screen Keys (Contd.)

4.13.3.3 Introducing Deviation and Offset Values

Pressing the ' Δ ' key (bottom row) presents a screen with $\Delta\%$ and ΔF labelling the two top right screen keys:

Pressing the ' $\Delta\%$ ' screen key adds the 'Percentage Deviation' value to the lower left of the display presentation and the screen reverts to the main Capacitance display as shown below. The Deviation value is limited to $\pm 10\%$ of the Output value.

Pressing the ' ΔF ' screen key adds the 'Capacitance Offset' value to the lower right of the display presentation and the screen reverts to the main Capacitance display as shown below.

Note that as each of the ' Δ ' keys is pressed to show its value on the screen, the cursors will move to the latest selection.

The main Capacitance display is shown here with both $\Delta\%$ and ΔF additions in place. This would require two separate operations of the Δ key on the bottom row, as after each selection, the screen reverts to the main display. After reversion, the cursors can be transferred to any of the displayed values for editing, here shown on the main output display. Otherwise, the operation of the editing keys is unchanged (*paras* 4.13.3.2), and direct editing can also be used.

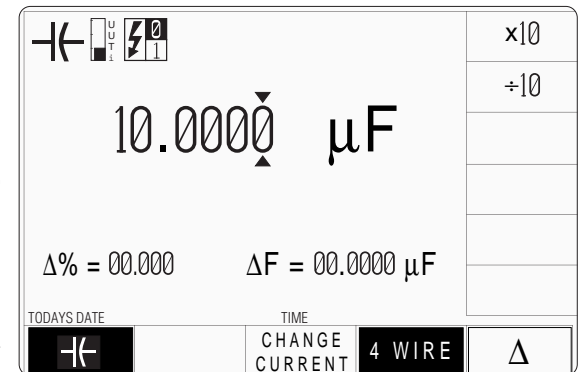
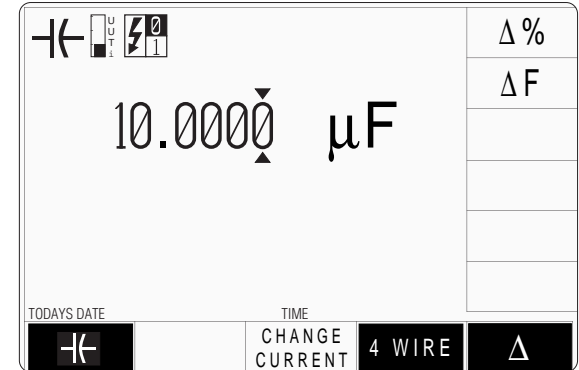

4.13.4 Value Editing

4.13.4.1 Output, Offset and Deviation

The Output, Offset and Deviation values can be changed using 'Digit' and 'Direct' edit facilities as described in *Section 3*.

Offset Values

The effect of introducing a non-zero offset value is to change all set values of the output by that of the offset. A positive offset will increase the output capacitance, and a negative offset will reduce the output capacitance.

For example:

- a. A set Output Value of 10 μ F with a +1 μ F Offset will be output as 11 μ F.
- b. A set Output Value of 400nF with a -100nF Offset will be output as 300nF.
- c. A set Output Value of 100nF with a -300nF Offset will not be enabled.

Deviation Percentage Values

The effect of introducing a non-zero deviation value is to change all set values of the output by the fraction expressed by the deviation. A positive deviation will increase, and a negative deviation will reduce, the output capacitance.

For example:

- a. An Output Value of 10mF set on the display, will be increased to 10.5mF by a +5% Deviation.
- b. A -10% Deviation will reduce an Output Value of 50 μ F set on the display, to 45 μ F.

Combined Deviation Percentage and Offset

Deviation and Offset values are combined by first applying the deviation, then the offset, to the output value in the form $y = (1 + m/100).x + c$, where:

y is the terminal capacitance; **x** is the set output capacitance;
m is the set deviation percentage; **c** is the set offset capacitance.

For example:

- a. Set Values: Output = 10mF; Deviation = +5%; Offset = +3mF.
Terminal Capacitance will be:
$$[(1 + 5/100) \times 10\text{mF}] + (+3\text{mF}) = [1.05 \times 10\text{mF}] + 3\text{mF} = 13.5\text{mF}$$
- b. Set Values: Output = 40 μ F; Deviation = -10%; Offset = -30 μ F.
Terminal Capacitance will be:
$$[(1 - 10/100) \times 40\mu\text{F}] + (-30\mu\text{F}) = [0.9 \times 40\mu\text{F}] - 30\mu\text{F} = 6\mu\text{F}$$

Final Width = 215mm

Final Width = 215mm

4.13.5 Crossing Thresholds

4.13.5.1 Capacitance Resolution Thresholds

The different resolutions are distinguished by two characteristics:

- Maximum and minimum values available.
- Absolute resolution of the least-significant digit.

The following table shows the spans of output values for the Capacitance function, against their associated resolutions.

Absolute Resolution	Span of Values
0.01pF	0.50000 nF to 4.00000 nF
0.1pF	00.5000 nF to 40.0000 nF
1pF	000.500 nF to 400.000 nF
10pF	0.00050 μ F to 4.00000 μ F
100pF	00.0005 μ F to 40.0000 μ F
1nF	000.001 μ F to 400.000 μ F
10nF	0.00001 mF to 4.00000 mF
100nF	00.0001 mF to 40.0000 mF

Rules, built into firmware, govern passage across thresholds between resolutions:

Increasing Output or Offset Capacitance

Using the \odot key in Digit Edit facility; an audible warning will be given if the new value is too large for the present span of values, with a reminder on the screen. The user must change to the next lower resolution, with a larger span of values, using the \langle key. This rule applies whether OUTPUT is OFF or ON.

When using either the X10 screen key or the Direct Edit facility; if the new value is too large for the present resolution, a lower resolution will be activated with a larger span of values. No warning will be given. This rule applies whether OUTPUT is OFF or ON.

Decreasing Output or Offset Capacitance

Using Digit Edit; values down to minimum lie within the spans shown in the resolution table. If the required value lies between steps of the present resolution, the user must increase resolution using the \rangle key, also reducing the span of values. This rule applies whether OUTPUT is OFF or ON.

Using either the $\div 10$ screen key or Direct Editing; if the required value lies between increments of the present resolution, a greater resolution will be activated with reduced span. No warning will be given. This rule applies whether OUTPUT is OFF or ON.

4.13.5.2 Hardware Configurations

When increasing or decreasing output Capacitance, using any method: if the new Capacitance is too large or small for the present hardware configuration, then if OUTPUT is OFF there will be no noticeable effect as the hardware reconfigures.

If OUTPUT is ON, it will be temporarily turned OFF so that the hardware can reconfigure, then ON again at the new capacitance. No warning will be given. This interruption should cause little disturbance to the reading on any UUT.

4.13.5.3 Configuration for Capacitance Measurement in UUTs

Instruments which measure Capacitance generally use a method which drives a current (I_c) as a stimulus through the test circuit (usually a capacitor) and measures the voltage (V_c) developed across it. The stimulus can be a constant, ramping or AC current. Internal circuits then calculate the Capacitance digitally, dependent on the type of stimulus.

Whatever the form of the stimulus current, the resulting voltage V_c will satisfy the basic capacitive equation: $C \times dv/dt = i$ (instantaneous values), and the voltage sensing device is designed to measure the form that the result will take. Digital calculations will derive the value of the test capacitance, knowing the stimulus.

The 9100 assumes that a method such as that of *Fig. 4.13.1*, is employed by UUTs.

Final Width = 215mm

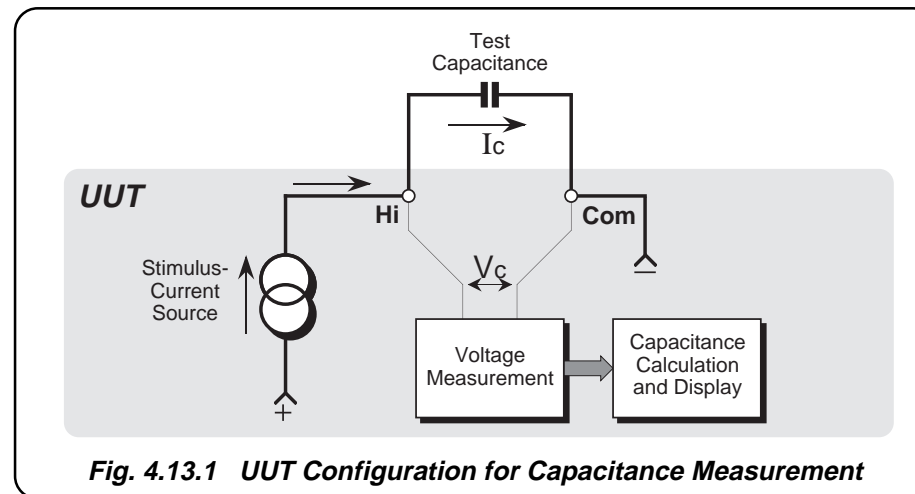

Fig. 4.13.1 UUT Configuration for Capacitance Measurement

Note that because the current passes through external test leads connecting the capacitor to the terminals, the voltage sensed across the terminals will include the lead volts drops, so the result here will also include a small quadrature element due to the lead resistance.

Final Width = 215mm

4.13.5.4 Configuration for Capacitance Function in the 9100

The 9100 uses 'Active Impedance' technology to output a 'Virtual Capacitance'. The method relies on the UUT having a form of measurement illustrated by Fig. 4.13.1.

The 9100 will produce a voltage (V_C) in response to a stimulus current (I_C) being sourced from the UUT. The instantaneous voltage value (v_C) is derived from the instantaneous value of stimulus current (i_C) modified by the Total Capacitance Demand (C_T) set on the 9100 display (including any Offset and Deviation variations): $dv_C/dt = i_C/C_T$.

The effect is that of placing a virtual capacitance of value (C_T) between the front panel Hi and Lo terminals of the 9100. The method is shown in Fig. 4.13.2, below:

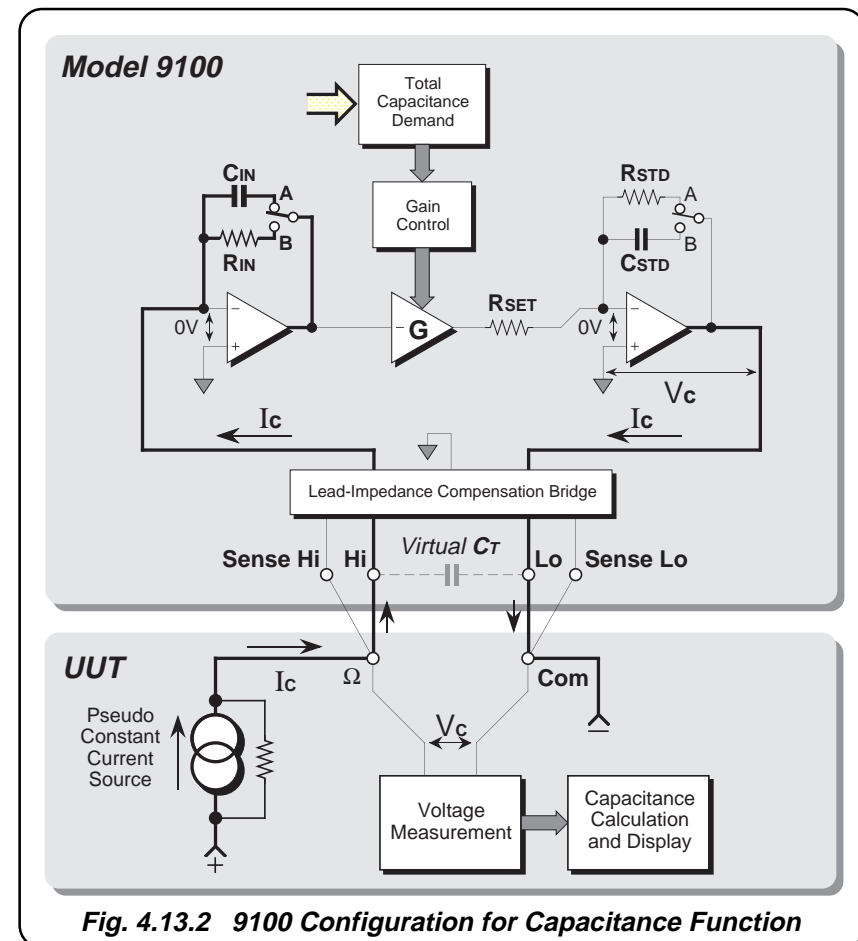

Fig. 4.13.2 9100 Configuration for Capacitance Function

Capacitance Function Action

Consider the switches at position 'A'. The UUT drives its stimulus current I_C into C_{IN} via the Hi terminal, and draws I_C via the Lo terminal. The value of C_{IN} can be one of five possible values, selected automatically to accommodate the range of stimulus currents. The system gain is set by the 'Total Capacitance Demand' set value (C_T), transferred by DAC to control the gain of amplifier 'G'. The final amplifier is switched in decade values. The overall result is an output voltage (V_C) satisfying $dv_C/dt = i_C/C_T$, placed across the Hi and Lo terminals, while sourcing the same instantaneous values of i_C , drawn by the UUT from the Lo terminal.

The value of the virtual capacitance with the switches in position 'A' is given by:

$$C_T = (C_{IN}/G) \times (R_{SET}/R_{STD})$$

With the switches in position 'B', for a particular range of I_C values, the value of the virtual capacitance is given by:

$$C_T = (C_{STD}/G) \times (R_{SET}/R_{IN})$$

4.13.5.5 4-Wire Connections for Capacitance Function

In order to protect the 9100 output, fuses and low-value protection resistors are placed internally in series with each of the current-carrying wires. Also, as noted earlier, the external current-carrying wires have their own resistance. The Lead-Impedance Compensation Bridge is used to compensate for these impedances between the voltage V_C and the UUT input.

In *Fig. 4.13.2*, the 9100 and UUT are shown in 4-wire connection. One pair of wires passes I_C (Hi and Lo at the 9100), while the second pair (Hi Sense and Lo Sense) senses the voltage at the UUT input terminals.

The bridge receives the sensed voltage from the UUT terminals. If this is not exactly the same as V_C , the bridge compensates for any volts drops in the protection circuitry and interconnecting leads, maintaining V_C at the UUT input.

It is **most important** that a four-wire connection be used for Capacitance function. The Model 9105 leadset, supplied with the 9100, provides a four-wire connection. It is recommended that the leadset be fitted, using its four short banana leads, whenever the 9100 is being used in Capacitance function.

When a four-wire connection is being used, the '**4 WIRE**' screen key beneath the LCD display should be selected (light characters on dark background). Four-wire operation is already selected in the default condition of the Capacitance function.

Refer to *pages 4.13.2/3*.

Caution:

The greatest error exists when 2-wire connections are being used, with 4-wire selected.

Final Width = 215mm

Final Width = 215mm

4.13.5.6 2-Wire Connection

If it is deemed absolutely necessary to use a two wire connection, the 9100 should be informed by deselecting '4 WIRE'. As illustrated in Fig.4.13.3, the 9100 will then permanently short Hi to Hi Sense, and Lo to Lo Sense, so that at least the internal protection circuitry is compensated. Measurements made by the UUT will, of course, still include the resistance of the two interconnecting leads. *Do not use 2-wire connections when '4 WIRE' is selected on the 9100.*

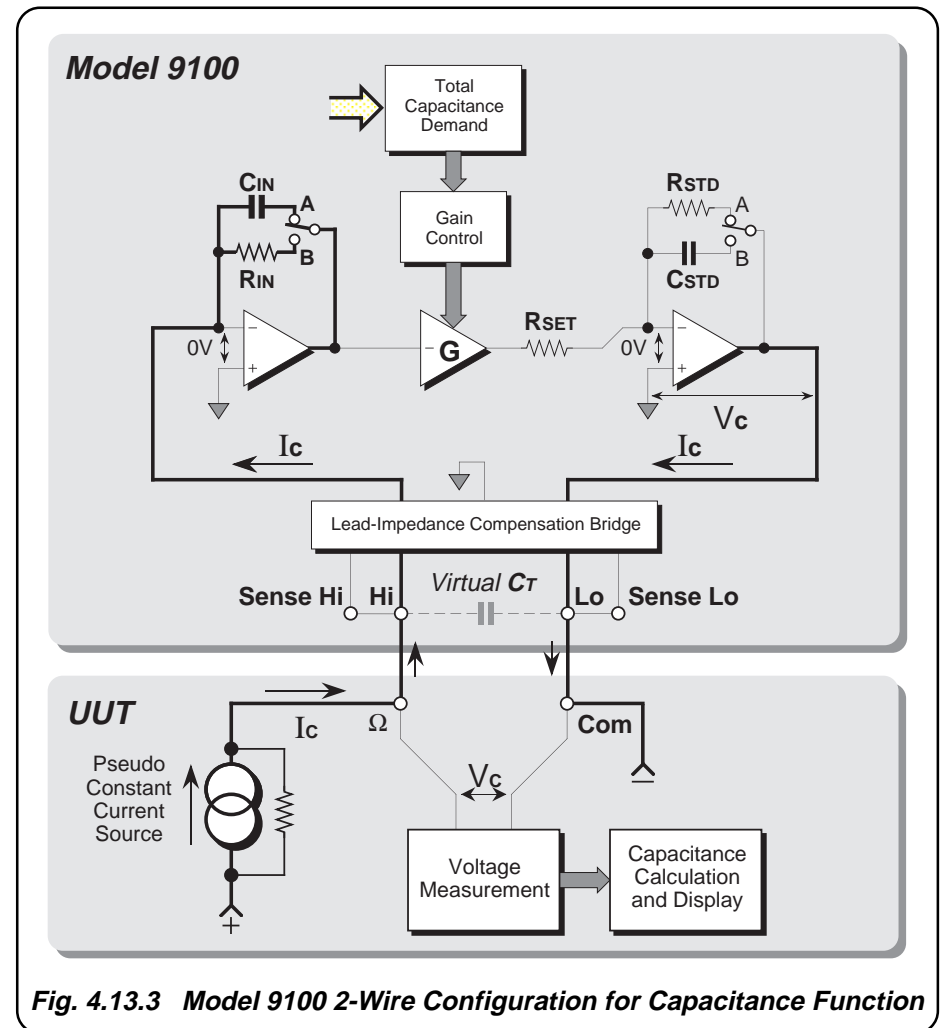

Fig. 4.13.3 Model 9100 2-Wire Configuration for Capacitance Function

4.13.5.7 Spans of Source Currents

In the synthesized capacitance technology used in the 9100, the constant current sourced from the UUT must fall within a maximum of two spans of values (Spans 1 and 3 as shown below) for each dialled capacitance value. The spans of constant source currents acceptable to the 9100 are shown against their corresponding spans of output capacitance in the following table:

Hardware Configuration Limits on Span of Output Capacitance	Constant Source Current Limits		
	UUTi Low	UUTi High	UUTi Super
0.50000 nF to 4.00000 nF	0.02µA to 500µA	◆	◆
4.00001 nF to 40.0000 nF	0.02µA to 500µA	◆	◆
40.0001 nF to 400.000 nF	0.04µA to 1mA	◆	◆
0.40001 µF to 4.00000 µF	0.5µA to 1mA	◆	◆
04.0001 µF to 40.0000 µF	5µA to 3mA	◆	◆
040.001 µF to 400.000 µF	5µA to 3mA	◆	2.5mA to 35mA
0.40001 mF to 4.00000 mF	5µA to 3mA	◆	2.5mA to 35mA
04.0001 mF to 40.0000 mF	5µA to 3mA	◆	2.5mA to 35mA

◆ = No corresponding span available

When the Capacitance function is entered from another function, the default capacitance setting is 10µF (in the 0.4µF-40µF capacitance span), coupled with its only available current span: 'UUTi Low' (5µA to 3mA). 'UUTi Low' will persist for all changes between capacitance spans, but in the three upper spans (40µF-40mF) 'UUTi Super' can be selected by pressing the **CHANGE CURRENT** screen key (refer to pages 4.13-2/3). Once selected, UUTi Super will persist until one of the lower five spans (0.5µF to 40µF) is selected, when the 9100 reverts to UUTi Low. The indications given on the screen for the two different spans are as follows:

Final Width = 215mm



Output Voltage Limitation

At any UUTi span, the 9100 will seek a suitable configuration of hardware to accommodate both the value of source current within the limits, and the value of capacitance set as Output Value. The maximum output voltage for guaranteed proper operation is 3.5V (2.5V on 4µF to 40µF span). Under some conditions, a higher voltage can be obtained.

Any Capacitance value within the total span can be selected. However, if the source current exceeds the upper limit of the selected span, the circuit will be saturated, and a warning will be given. When a warning appears, the instrument will still function, but the specification will be compromised.

Always use UUTi Low unless the 'Sense current high' warning appears, then choose UUTi Super, if available. Always try to use the smallest possible current.

4.13.6 Capacitance Routines for Calibrating UUTs

4.13.6.1 Interconnections

The general connection scheme for UUT calibration is illustrated in *Fig. 4.13.4*.

For UUTs without *safety* banana sockets, use appropriate adaptors.

Do not twist the leads together — *separate* them as far as possible.

Final Width = 215mm

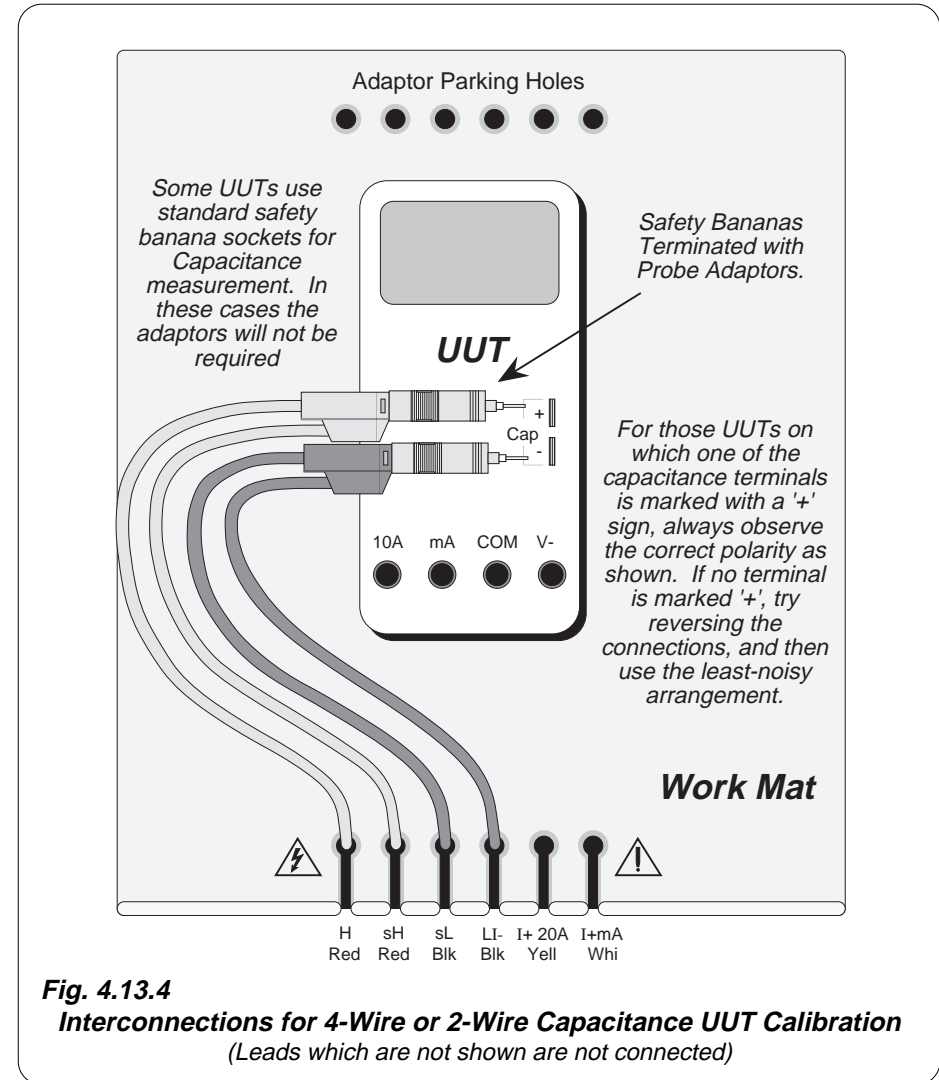

4.13.6.2 Using the 9100 as a Fixed Source

The following procedure assumes that the instrument is in Manual Mode. In the case of difficulty, re-read *Section 3; sub-section 3.3.1*. Familiarity with the methods of editing screen values is also assumed (*Section 3*).

9100 and UUT Setup

1. **Connections** Connect the 9100 to the UUT as shown in *Fig. 4.13.4*, and ensure that both instruments are powered ON and warmed up.
2. **UUT** Select Capacitance function.
3. **9100** Ensure that the 9100 is in Capacitance Function with Output OFF. If in any other function, press the '**Aux**' key on the right of the front panel to access Auxiliary functions. Then press the  screen key on the bottom row to select Capacitance Function.

Sequence of Operations

Refer to the table or list of UUT calibration points in the *UUT Manufacturer's Calibration Guide*.

Follow the correct sequence of calibration stages as directed by the guide, and carry out the following operations (1) to (5) at each stage.

1. **9100** Consult the *UUT Manufacturer's Calibration Guide* to determine the requirements for source current and 2/4 wire connection. Refer to the table in paras 4.13.5.7, and use the front panel controls to set the 9100 Output capacitance to the UUT cal point value, selecting 2-Wire or 4-Wire and Source Current span as required.
2. **UUT** Select the correct range for the cal point.
3. **9100**
 - a. Set Output **ON**.
 - b. Note the UUT reading.
4. **UUT**
 - a. If a UUT calibration adjustment is provided, adjust the UUT reading to be equal to that on the 9100 screen, as detailed in the *UUT Manufacturer's Calibration Guide*.
 - b. If no adjustment is provided on the UUT, record the UUT reading at the calibration point as detailed in the *UUT Manufacturer's Calibration Guide*.
5. **9100** Set Output **OFF**.

Final Width = 215mm

Final Width = 215mm

4.13.6.3 Using the 9100 as an Adjustable Source

The following procedure assumes that the instrument is in Manual Mode. In the case of difficulty, re-read *sub-section 3.3.1*. Familiarity with the methods of editing screen values is also assumed (*Section 3*).

9100 and UUT Setup

1. **Connections** Connect the 9100 to the UUT as shown in *Fig. 4.13.4*, and ensure that both instruments are powered ON and warmed up.
2. **UUT** Select Capacitance function.
3. **9100** Ensure that the 9100 is in Capacitance Function with Output OFF. If in any other function, press the '**Aux**' key on the right of the front panel to access Auxiliary functions. Then press the  screen key on the bottom row to select Capacitance Function.

Sequence of Operations

Refer to the table of UUT calibration points in the *UUT Manufacturer's Calibration Guide*. Follow the correct sequence of calibration stages as directed by the guide, and carry out the following operations (**1**) to (**5**) at each stage.

1. **9100** Consult the *UUT Manufacturer's Calibration Guide* to determine the requirements for source current and 2/4 wire connection. Refer to the table in paras 4.13.5.7, and use the front panel controls to set the 9100 Output capacitance to the UUT cal point value, selecting 2-Wire or 4-Wire and Source Current span as required.
2. **UUT** Select the correct range for the cal point.
3. **9100**
 - a. Set Output **ON**.
 - b. Slew the Capacitance Output reading until the UUT reading is equal to the calibration point value.
4. **UUT** Record the 9100 screen output value as detailed in the *UUT Manufacturer's Calibration Guide*.
5. **9100** Set Output **OFF**.

4.14 Thermocouple Function — Operation

4.14.1

This sub-section is a guide to the use of the 9100 for simulating thermocouples, producing a DC Voltage output related to temperature. The following topics are covered:

- 4.14.2 Selection of Thermocouple Function.
 - 4.14.2.1 'Aux' Key.
 - 4.14.2.2 Default Settings.
- 4.14.3 Screen Keys.
 - 4.14.3.1 Bottom Screen Keys.
 - 4.14.3.2 Right Side Screen Keys.
 - 4.14.3.3 Selecting Other Thermocouple Types.
 - 4.14.3.4 Temperature Scales
- 4.14.4 Delivery of DC Voltage Thermocouple Simulation.
 - 4.14.4.1 Simulation Drive.
 - 4.14.4.2 Software Compensation.
 - 4.14.4.3 Simulation Analog.
 - 4.14.4.4 External Connections.
- 4.14.5 Value Editing.
 - 4.14.5.1 Span of Temperature Adjustment.
- 4.14.6 Crossing Thresholds.
 - 4.14.6.1 Temperature Resolution.
 - 4.14.6.2 Hardware Configurations.
- 4.14.7 Thermocouple Routines for Calibrating UUTs.
 - 4.14.7.1 Interconnections
 - 4.14.7.2 Using the 9100 as a Fixed Source
 - 4.14.7.3 Using the 9100 as an Adjustable Source

Final Width = 215mm

In this sub-section, we deal with the range of thermocouple simulation facilities, in a concise way. For those who require more detailed instructions for manipulating the front panel controls, the DC Voltage function was used as an example for the general familiarization tutorials in *Section 3*, and this may provide an introduction to the function.

Final Width = 215mm

4.14.2 Selection of Thermocouple Function

(Manual Mode selected)

4.14.2.1 'Aux' Key

Temperature is an 'Auxiliary' function. The Auxiliary menu screen is selected by pressing the 'Aux' key at the right of the 'CALIBRATION SYSTEM' panel.

Temperature is selected by pressing the °C screen key on the bottom row.

4.14.2.2 Default Settings

At power-on, the system defaults into DC Voltage function. Each time the 'Aux' key is pressed, the system defaults into Auxiliary function.

Whenever the Temperature menu screen is opened from a non-temperature function by pressing the °C screen key on the Auxiliary menu screen, it will appear with the following thermocouple default settings, and with 'K Type' thermocouple selected:

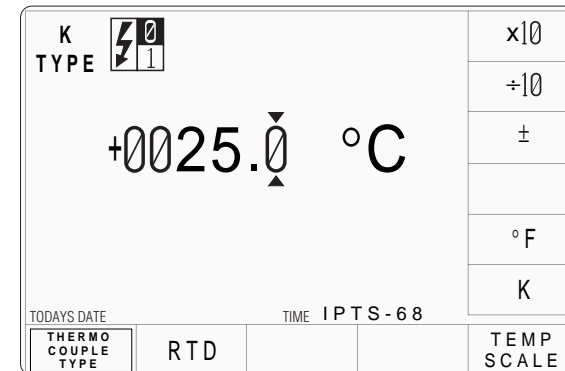

Once entered into a temperature function, switching *between* Thermocouple and RTD function will *retain* the selected unit of temperature (°C, °F or K) and the selected temperature scale (IPTS-68 or ITS-90).

If the unit or scale is changed by screen keys, the new selection will persist until a non-temperature function is selected. Then subsequent reselection of the Thermocouple function will revert to the default shown above.

4.14.3 Screen Keys

4.14.3.1 Bottom Screen Keys

**THERMO
COUPLE
TYPE**

Permits selection of other thermocouple types (*paras 4.14.3.3*).

RTD

Selects RTD function when Thermocouple function is active.

**TEMP
SCALE**

Selects the type of temperature scale: IPTS-68 or ITS-90 when the Thermocouple function is active (*paras 4.14.3.4*).

4.14.3.2 Right Side Screen Keys

A. Digit Edit Keys operate on the temperature value.

x10

Multiplies the temperature value by ten.

÷10

Divides the temperature value by ten.

±

Reverses the polarity of the temperature value (only available when °C or °F has been selected).

°C

Converts the temperature value into degrees Celsius (only available when °F or K is active — the '°C' key label disappears when °C is active).

°F

Converts the temperature value into degrees Fahrenheit (only available when °C or K is active — the '°F' key label disappears when °F is active).

K

Converts the temperature value into Kelvins (only available when °C or °F is active — the 'K' key label disappears when K is active).

B. Direct Edit Right side keys operate on the number in the edit box, and acting in place of the ↵ key, exit from Direct Edit back to Digit Edit, setting the temperature value to that shown in the box.

Temperature

°C

Evaluates the number in the box in **degrees Celsius**.

°F

Evaluates the number in the box in **degrees Fahrenheit**.

K

Evaluates the number in the box in **Kelvins**.

All temperature values have the resolution: **5** significant digits with **1** decimal place.

Final Width = 215mm

Final Width = 215mm

4.14.3 Screen Keys *(Contd.)*

4.14.3.3 Selecting Other Thermocouple Types

Pressing the 'THERMO COUPLE TYPE' key (bottom row) presents a screen with five types of thermocouple listed against the right screen keys:

Pressing the 'MORE' key presents a second screen with four further types of thermocouple:

R, E, B, C, L.

Continued operation of the MORE key will toggle between the two type-selection screens.

Pressing the appropriate 'type' screen key (e.g. 'J' type) sets the internal parameters to simulate the selected thermocouple type.

The screen reverts to the main thermocouple display, but with the selected type identifier transferred to the top left corner:

The operation of the editing keys is unchanged (*paras 4.14.3.2*).

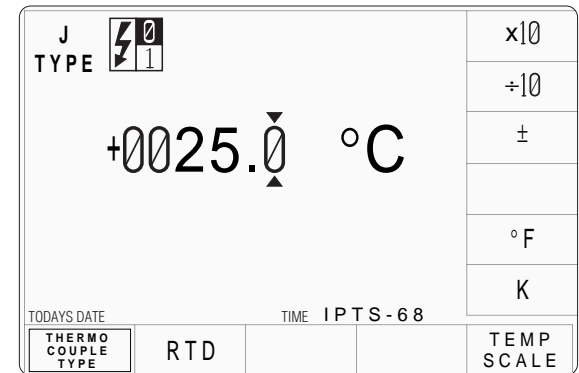
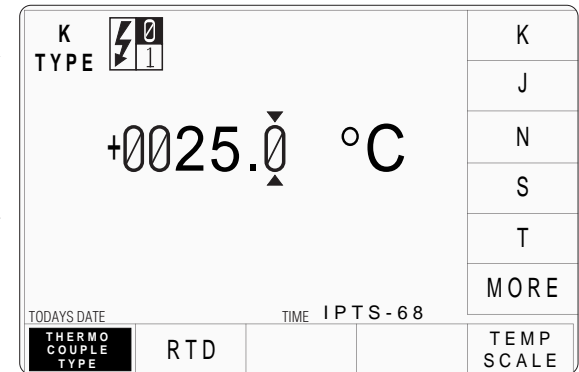

4.14.3.4 Temperature Scales

The 9100 supports two types of temperature scale: IPTS-68 (default) and ITS-90. The 'TEMP SCALE' key toggles between the two scales, and the active selection appears on the bottom right of the screen as shown.

4.14.4 Delivery of DC Voltage Thermocouple Simulation

4.14.4.1 Simulation Drive

The simulation is available only through the 'D-Type' socket beneath the main terminals. Correct interconnections, terminations and materials must be used to maintain traceability. It is assumed that the UUT will use a reference-junction method of compensation in the measurement circuit.

4.14.4.2 Software Compensation (Fig 4.14.1)

One of the 9100 accessories is an isothermal block, which connects directly into the D-type socket on the front of the 9100. This block supports two reference junctions which terminate directly as a two-pin socket, into which a standard thermocouple extension lead for the appropriate thermocouple type can be inserted.

The reference junctions are formed by the contacts between the copper socket pins and the plug pins of the external extension lead.

A thermistor, mounted in thermal conduction with the block and connected to the 9100 through the D-type connection, senses the temperature of the two junctions. This measurement is converted to provide an equivalent reference junction voltage, which in turn is used to compensate for the effect of the junctions' thermoelectric EMFs.

When the Model 9105 leadset is in use, the same connections for the isothermal block are available at a D-type socket, fitted on the end of the leadset connector unit, under the workmat (refer to sub-section 4.2).

The automatic process of updating the compensation, after sensing block temperature, is carried out on the following occasions:

- a. At the point of selecting the Thermocouple function;
- b. At intervals of several seconds, when the Thermocouple function is selected and Output is On.

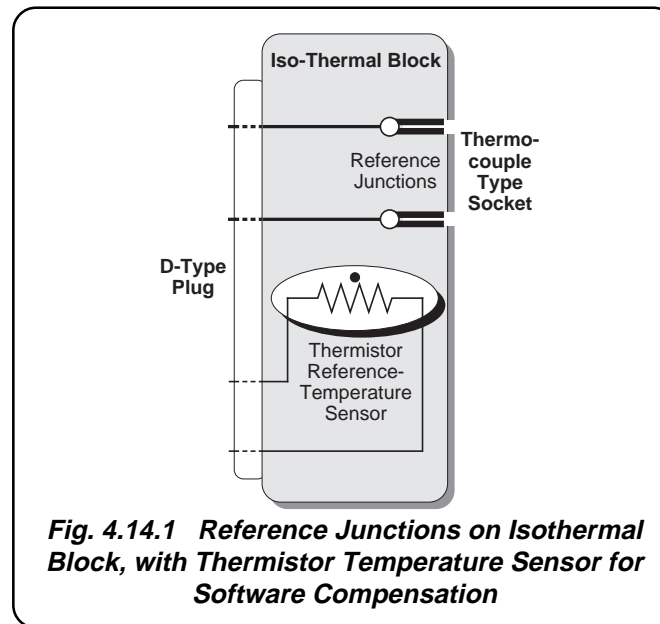

Fig. 4.14.1 Reference Junctions on Isothermal Block, with Thermistor Temperature Sensor for Software Compensation

Final Width = 215mm

4.14.4.3 Simulation Analog

Most thermocouples are inherently non-linear, and thermocouple thermometers incorporate circuitry or software to permit linear temperature scales to be used. The 9100 therefore simulates the non-linearity for each type in order to test the UUT.

The temperature set on the 9100 front panel screen is ultimately converted to a compensated output voltage. For each thermocouple type, a look-up table in firmware converts the temperature setting into a voltage demand, based on the type's published characteristics. The setting resolution of 0.1°C is obtained by interpolation between points on the look-up table.

4.14.4.4 External Connections

After compensation for the reference junctions, the voltage appears on the pins of the extension lead (the correct lead must be used, which will have wires made of the correct extension alloys, so that no further EMF-producing junctions are produced).

Help Available!

Section 3 Editing Tutorials.

Final Width = 215mm

4.14.5 Value Editing

The Temperature value can be edited using 'Digit' and 'Direct' edit facilities as described in *Section 3*.

4.14.5.1 Span of Temperature Adjustment

As can be seen from the representation of the screen in *sub-section 4.14.2*, the Output temperature can be expressed in degrees Celsius, degrees Fahrenheit, or Kelvins. The span of output temperature simulation is given in the table below for all three units:

Thermocouple Type	Temperature Span					
	Celsius (°C)		Fahrenheit (°F)		Kelvin (K)	
	Min	Max	Min	Max	Min	Max
B	+0500.0	+1820.0	+0932.0	+3308.0	0773.0	2093.0
C	0000.0	+2320.0	+0032.0	+4208.0	0273.0	2593.0
E	-0250.0	+1000.0	-0418.0	+1832.0	0023.0	1273.0
J	-0210.0	+1200.0	-0346.0	+2192.0	0063.0	1473.0
K	-0250.0	+1372.0	-0418.0	+2501.0	0023.0	1645.0
L	-0200.0	+0900.0	-0328.0	+1652.0	0073.0	1173.0
N	-0200.0	+1300.0	-0328.0	+2372.0	0073.0	1573.0
R	0000.0	+1767.0	+0032.0	+3212.0	0273.0	2040.0
S	0000.0	+1767.0	+0032.0	+3212.0	0273.0	2040.0
T	-0250.0	+0400.0	-0418.0	+0752.0	0023.0	0673.0

4.14.6 Crossing Thresholds

4.14.6.1 Temperature Resolution

As the temperature value exists in only one resolution:

5 significant digits with 1 decimal place;

there are no resolution thresholds to cross.

4.14.6.2 Hardware Configurations

As the DC Voltage simulation of the thermocouple is served by only one hardware configuration, there are no hardware configuration thresholds to cross.

4.14.7 Thermocouple Routines for Calibrating UUTs

4.14.7.1 Interconnections

The general connection scheme for UUT calibration is illustrated in *Fig. 4.14.2*. Always use the correct extension cable from the thermocouple socket on the isothermal block to the UUT thermocouple input. Observe the correct polarity, otherwise spurious junctions may be set up.

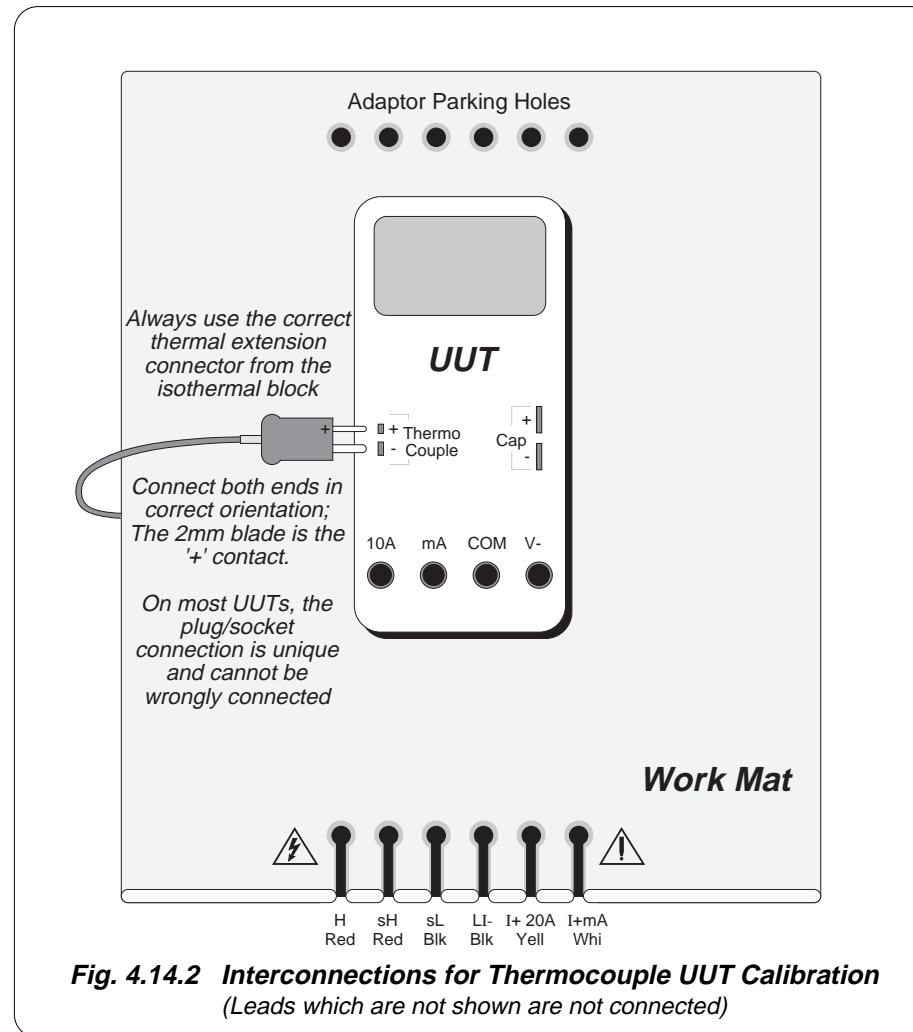

Final Width = 215mm

Final Width = 215mm

4.14.7.2 Using the 9100 as a Fixed Source

The following procedure assumes that the instrument is in Manual Mode. In the case of difficulty, re-read *Section 3; sub-section 3.3.1*. Familiarity with the methods of editing screen values is also assumed (*Section 3*).

9100 and UUT Setup

1. **Connections** Connect the 9100 to the UUT as shown in *Fig. 4.14.2*, and ensure that both instruments are powered ON and warmed up. Ensure that the CJC pod fitted to the leadset connection block (or 9100 front panel) is the same unit that was calibrated together with the 9100 unit in use.
2. **UUT** Select the Thermocouple Temperature function.
3. **9100**
 - a. Ensure that the 9100 is in Thermocouple Function with Output OFF. If in any other function, press the **Aux** key on the right of the front panel, then the °C screen key.

Sequence of Operations

Refer to the table or list of UUT calibration points in the *UUT Manufacturer's Calibration Guide*.

Follow the correct sequence of calibration stages as directed by the guide, and carry out the following operations (*1*) to (*5*) at each stage.

1. **9100**
 - a. Ensure that the correct parameters (thermocouple type, temperature scale, and unit of temperature) are selected.
 - b. Use the front panel controls to set the 9100 Output Temperature to the UUT cal point value.
2. **UUT** Select the correct range for the cal point.
3. **9100**
 - a. Set Output **ON**.
 - b. Note the UUT reading.
4. **UUT**
 - a. If a UUT calibration adjustment is provided, adjust the UUT reading to be equal to that on the 9100 screen, as detailed in the *UUT Manufacturer's Calibration Guide*.
 - b. If no adjustment is provided on the UUT, record the UUT reading at the calibration point as detailed in the *UUT Manufacturer's Calibration Guide*.
5. **9100** Set Output **OFF**.

4.14.7.3 Using the 9100 as an Adjustable Source

The following procedure assumes that the instrument is in Manual Mode. In the case of difficulty, re-read *sub-section 3.3.1*. Familiarity with the methods of editing screen values is also assumed (*Section 3*).

9100 and UUT Setup

1. **Connections** Connect the 9100 to the UUT as shown in *Fig. 4.14.2*, and ensure that both instruments are powered ON and warmed up. Ensure that the CJC pod fitted to the leadset connection block (or 9100 front panel) is the same unit that was calibrated together with the 9100 unit in use.
2. **UUT** Select the Thermocouple Temperature function.
3. **9100** a. Ensure that the 9100 is in Thermocouple Function with Output OFF. If in any other function, press the **Aux** key on the right of the front panel, then the °C screen key.

Sequence of Operations

Refer to the table of UUT calibration points in the *UUT Manufacturer's Calibration Guide*. Follow the correct sequence of calibration stages as directed by the guide, and carry out the following operations (1) to (5) at each stage.

1. **9100** a. Ensure that the correct parameters (thermocouple type, temperature scale, and unit of temperature) are selected.
b. Use the front panel controls to set the 9100 Output Temperature to the UUT cal point value.
2. **UUT** Select the correct range for the cal point.
3. **9100** a. Set Output ON.
b. Slew the Temperature reading until the UUT reading is equal to the calibration point value.
4. **UUT** Record the 9100 screen output value as detailed in the *UUT Manufacturer's Calibration Guide*.
5. **9100** Set Output OFF.

Final Width = 215mm

4.15 RTD Temperature Function — Operation

4.15.1

This sub-section is a guide to the use of the 9100 for simulating a RTD sensor, producing a Resistance output related to temperature. The following topics are covered:

- 4.15.2 Selection of RTD Temperature Function.
 - 4.15.2.1 'Aux' Key.
 - 4.15.2.2 Default Settings.
 - 4.15.2.3 RTD Nominal Resistance and Conformance Curve.
- 4.15.3 Screen Keys.
 - 4.15.3.1 Bottom Screen Keys.
 - 4.15.3.2 Right Side Screen Keys.
 - 4.15.3.3 Selecting Other RTD Types.
 - 4.15.3.4 Temperature Scales
- 4.15.4 Delivery of Resistance Simulation of Platinum-Resistance Thermometer Sensor.
 - 4.15.4.1 Simulation Drive.
 - 4.15.4.2 Simulation Analog.
 - 4.15.4.3 Configuration for RTD Temperature Measurement in UUTs.
 - 4.15.4.4 Configuration for RTD Temperature Function in the 9100.
 - 4.15.4.5 4-wire Connection for RTD Temperature Function.
 - 4.15.4.6 2-wire Connection.
 - 4.15.4.7 Spans of Source Currents.
- 4.15.5 Value Editing.
 - 4.15.5.1 Span of Temperature Adjustment.
- 4.15.6 Crossing Thresholds.
 - 4.15.6.1 Temperature Resolution.
 - 4.15.6.2 Hardware Configurations.
- 4.15.7 RTD Temperature Routines for Calibrating UUTs.
 - 4.15.7.1 Interconnections
 - 4.15.7.2 Using the 9100 as a Fixed Source
 - 4.15.7.3 Using the 9100 as an Adjustable Source

Final Width = 215mm

In this sub-section, we deal with the range of RTD simulation facilities, in a concise way. For those who require more detailed instructions for manipulating the front panel controls, the DC Voltage function was used as an example for the general familiarization tutorials in *Section 3*, and this may provide an introduction to the function.

4.15.2 Selection of RTD Temperature Function

4.15.2.1 'Aux' Key

Temperature is an 'Auxiliary' function. The Auxiliary menu screen is selected by pressing the 'Aux' key at the right of the 'CALIBRATION SYSTEM' panel. Temperature is selected by pressing the °C screen key on the bottom row.

4.15.2.2 Default Settings

At power-on, the system defaults into DC Voltage function. Each time the 'Aux' key is pressed, the system defaults into Auxiliary function.

Whenever the Temperature menu screen is opened from a non-temperature function by pressing the °C screen key on the Auxiliary menu screen, the Thermocouple screen will appear with 'K Type' selected.

RTD is selected via the Thermocouple menu screen by pressing the RTD screen key on the bottom row. Unless changes were made in Thermocouple function before selecting RTD, the RTD menu screen will appear with the following default settings:

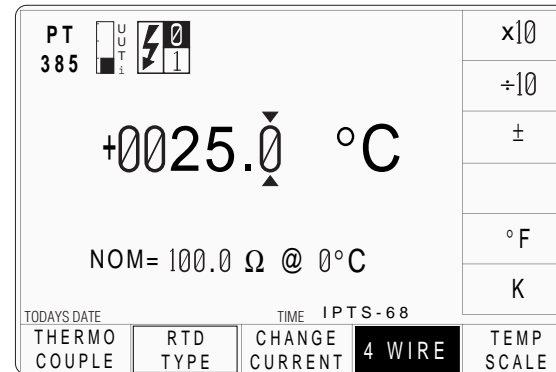

Final Width = 215mm

Once entered into a temperature function, switching *between* Thermocouple and RTD function will *retain* the selected unit of temperature (°C, °F or K) and the selected temperature scale (IPTS-68 or ITS-90).

If the unit or scale is changed by screen keys, the new selection will persist until a non-temperature function is selected. Then subsequent reselection of the RTD function, without changes in Thermocouple function, will revert to the default shown above.

4.15.2.3 RTD Nominal Resistance and Conformance Curve

The system defaults to provide parameters which simulate a platinum-resistance thermometer whose 0°C nominal value is 100Ω, conforming to the European curve PT385, and using the temperature scale IPTS-68. The nominal value is shown on the screen, and can be adjusted between 10Ω and 2kΩ using the normal digit and direct editing methods described in *Section 3*.

The simulation can be made to conform to a second curve, the US PT392. This can be selected using the RTD TYPE key as described in *paras 4.15.3.3*.

4.15.3 Screen Keys

4.15.3.1 Bottom Screen Keys

THERMO

COUPLE Selects K-Type function when RTD function is active.

RTD

TYPE Permits selection of other conformance curves (*paras 415.3.3*).

CHANGE CURRENT Scales the analog circuitry to accept alternative constant source currents (*refer to paras 4.15.4.7*).

4 WIRE Connects the analog circuitry as a 4-wire source when selected. (*refer to paras 4.15.4.5/6 — 4-Wire is the default*).

TEMP SCALE Selects the type of temperature scale: IPTS-68 or ITS-90 when the RTD function is active (*paras 4.15.3.4*).

4.15.3.2 Right Side Screen Keys

A. Digit Edit Facility Keys operate on the temperature value.

X10 Multiplies the temperature value by ten.

÷10 Divides the temperature value by ten.

± Reverses the polarity of the temperature value (only available when °C or °F has been selected).

°C Converts the temperature value into degrees Celsius (only available when °F or K is active — the '°C' screen key label disappears when °C is active).

°F Converts the temperature value into degrees Fahrenheit (only available when °C or K is active — the '°F' screen key label disappears when °F is active).

K Converts the temperature value into Kelvins (only available when °C or °F is active — the 'K' screen key label disappears when K is active).

B. Direct Edit Facility Keys operate on the number in the edit box, and acting in place of the ↵ key, exit from Direct Edit back to Digit Edit, setting the temperature value as evaluated in the box.

Temperature

°C Evaluates the number in the box in **degrees Celsius**.

°F Evaluates the number in the box in **degrees Fahrenheit**.

K Evaluates the number in the box in **Kelvins**.

All temperature values have the same resolution:

6 significant digits with **2** places of decimals.

Final Width = 215mm

Final Width = 215mm

4.15.3 Screen Keys (Contd.)

4.15.3.3 Selecting Other RTD Types

Pressing the 'RTD TYPE' key (bottom row) presents a screen with the two types of RTD listed against the right screen keys:

Pressing the appropriate 'type' screen key (e.g. 'PT392' type) sets the internal parameters to simulate the selected RTD type.

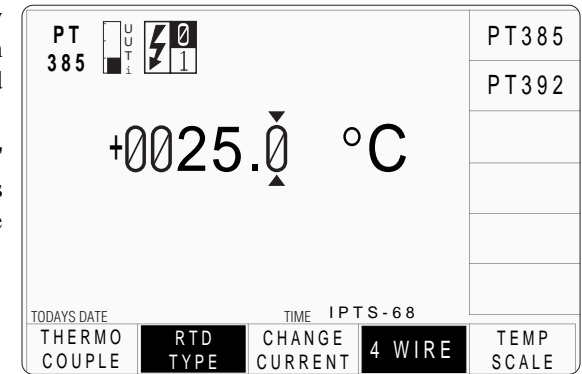

The screen reverts to the main RTD display, but with the selected type identifier transferred to the top left corner:

The operation of the editing keys is unchanged (paras 4.15.3.2).

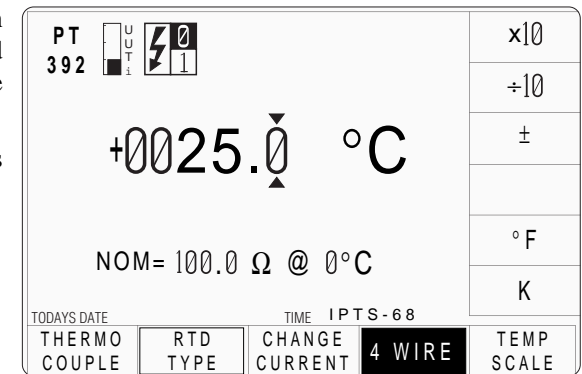

4.15.3.4 Temperature Scales

The 9100 supports two types of temperature scale: IPTS-68 (default) and ITS-90. The 'TEMP SCALE' key toggles between the two scales, and the active selection appears on the bottom right of the screen as shown.

4.15.4 Delivery of Resistance Simulation of RTD Sensor

4.15.4.1 Simulation Drive

The simulation is available only through the main front panel terminals. Correct interconnections must be used to maintain traceability. It is assumed that the UUT will measure resistance directly.

4.15.4.2 Simulation Analog

The RTD sensor is inherently non-linear, and sensor thermometers incorporate circuitry or software to permit linear temperature scales to be used. The 9100 is therefore required to simulate the RTD non-linearity in order to test the UUT.

The temperature set on the 9100 front panel screen is ultimately converted to a compensated output resistance. For each type of RTD sensor, a formula is embedded in firmware. This formula converts the temperature setting into a resistance demand, based on the published non-linear characteristics of the RTD sensor. The output resolution of 0.01°C is obtained through that formula.

4.15.4.3 Configuration for RTD Temperature Measurement in UUTs

Instruments which measure resistance, generally use a method which drives a 'pseudo-constant' current (I_r) through the Resistance-Temperature Detector (RTD — often a platinum-resistance thermometer element), measuring the voltage (V_r) developed across it. Internal circuits then calculate the resistance digitally, using a form of Ohm's Law:

$$R = V/I$$

Subsequent calculations use the published non-linear characteristics of the RTD sensor to convert the measured resistance value into a temperature value.

The 9100 assumes that this form of measurement is employed by the UUT. A simplified illustration is shown in *Fig. 4.15.1*:

Note that because I_r passes through external test leads connecting the resistor to the terminals, the voltage sensed across the terminals will include the lead volts drops, so the result here will also include the resistance of the UUT's external leads.

Final Width = 215mm

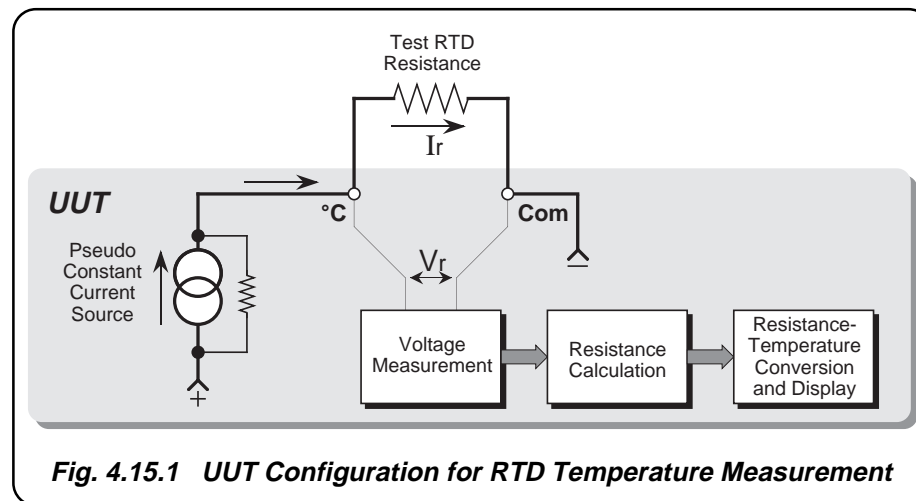

Fig. 4.15.1 UUT Configuration for RTD Temperature Measurement

Final Width = 215mm

4.15.4.4 Configuration for RTD Temperature Function in the 9100

The 9100 uses 'Active Impedance' technology to output a 'Virtual Resistance'. The method relies on the UUT having a form of measurement illustrated by Fig. 4.15.1.

The 9100 will produce a DC voltage (V_R) in response to a DC current (I_R) being sourced from the UUT. The value of the voltage is derived electronically from the value of the I_R multiplied by the Total Resistance Demand value (R_T) converted from the temperature set on the display: $V_R = I_R \times R_T$.

The effect is that of placing a resistor of value R_T (Virtual Resistance) between the front panel Hi and Lo terminals of the 9100. The method is shown in Fig. 4.15.2.

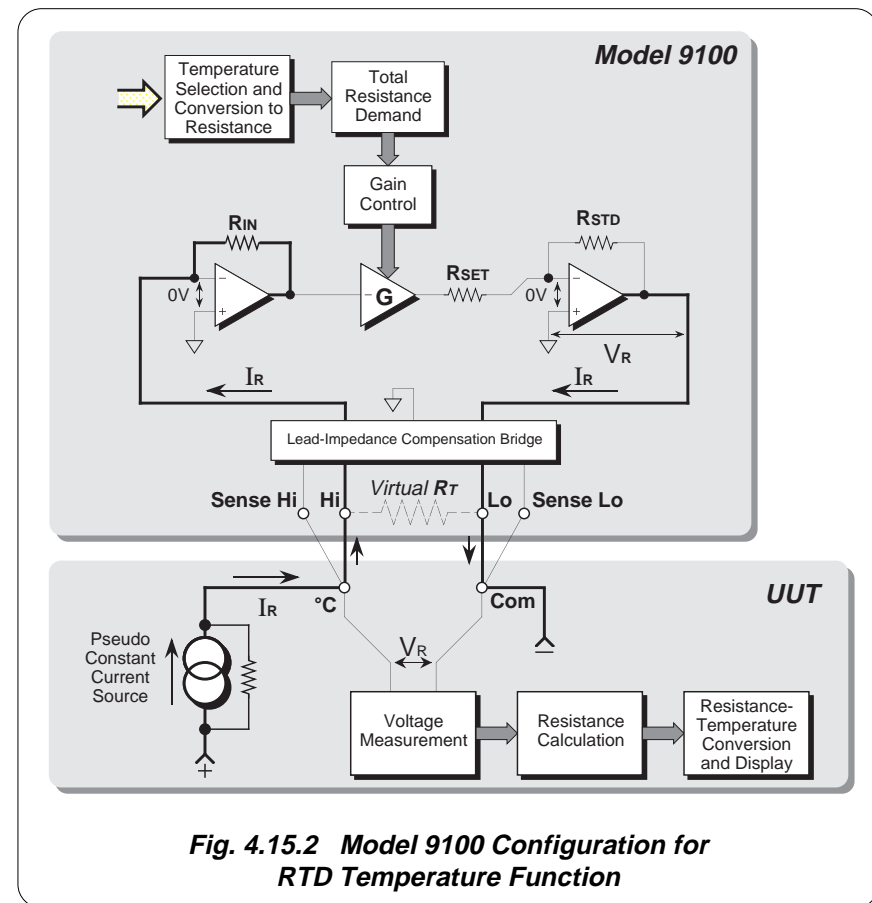

Fig. 4.15.2 Model 9100 Configuration for RTD Temperature Function

RTD Temperature Function Action

The UUT drives the current I_R through R_{IN} via the Hi terminal, and draws I_R out via the Lo terminal. The value of R_{IN} accommodates the value of current I_R . This first stage acts as a current-to-voltage converter, whose output is a negative DC voltage of value $I_R \times R_{IN}$, with respect to the virtual ground at the converter input. This voltage is presented as input to the gain-control amplifier '-G'

The system gain is set from the temperature selection by the Total Resistance Demand value (R_T) transferred by DAC to control the gain of amplifier '-G'. The final amplifier is switched by R_{STD} and R_{SET} in decade values. It generates a negative DC output voltage V_R , equal to $I_R \times R_T$, across the Hi and Lo terminals; while sourcing the current I_R drawn by the UUT from the Lo terminal.

The value of the virtual resistance R_T is given by: $R_T = R_{IN} \times G \times R_{STD} / R_{SET}$

4.15.4.5 4-Wire Connection for RTD Temperature Function

In order to protect the 9100 output, fuses and low-value protection resistors are placed internally in series with each of the current-carrying wires. Also, as noted earlier, the external current-carrying wires have their own resistance. The Lead-Impedance Compensation Bridge is used to compensate for these impedances between the voltage V_R and the UUT input.

In *Fig. 4.15.2*, the 9100 and UUT are shown in 4-wire connection. One pair of wires passes I_R (Hi and Lo at the 9100), while the second pair (sHi and sLo) senses the voltage at the UUT input terminals.

The bridge receives the sensed voltage from the UUT terminals. If this is not exactly the same as V_R , the bridge compensates for any volts drops in the protection circuitry and interconnecting leads, maintaining V_R at the UUT input.

It is **most important** that a four-wire connection be used for RTD Temperature function. The Model 9105 Leadset, supplied with the 9100, provides a four-wire connection. It is recommended that the leadset be fitted, using its four short banana leads, whenever the 9100 is being used in RTD Temperature function.

When a four-wire connection is being used, the **'4 WIRE'** screen key beneath the 9100 LCD display should be selected (light characters on a dark background). Four-wire operation is already selected in the default condition of RTD function.

Refer to *pages 4.15-2/3*.

Caution:

The greatest error exists when 2-wire connections are being used, with 4-wire selected.

Final Width = 215mm

Final Width = 215mm

4.15.4.6 2-Wire Connection

If it is deemed absolutely necessary to use a two wire connection, the 9100 should be informed by de-selecting '4 WIRE'. As illustrated in Fig.4.15.3, the 9100 will then permanently short Hi to Hi Sense, and Lo to Lo Sense, so that at least the internal protection circuitry is compensated. Measurements made by the UUT will, of course, still include the resistance of the two interconnecting leads. *Do not use 2-wire connections when '4 WIRE' is selected on the 9100.*

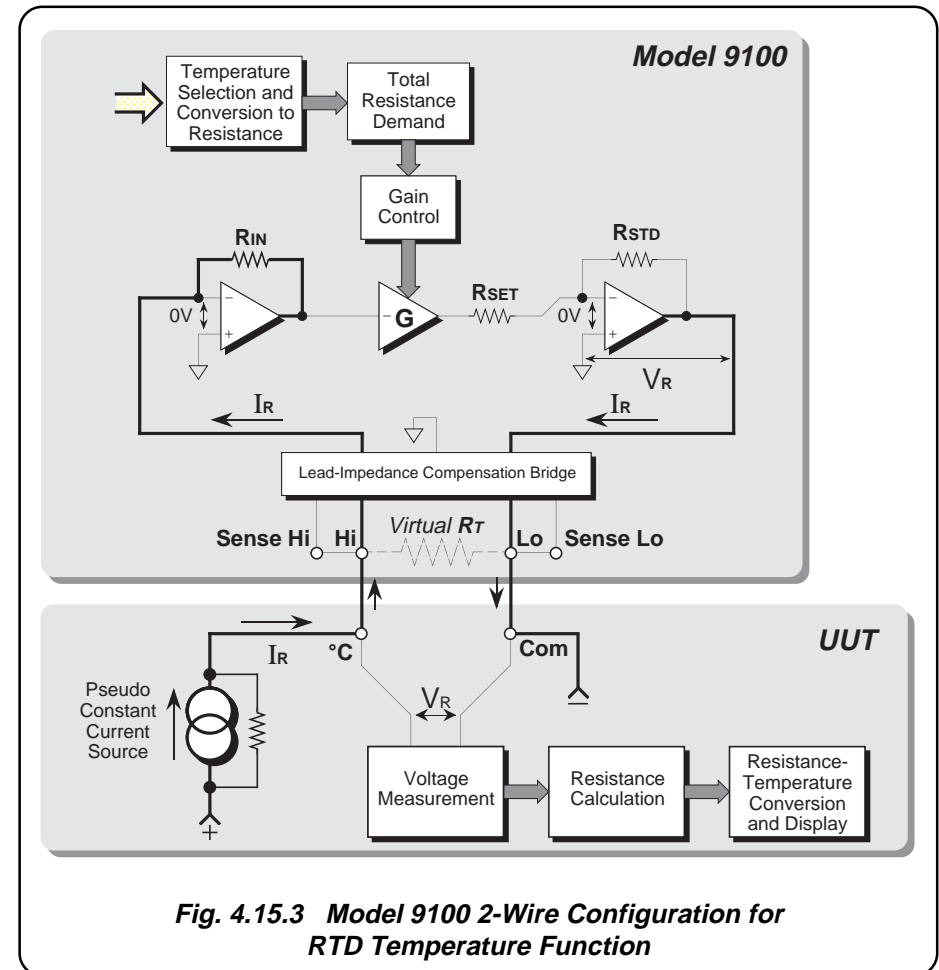

Fig. 4.15.3 Model 9100 2-Wire Configuration for RTD Temperature Function

4.15.4.7 Spans of Source Currents

In the synthesized resistance technology used in the 9100, the constant current sourced from the UUT must fall within one of a maximum of three spans of values for each resistance value, as a result of setting the RTD 0°C nominal value and dialling each temperature value. The spans of constant source currents acceptable to the 9100, are shown against their corresponding spans of output resistance in the following table:

Hardware Configuration Limits on Span of Output Resistance	UUTi Low	Constant Source Current Limits	
		UUTi High	UUTi Super
00.0000 Ω to 40.0000 Ω	250μA to 3.5mA	2.5mA to 35mA	25mA to 350mA
040.001 Ω to 400.000 Ω	25μA to 320μA	250μA to 3.5mA	2.5mA to 35mA
0.40001 kΩ to 4.00000 kΩ	25μA to 320μA	250μA to 3.5mA	2.5mA to 35mA
04.0001 kΩ to 10.0000 kΩ*	2.5μA to 32μA	25μA to 350μA	250μA to 3.5mA

* = Resistance span used when the nominal zero of the detector is raised, to give resistance values above 4kΩ for certain temperature readings.

When the RTD function is entered from another function, the default temperature setting is +25°C (resistance a little above 100Ω as default nominal zero is 100Ω), coupled with the default current span of 'UUTi Low'. As the resistance span is altered within RTD function, the 9100 will default to the current span nearest to that previously in use. For instance, when decreasing the output setting from the default 25°C — UUTi high current span (250μA to 3.5mA), to -160°C (approx 35Ω in the 0-40Ω resistance span), the 9100 will automatically select the low current span (250μA to 3.5mA). If a different Current span is required, it will be necessary to select it manually by pressing the **CHANGE CURRENT** screen key until the chosen span is selected (*refer to pages 4.15-2/3*). The indications given on the screen for the three different spans are as follows:

Final Width = 215mm

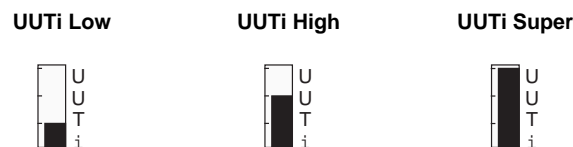

Output Voltage Limitation

At any UUTi span, the 9100 will seek a suitable configuration of hardware to accommodate both the value of source current within the limits, and the value of resistance by the set Output Value of Temperature. The maximum nominal output voltage is 10V, such that: $I_R \times R_T = \leq 10V$.

Any RTD Temperature value within the total span can be selected. However, if the source current exceeds the upper limit, the circuit will be saturated, and a warning will be given. Also, a warning will be given if the source current is less than the lower limit. When a warning appears, the instrument will still function, but the specification will be compromised. In the 0Ω to 40Ω configuration, low current warnings will not be given as this configuration may be used as a reference point for the resistance configurations.

Always choose the lowest possible UUTi setting at which no 'Sense current high' warning appears; i.e. if a warning is given on a particular UUTi span, work up to use the first span at which the warning disappears.

Help Available!

Section 3 Editing Tutorials.

Final Width = 215mm

4.15.5 Value Editing

The Temperature value can be edited using 'Digit' and 'Direct' edit facilities as described in *Section 3*.

4.15.5.1 Span of Temperature Adjustment

As can be seen from the representation of the screen in *sub-section 4.15.2*, the Output temperature can be expressed in degrees Celsius, Fahrenheit or Kelvin. The span of output temperature simulation is given in the table below for all three units:

Unit of Temperature	PT385		PT392	
	Minimum Value	Maximum Value	Minimum Value	Maximum Value
Celsius	-0200.00°C	+0850.00°C	-0200.00°C	+0630.00°C
Fahrenheit	-0328.00°F	+1562.00°F	+0212.00°F	+1166.00°F
Kelvin	0073.15K	1123.15K	0173.15K	0903.15K

4.15.6 Crossing Thresholds

4.15.6.1 Temperature Resolution

As the temperature value exists in only one resolution:

6 significant digits with **2** places of decimals;

there are no resolution thresholds to cross.

4.15.6.2 Hardware Configurations

Transfer between hardware configurations is transparent to the user, as described below:

When increasing or decreasing temperature and hence output resistance, using any method: if the new resistance is too large or small for the present hardware configuration, then if OUTPUT is OFF there will be no noticeable effect as the hardware reconfigures.

If OUTPUT is ON, it will be temporarily turned OFF so that the hardware can reconfigure, then ON again at the new resistance. No warning will be given. This interruption should cause little disturbance to the reading on any UUT.

When moving from one hardware configuration to another, the 9100 will attempt to retain the same current output for the new output value.

4.15.7 RTD Temperature Routines for Calibrating UUTs

4.15.7.1 Interconnections

The general connection scheme for UUT calibration is illustrated in *Fig. 4.15.4*. The use of either 4-wire remote sensing at the UUT terminals, or 2-wire local sensing at the 9100 terminals, is served by the same connections from the 9105 at the work mat. Selection of 2/4-wire is carried out on the 9100 front panel.

For UUTs without *safety* banana sockets, use appropriate adaptors.

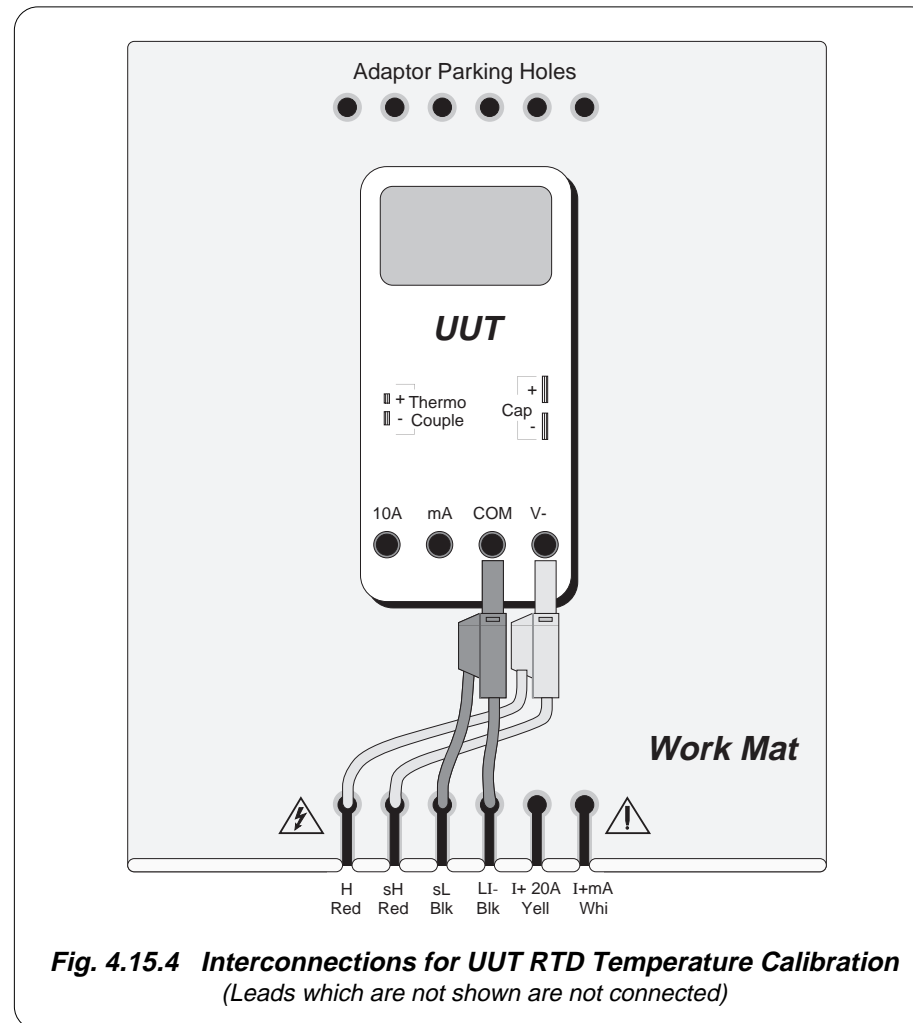

Final Width = 215mm

Final Width = 215mm

4.15.7.2 Using the 9100 as a Fixed Source

The following procedure assumes that the instrument is in Manual Mode. In the case of difficulty, re-read *Section 3; sub-section 3.3.1*. Familiarity with the methods of editing screen values is also assumed (*Section 3*).

9100 and UUT Setup

1. **Connections** Connect the 9100 to the UUT as shown in *Fig. 4.15.4*, and ensure that both instruments are powered ON and warmed up.
2. **UUT** Select the RTD Temperature function.
3. **9100**
 - a. Ensure that the 9100 is in RTD Temperature Function with Output OFF. If in any other function, press the **Aux** key on the right of the front panel, then the °C screen key on the bottom row. Finally press the **RTD** screen key on the bottom row.
 - b. Use the RTD TYPE key to select the required conformance curve (PT385 or PT392).
 - c. Select the required temperature scale.
 - d. Use an edit facility to set the RTD's 0°C Nominal Value.

Sequence of Operations

Refer to the list of UUT calibration points in the *UUT Manufacturer's Calibration Guide*. Follow the correct sequence of calibration stages as directed by the guide, and carry out the following operations (*1*) to (*5*) at each stage.

1. **9100**
 - a. Ensure that the correct parameters (RTD type, temperature scale, and unit of temperature) are selected.
 - b. Use the front panel controls to set the 9100 Output Temperature to the UUT cal point value, selecting 2-Wire or 4-Wire and 'UUTi' Current Span as required.
2. **UUT** Select the correct range for the cal point.
3. **9100**
 - a. Set Output **ON**.
 - b. Note the UUT reading.
4. **UUT**
 - a. If a UUT calibration adjustment is provided, adjust the UUT reading to be equal to that on the 9100 screen, as detailed in the *UUT Manufacturer's Calibration Guide*.
 - b. If no adjustment is provided on the UUT, record the UUT reading at the calibration point as detailed in the *UUT Manufacturer's Calibration Guide*.
5. **9100** Set Output **OFF**.

4.15.7.3 Using the 9100 as an Adjustable Source

The following procedure assumes that the instrument is in Manual Mode. In the case of difficulty, re-read *sub-section 3.3.1*. Familiarity with the methods of editing screen values is also assumed (*Section 3*).

9100 and UUT Setup

1. **Connections** Connect the 9100 to the UUT as shown in *Fig. 4.15.4*, and ensure that both instruments are powered ON and warmed up.
2. **UUT** Select the RTD Temperature function.
3. **9100**
 - a. Ensure that the 9100 is in RTD Temperature Function with Output OFF. If in any other function, press the **Aux** key on the right of the front panel, then the °C screen key on the bottom row. Finally press the **RTD** screen key on the bottom row.
 - b. Use the RTD TYPE key to select the required conformance curve (PT385 or PT392).
 - c. Select the required temperature scale.
 - d. Use an edit facility to set the RTD's 0°C Nominal Value.

Final Width = 215mm

Sequence of Operations

Refer to the list of UUT calibration points in the *UUT Manufacturer's Calibration Guide*. Follow the correct sequence of calibration stages as directed by the guide, and carry out the following operations (1) to (5) at each stage.

1. **9100**
 - a. Ensure that the correct parameters (RTD type, temperature scale, and unit of temperature) are selected.
 - b. Use the front panel controls to set the 9100 Output Temperature to the UUT cal point value, selecting 2-Wire or 4-Wire and 'UUTi' Current Span as required.
2. **UUT** Select the correct range for the cal point.
3. **9100**
 - a. Set Output **ON**.
 - b. Slew the Temperature reading until the UUT reading is equal to the calibration point value.
4. **UUT** Record the 9100 screen output value as detailed in the *UUT Manufacturer's Calibration Guide*.
5. **9100** Set Output **OFF**.

4.16 Logic-Pulses Function — Operation

4.16.1

This sub-section is a guide to the use of the 9100 for generating logic pulses with defined pulse width and repetition interval. The following topics are covered:

4.16.2 Selection of Logic-Pulses Function.

4.16.2.1 'Aux' Key.

4.16.2.2 Default Settings.

4.16.3 Screen Keys.

4.16.3.1 Bottom Screen Keys.

4.16.3.2 Right Side Screen Keys.

4.16.4 Value Editing.

4.16.4.1 'Pulse Width' and 'Repetition' Time-Intervals.

4.16.4.2 'Pulse Width' and 'Repetition' Time-Interval Editing.

4.16.5 Crossing Thresholds.

4.16.5.1 Time-Interval Resolution Thresholds.

4.16.5.2 Hardware Configurations.

4.16.6 'Logic-Pulses' Routines for Calibrating UUTs.

4.16.6.1 Interconnections

4.16.6.2 Using the 9100 as a Fixed Source

4.16.6.3 Using the 9100 as an Adjustable Source

Final Width = 215mm

In this sub-section, we deal with the full range of 'Pulse Width/Repetition Interval' facilities, in a concise way. For those who require more detailed instructions for manipulating the front panel controls, the DC Voltage function was used as an example for the general familiarization tutorials in *Section 3*.

Final Width = 215mm

4.16.2 Selection of Logic-Pulses Function

(Manual Mode selected)

4.16.2.1 'Aux' Key

Logic-Pulses is an 'Auxiliary' function. The Auxiliary menu screen is selected by pressing the 'Aux' key at the right of the 'CALIBRATION SYSTEM' panel.

Logic-Pulses is selected by pressing the 'LOGIC' screen key on the bottom row.

4.16.2.2 Default Settings

At power-on the system defaults into DC Voltage function. Each time the 'Aux' key is pressed, the system defaults into Auxiliary function.

Whenever the Logic-Pulses menu screen is opened by pressing the 'LOGIC' screen key on the Auxiliary menu screen, except on recovery from a standby period, it will appear with the following default settings, with '□□□□' selected:

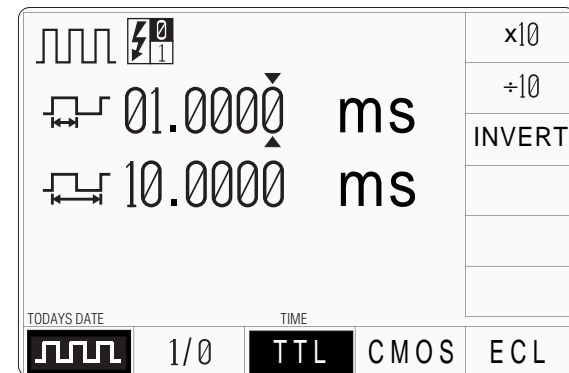

4.16.3 Screen Keys

4.16.3.1 Bottom Screen Keys

	Selects Logic-Pulse when Logic-Level is active.
1/∅	Selects Logic-Level when Logic-Pulse is active.
TTL	Selects TTL pulse levels when CMOS or ECL is active. (TTL levels: High = +5V; Low = 0V).
CMOS	Selects CMOS pulse levels when TTL or ECL is active. (CMOS levels: High = +5V; Low = 0V).
ECL	Selects ECL pulse levels when TTL or CMOS is active. (ECL levels: High = -0.9V; Low = -1.75V).

4.16.3.2 Right Side Screen Keys

A. Digit Edit Facility Keys operate on the value marked by the cursor.

X	10 Multiplies the marked value by ten.
÷	10 Divides the marked value by ten. (For X10 or ÷10, the selected Pulse Width or Repetition interval value is set into the highest resolution available to its magnitude).
INVERT	Inverts the Mark/Space ratio of the waveform. The INVERT key is only available when the cursor is selecting the Pulse Width interval.

Final Width = 215mm

B. Direct Edit Facility Right side keys operate on the value in the edit box, and acting in place of the ↵ key, exit from Direct Edit back to Digit Edit; then set the value as evaluated in the box.

Pulse Width or Repetition Intervals

μs	Evaluates the number in the box in Microseconds .
ms	Evaluates the number in the box in Milliseconds .
s	Evaluates the number in the box in Seconds .

The selected Pulse Width or Repetition interval value is set into the highest resolution available to its magnitude.

Help Available!

Section 3 Editing Tutorials.

Final Width = 215mm

4.16.4 Value Editing

4.16.4.1 'Pulse Width' and 'Repetition' Time-Intervals

Pulse width and repetition time-intervals can be changed using 'Digit' and 'Direct' edit facilities as described in *Section 3*. On the 'Logic-Pulse' menu screen (illustrated on *page 4.16-2*) the 'Repetition' time-interval is placed beneath the 'Pulse Width' time-interval in the center of the screen, as indicated by the icons on the left.

Default Output Waveshape

The default output (TTL levels) is a continuous stream of 1ms-wide positive pulses at a repetition interval of 10ms — equating to a 1:10 mark/period ratio; 1:9 mark/space ratio; i.e. 10% duty cycle at 100 pulses per second (pps) — with fixed switching levels, as shown below in *Fig 4.16.1*:

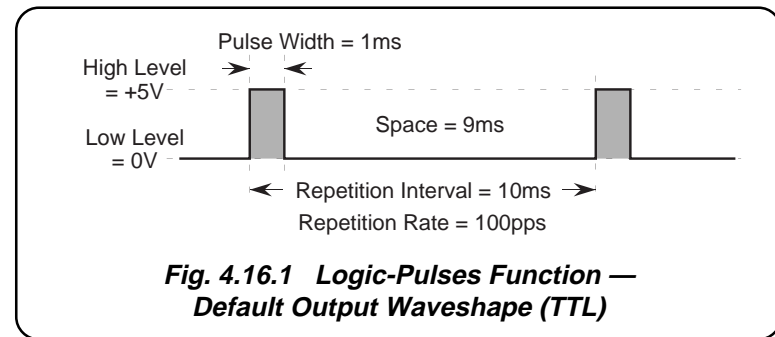

Effect of Selecting TTL, CMOS and ECL

Selecting between TTL, CMOS and ECL will only alter the high and low switching levels, shown in the table below. The selected pulse width and repetition interval will remain the same.

Selected Logic	Signal Level	Voltage
TTL	High	+5.00 V
	Low	0.00 V
CMOS	High	+5.00 V
	Low	0.00 V
ECL	High	-0.90 V
	Low	-1.75 V

4.16.4.2 'Pulse Width' and 'Repetition' Time-Interval Editing

Pulse Width and Repetition time-intervals can be changed using 'Digit' and 'Direct' edit facilities. The editing processes are not described in Section 3, but follow the same general rules as for editing voltages.

The resolution of time-interval values is set at six significant digits, except for the shortest span of intervals at four significant digits. This leads to four interval spans. The 'Pulse Width' interval value must always be at least $0.3\mu\text{s}$ shorter than the 'Repetition' interval.

The thresholds between resolutions of Pulse Width interval and of Repetition interval are given in *paras 4.16.5.1*.

Hardware configurations for time-interval change are given in *paras 4.16.5.2*.

Final Width = 215mm

Final Width = 215mm

4.16.5 Crossing Thresholds

4.16.5.1 Time-Interval Resolution Thresholds

The different time-interval resolutions are distinguished by two characteristics:

- Shortest and longest time-intervals available.
- Absolute resolution of the least-significant digit.

'Pulse Width' Time-Intervals

The following table shows the spans of output **Pulse Width** time-intervals for the Logic-Pulses Function, against their associated resolutions.

Absolute Resolution	Span of Time-Intervals
100ns	000.3 μ s to 999.9 μ s
100ns	00.0003 ms to 99.9999 ms
1 μ s	000.001 ms to 999.999 ms
10 μ s	0000.01 ms to 1999.99 ms

'Repetition' Time-Intervals

The following table shows the spans of output **Repetition** time-intervals for the Logic-Pulses Function, against their associated resolutions.

Absolute Resolution	Span of Time-Intervals
100ns	000.6 μ s to 999.9 μ s
100ns	00.0006 ms to 99.9999 ms
1 μ s	000.001 ms to 999.999 ms
10 μ s	0000.01 ms to 2000.00 ms

Pulse Width/Repetition Ratio Limits

The Pulse Width and Repetition time-intervals can be adjusted over their entire range of values provided that the Pulse Width time-interval remains at least 0.3 μ s shorter than the Repetition time-interval. An audible warning will be given if an attempt is made to set a Pulse Width or Repetition time-interval which would produce a Pulse Width/Repetition Interval ratio of 1 or greater. The user must reset either the Pulse Width or the Repetition Interval to give a ratio less than 1. This rule applies whether OUTPUT is OFF or ON.

Increasing Pulse Width or Repetition Time-Interval Value

Using the \odot key in Digit Edit facility; an audible warning will be given if the new value is too large for the present span of time-intervals, with a reminder (Up range required) on the screen. The user must change to the next lower resolution, with a larger span of intervals, using the $\langle \rangle$ key. This rule applies whether OUTPUT is OFF or ON.

When using either the X10 screen key or the Direct Edit facility; if the new value is too large for the present resolution, a lower resolution will be activated with a larger span of time-intervals. No warning will be given. This rule applies whether OUTPUT is OFF or ON.

Decreasing Pulse Width or Repetition Time-Interval Value

Using Digit Edit; time-intervals down to 0.01ms lie within all spans, but to select intervals shorter than this, one of the four lower spans of intervals must be used.

If the required time-interval lies between steps of the present resolution, then the user must increase resolution using the $\langle \rangle$ key, also reducing the span of intervals. This rule applies whether OUTPUT is OFF or ON.

Using either the $\div 10$ screen key or Direct Editing; if the required time-interval lies between increments of the present resolution, a greater resolution will be activated with reduced span. No warning will be given. This rule applies whether OUTPUT is OFF or ON.

Final Width = 215mm

4.16.5.2 Hardware Configurations

Time-Interval Changes

When increasing or decreasing time-interval, using any method: if the new interval is too large or small for the present hardware configuration, then if OUTPUT is OFF there will be no noticeable effect as the hardware reconfigures.

If OUTPUT is ON, it will be temporarily turned OFF so that the hardware can reconfigure, then ON again at the new time-interval. No warning is given. This interruption should cause little disturbance to the reading on any UUT.

Final Width = 215mm

4.16.6 Logic-Pulses Routines for Calibrating UUTs

4.16.6.1 Interconnections

The general connection scheme for UUT calibration is illustrated in *Fig. 4.16.2*.

For UUTs without *safety* banana sockets, use appropriate adaptors.

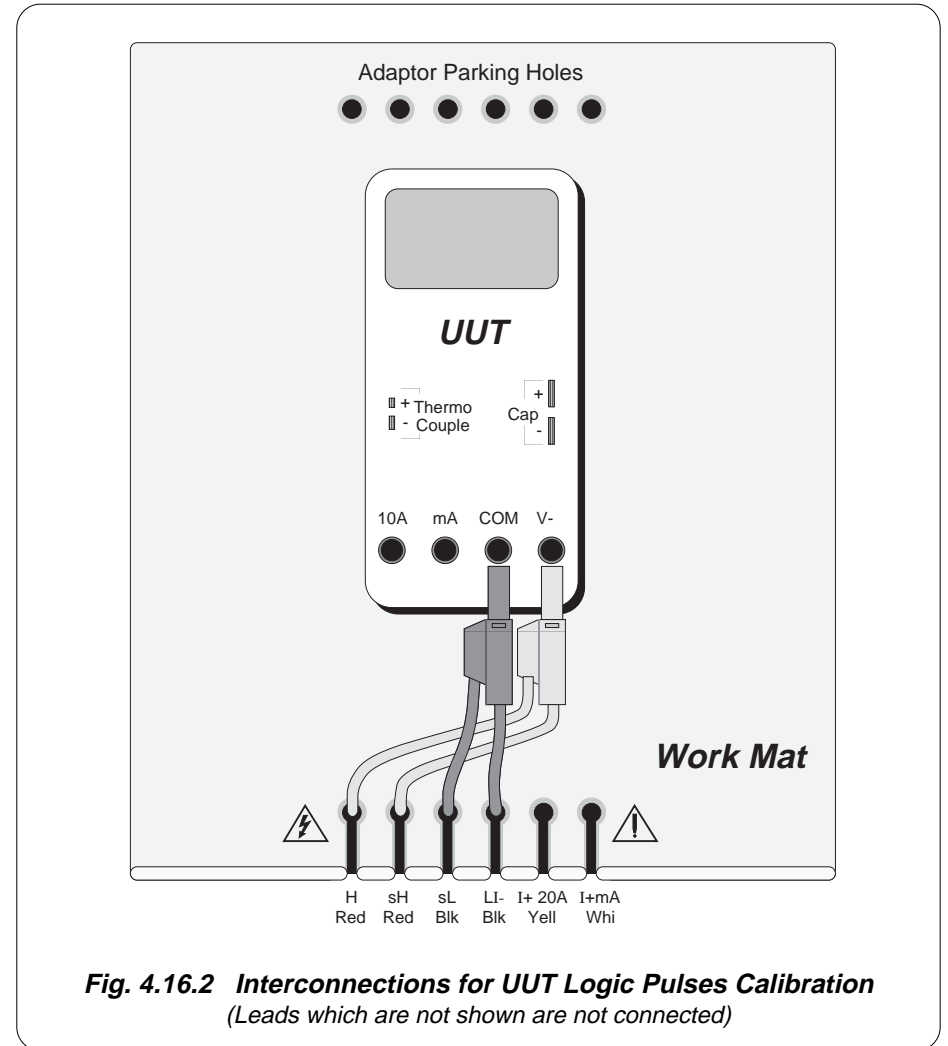

4.16.6.2 Using the 9100 as a Fixed Source

The following procedure assumes that the instrument is in Manual Mode. In the case of difficulty, re-read *Section 3; sub-section 3.3.1*. Familiarity with the methods of editing screen values is also assumed (*Section 3*).

9100 and UUT Setup

1. **Connections** Connect the 9100 to the UUT as shown in *Fig. 4.16.2*, and ensure that both instruments are powered ON and warmed up.
2. **UUT** Select 'Logic Pulses' function.
3. **9100** Ensure that the 9100 is in Logic Pulses Function with Output OFF. If in any other function, press the '**Aux**' key on the right of the front panel, then the 'LOGIC' screen key on the bottom row.
If 1/Ø function is selected, press the '' screen key.

Sequence of Operations

Refer to the table or list of UUT calibration points in the *UUT Manufacturer's Calibration Guide* for the UUT.

Follow the correct sequence of calibration stages as directed by the guide, and carry out the following operations (**1**) to (**5**) at each stage.

1. **9100** Use the front panel controls to set the 9100 Output to the UUT cal point parameters, and select the required logic signal:
Pulse width, and Repetition interval;
TTL signal, or CMOS signal, or ECL signal.
2. **UUT** Select the correct range or response for the cal point.
3. **9100**
 - a. Set Output **ON**.
 - b. Note the UUT reading or response.
4. **UUT**
 - a. If a UUT calibration adjustment is provided, adjust the UUT reading or response to be appropriate to the 9100 screen settings, as detailed in the *UUT Manufacturer's Calibration Guide*.
 - b. If no adjustment is provided on the UUT, record the UUT reading or response at the calibration point as detailed in the *UUT Manufacturer's Calibration Guide*.
5. **9100** Set Output **OFF**.

Final Width = 215mm

Final Width = 215mm

4.16.6.3 Using the 9100 as an Adjustable Source

The following procedure assumes that the instrument is in Manual Mode. In the case of difficulty, re-read *sub-section 3.3.1*. Familiarity with the methods of editing screen values is also assumed (*Section 3*).

Calibration Setup

1. **Connections** Connect the 9100 to the UUT as shown in *Fig. 4.16.2*, and ensure that both instruments are powered ON and warmed up.
2. **UUT** Select 'Logic Pulses' function.
3. **9100** Ensure that the 9100 is in Logic Pulses Function with Output OFF. If in any other function, press the '**Aux**' key on the right of the front panel, then the 'LOGIC' screen key on the bottom row.

If 1/Ø function is selected, press the '' screen key.

Sequence of Operations

Refer to the table of UUT calibration points in the *UUT Manufacturer's Calibration Guide*. Follow the correct sequence of calibration stages as directed by the guide, and carry out the following operations (*1*) to (*5*) at each stage.

1. **9100** Use the front panel controls to set the 9100 Output to the UUT cal point parameters, and select the required logic signal level:
Pulse width, and Repetition interval;
TTL signal, or CMOS signal, or ECL signal.
2. **UUT** Select the correct range or response for the cal point.
3. **9100**
 - a. Set Output **ON**.
 - b. Slew the required Output parameter until the UUT reading or response is appropriate to the screen Output settings.
4. **UUT** Record the 9100 screen output settings as detailed in the *UUT Manufacturer's Calibration Guide*.
5. **9100** Set Output **OFF**.

4.17 Logic-Levels Function — Operation

4.17.1

This sub-section is a guide to the use of the 9100 for generating test DC Voltage levels for TTL, CMOS and ECL logic. The following topics are covered:

4.17.2 Selection of Logic-Levels Function.

4.17.2.1 'Aux' Key.

4.17.2.2 Default Settings.

4.17.3 Screen Keys.

4.17.3.1 Bottom Screen Keys.

4.17.3.2 Right Side Screen Keys.

4.17.4 Value Editing.

4.17.4.1 DC Voltage Values.

4.17.5 Crossing Thresholds.

4.17.5.1 Logic-Level Resolution.

4.17.5.2 Hardware Configurations.

4.17.6 'Logic-Levels' Routines for Calibrating UUTs.

4.17.6.1 Interconnections

4.17.6.2 Using the 9100 as a Fixed Source

4.17.6.3 Using the 9100 as an Adjustable Source

Final Width = 215mm

In this sub-section, we deal with the full range of 'Logic-Levels' facilities, in a concise way. For those who require more detailed instructions for manipulating the front panel controls, the DC Voltage function was used as an example for the general familiarization tutorials in *Section 3*.

Final Width = 215mm

4.17.2 Selection of Logic-Levels Function

(Manual Mode selected)

4.17.2.1 'Aux' Key

'Logic-Levels' is an 'Auxiliary' function. The Auxiliary menu screen is selected by pressing the 'Aux' key at the right of the 'CALIBRATION SYSTEM' panel.

'Logic-Pulses' is selected by pressing the LOGIC screen key on the bottom row of the 'Aux' menu screen.

'Logic-Levels' is selected by pressing the $1/\emptyset$ screen key on the bottom row of the 'Logic-Pulses' menu screen.

4.17.2.2 Default Settings

At power-on the system defaults into DC Voltage function. Each time the 'Aux' key is pressed, the system defaults into Auxiliary function.

Whenever the LOGIC screen key is pressed on the Auxiliary menu screen, it will default to the Logic-Pulses menu screen, with '□□□□' selected.

Whenever the Logic-Levels menu screen is opened by pressing the ' $1/\emptyset$ ' screen key on the Logic-Pulses menu screen, except on recovery from a standby period, it will appear with the following default settings, and with ' $1/\emptyset$ ' selected:

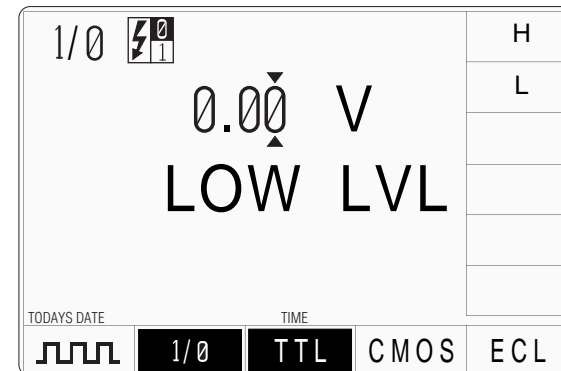

4.17.3 Screen Keys

4.17.3.1 Bottom Screen Keys



Selects **Logic-Pulse** when Logic-Level is active.

1/0

Selects **Logic-Level** when Logic-Pulse is active.

When **1/0** is selected and active:

TTL

Selects **TTL** DC Voltage level when CMOS or ECL is active.
TTL default level: Low = 0V; (default High = +5V).

CMOS

Selects **CMOS** DC Voltage levels when TTL or ECL is active.
CMOS default level: Low = 0V; (default High = +5V).

ECL

Selects **ECL** DC Voltage levels when TTL or CMOS is active.
ECL default level: High = -0.9V (default Low = -1.75V).

4.17.3.2 Right Side Screen Keys

A. Digit Edit Facility Keys operate on the DC Voltage value only.

H

Resets the DC Voltage to default **High** for the selected logic.

L

Resets the DC Voltage to default **Low** for the selected logic.

Final Width = 215mm

B. Direct Edit Facility Right side keys operate on the value in the edit box, and acting in place of the ↵ key, exit from Direct Edit back to Digit Edit; then set the value as evaluated in the box.

i. DC Voltage Level

V

Evaluates the number in the box in **Volts**.

The DC Voltage Level value is set into a resolution of three significant digits with two decimal places.

Help Available!

Section 3 Editing Tutorials.

Final Width = 215mm

4.17.4 Value Editing

4.17.4.1 DC Voltage Values

DC Voltage values can be changed using 'Digit' and 'Direct' edit facilities as described in Section 3. On the '1/Ø' menu screen (illustrated on page 4.17-2), the current DC Voltage value is placed at the center of the screen.

High/Intermediate/Low Level Indications

An indication of high, intermediate, or low level value is placed beneath the current DC Voltage value.

As the DC Voltage value is adjusted, this level indication will change as the value passes across recognized boundaries within the currently-selected type of logic. These boundaries are given in the table below, which also shows the screen indications.

Upper Adjustment Limits

The output DC Voltage signal value can be adjusted between the High and Low default levels; and for TTL and CMOS can be set more positive than the High default level, but not more negative than the Low default level. The default levels and Upper Adjustment Limits are also given in the table below.

Logic Type	Signal Level	Screen Indication	Default Value ('H' or 'L')	Boundaries	Adjustment Limits
TTL	High	HIGH LVL	+5.00V	$V > +2.00V$	5.50V
	Intermediate	— — — —	---	$+0.80V < V < +2.00V$	---
	Low	LOW LVL	0.00V *	$V < 0.80V$	0.00V
CMOS	High	HIGH LVL	+5.00V	$V > +3.50V$	6.00V
	Intermediate	— — — —	---	$+1.50V < V < +3.50V$	---
	Low	LOW LVL	0.00V *	$V \leq 1.50V$	0.00V
ECL	High	HIGH LVL	-0.9V *	$V > -1.11V$	0.00V
	Intermediate	— — — —	---	$-1.48V < V < -1.11V$	---
	Low	LOW LVL	-1.75V	$V < -1.48V$	-5.20V

* indicates the default value on selection of that logic family.

4.17.5 Crossing Thresholds

4.17.5.1 Logic-Level Resolution

As the DC Voltage value exists in only one resolution:

3 significant digits with 2 places of decimals;

there are no resolution thresholds to cross.

4.17.5.2 Hardware Configurations

As the DC Voltage output values are obtainable from only one hardware configuration, there are no hardware configuration thresholds to cross.

Final Width = 215mm

Final Width = 215mm

4.17.6 Logic-Levels Routines for Calibrating UUTs

4.17.6.1 Interconnections

The general connection scheme for UUT calibration is illustrated in *Fig. 4.17.1*.

For UUTs without *safety* banana sockets, use appropriate adaptors.

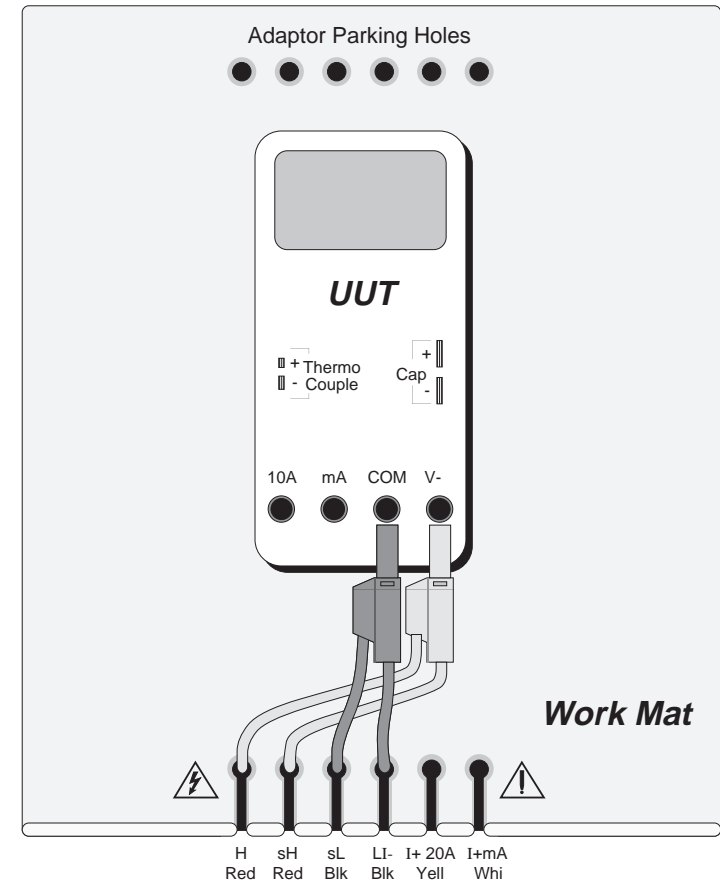

Fig. 4.17.1 Interconnections for UUT Logic-Levels Calibration
(Leads which are not shown are not connected)

4.17.6.2 Using the 9100 as a Fixed Source

The following procedure assumes that the instrument is in Manual Mode. In the case of difficulty, re-read *Section 3; sub-section 3.3.1*. Familiarity with the methods of editing screen values is also assumed (*Section 3*).

9100 and UUT Setup

1. **Connections** Connect the 9100 to the UUT as shown in *Fig. 4.17.1*, and ensure that both instruments are powered ON and warmed up.
2. **UUT** Select Logic-Levels function.
3. **9100** Ensure that the 9100 is in Logic-Levels Function with Output OFF. If in any other function, press the **Aux** key on the right of the front panel, then the LOGIC screen key on the bottom row. Finally press the **1/0** screen key on the bottom row.

Sequence of Operations

Refer to the table or list of UUT calibration points in the *UUT Manufacturer's Calibration Guide*.

Follow the correct sequence of calibration stages as directed by the guide, and carry out the following operations (1) to (5) at each stage.

1. **9100** Use the front panel controls to set the 9100 Output to select the UUT cal point logic signal and set the required parameters:
 TTL signal, or CMOS signal, or ECL signal.
 Voltage Level (use 'H' or 'L' screen keys if required),
2. **UUT** Select the correct range or response for the cal point.
3. **9100**
 - a. Set Output **ON**.
 - b. Note the UUT reading or response.
4. **UUT**
 - a. If a UUT calibration adjustment is provided, adjust the UUT reading or response to be appropriate to the 9100 screen settings, as detailed in the *UUT Manufacturer's Calibration Guide*.
 - b. If no adjustment is provided on the UUT, record the UUT reading or response at the calibration point as detailed in the *UUT Manufacturer's Calibration Guide*.
5. **9100** Set Output **OFF**.

Final Width = 215mm

Final Width = 215mm

4.17.6.3 Using the 9100 as an Adjustable Source

The following procedure assumes that the instrument is in Manual Mode. In the case of difficulty, re-read *sub-section 3.3.1*. Familiarity with the methods of editing screen values is also assumed (*Section 3*).

Calibration Setup

1. **Connections** Connect the 9100 to the UUT as shown in *Fig. 4.17.1*, and ensure that both instruments are powered ON and warmed up.
2. **UUT** Select Logic-Levels function.
3. **9100** Ensure that the 9100 is in Logic-Levels Function with Output OFF. If in any other function, press the **Aux** key on the right of the front panel, then the LOGIC screen key on the bottom row. Finally press the **1/∅** screen key on the bottom row.

Sequence of Operations

Refer to the table of UUT calibration points in the *UUT Manufacturer's Calibration Guide*. Follow the correct sequence of calibration stages as directed by the guide, and carry out the following operations (*1*) to (*5*) at each stage.

1. **9100** Use the front panel controls to set the 9100 Output to select the UUT cal point logic signal and set the required parameters:
TTL signal, or CMOS signal, or ECL signal.
Voltage Level (use 'H' or 'L' screen keys if required),
2. **UUT** Select the correct range or response for the cal point.
3. **9100**
 - a. Set Output **ON**.
 - b. Slew the Logic-Levels Output reading until the UUT reading or response is appropriate to the screen Output settings.
4. **UUT** Record the 9100 screen output settings as detailed in the *UUT Manufacturer's Calibration Guide*.
5. **9100** Set Output **OFF**.

4.18 Insulation/Continuity Function — Operation

4.18.1 Introduction

This sub-section is a guide to the use of the Model 9100 Option 135 — an option that extends the functionality of the active resistance feature to include the calibration of hand-held insulation and continuity testers.

Option 135 allows both manual and procedure mode calibration of the ‘250V/500V/1000V’ class of hand-held meters, designed to test the insulation resistance and continuity of electrical circuits and installations. These meters provide the facility for testing insulation resistance at a nominal DC potential of 250V, 500V or 1000V, in addition to testing circuit connectivity at a nominal DC current of 200 milliamperes.

Option 135 has two modes of operation:-

- 1) A continuity mode, where 4-wire active ohms with a 350mA maximum current capability is provided in three ranges, with a visual indication of the current provided by the unit-under-test (UUT).
- 2) An insulation mode, where 2-wire high voltage active ohms with a 1350V DC maximum voltage capability is provided in five ranges, with a visual indication of the output voltage provided by the unit-under-test together with a derived value of output current for the user’s convenience.

This section assumes that the reader is familiar with the Model 9100 user interface, soft keys, layout and control system of the active resistance function. If this is not the case, please refer to *Section 4.7* for a more detailed description before attempting to use Option 135.

CAUTION

The injection of very high voltages (up to 5000 volts) from a breakdown or ‘Hipot’ tester would be likely to cause ‘flashover’ and permanently damage the input to the Model 9100. This is a serious consideration and must not be overlooked by the user. The Model 9100 Option 135 is only intended to calibrate hand-held 1000V class insulation and continuity testers. It will not calibrate flash testers, high voltage MEGGERS™, insulation breakdown testers or Hipot testers, all of which produce very high voltages in excess of the capability of the Model 9100 Option 135. Fluke will not be held responsible for damage to the Model 9100 caused by misuse with inappropriate equipment, and any such use will render the user’s warranty invalid.

Please confirm that the maximum voltage output capability of the unit you wish to calibrate is less than 1350VDC before attempting to use the Model 9100 Option 135 function.



**DANGER
HIGH VOLTAGE**



**THIS INSTRUMENT IS CAPABLE OF DELIVERING
A LETHAL ELECTRIC SHOCK !**

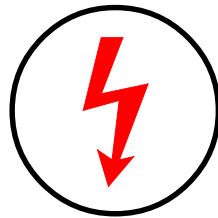

When using insulation testers, potentially lethal voltages are produced. It is essential to take extreme care to avoid the risk of electric shock.

THIS CAN KILL !

In particular!

1. Always ensure the tester is turned OFF before connecting or disconnecting test leads.
2. Always use test leads which are in good condition, fully insulated and have a suitably high insulation voltage capability (the Model 9105 lead mat is suitable).
3. Do not touch the connections during any part of the test.
4. Never get the tester or the Model 9100 wet or near to sources of water.
5. Never operate the unit in damp conditions or in very high relative humidity.
6. Always turn the tester OFF immediately after completing each test.



4.18.2 Selection of Insulation/Continuity Function

The Insulation and Continuity functions are accessed via the 'Aux' key on the right hand side of the 9100, followed by the 'Insulation/Continuity' softkey:



4.18.2.1 Default setting

When you enter the Insulation/Continuity function, it will appear with the following default screen settings:

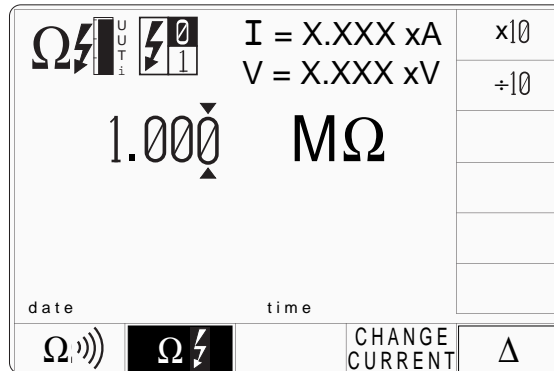

4.18.3 Screen Keys

4.18.3.1 Bottom Screen Keys

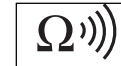

Selects the **Continuity** function. This defaults to 4-wire continuity mode, which is not selectable by the user. The Continuity function is permanently connected in 4-wire mode, for the following reasons:

1. The resistances measured by continuity meters are typically very low (a few ohms or less)
2. The current used to measure these resistances is relatively high (typically at least 200mA). Voltage drops across the test leads and the instrument's internal resistance would therefore be significant and would produce relatively large measurement errors



Selects the **Insulation** function. This is the default function when the Insulation/Continuity option is selected. The user can toggle between Insulation and Continuity functions using the two softkeys along the bottom of the screen.



Scales the internal high voltage active impedance circuitry to accept alternative input currents on a given impedance value. See *Section 4.18.7.2* for a more detailed description of this function.

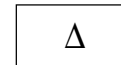

The delta key provides access to the 'Percentage Deviation' and 'Resistance Offset' displays to adjust the absolute value of output impedance. These fields operate in the same manner as for the existing active ohms circuit, and the user is encouraged to refer to *Section 4.7.3.3 and 4.7.4.1* for a more detailed explanation.

4.18.3.2 Right Side Screen Keys

A. Digit Edit Facility Keys operate on the value marked by the cursor.

X10 Multiplies the marked value by ten.

÷10 Divides the marked value by ten.

B. Direct Edit Facility Right side keys operate on the value in the edit box, and acting in place of the ↵ key, exit from Direct Edit back to Digit Edit; then set the value multiplier as evaluated in the box.

i. Output Value and Offset Value

Ω Evaluates the number in the box as **Ohms**

kΩ Evaluates the number in the box as **Kilohms**

MΩ Evaluates the number in the box as **Megohms**

GΩ Evaluates the number in the box as **Gigohms**

ii. Deviation Value

% Evaluates the number in the box in **Percentage Deviation**. Refer to section 4.7.3 for a further explanation with examples.

4.18.4 Icons and Other Screen Information

When Insulation mode is active (i.e. the insulation icon appears at the top left of the screen), there is a bargraph icon representing which of the two available current modes is selected for the particular requested resistance. The output defaults to Super I (Super Current) mode, i.e. the bargraph is shown all the way up. This is the most suitable current for the class of insulation testers for which the Option 135 is designed. However, some testers that operate at a lower test voltage/current may not be ideally suited to the internal dynamic range of the Option 135, and the two current modes provided by this option allow the user to compensate for this. *Refer to section 4.18.7.2 for a more detailed description.*

The 16th edition of the I.E.E. wiring regulations (713-02 to 713-12) requires that an insulation tester must be capable of providing the following test currents and voltages into the specified load impedance:

Range	Load impedance	Minimum Current	Minimum Voltage
250V	250k Ω	1mA	250.0V
500V	500k Ω	1mA	500.0V
1000V	1M Ω	1mA	1000V

In order to ascertain that the UUT is providing sufficient test voltage at each of its respective test points, the output voltage across the load must be measured when calibrating the unit. Model 9100 Option 135 provides a display of UUT output voltage and current in the top right-hand corner of the screen to enable the user to confirm that this is the case. When a (high) voltage is not being applied, these values default to **X.XXX xA** and **X.XXX xV** respectively.

4.18.5 Continuity Mode Operation

Access to the Continuity mode is made via the Continuity screen softkey: 

When Continuity mode is selected, the following default screen appears:

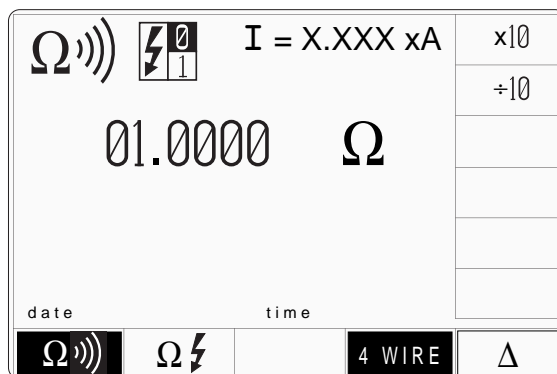

The Continuity function operates over the following three hardware ranges:

Absolute Resolution	Span of Values		Nominal Span Value
0.1mΩ	00.0000Ω	40.0000Ω	40Ω
1mΩ	000.000Ω	400.000Ω	400Ω
10mΩ	0.00000kΩ	4.00000kΩ	4kΩ

The operation of the Continuity function is essentially the same as the existing Active Resistance function, with the following exceptions:

1. The output resistance is permanently locked into '4-WIRE' mode. This is because at the low resistance values and high test currents which continuity testers use (at least 200mA into a short circuit), the series resistance of the test leads and the internal resistances of the UUT and 9100 would cause measurement inaccuracies. Always ensure that you connect the UUT to the instrument in 4-wire mode when conducting continuity tests (connect the **HI** to **Sense HI** and the **LO** to **Sense LO** terminals *at the input terminals of the UUT*, using either stackable insulated plug leads or the red and black terminals of the 9105 lead mat).

-
2. There is no **CHANGE CURRENT** key. The internal dynamic range settings of the Model 9100 hardware have been optimally configured for continuity measurements. Correspondingly, there is no bargraph indication of the UUT current setting as this is automatically adjusted by the Model 9100.
 3. The output current of the UUT is displayed in the upper right-hand corner of the screen. This is for confirmation that the output current of the continuity tester complies with its minimum current specification. This display defaults to X.XXXX xA when no test is being conducted.

Refer to sections 4.7.5.4 and 4.7.5.5 for a more detailed explanation of the operation and configuration of the Active Ohms circuit.

4.18.6 Insulation Test Operation

On entering the Insulation/Continuity function, or pressing the Insulation softkey from Continuity mode, the default insulation screen appears.

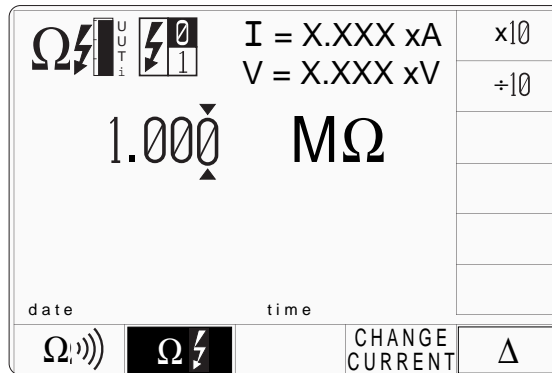

The insulation resistance value defaults to 1.000MΩ.

To perform a verification of an insulation tester, the following procedure should be followed:

1. Connect the insulation tester's positive output terminal to the 9100 **HI** terminal and the insulation tester's negative output terminal to the 9100 **LO** terminal. You may connect the UUT either in 2-wire or 4-wire configuration, as the high-voltage active impedance is a 2-wire function. Assuming the UUT has 4mm input terminals, it is recommended that you use the 9105 leadset. See the diagram below:

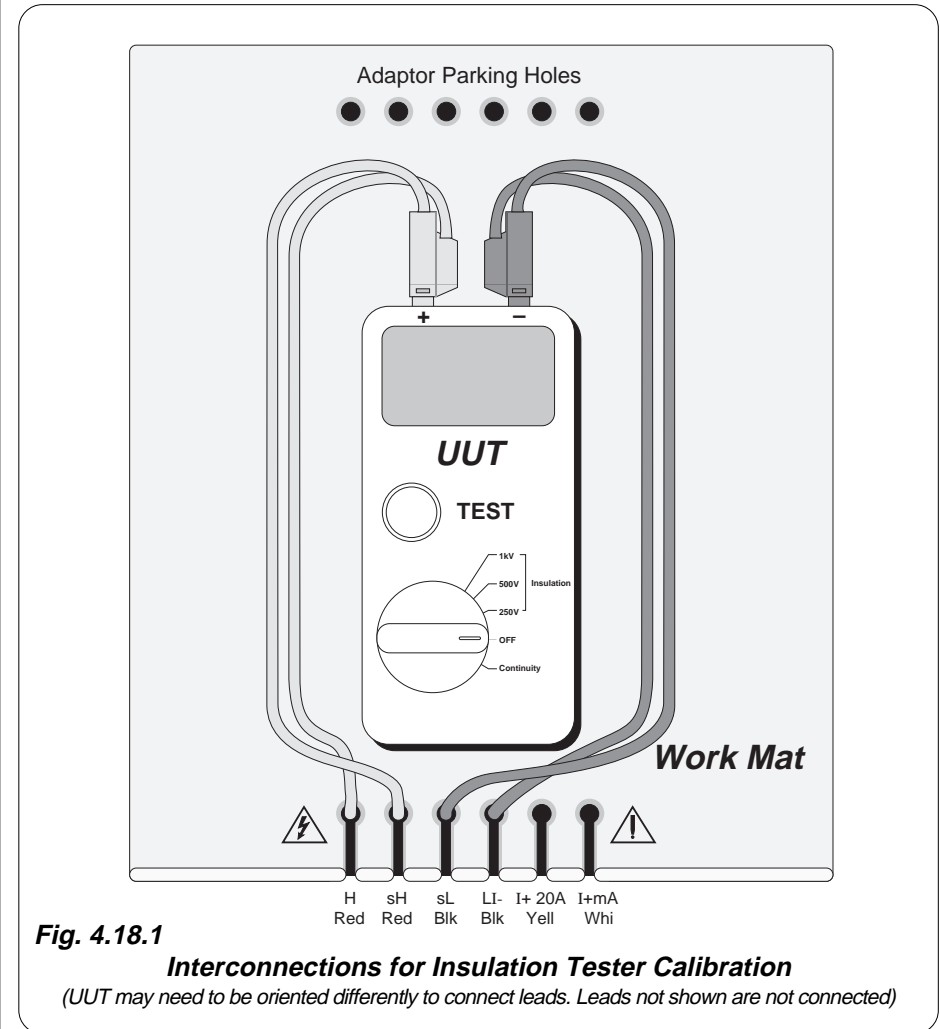

-
2. Select the desired resistance value on the 9100 screen, using either the Direct or Digit Edit method.
 3. Turn the 9100 output **ON**. The unit will beep for a few seconds before switching on to indicate that high voltages may be present across the terminals.
 4. Taking care not to touch any connections, push the test button on the UUT and note the reading. Many insulation testers take several seconds to settle, especially on high resistance values (above 10M Ω). Release the test button immediately after you have performed the test.

You may adjust the **Percentage Deviation** and **Offset** fields or the absolute value of resistance output while the UUT is on. However, always be aware of the settling time of the UUT.

4.18.7 Operation of Insulation Resistance

4.18.7.1 Overview

The following simplified diagram shows the operation of an insulation tester in conjunction with the Option 135 high voltage active ohms circuit.

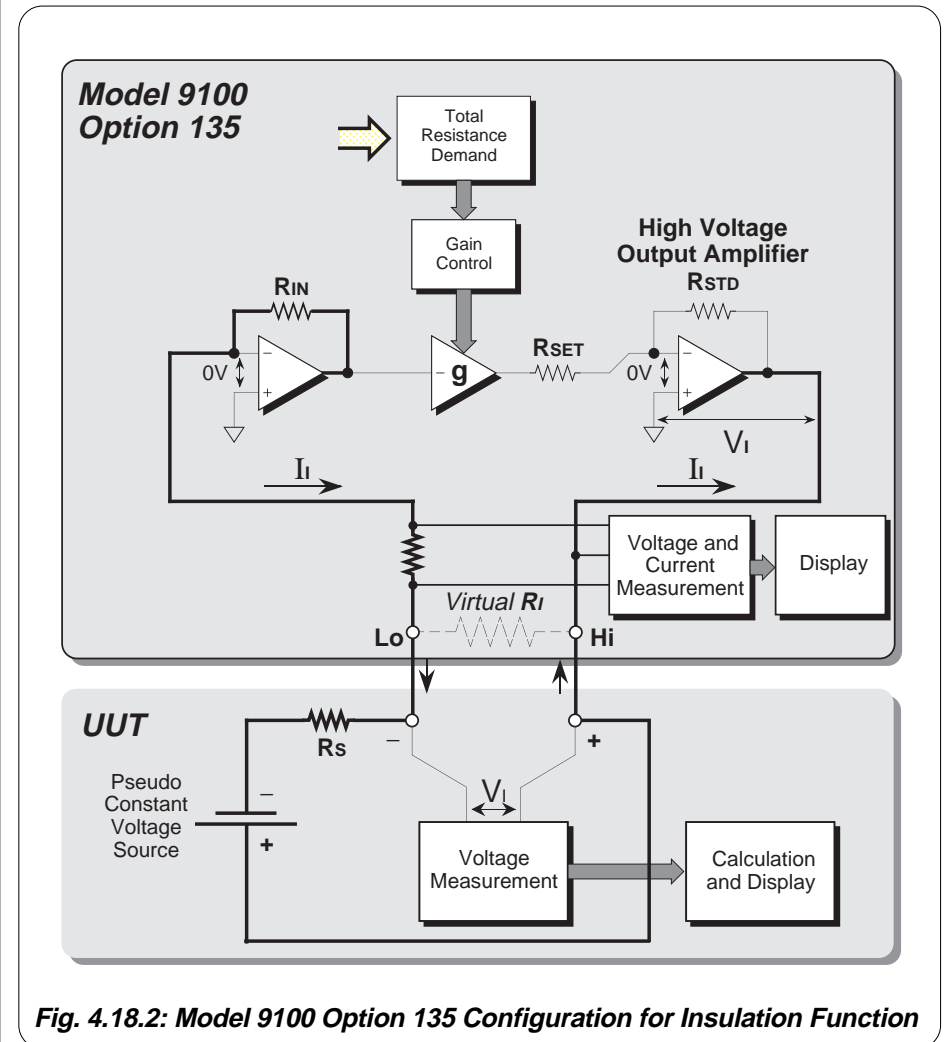

Fig. 4.18.2: Model 9100 Option 135 Configuration for Insulation Function

The insulation tester has a high-voltage DC-DC converter which transforms the low voltage from its batteries up to the high voltage DC required for insulation tests. Usually, there is a resistance in series with the converter. To calculate the resistance of insulation, the tester compares the voltage across its terminals with the voltage from its internal power supply. The ratio of these two voltages corresponds to the ratio of the potential divider comprised of the internal series resistance and the insulation resistance being measured.

The high voltage power supply and series resistance of the UUT can usually be switched to allow different ranges of voltage output and resistance precision and amplitude.

The topology of the Option 135 circuit is essentially the same as that for the Resistance function, with the following important differences:

1. The output amplifier has to be able to produce voltages in excess of 1000VDC. This is a unipolar amplifier that can only produce positive output voltages.
2. If you attempt connection to the 9100 with the lead polarity reversed, when you press the UUT test button you will see a message '**UUT polarity reversed or no UUT applied voltage**'. This indicates that the 9100 has detected a negative output voltage on the **HI** terminals. Reconnect with the correct lead polarity and repeat the test if this message appears.
3. The high impedances used in insulation resistance measurements mean that 4-wire connection with a lead compensation bridge are not required. Because the minimum selectable resistance of Option 135 is 100k Ω , any small series resistance that occurs within the system can be automatically compensated within the internal calibration of the 9100. The series resistance of the test leads (about 0.1 Ω) is insignificant compared with the minimum test resistance (100k Ω), and therefore represents a worst case error of approximately 0.0001%. This is well below the measurement noise, resolution and absolute accuracy of the test system.

4.18.7.2 Spans of Source Currents

In the synthesised active resistance technology used in Option 135, the current sourced from the UUT must fall within a maximum of two spans of values for each selected resistance value. This can be extrapolated using Ohm's law to indicate the maximum voltage on each range that the UUT can supply to the virtual resistive load the 9100 produces. The internal architecture of Option 135 has been designed to suit the output voltage versus resistance curves for a typical range of insulation testers, and this is the default **Super I** (Super Current) mode. Under normal circumstances, you should not have to change this value when performing insulation resistance tests on the 250V, 500V or 1000V range of most insulation meters.

However, if the source currents do not fall within expected parameters, Option 135 will provide prompts to the user to suggest a course of action.

4.18.7.3 User prompts and messages

Shown on the opposite page is a brief list of the user prompts which may appear during the operation of the unit, and their implications.

Under normal operating conditions, the only message you should see is '**UUT polarity reversed or no applied UUT voltage**'. This will occur when you turn the 9100 output ON before pressing the TEST button on the UUT. The 9100 detects that no current is flowing through the circuit and presents the user with the above message. This should be ignored provided that it disappears within a second of pressing the TEST button on the UUT.

MEGGER is a registered trademark of AVO International Limited

Displayed Message	Description	Action
ADVICE - Changing current setting ↓ gives best UUT performance.	The output voltage or current of the UUT is too low.	Ignore if you do not have the TEST button pressed (the 9100 has no way of recognising this), or press the CHANGE CURRENT key to re-scale the 9100 for a lower current/voltage input signal (N.B. This should NOT be necessary if using a 'standard' insulation type tester).
WARNING - UUT sense current is low, output outside specification.	The output voltage or current of the UUT is too low.	If you do not have the TEST button pressed, press the CHANGE CURRENT key to restore default (Super I) current setting. If you do have the TEST button pressed, check the connections to your instrument as there is no current path. If the connections are OK, there is a fault with your insulation tester and it is not supplying sufficient output voltage for the Option 135 circuits to operate.
WARNING - UUT sense current is high. Internal circuits saturated. Change current setting ↑	The output voltage/current of the UUT is too high for the High current setting of the 9100.	Press the CHANGE CURRENT key to restore Super I current setting (this is the default current setting).
WARNING - UUT sense current is high. Internal circuits saturated. Output outside specification.	The output voltage/current of the UUT is too high for the 9100.	Release the TEST button immediately. The output current of the UUT is too high for the Option 135.
WARNING - Output saturation, outside specification.	The output amplifier of the Option 135 has become saturated. The Option 135 has an output voltage compliance of 1350VDC.	Release the TEST button immediately. Check that the maximum output voltage of your UUT is less than 1350VDC. Check the connections to the instrument are correct (check you have no short circuits or faulty leads).
UUT lead polarity reversed or no UUT applied voltage	You have attempted to connect the negative terminal of your UUT to the HI terminal of the 9100, or you do not have a complete circuit connected.	Check that you have correctly wired the UUT to the Model 9100.

4.19 DC Power Function — Operation

4.19.1

This sub-section is a guide to the use of the 9100 for generating a required DC Power output. The following topics are covered:

- 4.19.1.1 Default Settings and Configurations
- 4.19.2 Selection of DC Power Function
 - 4.19.2.1 **==W** Key
- 4.19.3 DC Power Screen Keys
 - 4.19.3.1 Bottom Screen Keys
 - 4.19.3.2 Right Side Screen Keys
- 4.19.4 Value Editing
 - 4.19.4.1 Amplitude Editing
- 4.19.5 Crossing Thresholds
 - 4.19.5.1 DC Power Resolution Thresholds
 - 4.19.5.2 Hardware Configurations
 - 4.19.5.3 Low and High Voltage States
 - 4.19.5.4 Reconfiguration of High Voltage State Thresholds
- 4.19.6 DC Power Routines for Calibrating UUTs
 - 4.19.6.1 Interconnections
 - 4.19.6.2 Using the 9100 as a Fixed Source
 - 4.19.6.3 Using the 9100 as an Adjustable Source

Final Width = 215mm

In this sub-section, we deal with the full range of DC Power facilities. For those who require more detailed instructions for manipulating the front panel controls, the DC Voltage function is used as an example for the general familiarization tutorials in Section 3.

4.19.1.1 Default Settings and Configuration

Before using the Model 9100's DC Power function you can view and, if necessary, change this function's default settings. To do this, press the **Mode** front panel key, followed by the softkey sequence **CONFIG, MORE, MORE, ^{CONFIG}_{POWER} ^{OPTION}**. This will result in the display of a configuration screen similar to that shown below which can be used to enter user-defined default values for the power option.

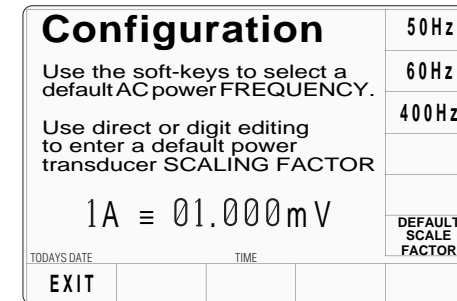

Figure 4.19.1 - the Power configuration screen.

The power configuration screen allows the following defaults to be modified:

Default Frequency - This default will be used to set the AC power default frequency.

Aux Voltage Scaling Factor - This value is used to scale the displayed power value of the dc power function when the auxiliary voltage output is active. The message 7031, "The transducer scaling factor must be between 45 μ V and 10 mV" will be displayed if the user attempts to enter a scale factor in the configuration menu that exceeds the specified limits. The user must enter a scaling factor for the instrument transducer. For example, a 50mV 1000A transformer requires the scaling factor 1A = 0.050 mV to be entered.

Pressing the **EXIT** softkey returns to the configuration screen.

Final Width = 215mm

4.19.2 Selection of DC Power Function

(Manual Mode selected) Entry is via the **Aux** key at the bottom right of the 'CALIBRATION SYSTEM' panel, followed by the **POWER** softkey if an oscilloscope calibration option (Option 250 or Option 600) is fitted to the Model 9100. If no oscilloscope calibration option is fitted, the Power selection softkeys illustrated below will appear immediately the **Aux** key is pressed.

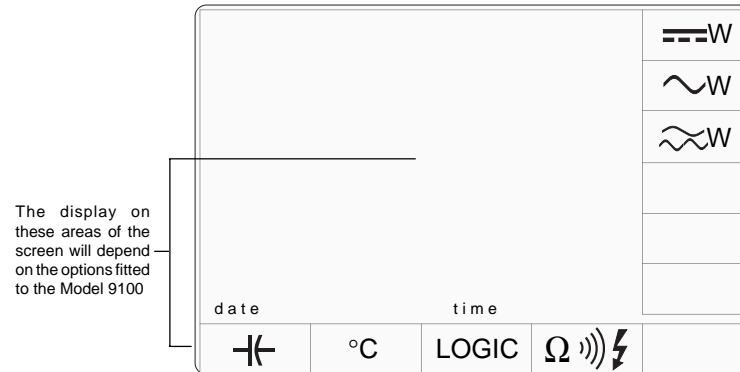

Final Width = 215mm

Figure 4.19.2 - the Auxiliary Function selection screen.

DC Power is selected by pressing the **===W** vertical softkey.

4.19.2.1 Key

Pressing the  vertical softkey will result in the display of a default DC power function screen similar to that illustrated below.

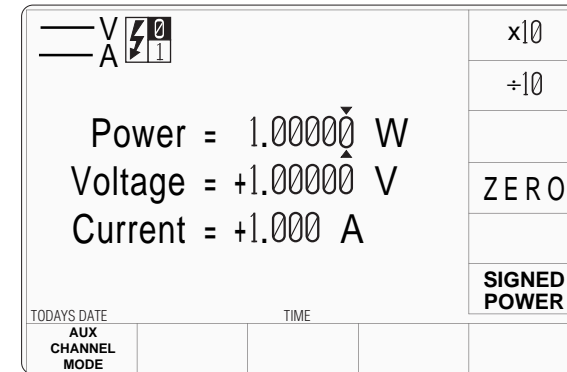

Final Width = 215mm

Note that the 9105 Lead/Workmat must **NOT** be used with the Model 9100's Power function. You must use the 9104 lead or an equivalent. If a 9105 Lead/Workmat is connected to the Model 9100, the message 1014 "Power output not allowed with 9105 work-mat" will be generated when any Power function is activated and an output ON is requested.

The DC Power function icon is used to indicate whether auxiliary voltage or one of the current modes is active. The upper part of the icon refers to the *main* channel, the lower, the *auxiliary* channel. The left side of the icon indicates the waveshape (just a dc level in this case), the right side, the output mode. The main channel will always be in voltage mode, the auxiliary channel can be in voltage or current mode (current is indicated by 'A', voltage by 'V').

The DC power screen will also give the user access to the  softkey.

Whenever the DC Power menu screen is opened, except on recovery from a standby period, it will appear with the following default settings:

Power = 1.00000 W
Voltage = +1.00000 V
Current = +1.000 A

4.19.3 DC Power Screen Keys

4.19.3.1 Bottom Screen Keys

AUX
CHANNEL
MODE

This softkey will trigger the display of an expansion menu that allows the Auxiliary output channel's operating mode to be configured. The expansion menu will contain the following items:

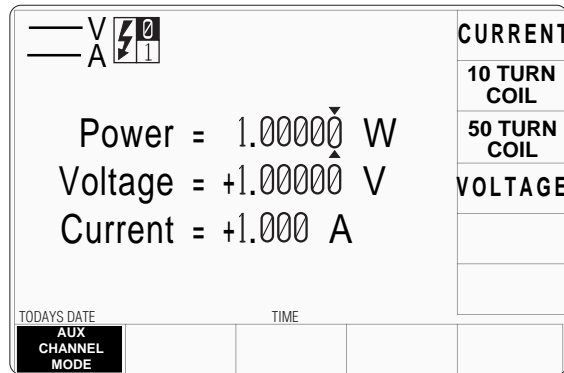

Final Width = 215mm

CURRENT Configures the Auxiliary channel as a current source.

10 TURN COIL Configures the Auxiliary channel to provide a current source via x10 current coil.

50 TURN COIL Configures the Auxiliary channel to provide a current source via a x50 current coil.

VOLTAGE Configures the Auxiliary channel as a voltage source.

4.19.3.2 Right Side Screen Keys on Main DC Power Screen

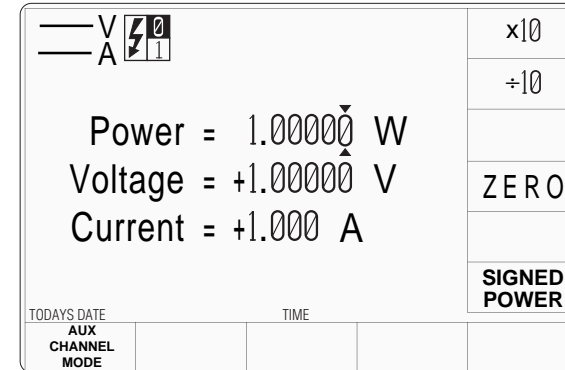

Final Width = 215mm

- x10** Multiplies the value in the active edit field by ten.
- ÷10** Divides the value in the active edit field by ten.
- ±** **Voltage =**, **Current =** and **Voltage ≡** fields only. Reverses the polarity of the value indicated in these edit fields.
- ZERO** Sets the value in the active edit field to zero.
- SIGNED POWER** **Power =** field only. This softkey toggles the display of the sign of the power field. Depending on the sign settings, the power (mathematically) is negative in two quadrants. Some power meters respond to this, others do not. The key enables the display to be the same as the instrument under test.

4.19.4 Value Editing

4.19.4.1 Amplitude Editing

Output values can be changed using 'Digit' and 'Direct' edit facilities as described in *Section 3*.

Editing of power The output power can be defined by directly entering it into the Power field (in which case the voltage will be recalculated automatically, based on the present current setting), or the output power can be defined by entering the voltage and current into their respective fields (see below).

For example: If $V=10V$ and $I=1A$ then a Power level of 10W will be displayed. If the Power field is increased to 11W the Voltage field will automatically be recalculated to 11V.

Note that directly editing the Power field first requires a suitable Current value to be set. Otherwise an error message will result.

Editing the Main channel amplitude only varies the voltage source.

Editing the Auxiliary channel amplitude normally varies the current source, but its operating mode can be modified to provide an auxiliary voltage source (displayed as an equivalent current), or to allow the selection of current coils that can be used to boost the effective current output as described in *4.19.3*.

Final Width = 215mm

4.19.5 Crossing Thresholds

4.19.5.1 DC Power Resolution Thresholds

The different resolutions are distinguished by two characteristics:

Maximum and minimum values available.

Absolute resolution of the least-significant digit.

The following table shows the spans of output values in the DC Power function, against the associated resolutions:

Default Display Ranges ('Power =' Field):

Min Value	Max Value	Sig. Figures	Dec. Places	Legend
00.0000	32.0000	6	4	μW
000.000	320.000	6	3	μW
0.00000	3.20000	6	5	mW
00.0000	32.0000	6	4	mW
000.000	320.000	6	3	mW
0.00000	3.20000	6	5	W
00.0000	32.0000	6	4	W
000.000	320.000	6	3	W
0.00000	3.20000	6	5	kW
00.0000	32.0000	6	4	kW
000.000	320.000	6	3	kW
0.00000	3.20000	6	5	MW
00.0000	07.8750	6	4	MW

When Aux volts is configured as current at non-default scaling factors, the above field is extended..

Rules, built into firmware, govern passage across thresholds between resolutions: These rules are generally the same as described in *Section 4.4.5.1*.

Best available resolution and specification are obtained immediately using direct entry.

Final Width = 215mm

4.19.5.2 Hardware Configurations

When increasing or decreasing output voltage using any method: if the new voltage is too large or small for the present hardware configuration, then if the OUTPUT is OFF there will be no noticeable effect as the hardware reconfigures.

If OUTPUT is **ON**, it will be temporarily turned **OFF** so that the hardware can reconfigure, then **ON** again at the new voltage. No warning is given. This interruption should cause little disturbance to the reading on any UUT.

4.19.5.3 Low and High Voltage States

In the interests of safety, to avoid electric shock, the 9100 incorporates a high voltage interlock system for both DC and DC Power functions. The interlock threshold voltage can be chosen by the user. A default threshold value is set unless another is set by the user, and the active threshold value is stored in non-volatile memory.

Refer to *Section 4.3.5.4* for further details.

4.19.5.4 Reconfiguration of High Voltage State Thresholds

Final Width = 215mm

N.B. A password will be required for access when changing thresholds.

The High Voltage State thresholds have default values that can be changed to user-defined values using the procedure given in *Section 4.3.5.4*.

4.19.6 DC Power Routines for Calibrating UUTs

4.19.6.1 Interconnections

The general connection scheme for 'UUT calibration of DC Power Functions is as follows:-

From 9100	To UUT
Hi	Hi
Lo	Lo
I+ (Also sources Aux Voltage)	I+ Terminal or Second Channel +ve
I- (Also sources Aux Voltage)	I- Terminal or Second channel -ve.

For UUTs without safety banana sockets, use appropriate adaptors.

Note that the 9105 lead set is NOT suitable. Use of this will cause an error. A suitable lead set, 9104, is supplied with the Power Option. No electrical connection is possible between the Voltage and Current channels of the Model 9100. This is not usually a limitation as power meters are almost universally equipped with isolated volts and current channels.

The detail of the required connections is dependent on the nature of the UUT and its associated current transducer if any.

4.19.6.2 Using the 9100 as a Fixed source.

The following procedure assumes that the instrument is in Manual Mode. In the case of difficulty, re-read sub-section 3.3.1. Familiarity with the methods of editing screen values is also assumed (*see Section 3*).

Calibration Setup

- 1. Connections** Connect the 9100 as described, and ensure that both instruments are powered ON and warmed up.
- 2. UUT** Select DC Power function.
- 3. 9100** Ensure that the 9100 is in DC Power Function with Output OFF.

Final Width = 215mm

Sequence of Operations

Refer to the table of UUT calibration points in the UUT Manufacturers Calibration Guide. Follow the correct sequence of calibration stages as directed by the guide, and carry out the following operations (1) to (5) at each stage.

1. **9100** Use the front panel controls to set the 9100 Output to the UUT cal point frequency and voltage, entering High Voltage State if the cal point has been assigned to that State. The default High Voltage State boundaries are shown in Fig. 4.19.1.
2. **UUT** Select the correct range for the cal point.
3. **9100**
 - a. Set Output **ON**.
 - b. Note the UUT reading
4. **UUT**
 - a. If a UUT calibration adjustment is provided, adjust the UUT to equal the reading on the 9100 screen.
 - b. If no adjustment is provided on the UUT, record the UUT reading at the calibration point
5. **9100** Set Output **OFF**.

Final Width = 215mm

4.19.6.3 Using the 9100 as an Adjustable Source

The following procedure assumes that the instrument is in Manual Mode. In the case of difficulty, re-read sub-section 3.3.1. Familiarity with the methods of editing screen values is also assumed (Section 3).

Calibration Setup

1. **Connections** Connect the 9100 as described, and ensure that both instruments are powered ON and warmed up.
2. **UUT** Select DC Power function.
3. **9100** Ensure that the 9100 is in DC Power Function with Output **OFF**.

Final Width = 215mm

Sequence of Operations

Refer to the table of UUT calibration points in the UUT Manufacturers Calibration Guide. Follow the correct sequence of calibration stages as directed by the guide, and carry out the following operations (1) to (5) at each stage.

1. **9100** Use the front panel controls to set the 9100 Output to the UUT cal point frequency and voltage, entering High Voltage State if the cal point has been assigned to that State. The default High Voltage State boundaries are discussed in *Sections 4.19.5.3 and 4.19.5.4.*
2. **UUT** Select the correct range for the cal point.
3. **9100**
 - a. Set Output **ON**.
 - b. Slew the DC Power Output reading until the UUT reading is equal to the calibration point value.
4. **UUT** Record the 9100 screen output value as detailed in the UUT Manufacturer's Calibration Guide.
5. **9100** Set Output **OFF**.

4.20 AC Power Function — Operation

4.20.1

This sub-section is a guide to the use of the 9100 for generating a required AC Power output. The following topics are covered:

- 4.20.1.1 Default Settings and Configurations
- 4.20.2 Selection of AC Power Function
 - 4.20.2.1 \sim **W** Key
- 4.20.3 Screen Keys
 - 4.20.3.1 Bottom Screen Keys
 - 4.20.3.2 Right Side Screen Keys
 - 4.20.3.3 Selecting Other Waveshapes
 - 4.20.3.4 Phase-Locking Facilities
 - 4.20.3.5 Conditions for Operation
- 4.20.4 Value Editing
 - 4.20.4.1 Amplitude Editing
 - 4.20.4.2 Frequency and Phase Editing
 - 4.20.4.3 'Out of Range'
 - 4.20.4.4 Power Factor (PF)
- 4.20.5 Crossing Thresholds
 - 4.20.5.1 AC Power Resolution Thresholds
 - 4.20.5.2 Frequency Resolution Thresholds
 - 4.20.5.3 Hardware Configurations
 - 4.20.5.4 Low and High Voltage States
 - 4.20.5.5 Reconfiguration of High Voltage State Thresholds
- 4.20.6 Volt-Hertz Limits.
 - 4.20.6.1 Volt-Hertz Profile
- 4.20.7 AC Power Routines for Calibrating UUTs
 - 4.20.7.1 Interconnections
 - 4.20.7.2 Using the 9100 as a Fixed Source
 - 4.20.7.3 Using the 9100 as an Adjustable Source

Final Width = 215mm

In this sub-section, we deal with the full range of AC Power facilities. For those who require more detailed instructions for manipulating the front panel controls, the DC Voltage function was used as an example for the general familiarization tutorials in *Section 3*.

4.20.1.1 Default Settings and Configuration

Before using the Model 9100's AC Power function you can view and, if necessary, change this function's default settings. To do this, press the **Mode** front panel key, followed by the softkey sequence **CONFIG, MORE, MORE**, CONFIG
POWER
OPTION. This will result in the display of a configuration screen similar to that shown below which can be used to enter user-defined default values for the power option.

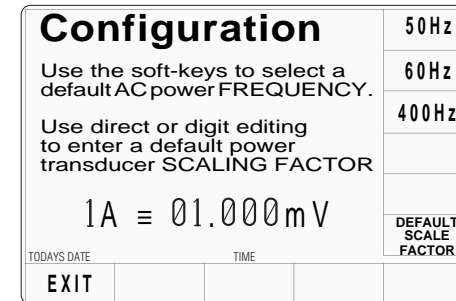

Figure 4.19.1 - the Power configuration screen.

The power configuration screen allows the following defaults to be modified:

Default Frequency - This default will be used to set the AC power default frequency.

Aux Voltage Scaling Factor - This value is used to scale the displayed power value of the ac power function when the auxiliary voltage output is active. The message 7031, "The transducer scaling factor must be between 45 uV and 10 mV" will be displayed if the user attempts to enter a scale factor in the configuration menu that exceeds the specified limits. The user must enter a scaling factor for the instrument transducer. For example, a 50mV 1000A transformer requires the scaling factor 1A = 0.050 mV to be entered.

Pressing the **EXIT** softkey returns to the configuration screen.

Final Width = 215mm

4.20.2 Selection of AC Power Function

(Manual Mode selected) Entry is via the **AUX** key at the bottom right of the 'CALIBRATION SYSTEM' panel, followed by the **POWER** softkey if one of the oscilloscope calibration options (Option 250 or Option 600) is fitted.

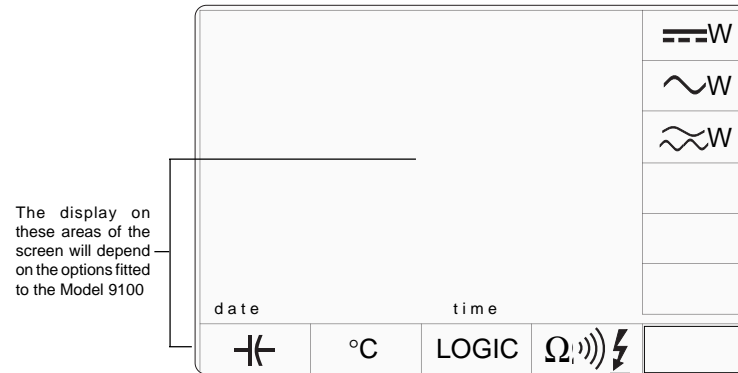

Figure 4.20.2 - the Auxiliary Function selection screen.

Final Width = 215mm

AC Power is selected by pressing the \sim **W** vertical softkey.

4.20.2.1 \sim W Key

Pressing the \sim W vertical softkey will result in the display of a default AC power function screen similar to that illustrated below.

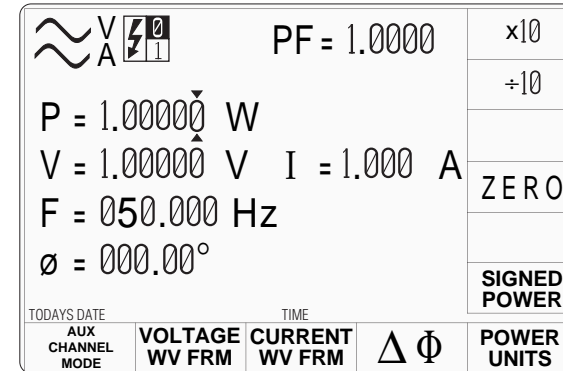

Final Width = 215mm

Note that the 9105 Lead/Workmat must **NOT** be used with the Model 9100's Power function. You must use the 9104 lead or an equivalent. If a 9105 Lead/Workmat is connected to the Model 9100, the message 1014 "Power output not allowed with 9105 work-mat" will be generated when any Power function is activated and an output ON is requested.

The AC Power function icon is used to indicate whether auxiliary voltage or one of the current modes is active. The upper part of the icon refers to the *main* channel, the lower, the *auxiliary* channel. The left side of the icon indicates the waveshape, the right side the output mode. The main channel will always be in voltage mode, the auxiliary channel can be in voltage or current mode (current is indicated by 'A', voltage by 'V').

The AC power screen also allows the user to set the following:-

- frequency.
- phase relationship between the voltage and current channels.
- an external phase locking signal (ref. output selection and phase angle).
- Voltage or Current output on auxiliary channel.
- Voltage and Current waveforms
- Power units
- Sign of Power
- +/- Phase when edit box is on Ø

Whenever the AC Power menu screen is opened, except on recovery from a standby period, it will appear with the following default settings:

Power = 1.00000 W

Voltage = 1.00000 V

Current = 1.000 A

Frequency = as configured (see Section 4.20.1.1).

$\phi = 000.00^\circ$ (This is the internal phase angle of I or aux V relative to V)

4.20.3 AC Power Screen Keys

4.20.3.1 Bottom Screen Keys

AUX
CHANNEL
MODE

This softkey will trigger the display of an expansion menu that allows the Auxiliary output channel's operating mode to be configured.

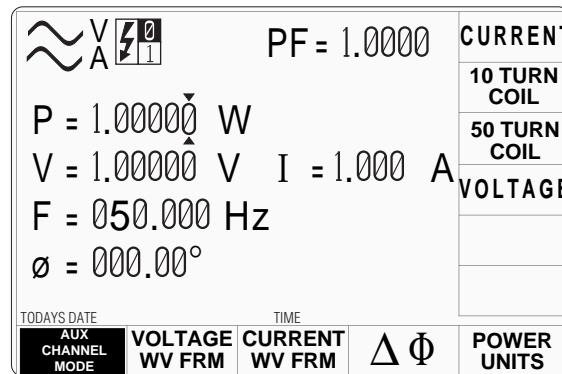

Final Width = 215mm

The expansion menu on the right-hand side keys contains the following four items:-

CURRENT Configures the Auxiliary channel as a current source.

10 TURN COIL Configures the Auxiliary channel to provide a simulated current via a x10 current coil.

50 TURN COIL Configures the Auxiliary channel to provide a simulated current via a x50 current coil.

VOLTAGE Configures the Auxiliary channel as a voltage source.

Final Width = 215mm

- VOLTAGE
WV FRM** This softkey brings up an expansion menu which allows the user to select the waveshape used by the *Main channel*. Refer to *Section 4.20.3.3* for further details.
- CURRENT
WV FRM** This softkey brings up an expansion menu which allows the user to select the waveshape used by the *Auxiliary channel*. Refer to *Section 4.20.3.3* for further details.
- $\Delta \Phi$ This softkey will bring up an expansion menu that allows the user to enable/disable the *instrument* phase angle field. For further details refer to *Section 4.20.3.4*

4.20.3.2 Right Side Screen Keys

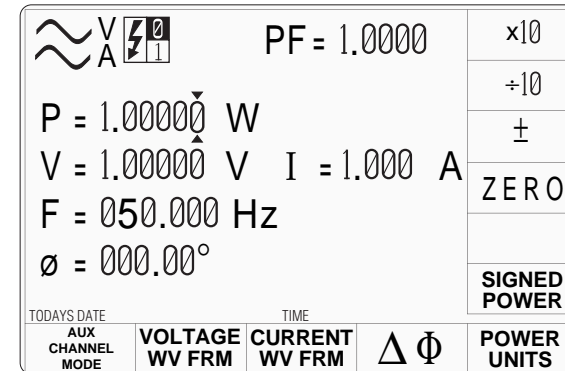

- X10** Multiplies the value in the active edit field by ten.
- ÷10** Divides the value in the active edit field by ten.
- ±** **∅** = field only. Reverses the polarity of the value indicated in the phase angle edit field.
- ZERO** **P** =, **V** =, **I** =, **V** ≡, **∅** = fields only. Sets the value in the active edit field to zero.

SIGNED POWER

P = field only. This softkey removes negative polarity indication from, or restores it to, the Power (**P** =) field. Nothing else is altered. The display of power may therefore be mathematically incorrect when this is selected.

POWER UNITS

This softkey allows the Power field units to be set between VA, VARs and Watts (default Watts). When VA is active, the phase field is ineffective and the Power field shows V*I. W is V*I*cosØ for sinewaves. CosØ is effectively inserted by shifting the auxiliary waveform by the phase shown, then multiplying the two waveforms together. Similarly, for VAR the reactive power needs the term SinØ, obtained in the Model 9100 by subtracting 90° from the Ø shown, then multiplying the two waveforms together. (Note that if a target machine is specified for sinewaves only, results with non- sinusoids may give readings which appear to disagree with those shown on the Model 9100 except usually at 0°.)

4.20.3.3 Selecting Other Waveshapes

Pressing the **VOLTAGE WV FRM** softkey presents a screen with five waveshapes shown against the right screen keys as illustrated below:-

Final Width = 215mm

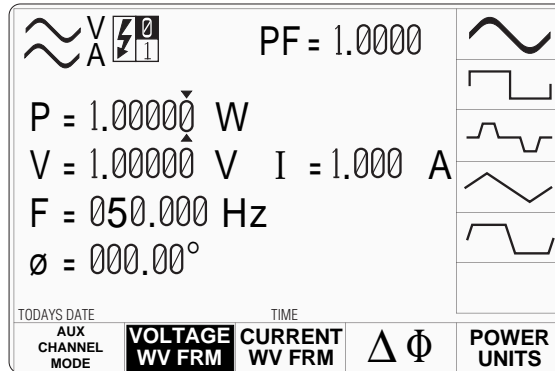

Pressing the appropriate key selects the waveform output on the **Main** channel. The possible selections are Sinusoidal, Square, Impulse, Triangular and Trapezoidal waveforms. The currently selected waveform also appears as part of the AC function icon. Refer to *Section 4.4.3.4* for further details.

Final Width = 215mm

Pressing the **CURRENT WV FRM** softkey also presents a screen with five waveshapes shown against the right screen keys. This time, however, pressing the appropriate key selects the waveform output on the **Auxiliary** channel. The possible selections are Sinusoidal, Square, Impulse, Triangular and Trapezoidal waveforms. The currently selected waveform also appears as part of the AC function icon. Refer to *Section 4.4.3.4* for further details.

4.20.3.4 Phase-Locking Facilities

The bottom $\Delta\Phi$ softkey will bring up a 2-key expansion menu that allows the user to enable/disable the instrument phase angle field, and the generation of a phase reference signal. Do not confuse it with \emptyset .

The two right screen keys that appear have the following functions:-

$\Delta\Phi$ Enables/disables the use of the instrument phase angle field.

REF OUTPUT Enables/disables the generation of a phase reference¹ signal. For a complete explanation of this function refer to *Section 4.4.3.5*, which refers to instrument facilities and contains several important warnings. The most important of these warnings are outlined in *Section 4.20.3.5* opposite.

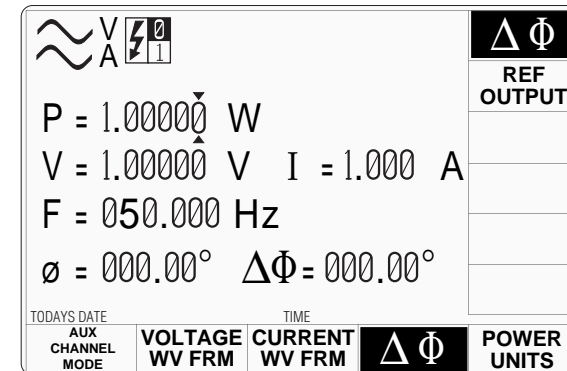

¹ REF OUTPUT enabled will make the instrument the master (when units are phase locked together).

4.20.3.5 Conditions for Operation

Same Frequency

For any two 9100 units (Master and Slave), both must be set to the same frequency of 1kHz or lower, before the output of the Driven unit is turned on.

Good Practice

In general, a slave unit will be well-behaved if the synchronizing pulse is interrupted. However, as the voltage increases above a few hundred volts, and the frequency decreases below 100Hz, synch. pulse interruptions or shifts may cause transients which result in operation of the protection circuitry in the slave unit automatically turning the slave unit output OFF. Only select phase locking while inputs are driven or, at least, terminated.

If units are run as slaves at HV AC and LF, observe the precautions described in the following paragraph.

Change of Function - Reference 9100 Unit

If the Reference unit's function is changed from ACV, its reference output will go low. This will cause the Driven unit to unlock and free-run, being most unlikely to remain in phase with the Reference unit. External control will be re-established when the Reference unit is returned to ACV function (or placed in ACI function). At this time the Driven unit's phase will be switched rapidly, creating transient disturbances in the output AC Power unless it is switched off. The Driven unit's output must therefore be turned OFF before the reference unit is returned to any AC function, (AC Power, ACV or ACI).

Disconnection of the cable from the Reference input ('PHASE LOCK IN' on the rear panel) will also cause the Driven unit to free-run, with resultant phase-shift of its output and possible transients when reconnected. Again, the Driven unit's output must be turned OFF before the cable is reconnected.

It is also poor practice to demand large frequency shifts when high currents are selected on the slave or even the internal auxiliary channel. This creates an inductive spike due to the output wiring or load, which can trip the over-compliance detector. If this happens, simply turn the output back ON. Procedure writers should consider turning the output OFF before any significant change to avoid any possibility of nuisance tripping.

Lead Set

The 9104 lead has been optimised for this application. Use of untwisted replacements may result in increased voltage errors when high currents are selected. The 9100 specification assumes the use of the 9104.

Final Width = 215mm

Final Width = 215mm

4.20.4 Value Editing

4.20.4.1 Amplitude Editing

Output values can be changed using 'Digit' and 'Direct' edit facilities as described in *Section 3*.

Note that as a general rule, editing any value will cause the Power to change. Editing Power causes only the voltage to change. Changing from one waveform to another retains Phase, RMS Volts and Current, thus making Power the varying field.

Editing Power – The output power can be defined by directly entering it into the Power field (in which case the voltage will be recalculated automatically, based on the present current and phase setting), or the output power can be defined by entering the voltage, current and phase into their respective fields (see below).

For example:

If $V=10$ and $I=1$.

An Output Value of 10W thus set on the display, when increased to 11W will result in V being recalculated as 11V.

Editing the **Main** channel amplitude, varies only the voltage source.

Editing of the **Auxiliary** channel amplitude normally varies the current source, but its operating mode can be modified to provide an auxiliary voltage source (although still displayed as a current), or to allow the selection of current coils that boost the effective current output as described in *Section 4.20.3*.

Editing \emptyset causes Power and VAR to be recalculated, but not VA.

4.20.4.2 Frequency and Phase Editing

Frequency and Internal Phase-Shift (\emptyset) values can be changed using 'Digit' and 'Direct' edit facilities. The general rules for editing processes are described in *Section 3*. (Note that as \emptyset angle increases, specifications tend to worsen. For this reason, most calibrations are performed at low phase angles.) Altering phase causes Power and VARs to be recalculated.

4.20.4.3 'Out of Range'

Any attempt to select a combination of voltage and frequency (including the application of deviations and/or offsets) outside the constraints of the Volt-Hertz profile will not be implemented.

Several user inputs may result in exceeding these constraints. As an extreme example, attempting to edit the Power field, with sine waves selected and $\phi = 90^\circ$, is impossible because the power can only be zero. The message 9070, "Cannot change: phase = 90" will be generated because it is not possible to resolve $P=VI \cos\phi$.

Similarly, at very high powers, if the phase angle is too high or the selected current is too low, this could cause an error message to occur indicating too high a voltage demand.

If a high VA or power is being demanded, selecting Power rather than VA or reducing the phase angle respectively, may cause errors due to exceeding the permissible operating envelope. Alternatively, the instrument may attempt to give out a high voltage or current, requiring user confirmation. This requires some thought on the part of the user.

Exceeding some part of the operating envelope will cause an audible warning to be given, accompanied by a screen message: Out of range'.

Refer also to *Section 4.4.6*.

4.20.4.4 Power Factor (PF)

This field is 'read only'. It is calculated automatically according to the equation:-

$$\frac{\text{Power in Watts}}{V_{\text{rms Main}} \times I_{\text{rms Aux}}}$$

Where $I_{\text{rms Aux}}$ is the displayed real or equivalent current.

Final Width = 215mm

4.20.5 Crossing Thresholds

4.20.5.1 AC Power Resolution Thresholds

The different resolutions are distinguished by two characteristics:

- Maximum and minimum values available.
- Absolute resolution of the least-significant digit.

The following table shows the spans of output values in the AC Power function, for 'sinusoidal' waveshape only, against the associated resolutions:

Default Display Ranges ('P =' Field):

Min Value	Max Value	Sig. Figures	Dec. Places	Legend
00.0000	32.0000	6	4	μW or μVA
000.000	320.000	6	3	μW or μVA
0.00000	3.20000	6	5	mW or mVA
00.0000	32.0000	6	4	mW or mVA
000.000	320.000	6	3	mW or mVA
0.00000	3.20000	6	5	W or VA
00.0000	32.0000	6	4	W or VA
000.000	320.000	6	3	W or VA
0.00000	3.20000	6	5	kW or kVA
00.0000	32.0000	6	4	kW or kVA
000.000	320.000	6	3	kW or kVA
0.00000	3.20000	6	5	MW or MVA
00.0000	07.8750	6	4	MW or MVA

When Aux volts is configured as current at non-default scaling factors, the above field is extended..

Rules, built into firmware, govern passage across thresholds between resolutions: These rules are generally the same as described in *Section 4.4.5.1*.

Best available resolution and specification are obtained immediately using direct entry.

If direct entry into the Power field is used, Current and Phase must first be set to suitable values.

For information concerning other waveshapes and available voltages, refer to *Sections 7.4 and 7.6*.

Final Width = 215mm

4.20.5.2 Frequency Resolution Thresholds

The frequency field is limited to 10 Hz to 3.00000 kHz, 6 significant figures. The default value is set by the configuration screen (nominally 50Hz).

For 'Out of Range', refer to *Section 4.4.6*.

4.20.5.3 Hardware Configurations

When increasing or decreasing output voltage or frequency, using any method: if the new voltage or frequency is too large or small for the present hardware configuration, then if OUTPUT is **OFF** there will be no noticeable effect as the hardware reconfigures.

If OUTPUT is **ON**, it will be temporarily turned **OFF** so that the hardware can reconfigure, then **ON** again at the new voltage. No warning is given. This interruption should cause little disturbance to the reading on any UUT.

4.20.5.4 Low and High Voltage States

In the interests of safety, to avoid electric shock, the 9100 incorporates a high voltage interlock system for both DC and AC Power functions. The interlock threshold voltage can be chosen by the user. A default threshold value is set unless another is set by the user, and the active threshold value is stored in non-volatile memory.

Refer to *Section 4.4.5.4* for further details.

4.20.5.5 Reconfiguration of High Voltage State Thresholds

N.B. A password will be required for access when changing thresholds.

The High Voltage State thresholds have default values and change procedures as given in *Sections 4.4.5.4 and 4.4.5.5*.

Final Width = 215mm

Final Width = 215mm

4.20.6 Volt-Hertz Limits

4.20.6.1 Volt-Hertz Profile (Sinusoidal Waveshape)

The combination of voltage and frequency of the sinewave output signal is constrained within the Volt.Hertz product envelope shown in Fig. 4.4.2. subject to further HF limitations for power as stated in the specifications.

Any attempt to select a combination of voltage and frequency outside these constraints will not be implemented. An audible warning will be given, accompanied by the screen message: 'Out of range'.

If the abortive attempt involves the use of Direct Editing, then a further message will be placed into the active editing box.

The other four voltage waveshapes (see *Section 4.4.3.4*) have different limits:-

1kHz maximum up to 150V peak (nominal)

45Hz-55Hz above 150V peak (nominal)

4.20.7 AC Power Routines for Calibrating UUTs

4.20.7.1 Interconnections

The general connection scheme for 'UUT calibration of AC Power Functions is as follows:-

From 9100	To UUT
Hi	Hi
Lo	Lo
I+ (Also sources Aux Voltage)	I+ Terminal or Second Channel +ve
I- (Also sources Aux Voltage)	I- Terminal or Second channel -ve.

For UUTs without safety banana sockets, use appropriate adaptors.

Note that the 9105 lead set is NOT suitable. Use of this will cause an error if a Current output is selected. A suitable lead set is supplied with the Power Option. No electrical connection is possible between Voltage and Current channels of the 9100. This is not usually a limitation as power meters are almost universally equipped with isolated volts and current channels.

The detail of the required connections is dependent on the nature of the UUT and its associated current transducer if any.

4.20.7.2. Using the 9100 as a Fixed source

The following procedure assumes that the instrument is in Manual Mode. In the case of difficulty, re-read sub-section 3.3.1. Familiarity with the methods of editing screen values is also assumed (*Section 3*).

Calibration Setup

- 1. Connections** Connect the 9100 to the UUT, and ensure that both instruments are powered ON and warmed up.
- 2. UUT** Select AC Power function.
- 3. 9100** Ensure that the 9100 is in AC Power Function with Output **OFF**.

Final Width = 215mm

Final Width = 215mm

Sequence of Operations

Refer to the table of UUT calibration points in the UUT Manufacturers Calibration Guide. Follow the correct sequence of calibration stages as directed by the guide, and carry out the following operations (1) to (5) at each stage.

1. **9100**
 - a. Use the front panel controls to set the 9100 Output to the UUT cal point frequency, voltage and current, entering High Voltage State if the cal point has been assigned to that State. The default High Voltage State boundaries are shown in *Fig. 4.20.1*.
 - b. Select the required waveforms and phase-shift.
2. **UUT**

Select the correct range for the cal point.
3. **9100**
 - a. Set Output **ON**.
 - b. Note the UUT reading
4. **UUT**
 - a. If a UUT calibration adjustment is provided, adjust the UUT to equal the reading on the 9100 screen.
 - b. If no adjustment is provided on the UUT, record the UUT reading at the calibration point
5. **9100**

Set Output **OFF**.

4.20.7.3 Using the 9100 as an Adjustable Source

The following procedure assumes that the instrument is in Manual Mode. In the case of difficulty, re-read *Section 3.3.1*. Familiarity with the methods of editing screen values is also assumed (*Section 3*).

Calibration Setup

1. **Connections** Connect the 9100 to the UUT and ensure that both instruments are powered ON and warmed up.
2. **UUT** Select AC Power function.
3. **9100** Ensure that the 9100 is in AC Power Function with Output **OFF**.

Sequence of Operations

Refer to the table of UUT calibration points in the UUT Manufacturers Calibration Guide. Follow the correct sequence of calibration stages as directed by the guide, and carry out the following operations (1) to (5) at each stage.

1. **9100**
 - a. Use the front panel controls to set the 9100 Output to the UUT cal point frequency, voltage and current, entering High Voltage State if the cal point has been assigned to that State. The default High Voltage State boundaries are shown in *Fig. 4.20.1*.
 - b. Select the required waveforms and phase-shift.
2. **UUT**

Select the correct range for the cal point.
3. **9100**
 - a. Set Output **ON**.
 - b. Slew the AC Power Output reading until the UUT reading is equal to the calibration point value.
4. **UUT**

Record the 9100 screen output value as detailed in the UUT Manufacturer's Calibration Guide.
5. **9100**

Set Output **OFF**.

Final Width = 215mm

4.21 AC Harmonics Function — Operation

4.21.1

This sub-section is a guide to the use of the 9100 for generating a required AC Harmonics output. The following topics are covered:

- 4.21.1.1 Default Settings and Configurations
- 4.21.2 Selection of AC Harmonics Function
 - 4.21.2.1 \approx **W** Key
- 4.21.3 Screen Keys
 - 4.21.3.1 Bottom Screen Keys
 - 4.21.3.2 Right Side Screen Keys
 - 4.21.3.3 Phase-Locking Facilities
 - 4.21.3.4 Conditions for Operation
- 4.21.4 Value Editing
 - 4.21.4.1 Amplitude Editing
 - 4.21.4.2 Frequency and Phase Editing
 - 4.21.4.3 'Out of Range'
- 4.21.5 Crossing Thresholds.
 - 4.21.5.1 AC Harmonics Resolution Thresholds
 - 4.21.5.2 Frequency, Harmonic and Resolution Thresholds
 - 4.21.5.3 Hardware Configurations
 - 4.21.5.4 Low and High Voltage States
 - 4.21.5.5 Reconfiguration of High Voltage State Thresholds
- 4.21.6 Volt-Hertz Limits
 - 4.21.6.1 Volt-Hertz Profile
- 4.21.7 AC Harmonics Routines for Calibrating UUTs
 - 4.21.7.1 Interconnections
 - 4.21.7.2 Using the 9100 as a Fixed Source
 - 4.21.7.3 Using the 9100 as an Adjustable Source

Final Width = 215mm

In this sub-section, we deal with the full range of AC Harmonics facilities. For those who require more detailed instructions for manipulating the front panel controls, the DC Voltage function was used as an example for the general familiarization tutorials in *Section 3*.

4.21.1.1 Default Settings and Configuration

Before using the Model 9100's AC Harmonics function you can view and, if necessary, change this function's default settings. To do this, press the **Mode** front panel key, followed by the softkey sequence **CONFIG, MORE, MORE,** CONFIG
POWER
OPTION. This will result in the display of a configuration screen similar to that shown below which can be used to enter user-defined default values for the power option.

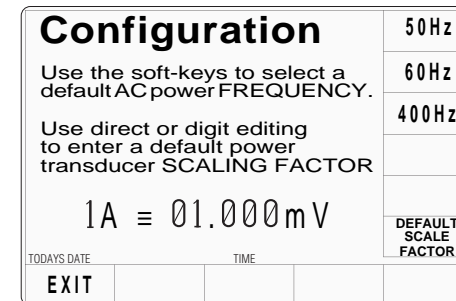

Figure 4.19.1 - the Power configuration screen.

The power configuration screen allows the following defaults to be modified:

Default Frequency - This default will be used to set the AC power default frequency.

Aux Voltage Scaling Factor - This value is used to scale the displayed power value of the ac power function when the auxiliary voltage output is active. The message 7031, "The transducer scaling factor must be between 45 uV and 10 mV" will be displayed if the user attempts to enter a scale factor in the configuration menu that exceeds the specified limits.

Pressing the **EXIT** softkey returns to the configuration screen.

Final Width = 215mm

4.21.2 Selection of AC Harmonics Function

(Manual Mode selected) Entry is via the **AUX** key at the bottom right of the 'CALIBRATION SYSTEM' panel, followed by the **POWER** softkey if one of the oscilloscope calibration options (Option 250 or Option 600) is fitted.

Note that the 9105 Lead mat must NOT be used.

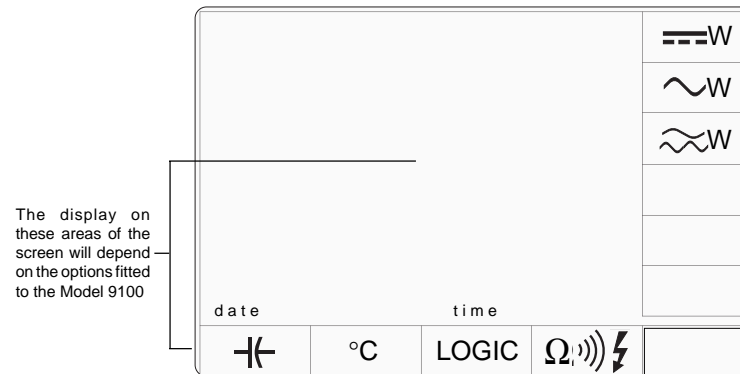



Figure 4.21.2 - the Auxiliary Function selection screen.

Final Width = 215mm

AC Harmonics is selected by pressing the \approx W vertical softkey.

4.21.2.1 W Key

Pressing the  W vertical softkey will result in the display of a default AC Harmonics function screen similar to that illustrated below.

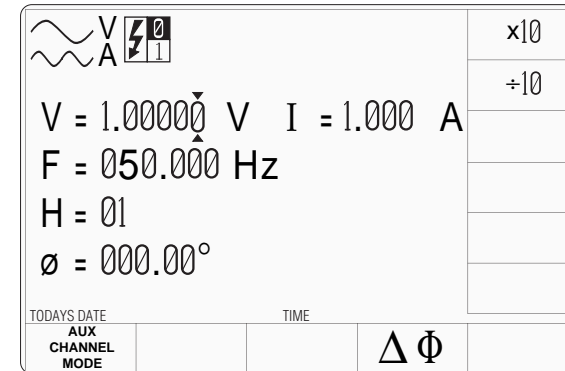

Final Width = 215mm

The AC Harmonics function icon is used to indicate whether auxiliary voltage or one of the current modes is active. The upper part of the icon refers to the *main* channel, the lower the *auxiliary* channel. The left side of the icon indicates the sine waveshape, the right side, the output mode. The main channel will always be in voltage mode, the auxiliary channel can be in voltage or current mode (current is indicated by 'A', voltage by 'V').

Whenever the AC Harmonics menu screen is opened, except on recovery from a standby period, it will appear with the following default settings:

$$V = 1.00000 V$$

$$I = 1.000 A$$

$F = \text{as configured.}$

$H = 01$ (Setting this to NN sets the harmonic of the auxiliary channel.)

$\emptyset = 000.00^\circ$ (This is the internal phase angle of I or aux V relative to V . It defines the starting point of the first harmonically related waveform relative to the 0° point of the fundamental.)

4.21.3 Harmonics Screen Keys

4.21.3.1 Bottom Screen Keys

AUX
CHANNEL
MODE

This softkey will trigger the display of an expansion menu that allows the Auxiliary output channel's operating mode to be configured.

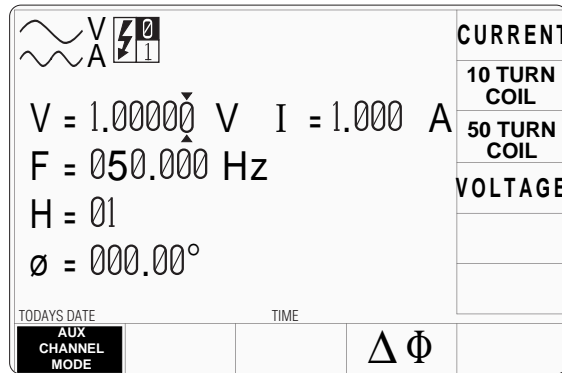

Final Width = 215mm

The expansion menu contains the following items:-

- | | |
|---------------------|---|
| CURRENT | Configures the Auxiliary channel as a current source. |
| 10 TURN COIL | Configures the Auxiliary channel to provide a simulated current via a x10 current coil. |
| 50 TURN COIL | Configures the Auxiliary channel to provide a simulated current via a x50 current coil. |
| VOLTAGE | Configures the Auxiliary channel as a voltage source. |
| Δ Φ | This softkey will bring up an expansion menu that allows the user to enable/disable the <i>instrument</i> phase angle field. For further details refer to <i>Section 4.21.3.3</i> |

Final Width = 215mm

4.21.3.2 Right Side Screen Keys

- ×10 Multiplies the value in the active edit field by ten.
- ÷10 Divides the value in the active edit field by ten.

4.21.3.3 Phase-Locking Facilities

This bottom $\Delta\Phi$ softkey will bring up a 2-key expansion menu that allows the user to enable/disable the *instrument* phase angle field, and the generation of a phase reference signal. Do not confuse it with \emptyset . The master channels are those which are phase locked together.

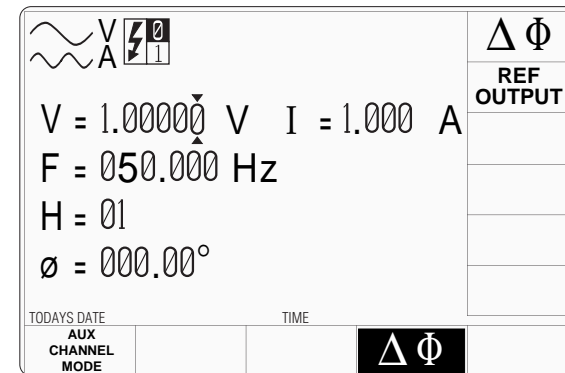

The two right-hand screen keys that appear have the following functions:-

- $\Delta\Phi$ Enables/disables the use of the instrument phase angle field.
- REF OUTPUT** Enables/disables the generation of a phase reference¹ signal. For a complete explanation of this function refer to *Section 4.4.3.5*, which refers to instrument facilities and contains several important warnings. The most important of these warnings are outlined in *Section 4.21.3.4* opposite.

¹ REF OUTPUT enabled will make the instrument the master (when units are phase locked together).

4.21.3.4 Conditions for Operation

Same Frequency

For any two 9100 units (Master and Slave), both must be set to the same frequency of 1kHz or lower, before the output of the Driven unit is turned on.

Good Practice

In general, a slave unit will be well-behaved if the synchronizing pulse is interrupted. However, as the voltage increases above a few hundred volts, and the frequency decreases below 100Hz, synch. pulse interruptions or shifts may cause transients which result in operation of the protection circuitry in the slave unit, automatically turning the slave unit output OFF. Only select phase locking while inputs are driven or, at least, terminated.

If units are run as slaves at HV AC and LF observe the precautions described in the following paragraph.

Change of Function - Reference 9100 Unit

If the Reference unit's function is changed from ACV, its reference output will go low. This will cause the Driven unit to unlock and free-run, being most unlikely to remain in phase with the Reference unit. External control will be re-established when the Reference unit is returned to ACV function (or placed in ACI function). At this time the Driven unit's phase will be switched rapidly, creating transient disturbances in the output AC Power unless it is switched off. The Driven unit's output must therefore be turned OFF before the reference unit is returned to any AC function, (Power, ACV or ACI).

Disconnection of the cable from the Reference input ('PHASE LOCK IN' on the rear panel) will also cause the Driven unit to free-run, with resultant phase-shift of its output and possible transients when reconnected. Again, the Driven unit's output must be turned OFF before the cable is reconnected.

It is also poor practice to demand large frequency shifts when high currents are selected on the slave or even the internal auxiliary channel. This creates an inductive spike due to the output wiring or load, which can trip the over-compliance detector. If this happens, simply turn the output back ON. Procedure writers should consider turning the output OFF before any significant change to avoid any possibility of nuisance tripping.

Lead Set

The 9104 lead has been optimised for this application. Use of untwisted replacements may result in increased voltage errors when high currents are selected. The 9100 specification assumes the use of the 9104.

Final Width = 215mm

Final Width = 215mm

4.21.4 Value Editing

4.21.4.1 Amplitude Editing

Output values can be changed using 'Digit' and 'Direct' edit facilities as described in *Section 3*.

Editing of the Auxiliary channel amplitude normally varies the current source, but its operating mode can be modified to provide an auxiliary voltage source (although still displayed as a current), or allow the selection of current coils which can be used to boost the effective current output as described in *Section 4.21.3*.

4.21.4.2 Frequency and Phase Editing

Frequency and Internal Phase-Shift \emptyset values can be changed using 'Digit' and 'Direct' edit facilities. The general rules for editing processes are described in *Section 3*.

\emptyset is the internal phase angle of I or Aux V – i.e. the Harmonic relative to V. It defines the 0° starting point of the first harmonically related waveform relative to the 0° point of the fundamental (**Main** channel). The actual phase shift at the fundamental frequency is the displayed value/nn, where nn is the chosen harmonic.

4.21.4.3 'Out of Range'

Any attempt to select a combination of voltage and frequency (including the application of deviations and/or offsets) outside the constraints of the Volt.Hertz profile will not be implemented.

Several user inputs may result in exceeding these constraints.

Exceeding some part of the operating envelope will cause an audible warning to be given, accompanied by a screen message: 'Out of range'. Refer also to Section 4.4.6.

4.21.5 Crossing Thresholds

4.21.5.1 AC Harmonics Resolution Thresholds

The different resolutions are distinguished by two characteristics:

Maximum and minimum values available.
Absolute resolution of the least-significant digit.

The Voltage and Harmonics thresholds follow those of the Main (fundamental) and Auxiliary (harmonics) outputs respectively, as defined in the Model 9100 Specifications.

4.21.5.2 Frequency, Harmonic and Resolution Thresholds

The frequency is limited to the range 10 Hz to 3.0000 kHz, 6 significant figures. The default value is set by the configuration screen (nominally 50Hz).

The maximum Harmonic is the 50th.

There are therefore many forbidden combinations, that cause error messages to be displayed.

e.g. F=100.00 and H=40 will cause an error 9069 "Harmonic frequency cannot exceed 3000 Hz" because a Harmonic frequency of 4kHz is too high.

For 'Out of Range', refer also to *Section 4.4.6*.

4.21.5.3 Hardware Configurations

When increasing or decreasing output voltage or frequency, using any method: if the new voltage or frequency is too large or small for the present hardware configuration, then if OUTPUT is **OFF** there will be no noticeable effect as the hardware reconfigures.

If OUTPUT is **ON**, it will be temporarily turned **OFF** so that the hardware can reconfigure, then **ON** again at the new voltage. No warning is given. This interruption should cause little disturbance to the reading on any UUT.

Final Width = 215mm

Final Width = 215mm

4.21.5.4 Low and High Voltage States

In the interests of safety, to avoid electric shock, the 9100 incorporates a high voltage interlock system for both DC and AC Power functions. The interlock threshold voltage can be chosen by the user. A default threshold value is set unless another is set by the user, and the active threshold value is stored in non-volatile memory.

Refer to *Section 4.4.5.4* for further details.

4.21.5.5 Reconfiguration of High Voltage State Thresholds

N.B. A password will be required for access when changing thresholds.

The High Voltage State thresholds have default values and change procedures as given in *Sections 4.4.5.4 and 4.4.5.5*.

4.21.6 Volt-Hertz Limits

4.21.6.1 Volt-Hertz Profile (Sinusoidal Waveshape)

The combination of voltage and frequency of the sinewave output signal is constrained within the Volt-Hertz product envelope shown in *Fig. 4.4.2*. subject to further HF limitations for Harmonics as stated in the specifications.

Any attempt to select a combination of voltage and frequency outside these constraints will not be enabled. An audible warning will be given, accompanied by the screen message: 'Out of range'.

If the abortive attempt involves the use of Direct Editing, then a further message will be placed into the active editing box.

4.21.7 AC Harmonics Routines for Calibrating UUTs

4.21.7.1 Interconnections

The general connection scheme for 'UUT calibration of AC Harmonics Functions is as follows:-

From 9100	To UUT
Hi (Fundamental)	Hi
Lo (Fundamental)	Lo
I+ (Also sources Aux Voltage)	I+ Terminal or Second Channel +ve
I- (Also sources Aux Voltage)	I- Terminal or Second channel -ve.

For UUTs without safety banana sockets, use appropriate adaptors.

Note that the 9105 lead set is NOT suitable. Use of this will cause an error if a Current output is selected. A suitable lead set is supplied with the Power Option. No electrical connection is possible between Voltage and Current channels of the 9100. This is not usually a limitation as power meters are almost universally equipped with isolated volts and current channels.

The detail of the required connections is dependent on the nature of the UUT and its associated current transducer if any.

4.21.7.2. Using the 9100 as a Fixed source

The following procedure assumes that the instrument is in Manual Mode. In the case of difficulty, re-read sub-section 3.3.1. Familiarity with the methods of editing screen values is also assumed (*Section 3*).

Calibration Setup

- 1. Connections** Connect the 9100 to the UUT, and ensure that both instruments are powered ON and warmed up.
- 2. UUT** Select AC Harmonics function.
- 3. 9100** Ensure that the 9100 is in AC Harmonics Function with Output **OFF**.

Final Width = 215mm

Final Width = 215mm

Sequence of Operations

Refer to the table of UUT calibration points in the UUT Manufacturers Calibration Guide. Follow the correct sequence of calibration stages as directed by the guide, and carry out the following operations (1) to (5) at each stage.

1. **9100**
 - a. Use the front panel controls to set the 9100 Main Output to the UUT cal point frequency, voltage and current, entering High Voltage State if the cal point has been assigned to that State. The default High Voltage State boundaries are shown in *Fig. 4.21.1*.
 - b. Select the required Harmonic parameters.
2. **UUT**

Select the correct range for the cal point.
3. **9100**
 - a. Set Output **ON**.
 - b. Note the UUT reading
4. **UUT**
 - a. If a UUT calibration adjustment is provided, adjust the UUT to equal the reading on the 9100 screen.
 - b. If no adjustment is provided on the UUT, record the UUT reading at the calibration point
5. **9100**

Set Output **OFF**.

4.21.7.3 Using the 9100 as an Adjustable Source

The following procedure assumes that the instrument is in Manual Mode. In the case of difficulty, re-read *Section 3.3.1*. Familiarity with the methods of editing screen values is also assumed (*Section 3*).

Calibration Setup

1. **Connections** Connect the 9100 to the UUT and ensure that both instruments are powered ON and warmed up.
2. **UUT** Select AC Harmonics function.
3. **9100** Ensure that the 9100 is in AC Harmonics Function with Output **OFF**.

Sequence of Operations

Refer to the table of UUT calibration points in the UUT Manufacturers Calibration Guide. Follow the correct sequence of calibration stages as directed by the guide, and carry out the following operations (1) to (5) at each stage.

1. **9100**
 - a. Use the front panel controls to set the 9100 Main Output to the UUT cal point frequency, voltage and current, entering High Voltage State if the cal point has been assigned to that State. The default High Voltage State boundaries are shown in *Fig. 4.21.1*.
 - b. Select the required Harmonic parameters.
2. **UUT**

Select the correct range for the cal point.
3. **9100**
 - a. Set Output **ON**.
 - b. Slew the appropriate 9100 output reading until the UUT reading is equal to the calibration point value.
4. **UUT**

Record the 9100 screen output value as detailed in the UUT Manufacturer's Calibration Guide.
5. **9100**

Set Output **OFF**.

Final Width = 215mm

Final Width = 215mm

Section 5 Using the Model 9100 — Procedure Mode

5.1 About Section 5

Section 3 should have given you practice at manipulating the front-panel controls. In Section 5 we shall guide you, in a general way, through the phases of using a procedure card in the 9100, to calibrate a manually-operated measuring instrument (UUT). For a guide to using front panel controls in Manual Mode, please turn to *Section 4*.

Section 5 is divided into the following sub-sections:

- 5.1 About Section 5 (this sub-section).
- 5.2 Safety and General Notes.
- 5.3 Access Guide.
- 5.4 Adjustment Only Procedure.
- 5.5 1 Year Verification Procedure.
- 5.6 Verify Pass/Fail Procedure.

Final Width = 215mm

5.2 Procedure Mode — Safety and General Notes

5.2.1 Introduction

Sub-section 5.2 introduces notes to Procedure mode. The following topics are covered:

- 5.2.2 Safety Features.
 - 5.2.2.1 Output 'OFF' button.
- 5.2.3 Serial Mouse.
 - 5.2.3.1 General Use of a Mouse.
 - 5.2.3.2 Output Slewing.
- 5.2.4 Printing Setup.
 - 5.2.4.1 Printer Type.
 - 5.2.4.2 Certificate Formatting and Data Presentation.
 - 5.2.4.3 Enable Printing.
- 5.2.5 Saving Results on Memory Cards.
 - 5.2.5.1 Results Card Enabling and Insertion.
 - 5.2.5.2 Stage-by-Stage Results Saving.
 - 5.2.5.3 Results Memory Space.
 - 5.2.5.4 Static RAM Card — Battery Condition.
 - 5.2.5.5 Static RAM Card — Re-chargeable Battery.

Final Width = 215mm

5.2.2 Safety Features

The Model 9100 incorporates safety mechanisms in all its internal programming. For example: a user must make an extra confirming key-press in order to raise a voltage at the terminals above a pre-determined value.

High Voltage Warning — Take Care

After pressing OK or REPEAT PREV. keys:

*If the procedure writer has not conformed strictly to the procedure-writing guidelines, **LETHAL VOLTAGES MAY APPEAR WITHOUT WARNING AT ANY POINT IN THE PROCEDURE. ANY WARNING BEEPS SHOULD BE TAKEN VERY SERIOUSLY!***

Emergency Action — Use of OUTPUT OFF Button

In emergency, the most effective way of turning output off (other than pulling the line-power plug) is to press the OUTPUT OFF button on the right of the front panel. This may sound obvious, but a special feature of the OFF button operation is that as well as sending the appropriate message to the operating system, it also has a hardware link which bypasses the software. Even if the program has locked up, this button is effective in cutting off the output.

5.2.3 Serial Mouse

A serial mouse can be used to improve the speed of user-interaction in Procedure mode only.

Data are transferred between the mouse and 9100, providing rapid selections within certain operations of Procedure mode.

The mouse can also be used to slew the output in the 1 Year Verification procedure, and possibly in other user-programmed procedures

5.2.3.1 General Use of a Mouse

Buttons

Within Procedure mode it is advantageous to move rapidly between procedure screens. The two screen keys at the extreme left of the bottom row are often used to transfer from one procedure screen to another (one for 'OK' or 'PASS'; the other for 'FAIL').

The left and right buttons of a mouse duplicate the operation of these two screen keys. Other buttons or wheels are not used. Whenever it is necessary to press either of these screen keys, the two mouse buttons will perform the same actions.

Left - Right Mouse Movement

Movement of the serial mouse left or right is summed and mapped to the ⤴ and ⤵ keys.

Some of the Procedure mode screens offer a list of user-choices. Moving a mouse left or right will move the highlight up and down such lists, changing the selection; then pressing the left button (equivalent to 'OK' on the screen key) will confirm the selection, and usually progress to another screen.

5.2.3.2 Output Slewing

In the '1 Year Verification' procedure within Procedure mode, there is a need for the 9100 output to be adjusted ('slewed') around the nominal test point value. This enables the 'slew error' to be registered in the 9100 internal memory, to appear on printed certificates.

Front Panel Controls — Fine Slewing Adjustments

To provide slewing in single-digit increments, there is an 'ENABLE CURSOR' screen key on the bottom row of all 'READ — SLEW SOURCE' screens. The effect of pressing this key is to place the cursors on the least-significant digit of the 'Applied Value', enabling all the cursor keys, shift keys, spinwheel, and a mouse to operate as for the Digit Edit facility (*refer to Section 3, paras 3.4.4*).

Front Panel Controls — Coarse Slewing Adjustments

Most initial slewing operations will require steps of adjustment larger than a single digit. These coarser adjustments are available with the 'ENABLE CURSOR' key cancelled. Of the front panel keys, only the spinwheel and the ⤴ and ⤵ keys are enabled. The size of their increments and decrements are calculated internally: one twentieth of the value between the upper and lower limits of the specification tolerance at the subject test point.

Final Width = 215mm

Final Width = 215mm

5.2.4 Printing Setup

The results of adjustment and verification operations on UUTs can be printed on one of two forms of certificate. A suitable printer must be connected and switched on-line, and the required certificate style, format and data must be entered into the 9100 memory. Then with the correct printer type enabled, the 9100 internal program will generate the required certificate.

5.2.4.1 Printer Type

The printer to be used should be capable of printing 120 characters per line, and must be able to print the Code Page 437 character set. Most printers compatible with Epson FX, Canon Bubble-Jet or Hewlett-Packard Desk-Jet are suitable. The printer is connected to the 25-way D-type port on the 9100 rear panel.

5.2.4.2 Certificate Formatting and Data Presentation

Config mode is used to select the style of certificate to be printed, and to set the format of page length, headers, footers, etc. In addition, such certificate entries as laboratory identification, temperature and humidity can be added. Details of these elements of Config mode can be found in *Section 3, paras 3.3.2.12 to 3.3.2.22*.

5.2.4.3 Enable Printing

Printing must be enabled, using the Config mode screen keys 'PRINTER' and the appropriate selection of printer type (*refer to Section 3, paras 3.3.2.6*).

5.2.5 Saving Results on Memory Cards

Front Panel 'PROCEDURE' and 'RESULTS' Slots

In Procedure mode, the procedures for adjustment and verification operations for UUTs are controlled from a pre-programmed memory card, inserted in the left 'PROCEDURE' slot on the 9100 front panel. The results of these operations can be saved on Static RAM memory cards, inserted in the right 'RESULTS' slot. The 9100 'Test' mode of operation can be used to erase SRAM cards containing old results, and initialize them as blank results cards (*refer to Volume 2, Section 8, paras 8.3.4.5*).

Although 'FLASH' cards are used to store procedures, they cannot be used for storing results.

Use of Model 9010

The Fluke Model 9010 provides a means of programming 'Procedure' cards for users' requirements, also formatting blank 'Results' cards; and later reading the saved results for analysis, auditing and generation of high quality certificates.

5.2.5.1 Results Card Enabling and Insertion

Use of Config Mode

Config mode is used to enable results to be saved on memory cards. Details can be found in *Section 3, paras 3.3.2; 3.3.2.2 and 3.3.2.7.*

Inserting the Card

Before the results can be saved, a memory card must be inserted in the RESULTS slot and pressed firmly home. If a card is not present, a reminder will be given on the screen when the internal program attempts to write results.

Examine the Memory Card

The 68-way socket pins can be seen on the end of the card to be inserted:

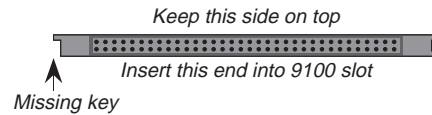

Insert the Card

When inserting, the missing key must be located underneath the card on the right front:

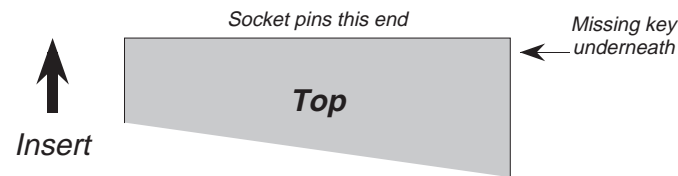

Final Width = 215mm

Write-Protect Switch

The Static RAM cards can be write-protected by means of a small switch on the opposite end to the contact pins. Obviously this protection must be switched off before the 9100 can write results. If a card *is* write protected, a warning message will appear on the screen.

Do Not Remove in Mid-Procedure

It is not necessary to insert a card before enabling, but once the card *is* inserted, it must *not* be removed until the procedure is ended or aborted. Such removal will corrupt data.

Final Width = 215mm

5.2.5.2 Stage-by-Stage Results Saving

The 9100 internal program will generate and save results at the conclusion of *each stage* in the UUT adjustment or verification procedure. The end of each stage is marked by the use of the 'OK', 'PASS' or 'FAIL' screen key on the front panel (or, of course, by the equivalent use of a mouse).

5.2.5.3 Results Memory Space

After a 'Procedure' memory card is created, an estimate of the results memory requirement for each procedure is calculated and written on to the card.

When in use, before the first results for a procedure are written into the 'Results' card, the 9100 system will review the free memory space on the card. If this is less than 150% of the procedure's estimated results requirement, the user will be warned to insert a different card.

5.2.5.4 Static RAM Card — Non-Rechargeable Battery Condition

Battery Voltage Monitoring

Each Static RAM card is powered by its own battery which maintains the non-volatile status of its RAM. While a results card is present in the 'RESULTS' slot, the 9100 continuously monitors the battery voltage state. When the voltage falls to approach a failure condition, a warning is given on the 9100 screen.

Changing the Battery

With the card present in the 'RESULTS' slot, the RAM is powered from 9100 power supplies, so it is possible to pull out the battery module from the card and insert a new module without losing the stored data.

5.2.5.5 Static RAM Card — Rechargeable Battery

Battery Charging

Each Static RAM card is powered by its own battery which maintains the non-volatile status of its RAM. While a results card is present in the 'RESULTS' slot, with the 9100 powered ON, the battery will be recharged. The specified recharge times are 8 hours to 60% capacity, and 40 Hours to 100% capacity. If the card battery charge is low when the card is inserted into the 'RESULTS' slot, a low battery warning may be given on the 9100 screen, during the initial charge period of up to 40 seconds.

Battery Access and Life

The battery is not accessible to be changed in these cards, but the retention time between chargings is in excess of six months.

5.3 Procedure Mode — Access Guide

5.3.1 Introduction

Sub-section 5.3 is a guide to access to Procedure Mode. The following topics are covered:

- 5.3.2 Mode Selection.
 - 5.3.2.1 'Mode' Key.
 - 5.3.2.2 'Mode Selection' Display.
- 5.3.3 Selection of Procedure Mode —
Entry Menus Common to All Procedures.
 - 5.3.3.1 PROC Key.
 - 5.3.3.2 Procedure Mode Display at Entry.
 - 5.3.3.3 Is Your Name on the List?.
 - 5.3.3.4 Select and Insert the Procedure Card which contains the
Procedure for the Subject UUT Model.
 - 5.3.3.5 Select the Subject UUT Manufacturer.
 - 5.3.3.6 Select the Subject UUT Model.
 - 5.3.3.7 Enter the Serial Number of the Subject UUT.
 - 5.3.3.8 Select the Procedure for the Subject UUT Model.
 - 5.3.3.9 Procedures — Card-Based Operating Instructions.
 - 5.3.3.10 'ABORT'.
 - 5.3.3.11 'END'.
 - 5.3.3.12 User Options Following 'ABORT' or 'END'.
 - 5.3.3.13 Common Operations in Procedure Mode —
Summary of Actions.

Final Width = 215mm

5.3.2 Mode Selection

(A flow chart summarizing the access to Procedures is given at paras 5.3.3.13 — Fig. 5.3.1)

5.3.2.1 'Mode' Key

The five 'Modes' are accessed by pressing the 'Mode' key at the right of the front panel.

5.3.2.2 'Mode Selection' Display

At power-on, the system defaults into either Procedure mode or Manual mode as previously programmed in 'Configure' mode. When 'Procedure' mode is required and the Configure default is 'Manual' mode, it will be necessary to transfer via the 'Mode' display.

Press the **Mode** key on the right of the front panel to obtain the 'Mode Selection' menu screen

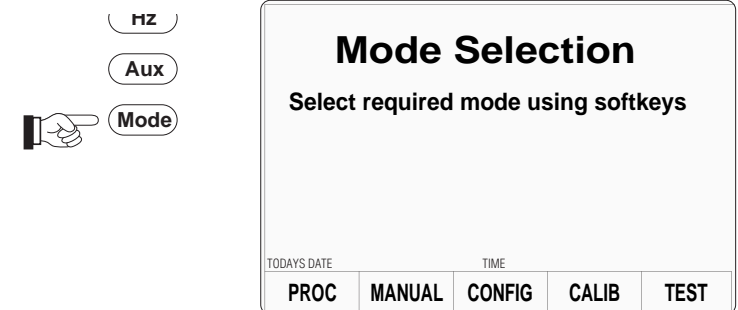

Each time the 'Mode' key is pressed, the system will present the Mode Selection menu screen for selection from the five modes:

Procedure; Manual, Configure, Calibration; Test.

Whenever the Mode Selection menu screen is opened, it will appear with the choices and information shown:

The required mode is selected by pressing its appropriate screen key on the bottom row; then the 'Mode Selection' screen will be replaced by the mode's first menu screen (or in the case of Configure or Calibration mode, the password entry screen).

Final Width = 215mm

5.3.3 Selection of Procedure Mode — Entry Menus Common to All Procedures

(A flow chart summarizing the access to Procedures is given at Paras 5.3.3.13 — Fig. 5.3.1)

5.3.3.1 PROC Key

Procedure mode is entered by pressing the 'PROC' screen key on the bottom row of the Mode Selection menu screen (or after Power On when the Procedure mode is set as the power-on default in Configuration mode).

5.3.3.2 Procedure Mode Display at Entry

When Procedure mode has been successfully entered, the 9100 starts by presenting the 'Select USER NAME ...' display: 

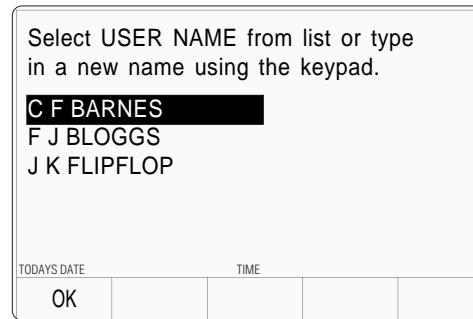

Select USER NAME from list or type in a new name using the keypad.	
C F BARNES	
F J BLOGGS	
J K FLIPFLOP	
TODAYS DATE	TIME
OK	

5.3.3.3 Is Your Name on the List?

If you are on the list, use cursor keys to select your name, then press the 'OK' screen key.

If Your Name is NOT on the List:

Use the alpha-numeric keypad to write your name (12 characters max.) on the screen^[1]. It will appear at the bottom of the screen as you type. Then press the '↵' key or the 'OK' screen key, after which the screen will change to select the manufacturer or model to be tested, except that further progress will require a procedure card to be inserted into the 'PROCEDURE MEMORY CARD' slot (refer to paras 5.3.3.4, overleaf).

The list can be cleared only by entering **CONFIG** Mode, using the password and pressing the **MORE** screen key, then using the **CLEAR USER LIST** facility.

[1] Writing Your Name on the Screen

For alphabetical characters, there are two shift keys: '▲' (blue — left) and '■' (green — right) on the bottom row of the keypad. The numeric keys have colour-coded alphabetical characters printed on left and right. Press and release the appropriate shift key then the alphabetic character key in order to spell out your name.

Only UPPER CASE characters are available from the keypad.

After one of the shift keys has been pressed, and before pressing the '↵' key, the corresponding shift icon is presented at the bottom right of the screen.

Final Width = 215mm

Final Width = 215mm

5.3.3.4 Select and Insert the Procedure Card which contains the Procedure for the Subject UUT Model

a. No Procedure Card in Slot, and no Procedures Downloaded

Up to now, there has been no need to use the Procedure memory card. After this point, the 9100 needs to extract information from the card, so the card required for the UUT must be inserted into the 'Procedure' slot, and pushed firmly home. But first:

Examine the Memory Card

The 68-way socket pins can be seen on the end of the card to be inserted:

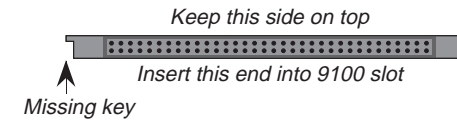

Insert the Card

When inserting, the missing key must be located underneath the card on the right front:

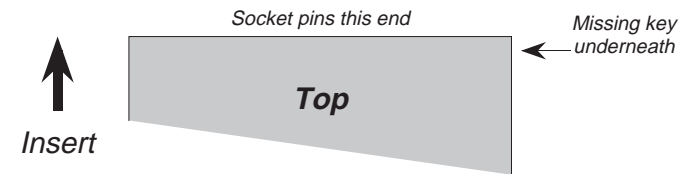

If no Procedure Card has yet been inserted into the slot, and no procedure is at present resident in the RAM, (see 5.3.3.6), then the following message will appear on the screen:

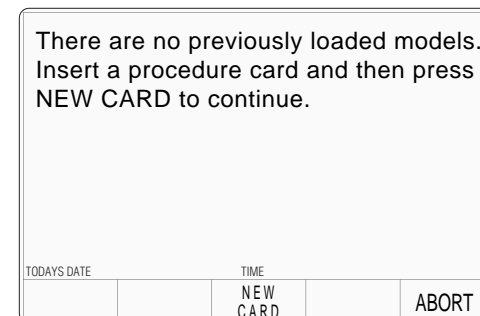

In this case, insert the card required for the UUT into the 'Procedure' slot, push gently home, and press the 'NEW CARD' screen key for the sequence to continue.

The 9100 will transfer to the 'Select MANUFACTURER' menu screen if more than one manufacturer is listed in the procedure card, or to 'Select MODEL' screen if only one manufacturer is listed.

ABORT returns to the 'Select USER NAME ...' screen.
Refer to paras 5.3.3 13, Fig 5.3.1.

b. No Procedure Card in Slot, but a UUT Model's Procedures Resident in RAM

If, on a previous occasion since the most-recent power-on, a UUT model was selected from the Select Model screen menu, the 9100 will have downloaded all the procedures for the selected model into internal RAM.

If, on this occasion, no Procedure memory card has yet been inserted into the slot, and procedures are still resident in the RAM, (*see 5.3.3.6*), then a message similar to the following will appear on the screen:

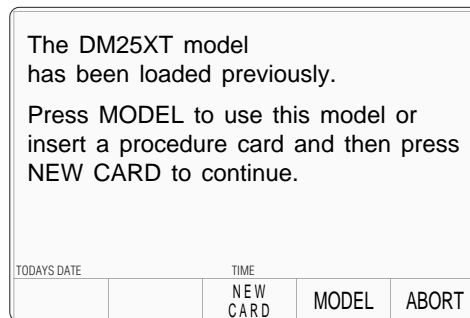

Final Width = 215mm

A choice is given: whether to use the loaded procedures, or to insert a new card to load a different model's procedures.

For the same model, merely press the 'MODEL' screen key and the 9100 will transfer to the 'Enter the SERIAL NUMBER ...' screen.

For a different model, insert the card required for the UUT into the 'Procedure' slot, push firmly home, and press the 'NEW CARD' screen key for the sequence to continue.

After pressing 'NEW CARD', the 9100 will transfer to the 'Select MANUFACTURER' menu screen if more than one manufacturer is listed in the procedure card, or to 'Select MODEL' screen if only one manufacturer is listed.

ABORT returns to the 'Select USER NAME ...' screen.
Refer to *paras 5.3.3 13, Fig 5.3.1.*

Final Width = 215mm

5.3.3.5 Select the Subject UUT Manufacturer

(Only available if more than one manufacturer is listed in the Procedure Card)

By the time the 'Select MANUFACTURER' screen has been successfully opened, the 9100 will have extracted a list of the manufacturers whose models' procedures are contained in the Procedure card memory. These it displays on the screen for the user to choose. For example:

Select MANUFACTURER using cursor keys.
Press NEW CARD to read another card.

MANUF 1
MANUF 2

TODAYS DATE TIME

OK NEW CARD ABORT

If the wrong card has been inserted:

Remove that card, insert another, then press the NEW CARD screen key to tell the 9100 that a different card has been inserted.

More than one manufacturer listed in the new card:

The 9100 lists the manufacturers whose models' procedures are resident in the new card

Only one manufacturer listed in the new card:

The 9100 transfers to the 'Select MODEL' screen if only one manufacturer is listed.

Correct manufacturer selected:

After selecting the required manufacturer, pressing the OK screen key will cause the 9100 to transfer to the 'Select MODEL' menu screen.

ABORT returns to the 'Select USER NAME ...' screen.

Refer to *paras 5.3.3 13, Fig 5.3.1.*

5.3.3.6 Select the Subject UUT Model

By the time the 'Select MODEL' screen has been successfully opened, the 9100 will have extracted a list of the models whose procedure is contained in the Procedure card memory. These it displays on the screen for the user to choose. For example:

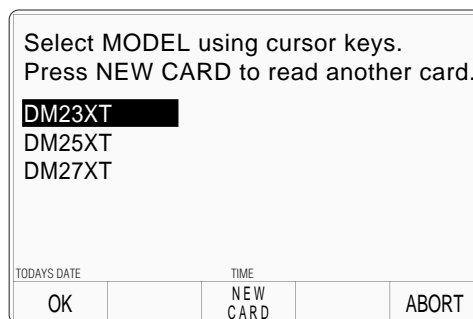

If the wrong card has been inserted:

Remove that card, insert another, then press the NEW CARD screen key to tell the 9100 that a different card has been inserted.

More than one manufacturer listed in the new card:

The 9100 lists the manufacturers whose models' procedures are resident in the new card. After selecting the required manufacturer using the cursor keys, pressing the OK screen key will cause the 9100 to transfer to the 'Select MODEL' menu screen.

Only one manufacturer listed in the new card:

The 9100 transfers to the 'Select MODEL' screen if only one manufacturer is listed.

Correct Model selected:

After selecting the required model, pressing the OK screen key will cause the 9100 to download all the procedures for that model into internal RAM. The card can then be removed and used to load another instrument.

After choosing the model, the next stage is to enter the UUT serial number. Pressing the 'OK' screen key will cause the 9100 to transfer to the 'Serial Number' screen.

ABORT returns to the 'Select USER NAME ...' screen.

Refer to *paras 5.3.3 13, Fig 5.3.1.*

Final Width = 215mm

Final Width = 215mm

[1] Writing the Serial Number

For alphabetical characters, there are two shift keys: '▲' (blue — left) and '■' (green — right) on the bottom row of the keypad. The numeric keys have colour-coded alphabetical characters printed on left and right. Press and release the appropriate shift key then the alphabetic character key in order to spell out your name.

Only UPPER CASE characters are available from the keypad.

After one of the shift keys has been pressed, and before pressing the '↵' key, the corresponding shift icon is presented at the bottom right of the screen.

5.3.3.7 Enter the Serial Number of the Subject UUT

Having selected the UUT model, the 9100 asks for the serial number to be entered so that any results can be identified. This is done on the following screen:

Enter the SERIAL NUMBER of UUT..
Confirm with OK.

Serial Number:

TODAYS DATE TIME

OK ABORT

Enter the UUT's Serial Number:

Use the alpha-numeric keypad to write the serial number (20 characters max.) on the screen^[1]. It will appear at the bottom of the screen as you type. Then press the '↵' key or the 'OK' screen key, after which the screen will change to select the type of procedure required

ABORT returns to the 'Select USER NAME ...' screen.
Refer to *paras 5.3.3 13, Fig 5.3.1.*

5.3.3.8 Select the Procedure for the Subject UUT Model

When the 'Select PROCEDURE' screen is opened, the 9100 will have already downloaded all the procedures for the selected model from the Procedure card memory into internal RAM. The 9100 displays a list of these on the screen for the user to choose:

Select PROCEDURE using cursor keys.
Confirm with OK.

Adjustment Only
1 Year Verification
ISO9000 Verify
Verify Pass/Fail
ISO9000 Pass/Fail

TODAYS DATE TIME

OK ABORT

Types of Procedure (*Procedure Cards supplied from the Procedure Library*)

Variants of three basic procedures (Adjustment Only; 1 Year Verification and Verify Pass/Fail) can be found in the Procedure cards available in the manufacturer's UUT Calibration Procedure Library (*sub-section 1.4*). The Model 9010 provides for users to generate other procedures. The titles of all procedures present in a Procedure card for a model will be listed on the 'Select PROCEDURE' screen.

Adjustment Only

The procedure will cause the 9100 to provide the correct outputs for each of the Manufacturer's recommended test points for adjustment of the subject UUT model. The identity of adjustment controls, target values and limits are presented on the screen for the convenience of the user, who will also decide whether the adjustment was successful, and record pass/fail status. The procedure is described in *sub-section 5.4*.

1 Year Verification

The 9100 provides the correct outputs for each of the Manufacturer's recommended test points used to verify the full performance of the subject UUT model. Users can slew the output to determine the UUT error. 'Style 1' printed results will list these errors. The procedure is described in *sub-section 5.5*.

ISO9000 Verify

This is a variant of 1 Year Verification, different in that the 9100 provides a wider range of test points to verify performance in greater detail than is recommended by the Manufacturer.



Verify Pass/Fail

The 9100 provides the correct outputs at each of the test points, for the user to check whether the UUT verifies within its specification. Pass/Fail only is printed on the report. The procedure is described in *sub-section 5.6*.

ISO9000 Pass/Fail

This is a variant of Verify Pass/Fail, different in that the 9100 provides a wider range of test points to check the specification in greater detail than is recommended by the Manufacturer.

To Select a Procedure

Use either the  and  cursor keys, the spinwheel, or a mouse to highlight the required procedure, then press 'OK'. the 9100 will transfer to the appropriate menu screen. Refer to the procedure description.

ABORT returns to the 'Select USER NAME ...' screen.

Refer to *paras 5.3.3 13, Fig 5.3.1*.

Final Width = 215mm

Final Width = 215mm

5.3.3.9 Procedures — Card-Based Operating Instructions

Selection of UUT Model

When the model of UUT has been chosen from the menu (derived from the procedure card), all procedures for the selected model are automatically downloaded into the 9000's internal memory, and the selected procedure no longer requires the card, as it will be programmed from the internal memory. Once the procedure has progressed this far, the procedure card can be removed and used to program other Model 9100 units.

Procedure Activation

Once the type of procedure has been selected, the downloaded user-interactive program will be run by the 9100. Subsequent instructions appearing on the screen will be derived from the programmed sequences.

No further routine instructions are given here, as they may vary from model to model and are developed within the programmed sequences. However, the 9100 is programmed also to interrupt procedures and communicate with the user when certain events occur. Among these, the two most important are those of 'Abort' and 'End'.

5.3.3.10 'ABORT'

Up to this point of choosing a procedure, when an 'ABORT' screen key is pressed, the system will revert to the first Procedure-mode screen 'Select USER NAME'.

After the choice of procedure has been confirmed by 'OK', the procedure itself is controlled from the card sequence, and when an 'ABORT' screen key is pressed, the system will generate a special 'ABORT' message which also ends the procedure, overwriting the currently-displayed screen: 

The procedure can be aborted by the 9100 itself for other reasons. This will also invoke the 'ABORT' screen.

For the choices obtained from the five screen keys, refer to *paras 5.3.3.12*.

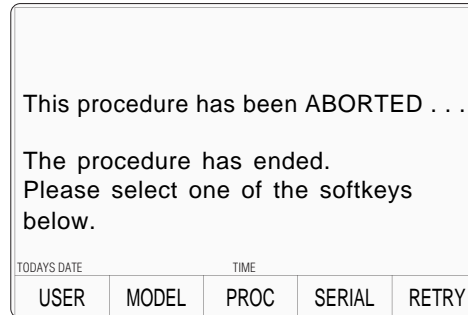

This procedure has been ABORTED . . .

The procedure has ended.
Please select one of the softkeys
below.

TODAYS DATE	TIME			
USER	MODEL	PROC	SERIAL	RETRY

Final Width = 215mm

5.3.3.11 'END'

When all stages of the procedure have been completed, the system will end the procedure, also generating a special 'END' message which overwrites the currently- displayed screen:

For the choices obtained from the five screen keys, refer to *paras 5.3.3.12*.

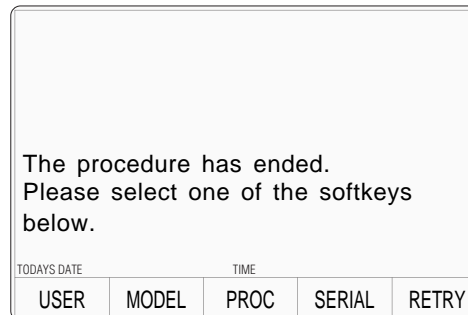

The procedure has ended.
Please select one of the softkeys
below.

TODAYS DATE	TIME			
USER	MODEL	PROC	SERIAL	RETRY

Final Width = 215mm

5.3.3.12 User Options Following 'ABORT' or 'END'

Once the procedure has ended or been aborted, the user can return to one of five points in the sequence. The point numbers refer to *Fig 5.3.1*:

USER *(Point 1)*

The 'Select USER NAME' screen is the first to appear after selecting Procedure mode. All setup parameter variables can be changed, and a new procedure card can be inserted.

MODEL *(Point 2)*

The 'Select MODEL' screen offers user-selection from all the UUT models (for the previously-selected manufacturer) on the currently-loaded procedure card; or a new procedure card can be inserted.

Note: For those cards containing procedures for UUTs from more than one manufacturer: then in order to change manufacturer, return to the 'Select USER NAME' screen by pressing the 'USER' screen key.

SERIAL *(Point 3)*

This choice assumes a wish to select a different unit of the same model. The system therefore returns to the 'Enter SERIAL NUMBER' screen.

PROC *(Point 4)*

This choice assumes a wish to select a different procedure for the same model and serial number. The system therefore returns to the 'Select PROCEDURE' screen.

RETRY *(Point 5)*

This selection re-runs the same procedure which has just ended or been aborted. It is assumed that the same unit is being tested, so the same serial number will appear on any results print-out.

5.3.3.13 Common Operations in Procedure Mode — Summary of Actions

The flow chart in *Fig. 5.3.1* summarizes the user actions needed to enter Procedure mode and load the procedure card; then select the UUT model and its pre-programmed procedures:

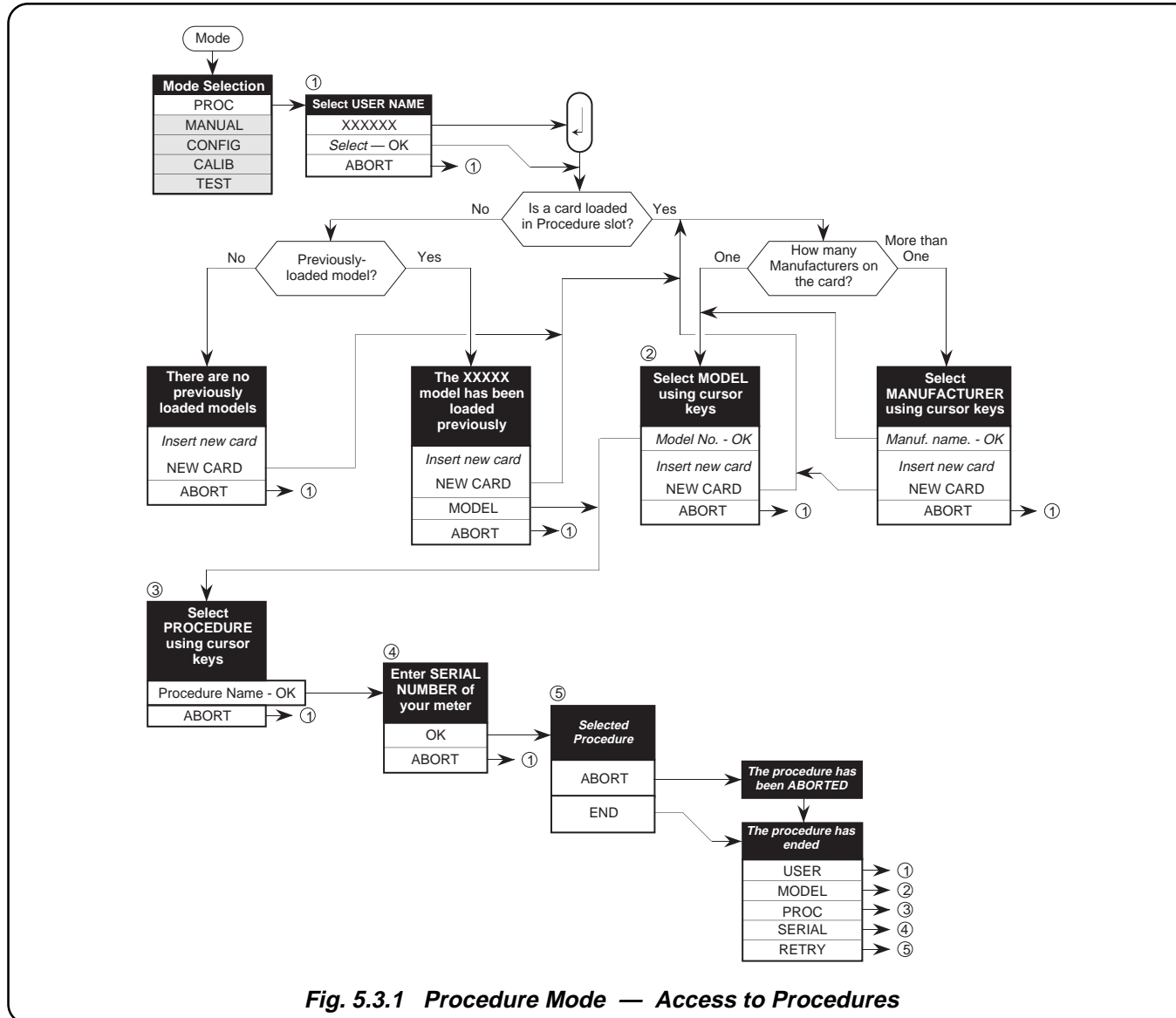

Final Width = 215mm

Fig. 5.3.1 Procedure Mode — Access to Procedures

5.4 Procedure Mode — Adjustment Only Procedure

5.4.1 Introduction

Sub-section 5.4 extends the Procedure mode access guide of sub-section 5.3, to describe elements in the use of 'Adjustment Only' Procedure. The following topics are covered:

- 5.4.2 'Adjustment Only' Procedure Selection.
 - 5.4.2.1 Procedure Menu Screen for the Subject UUT Model.
 - 5.4.2.2 Selection of 'Adjustment Only'.
- 5.4.3 General Sequence.
 - 5.4.3.1 'OPERATOR PROMPT'.
 - 5.4.3.2 'UUT ADJUST'.
 - 5.4.3.3 High Voltage Warning.
 - 5.4.3.4 OK / FAIL Screen Keys.
 - 5.4.3.5 'REPEAT PREV.' Key.
 - 5.4.3.6 'ABORT' Key and End of Procedure.
- 5.4.4 Verification of Results.

Final Width = 215mm

5.4.3 General Sequence

As the sequence progresses, user-interaction will be required to make connections, set UUT front panel controls and adjust the relevant UUT control.

5.4.3.1 'OPERATOR PROMPT'

Within the 'Adjustment Only' procedure, a prompt to inform the operator may appear on the screen, giving the number of internal adjustments present in the procedure. Other prompts are concerned with connections, range switching, and removal of UUT covers. The number and character of the prompts are determined when the procedure is written.

5.4.3.2 'UUT ADJUST'

The adjustment instructions contained within the 'Adjustment Only' procedure, are given on a screen which includes the words 'UUT ADJUST'. The following example shows a typical presentation:

	Wavetek DM25XT Adjustment Only U00231						
200 mV Range +190 mV							
UUT ADJUST							
Adjust VR1 (lower left trim pot) until UUT displays the target value and is within the limits shown.							
<table border="1"><tr><td>190.0</td></tr><tr><td>UUT Target</td></tr></table>	190.0	UUT Target	<table border="1"><tr><td>190.1</td><td>Upper Limit</td></tr><tr><td>189.9</td><td>Lower Limit</td></tr></table>	190.1	Upper Limit	189.9	Lower Limit
190.0							
UUT Target							
190.1	Upper Limit						
189.9	Lower Limit						
TODAYS DATE	TIME						
OK	FAIL		Repeat Prev.	ABORT			

Final Width = 215mm

The identity of the adjustment controls will be given. For their location and access, refer to the UUT calibration instructions.

Final Width = 215mm

5.4.3.3 High Voltage Warning

After pressing **OK** or **REPEAT PREV.** keys:

*If the procedure writer has not conformed strictly to the procedure-writing guidelines, **LETHAL VOLTAGES MAY APPEAR WITHOUT WARNING AT ANY POINT IN THE PROCEDURE. ANY WARNING BEEPS SHOULD BE TAKEN VERY SERIOUSLY!***

Emergency Action

*In emergency, the most effective way of turning output off (other than pulling the line-power plug) is to press the **OUTPUT OFF** button on the right of the front panel. This may sound obvious, but a special feature of the **OFF** button operation is that as well as sending the appropriate message to the operating system, it also has a hardware link which bypasses the software. Even if the program has locked up, this button is effective in cutting off the output.*

5.4.3.4 OK / FAIL Screen Keys

The use of the 'OK' and 'FAIL' screen keys is to inform the 9100 whether or not it was possible, by making the specified adjustment, for the UUT measurement to be set to the target value.

'FAIL' Key

If, by adjustment, the UUT measurement cannot reach the target value, the 'FAIL' key should be pressed. This will cause the 9100 to register the test as an 'Invalid Reading', and print this on the certificate.

'OK' Key

If, by adjustment, the UUT measurement acquires the target value, the 'OK' key should be pressed. This will cause the 9100 to register the test as a 'Valid Reading'.

5.4.3.5 'REPEAT PREV.' Key

The effect of pressing the 'REPEAT PREV.' (repeat previous) screen key, on the *first* 'Prompt' screen of a test point, is to force the procedure back to the first screen for the test point immediately preceding the current point.

On any screen other than the first, pressing the 'REPEAT PREV.' key will return to the first screen of the current test point.

5.4.3.6 'ABORT' Key and End of Procedure

The effects of (a) pressing the 'ABORT' screen key or (b) arriving at the end of the card procedure are described in *sub-section 5.3, paras 5.3.3.9 to 5.3.3.13.*

5.4.4 Verification of Results

Following any adjustment, the UUT performance must be verified in accordance with the manufacturer's instructions. Either the '1 Year Verification', the ISO9000 Verify, the 'Verify Pass/Fail' or the 'ISO9000 Verify procedure can be used, depending on local requirements.

Final Width = 215mm

5.5 Procedure Mode — '1 Year Verification' & 'ISO9000 Verify' Procedures

5.5.1 Introduction

Sub-section 5.5 extends the Procedure mode access guide of sub-section 5.3, to describe the use of the '1 Year Verification' Procedure and its variant 'ISO9000 Verify'. The following topics are covered:

- 5.5.1.1 'ISO9000 Verify' Procedure.
- 5.5.2 '1 Year Verification' or 'ISO9000 Verify' Procedure Selection.
 - 5.5.2.1 Procedure Menu Screen for the Subject UUT Model.
 - 5.5.2.2 Selection of '1 Year Verification' or 'ISO9000 Verify'.
- 5.5.3 General Sequence.
 - 5.5.3.1 'OPERATOR PROMPT'.
 - 5.5.3.2 'READ — SLEW SOURCE'.
 - 5.5.3.3 High Voltage Warning.
 - 5.5.3.4 'OK' / 'FAIL' Screen Keys.
 - 5.5.3.5 'ENABLE CURSORS' Key.
 - 5.5.3.6 'REPEAT PREV.' Key.
 - 5.5.3.7 'ABORT' Key and End of Procedure.
- 5.5.4 Output Slewing.
 - 5.5.4.1 Fine Slewing Adjustments.
 - 5.5.4.2 Coarse Slewing Adjustments.

Final Width = 215mm

5.5.1.1 'ISO9000 Verify' Procedure

The mechanics of using the 'ISO9000 Verify' procedure are virtually identical with those for '1 Year Verification'. Except for initial selection of the procedure, the only differences are in the number and range of test points to be verified. These will become evident while using the programmed procedure cards, and need no further explanation here.

When reading this sub-section for the 'ISO9000 Verify' procedure, merely substitute 'ISO9000 Verify' for '1 Year Verification'.

Final Width = 215mm

5.5.2 '1 Year Verification' or 'ISO9000 Verify' Procedure Selection

(Assuming that the correct procedure card has been inserted, the user name has been entered, the subject UUT model has been selected, and the UUT serial number has been entered)

5.5.2.1 Procedure Menu Screen for the Subject UUT Model

When the 'Select PROCEDURE' screen has been successfully opened in the 'Select Model' menu screen, the 9100 will have already downloaded all the procedures for the selected model from the Procedure card memory into internal RAM. The 9100 displays a list of these on the screen for the user to choose. For example:

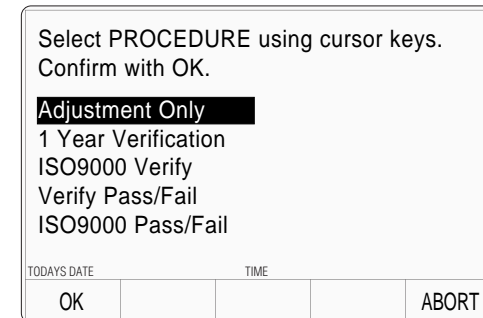

5.5.2.2 Selection of '1 Year Verification' or 'ISO9000 Verify'

The procedure titles appear in the same order as the procedures are stored on the card. Use the ⬆ and ⬇ cursor keys to highlight the '1 Year Verification' or 'ISO9000 Verify' procedure, then press 'OK'. The 9100 will transfer to a menu screen which starts the procedure.

The memorized procedure will cause the 9100 to provide the correct outputs for verifying the subject UUT model, at each of the recommended test points. Methods of connection, identification of target values and limits, plus access to slew the output value using spinwheel or a mouse, appear on the screen for the convenience of the user, who will decide whether the test was successful, and record pass/fail status.

Procedure Activation

Once the type of procedure has been selected, the downloaded user-interactive program will be run by the 9100. Subsequent instructions appearing on the screen will be derived from the programmed sequences.

No further routine instructions are given here, as they may vary from model to model and are developed within the programmed sequences. However, the 9100 is programmed also to interrupt procedures and communicate with the user when certain events occur. Among these, the two most important are those of 'Abort' and 'End'; for further information, refer to *sub-section 5.3, paras 5.3.3.9 to 5.3.3.13*. 5.5.2.3.

Note about Noise when Reading the UUT Measurement

Presence of Noise

The UUT design or external conditions can add noise to readings obtained on the UUT. This may vary between functions and ranges for an individual UUT, and may or may not be given a specification by the UUT manufacturer.

How the Noise Appears

On a digital UUT display, this noise will appear as a variation (digit run-around), between maximum and minimum values. On an analog display there will be a variation in the position of a needle or other indication.

Slewing to a Mean Target

The 9100 'Applied Value' should be slewed until any variation is balanced about the 'UUT Target' value as shown on the 9100 'READ — SLEW SOURCE' screen.

Allowable Limits

As well as the Target and Applied Values, the 9100 screen also presents an 'Upper Limit' and a 'Lower Limit' which represents the noise specification of the UUT (± 1 digit in the example shown). For the measurement to be valid, the variation should be such that maximum and minimum variations do not exceed these limits.

5.5.3 General Sequence

As the sequence progresses, user-interaction will be required to make connections, set UUT front panel controls and slew the output.

5.5.3.1 'OPERATOR PROMPT'

Within the procedure, prompts may appear on the screen to inform the operator. These prompts will be concerned with connections, range switching, etc. The number and character of the prompts are determined when the procedure is written.

5.5.3.2 'READ — SLEW SOURCE'

Within the procedure, a screen headed 'READ — SLEW SOURCE' may appear. The following example shows a typical presentation:

Wavetek
DM25XT
ISO9000 Verification
U00231

20 V Range 19 V @ 400 Hz
READ — SLEW SOURCE

Use controls to adjust 9100 output
until UUT display is equal to the
target shown, within the limits given.

19.00	19.01	Upper Limit
	18.99	Lower Limit

UUT Target 19.0000 V Applied Value

TODAYS DATE TIME

OK	FAIL	Enable Cursors	Repeat Prev.	ABORT
----	------	-------------------	-----------------	-------

Final Width = 215mm

By adjusting the 9100 output until the UUT shows the target value, the actual error in the UUT measurement can be registered, and stored within the 9100 itself. Subsequently, this error can be printed on any results certificate.

Final Width = 215mm

5.5.3.3 High Voltage Warning

After pressing **OK** or **REPEAT PREV.** keys:

If the procedure writer has not conformed strictly to the procedure-writing guidelines, **LETHAL VOLTAGES MAY APPEAR WITHOUT WARNING AT ANY POINT IN THE PROCEDURE. ANY WARNING BEEPS SHOULD BE TAKEN VERY SERIOUSLY!**

Emergency Action

In emergency, the most effective way of turning output off (other than pulling the line-power plug) is to press the **OUTPUT OFF** button on the right of the front panel. This may sound obvious, but a special feature of the **OFF** button operation is that as well as sending the appropriate message to the operating system, it also has a hardware link which bypasses the software. Even if the program has locked up, this button is effective in cutting off the output.

5.5.3.4 'OK' / 'FAIL' Screen Keys

The use of the 'OK' and 'FAIL' screen keys (or the left/right buttons of a mouse) is to inform the 9100 whether or not it was possible, by slewing the source, for the UUT measurement to be set to the target value.

'FAIL' Key

If, by slewing, the UUT measurement cannot reach the target value, the 'FAIL' key should be pressed. This will cause the 9100 to register the test as an 'Invalid Reading', and print this on the certificate.

'OK' Key

If, by slewing, the UUT measurement acquires the target value, the 'OK' key should be pressed. This will cause the 9100 to register the test as a 'Valid Reading'. From the amount of slew (slew error) from nominal which is required to reach the target value, the 9100 will place the test into one of three categories:

- **Fail:** The slew error is greater than 100% of the specification tolerance for that particular test point.
- **Borderline:** The slew error is equal to or less than 100% of the specification tolerance for that particular test point; and greater than a percentage of that tolerance set by the user as 'borderline' within Config mode.
- **Pass:** The slew error is equal to or less than a percentage of the specification tolerance for that particular test point, set by the user as 'borderline' within Config mode.

5.5.3.5 'ENABLE CURSORS' Key

Refer to *paras 5.5.4.*

5.5.3.6 'REPEAT PREV.' Key

The effect of pressing the 'REPEAT PREV.' (repeat previous) screen key, on the *first* 'Prompt' screen of a test point, is to force the procedure back to the first screen for the test point immediately preceding the current point.

On any screen other than the first, pressing the 'REPEAT PREV.' key will return to the first screen of the current test point.

5.5.3.7 'ABORT' Key and End of Procedure

The effects of: (a) pressing the 'ABORT' screen key; or: (b) arriving at the end of the card procedure; are described in *sub-section 5.3, paras 5.3.3.9 to 5.3.3.13.*

Final Width = 215mm

Final Width = 215mm

5.5.4 Output Slewing

In the '1 Year Verification' and 'ISO9000 Verify' procedures, there is a need for the 9100 output to be adjusted ('slewed') around the nominal test point value. This enables the 'slew error' to be registered in the 9100 internal memory, to appear on printed certificates.

5.5.4.1 Fine Slewing Adjustments

To provide slewing in single-digit increments, there is an 'ENABLE CURSOR' screen key on the bottom row of all 'READ — SLEW SOURCE' screens. The effect of pressing this key is to place the cursors on the least-significant digit of the 'Applied Value', enabling all the cursor keys, shift keys, spinwheel, and mouse to operate as for the Digit Edit facility (*refer to Section 3, paras 3.4.4*).

5.5.4.2 Coarse Slewing Adjustments

Most slewing operations will require initial steps of adjustment larger than a single digit. These coarser adjustments are made available on the 'Applied Value', with the 'ENABLE CURSOR' key cancelled, in order to reduce the time required to perform a verification. Only the spinwheel, the ☺ and ☹ keys and mouse are enabled. The size of their increments and decrements are calculated internally as: one twentieth of the value between the upper and lower limits of the specification tolerance at the subject test point.

5.6 Procedure Mode — 'Verify Pass/Fail' & 'ISO9000 Pass/Fail' Procedures

5.6.1 Introduction

Sub-section 5.6 extends the Procedure mode access guide of sub-section 5.3, to describe the use of the 'Verify Pass/Fail' Procedure and its variant 'ISO9000 Pass/Fail'. The following topics are covered:

- 5.6.1.1 'ISO9000 Pass/Fail' Procedure.
- 5.6.2 'Verify Pass/Fail' or 'ISO9000 Pass/Fail' Procedure Selection.
 - 5.6.2.1 Procedure Menu Screen for the Subject UUT Model.
 - 5.6.2.2 Selection of 'Verify Pass/Fail' or 'ISO9000 Pass/Fail'.
- 5.6.3 General Sequence.
 - 5.6.3.1 'OPERATOR PROMPT'.
 - 5.6.3.2 'READ — PASS / FAIL NUMERIC'.
 - 5.6.3.3 High Voltage Warning.
 - 5.6.3.4 'PASS' / 'FAIL' Screen Keys.
 - 5.6.3.5 'REPEAT PREV.' Key.
 - 5.6.3.6 'ABORT' Key and End of Procedure.

Final Width = 215mm

5.6.1.1 'ISO9000 Pass/Fail' Procedure

The mechanics of using the 'ISO9000 Pass/Fail' procedure are virtually identical with those for 'Verify Pass/Fail'. Except for initial selection of the procedure, the only differences are in the number and range of test points to be verified. These will become evident while using the programmed procedure cards, and need no further explanation here.

When reading this sub-section for the 'ISO9000 Pass/Fail' procedure, merely substitute 'ISO9000 Pass/Fail' for 'Verify Pass/Fail'.

Final Width = 215mm

5.6.2 'Verify Pass/Fail' or 'ISO9000 Pass/Fail' Procedure Selection

(Assuming that the correct procedure card has been inserted, the user name has been entered, the subject UUT model has been selected, and the UUT serial number has been entered)

5.6.2.1 Procedure Menu Screen for the Subject UUT Model

When the 'Select PROCEDURE' screen has been successfully opened in the 'Select Model' menu screen, the 9100 will have already downloaded all the procedures for the selected model from the Procedure card memory into internal RAM. The 9100 displays a list of these on the screen for the user to choose. For example:

Select PROCEDURE using cursor keys. Confirm with OK.			
Adjustment Only			
1 Year Verification			
ISO9000 Verify			
Verify Pass/Fail			
ISO9000 Pass/Fail			
TODAYS DATE		TIME	
OK			ABORT

5.6.2.2 Selection of 'Verify Pass/Fail' or 'ISO9000 Pass/Fail'

The procedure titles appear in the same order as the procedures are stored on the card. Use the ⤴ and ⤵ cursor keys to highlight the 'Verify Pass/Fail' or 'ISO9000 Pass/Fail' procedure, then press 'OK'. The 9100 will transfer to a menu screen which starts the procedure.

The memorized procedure will cause the 9100 to provide the correct outputs for verifying the subject UUT model, at each of the recommended test points. Methods of connection, with identification of target values and limits, appear on the screen for the convenience of the user, who will decide whether the test was successful, and record pass/fail status.

Procedure Activation

Once the type of procedure has been selected, the downloaded user-interactive program will be run by the 9100. Subsequent instructions appearing on the screen will be derived from the programmed sequences.

No further routine instructions are given here, as they may vary from model to model and are developed within the programmed sequences. However, the 9100 is programmed also to interrupt procedures and communicate with the user when certain events occur. Among these, the two most important are those of 'Abort' and 'End'; for further information, refer to *sub-section 5.3, paras 5.3.3.9 to 5.3.3.13*.

5.6.3 General Sequence

As the sequence progresses, user-interaction will be required to make connections, set UUT front panel controls, read the UUT measurement and report a 'PASS' or 'FAIL'.

5.6.3.1 'OPERATOR PROMPT'

Within the procedure, prompts may appear on the screen to inform the operator. These prompts will be concerned with connections, range switching, etc. The number and character of the prompts are determined when the procedure is written.

5.6.3.2 'READ — PASS / FAIL NUMERIC'

Within the procedure, a screen headed 'READ — PASS / FAIL NUMERIC' may appear. The following example shows a typical presentation:

The screenshot shows a device display with the following content:

- Top left: A sine wave icon, a 'V' symbol, and a square icon containing a lightning bolt, a '0', and a '1'.
- Top right: Text reads "Wavetek DM25XT Verify Pass / Fail U00231".
- Second line: "20 V Range 19 V @ 400 Hz".
- Third line: A black bar with white text "READ PASS / FAIL NUMERIC".
- Fourth line: "Verify that the UUT display is within the limits given."
- Bottom section: A table with two columns for limits and one for the target.

18.77	19.23	
Lower Limit	Upper Limit	
19.00		UUT Target
TODAYS DATE	TIME	
PASS	FAIL	Repeat Prev.
		ABORT

Final Width = 215mm

Using the 'PASS' or 'FAIL' keys, the UUT pass / fail status is stored within the 9100 itself. Subsequently, this status can be printed on any results certificate.

Final Width = 215mm

5.6.3.3 High Voltage Warning

After pressing **PASS** or **REPEAT PREV.** keys:

*If the procedure writer has not conformed strictly to the procedure-writing guidelines, **LETHAL VOLTAGES MAY APPEAR WITHOUT WARNING AT ANY POINT IN THE PROCEDURE. ANY WARNING BEEPS SHOULD BE TAKEN VERY SERIOUSLY!***

Emergency Action

*In emergency, the most effective way of turning output off (other than pulling the line-power plug) is to press the **OUTPUT OFF** button on the right of the front panel. This may sound obvious, but a special feature of the **OFF** button operation is that as well as sending the appropriate message to the operating system, it also has a hardware link which bypasses the software. Even if the program has locked up, this button is effective in cutting off the output.*

5.6.3.4 'PASS' / 'FAIL' Screen Keys

The 'PASS' and 'FAIL' screen keys are provided for the user to inform the 9100 whether or not the UUT measurement is within the target value limits.

'FAIL' Key

If the UUT measurement *is not* at or within the target value upper and lower limits, the 'FAIL' key should be pressed. This will cause the 9100 to register the test as a 'Fail':

Fail: The UUT measurement error is greater than 100% of the specification tolerance for that particular test point.

'PASS' Key

If the UUT measurement *is* at or within the target value upper and lower limits, the 'PASS' key should be pressed. This will cause the 9100 to register the test as a 'Pass':

Pass: The UUT measurement error is equal to or less than 100% of the specification tolerance for that particular test point.

The pass/fail status for that particular test point will be printed on the certificate for the 'Verify Pass / Fail' procedure.

5.6.3.5 'REPEAT PREV.' Key

The effect of pressing the 'REPEAT PREV.' (repeat previous) screen key, on the *first* 'Prompt' screen of a test point, is to force the procedure back to the first screen for the test point immediately preceding the current point.

On any screen other than the first, pressing the 'REPEAT PREV.' key will return to the first screen of the current test point.

5.6.3.6 'ABORT' Key and End of Procedure

The effects of: (a) pressing the 'ABORT' screen key; or: (b) arriving at the end of the card procedure; are described in *sub-section 5.3, paras 5.3.3.9 to 5.3.3.13*.

Final Width = 215mm

