

WAVETEK®
SAN DIEGO

REFERENCE COPY

INTRODUCTION MANUAL

MODELS 270, 271 and 278

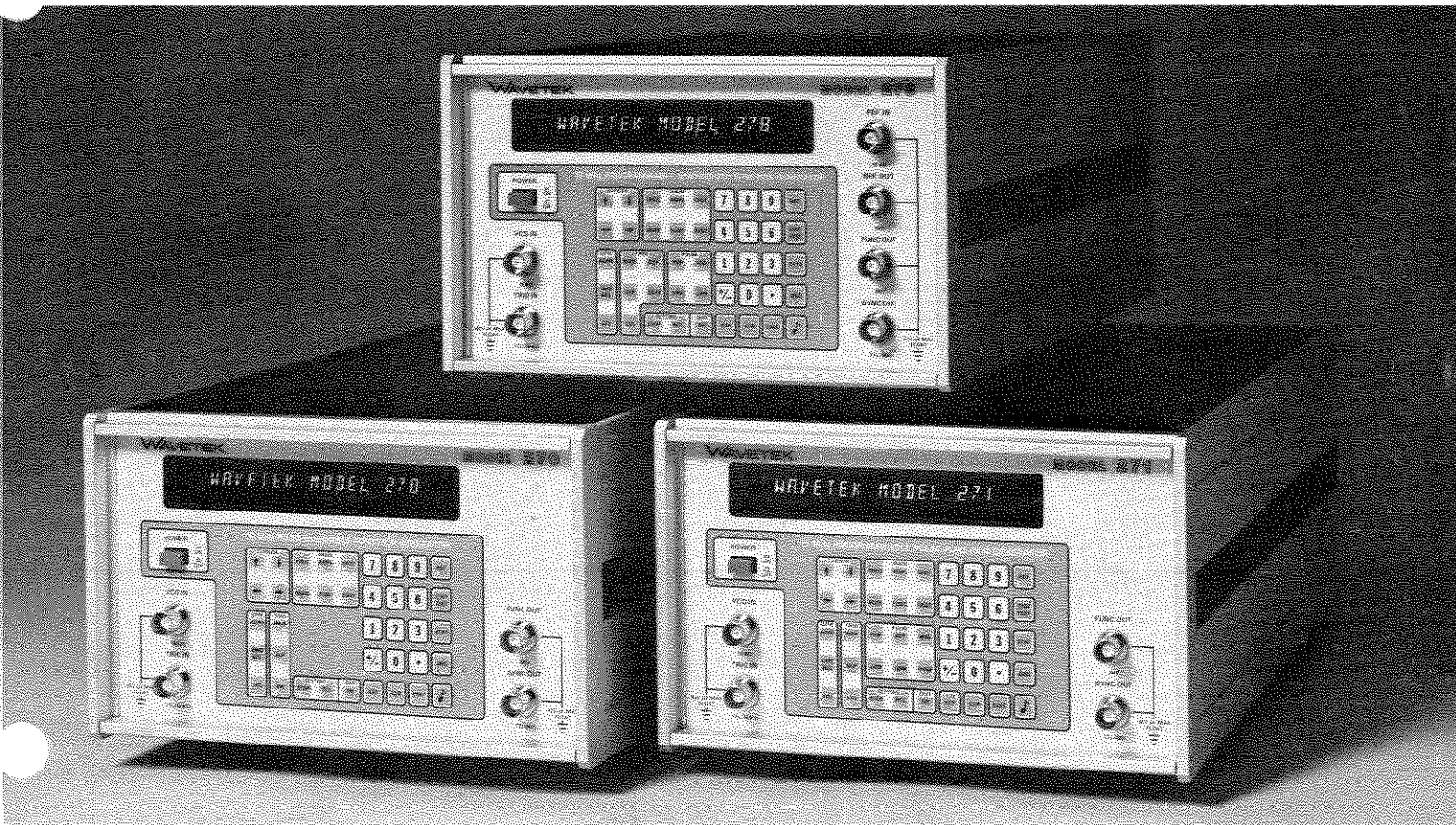

Programmable Function Generators

CONTENTS

	270	271	278
Introduction	1	1	1
Key Features	3	3	3
Benefits	4	5	6
Operation Demonstration	7	7	7
Controls and Connectors	16	16A	16B
GPIB Programming	20	20	20
Specifications	23	24	24

INTRODUCTION

WAVETEK has challenged the 80's with a revolutionary new series of programmable test instruments. This new series offers a fully Programmable Function Generator, a Programmable Function/Pulse Generator, and a Programmable Synthesized Function Generator.

The **WAVETEK Model 270** is the lowest-cost fully programmable, GPIB compatible Function Generator on the market today.

Despite its low cost, the 270 offers features not found on other programmable function generators at any price. Convenience features such as 80 stored settings, stored calibration procedures and performance verification, external width, and 40-character command recall are all standard with the 270.

The 270 is equally at home in bench-top or GPIB ATE applications. With little more investment than a conventional non-programmable generator, the 270 can be the basis for an automated test system.

WAVETEK's famous free format programming (a standard feature) provides freedom in programming and eliminates problems caused by intermediate waveforms.

The **WAVETEK Model 271** is the lowest-cost fully programmable, GPIB compatible Function and Pulse Generator on the market today. In addition to all of the features of the Model 270, the Model 271 is also a true Pulse Generator. This means that pulse period and width can be set independently, not by using a symmetry control.

The 271 also offers programmable pulse delay and separate upper and lower pulse amplitudes. There is nothing in this price range that can program pulse period, pulse width, pulse delay, upper level and lower level. Counted burst to 1,048,200 cycles is standard.

The **WAVETEK Model 278** does it all, and at a remarkably low price. It is the lowest cost generator on the market today with all of the following features: sine, triangle, and square waves to 12 MHz, synthesized continuous mode with 0.0005% frequency accuracy, programmable pulse period, width, upper level, and lower level, and standard counted burst to 1,048,200 cycles.

These combined with all the aforementioned features of the 270, make a combination that's impossible to beat.

This brochure introduces you to the Model 270, 271 and 278 features and ease of operation.

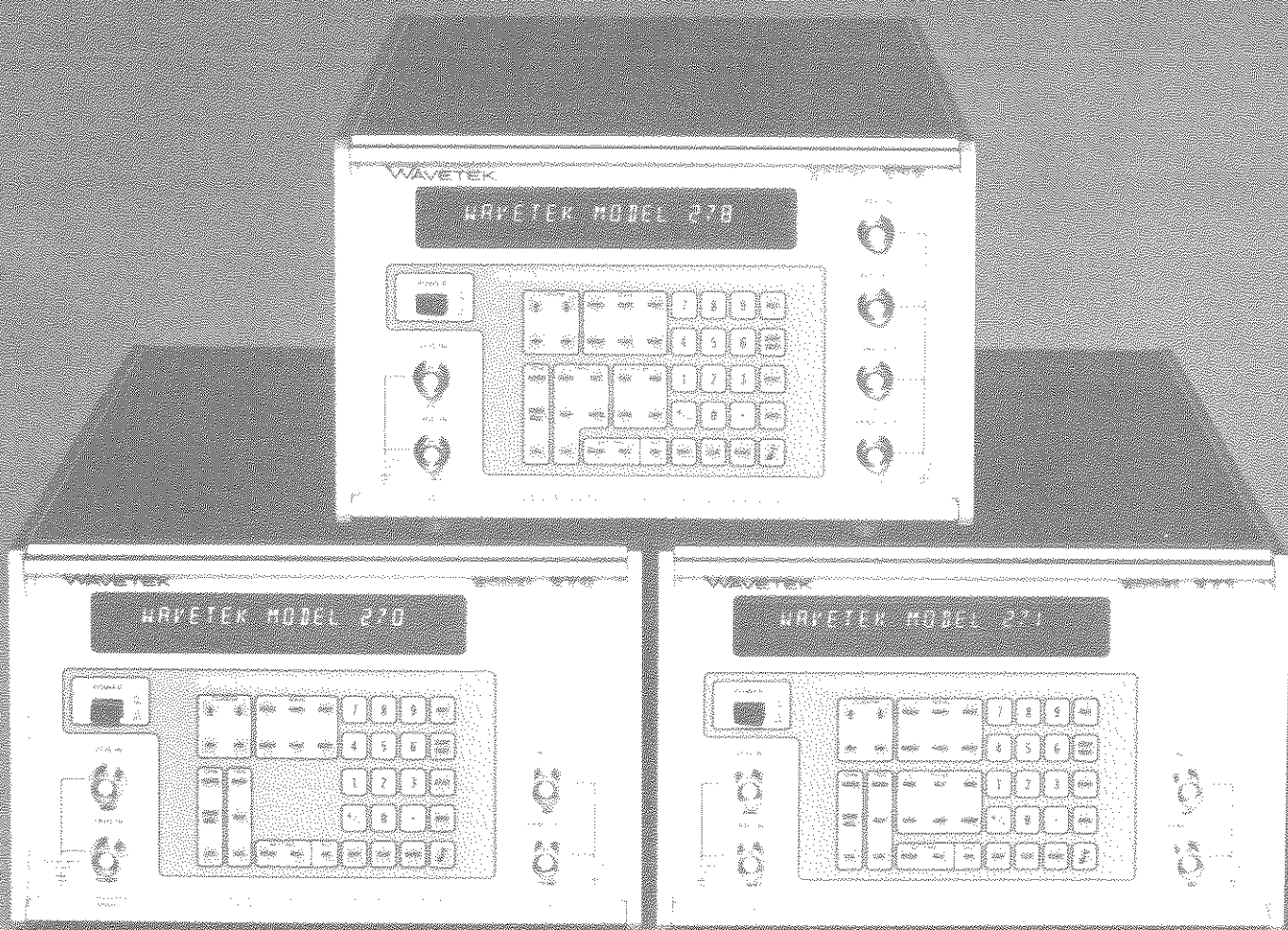

KEY FEATURES

MODEL 270

- Sine, Triangle and Square Waveforms to 12 MHz
- External Width Mode
- Continuous, Triggered and Gated Modes
- Less than 15 Nanoseconds Transition Time
- Versatile Data Entry—
 - Free Format Numerical Entry
 - Parameter Independence
- Low Price
- GPIB (IEEE-488) Remote Programming is Standard
- Descriptive Display
- Output Protection
- Stored Settings - 80 Standard, Expandable to 200
- Optional Counted Burst to 1,048,200 Cycles
- Stored Calibration Procedure and Performance Verification
- Programmable Trigger Level

MODEL 271

- All Features of Model 270
- Programmable Pulse Period and Width
- Programmable Pulse Delay
- Programmable Upper and Lower Pulse Levels
- Standard Counted Burst to 1,048,200 Cycles

MODEL 278

- All Features of Model 270
- Synthesizer
- External Synthesizer Reference Input
- External Phase Lock Mode
- Synthesizer Reference Output
- Internal Trigger Capability
- Programmable Pulse Period and Width
- Programmable Upper and Lower Pulse Level
- Standard Counted Burst to 1,048,200 Cycles

BENEFITS

MODEL 270

Sine, Triangle and Square Waveforms to 12 MHz

Precision sine, triangle and square waveforms may be generated in the frequency range of 0.01 Hz to 12 MHz with amplitudes up to 10 V_{p-p} into 50Ω.

External Width Mode

The "external width" waveform produces an output pulse during the time that a signal applied to the trigger input exceeds a programmable threshold level. As an example, external width can be used to clean up a noisy pulse train for further systems use.

Continuous, Triggered and Gated Modes

The 270 generates any of its waveforms in a continuous mode, in a triggered mode (in which only one output waveform is generated per trigger), or in a gated mode (which delivers a continuous string of waveforms for the duration of the external gate plus the time required for completion of the last cycle started).

Fast Transition Time

Fast transition times (less than 15 ns) insure accurate square wave outputs.

Versatile Data Entry

Free format numerical entries are made in operator convenient fixed point, floating point or scientific notation. The microprocessor handles all details of resolution, round off, range selection, etc.

Parameter independence allows any order of parameter entry. If a new entry conflicts with an earlier parameter, the new parameters are not "lost" or considered to be in error, but error checked after the operator has finished entering the entire new setting. All parameters are then checked for possible conflicts.

Low Price

Model 270 is the lowest cost fully programmable, GPIB compatible function generator on the market today. Despite its low cost, the 270 offers features not found on other programmable function generators at

any price. Convenience features such as 80 stored settings, stored calibration procedures, external width, and 40-character command recall are all standard with the 270.

GPIB Programming

Model 270 includes GPIB programming as standard. Implementation is consistent with IEEE 488 specifications. The interface is buffered, permitting a very fast handshake and temporary storage of command while the rest of the bus is allowed to continue with its tasks. The microprocessor handles all the programming information within milliseconds and applies it to the output circuits upon receipt of the execute command. The 270's GPIB interface is just as flexible as the front panel control. The free format acceptance of data eases the programmer's task considerably.

As an aid to the programmer, each of the 270's front panel parameter keys is identified with an ASCII character—this is the character code used by the programmer. In addition, should the programmer decide to manually setup the instrument to the desired configuration, the 270 has a learn mode which dumps all of the settings back into the computer. Another feature is the command recall which is a buffer holding the last 40 programming character entries. Although the display is only 20 characters, the cursor control allows the display to read the remainder of the 40 character codes. This feature is also useful for reading GPIB commands to the 270 or any other instrument on the bus.

Descriptive Display

The display informs the user of each condition selected on the keyboard, certain bus conditions, error conditions and other pertinent messages.

Output Protection

The main output is protected from short circuit and overvoltage up to 140 Vac and 200 Vdc. Activation of overvoltage protection circuits causes a GPIB service request and a front panel message.

Stored Settings

Model 270 provides RAM storage of up to 80 different sets of front panel settings for rapid recall. Option 001 provides nonvolatile memory and 120 additional stored settings. Standard memory as well as additional memory is battery backed for 180 days minimum retention of settings. A warning message is displayed when the long-life, non-rechargeable battery should be replaced.

Stored Calibration Procedure and Performance Verification

An internally stored calibration procedure automatically programs and executes instrument settings and displays technician prompts for 28 calibration steps. The technician presses the cursor when he is ready for the next setup and display.

An internally stored automatic test procedure may be used to quickly verify the operational performance of the 270. The procedure allows an operator to step through a sequence of tests which check all modes, functions and outputs.

Optional Counted Burst to 1,048,200 Cycles

Option 003 provides a burst mode which allows a preprogrammed number of cycles (from 1 to 1,048,200) each time the generator is triggered.

Programmable Trigger Level

External trigger threshold level is programmable over a range from -10 volts to +10 volts. This feature allows discrimination against undesirable low level signals or noise when triggering or gating.

BENEFITS MODEL 271

All the Features of Model 270

Model 271 incorporates all the features of the Model 270 except the number of stored settings. The Model 271 provides 50 stored settings with 100 additional stored settings optional.

Programmable Pulse Period and Width

Pulse period and width are programmed directly which allows the operator to keep pulse parameters in the usual format. Period is programmable from 83.3 ns to 100 sec. with 3 digits of resolution. Pulse width is programmable from 40 ns to 0.1 sec.

Programmable Pulse Delay

Pulse delay is programmed from 80 ns to 0.1 sec. and measured from leading edge of the sync output.

Programmable Upper and Lower Pulse

Upper and lower programmable pulse level allows the operator to directly program positive and negative peaks of the pulse. This makes it easy to set logic levels such as ECL and TTL.

Counted Burst to 1,048,200 Cycles

Burst mode allows a pre-programmed number of cycles (from 1 to 1,048,200) each time the generator is triggered.

BENEFITS

MODEL 278

All the Features of Model 270

Model 278 has all the features of the Model 270 except the number of stored settings. Model 278 provides 40 stored settings with 60 additional stored settings optional.

Synthesizer

Synthesizer mode provides 5 digit frequency resolution with 0.0005% accuracy.

External Synthesizer Reference Input

An external 10 MHz signal at the REF IN BNC allows the operator to lock the 278 to an external house frequency standard for increased accuracy and stability. Frequency resolution is 5 digits. Frequency accuracy is dependent upon the reference signal. Reference signals can be either TTL level or zero-crossing. The front panel displays LOOP NOT LOCKED should the incoming signal be unacceptable.

External Phase Lock Input

An external phase lock signal allows the operator to phase lock the 278 to an external source. Phase lock signal frequency range is from 10 Hz to 12 MHz. Frequency resolution is 5 digits. Frequency accuracy is dependent upon the accuracy of the phase lock source. The signal can be either TTL level or zero-crossing. The front panel displays LOOP NOT LOCKED should the incoming signal be unacceptable.

Synthesizer Reference Output

The synthesizer reference output allows the operator to use an auxiliary 10 MHz TTL level, 0.0005% accurate signal as a frequency standard.

Internal Trigger Capability

In nonsynthesized modes, an internal trigger source can trigger the 278. The internal trigger rate is programmable from 1 Hz to 24 MHz with 5 digits of resolution.

Programmable Pulse Period and Width

Pulse period and width can be programmed directly which allows the operator to keep pulse parameters in the usual format. Period is programmable from 90 ns to 1 sec with 3 digits of resolution. Pulse width is programmable from 45 ns to 500 ms with 2 digits of resolution.

Programmable Upper and Lower Pulse Level

Upper and lower programmable pulse level allows the operator to directly program positive and negative peaks of the pulse. This makes it easy to set logic levels such as ECL and TTL.

Counted Burst to 1,048,200 Cycles

Burst mode allows a pre-programmed number of cycles (from 1 to 1,048,200) each time the generator is triggered.

OPERATION DEMONSTRATION

SETUP

These steps display the flexibility and versatility of the Models 270, 271 and 278 and allow you to easily step through every front panel control, no feature overlooked, and to find how easy these models are to operate. Take notice of the cursor controls, ASCII codes on the keys, and free format programming capability while proceeding through the steps. Use the oscilloscope as you desire to verify operations as the 270, 271 and 278 control capabilities are demonstrated.

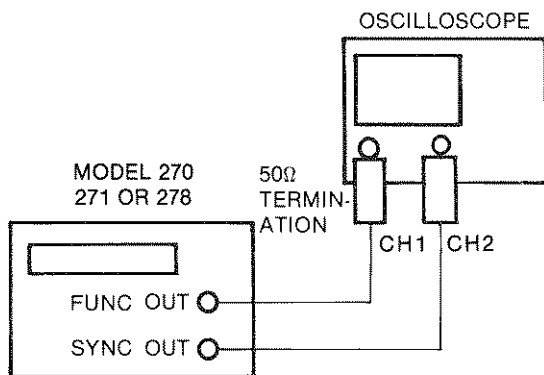

1. POWER-UP

When ac power is applied to the instrument, it wakes up in a specific mode. During the first 1 or 2 seconds, the power supply stabilizes and the microprocessor does internal checks. Immediately following power-on, the display shows all segments, decimal points, and commas for 1 second , then:

"WAVETEK MODEL 270"
(or 271 or 278)



NOTE

Allow 3 seconds between power-off and power-on.

2. DISPLAY TEST

When pressed, the  (Display Test) key lights all 20 sets of character segments and semicolons.

3. TONE KEY

An audible tone indicates that a key is pressed. Pressing  will inhibit or enable the key tone. If there is no tone when keys are pressed, pressing  restores the tone.

4. STATUS

By pressing , (Status) key, the display will sequentially indicate the following start-up parameters.

MODEL 270 ONLY

FREQ	1 KHZ
AMPLITUDE	5V
OFFSET	0V
MODE CONTINUOUS	(0)
FUNC SINE	(0)
NO BURST OPTION or BURST COUNT	2
TRIG SLOPE POS	(0)
TRIG LEVEL	1.5V

MODEL 271 ONLY

FREQ	1 KHz
AMPLITUDE	5V
OFFSET	0V
MODE CONTINUOUS	(0)
FUNC SINE	(0)
BURST COUNT	2
PERIOD	1 mS
DELAY	120 nS
WIDTH	40 nS
UPPER LEVEL	2.5V
LOWER LEVEL	-2.5V
PULSE NORMAL	(0)
OUTPUT OFF	(0)
TRIG SLOPE POS	(0)
TRIG LEVEL	1.5V



MODEL 278 ONLY

FREQ	1 KHZ
AMPLITUDE	5V
OFFSET	0V
MODE CONTINUOUS	(0)
FUNC SINE	(0)

BURST COUNT	2
PERIOD	1 mS
WIDTH	45 nS
UPPER LEVEL	2.5V
LOWER LEVEL	-2.5V
OUTPUT OFF	(0)
EXTERNAL TRIGGER	(0)
TRIG RATE	200 HZ
TRIG SLOPE POS	(0)
TRIG LEVEL	1.5V

By pressing  , the display will stop on the existing readout.



NOTE

CURSOR  and  keys will increment the status display forward and backward respectively. Holding a *CURSOR* key down will continuously increment the display.

5. OUTPUT



Notice the power-up output status:





In order to observe the output on the oscilloscope press    = Output On. The output codes are:





CODE	OUTPUT MODE
0	Output off
1	Output on
2	Output off, FUNC OUT impedance 50Ω

6. FREQUENCY AND CURSOR CONTROLS

To enter frequency, press the  (frequency) key followed by a numerical entry and the  (Execute) key. The instrument will accept frequency inputs of 10 mHz to 12 MHz. There are no range settings to be concerned with when entering data, and the instrument will take a free format entry of numbers: Numbers may be entered in scientific (exponential) notation, fixed (implied decimal at the end), floating (explicit decimal point in any position) with leading or trailing zeroes and + or - signs.





Example: Press  and then cursor  up then  down. These key strokes cause the instrument frequency to be displayed (to 3 digits) and executed (control information routed to the waveform circuitry.)



Notice that a blinking number indicates a digit which may be incremented by pressing the  or  keys. Pressing  or  will move the cursor left or right to control another digit.

NOTE

The illustration on the next page will help you understand the control of this instrument, remember:

1. All "Alpha" keys (except ) properly terminate entries and cause them to be placed in scratch pad memory.
2.  GPIB "I", and GPIB Group - Execute - Trigger transfers (executes) data to the waveform circuit memory. In cases where entries have been Alpha terminated, the cursor   will change the execute the last selected parameter.
3. A leading asterisk on a display indicates non-executed scratch pad data.
4. Reset does not affect stored settings.

7. EXECUTE KEY

The  (Execute) key transfers all data from the scratch pad memory to the waveform circuit memory. (A leading asterisk (*) on the display, indicates that the parameter value has not been executed.)

Example: Press     . A dash at the end of the string of characters means that the

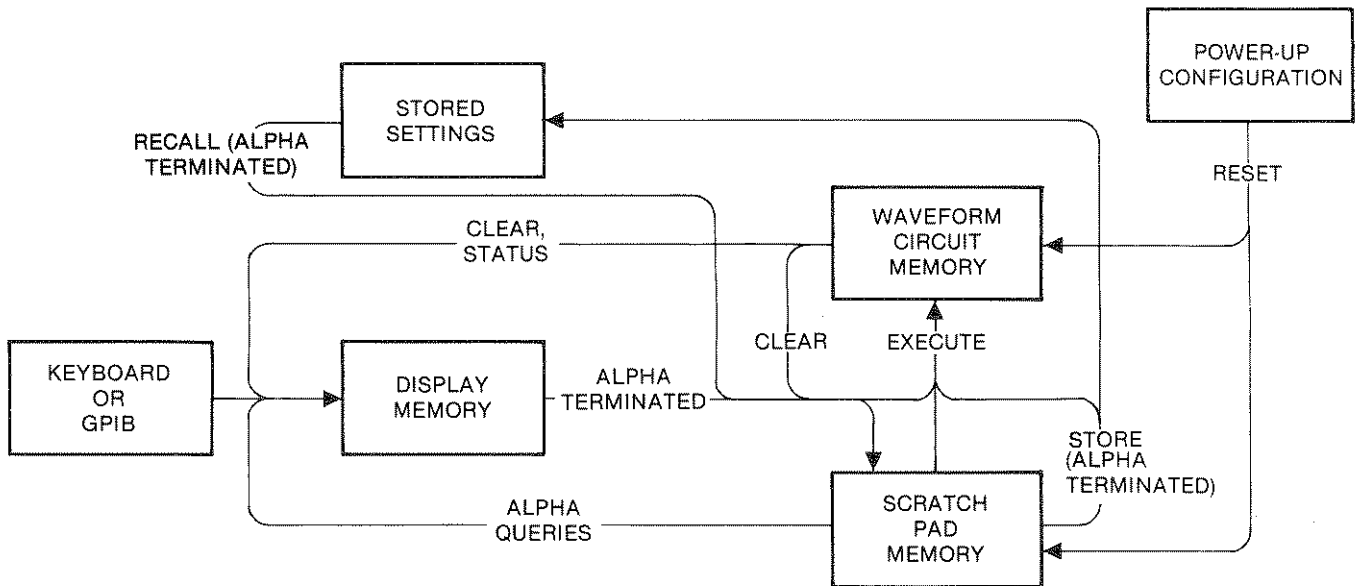

MEMORY STRUCTURE

string of characters has not been terminated (nor executed).



Press and return to the key. The display will be:



which indicates that it has been properly alpha terminated but not executed.

8. CLEAR ENTRY

The (Clear) key erases a parameter value which has been entered but not executed. The removes the numeric digits entered after the last parameter letter entry. (Clearable entries are always prefixed by an asterisk or suffixed by a dash.) The display reverts to that caused by the previous accepted value of the parameter being programmed.

9. EXPONENTIAL ENTRY

The numeric characters (0 through 9, E, —, •) may be used to program new parameter values. To change a

parameter value, first program the alphabetic character which selects the desired parameter (F = Frequency, etc.) Next, program the new value using numeric characters. Any sequence of characters which gives the new value is acceptable.

Example: =

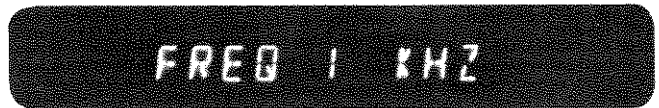

10. AMPLITUDE CONTROL

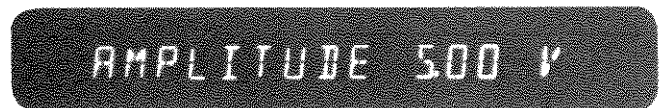

To enter amplitude, press the (Amplitude) key followed by a numerical entry and . The instrument will accept voltage programming from 10 mV to 10.0 Vp-p and up to 3 digits. (The instrument assumes that its output is fed into a 50Ω load.) As with frequency, amplitude programming is free format.

Example: Press and then cursor up then down. These key strokes cause the instruments amplitude to be displayed (to 3 digits).





11. OFFSET CONTROL

To enter offset, press the  (Offset) key followed by a numerical entry in the same manner as with amplitude. The offset range is from 0 to $\pm 5V$ (into a 50Ω load) with 3 digit resolution.





Example: Press  and then cursor  up then  down. These key strokes cause the waveform offset (or DC output in DC function) to be displayed.



12. FUNCTION CONTROL

To change function, press the  (Function) key followed by a numerical value and .

CODE	FUNCTIONS
0	Sine
1	Triangle
2	Square
3	Square Complement
4	DC
5	External Width
6	Single Pulse (271, 278 only)
7	Delay Pulse (271 only)
7	Pulse Complement (278 only)
8	Double Pulse (271 only)

Example: Press  key and then . As the cursor key is pressed the instrument will automatically step through each of the functions (note that the display indicates the waveform by name). Press  and  and the waveform will return to a sine wave and the display will read:



13. MODE CONTROL

To change modes press  followed by a numerical value and execute. Example:

Press    = Continuous

The mode codes are:

CODES	MODE
0	Continuous
1	Triggered. Main generator is triggered by external signal at TRIG IN BNC, MAN key or GPIB command. When triggered, one cycle of waveform is generated.
2	Gated. At the onset of the trigger, regardless of its source (ref: code 1), enables the main generator for the duration of the trigger signal plus the time required for the completion of the last waveform cycle started.
3	Burst (optional for 270). At the onset of the trigger (ref: code 1), initiates a counted burst of the waveforms (ref: 16 Burst Control).

NOTE

Modes 4 through 8 are Model 278 only.

4	Synthesized. Same as continuous mode except for increased frequency resolution (5 digits) and accuracy (5 ppm).
5	TTL Reference. Same as synthesized except locked to an external TTL 10 MHz reference signal.
6	Zero Reference. Same as synthesized except locked to an external 1 Vp-p (min.) 10 MHz zero crossing reference signal.
7	TTL Lock. As continuous except phase locked to a TTL signal.
8	Zero Lock. As continuous except phase locked to a 1 Vp-p (min.) zero crossing signal.

14. TRIGGER CONTROLS

The  (Manual Trigger) key triggers the triggered, gated or (optional) burst mode waveforms.

The  (Slope) key allows external triggering either on the positive slope or negative slope of a signal applied to the TRIG IN BNC.

CODE	SLOPE MODE
0	Positive
1	Negative

Trigger level is the voltage sensitivity threshold of the trigger circuit to the external trigger signal at the TRIG IN BNC. If the circuit is set for positive slope trigger signals, the rising edge of the trigger signal at the TRIG IN BNC must pass through the trigger level to activate the generator. If set for negative slope trigger signals, the falling edge must pass through the trigger level. Trigger level is programmable between +10 and -10 volts in 20 mV increments.

To set a trigger level, press the **LVL XL** (Level) key followed by a value and execute.

Example: **LVL XL** **2** **.** **5** **EXEC I** = 2.5V Trigger Level.

15. INTERNAL TRIGGER (278 ONLY)

The **EXT G** key followed by a code allows selection of either an external or internal trigger source.

CODE	TRIG SOURCE
0	External Trigger
1	Internal Trigger

If internal trigger is selected, the **RATE T** key followed by its numeric value (1 Hz to 20 MHz with 5 digits of resolution) selects the internal trigger rate. Note that in internal trigger the trigger slope and level are not applicable.

To demonstrate internal triggering on the scope, use REF OUT BNC as the scope sync.

Example: Press **MODE B** **1** **FREQ F** **5** **EXP** **3**
EXT G **1** **RATE T** **1** **EXP** **3** **EXEC I**



16. BURST CONTROL

For instruments with burst, the instrument can provide a counted burst of waveforms. The number of cycles of waveform is selected by pressing **BRST R** followed by a value from 1 through 1,048,200. Upon triggering, the burst occurs; its duration is dependent upon the frequency of the waveform as well as the burst count.

Example: **MODE B** **3** **BRST R** **1** **EXP** **3** **EXEC I** gives



Press **MAN J H** to trigger the burst output.

17. STORAGE AND RECALL

Front panel settings can be stored in and recalled from memory. Memory is volatile (will be lost when power is OFF) unless option 001 is installed. Option 001 includes battery back-up for nonvolatile memory and additional stored settings. By selecting more than the established stored settings the display will read:



The number of stored settings is:

Model	Standard	Optional	Total
270	80	120	200
271	50	100	150
278	40	60	100

Look at the Memory Structure illustration again. As shown, it is the settings in scratch pad memory that are stored. To store your selected program, parameter values are programmed into scratch pad memory, and **STOR M** **1** **STOR M** (or any non-EXEC key) keyed. Those parameter values have now been stored in location number 1. By terminating with an **EXEC I** the function output will be updated.

To recall those parameters, **RCL** **1** **RCL** are keyed. By pressing individual parameter keys, such as **FUNC C**, the parameter values recalled may be displayed.

Example: Press **FUNC C** **2** **FUNC C** **FUNC C** was pressed to act as a terminator, which places Function 2 (square wave) in scratch pad memory. Now press **STOR M** **2** **7** **STOR M** Everything in scratch pad memory is now stored in location 27 as well.

Parameter values that are stored will not be altered by keying in new parameter values for scratch-pad and waveform circuits. A parameter stored in a specific stored setting may be recalled, changed and restored when desired.

NOTE

The use of the negative sign with the location number deletes the stored settings.

Example: Press :

NO. 27 LAST DELETED

This action deletes the settings in location 27. To verify that the information in stored setting 27 has been deleted:

Press :

CANNOT RECALL

18. RESET

The (Reset) key returns the instrument waveform parameters to their power-on condition. The instrument becomes reset. (Storage is not affected by .)

Example: Press then . Compare the parameter values with those of the power-on values listed in step 3. They are the same.

19. GPIB ADDRESS

When pressed, the (Address) key indicates the instrument's GPIB address. The GPIB address can be changed by pressing the key and entering the desired decimal number address (0 - 30) and terminating.

Example: Press gives:

GPIB ADRS 20

The address can also be changed by a group of five internal switches accessible by removing the bottom cover. The power-on address is always that of these internal switches. Another internal switch enables and disables the keyboard selection of the GPIB address. When disabled, the display shows:

ADRS ENTRY DISABLED

NOTE

Please review GPIB Programming (page 20) to enable/disable keyboard selection.

20. COMMAND RECALL

Pressing the (Command Recall) key causes up to 20 programmed characters to be displayed. Using the cursor and shifts the display 4 character positions to allow the eventual display of up to 40 characters.

Example: Press three times, then press

and enter

Now press and the right most 16 characters on the display reads

IIIF10 .5E3A2 .5C2

Where I, F, E, A and C are ASCII codes for Execute, Frequency, Exponent, Amplitude and Function respectively.

Now press and note that .5C2 have shifted off the display. Press and shift them back on. Press five times to observe all 40 programmed characters.

21. LOCAL KEY

The (Local) key removes the instrument from the bus command and places it under front panel control. This key can be locked out from the GPIB controller with a "LLO" if so desired.

22. SRQ KEY

The (Service Request) key asserts the SRQ line of the GPIB and unmask the rsv bit of the service response byte. SRQ key bit of the service response byte must have been previously unmasked by the GPIB SRQ mode **XQ**.

23. PULSE PERIOD CONTROL (271, 278 only)

For convenience, the repetition rate may be entered in FREQUENCY or PERIOD ($P = 1/F$). The internal microprocessor makes the conversion. There are no range settings to be concerned with and the instrument accepts a free-formatted entry of numbers. To enter the period, press **PER** (period) key followed by a value and **EXEC**

Period range is: 83:3 ns to 100 sec. (271 only)
90 ns to 1 sec. (278 only)

Example: Press **PER** **2** **5** **EXP** **+/-** **3** **EXEC** =

PERIOD 25 mS
(FREQ 40 Hz)

24. PULSE DELAY CONTROL (Model 271 only)

When the function selected is the delayed pulse, the time between the sync out and the main output is settable from 80 ns to 0.1 seconds with 3 digits resolution. To set the delay, press **DLY** followed by a numerical entry and **EXEC**

Example:

Press **FUNC** **7** **DLY** **1** **EXP** **+/-** **3** **EXEC** =

DELAY 1 mS

25. PULSE WIDTH CONTROL (271, 278 only)

The pulse width is measured at the 50% transition points of the pulse with 3 digit resolution. The width is independent of amplitude and the other pulse parameters. To enter a value for width press **WID**, followed by a numerical entry.

Range is: 271 40 ns to 0.1 sec.
278 45 ns to 500 ms.

Example: Press **WID** **1** **EXP** **+/-** **3** **EXEC** =

WIDTH 1 mS

26. UPPER/LOWER LEVEL (Models 271, 278 only)

To enter a value for the amplitude level, press Upper or Lower, followed by a numerical value, (not to exceed $\pm 5V$) and execute.

NOTE

When entering amplitude level, the upper level must be more positive than lower.

Example: **UPR** **2** **.** **5** **EXEC** =

UPPER LEVEL 2.5 V

Press **LWR** **+/-** **2** **.** **5** **EXEC** =

LOWER LEVEL -2.5 V

NOTE

Pulse amplitude may also be entered in peak-to-peak format by using the AMP and offset keys.

27. COMPLEMENT (271 only)

To enter complement, press **COMP** (complement) key followed by **1** then **EXEC**. The Model 271 display will read:

PULSE COMP (1)

The pulse on your oscilloscope will show an inverted waveform. When a normal pulse is desired: Press

COMP **0** **EXEC**. Your display will now read:

PULSE NORMAL (0)

28. CALIBRATION PROCEDURE

The calibration procedure is called up by pressing

RCL **1** **0** **0** **0** **EXEC**. The front panel display

will read:



Each press of [↑] steps to the next calibration prompt. Press [↑] and observe the display:



This display tells the technician to adjust the +15V power supply with potentiometer R39. By pressing [↑], all calibration prompts can be displayed and required internal control setups will be made automatically. Test points and test equipment setup are included in the instruction manual.

29. STORED PERFORMANCE VERIFICATION

An internally stored program exercises the instrument circuits to enable a quick verification of operation.

An oscilloscope must be used to observe this procedure. Connect as shown and setup the scope as follows:

1. Trigger on sync output (CH2).
2. 0.2 ms, Time/Div.
3. 2V/Div, CH1 and CH2.

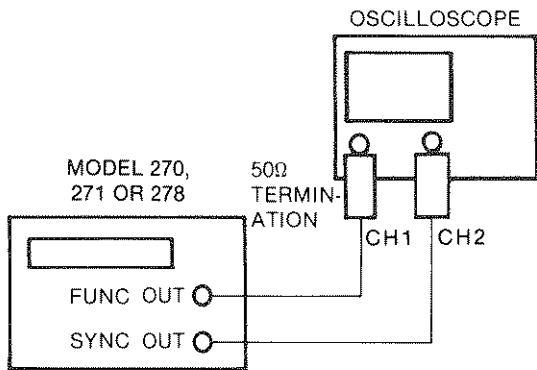

Press [RCL] [2] [0] [0] [0] [EXEC] to start the Quality Assurance Procedure.



The oscilloscope displays a main output sine wave and a sync output square wave.

Press [↑] to select these steps:

1. A rapid stepping of frequencies.
2. A rapid stepping of amplitude.
3. A square wave that steps from a negative to positive offset and repeats.
4. A delay circuit test (Model 271 only).
5. A width circuit test (Model 271 only).

NOTE

At this point trigger on function out (CH1).

6. A trigger circuit test. (Note: Model 278 REF OUT to CH2; Sync on REF OUT).
7. A gate circuit test.
8. A burst circuit test. (Not applicable to Model 270 unless burst option is installed.)

30. SYNTHESIZED (278 only)

Pressing [MODE] [4] [EXEC] places the 278 in the synthesized mode.



Press [FREQ] cursor [←] until the display shows



Then press [↑] to increase the frequency in 0.1 Hz increments. The display could show



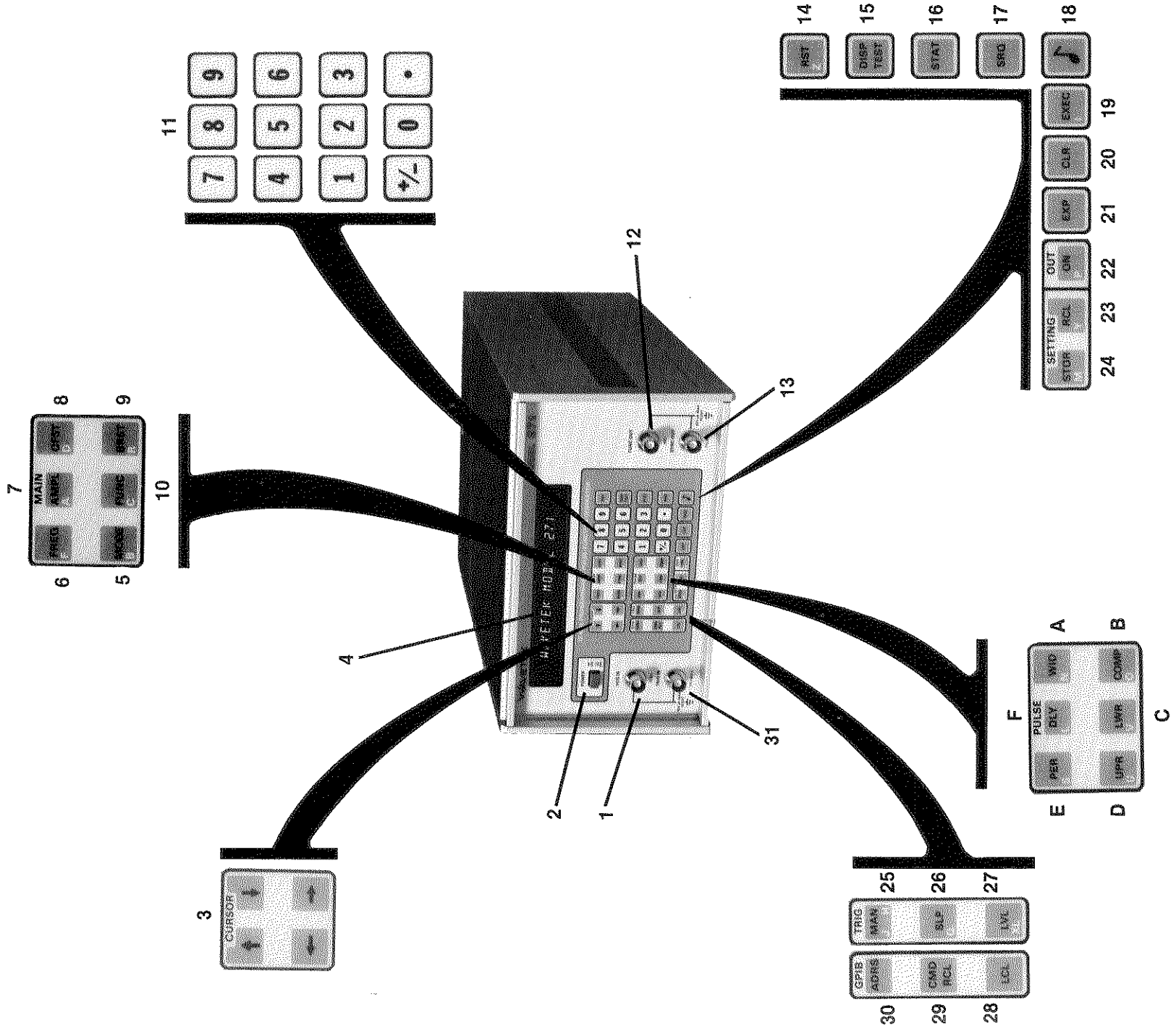

MODEL 271 CONTROLS AND CONNECTORS

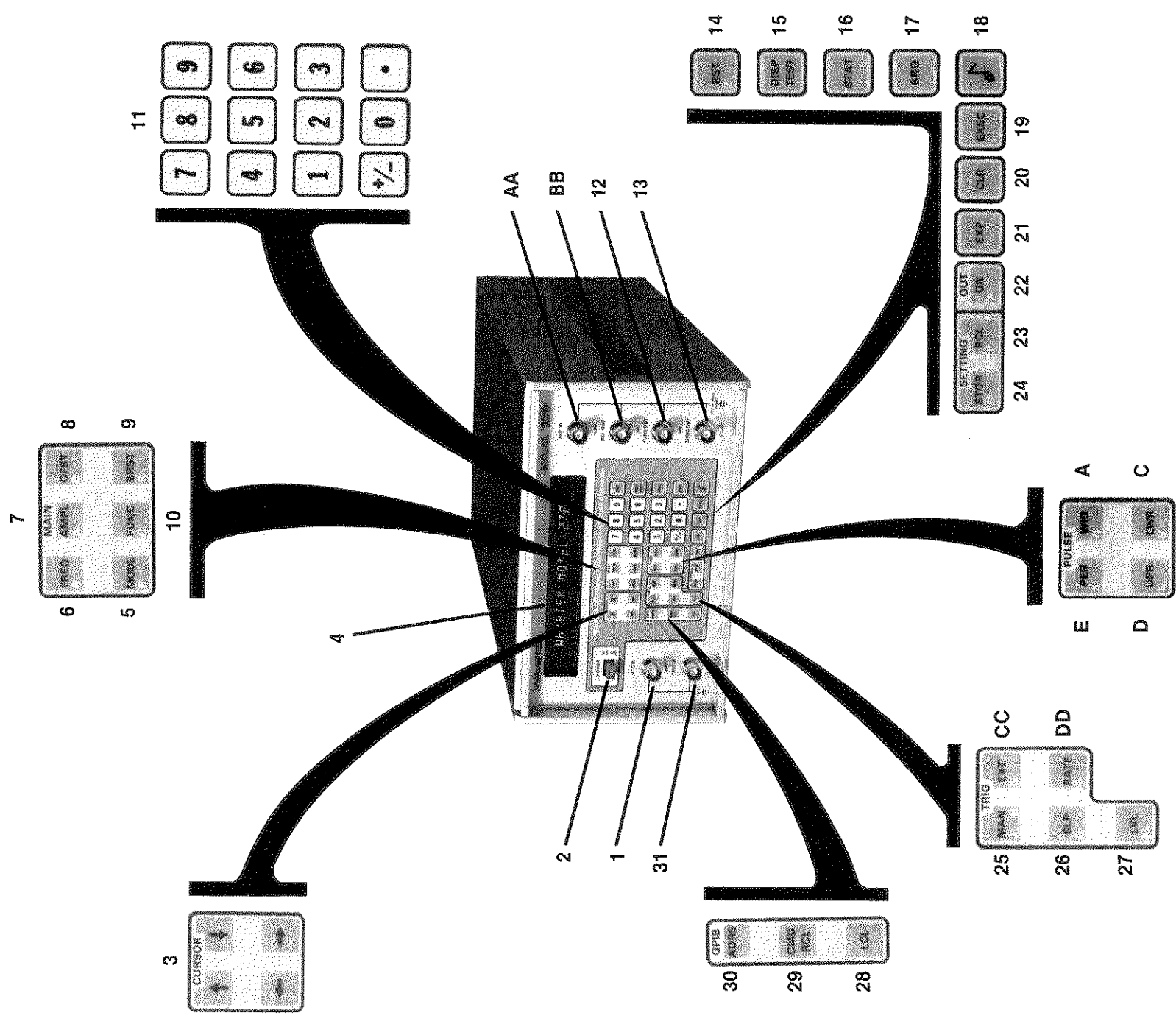

MODEL 278 CONTROLS AND CONNECTORS

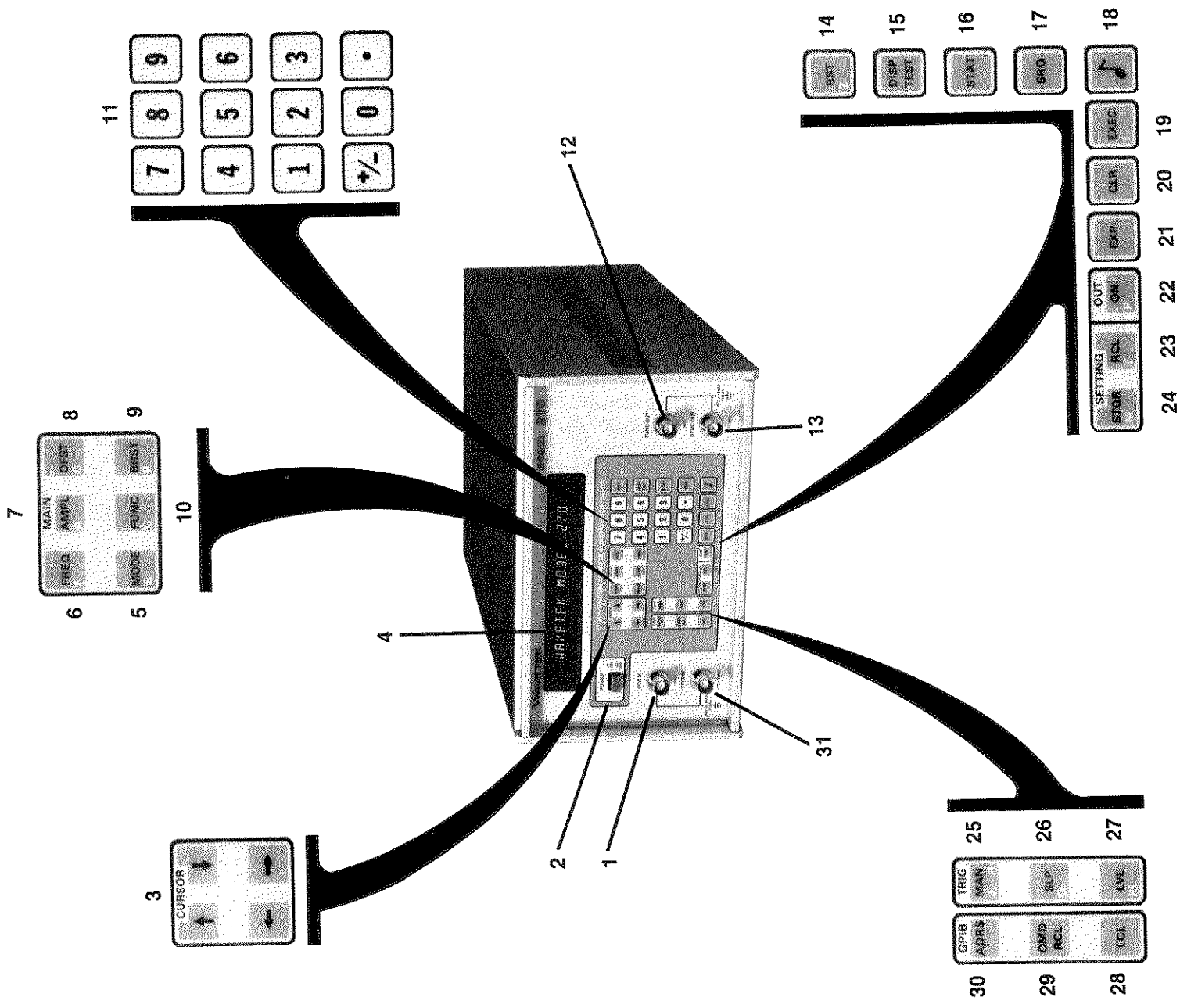

MODEL 270 CONTROLS AND CONNECTORS

CONTROLS AND CONNECTORS

For quick reference, individual control and connector explanations are keyed to the preceding 270, 271 and 278 front panel photos.

1. **VCG IN** - The VCG input accepts ac or dc voltages used to externally control the frequency of the function out signal. A positive voltage applied to the VCG IN connector will increase the generator frequency, and a negative voltage will decrease the frequency. 0.01 to 12V gives 1200:1 frequency change. Input impedance is 10 k Ω .
2. **POWER ON/OFF** - Turns generator on and off.
3. **CURSOR** - ←, → positions the cursor to any numerical digit (indicated by the flashing digit on the display). ↑, ↓ increments or decrements codes, storage addresses or the flashing digit (features carry action) of a parameter value. ←, → also used to move a displayed program string (CMD RCL) to the left or right in increments of 4 characters. Because ↑, ↓ employs an automatic execute, the instrument output is instantly changed with cursor action.
4. **DISPLAY** - Twenty character readout (both manually and remotely accessible). Advises operator of parameters and values, errors, warnings and GPIB activity. Also displays programming strings.
5. **MODE (B)** - Displays main generator operating mode and enables change. There are nine basic modes.

MODE	CODE
Continuous	0
Trigger	1
Gate	2
Burst (Optional on 270)	3
Synthesizer (278 only)	4
TTL Reference (278 only)	5
Zero Reference (278 only)	6
TTL Lock (278 only)	7
Zero Lock (278 only)	8



6. **FREQ (F)** - Displays main generator frequency of programming and enables change. Frequency range is 10 mHz to 12 MHz with 3 digit

resolution. (5 digits with 278 in synthesized mode.)

7. **AMPL (A)** - Displays output amplitude programming and enables change. Amplitude maximum is 10.00 Vp-p into 50 Ω .
8. **OFST (D)** - Displays dc offset programming and enables change. DC offset used with amplitude adjusts the output waveform offset bias. Maximum offset is $\pm 5V$ into 50 Ω .
9. **BRST (R)** - Displays burst count and enables change. Burst count can be from 1 to 1,048,200. This is the number of waveform cycles in the burst each time it is triggered. (Burst is an option for 270.)
10. **FUNC (C)** - Displays function (waveform) programming and enables change. Function may be one of eight basic output waveforms.

FUNCTION	CODE
Sine	0
Triangle	1
Square	2
Square Complement	3
DC	4
External Width	5
Single Pulse (271, 278 only)	6
Delay Pulse (271 only)	7
Pulse Complement (278 only)	7
Double Pulse (271 only)	8

11. **NUMERICAL KEYBOARD** - Used with other keys to enter data or retrieve information. Free format data entry allows fixed point, floating point and scientific (exponential) notation. Microprocessor will round off as required.
12. **FUNC OUT** - Function output is off at power-up and reset. Output control **22** set FUNC OUT at on or off with 50 Ω impedance.
13. **SYNC OUT** - The sync signal is 0V to approximately 3V (TTL level) from a 50 Ω source.

- 14. **RST (Z)** - Returns the instrument waveform parameters to their power-on condition. Stored settings are not affected.
- 15. **DISP TEST** - Lights all 20 sets of character segments and semicolons.
- 16. **STAT** - Gives the current waveform generator status by displaying each parameter and value momentarily. Pressing the key a second time holds the display.
- 17. **SRQ** - To use the SRQ key, the instrument must be in the local mode and the SRQ mode bit 128 must be selected. Under these conditions pressing the SRQ key asserts the SRQ line of the GPIB.
- 18.  - Prevents or restores audible key tone. If there is no tone when keys are pressed, pressing  restores the tone.
- 19. **EXEC (I)** - Causes all the entered instructions to be error checked and transferred to waveform circuits. No parameter entries will change the output until execute (EXEC key, CURSOR ↑, ↓, GPIB I, GPIB GET, GPIB Z or RESET) is received. This permits a complete test setup to occur at one time with no in-between parameter change aberrations.
- 20. **CLR** - Corrects front panel and scratch-pad numerical entries. (An asterisk on the display indicates that the value displayed has not been executed and resides in scratch-pad memory only.)
- 21. **EXP** - Designates the next numerical and +/– entries pertaining to the power of the ×10 multiplier.
- 22. **OUT/ON (P)** - Displays output on, and load status and enables change. Output status programming codes are:

CODE	OUTPUT
0	Output Off (0)
1	Output On (1)
2	Output Off, Lo Z (2)

- 23. **RCL (Y)** - Displays the status of setting recall (none recalled, recall setting No. _____, or No. _____ last recalled) and enables the change of

address of settings to be recalled. Stored settings can be recalled to scratch-pad memory only and do not affect the instrument output operation if recall is alpha terminated but not executed.

- 24. **STOR (M)** - Displays address of last storage location used and enables storage location address change. The settings stored are those currently in scratch-pad memory; the instrument output operation is not disturbed by storage action. A minus (–) address entry erases the stored settings at that address from memory. The number of stored settings is:

Model	Standard	Optional	Total
270	80	120	200
271	50	100	150
278	40	60	100

- 25. **MAN TRIG (J)(H)** - Triggers output when in any of the modes requiring trigger. The two ASCII codes (J and H) are for gating; J gates on and H gates off.

- 26. **SLP (Q)** - Enables external triggering on the rising or falling edge of the external signal.

CODE	TRIGGER
0	Positive Slope
1	Negative Slope

- 27. **LVL (XL)** - Displays programmed trigger level and enables change. Trigger level is the voltage at which the trigger circuit is sensitive to the TRIG IN BNC input signals. Trigger level may be set in the ±10 Vdc range with 20 mV resolution.

- 28. **LCL** - Takes the instrument out of remote control without affecting the rest of the bus with the following exception. A GPIB LLO command will override the key logic and inhibit its operation.

- 29. **CMD RCL** - Displays the last 40 parameters, values and actions (all in ASCII Code) sent to the instrument from the keyboard and the GPIB. The display shows only 20 characters at a time, and the CURSOR ← and → must be used to see the entire 40 character program string.

- 30. **ADRS** - Displays the GPIB decimal address and enables change, with the following exception. The GPIB address cannot be changed by front panel control if the internal disable switch has been set.

31. TRIG IN - A sufficient external signal level transition triggers or gates the generator when in mode requiring a trigger or gate signal. The required level is determined by **27** and the required transition by **26**.

A WID (N) (271, 278 only) - Displays the pulse width programmed and enables a change. Pulse width range is 40 ns to 0.1 sec with 3 digits of resolution (271), and 45 ns to 500 ms with 2 digits of resolution (278). Pulse width is measured at 50% amplitude points.

B COMP (0) (271 only) - Displays the programmed state of the pulse output and enables a change. Pulse output state codes are:

CODE	OUTPUT
0	Normal
1	Complement

C LWR (V) (271, 278 only) - Displays the programmed lower pulse level and enables a change. Lower level range is -5V to +4.99V with 3 digits of resolution. Lower level must be more negative than upper level.

D UPR (U) (271, 278 only) - Displays the programmed upper pulse level and enables a change. Upper level range is +5V to -4.99V with 3 digits of resolution. Upper level must be more positive than lower level.

E PER (S) (271, 278 only) - Displays the pulse period (period = 1/frequency) programmed and enables a change. Period range is 83.3 ns to 100 sec with 3 digits of resolution (271), and 90 ns to 1 sec with 3 digits of resolution (278).

F DLY (L) (271 only) - Displays the pulse delay programmed and enables a change. Pulse delay range is 80 ns to 0.1 sec with 3 digits of resolution. Pulse delay is relative to the SYNC OUT.

AA REF IN (278 only) - The reference input accepts a reference clock from an external instrument (ref: MODE 5, 6, 7 and 8).

BB REF OUT (278 only) - The reference output is a 10 MHz TTL level pulse in external reference and synthesized modes. When internal trigger is selected, the REF OUT will be a TTL level signal at the same frequency as RATE.

CC EXT TRIG (G) (278 only) - Displays the trigger source and enables change. There are two trigger sources.

CODE	SOURCE
0	External
1	Internal

DD RATE (T) (278 only) - Displays the internal trigger rate and enables change. RATE range is 1 Hz to 24 MHz with 5 digits of resolution.

GPIB PROGRAMMING

The 270 is programmed remotely by means of the General Purpose Interface Bus (GPIB). This is the same asynchronous data bus described in the IEEE Standard 488-1978. The 1978 implementation of the GPIB is consistent with IEEE recommended practice for code and format convention and is fully compatible with your controller's GPIB system.

Should more information on the GPIB be desired, ask for a copy of Wavetek's *Introduction to the GPIB*. This guide is more detailed as to the bus transactions and Wavetek's implementation of the bus.

GPIB CONNECTION

The GPIB I/O rear panel connection consists of an Amphenol 57-10240 (or equivalent) connector in accordance with the IEEE standard and allows any GPIB cable to be connected at this point.

GPIB ADDRESS

The 270's bus address is selected with an internal microswitch as shown or by the front panel keys. The microswitch, accessible by removing the bottom cover, actually consists of eight separate switches, S1 through S8. The first five switches, S1 through S5, each set a digit of a binary number and permits a

range of address selections from 0 to 30. Note that switch S5 is the most significant digit (bit 5) and switch S1 the least significant bit (bit 1). To verify this switch selected GPIB address, press the front panel ADRS Key first thing after turning instrument power on. The front panel display indicates the decimal number.

In addition, the GPIB address can be selected from the front panel, if S6 (keyboard address selection enable) is on and the instrument is in local mode.

Press and a decimal value between 0 and 30 followed by an alpha for a new address. If S6 is off, an attempt to enter a GPIB address from the front panel will cause the display to read "ADRS ENTRY DISABLED". At power-up, the 270's address always reverts to the internal switch address.

Note that switches S7 and S8 have no effect on the GPIB address.

The talk and listen addresses are sent via the controller using bits 6 and 7, respectively, plus the 5 address bits. Most controllers are formatted to accept the decimal device number as the GPIB address. Check your controller programming manual to see whether your controller requires a decimal address, ASCII character or some variation of these.

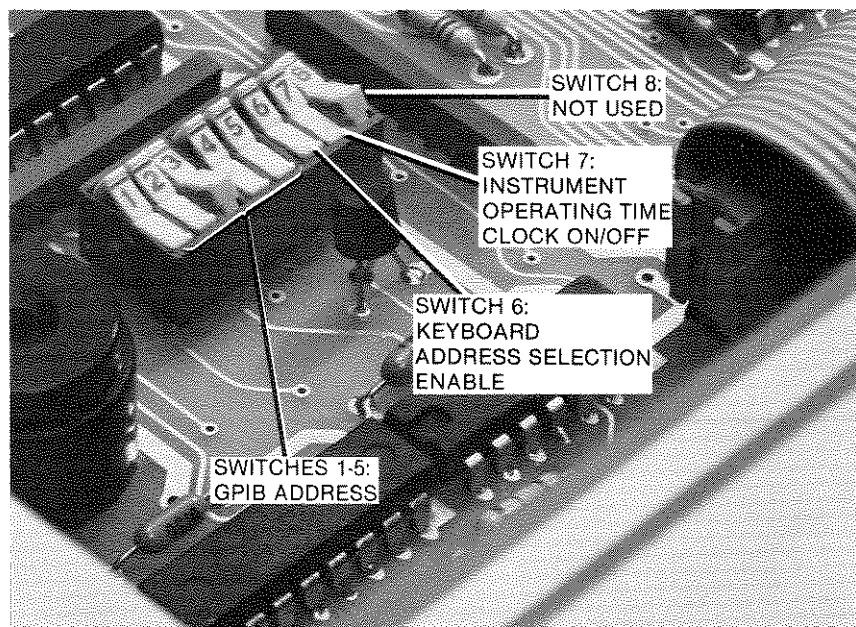

TYPICAL LISTEN AND TALK FORMATS

The following statements are intended only as programming examples. Before programming, check the operating instructions for your controller.

Program for the HP 9825 (HPL Language)

Listen

```
wrt 702,"F10E3A2C2I"
```

The 7 selects the HP 9825's GPIB interface port. The 02 is the instrument's decimal address. The programming string is within the quotes.

Talk

```
red 702,B$
```

The instrument talks via the GPIB and returns data to the B\$ string within the controller.

Program for the HP 9830 (BASIC Language)

Listen

```
CMD "?U!","F10E3A2C2I"
```

The ? tells all instruments to unlisten. U is the HP 9830's GPIB interface port. ! is the ASCII equivalent listen address of decimal 1.

or

```
CMD "?U!"  
OUTPUT (13,*)"A",A,"I"
```

The 13 is the GPIB interface port. The * is a format assignment for data. The "A" and "I" are ASCII string data. The A (no quotes) is the variable of the formatted data sent to the instrument.

Talk

```
CMD "?5B"
```

The ? is unlisten. 5 is the controller's listen address. B is the instrument's ASCII talk address equivalent of decimal 2.

Program for the HP 21MX (RTE BASIC)

Listen

```
PRINT #18,"F10E3A2C2I"
```

The address 18 is determined by the sum of logical unit assignment of the computer I/O (16 in this case), plus the decimal address (2) of the instrument.

Talk

```
READ #18,B$
```

The instrument talks via the GPIB and returns data to the B\$ string in the computer.

Program for the Tektronix 4051 (TEK BASIC)

Listen

PRINT @2,32:"F10E3A2C2I"

The 2 is the instrument's decimal address. The 32 inhibits the sending of the secondary address (secondary command) which the instrument does not use.

Talk

INPUT @2:B\$

The instrument talks via the GPIB and returns data to the B\$ string in the controller.

Program for the PET computer (BASIC)

Early in the Program, Assign Files

OPEN 2,34
OPEN 3,66

Since the instrument bus address is less than decimal 3, file 2 is opened for the listen address (2 + 32) and file 3 is opened for the talk address (2 + 64).

Listen

PRINT #2,"F10E3A2C2XV13I"

The 2 indicates file 2, which contains the listener address as defined in the OPEN statement. The XV13 defines the instrument terminator as CR.

Talk

INPUT #3,B\$

The instrument talks via the GPIB and returns data to the B\$ string in the computer.

Program for the HP85 (BASIC Language)

Listen

OUTPUT 702; "F10E3AC2I"

The 7 is the interface select code. The 02 is the instrument decimal address. The programming string is within the quotes.

Talk

ENTER 702; B\$

The instrument talks via the GPIB and returns data to the B\$ string in the computer.

SPECIFICATIONS

MODEL 270

WAVEFORMS (FUNCTIONS)

Programmable sine \sim , triangle \wedge , square \square , external width, and dc.

Sine Distortion (THD at 5 Vp-p):

< 0.5% 10 MHz - 99.9 kHz
No harmonics above
- 40 dBc 100 kHz - 999 kHz
- 30 dBc 1 MHz - 12 MHz

Time Symmetry

$\pm 1\% \pm 8$ ns.

Square Transition Time

< 15 ns.

Square Over/Undershoot

< 5% of pk-pk amplitude
 ± 20 mV.

Triangle Linearity

99% to 100 kHz.

OPERATIONAL MODES

Continuous

Output continuous at programmed frequency.

Triggered

Output quiescent until triggered by external signal, GPIB trigger or manual trigger, then generates one cycle at programmed frequency.

Gated

As Triggered mode except output is continuous for the duration of the gate signal. The last cycle started is completed.

Burst (Optional)

As Triggered mode for programmed number of cycles.

Count Range: 1 to 1,048,200.

Burst Rate: 12 MHz maximum.

FREQUENCY

Range

10 MHz to 12 MHz.

Resolution

3 digits.

Accuracy

$\pm 2\%$.

Repeatability (24 hr)

$\pm 1\%$.

Jitter

$\leq 0.1\% \pm 100$ ps.

Control

Frequency may be controlled 2 ways: Value or VCG.

Value: Frequency value is keyboard or GPIB programmable with automatic range selection.

VCG (Voltage Controlled Generator): AC or DC input controls frequency. 0.01 to 12 V into 10 k Ω for up to 1200:1 frequency change in each of 9 frequency ranges (ranges must be programmed).

Slew rate is limited to 0.1 V/ μ s.

AMPLITUDE

Range

0.01 to 10 Vp-p into 50 Ω (0.02 to 20 Vp-p into ≥ 50 k Ω) from main output. Absolute peak amplitude plus offset may not exceed 5V into 50 Ω (10V into ≥ 50 k Ω).

Resolution

3 digits or 10 mV when absolute peak amplitude plus offset > 0.5V; 3 digits or 1 mV when absolute peak amplitude plus offset ≤ 0.5 V.

Accuracy

$\pm 2\%$ of programmed value and:
 ± 5 mV for 0.1 to 1V (peak amplitude + offset < 0.5V),
 ± 20 mV for 1.01 to 10V,
 ± 50 mV for all other.

Repeatability (24 hr)

$\pm 1\% \pm 10$ mV.

Flatness

For output at 5 Vp-p: 0.1 dB to 100 kHz, 1.5 dB to 12 MHz.

OFFSET

Range

DC or offset programmable from -5V to +5V into 50 Ω (-10V to +10V into ≥ 50 k Ω). Absolute peak amplitude plus offset may not exceed 5V into 50 Ω (10V into ≥ 50 k Ω).

Resolution

3 digits or 10 mV when absolute peak amplitude plus offset > 0.5V, 3 digits or 1 mV when absolute peak amplitude plus offset ≤ 0.5 V.

Accuracy

± 40 mV in dc function.

Repeatability (24 hr)

$\pm 1\% \pm 20$ mV.

OUTPUTS

Function Output

Source of primary waveforms. Programmable to be On (source impedance 50 Ω), Off High Z (> 500 k Ω), or Off Low Z ($\approx 50\Omega$).

Source Impedance: 50 Ω .

Protection: Output protected to 140 Vac or 200 Vdc without replacement of internal fuse.

Sync Output

Sync signal is at programmed frequency and TTL level.

Level: ≤ 0.4 V to ≥ 2.4 V into 50 Ω ,
 ≤ 0.8 V to ≥ 4.8 V into ≥ 50 k Ω .

Source Impedance: 50 Ω .

Timing: Concurrent with main output in square; lags sine and triangle by 90°.

Over/Undershoot: < 10% into 50 Ω .

Protection: Output protected from short circuit to any voltage between ± 15 Vdc.

INPUTS

External Trigger

Discrimination of input circuit is programmable for acceptance of a + or - signal slope and required voltage level.

Level: - 10 to + 10V.

Resolution: 20 mV.

Accuracy: ± 500 mV.

Input Impedance: 10 k Ω .

Maximum Trigger Rate: 12 MHz (24 MHz for External Width).

Minimum Trigger Width: 20 ns.

Minimum Amplitude: 500 mVp-p to 1 MHz, 1 Vp-p to 24 MHz.

Protection

Inputs protected to ± 50 V.

VCG In

Voltage control of generator frequency. See Frequency.

Range: 0.01 to 12V.

Impedance: 10 k Ω .

GPIB PROGRAMMING

IEEE 488-1978 compatible. Non-isolated. Double buffered.

Address

0-30, keyboard or internal switch selectable. Internal switch can lock out keyboard selection. Power-up address is internal setting.

Subsets

- SH1—Complete Source Handshake
- AH1—Complete Acceptor Handshake
- T6—Basic Talker
- TE0—No Extended Talker
- L4—Basic Listener
- SR1—Complete Service Request (Software Selectable)
- RL1—Remote/Local and Local Lockout
- P0—No Parallel Poll Capability
- DC1—Complete Device Trigger Capability
- C0—No Controller Capability
- E2—Tri-State Drivers

Interface Timing

Frequency	11 ms
Amplitude	14 ms
Offset	14 ms
Mode	4 ms
Waveform	5 ms
Execute	8 ms
Other	4 ms

STORED SETTINGS

Volatile memory for 80 stored settings. Nonvolatile memory and 120 additional settings optional: total of 200 nonvolatile settings.

GENERAL

Environmental

Temperature Range: 25°C ±10°C for spec operation, operates 0°C to 50°C, -50°C to +75°C for storage.

Warm-up Time: 20 minutes for specified operation.

Altitude: Sea level to 10,000 ft for operation. Sea level to 40,000 ft for storage.

Relative Humidity: 95% at 25°C and sea level (non-condensing).

Dimensions: 21.7 cm (8.54 in.) wide (half-rack), 13.3 cm (5.25 in.) high, 39.4 cm (15.5 in.) deep.

Weight

5.9 kg (13 lb) net. 7.2 kg (16 lb) shipping.

Power

90 to 105, 108 to 126, 198 to 231, or 216 to 252 volts rms; 48 to 66 Hz; 1 phase; <40 watts.

MODEL 271

ALL 270 FEATURES AND SPECIFICATIONS PLUS:

WAVEFORMS (FUNCTIONS)

Programmable single pulse \square , delayed pulse \square , and double pulse \square .

OPERATIONAL MODES

Burst

As Triggered mode for programmed number of cycles.

Count Range: 1 to 1,048,200.

Burst Rate: 12 MHz maximum.

PULSE DELAY

Range: 80 ns to 0.1 sec.

Resolution: 3 digits.

Accuracy: ±3% ±10 ns ≥1.04 μs, ±5% ±10 ns <1.04 μs.

Duty Cycle: 80% ≥500 ns, 50% <500 ns.

Jitter: 0.1% + 1/2 LSD.

PULSE WIDTH

Range: 40 ns to 0.1 sec.

Resolution: 3 digits.

Accuracy: ±3% ±10 ns ≥1 μs, ±5% ±10 ns <1 μs.

Duty Cycle: 80% ≥500 ns, 50% <500 ns.

Jitter: 0.1% + 1/2 LSD.

PERIOD

Range: 83.3 ns to 100 sec.

Resolution: 2 digits.

Accuracy: ±3%.

UPPER/LOWER LEVEL

Upper level must be greater than lower level.

Range: ±5V.

Resolution: 20 mV.

Accuracy: See Amplitude and Offset specifications.

COMPLEMENT

Inverts (complements) pulse waveforms at function output. Applies only to pulse waveforms.

STORED SETTINGS

Volatile memory for 50 stored settings. Nonvolatile memory and 100 additional settings optional: Total of 150 nonvolatile settings.

MODEL 278

ALL 270 FEATURES AND SPECIFICATIONS PLUS:

WAVEFORMS (FUNCTIONS)

Programmable pulse \square and pulse complement \square .

OPERATIONAL MODES

Burst

As Triggered mode for programmed number of cycles.

Count Range: 1 to 1,048,200.

Burst Rate: 12 MHz maximum.

Synthesized

Same as Continuous except 5 digit frequency resolution and 0.0005% accuracy (5 ppm).

TTL Reference

Same as Synthesized except synthesizer externally referenced to a 10 MHz TTL source at REF IN BNC.

Zero Reference

Same as TTL Reference except external source is a zero-crossing 10 MHz signal.

TTL Lock

Main generator phase locked to external TTL signal at REF IN BNC. Capture and lock range >5% of programmed frequency.

Zero Lock

As TTL lock mode with external zero-crossing signal at REF IN BNC.

Triggered

Trigger sources include 1 Hz to 24 MHz internal trigger generator in nonsynthesized modes.

Gated

As for Triggered mode. Internal gate signal produced 50% duty cycle gate.

FREQUENCY

Range

10 MHz to 12 MHz except 10 Hz minimum in synthesizer modes.

Resolution

5 digits in synthesizer modes. 3 digits in all other modes.

Accuracy

5 ppm \pm 1 MHz in Synthesized mode. Accuracy of external signal \pm 1 MHz in reference modes. \pm 2% in all other modes.

Noise Floor

< - 50 dBc.

Spurious

< - 45 dBc.

INTERNAL TRIGGER

Range: 1 Hz to 24 MHz.

Resolution: 5 digits.

Accuracy: 0.0005%.

PULSE PERIOD

Range: 90 ns to 1 sec.

Resolution: 3 digits.

Accuracy: 0.1%.

PULSE WIDTH

Range: 45 ns to 0.5 sec.

Resolution: 2 digits.

Accuracy: 3% + 5 ns.

UPPER/LOWER LEVEL

Upper level must be greater than lower level.

Range: \pm 5V.

Resolution: 20 mV.

Accuracy: See amplitude and offset specifications.

OUTPUTS

Reference Output

1.5 Vp-p (into 50 Ω , TTL open circuit), 10 MHz when in synthesized modes.

Internal trigger frequency when in Triggered, Gated or Burst Modes.

Protection: Output protected from short circuit to any voltage between \pm 15 Vdc.

INPUTS

Reference Input

Used to externally reference or phase lock the main generator.

Programmable Input Selection: TTL or 1 Vp-p minimum zero-crossing.

Input: 10 MHz for external reference 10 Hz to 12 MHz for phase lock.

Protection: Input protected to \pm 50 Vdc.

STORED SETTINGS

Volatile memory for 40 stored settings. Nonvolatile memory

and 60 additional settings optional: Total of 100 nonvolatile settings.

GENERAL

Weight

6.8 (15 lb) net. 7.2 kg (16 lb) shipping.

Power

< 50 watts.

OPTIONS

001: Additional Stored Settings

Additional stored settings:

Model 270: 120

Model 271: 100

Model 278: 60

Standard and optional memory battery backed for 6 mo. memory retention (1-2 yr typical). "Low battery" display.

002: Rear Panel Connectors

Front panel BNC's relocated to rear panel.

003: Burst Option (270 only)

Programmable number of waveform cycles in a burst. Burst length: 1,048,200 max. Burst Rate: 12 MHz max.

WAVETEK®

WAVETEK SAN DIEGO, INC.

9045 Balboa Ave., San Diego, CA 92123
P. O. Box 85265, San Diego, CA 92138
Tel 619/279-2200 TWX 910/335-2007

128-6/82