

OPERATING MANUAL**STABILOCK® 4040**
Communications Test Set

© 1994 Wavetek

This document contains information proprietary to Wavetek and is provided solely for instrument operation. The information in this document or the software of the instrument may not be duplicated in any manner without the prior approval in writing from Wavetek GmbH.

Wavetek GmbH

Gutenbergstraße 2 – 4
D-85737 Ismaning, Germany
Tel.: +49 (89) 99 64 1-0
Fax: +49 (89) 99 64 1-160

Manual Revision 08/94
Manual Part Number 290 025
STABILOCK 4040
Manual Version 5.24-A



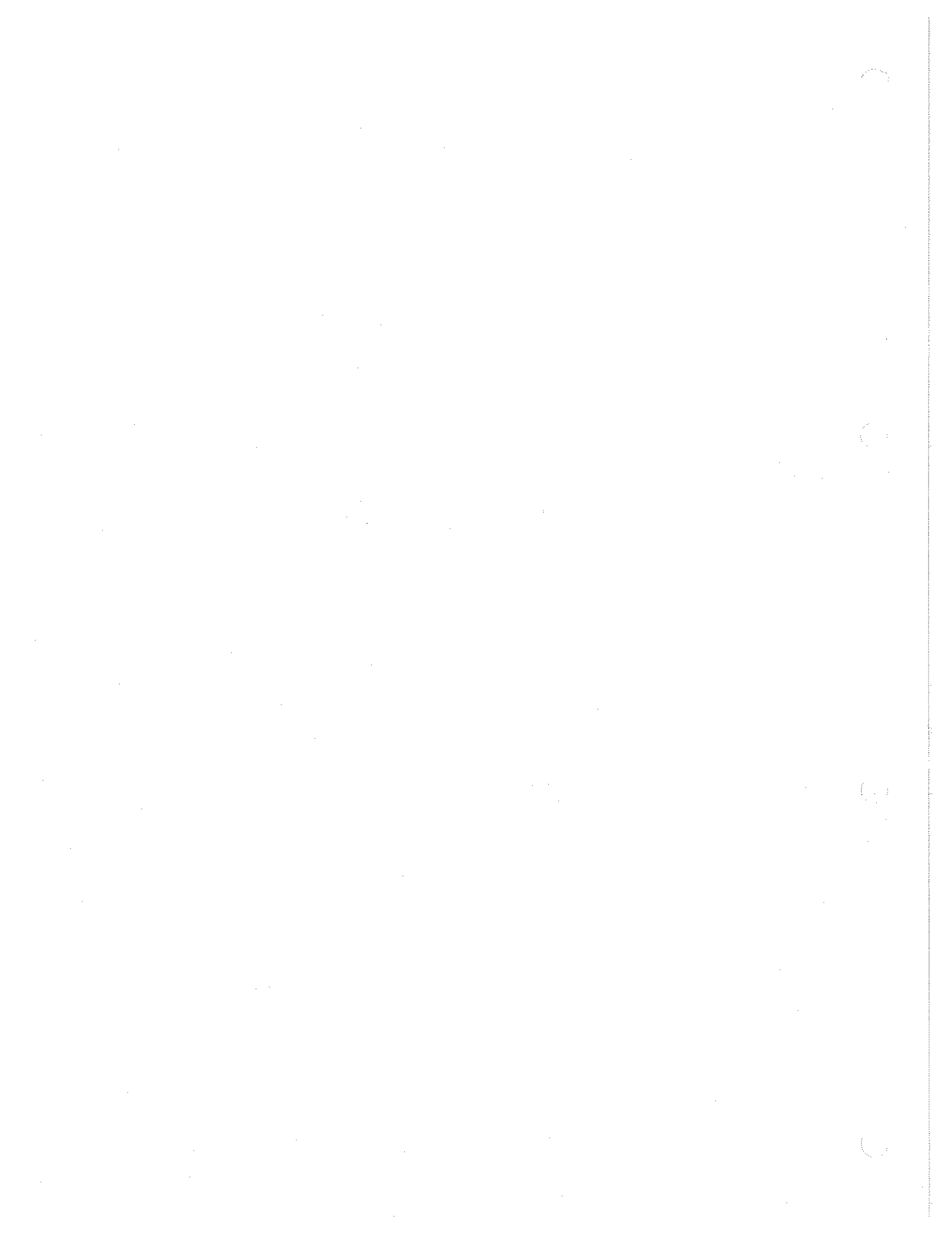

As you can see, we are now printing our manuals on recycled paper. Perhaps you would also like to know why we have decided to do this: because in our opinion 50 kg of chlorine organic compounds (eg dioxine) per ton of white, chlorine-bleached paper is simply too much. Quite apart from the fact that two or three trees also have to be felled for the purpose. By the way, from one ton of paper we can produce about a thousand manuals.

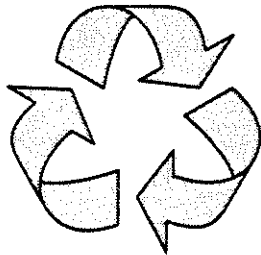
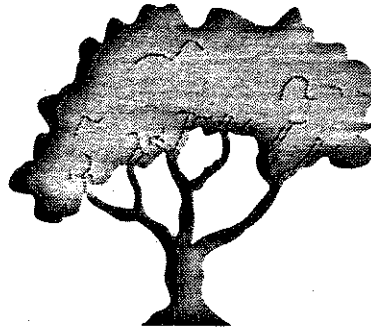

Our folders are 90% recycled paper. At present we are only using graphic paper for the cover with the impression.

To protect manuals against damp and dirt, they will be covered with a 120-micrometer-thin polypropylene film, which is quite unobjectionable in ecological terms.

Instead of the divider leaves of PVC we use the paper version. And where ever possible, we use a thumb index like in a telephone directory.

Trade names, article names and the like are used in this manual without any special identification because they are generally known by the reader. But these names can be the copyright of companies, institutes, etc.

Software and Documentation © 1985-1995 Wavetek GmbH. All rights reserved. No part of this manual or the associated program may be reproduced or copied in any form (print, photocopy or any other process) without the written approval of Wavetek GmbH.

! CAUTION !

Subject: Chapter 4, "AUTOTEST"

To avoid data loss on the memory card the card must not be plugged in when switching on or switching off the test set. It is sufficient to pull back the card approx. 1 cm in order to disconnect the card from the reading/writing device of the test set.

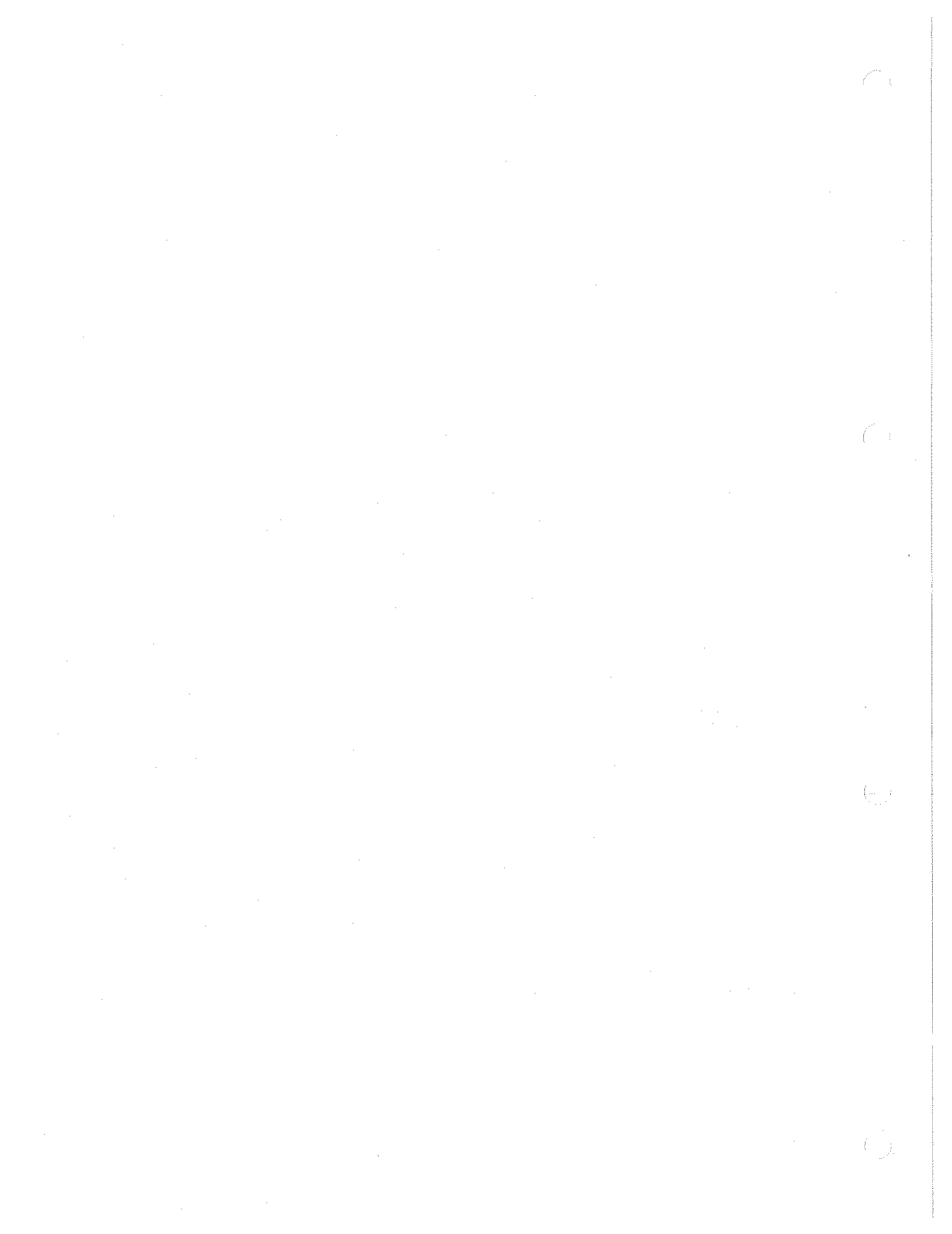

Contents

DATA SHEET

General, Specifications -----	1
-------------------------------	---

INSTALLATION INSTRUCTION

General -----	2-1
Power Operation -----	2-2
Battery Operation -----	2-3
Software Status -----	2-3
Switching On -----	2-4
External Synchronisation -----	2-4
Crystal Correction -----	2-4
Display of Options Built In -----	2-5
Rear Panel Connections	
10 MHz Synchronisation Bu12 -----	2-5
10 MHz Output Bu13 -----	2-5
AF Detector Bu15 -----	2-6
Monitor Output Bu16 -----	2-7
Double Modulation Bu17 -----	3-10
Control Interface Bu18 -----	2-8
Control Interface Bu19 -----	2-9
AM Output Bu36 -----	2-10
FM Output Bu37 -----	2-10
IF Output Bu38 -----	2-10
Printer Connection Bu20 -----	2-10
Wide Band FM Demod Bu40 -----	3-16

OPERATING INSTRUCTION

Short Form Operating Instruction -----	8-2
Connecting the Test Transceiver -----	3-1
Switch-On Status -----	3-2
Reset Functions -----	3-2
<u>Receiver Measurement</u>	
<u>Frequency Setting</u>	
Setting without Fine Detuning -----	3-3
Fine Detuning -----	3-3
Decadic Variation -----	3-3
Step Variation -----	3-4
<u>RF Output Level</u>	
Set -----	3-5
Vary and Switch Off -----	3-5
Terminal Voltage -----	3-5
dB Addition or Subtraction -----	3-6
RF DIRECT Output -----	3-6
2nd Signal Generator, Spectrum Analyser -----	3-7

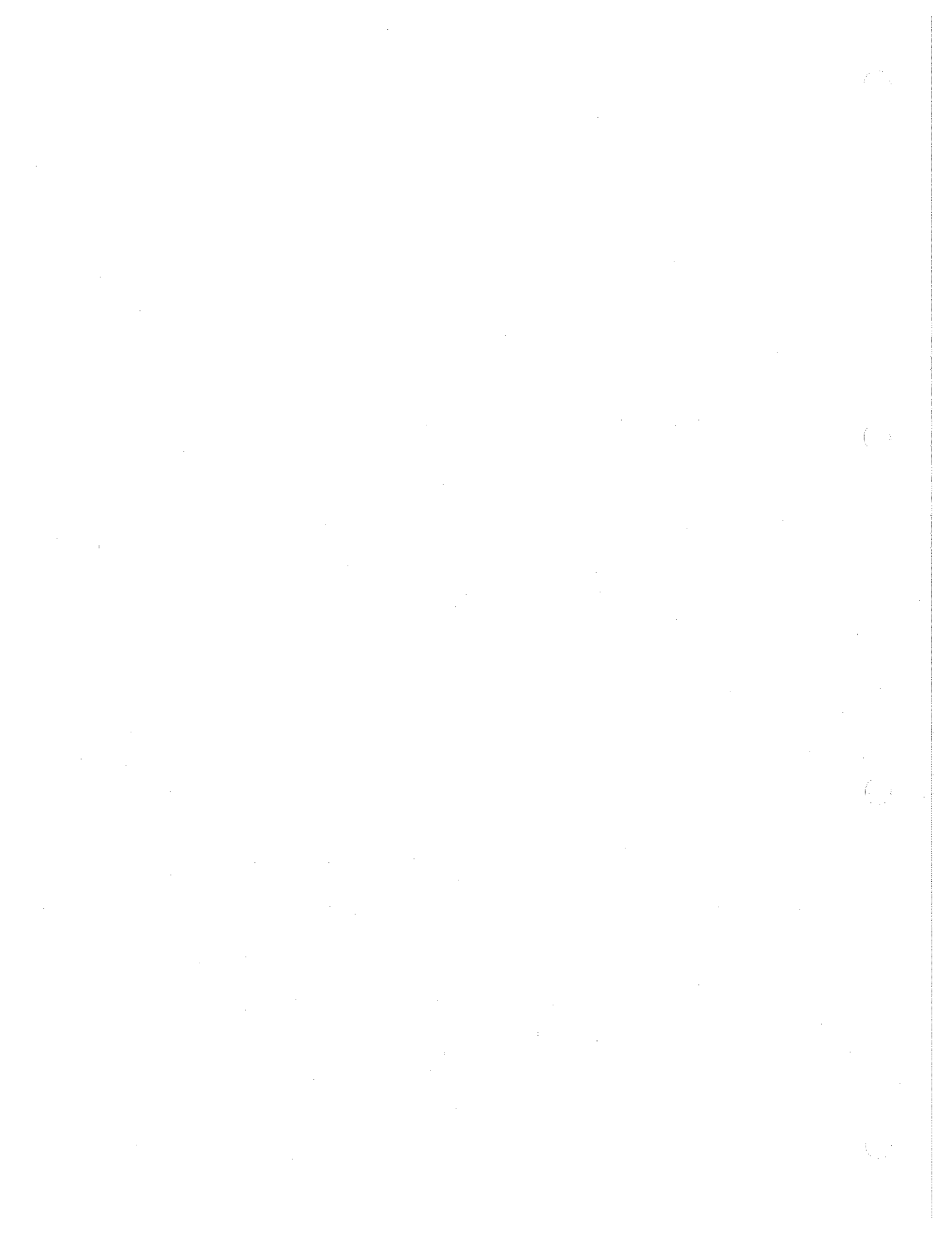

Setting Modulation	
Internal Modulation	3-8
External Modulation	3-9
Superimposing Modulation	3-10
Double Modulation	3-10
Wide Band FM	3-26
<u>Transmitter Measurement</u>	
Frequency OFFSET	3-11
Transmitter Frequency	3-12
Transmitter Power	3-13
Modulation Measurement	3-14
Residual Modulation	3-16
Wide Band FM Demodulator	3-16
<u>Modulation Generators</u>	
Output MOD GEN	3-17
Output MOD	3-18
<u>AC/DC Meter</u>	3-19
Distortion Measurement 200 to 600 Hz	3-33

SPECIALS

General	3-20
Measuring Conditions	3-20
SPECIALS via IEEE488 Bus	3-20
01 Modulation Sensitivity	3-21
02 Hold Peak Modulation Indication	3-22
03 Duplex FM Demodulator	3-23
04 Transmitter Harmonics	3-23
05 Spurious Signals	3-24
06 Selective Level Measurement	3-25
07 Adjacent Channel Power	3-25
08 Wide Band FM at Receiver Measurement Mode RX	3-26
09 Waiting Times	3-26
11 (S+N)/N Sensitivity	3-27
12 SINAD Sensitivity	3-27
13 Bandwidth and Center Frequency Error	3-28
14 Squelch Level	3-29
15 Interruption Free Level Range	3-30
16 Duplex Desensitisation and Duplex Filter Adjustment	3-30
17 AF Power	3-31
18 Frequency Transfer	3-31
19 Fast RX/TX Switching-over	3-32
21 External filters, distortion measurement	3-33
22 DC Measuring Inputs	3-34
23 Printout Mode	3-34
24 Entering Tolerance Limits	3-35
25 RF Preattenuation	3-36
26 Autoranging off	3-37
27 External Modulation Setability, DC-FM	3-9
28...29 Control Interface	3-39
31 Self Test	3-40
32...34 Selective Call Test	3-42
36 Step Variation of Frequency	3-4
35...37 Channel Number	3-46
39 Concealed SPECIALS	3-47

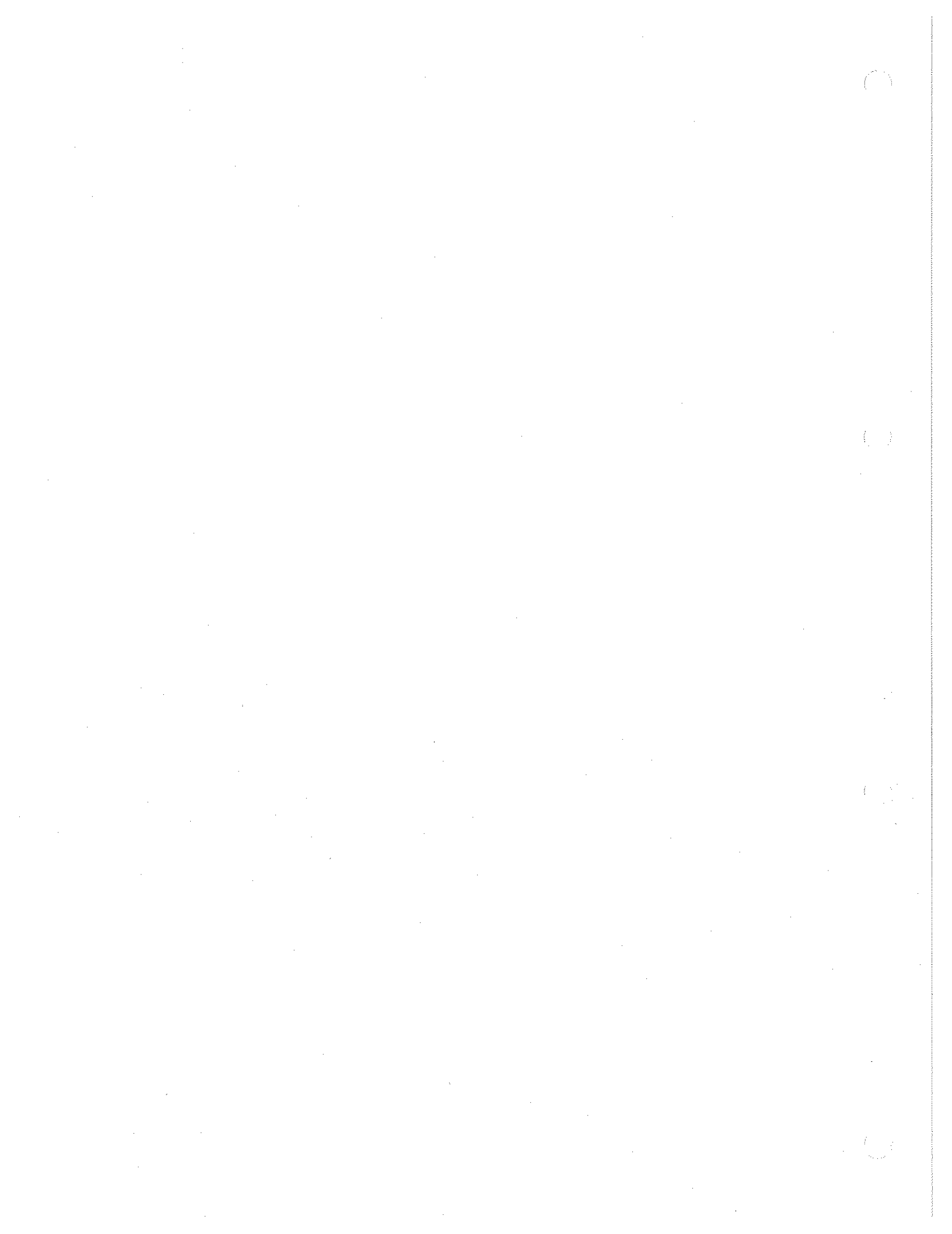

40 Shortened Measuring times with Controller -----	3-47
41 Cut-off EMF -----	3-29
42 Altering Unit (SPECIALs 11, 12, 14) -----	3-27, 3-29
43 SRN Measurement -----	3-48
44 Descending Channel Pattern -----	3-46
45 AF Generator 1 Hz Resolution -----	3-48
46 AF Generator with RX -----	3-48
47 SAT MOD/DEMOD -----	3-48
48 Frequency-settling transients on radio transmitters -----	3-49
49 Service Request -----	5-7
60 LED and Display Test	
61...63 Internal Test Routines IEEE	
64, 66 Software Status and Bus Address -----	2-3, 5-2
65 Display of Options Built In -----	2-5
90 Altering Program Frequency -----	4-6
94 Disable squelch on duplex stage -----	3-50
98 Program Repeat -----	4-6
99 Transition to Next File -----	4-6

AUTOTEST

Introduction -----	4-1
Memory Card -----	4-2
Autotest Display -----	4-4
Writing a Program -----	4-5
Channel Frequency Change -----	4-6
Run of Test Programs -----	4-7
File Handling -----	4-8
Editing Stored Programs -----	4-9
Program Printout -----	4-10
Text Input -----	4-10

IEEE 488 Bus

General Data -----	5-1
Bus Address -----	5-2
Bus Commands for the STABLOCK 4040	
Mode selection -----	5-4
General commands -----	5-4
Special routines -----	5-7
Trigger at single measurements -----	5-7
Modulation-peak hold -----	5-7
Service Request -----	5-8
Output Format -----	5-8
Transient Recorder -----	5-9

APPLICATION NOTES

Separate Table of Contents -----	6
----------------------------------	---

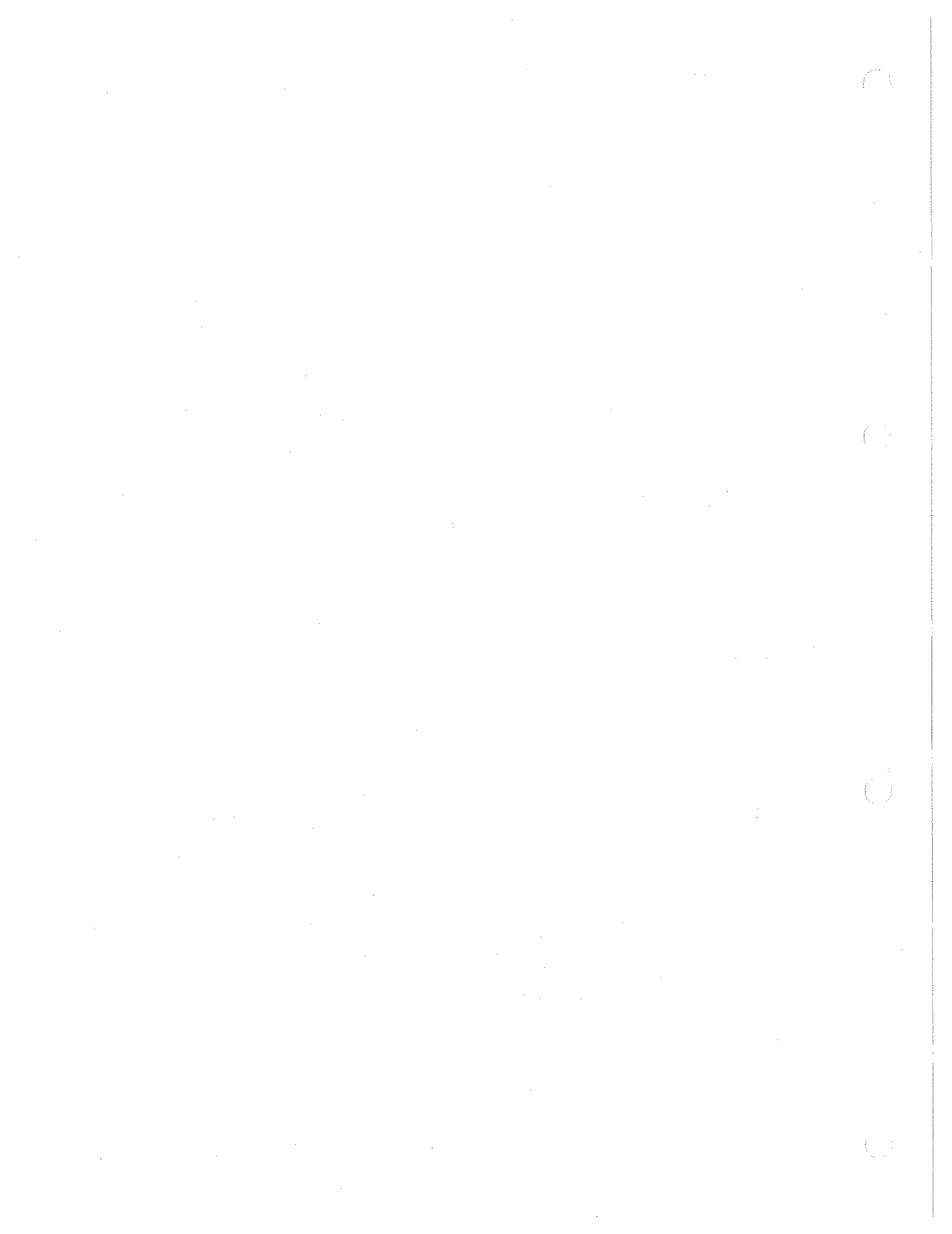

OPTIONS

Frequency-Range Extension	
Specifications -----	7-1
Operation -----	7-3
VSWR Measuring Head -----	7-4
SSB Stage (only with software 6.xx) -----	7-5

APPENDIX

Block Diagram -----	8-1
Short Form Operating Instruction -----	8-2

Test Division of Schlumberger Technologies, are now part of Wavetek Corporation.

So we are integrated into an international and successful enterprise that is fully committed to test engineering. That means decisive advantages for you. First of all, your investment to date is secured longterm.

The future-oriented, modular concept of our instruments will be pursued to ensure that everything continues to match everything else. Tackling your test and measurement problems with all our expertise and to develop exactly the right solution is what we will continue to do in the future, just as in the past 35 years.

Precision Radio Test Set STABILOCK® 4040

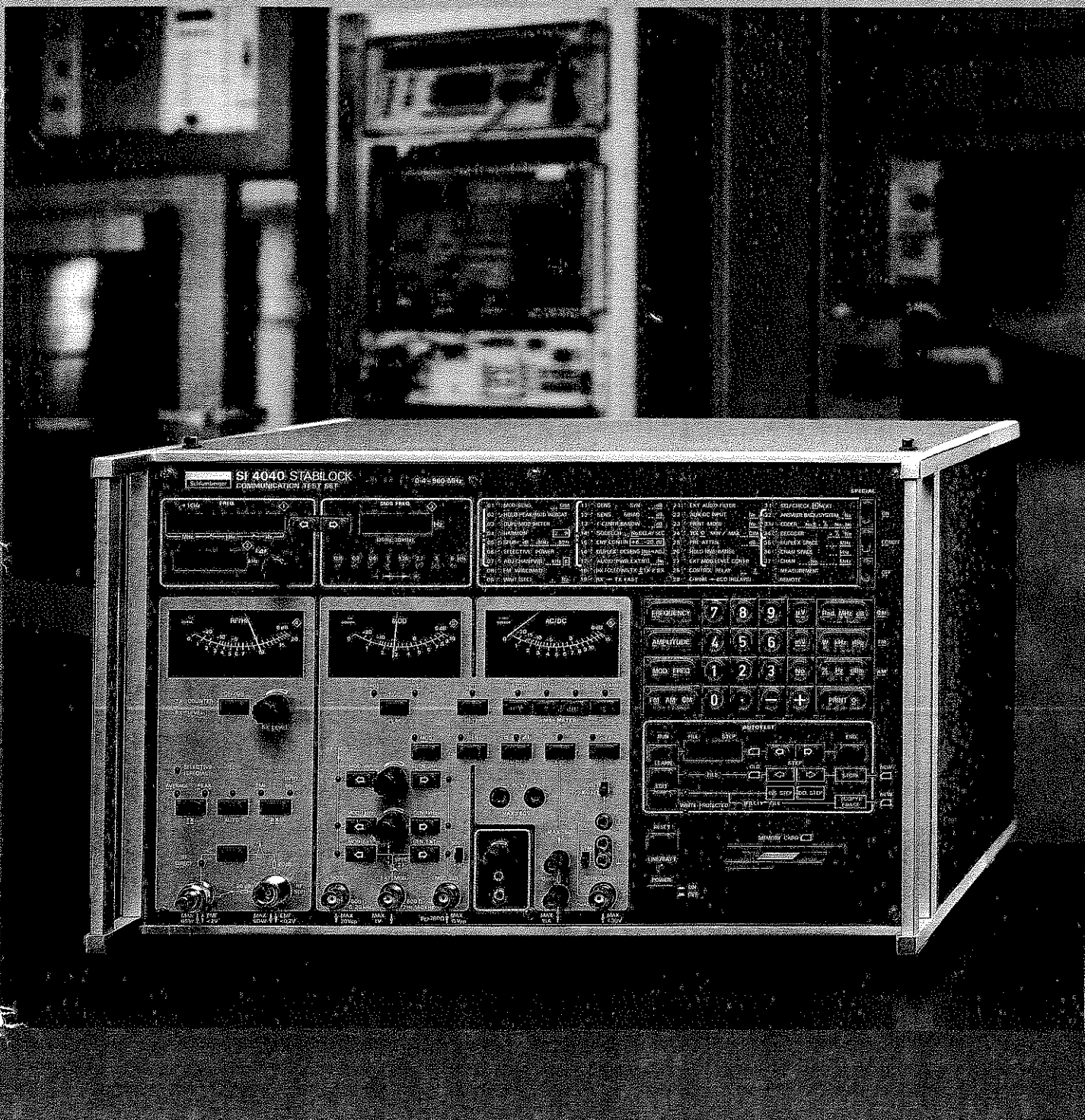

STABILOCK 4040

The "High Accuracy" Radio Test Set

Application

Claiming the title of the optimal Radio Measurement Technology for Development, Production and Quality Assurance, highlights the reputation of the STABILOCK 4040 High Accuracy Radio Test Set. Its worldwide use in renowned radio equipment manufacturers as well as its excellent data sheet characteristics speak for themselves. The STABILOCK 4040 checks reliably, precisely and quickly complete systems, radio sets and radio components. You have the choice between manual, half and fully automatic operation. Supplemented by the Radiocode Analyser 4923 the STABILOCK 4040 becomes a full digital measurement set. Integrated firmware performs powerful standard measurement with simple key-stroke operation. With an external controller, the programmer has an easily used powerful set of standard and "SPECIAL" functions. For your application a comprehensive set of accessories and options are available, for example frequency range up to 1.85 GHz, adjacent channel power measurement and a DC FM modulator.

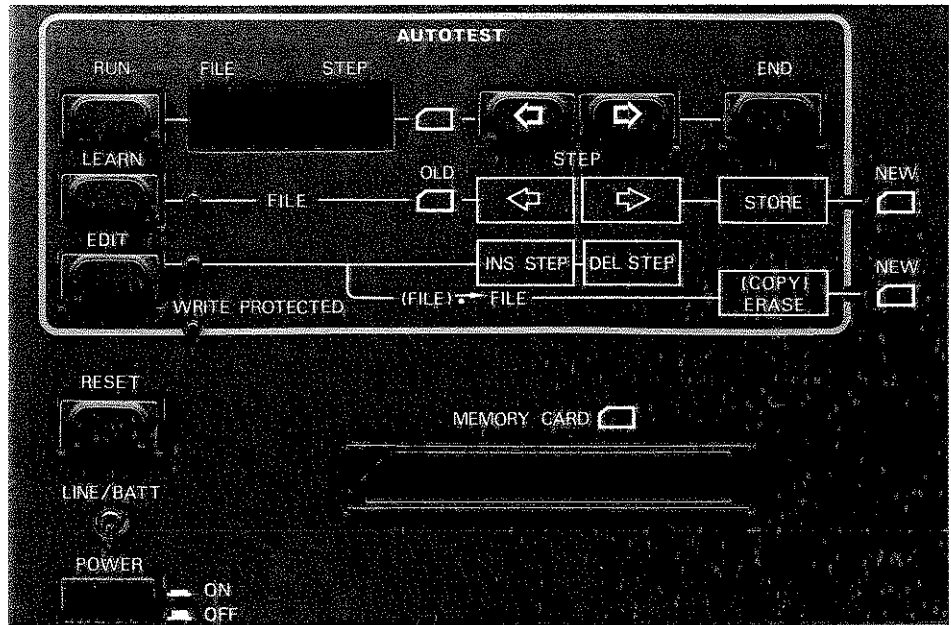

PRUEFPROTOKOLL FUER: FUNKGERAETE	
SENDERMESSUNG	
BETRIEBSSPANNUNG	12.0 V
STROMAUFNAHME	3.3 A
FREQUENZ	146.27934 MHZ
FREQUENZABLAGE	9.187 KHZ
SENDELEISTUNG	9.43 W
MOD-EMPFINDLICHKEIT	3.3 MV
KLIRRFAKTOR 1 KHZ	.7 %
MOD-FREQ-GANG	
0.3 KHZ	0.1 DB
0.4 KHZ	0.4 DB
2.7 KHZ	0.6 DB
3.0 KHZ	0.8 DB
6.0 KHZ	24.4 DB
S/N-CCITT	49.3 DB
2. OBERWELLE	75.3 DB
NACHBARKANALLEISTUNG+	78.7 DB
NACHBARKANALLEISTUNG-	76.4 DB
EMPPFAENGERMESSUNG	
STROMAUFNAHME	566 MA
MITTENFREQ-ABLAGE	214 KHZ
BANDBREITE 6 DB	16.72 KHZ
EMPFINDL. 12 DB SINAD	.51 UV
OBERE SQUELCH SCHW.	.89 UV
SQUELCH HYSTERESE	1.8 DB
NF-FREQUENZGANG	
0.3 KHZ	.6 DB
0.4 KHZ	.0 DB
2.7 KHZ	.3 DB
3.0 KHZ	.3 DB
6.0 KHZ	35.7 DB
KLIRRFAKTOR 1 KHZ	2.4 %

Selective call testing

Integral call tone encoder and decoder for ZVEI1, ZVEI2, CCIR, VDEW, EURO, NATEL or user-specific call sequence with extended first to fourth tone and preselectable parameters such as duration of tone/pause, encoder offset and decoder bandwidth. Rapid automatic switchover from receiver measurement to transmitter measurement with receipt call testing.

Examples for selective call testing:



Readout of a 5-tone sequence set at the encoder with extended first tone.



Readout of decoding with alarm tone in first position and second and fourth tone out of tolerance.

Manual

Operation is simplified by the clear arrangement of operating and display elements based on functions, the combination of analog and digital displays, rotary knobs for rapidly altering settings and routines for all principal radio set properties.

Semi-automatic

Complete testing of two-way radio sets including tolerance comparison, log printout with accompanying text, control of the radio set with integral sequential control which is "programmed" by operating the STABLOCK 4040 with no knowledge of programming language being required. The programs are recorded on a memory card and can be retrieved at any time.

Automatic

Processor-controlled test system with the STABLOCK 4040. Can be upgraded to include multi-transmitter measurements, control of UUT, power unit and further system equipment such as multiplexers, analyzers etc. A comprehensive software package enables all required measurements to be performed without any programming knowledge.

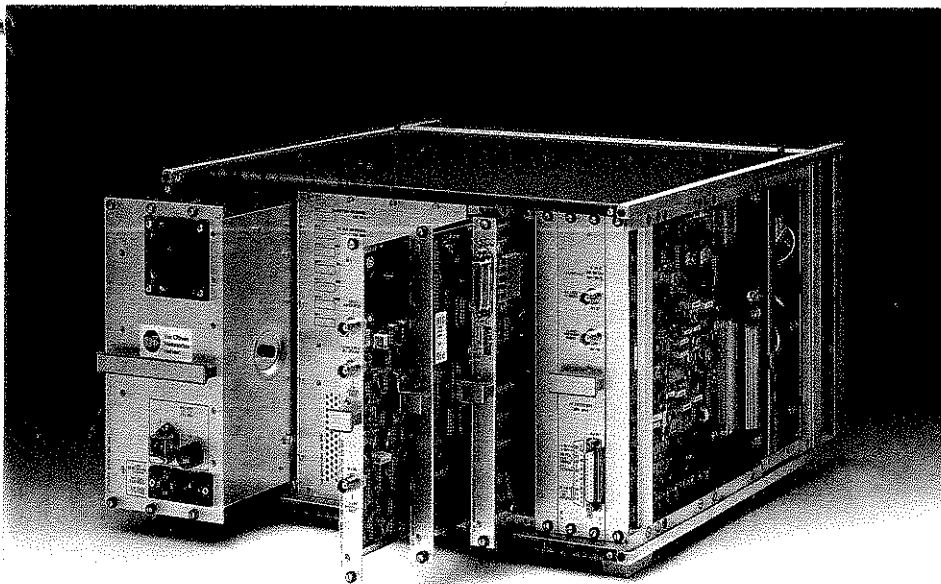
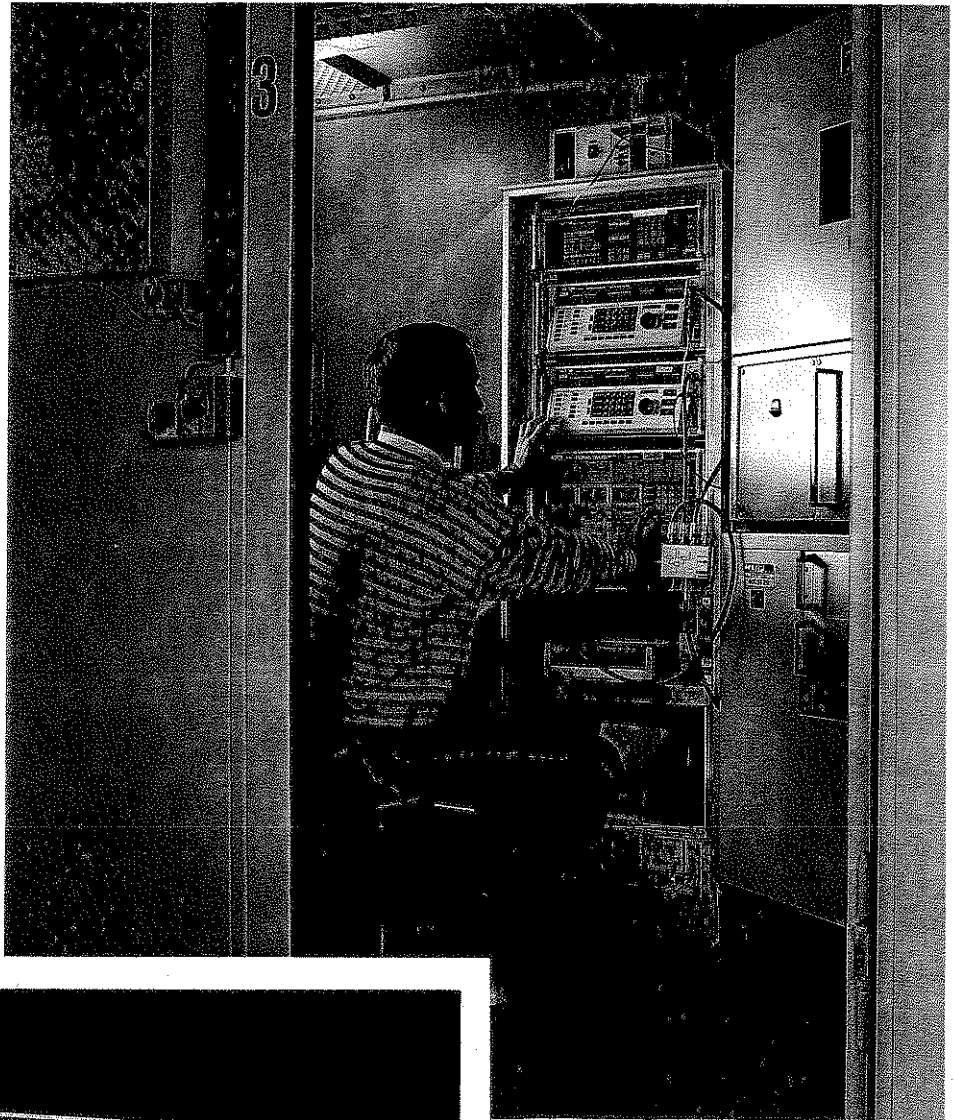

Options

Low-priced, field installable options such as Adjacent Channel Power Meter (and Selective RF Level Meter), Memory Card Interface, Control Interface, Duplex Demodulator, DC-coupled FM and Wideband Demodulator allow to expand the STABLOCK 4040 to meet future requirements.

Maintenance

Microprocessor-aided fault diagnostics in combination with easily replaceable modules ensure high availability of the STABLOCK 4040.

SI 4040 STABILOCK COMMUNICATION TEST SET

0.4-960 MHz

FREQ. MHz kHz Hz

MOD FREQ. Hz

(30 Hz, 30 kHz)

0.15 0.3 0.4 1 1.25 2.7 3 6 kHz

RF/Hz dB

MOD dB

AC/DC dB

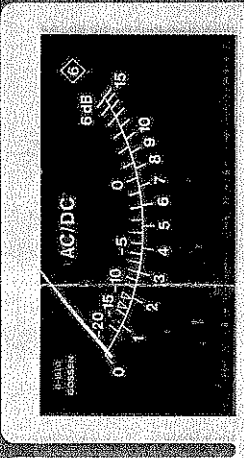
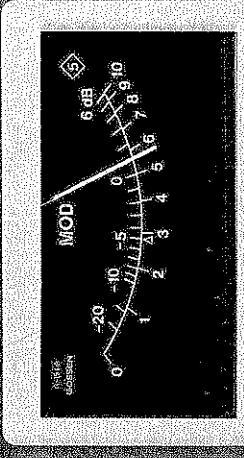
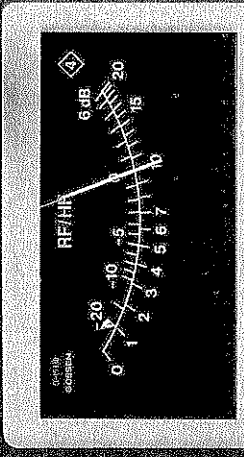

REFLECTIVE **AVG** **PEAK** **EMF** **EMF**

RF/LEVEL **RF/LEVEL** **RF/LEVEL**

RF/LEVEL **RF/LEVEL** **RF/LEVEL**

REFLECTIVE **AVG** **PEAK** **EMF** **EMF**

RF/LEVEL **RF/LEVEL** **RF/LEVEL**

RF/LEVEL **RF/LEVEL** **RF/LEVEL**

REFLECTIVE **AVG** **PEAK** **EMF** **EMF**

RF/LEVEL **RF/LEVEL** **RF/LEVEL**

RF/LEVEL **RF/LEVEL** **RF/LEVEL**

- SPECIAL**
- 01 MOD SENS SENS S/N EXT AUDIO FILTER 21
 - 02 HOLD PEAK MOD INDICAT SENS SINAD DB AUX DC INPUT 22
 - 03 DUPL MOD METER DB CENTER BANDW DB PRINT MODE 23
 - 04 TUNING DB SQUELCH No DELAY SEC 24
 - 05 TOL MIN / MAX DIM 34
 - 06 SELECTIVE POWER MHz EMP CONTIN dB 20 DB 16
 - 07 ADD CHAN FWR kHz DUPLEX DESENS No ADJ 25
 - 08 FM WIDEBAND kHz AUDIO PWR EXT LO No 27
 - 09 WAIT SEC No RX FOLLOW STX TX 2 RX 28
 - 10 TX FAST No TX 29
 - 11 SENS S/N EXT AUDIO FILTER 21
 - 12 HOLD PEAK MOD INDICAT SENS SINAD DB AUX DC INPUT 22
 - 13 DUPL MOD METER DB CENTER BANDW DB PRINT MODE 23
 - 14 TUNING DB SQUELCH No DELAY SEC 24
 - 15 SELECTIVE POWER MHz EMP CONTIN dB 20 DB 16
 - 16 ADD CHAN FWR kHz DUPLEX DESENS No ADJ 25
 - 17 FM WIDEBAND kHz AUDIO PWR EXT LO No 27
 - 18 WAIT SEC No RX FOLLOW STX TX 2 RX 28
 - 19 TX FAST No TX 29
 - 31 SEL CHECK NEXT 31
 - 32 ANSWER BACK/SYSTEM No 32
 - 33 CODEF No % No 33
 - 34 DECODER % No 34
 - 35 DUPLEX SPACE MHz 35
 - 36 CHAN SPACE MHz 36
 - 37 CHAN No 37
 - MEASUREMENT 38
 - CONTROL RELAY 39
 - CHANF BCD (RELAYS) 40
 - REMOTE 41

FREQUENCY **Rad MHz dB** **FM**

AMPLITUDE **μV** **FM** **W kHz dB** **AM**

MOD FREQ **No** **% Hz dBm** **PRINT**

AUTOTEST

RUN **FILE** **STEP** **END**

LEARN **FILE** **STEP** **STORE** **NEW**

EDIT **FILE** **OLD** **INS STEP** **DEL STEP** **(COPY)** **ERASE**

WRITE PROTECTED **(FILE)** **FILE**

RESET **MEMORY CARD**

LINE/BATT **POWER** **ON** **OFF**

MAX 100Vpp MAX 15Vpp MAX 15Vpp MAX 15Vpp MAX 15Vpp MAX 15Vpp



Technical Data

Signal generator

Carrier frequency	
Frequency range	0.4 to 960 MHz
Resolution	10 Hz
Accuracy	as Reference Oscillator
Reference oscillator	
Frequency error	$< 1 \times 10^{-7}$ after 15 min, at 20°C
Temperature drift	$< 5 \times 10^{-8}$ / °C
Ageing	$< 1 \times 10^{-6}$ / year
Output	10 MHz, approx. + 5 dBm
Output level (EMF)	
Socket RF	0.1 μ V to 0.2 V (max. 0.1 V with AM)
Socket RF DIRECT	1 μ V to 2 V (max. 1 V with AM)
Resolution	0.1 dB
EMF error Socket RF 20 to 500 MHz	< 1.3 dB \pm 1 digit
0.4 to 960 MHz	< 1.8 dB \pm 1 digit
EMF error Socket RF DIRECT	as before + 0.7 dB (max.)
Impedance	50 Ω
VSWR	
Socket RF	< 1.1
Socket RF DIRECT	< 1.5 (P < -5 dBm)
EMF setting range without interruption	0 to 26 dB
Additional level error	0.1 dB per dB

Spectral purity

(EMF setting range = 0 dB)

Phase noise 25 kHz from carrier	
f \leq 500 MHz	< -132 dBc / Hz
f > 500 MHz	< -126 dBc / Hz
Residual FM in a 30 Hz to 3 kHz bandwidth	
f \leq 500 MHz	< 2 Hz (rms)
f > 500 MHz	< 3 Hz (rms)
Spurious signals 0.01 to 30 MHz from carrier	
f \leq 500 MHz	< -80 dBc
f > 500 MHz	< -75 dBc
Harmonics	< -25 dBc
Residual AM	< -70 dB referred to 30 % AM, CCITT-weighted

FM

Frequency deviation Δf	0 to 20 kHz
Resolution	10 Hz ($\Delta f < 4$ kHz) 100 Hz ($\Delta f > 4$ kHz)
Modulation frequency	
internal	30 Hz to 30 kHz
external	2 Hz to 140 kHz (-3 dB)
Setting error with $\Delta f < 10$ kHz	
f _{mod} = 0.3 to 3 kHz	< 4 % \pm 2 digit
f _{mod} = 0.03 to 30 kHz	< 8 % \pm 2 digit
Distortion	
	< 2 % at $\Delta f < 10$ kHz and f _{mod} = 0.3 to 3 kHz

DC-coupled FM (option)

Frequency deviation Δf	0 to 5 kHz
Resolution	10 Hz ($\Delta f < 4$ kHz) 100 Hz ($\Delta f > 4$ kHz)
f _{mod}	0 to 30 kHz
Setting error	< 4 % \pm 2 digit

Distortion	< 2 % (f _{mod} = 0.3 to 3 kHz)
Frequency offset	< 150 Hz

Broadband FM

Maximum frequency deviation depending on carrier frequency	
0.4 to $<$ 60 MHz	80 kHz
60 to $<$ 120 MHz	20 kHz
120 to $<$ 250 MHz	40 kHz
250 to $<$ 960 MHz	80 kHz

Φ M

Phase deviation	0 to 6 rad
Resolution	0.01 rad
Modulation frequency internal and external	
	100 Hz to 16 kHz (f _{mod} \times rad $<$ 20 kHz)
Setting error	< 4 % \pm 2 digit (0.3 to 3 kHz)
Frequency response	< -3 dB (100 Hz to 16 kHz)
Distortion	< 1 % (0.3 to 3 kHz)

AM

(EMF setting range = 0 dB)

Modulation depth	0 to 90 %
Resolution	0.1 %
Modulation frequency	
internal	30 Hz to 20 kHz
external	2 Hz to 20 kHz
Setting error for m $<$ 70 %	
f _{mod} = 0.3 to 3 kHz	< 4 % \pm 2 digit
f _{mod} = 0.03 to 10 kHz	< 8 % \pm 2 digit
Distortion	
	< 2 % to 50 % AM and f _{mod} = 0.3 to 3 kHz

Test receiver

Frequency measurement

Measuring range	30 kHz to 960 MHz
Resolution	10 Hz
Input level range	
Socket RF	0.3 mW to 50 W
Socket RF DIRECT	3 to 100 mV
Measuring error	like ref. oscillator \pm 10 Hz

Frequency-offset measurement

Frequency range	2 to 960 MHz
Measuring ranges	0 to ± 10 / ± 100 kHz
Resolution	1 Hz / 10 Hz
Admissible input level range with < 10 kHz offset	
Socket RF	10 μ W to 50 W
Socket RF DIRECT	0.5 to 200 mV

Power measurement

Frequency range	2 to 960 MHz
Measuring range	20 mW to 50 W
Resolution	10 mW $<$ 10 W 0.1 W \geq 10 W
Measuring error with average indication	
f = 15 to 500 MHz	< 8 % \pm 1 digit
f = 5 to 960 MHz	< 12 % \pm 1 digit

FM measurement

Frequency range	2 to 960 MHz
Deviation measuring range	
	0 to 50 kHz
Resolution	10 Hz ($\Delta f < 10$ kHz) 100 Hz ($\Delta f \geq 10$ kHz)

Measuring error with $\Delta f < 10$ kHz	
f _{mod} = 0.3 to 3 kHz	< 4 % \pm 2 digit
f _{mod} = 0.06 to 10 kHz	< 8 % \pm 2 digit

Input level range	
Socket RF	0.8 mW to 50 W
Socket RF DIRECT	5 to 200 mV
Demod output	DC to 20 kHz (-3 dB)

Broadband FM demodulator (option)

Frequency range	2 to 960 MHz
Deviation measuring range	
	0 to 50 kHz
Input level range	
Socket RF	10 mW to 50 W
Measuring error with	
f $<$ 500 MHz	< 5 % + residual FM
f _{mod} = 50 to 100 kHz	< 9 % + residual FM
Residual FM	
f $<$ 500 MHz	< 350 Hz peak
f \geq 500 MHz	< 500 Hz peak
Demod output	DC to 140 kHz (-3 dB)

Φ M measurement

Frequency range	2 to 960 MHz
Measuring range	0 to 6 rad ($\Delta f < 50$ kHz)
Resolution	0.01 rad
Measuring error with	
f _{mod} = 0.3 to 3 kHz	< 4 % \pm 2 digit
f _{mod} = 0.2 to 10 kHz	< 8 % \pm 2 digit
Demod output	150 Hz to 16 kHz (-3 dB)

AM measurement

Frequency range	2 to 960 MHz
Measuring range	0 to 99 %
Resolution	0.1 %

Measuring error with	
f _{mod} = 0.3 to 3 kHz	< 4 % \pm 2 digit
f _{mod} = 0.06 to 10 kHz	< 8 % \pm 2 digit

Input level range	
Socket RF	0.1 mW to 50 W peak
Socket RF DIRECT	7 mV to 1 V peak
Demod output	DC to 20 kHz (-3 dB)

Spurious-modulation measurement

Weighting	true rms
Measuring ranges for measuring error < 1 dB, referred to 3 kHz FM, 3 rad Φ M or 30 % AM	
f $<$ 500 MHz	0 to 60 dB / CCITT-weighted
f \geq 500 MHz	0 to 56 dB / CCITT-weighted
f $<$ 500 MHz	0 to 48 dB / 0.03 to 30 kHz
f \geq 500 MHz	0 to 44 dB / 0.03 to 30 kHz
Admissible input level	
Socket RF	> 10 mW
Socket RF DIRECT	> 20 mV

Adjacent-channel power measurement (option)

Frequency range	10.5 to 960 MHz
Input level range	
Socket RF	1 mW to 50 W
Socket RF DIRECT	20 to 200 mV
Measuring range for adjacent-channel power	
f $<$ 499 MHz	-18 to -80 dBc
f \geq 499 MHz	-18 to -76 dBc usable from -15 dBc
Channel spacings	10 / 12.5 / 20 / 25 kHz
Measuring error	< 3 dB

Harmonics measurement	0 to -70 dBc
Measuring error	< 3 dB to -60 dBc
Spurious-signal measurement	0 to -80 dBc
Measuring error	< 2 dB for -35 to -75 dBc and carrier offset 50 kHz to 20 MHz
Measuring range for selective level measurement	
Socket RF	-70 to +47 dBm
Socket RF DIRECT	-105 to +0 dBm
Measuring error	< 4 dB / < 600 MHz
Measuring bandwidth	approx. 3 kHz

Duplex FM/PhM demodulator (option)

Frequency range	27 to 960 MHz
FM measuring range	0 to 20 kHz
Resolution	10 / 100 Hz
ΦM measuring range	0 to 6 rad ($f_{mod} \times \text{rad} \leq 20 \text{ kHz}$)
Resolution	0.01 rad
f_{mod}	0.2 to 20 kHz
Measuring error	
($f_{mod} = 0.3$ to 3 kHz, $P_{in} = 0.5$ to 50 W):	
FM	< 5 % + residual FM ± 2 digit
ΦM	< 6 % + residual FM ± 2 digit
Residual FM, CCITT-weighted, rms	
FM	
$f \leq 500 \text{ MHz}$	< 10 Hz
$f > 500 \text{ MHz}$	< 2 Hz / 100 MHz
ΦM	
$f \leq 500 \text{ MHz}$	< 0.02 rad
$f > 500 \text{ MHz}$	< 0.01 rad / 100 MHz
Squelch threshold	
$f \geq 200 \text{ MHz}$	> 10 mV

General data

Variable modulation generator

Frequency range	30 Hz to 30 kHz
Resolution	0.1 Hz ($f < 300 \text{ Hz}$) 1 Hz ($f < 3 \text{ kHz}$) 10 Hz ($f \geq 3 \text{ kHz}$)
Fixed frequencies	0.15 / 0.3 / 0.4 / 1 / 1.25 / 2.7 / 3 / 6 kHz
Frequency error	< 0.01 %
EMF range	0.1 mV to 5 V
Load resistance	> 200 Ω
Level resolution	0.1 mV ($V = < 0.1 \text{ V}$) 1 mV ($V = < 1 \text{ V}$) 10 mV ($V = \geq 1 \text{ V}$)
EMF error	< 4 % ± 1 digit ($f_{mod} = 0.3$ to 3 kHz)
Distortion	< 1 % at $f > 50 \text{ Hz}$
Source resistance	< 5 Ω ($f = 0.3$ to 3 kHz) floating or 600 Ω ± 5 %

1 kHz modulation generator

Frequency error	< 0.1 Hz
Distortion	< 0.2 %

AF superposition

Variable modulation generator + 1 kHz modulation generator + external modulation signal	
Sum voltage	max. 15 V _{pp}

AF voltmeter

Frequency range	30 Hz to 30 kHz or CCITT-P53-weighted
Measuring range	0.2 mV to 30 V unbalanced 10 V max. balanced
Resolution	0.1 mV ($V < 0.1 \text{ V}$) 1 mV ($V < 1 \text{ V}$) 10 mV ($V < 10 \text{ V}$) 100 mV ($V \geq 10 \text{ V}$)
Measuring error	$f = 0.3$ to 3 kHz $f = 50 \text{ Hz}$ to 20 kHz
$f = 0.3$ to 3 kHz	< 5 % ± 1 digit
$f = 50 \text{ Hz}$ to 20 kHz	< 8 % ± 1 digit
Input resistance	100 kΩ ± 10 % or 600 Ω ± 4 % floating or grounded

Distortion meter

Measuring frequency	1 kHz ± 5 Hz
Measuring range	0 to 99 %
Resolution	0.1 %
Measuring error	$k = 1$ to 90 %
$k = 1$ to 90 %	< 5 % ± 3 digit
Input level	0.1 to 30 V

SINAD meter

Measuring range	1 to 46 dB
Resolution	0.1 dB (SINAD < 30 dB) 0.5 dB (SINAD ≥ 30 dB)
Measuring error	< 0.8 dB ± 1 digit
Input level	0.1 to 30 V

AF counter

Frequency range	30 Hz to 30 kHz
Resolution	0.1 Hz ($f < 300 \text{ Hz}$) 1 Hz ($f < 9700$ (9999) Hz) 10 Hz ($f \geq 9700$ (10000) Hz)
Measuring error	< 0.01 % ± 1 digit
Admissible input level	5 mV to 30 V

DC voltmeter

Measuring range	0 to ± 50 V
Resolution	10 mV ($V < 10 \text{ V}$) 100 mV ($V \geq 10 \text{ V}$)
Measuring error	< 5 % ± 1 digit
Input resistance	> 100 kΩ

DC ammeter

Measuring range	0 to ± 15 A
Resolution	1 mA ($I < 2 \text{ A}$) 10 mA ($I \geq 2 \text{ A}$)
Measuring error	< 4 % ± 5 mA
Shunt resistance	10 mΩ

SSB stage (option)

Frequency range	TX measurements 2 to 960 MHz
RF power measurement	0.1 W to 50 W (average and peak)
Measuring error	like with standard instrument
Preselectable intermodulation	25 to 40 dB
Test frequencies (AF)	0.7 / 1.7 kHz or 1.1 / 1.7 kHz
Frequency offset	± 50 kHz
Residual FM measurement	like "FM measurement" (page 6)
AF bandwidth	10 Hz to 30 kHz

Carrier suppression	0 to 60 dB ($f = 0$ to 15 kHz)
Measuring error	± 2 dB (0 to 40 dB)
SB suppression	0 to 60 dB ($f = 0$ to 15 kHz)

SSB modulation	RX measurements 0 to 30 kHz
Resolution	10 Hz
Frequency accuracy	like reference oscillator
Intermodulation measuring ranges	0 to 50 dB 0 to 60 dB (0 dBm / 600 Ω)
Measuring error	± 2 dB
Testable sensitivity	to 10 dB SINAD
Measuring error	< 0.8 dB ± 1 digit
Offset range	1 kHz ($f = 1 \text{ kHz}$)
max. RF level	
Socket RF DIRECT	+ 13 dBm
Socket RF	- 7 dBm
max. RF level for intermodulations measurements	
Socket RF DIRECT	+ 7 dBm
Socket RF	- 13 dBm

Selective call testing

Encoder, decoder and acknowledgement call testing. Tone sequences with up to 8 tones	
Call systems	ZVE1, ZVE2, CCIR, VDEW, EURO, NATEL and a free programmable tone sequence
Frequency error	< 0.01 %
Distortion	< 1 %
Frequency offset	0 to ± 9.9 %
Tone duration	20 to 999 ms
Pause duration	0 to 99 ms
Decoder bandwidth	± 0.1 to ± 9.9 %

IEEE-bus interface

Standard	IEEE 488
Connector	24-way
Functions	AH1, SH1, L2, T1, SR1, RL1, DC1

Control interface 236 041 (option)

16 on-off relays and 16 switchover relays

VSWR test probe (option)

Frequency range	25 to 500 MHz
VSWR measuring range	1.00 to 9.99
Measuring error	< (VSWR - 0.9) / 3
Impedance	50 Ω (VSWR < 1.07)
Forward power	50 mW to 50 W
Connecting cable	6 m

Power supply, dimensions, weight.

AC mains	97 to 140 V and 180 to 260 V 47 to 450 Hz, approx. 120 VA
DC Supply	11 to 32 V, approx. 85 W
Operating temperature	+ 5 to + 45 °C
Storage temperature	- 25 to + 70 °C
W x H x D	443 x 264 x 374 mm
Weight	approx. 21 kg (46 lb)

Transient Recorder for Radio Sets

Brief interference in adjacent channels when turning the transmitter of radio sets on and off or when the transmitter power takes too long to build up are typical problems that are simply analyzed with the aid of the transient recorder* in STABLOCK 4040.

Together with Windows on a PC and the transient recorder PC program, Precision Radio Test Set STABLOCK 4040 proves that it is still right up to date and up to the mark.

Storing test curves, printing, superimposing, comparison and enlargement are no problem at all. Thanks to Windows, test curves are easily transferred to other programs and printed out.

* Contained in all firmware versions \geq 5.12

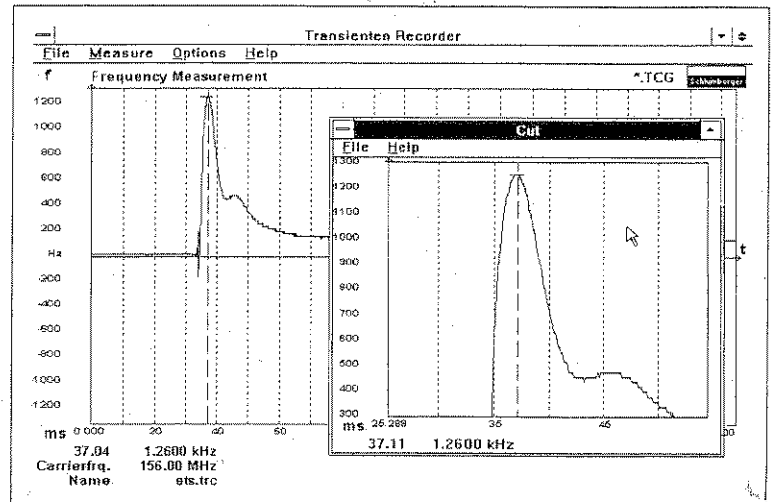

This picture shows the transient frequency response. The measurement is triggered by pressing the transmit key ($t = 0.0$ ms). For more detailed analysis, a section of the curve was zoomed for display in its own window. The maximum frequency error can be determined very fast with the aid of a cursor. In this example it is 1260 Hz and appears 37.12 ms after pressing the transmit key.

Ordering information

Radio Test Set STABLOCK 4040

incl. IEEE-bus interface 102 501

Options and extra accessories

Memory card/interface 235 041
 Memory card interface update kit 248 122
 Memory card 897 050
 Control interface 32 relays 236 041
 Frequency range extension 1.85 GHz 222 040
 Duplex FM/PhM demodulator 229 061
 DC-FM modulator 217 040
 Adjacent channel power meter 229 042
 SSB stage 219 003
 Transient Recorder PC Software 897 107
 IEEE-Bus Interface Card PC II A 860 182
 High speed IEEE 893 346
 Spare ink cartridge 860 133
 Printer paper 2500 sheets 860 134
 Stabitexter (Keyboard) * 248 081

RF probe 860 108
 300-Hz lowpass filter 248 074
 300-Hz highpass filter 248 099
 4-kHz bandpass filter (for NMT) 248 075
 200 to 600 Hz notch filter 248 079
 6 kHz notch filter (for TACS) 248 178
 VSWR test probe ** 248 104
 Front panel cover 860 034
 Soft carrying case 860 001
 Transport case 300 644
 Military case 860 060
 19-inch adapter (1 piece) 478 353
 IEEE-Bus cable, 2 m 860 110
 Connector set 300 690
 N/BNC adapter
 2 x 1 m cable BNC/BNC
 1 x 1 m cable N/N
 1 x 1 m cable BNC/banana
 25-way type "D" connector 300 641
 50-way type "D" connector 300 643

3-way AF connector 886 101
 TNC/BNC adapter 886 255
 Service manual 291 025

Accessories supplied

Power cable standard 249 012
 or Power cable USA 880 604
 or Power cable UK 880 621
 Mains fuse 220 V; T 1.6 A 849 036
 Mains fuse 110 V; T 3.15 A 849 037
 Battery fuse; T 16 A 849 071
 50 Ω TNC termination 874 008
 Phone plug 884 123
 Battery connector 300 642
 Operating manual 290 025

* A control interface 236 041 is required for connecting the Stabitexter.

** Can be used only in conjunction with the adjacent channel power meter option 229 042.

Schlumberger Technologies GmbH

Gutenbergstrasse 2-4, D-85737 Ismaning
 Tel. (+49 89) 9 96 41-0
 Fax (+49 89) 9 96 41-160

Schlumberger Technologies Ges. m.b.H.

Meidlinger Hauptstrasse 46, A-1120 Wien 12
 Tel. (+43 222) 813 56 28
 Fax (+43 222) 83 24 26

Schlumberger Technologies

Victoria Road, Farnborough
 GB-Hampshire GU14 7 RW
 Tel. (+44 252) 376 666
 Fax (+44 252) 543 854

Schlumberger Technologies

50, Ave Jean Jaurès, F-92542 Montrouge Cédex
 Tel. (+33 1) 47 46 67 00
 Fax (+33 1) 47 46 67 27

LP Instruments S.r.l.

Viale Edison, 44
 I-20090 Trezzano sul Naviglio (MI)
 Tel. (+39 2) 484 017 13
 Fax (+39 2) 484 018 52

Schlumberger Technologies

829 Middlesex Turnpike, USA-Billerica, MA 01821
 Tel. (+1 508) 671 9700
 Fax (+1 508) 671 9704

Schlumberger K.K.

2-1 Fuchinobe 2-chome, Sagami-hara-shi
 Kanagawa-ken 229, J-Tokyo
 Tel. (+81 427) 537 681, Fax (+81 427) 537 686

Schlumberger Technologies

Asia Pacific, 12 Lorong Bakur Batu # 07-07/11
 SGP-Singapore 1334
 Tel. (+65) 746 6344, Fax (+65) 747 5186

Schlumberger Technologies

Room 58 357, 191 Chang Le Road
 RC-Shanghai 200 020
 People's Republic of China
 Tel. (+86) 21 258 2582, Fax (+86) 21 471 1596

Subject to changes without notice. 4040 - 08.93

STABLOCK is a registered trademark of the Schlumberger Technologies GmbH

Printed by Kasdorf & Mayr

Installation Instruction

GENERAL

This set has been constructed and tested in conformity with DIN 57411 Part 1 / VDE 0411 Part 1, Protective Measures for Electronic Measuring Equipment, and was passed as safe before leaving our works. To maintain this condition and to ensure no hazards arise in service, the user must adhere to the information and warnings contained in these operating instructions.

If this instrument is to be operated via an autotransformer from a network with a higher voltage, it must be ensured that the base of the transformer is connected with the neutral conductor of the power supply.

The power plug may only be inserted into a socket with an earthing contact. The protection given by this must not be neutralized by an extension lead without a protective conductor.

Should the power plug be replaced with another type, please make sure that the yellow / green conductor is connected to the ground contact of the plug.

Warning: Interrupting or removing the ground cable inside or outside the set may cause the set to become a hazard. Intentionally interrupting the ground connection is not permissible.

Before switching on, ensure that the operating voltage set at the unit agrees with your power voltage.

If there is any reason for assuming that safe operation may no longer be possible, the set must be taken out of service and secured against unintentional operation.

The operating temperature range should be between +5 °C and +45 °C (+41 °F and +113 °F) ambient, the storage temperature between -25 °C and +70 °C (-13 °F and +158 °F) ambient.

POWER OPERATION

The STABILOCK 4040 can be operated with the following power voltages:

97...140 V or 180...260 V, 47 to 450 Hz

The equipment is set in the Works to 180...260 V (220 mark on voltage selector).

Adjusting power voltage:

1. Disconnect power plug
2. Lift out voltage selector on rear of set with screwdriver

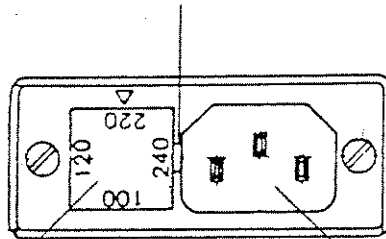

3. Fuse corresponding to power voltage:
97...140 V: T3,15/250 B (3.15 A)
180...260 V: T1,6 /250 B (1.6 A)
4. Insert voltage selector so that white arrow on selector is pointed toward the desired power voltage:
97...140 V: 100 mark on voltage selector
180...260 V: 220 mark on voltage selector
5. Re-connect power plug

Replacing powerfuse:

Sequence of operations as for altering power voltage

BATTERY OPERATION

The STABILOCK 4040 can be operated with an external battery.
The connection is on the rear panel and has its own fuse.
It is not possible to charge the battery with the STABILOCK 4040.

Battery voltage 11...32 V
Power consumption approx. 7 A at 12 V
 approx. 3,5 A at 24 V
Fuse: T16/250 E (16A)

Connection by means of:

Battery connector
reference number 300 642 (standard accessory)

SOFTWARE STATUS

Software status readout is provided in display \diamond after entering
 \square ON \square 64.

Example:

\square 5.04 — — A22

Software IEEE 488 bus
status address of the 4040

Switching off with \square RESET key.

SWITCHING ON

The unit is switched on and off with the POWER button both when operated from the power or from a battery. The LINE/BATT light diode is on if the power or battery is connected to the 4040, also when the set is switched off.

STANDBY mode is not provided since the unit achieves a frequency accuracy better than 1×10^{-7} within 15 minutes after switch-on ($T_a = 20 \text{ }^\circ\text{C}$).

EXTERNAL SYNCHRONISATION

If the accuracy of the crystal oscillator in the STABILOCK 4040 is not adequate for particular applications, pulling synchronisation is possible by an external reference signal to socket 12 on the rear of the unit:

Required signal: $f = 10 \text{ MHz}$, $\geq 0.2 \text{ V}$ into $200 \text{ } \Omega$
pulling range approx. 1×10^{-6}

CRYSTAL CORRECTION

If the STABILOCK 4040 has an excessive frequency error due to aging of the integral crystal normal, this can be adjusted by means of an adjusting potentiometer above socket 13 on the rear of the unit.

DISPLAYING BUILT-IN OPTIONS AND HARDWARE STATUS

Special ON 65: Displaying built-in options

[ON] [65] identifies built-in options. If an option is incorporated, a digit is displayed at the appropriate location of the display <1>. If the option is not found, a dash (-) appears instead.

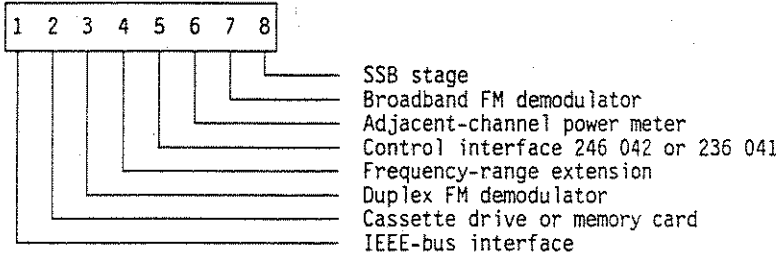

Special ON 66: Displaying hardware status

[ON] [66] shows the hardware status. This Special is important for servicing purposes or localizing functional faults (eg the new precision decade stage (digit 5) will only work with software of ≥ 5.18).

The hardware status is symbolized by a digit or a dash (-) at the appropriate place of the display <1>.

If you get in touch with a SCHLUMBERGER service station because of functional faults, you should have the values displayed here available for reference.

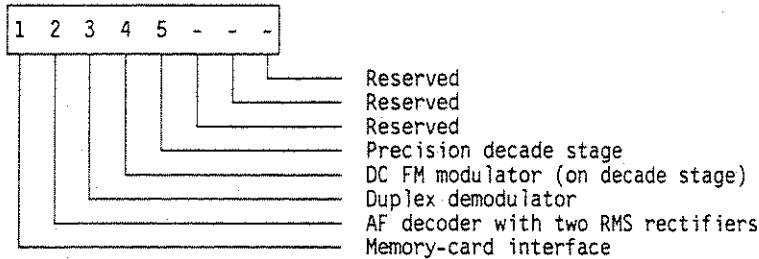

To switch display off: press RESET.

REAR PANEL CONNECTIONS

10 MHz Synchronisation Bul2

Synchronisation of internal reference oscillator

Required signal:

10 MHz, $\geq 0,2$ V into 200 Ω

Pulling range approx. 1×10^{-6} ppm

10 MHz Output Bul3

Output of internal reference oscillator

Output level approx. + 5 dBm into 50 Ω

AF Detector Bu15

This socket performs the following functions:

Insertion of an external AF filter

See SPECIAL 21, page 3-33

RX/TX Switchover by external TTL signal

Only in AUTO mode of STABLOCK 4040

RX/TX Message from STABLOCK 4040 by a TTL signal

DC Measuring inputs for polling test points

Controlled with SPECIAL 22, page 3-33

Pin occupancy Bu15:

Function	Pin
4040: max 10 Vpp, R_i 10 Ω \longrightarrow $R_i > 1$ k Ω 4040: ground	8 7
4040: max 10 Vpp, R_i 1 M Ω 4040: ground	20 21
+15 V, <10 mA, R_i 68 Ω for external filter \longrightarrow -15 V, " " " " " \longrightarrow Ground	12 25 13
RX/TX Switchover \longleftarrow RX = 1, TX = 0 RX/TX Message, RX = 1, TX = 0 \longrightarrow Ground	23 " 24
DC Measuring input 3 \longleftarrow 4 " " 5 " " 6 " " 7 " " ground " "	16 3 15 2 14 1 5 18
Notch Filter 248 076 200 - 600 Hz	10 22
Auxilliary control line (see chapter 3-33)	6

Mating plug for Bu15: Subminiature Plug Series D, DB-25 P
Reference number 300 641

Monitor Output Bu16

The monitor output enables the signal to be observed and analysed at the input of the RMS meter using an oscilloscope and AF analysers. Depending on operating modes the integral speaker and headphone outlet on the front panel are located parallel to Bu16.

See also SPECIAL 26 (page 3-37): AF Voltmeter Autorange

Monitor Signals

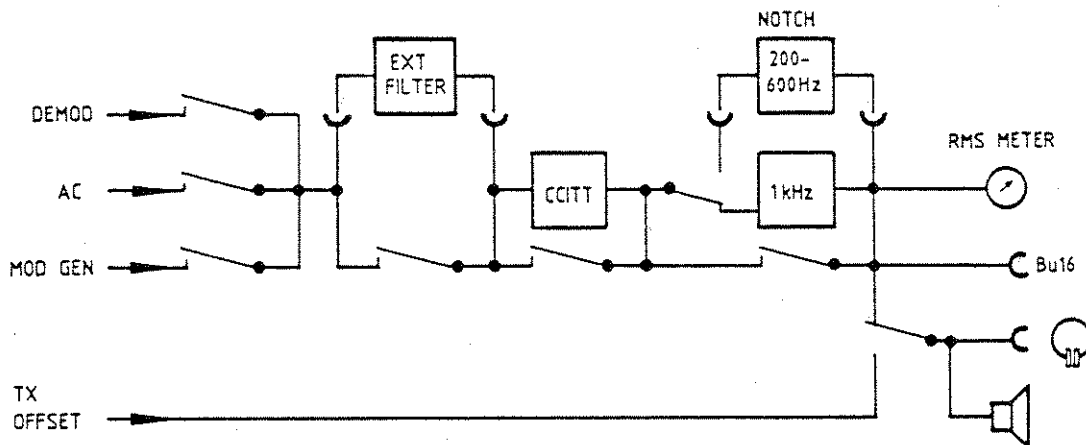

Double Modulation Bu17

See p. 3-10

Control Interface Bu18

236 041: 16 relays with OFF/ON contacts
 Relays not available with type 236 042
 Maximum permissible contact load: see data sheet

Relay control by SPECIAL 28 and 29, see page 3-39

Pin occupancy Bu18:

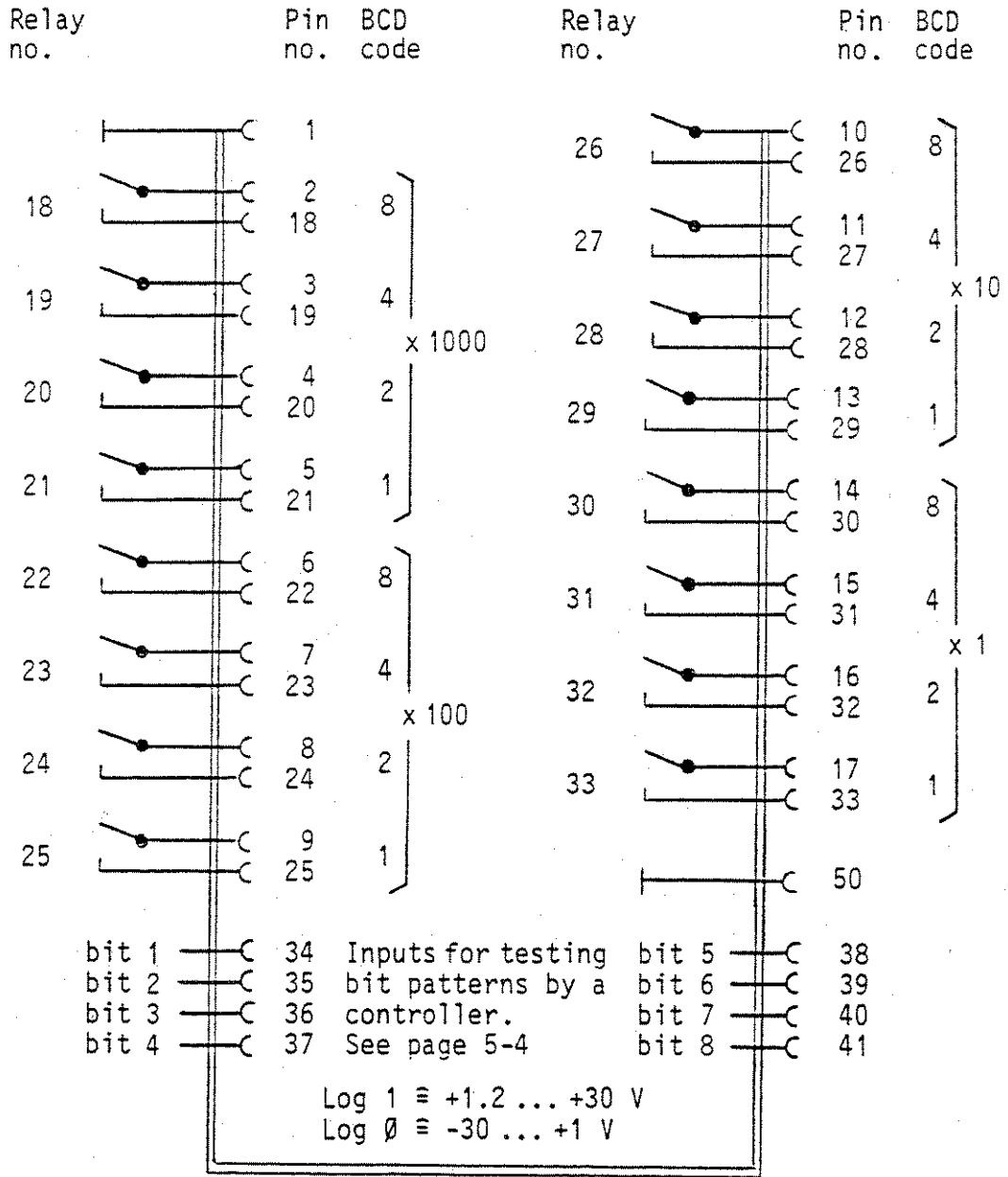

Drawing shows non-operative positions of relays

Mating plug for Bu18:

50 pin miniatur plug series D, reference no. 300 643

Control Interface Bu19

236 041: 16 relays with switchover contacts
 236 042: equipped with relays no. 02 to 05 and 17 only
 Maximum permissible contact load: see data sheet

Relay control by SPECIAL 28, see page 3-39

Pin occupancy Bu19:

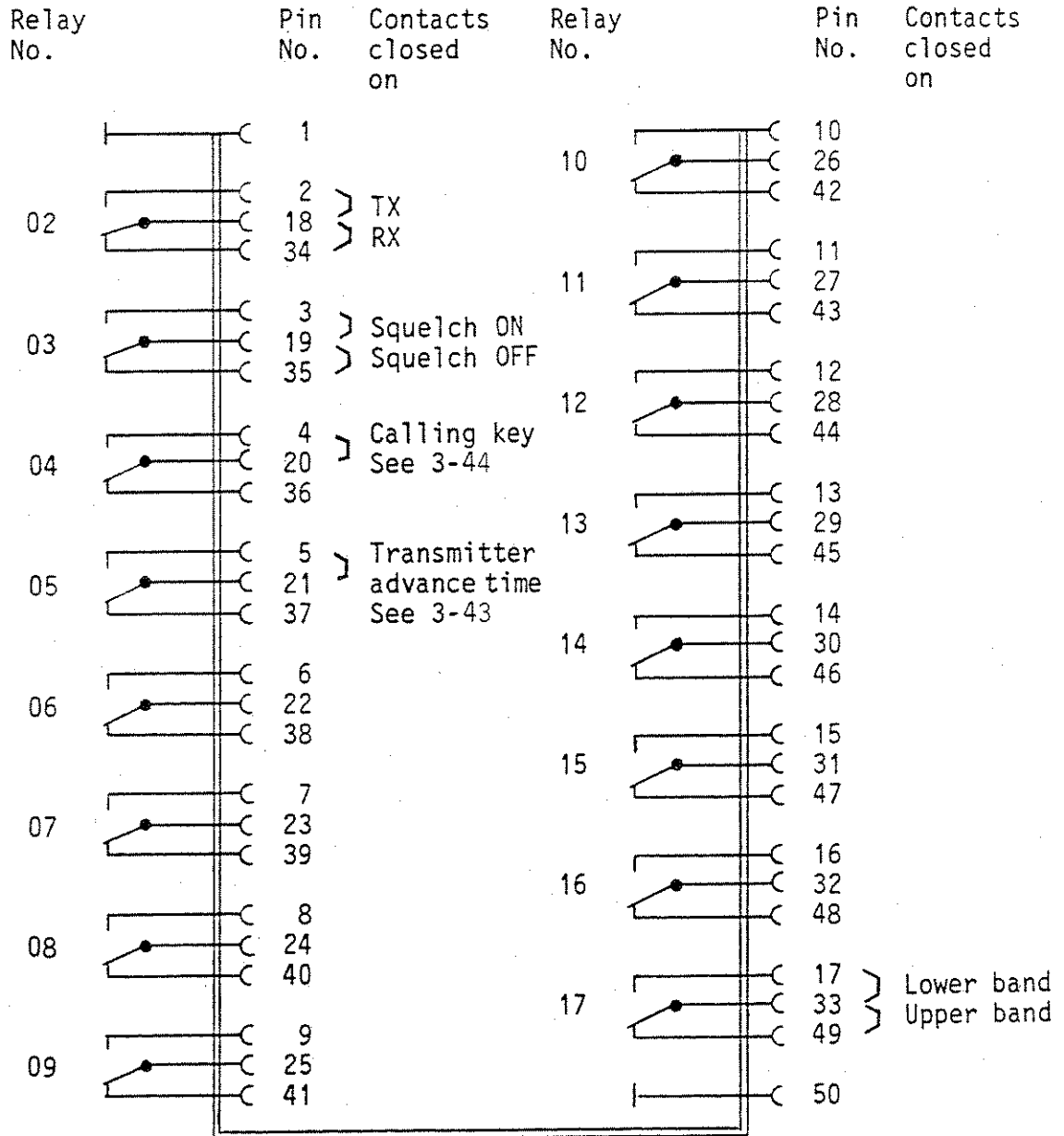

Drawing shows non-operative positions of relays

Mating plug for Bu19:

50 Pin miniature plug series D, reference no. 300 643

AM Output Bu36

DC-coupled demodulator output DC...20 kHz
DC content corresponding to carrier mean value with AM
demodulation in 4 dB steps regulated to approx. +3 to +5.5 V
100 % AM \cong 8.5 to 15.6 V peak-to-peak
With FM and \overline{M} demodulation Bu36 can be used as a linear
level output
Internal resistance 600 Ω

FM Output Bu37

DC-coupled discriminator output DC...20 kHz
Output voltage 2.8 V with 20 kHz frequency deviation
Internal resistance 600 Ω

IF Output Bu38

Linear output
IF with RF DIRECT button pressed (remote reception) 450 kHz,
Bandwidth 30 kHz
IF range through RF input (RF DIRECT off) approx. 30 kHz to 2 MHz
Output level max. 1 mW into 50 Ω

Printer Connection Bu20

Any printers with IEEE 488 interface can be used for printing out
measuring results.

The printer has to be set to LISTEN ONLY and the STABILOCK 4040
to TALK ONLY. This can be performed by means of the bus address
switch on the rear panel of the 4040.

Printer connection for instrument combination 4040 + 4922:
see 4922 operating manual, page 2-3

Wide Band FM Demod Bu40

See 3-16

Operating Instruction

SHORT FORM OPERATING INSTRUCTION

A short form operating instruction is located at the end of this manual.

CONNECTING THE TEST TRANSCEIVER

3 cable connections between the transceiver under test and the STABLOCK 4040 are usually sufficient to carry out all measurements required:

1. Cable with N plug for RF connection.
The RF socket of the 4040 can not be changed.
2. Cable with BNC plug for connecting transceiver AF input to 4040 modulation generator.
3. Cable with BNC plug for connecting the AF voltmeter of the 4040 to the transceiver AF output.

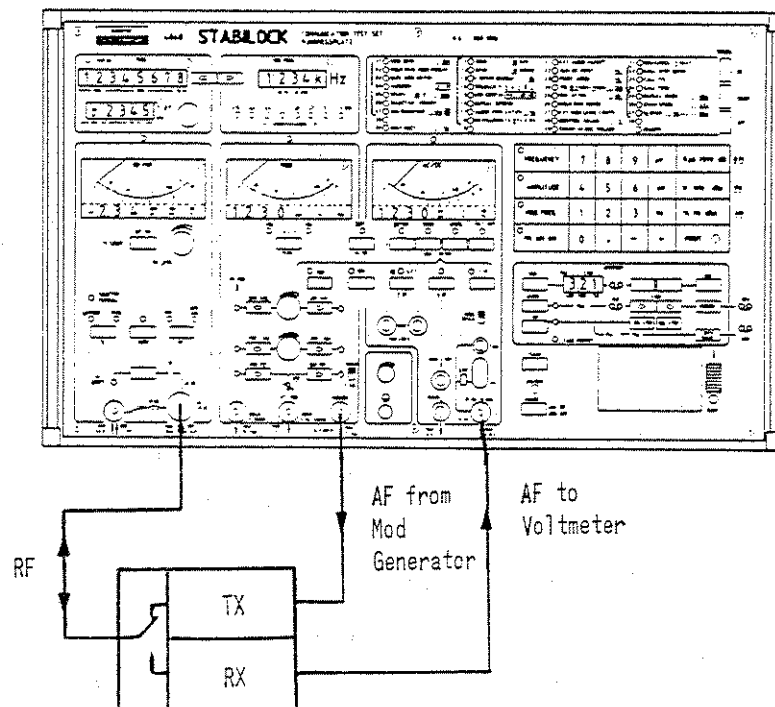

SWITCH-ON STATUS

After switching on the 4040 adapts the status existing when it was switched off.

Reset Functions

Function keys

Wrong numerical entries can be cleared by the corresponding function key.

RESET key

Used for clearing blocked entries. The modes existing before blocking are reset. The contents of the AUTOTEST memory remain preserved.

Master-clear

If all keys are locked and cannot be unlocked by depressing the reset key, the so-called Master-clear is needed. To activate the Master-clear: keep anyone key depressed and - upon depressing and releasing the RESET pushbutton - release the key again. After the beep the 4040 is reset to start-up condition:

Automatic RX/TX selection (AUTO)
Frequency 150 MHz
EMF 10 μ V
Modulation generator 1 kHz
Voltmeter to \sim AC and VOLT/AMP
CCITT filter switched off
All external filters deactivated (see 3-33)
All relays inactive (see 3-39)

The contents of the AUTOTEST memory are erased and the measuring conditions of the SPECIAL routines are reset to ex works status. Set "Concealed SPECIALs" (see 3-47) are cancelled.

Master-clear does not influence the stored selective call test parameters.

If the OFF-key is held and the RESET key is depressed and then released again, the selective-call parameters will also be set to their basic status (see 3-45).

RECEIVER MEASUREMENTS RX

Frequency Setting

The frequency is entered by the keyboard and indicated in display 1. If frequencies <0.1 and >960 MHz are entered a warning signal sounds and the previous value remains in the display. A 3fold signal sounds if the RF signal is out of synchronization.

By entering additionally a negative frequency offset, frequencies below 100 kHz can be generated (specifications valid only for frequencies above 400 kHz).

The entry has to be in MHz, decimal point included. Except with frequencies <1 MHz it is not necessary to enter previous and subsequent zeros.

Procedure:

1. FREQUENCY LED in the key lights up.
2. Enter numerical MHz value with decimal point
3. Rad MHz dB

Fine Detuning

The frequency set in 1 up to ± 99.99 kHz can be varied by knob Δf . Display in 2. Variation is also possible if the LED in the FREQUENCY key is off.

Selecting the direction of variation:

1. FREQUENCY if LED in the key is off
2. Select direction by keys + or -

Decadic Variation

Any decade of the frequency displayed in 1 can be varied by means of the + - keys. On overranging a warning signal sounds.

Procedure:

1. FREQUENCY if LED in the key is off
2. Move cursor into decade to be varied with ← →
3. Vary with + or - key
4. To switch off variation mode depress: FREQUENCY

Step Variation (channel hopping)

1. Enter step width:
Step width
in kHz
X = 0.01...99.9
2. Vary: or →
3. Switch off variation facility:

RF OUTPUT LEVEL

Set

The RF level can be set optionally in μV , mV , $\text{dB}\mu\text{V}$ or dBm with the keyboard.

The RF level with effective unit is indicated in $\diamond 4$.

Procedure:

1. **AMPLITUDE** LED in the key comes on
2. Enter numerical value with decimal point
3. Enter unit **μV**
or **mV**
or **$\text{W kHz dB}\mu$**
or **$\% \text{ Hz dBm}$** with terminal voltage (INTO 50Ω) display only

Alter unit:

1. **AMPLITUDE**
2. Depress key of desired unit

Vary and Switch Off

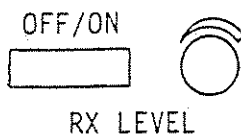

The output level displayed in $\diamond 4$ can be varied by turning the RX LEVEL knob and switched off and on again by the OFF/ON key. This can also be done if the LED in the AMPLITUDE key is off.

Terminal Voltage

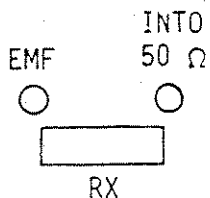

Switching over from EMF to terminal voltage and vice-versa is possible with the RX key. Independent of the load resistor applied the level display shows half of the EMF value or -6 dB respectively.

dB Addition or Subtraction

Altering of the output level displayed in \diamond by a defined dB value:

1. **AMPLITUDE**
2. Enter difference with sign: **+** (**-**) **DATA** **Rad MHz dB**
3. New value displayed in \diamond

RF DIRECT Output

The output level at RF DIRECT socket (2 V max.) is 20 dB higher than at RF socket (0.2 V max.).

Switching over between RF and RF DIRECT outputs with the RF DIRECT key. The higher level is indicated in \diamond if the LED RF DIRECT is on.

Caution: the RF DIRECT socket is not protected against overload. The maximum permissible load at the RF DIRECT socket is <1.5 V

2nd Signal Generator, Spectrum Analyser

The 4040 features an integral RF junction for connection of a 2nd signal generator for two signal receiver measurements or for connection of a spectrum analyser or other devices on transmitter measurements.

By the RF junction the signals from the signal generator or to the spectrum analyser are attenuated by 20 dB.

The RF DIRECT LED has to be off.

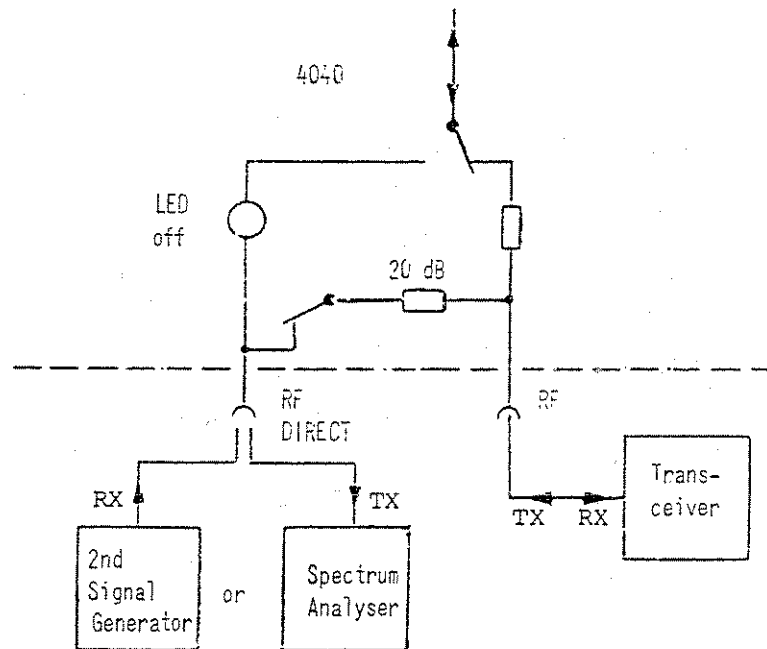

SETTING MODULATION

Internal Modulation

The 4040 provides two internal modulation generators the signals of which can be superimposed (see: 3-10).

The generator designated MOD VAR has a continuous frequency range from 30 Hz to 30 kHz or 8 fixed frequencies alternatively.

The second modulation generator generates 1 kHz with very low distortion.

Procedure:

1. Select modulation generator by MOD VAR or MOD 1 kHz keys. Switch off with same keys.

The MOD VAR generator is also switched on by depressing the key.

2. Set modulation frequency:

or

Fixed frequencies:

Back to DATA entry: ...

Modulation frequency indication by 8 LEDs in or as numerical value after pressing the key.

3. Set modulation:

for FM or

" " " AM "

" " " φM

Modulation indication in .

Vary modulation

By knobs MOD VAR or MOD 1 kHz. This is also possible when the LED in the FM AM φM key is off.

Vary modulation frequency

1. Define decade to be varied in :

2. Vary by or

3. Switch off variation facility:

External Modulation

Without setting facility

Modulation sensitivity at EXT MOD input (600 Ω) on the front panel:
0.1 V peak \equiv 2.5 kHz FM, 10 % AM or 1.00 rad Φ M

Switch on and off with the MOD EXT  key

Select type of modulation:

<input type="checkbox"/> AM	<input type="checkbox"/> FM	<input type="checkbox"/> Φ M	<input type="checkbox"/> W	<input type="checkbox"/> kHz	<input type="checkbox"/> dB μ	for FM, display in	<input type="checkbox"/> 5
			<input type="checkbox"/> %	<input type="checkbox"/> Hz	<input type="checkbox"/> dBm	" AM	" " "
			<input type="checkbox"/> Rad	<input type="checkbox"/> MHz	<input type="checkbox"/> dB	" Rad	" " "

With setting facility

Entry: CONDIT 27 0 ON 27

Then:

Set modulation with rotary knob MOD 1 kHz; display in 5.

Or:

Enter the modulation on the keypad of the 4040 or by remote control with 1 V peak on the EXT MOD socket of the 4040. For this purpose calibrate the voltage of the external generator as follows: enter a modulation value (eg frequency deviation 10 kHz) on the keypad and set the voltage of the external generator so that the entered value is displayed in 5. After this all further modulation inputs will be correct.

Switch off setting facility: OFF 27

DC-FM without setting facility (option)

The following entry produces DC coupling of the input for FM:

CONDIT 27 1 ON 27

Modulation sensitivity for DC FM: 40 mV/kHz

Switch off DC coupling: OFF 27

Caution: It is not allowed to switch off CONDIT 27 1 during TX operating mode.

Note:

The entry CONDIT 27 1 or 0 is only necessary when the operating mode is changed. After total reset CONDIT 27 is set to 0.

Superimposing Modulation

The modulation sources MOD VAR, MOD 1 kHz and MOD EXT (front panel) can be superimposed for the same type of modulation. With that e.g. testing of a receiver with subaudio squelch is possible with the MOD VAR generator set to the squelch frequency and the MOD 1 kHz generator used as test modulation.

Modulation intensity and modulation frequency have to be set separately for each modulation source while the two others are switched off.

Double Modulation

By a signal applied to Bu17 at the rear panel of the 4040 following modulation combinations are possible. The type of modulation at Bu17 is determined by selection of the type of internal modulation.

Internal Modulation	Modulation at Bu17
AM	FM
FM	AM
FM	AM

The internal modulation can be composed of MOD VAR, MOD 1 kHz and MOD EXT (front panel).

Modulation sensitivity at Bu17:

10 V peak into 600 Ω \approx 20 kHz FM or 100 % AM

Modulation frequency range as for internal modulation

TRANSMITTER MEASUREMENTS TX

Frequency OFFSET Measurement

Measuring frequency offset of a transmitter signal at the RF socket to the nominal transmitter frequency set in 1. The beat frequency can also be monitored by the integral loudspeaker of the 4040.

Procedure:

1. Enter nominal frequency: FREQUENCY data Rad MHz dB
2. Offset frequency display with sign: 2
----- appears if offset >100 kHz or signal too weak

3. Monitoring: Press the VDC key and adjust volume

The beat tone is disturbed with offset >10 kHz.

The beat tone can be switched off by pressing the VOLT/AMP key.

The specified measurement error is valid up to 30 % AM only.

Measuring error with FM modulated signals:

$$\text{Error} = \frac{\text{FM deviation}}{\pi \cdot \text{clock time} \cdot f_{\text{mod}}}, \text{ clock time} = 250 \text{ ms}$$

Example: FM deviation 2.8 kHz, f_{mod} 1 kHz

$$\text{Error} = \frac{2800}{\pi \cdot 0.25 \cdot 1000} = \pm 3.56 \text{ Hz}$$

Transmitter Frequency Measurement

The measurement is performed by a selective frequency counter requiring a search time of up to 5 seconds.

The specified measurement error is valid up to 30 % AM only.

Procedure:

Measurement at RF socket

Input level range 0.1 mW...50 W

TX or AUTO mode

TX COUNT

At RF DIRECT socket

Input level range 2...100 mV

TX mode

Switch-on RF DIRECT socket

TX COUNT

① indicates:

----- = search

--344056 previous frequency alternatively
with lines = no signal found

2567783 = frequency of the signal detected

Further measurements:
automatically on frequency
changes and power >50 mW
or with power <50 mW by
depressing TX COUNT only

Further measurements:
by depressing TX COUNT only

The measured frequency is now the reference frequency for the following TX modulation and offset measurements.

On RX measurement the signal frequency present before the TX measurement is effective again.

With ON18 set the frequency measured by TX COUNT is also effective in the RX mode.

Transmitter Power

Measurement at RF socket only

Select average or peak power indication by the TX key:

AVERAGE PEAK

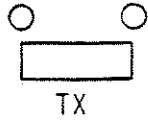

indication in \diamond in W

AVERAGE: for FM/PM transmitters.

On AM the average carrier power is indicated

PEAK: indication of envelope peak power

Frequency range 1...15 MHz

In order to provide a measuring error $< 8\%$ in this frequency range, the value read from the power meter must be multiplied with the correction factor given below:

Correction
factor

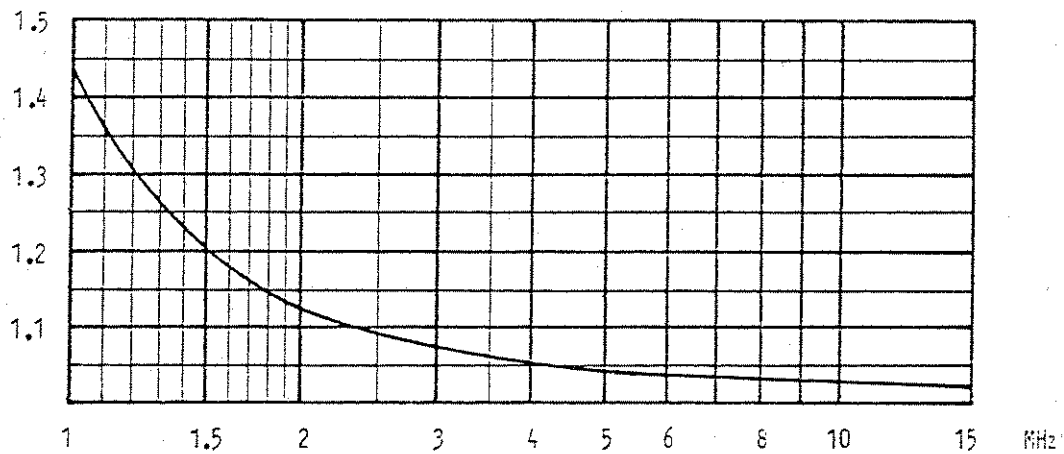

Modulation Measurement

The modulation measurement accuracy as specified on the data sheet is valid for the RF input. According to the smaller bandwidth of 30 kHz of the RF DIRECT input the result may be falsified when this socket is used. Faultless AM measurements can be performed with $f_{mod} \leq 3$ kHz only.

1. Select demodulation mode:

AM FM ϕ M W kHz dB μ for FM, display in 5
 or % Hz dBm " AM, " " "
 " Rad MHz dB " ϕ M, " " "

2. Select measurement mode by repeated depressing of the PEAK key:

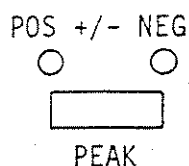

POS LED on: measurement of positive modulation

NEG LED on: measurement of negative modulation

Both LEDs off: on FM and ϕ M average of positive and negative modulation, on AM measurement of the "true AM":

$$m = \frac{A - B}{A + B} \times 100$$

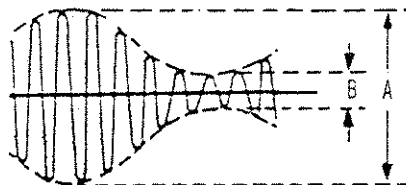

3. Monitoring modulation:

Depress the MOD key and adjust loudspeaker volume.

4. Demodulated signal:

The demodulated signal is available at sockets Bu36 and Bu37 on the rear panel (see page 2-10) and at the MOD socket on the front panel. It can be used for observing transient responses or for selective call evaluation and so on. The front panel output is DC coupled and in order to avoid faulty evaluations provided with a squelch.

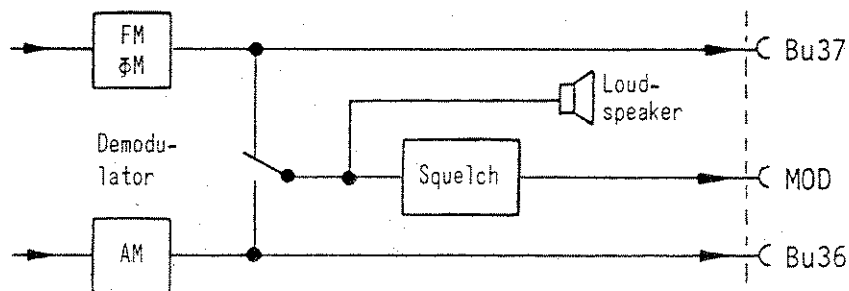

5. AM Demodulation

With AM demodulation there is automatic gain control (AGC) by the RF input attenuator. The attenuator is set in such a way that all RF input levels produce virtually the same level for the IF stage.

This process takes a certain amount of time, with the result that modulation content immediately following the connection of a signal, eg selective-call sequences, is not detected. The following operating sequence is necessary to be able to demodulate this modulation content:

Turn on the transmitter and wait until the (audible) switching processes of the input attenuator have ended.

Then enter: CONDIT 26 51 No ON 26

This holds the RF input attenuator. In any subsequent transmitter signal insertions there will be no switchover of the input attenuator.

Once the input attenuator holds, transmitter power may not be increased any further.

Turn on the automatic gain control again: OFF 26

Residual Modulation Measurement

True rms measurement of residual modulation.
Measuring bandwidth 30 Hz...30 kHz or CCITT-P53A.

Residual FM, AM or ϕ M relative to the test modulation

1. Modulate transmitter with test modulation and select demodulation mode of the 4040:

<input type="checkbox"/> FM	<input type="checkbox"/> AM	<input type="checkbox"/> ϕ M	<input type="checkbox"/> W	<input type="checkbox"/> kHz	<input type="checkbox"/> dB μ	for FM, indication in <input type="checkbox"/> 5
	<input type="checkbox"/> %	<input type="checkbox"/> Hz	<input type="checkbox"/> dBm	"	AM	" " "
	<input type="checkbox"/> Rad	<input type="checkbox"/> MHz	<input type="checkbox"/> dB	"	ϕ M	" " "

2. Test modulation indication by the AF voltmeter:

MOD VOLT/AMP indication in 6

3. Set test modulation as reference value: dB REL
4. Switch off test modulation and read off dB ratio of test modulation to residual modulation from the AF voltmeter 6.
5. Demodulated signal: refer to page 3-14

Residual FM or ϕ M in Hz or mrad units

1. Transmitter unmodulated
2. Depress MOD and VOLT/AMP keys
3. Calculate residual FM or ϕ M from the voltmeter reading 6 using the following relations:

0.141 mV \equiv 1 Hz
0.707 mV \equiv 1 mrad

Wide Band FM Demodulator 229 039 (Option)

Can not be used simultaneously with the Duplex-FM Demodulator 229 051.

By using this option, FM demodulation and measurement can be performed with modulation frequencies from DC to 140 kHz if the RF input is used. At the RF DIRECT input the bandwidth is limited to 30 kHz. Further specifications: see data sheet.

The demodulated signal is available at Bu40 on the rear panel:

10 V peak EMF at 50 kHz FM deviation
Source resistance 600 Ω

MODULATION GENERATOR

Output MOD GEN

With TX mode the following signals can be fed to the MOD GEN output and can be superimposed:

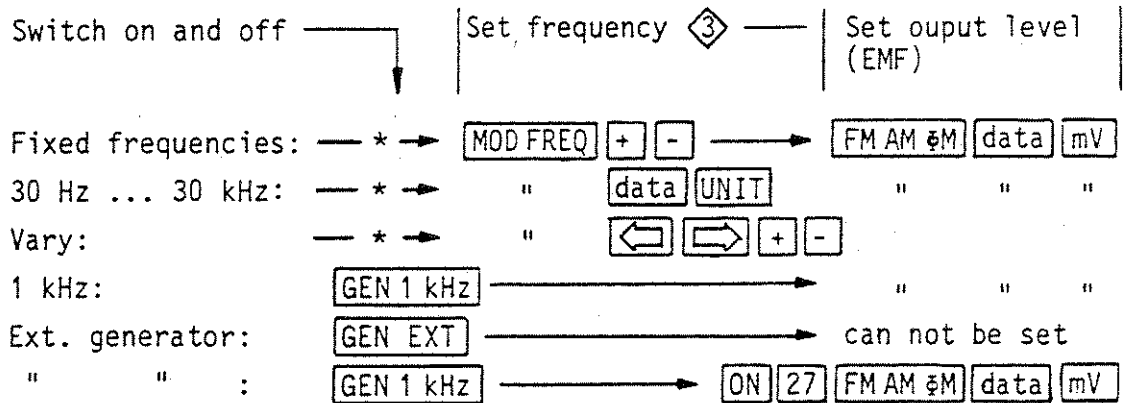

* The GEN VAR generator is switched on by depressing the MOD FREQ key. Switching off by depressing the GEN VAR key.

Modulation frequency indication after pressing the GEN key.

By means of knobs beside the corresponding keys the output level can also be varied continuously.

After setting SPECIAL 27 the level of a generator applied to the EXT MOD input can also be set through the 1 kHz path. As a result the 1 kHz modulation generator is switched off. An input of 1 V peak at the EXT MOD input (600 Ω) is required for correct level setting by the keyboard.

Upon ON 46 level and frequency of the mod generator MOD VAR can also be set in RX mode.

Amplification factor EXT MOD input —> MOD GEN output (EMF) without SPECIAL 27 = 1.

The MOD GEN output is transformer coupled (see also next page). Source resistance <5 or 600 Ω. See specifications.

Output level display: GEN VOLT/AMP —> ⑥

Not the EMF but the terminal voltage at the MOD GEN socket is displayed.

Output MOD

For some applications, the frequency response of the transformer coupled MOD GEN output may be too poor.

With RX mode the signal from the Modulation Generator is also available at the MOD socket providing a better frequency response.

Output via MOD socket with RX mode:

Frequency response ± 0.3 dB from 10 Hz to 30 kHz

Maximum available EMF 5.6 V

Source resistance 600 Ω unbalanced

EMF setting:

By setting FM as for receiver measurement, see page 3-8:

$$2.8 \text{ V} \approx 10 \text{ kHz FM or } 3.57 \frac{\text{kHz}}{\text{V}}$$

Setting resolution:

10 Hz or 2.8 mV at FM < 4 kHz

100 Hz or 28 mV at FM > 4 kHz

AC/DC METER

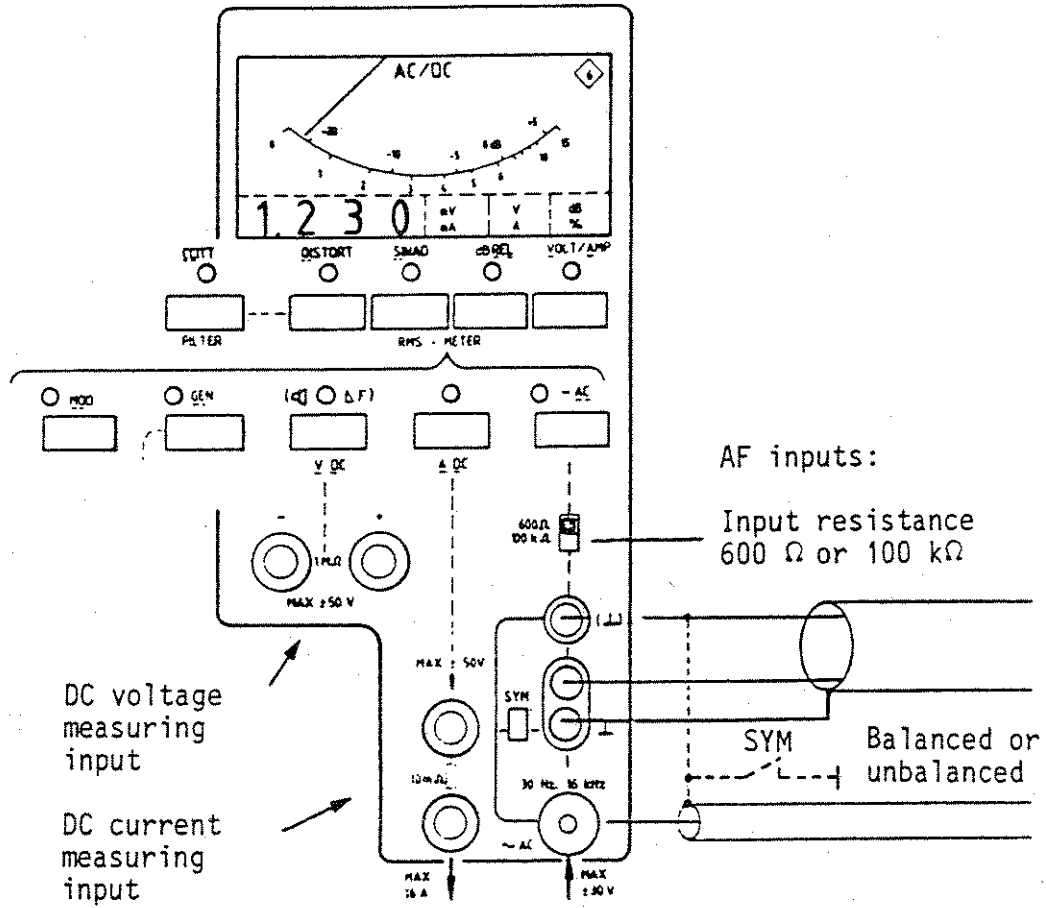

Meas. point

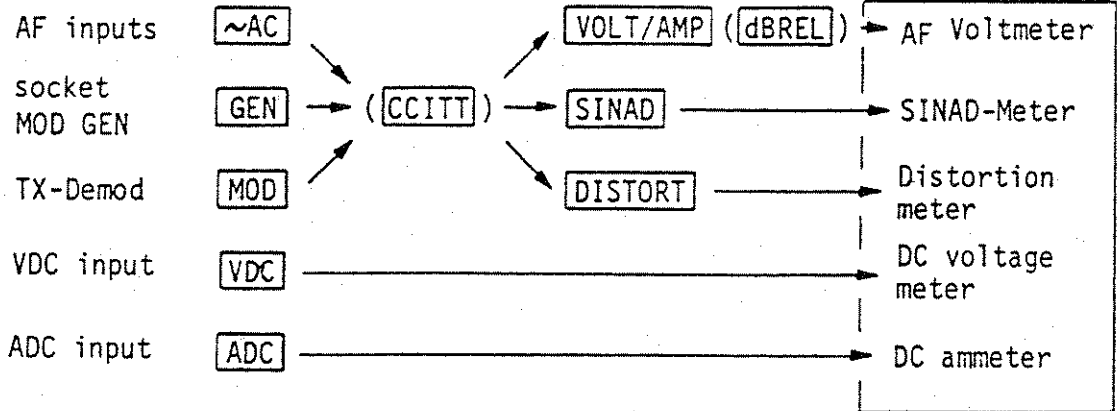

SPECIALS

General

By means of the SPECIALS transceiver test routines and special measurement modes can be called up. All SPECIALS are indicated on the front panel with the corresponding code number.

01	MOD SENS	... DIM	11	SENS	S/N .. dB	21	EXT AUDIO FILTER	31	SELF CHECK	<input checked="" type="checkbox"/> NEXT
02	HOLD PEAK MOD INDICAT		12	SENS	SINAD .. dB	22	AUX DC INPUT	32	ANSWER BACK/SYSTEM	No
03	DUPL MOD METER		13	I CENTR BANDW	.. dB	23	PRINT MODE	33	CODER	No \pm .. No No
04	HARMON	2 9	14	SQUELCH	.. No DELAY SEC	24	TOL \ominus MIN / MAX	34	DECODER	.. No No
X 05	SPUR _c	.. dB .. MHz .. MHz	X 15	EMF CONTIN	+6 -20 dB	25	PRE ATTN	35	DUPLEX SPACE	.. MHz
06	SELECTIVE POWER		16	DUPLEX DESENS	INQ-ADJ	26	HOLD RMS RANGE	36	CHAN SPACE	.. MHz
07	ADJ CHAN PWR	.. MHz \pm	17	AUDIO PWR EXTIO	.. No	27	EXT MOD LEVEL CONTR	37	CHAN	.. No .. MHz
08	FM WIDEBAND		18	RX FOLLOWS TX	\pm TX \pm RX	28	CONTROL RELAY		MEASUREMENT	
09	WAIT (SEC)	.. No	19	RX - TX FAST		29	CHANR - BCD (RELAYS)		REMOTE	

The special measurement modes can be called up and reset by ON and OFF keys in conjunction with the code number. An LED indicates that the selected function is called up. In the case of routines the LED extinguishes when the routine is over.

Measuring Conditions

Some SPECIALS, marked by one or several points on the front panel, require the presetting of measuring conditions. If no conditions are entered, the routine applies standard conditions stored in the 4040 microprocessor after it is called up by ON X (X = SPECIAL number). After being called up by

CONDIT valid conditions are shown in display **1**
 e.g. **20** -X

20 = numerical value of condition, X = SPECIAL number

The second part of multisectional conditions, e.g. 24, 37, is displayed after depressing any other random key. The condition indicated can be replaced by entering new values stored from now. After Total Reset (see page 3-2) all measuring conditions are reset to the ex works status.

SPECIALS via IEEE 488 Bus

Bus commands corresponding to the front panel operations are given in the following pages in parentheses.

IEEE 488 bus command = (-----)

01 Modulation Sensitivity

Procedure:

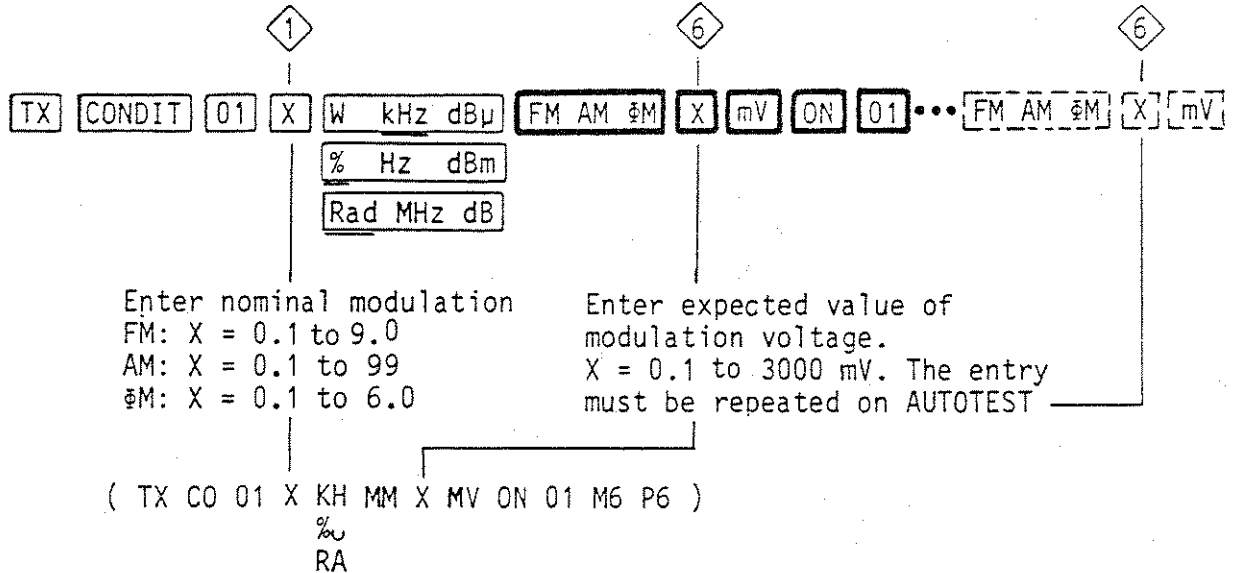

Result $\diamond 6$ = AF voltage at the microphone input of the transceiver for nominal modulation.

When the routine is recalled, the expected modulation voltage has to be entered again while the nominal modulation remains stored.

Recall: **FM AM φM X mV ON 01** (MM X MV ON 01 M6 P6)

Measurement of modulation sensitivity with the subaudio tone (eg 150 Hz) continuously present: by interconnecting 500-Hz highpass filter 248 087 (recommended extras) on Bu 15.

Insert highpass filter: **ON 21**, cut out: **OFF 21**

Test setup for high modulation sensitivity:

When determining modulation sensitivity of the order of a few mV the level resolution of the modulation generator (0.1 mV) may be too coarse. The level resolution can be increased by using a small load resistor (see following test setup). The slide switch on the generator output must be set to 600 Ω. The division factor of the arrangement is produced by ON 01 and does not have to be considered by the user (see also 3-22). This does not apply to level settings without ON 01.

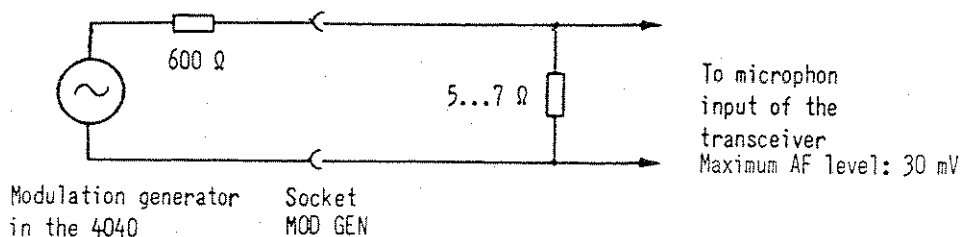

Procedure of SPECIAL 01 routine:

The routine cuts out the 1-kHz generator and turns on the variable generator. The AF millivoltmeter measures the level on output MOD GEN. The type of demodulation FM, AM or Φ M is set by CONDIT 01.

The program first determines the division factor between the entered expected value and the actual voltage on the output socket and then increases the output voltage by this division factor. This also includes range switching, so the level resolution of the modulation generator (0.1 mV) is also loaded with 6 Ω (shunt). The maximum output level in this example is 30 mV.

Then the required AF voltage for the entered nominal modulation is determined in the following manner: Proceeding from half the expected value the level is increased by 1/10 of the expected value every 250 ms until nominal modulation is exceeded. Then one step back is made. If the nominal modulation is not achieved with the maximum possible number of 12 steps, a signal sounds and the routine is aborted.

Further fine alignment is made after 300 ms with maximally 20 steps, each of 1/100 of the expected value, and with a duration of 50 ms per step. After nominal modulation is exceeded, the output voltage is measured and displayed as the result.

02 Hold Peak Modulation Indication

Switch on measurement mode: ON 02 (ON 02)

Switch off: OFF 02 (OF 02)

Note: In remote operation the peak detector is discharged by every M5 command, if ON 02 was set before.

03 Duplex FM Demodulator (option)

The Duplex FM Demodulator is tuned to transmitter frequency TX by means of SPECIAL 35 and SPECIAL 18.

Procedure:

1. Entries for SPECIAL 35 and 18: see 3-31, Frequency Transfer
2. Switch on Duplex FM Demodulator: ON 03
3. Enter receiver frequency (RX): FREQUENCY Rad MHz dB

Now all following RX frequency entries will tune the Duplex FM Demodulator automatically to corresponding TX frequencies. The modulation meter 5 indicates the modulation of the transmitter.

The Duplex FM Demodulator can also be tuned manually by the following entry, which however can not be stored on cassettes:

CO 03 X Rad MHz dB ON 03 (CO 03 X MH ON 03)

1 = TX frequency during entry
RX frequency after pressing the unit key

Switch off Duplex FM Demodulator OFF 03 (OF 03)

04 Transmitter Harmonics

Measuring ratio in dB between fundamental and selected harmonic frequency of transmitter output signal.

Maximum harmonic frequency = 960 MHz.

Transmitter unmodulated, 4040 tuned to fundamental frequency.

Procedure:

ON 04 n 4 = dB ratio (ON 04 n P4)
 3 5 6 : no reading

n = 2-9

Order number of the harmonic.

With front panel control n can be changed without entering ON 04 again.

Switch off: OFF 04 (OF 04)

Attention: Harmonic frequency measurement not possible at f = 80 MHz

05 Spurious Signals

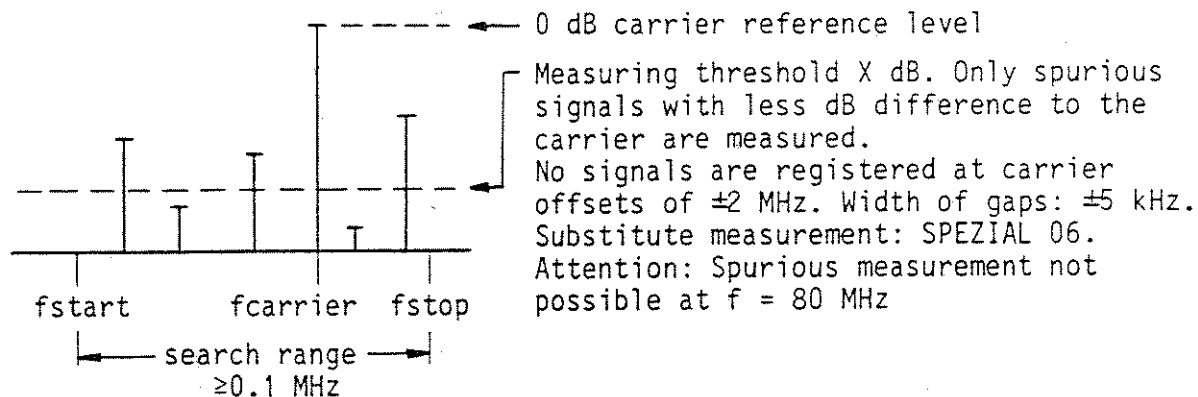

Search time: appr. 2 s for establishing the reference value on carrier frequency + appr. 9 s/MHz

Procedure:

1. Enter measuring conditions:

Measuring
threshold
X = 0...99.9 dB

Start
frequency
in MHz

Stop
frequency
in MHz

(CO 05 X DB X MH X MH)

2. Set carrier frequency with keyboard or by carrier frequency measurement (see 3-12).

3. → Continuous readout of actual search frequency

Result readout when spurious is found → dB

: no reading

Continue search: (+)

When a printer or controller is connected the frequency and level of detected spurious signals are printed out and the search continued automatically up to the stop frequency.

If harmonics are detected, these result in incorrect measurements. Only measure harmonics with SPECIAL 04.

4. Switch off routine: (OF 05)

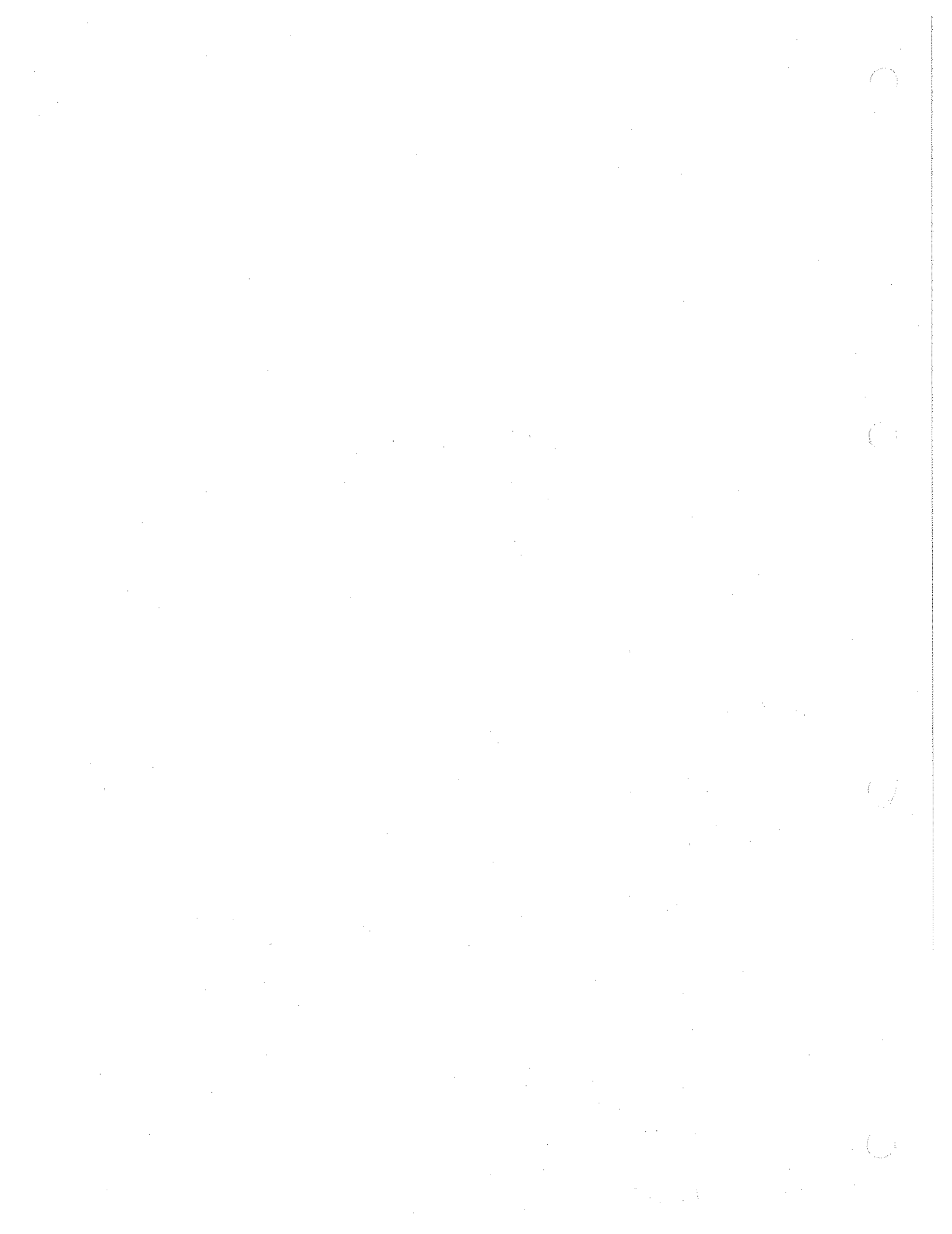

06 Selective Level Measurement

Measuring bandwidth approx. 3 kHz
 Measuring range at RF socket -70 to +47 dBm
 Measuring range at RF DIRECT -105 to 0 dBm

The volume range will decrease if a second signal with >70 dB above the measured signal is present simultaneously.

Attention: The input circuitry may be damaged by input levels >1.5 V at the RF DIRECT socket.

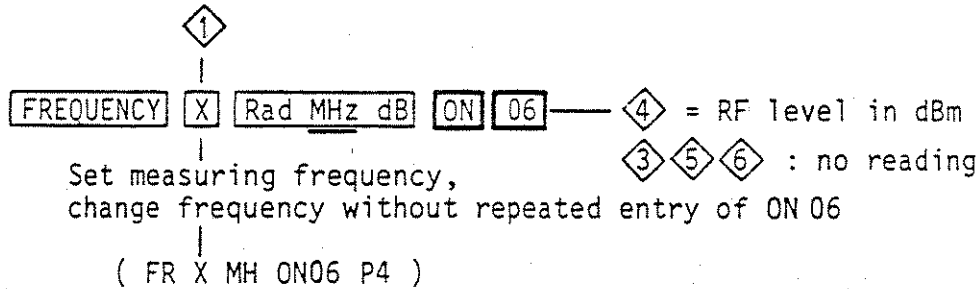

Recommended accessory for level measurements: RF Probe 860 108
 Allow for possible pre-attenuation of the RF Probe: see SPECIAL 25

Switch off level measurement mode:

Attention: Selective level measurement not possible at f = 80 MHz

07 Adjacent Channel Power

The microprocessor calculates the adjacent channel power by adding the values from a corresponding number of measurements set over the total bandwidth of the adjacent channel.

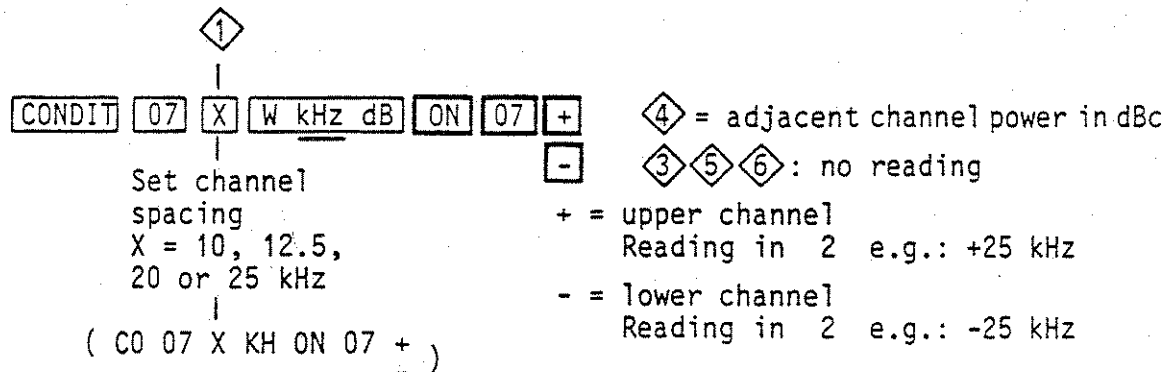

The signal from the GEN VAR and GEN EXT generator for setting transmitter modulation can be varied when SPECIAL 07 is set.

Attention: Adjacent channel measurement not possible at f = 80 MHz

Measuring ranges: see next page

For measurements on transceivers with poor adjacent-channel power ratios it is possible to shift the measuring range towards lower values by entering

CONDIT 26 71 ON 26

Measuring ranges for adjacent-channel power:

for	without SPECIAL 26	with SPECIAL 26
f < 499 MHz	-40 to -80 dBc	-18 to -60 dBc
f ≥ 499 MHz	-40 to -76 dBc	-18 to -60 dBc
		usable from -15 dBc

08 Wide Band FM in Receiver Measurement Mode RX

Switch on: ON 08 (ON 08) Switch off: OFF 08 (OF 08)

Frequency range	0.4	60	120	250	500	960 MHz
Max. int. FM deviation	80	20	40	80	80	kHz
Max. ext. FM deviation	80	20	40	80	160	kHz

Input level for maximum FM deviation at socket EXTMOD: 0.8 V peak

09 Waiting Times

Entry of waiting times on AUTOTEST (see chapter 4) required for the building up period of test objects. When waiting time is set, the next measuring step follows automatically.

Entry:



 CONDIT 09 X No. ON 09 (CO 09 X NO ON 09)

Waiting time in seconds
X = 0.1 to 9.9

Switch off waiting time: OFF 09 (OF 09)

11 Sensitivity (S+N)/N

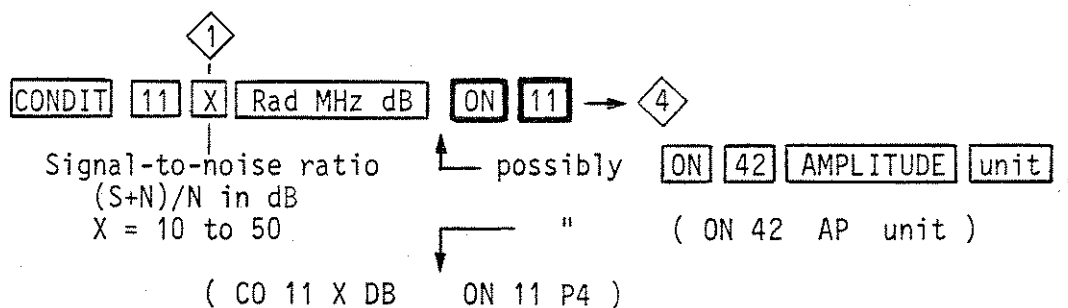

4 = EMF for the given signal-to-noise ratio in μV .
 Another unit can be selected for EMF with ON 42.

Procedure of SPECIAL 11 and 12 routines:

The routine selects the operating modes AC and dBREL (SINAD in SPECIAL 12) for the AC/DC voltmeter and turns on test modulation from the 1-kHz generator. SPECIAL 17 is cut out.

The routine, proceeding from -76 dBm, alters the RF input level for the receiver with continuously decreasing step width (successive approximation) until the given signal-to-noise ratio (S+N)/N or (S+N+D)/(N+D) is reached. In SPECIAL 11 the modulation is turned on and off with each step.

Step width: + or - $\frac{25.6 \text{ dB}}{n}$ $n = 1, 2, 4, 8, 16, 32, \text{ etc}$

Duration per step: 100 ms

Alignment tolerance ON 11: $\leq \pm 0.5 \text{ dB}$

Alignment tolerance ON 12: $\leq \pm 0.8 \text{ dB}$

The measured value is output in μV . If unit dBm or dB μV is wished, this must be entered by ON 42 before calling up the routine.

If no alignment is possible, ----- will appear on the AC/DC display 6. The modulation generators and the external modulation generator - if set before - are reactivated after the routine has stopped.

12 Sensitivity SINAD

The procedure is as with SPECIAL 11 with statement of the SINAD ratio.

$$\text{SINAD} = \frac{S+N+D}{N+D}$$

S = signal

N = noise

D = distortion

13 Bandwidth and Center Frequency Error

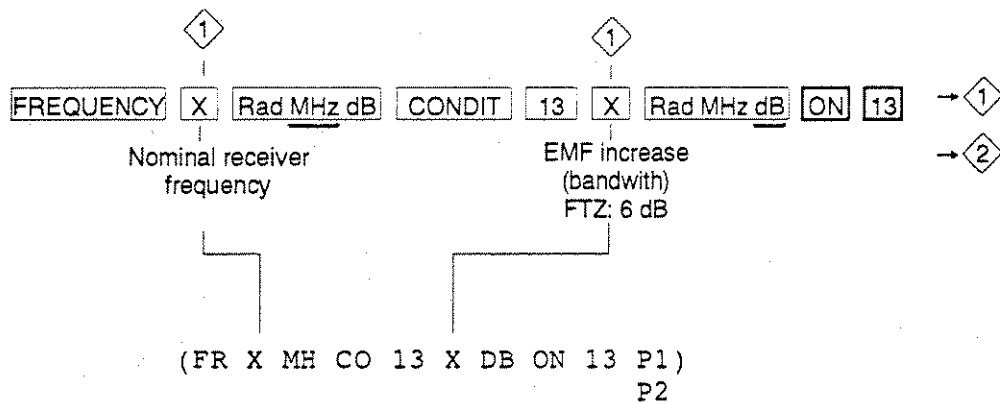

Result $\diamond 1$ = Bandwidth, $\diamond 2$ = center frequency error

Procedure of SPECIAL 13 routine:

The routine turns off the modulation and RF level and switches the AC/DC voltmeter to -AC.

After 100 ms the fundamental noise of the receiver is measured and set with dBREL as a reference value. Then the RF level is turned on and, proceeding from -76 dBm, altered in continuously decreasing steps until 10 dB (20 dB) noise rejection is reached. If no alignment is possible, the routine is aborted.

Step width: + or - $\frac{25,6dB}{n}$ $n = 1, 2, 4, 8, 16\dots$

Duration per step: 50 ms
Alignment tolerance: <1 dB

Then the RF level is increased by the value entered by COND13, the nominal receiver frequency set on the 4040 is reduced by 12,24kHz and alignment is made from there in continuously decreasing steps until 10 dB (20 dB) noise rejection is again achieved.

Step width: + or - $\frac{5,12kHz}{n}$ $n = 1, 2, 4, 8, 16\dots$

Duration per step: 100 ms

The upper bandwidth point is determined in the same way, proceeding from an offset of +12,24 kHz. From these two reference points the routine computes the bandwidth and the center frequency error.

When the routine has run, previously set modulation generators are turned on again and frequency offset is set zero.

Altering noise suppression:

The noise suppression (10 dB or 20 dB) is set upon entering the bandwidth.

Entries 80 dB for COND 13 produce noise suppression of 20dB. The dB values of the IF bandwidth are then given by: entry - 80

Entries 80 dB produce noise suppression of 10dB. The dB values of the IF bandwidth are the same as the entry from COND 13.

14 Squelch Level

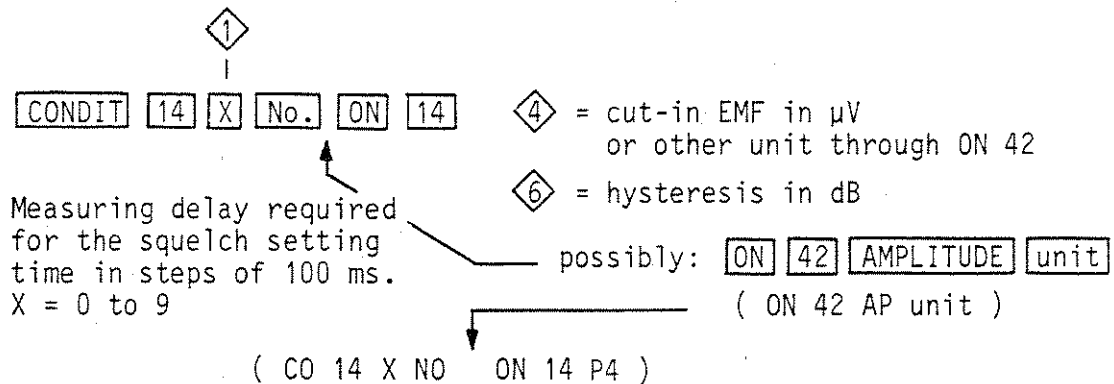

Cut-in EMF: clears the AF path.

If the cut-out EMF (blocks the AF path) is desired instead of the cut-in EMF the routine has to be called up as follows:

ON 41 ON 14 (ON 41 ON 14)

ON 41 remains! Switching off by OFF 41 (OF 41)

Procedure of SPECIAL 14 routine:

The routine cuts in the squelch relay (relay 03, page 2-9) and sets the RF output level to -80 dBm. The test modulation comes from the 1-kHz generator.

The AC/DC voltmeter is switched to \sim AC.

After a waiting time of CONDIT 14 x 100 ms x 2 the AF level of the receiver is measured and set with dBREL as a reference value.

Then the routine reduces the RF level in 5-dB increments until the squelch disconnects the AF path (>20 dB attenuation).



Duration per step: CONDIT 14 x 100 ms. If no squelch response point is found, the routine is aborted.

The RF level is then again increased by 15 dB and after a waiting time of CONDIT 14 x 100 ms x 2 reduced in 1-dB increments until the squelch again disconnects the AF path. This level reduction occurs without interruption by SPECIAL 15.

Duration per step: CONDIT 14 x 100 ms

The final fine alignment of the cutout point is made in 0.2-dB previously determined.

To determine the hysteresis the RF level is then increased in 0.2-dB increments (max. 50) until the AF path again connects through.

When the routine has run, the squelch relay and SPECIAL 15 are cut out and previously set modulation generators are turned on again. The AC/DC voltmeter remains disabled until the  key is pressed in AUTORUN, until PRINT , or until a key on the voltmeter is pressed.

15 Interruption Free Level Range

Operating mode for interruption free setting of the RF output level.

Switch on:

ON 15 → **4** Digital display = reference level (ON 15)
 → **4** Meter reading = setting range

Set interruption free output level by knob RF LEVEL: 

or by keyboard entry: **AMPLITUDE X Rad MHz dB** (AP X DB)

Setting range
 X = -20.0 to +6.0 dB

Change reference level: **AMPLITUDE X unit**

Unit = dB μ V, μ V or mV. After entering a new reference level, the pointer in **4** is positioned at 0 dB. Alteration of the unit without entering a numerical value is not possible.

With SPECIAL 15 ON amplitude modulation with limited specifications also can be set at EMF >0.1 V (RF output) or >1 V (RF DIRECT).

Switch off interruption free level range: **OFF 15** (OF 15)

16 Duplex Desensitisation and Duplex Filter Adjustment

Routine for determining the reduction of receiver sensitivity caused by the transmitter output power in the duplex channel.

4 = Sensitivity
 ↓
RX ON 11 — **CONDIT 160** — switch on — **ON 16** → **6** = Desensitisation in dB
 transmitter

(RX ON 11 CO 160 — switch on — ON 16 P6)
 transmitter

Duplex Filter Adjustment:

CONDIT 161 - TX on - **ON 16** → **4** = TX power displayed on analogue meter
 RX-RF level digitally displayed

CONDIT 162 - TX on - **ON 16** → **4** = TX power digitally displayed
 RX-RF level displayed on analogue meter

Automatic switching-on of the transmitter: see 2-9

17 AF Power

Terminate AF output of the receiver with nominal load.
 The 4040 calculates the AF power from the voltage measured and the resistance value entered by keyboard.
 Select the 100 k Ω input resistance of the AD/DC Voltmeter (\sim AC).

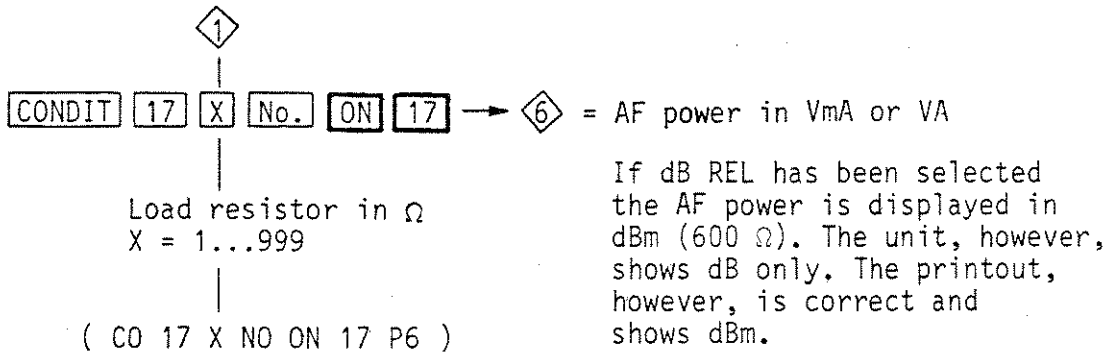

18 Frequency Transfer

With SPECIAL 18 the frequency set in RX mode is also effective in TX mode and vice-versa. Duplex offset is taken into account. In conjunction with TX COUNT (page 3-12) the set can be automatically tuned to the transmitter frequency of the transceiver.

Entry with simplex:

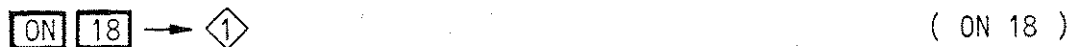

1 = measured transmitter frequency. For all following TX and RX measurements the transmitter frequency will be automatically the reference frequency.

Entry with duplex:

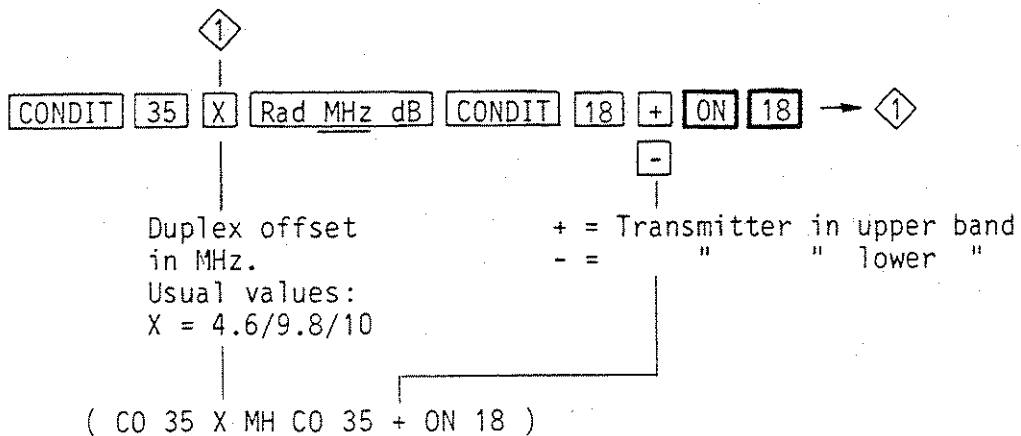

Switch off operating mode: OFF 18 (OF 18)

19 Fast RX/TX Switching Over

This operating mode provides fast switching-over from RX to TX measurement mode of the 4040 for receipt call measurement if an external Selective Call Coder/Decoder is used.

The RF output level of the 4040 is fixed to -60 dBm.
The switch-over of the 4040 caused by the output power of the transceiver is performed in less than 10 ms.

Procedure:

1. Set frequencies separately for RX and TX duplex transceivers
2. Select the RX mode (RX)
3. Feed the call to be transmitted into the EXT MOD socket and set modulation
4. ON 19 (ON 19)
5. Release the call. When the transmitter replies, the demodulated transmitter signal will be available within <10 ms at the MOD socket or at Bu37 (DC coupled) on the rear panel of the 4040
6. The 4040 has to be prepared by ON 19 for each measurement (ON 19)

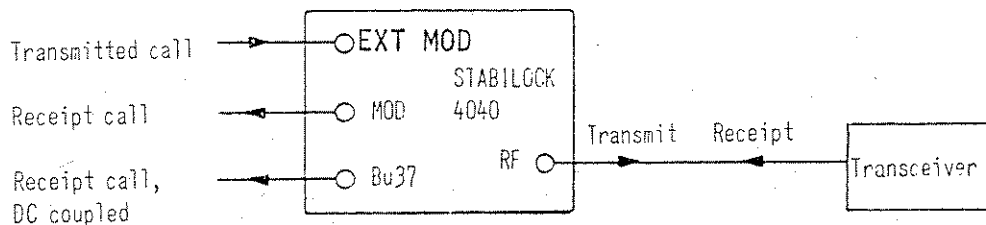

21 External filters, distortion measurement

Up to three external filters (see datasheet, "options and accessories") may be plugged on top of each other into socket 15 at rear panel. For pin configuration of socket 15 see page 2-6.

These filters are inserted into the low frequency path of the 4040 and allow distortion measurements on frequencies other than 1 kHz or to suppress specific low frequency ranges. The below procedure is used to activate the filters:

CONDIT 21 X No. ON 21 (CO 21 X NO ON 21)

Function of command (X)

- X = 0 = Resets function CONDIT-21
- 1 = Inserts distortion measuring filter (range 200 to 600 Hz)
- 2 = Inserts either the 4-kHz bandpass, the 300-Hz highpass or the 500-Hz lowpass filter
- 4 = Cancels the 300-Hz highpass filter (control line pin 5 of socket 15 = "H")
- 8 = 1 kHz distortion measurement without built-in 2-kHz highpass

Resetting CONDIT-21 function: OFF 21 (OF 21)

Starting again of CONDIT-21 function: ON 21 (ON 21)

Measuring distortion in the range 200 Hz to 600 Hz: Select external distortion measuring filter and then depress pushbutton DISTORT.

If however one filter only is plugged into socket 15 it can quickly be activated by ON 21, respectively deactivated by OFF 21. For this X has to be set 0. Distortion measurement with the external filter, the filter has to be selected first (ON 21) followed by the pushbutton DISTORT.

If two or three filters are plugged into socket 15 following values for X are to be used to select the individual filters. Maximum two filters can be selected at a time.

Note: At first the distortion measuring filter (F1) is to be plugged in when additional filters have to be added.

Two filters 1)			Two filters 2)			Three filters 2)			
X	F1	F2	X	F2	F3	X	F1	F2	F3
2	off	on	2	on	off	2	off	on	off
1	on	off	4	off	off	1	on	off	off
3	on	on	6	off	on	3	on	on	off
4	off	off				4	off	off	off
						6	off	off	on
						7	on	off	on

1) F1 = Distortion measuring filter
F2 = 4-kHz BP or 300-Hz LP or 500-Hz HP or 300-Hz HP

2) F1 = Distortion measuring filter
F2 = 300-Hz HP
F3 = 4-kHz BP or 300-Hz LP or 500-Hz HP

If the built-in 2-kHz highpass, used for 1-kHz distortion measurement, is deactivated distortion measuring results are equivalent to the SINAD results. The distortion measuring results, however, do not exactly correspond anymore with the definition of distortion.

To use the control line (pin 6/socket(BU)15) of equipment with a serial number below 1525001, in general the hardware needs modification. In such case, please contact your nearest Schlumberger-repair centre for modification.

Master-clear (see 3-2) resets all CONDIT-21 settings (X = 0)

22. DC Measuring Inputs

Connection of 5 DC measuring inputs to the DC voltmeter of the 4040.

Measuring range 0 to +5 V

Resolution 5 mV

Maximum permissible input ± 20 V

Selection of input:

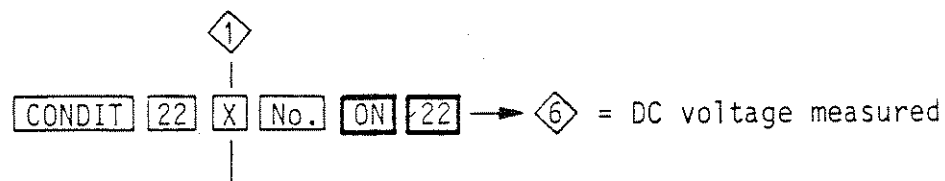

X = 3 = pin 16 of Bu15 on the 4040 rear panel

4 3

5 15

6 2

7 14

Ground: pins 1, 5, 18

Input commands via desk-top calculator: Fast measurements: "ON40DC"
 Cycle time needed for one single measurement with HP 9825: approx. 25 ms
 Input format: wrt722;"M6P6"
 red722;A\$
 dsp A\$

In order to save time the result output is shortened by 10 spaces.

23 Printout Mode

If on AUTOTEST only the print command **PRINT** \diamond **Y** is entered for the particular measuring step (see p. 4-5), the result is printed out with unit but without any further comment.

Further printout modes can be selected with SPECIAL 23:

CONDIT 23 X No. ON 23 PRINT \diamond **Y** (CO 23 X ON 23)

Printout:

- X = 0 Without comment, ----- all results
- 1 " " , ----- if out of limit only
- 2 With result field no. P \diamond , all results
- 3 " " " " " , if out of limit only
- 4 With Text (see page 4-10) , all results
- 5 " " " " , if out of limit only
- 9 Program will stop at out of limit

Note: no display of X = 0

Entry of tolerances: see 3-35

If tolerances are exceeded, >>>> or <<<< is printed beside the result.

24 Entering Tolerance Limits

Entry of tolerance limits for the results $\diamond Y = 1$ to 6 as a criterion for the print out mode (see SPECIAL 23).
On AUTOTEST the tolerances must be entered separately for each step.

Entry:

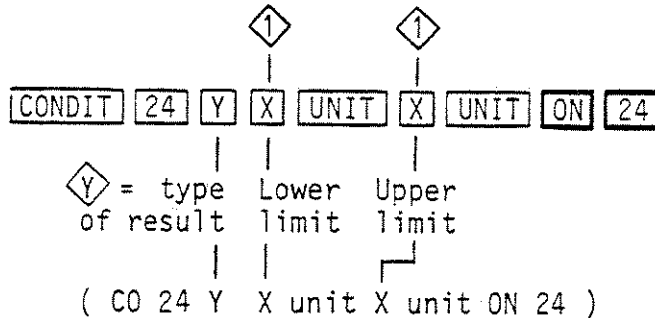

The entry is independent of the set operating mode and valid for the specified unit only. Tolerance comparison is not possible if the sign changes. Tolerance entries can be made for the following results:

Y	Result	Unit by keyboard	Unit via IEEE bus
②	Frequency offset	kHz	(KH)
③	AF frequency	kHz, Hz	(KH, HZ)
④	Transm. power	W	(W _U)
	RF level	μV, mV, dBμV, dBm	(UV, MV, DU, DM)
⑤	Modulation	kHz, %, rad	(KH, % _U , RA)
⑥	AF level	mV, V (SINAD), dBREL	(MV, V _U , RL)
	Distortion	%	(% _U)
	DC voltage	mV, V (SINAD)	(MV, V _U) *
	DC current	mA (dBREL), A (VOLT/AMP)	(MA, A _U)
	SINAD	dB	(DB)
	AF power	mW (DISTORT), W	(mW, W _U)

Double function keys:

DISTORT	SINAD	dBREL	VOLT/AMP
mW	V	mA	A

* Tolerance limits below 1 V have to be entered with mV units, >1 V with the V unit.

25 RF Preattenuation

With SPECIAL 25 allowance is made for the attenuation of a power adapter (eg 4911, 250 W, oder no. 103 601) or of a RF probe (860 108) by the power meter anf the RF level meter.

Allow for preattenuation:

◇ 1
|
CONDIT 25 X Rad MHz dB ON 25

dB preattenuation
X = 0.1 to 99.9

|
(CO 25 X DB ON 25)

Switch off allowance: OFF 25

(OF 25)

26 00 Disconnect Autorange

CONDIT 26 00 No. ON 26

(CO 26 00 NO ON 26)

This entry will disconnect the autorange of the AC/DC meter to avoid any measuring interference caused by range switching. The momentary amplification setting is frozen. This enables, for instance, observation of the demodulated transmitter signal without interruption on socket MOD or on Bu16 on the rear of the instrument.

After switchover of the signal sources VAC, VDC, etc or of the measuring modes VOLT/AMP, dBREL, SINAD and DISTORT, the "Disconnected autorange" function must be reactivated by the following entry:

OFF 26 ON 26

(OF 26 ON 26)

Return to autorange: OFF 26

(OF 26)

26 XY Preselect Analog Meter Range

CONDIT 26 XY No. ON 26

(CO 26 XY NO ON 26)

This entry avoids the jumping about of the pointer caused by the autorange, this being an advantage especially in adjustment work.

Preselectable analog meter ranges XY: see next page.

If the measured value is more than the end value of the selected meter range, the meter will go to full scale, and if it is below the beginning of the range, the meter goes to 1/10 of full scale.

Return to autorange for analog meter:

OFF 26

Preselectable Analog Ranges of Indication

Type of measurement	X	Y	Range
All measurement modes of AC/DC meter	0	0	Autorange disconnected (Hold range)
Transmitter power	4	1	0.00 - 0.20 W
	4	2	0.21 - 2.00 W
	4	3	2.01 - 20.0 W
	4	4	20.1 - 200 W
	4	5	201 - 2000 W
	5	6	2001 - 9999 W
AM demodulation	5	1	The RF input attenuator is held (automatic gain control off) See 3-15
ADC	6	1	0 - 150 mA
	6	2	151 - 1500 mA
	6	3	1510 mA - 15.0 A
	6	4	15.1 - 20.0 A
VDC	6	1	0 - 150 mV
	6	2	151 - 1.50 mV
	6	3	1.51 mV - 1.50 V
	6	4	15.1 - 50.0 V
DISTORT	6	1	0.0 - 15.0 %
	6	2	15.1 - 100.0 %
MOD, GEN	6	1	0.0 - 15.0 mV
	6	2	15.1 - 150 mV
	6	3	151 mV - 1.50 V
	6	4	1.51 - 15.0 V
~AC	6	1	0.0 - 15.0 mV
	6	2	15.1 - 150 mV
	6	3	151 mV - 1.50 V
	6	4	1.51 - 15.0 V
	6	5	15.1 - 33.3 V
SINAD, dBREL	6	1	+86.0 - +66.1 dB
	6	2	+66.0 - +46.1 dB
	6	3	+46.0 - +26.1 dB
	6	4	+26.0 - +6.1 dB
	6	5	+6.0 - -13.9 dB
	6	6	-14.0 - -33.9 dB
	6	7	-34.0 - -53.9 dB
	6	8	-54.0 - -73.9 dB
	6	9	-74.0 - -93.9 dB
Adjacent channel power	7	1	-18 to -60 dBm See 3-26

27 External Modulation, see 3-9

28, 29 Control Interface

By SPECIAL 28 and 29 relay functions of the Control Interface can be called up. There are two groups of relays:

1. 16 relays with two-way contacts.
Connection diagram: Bu19, page 2-9.

When SPECIAL 28 is set, five of these relays are activated automatically depending on the operating modes RX/TX, squelch ON/OFF, calling key, transmitter advance time and upper/lower band. The other relays can be called up separately. The automatically activated relays can also be switched by entries via SPECIAL 28, the automatic action however becomes effective again when the next change over occurs (not after ON 51).

2. 16 relays with on-off contacts.
Connection diagram: Bu18, page 2-8

These relays can be called up separately or can be used for BCD code output of channel numbers according to SPECIAL 37.

Set relays:

CONDIT 28 X + X + X + (CO 28 X + X +)
 - - -

X = relay no. 02 to 33, see 2-8 and 2-9
+ = set relay
- = reset relay

Cancelling of all relays set: CONDIT 28 . (CO 28 .)

Switch relays to the operative position: ON 28

Non-operative position: OFF 28

Output of channel number: ON 28 ON 29 (ON 28 ON 29)

Reset output of channel number: OFF 29 (OF 29)

Upon Master-clear (see 3-2) all relay settings set by CONDIT 28 are reset. All relays are deactivated.

31 Selfcheck

Start selfcheck routine: ON 31 (ON 31)

Continue routine after error indication: +

If no error is found, LED 31 goes out and the frequency indication appears in display 1.

If a fault in the 4040 is determined, the unit number in which the error occurs and the kind of error are indicated in 1. The designations used in the display for the interchangeable units are also printed on the rear panels of the units, e.g. U2 for the Output Unit. If a repair is required it is important to report all errors indicated by the selfcheck routine to the service department.

The selfcheck may only be performed at frequency settings < 959.999 MHz.

Immediately after switching on the display may indicate a fault caused by the warm-up period of the test set not being finished. External signals or too low load resistances at the front panel sockets may cause wrong error messages.

With REMOTE control LED 31 goes out only with the next command.

Survey of possible fault indications: see next page.

Survey of possible faults:

Display ↕	Fault in:	Faulty:
Err U 1.1	Power Supply 204 040	Supply voltages
Err U 2.1	Output Unit 230 040	Level control ALC
Err U 3.1 .2 .3	UHF Synthesis 213 040	Oscillator Divider Osc. + Div.
Err U 4.1 .2 .3 .4 .5 .6 .7	80 MHz Spectrum 224 040	Synchronization (Sync) Spectrum oscillator Sync + Sp.Osc. Thermostat Thermost. + Sync Thermost. + Sp.Osc. Thermost. + Sp.Osc. + Sync
Err U 5.1 .2 .3 .4 .5	Decade Synth. 210 040	10 Hz Decade 100 kHz Decade 10 Hz Dec. + 100 kHz Dec. Unsync >0.5 sec at 0.40123 MHz or 1.23456 MHz or 1.56789 MHz Unsync >0.5 sec at 0.45100 MHz
Err U 6.1 .2 .3 .4 .5	IF Unit 229 040	Counter 10 Hz resolution " 1 Hz " AM Demodulator FM Demodulator FM Demodulator/Deemphasis
Err U 7.1 .2 .3 .4 .5 .6 .7 .8 .9	Mod Generator 208 040	1 kHz Generator Frequency " " Amplifier " " Level DAC " " Distortion Variable Gen. Frequency " " Amplifier " " Level DAC " " Distortion Output amplifier
Err U11.1 .2 .3 .4 .5 .6	AF Detector 209 041	RMS Detector Notchfilter CCITT filter Pos. DC peak detector Neg. " AF level control 10+8 bit DAC
Err U13.1 .2 .4 .6 .7 .9	Attenuator 226 040	Att R1s1 (Bu RF) <Att R1s8(20 dB) " R1s2 (20 dB) ≠ " " " R1s4 " ≠ " " " R1s6 " ≠ " " " R1s7 (8 dB) > " R1s5(16 dB) or < " R1s3(4 dB) " R1s5+3(16+4dB) ≠ " R1s8(20 dB)
Err U14.1	RF Detector 229 043	Zero drift
Err U16.1 .2	Adjacent 229 042 Channel Power Meter	1 MHz Oscillator/Adj.Ch.P.Meter 1 MHz Oscillator switch

3

0

0

0

SELECTIVE CALL TEST

32 Selection of the Call System

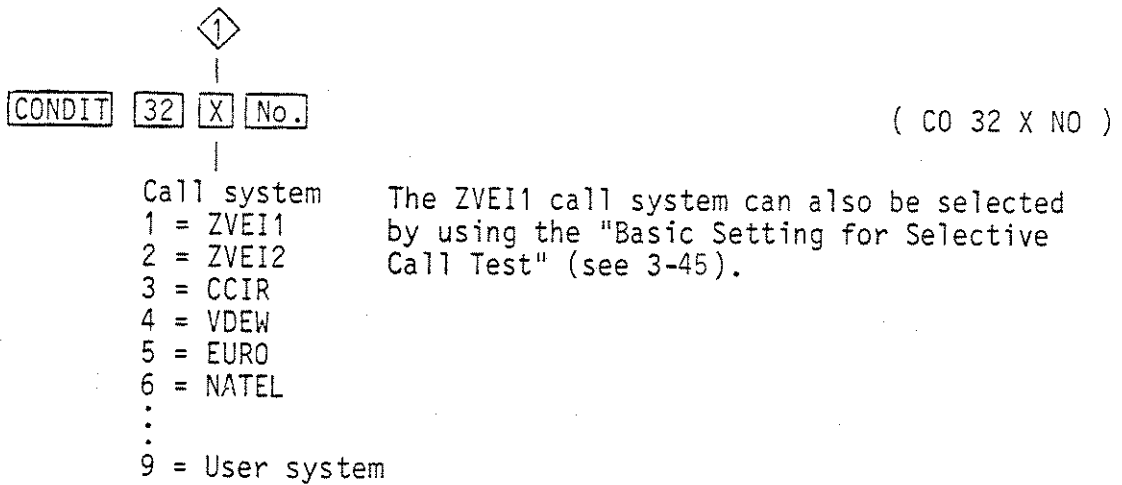

For the no. 9 system the user can allocate arbitrary tone frequencies to the tone numbers by the following entry:

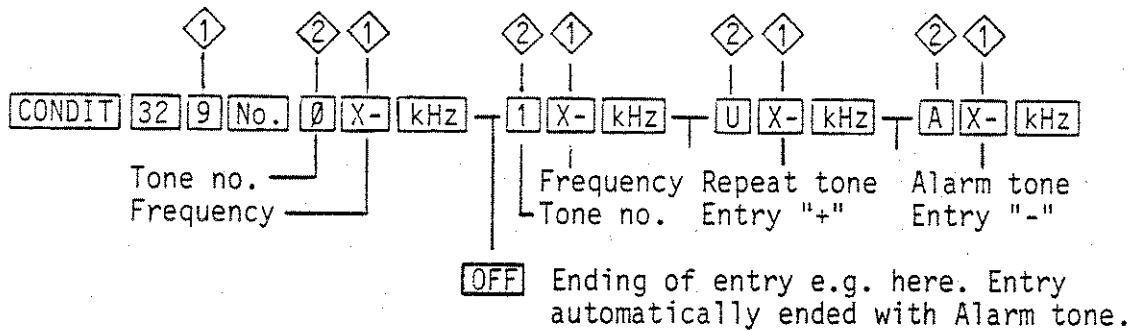

(CO 32 9 NO 0 X KH 1 X KH U X KH A X KH)
 X (Ending of entry by character X)

Frequency allocations (Hz):

Tone no.	ZVEI1	ZVEI2	CCIR	VDEW	EURO	NATEL	User
0	2400	2400	1981	2280	980	1633	
1	1060	1060	1124	370	903	631	
2	1160	1160	1197	450	833	697	
3	1270	1270	1275	550	767	770	
4	1400	1400	1358	675	707	852	
5	1530	1530	1446	825	652	941	
6	1670	1670	1540	1010	601	1040	
7	1830	1830	1640	1240	554	1209	
8	2000	2000	1747	1520	511	1336	
9	2200	2200	1860	1860	471	1477	
10 U "+"	2600	970	2110		1063	200	
11 A "-"	2800	885	2400		1153	1805	

U "+" = Repeat tone
 A "-" = Alarm tone

Rounded up or down according to 1 Hz frequency resolution of the AF generator

33 Encoder

Select the Call System (see 3-42)

Enter call tones and call tone parameters:

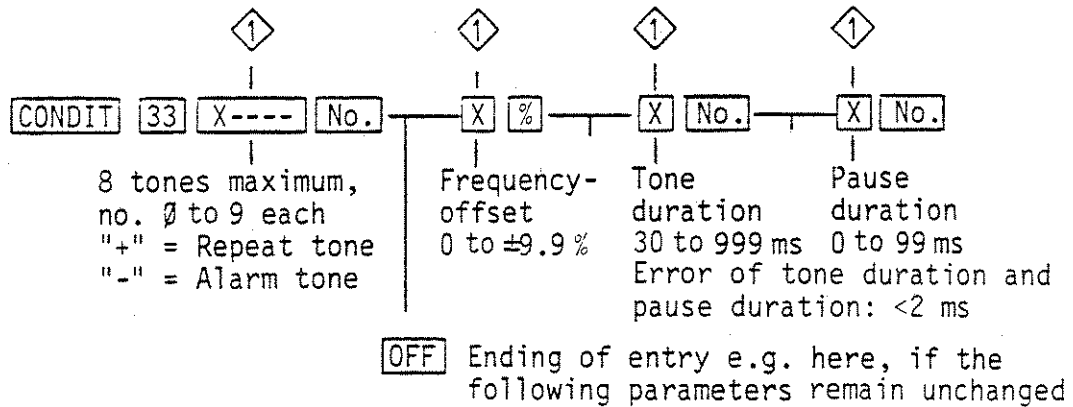

(CO 33 X NO T X % T X NO T X NO)

X (Ending of entry by character X)

The repeat tone is sent automatically when a tone is entered twice in sequence.

Tone duration extension:

By entering after one of the first four tones the duration of this tone is extended by ten.

Releasing the tone sequence:

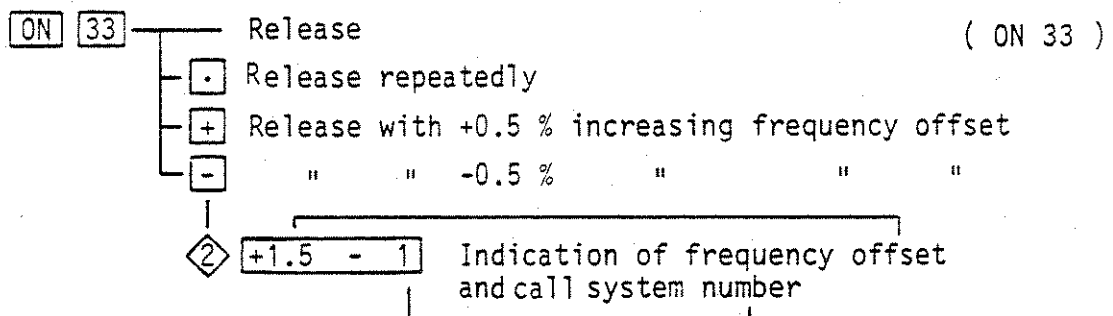

When special 33 active no other keys than , or the ones used to enter RF level and deviation must be touched. Any other key deactivates special 33. Analogue variation of RF level and deviation impossible whilst special 33 is active.

By ON 33 relay 05 of the Control Interface (see 2-9) is activated 200 ms before the first tone (transmitter advance time).

Set call tone deviation for receiver measurement:

MOD VAR FM AM Φ M value W kHz dBm → Display in

Set output level at socket MOD GEN :

GEN VAR FM AM Φ M value mV MOD → Display in

34 Decoder

Select the Call System (see 3-42)

Enter the decoder parameters:

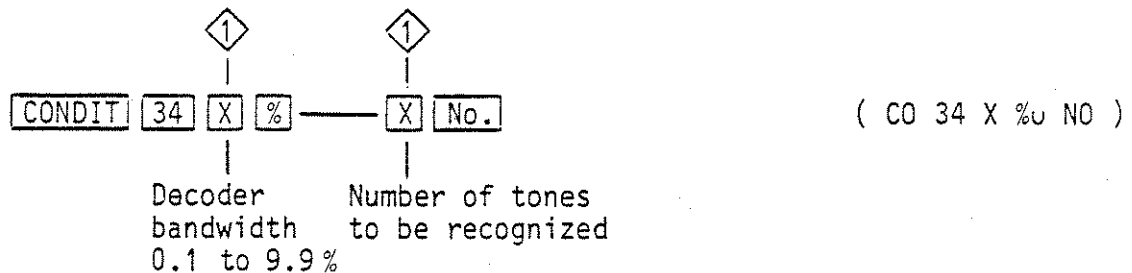

Set decoder to waiting position: ON 34 (ON 34)

In case of AM demodulation: see 3-15

The numbers of recognized tones of the call system selected by CONDIT 32 are indicated in (recognition decoder).

Tones out of bandwidth are not recognized

Tones which are shorter than 0.7 times of the tone duration set through CONDIT 33 are not recognized

At pause durations >200 ms after receiving the first tone the decoding is interrupted

"-" appears at tones not recognized

"A" appears for the alarm tone

"U" appears for the repeat tone in first place

By ON 34 relay 04 of the Control Interface (see 2-9) is activated (Calling key)

Various calls can be released from the transceiver by use of further relays of the Control Interface:

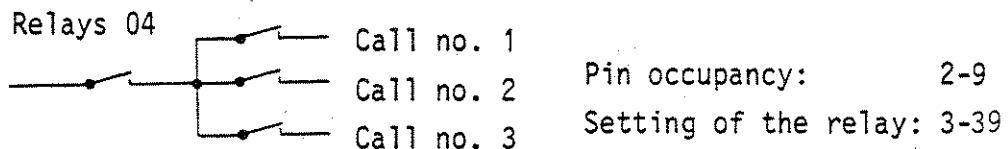

During waiting position ON 34 alterations of the measured values are not registered.

End waiting position: by depressing any arbitrary key (X)

Entry for indication of the call tone deviation:



32 Receipt Call

Operation:

1. Select the call sytem number: CONDIT 32 ..., page 3-42
2. Set Encoder: CONDIT 33 ..., page 3-43
3. Set Decoder: CONDIT 34 ..., page 3-44
4. Release a call: RX ON 32 (RX ON 32 P1)

After releasing the call, the test set switches over to transmitter measurement mode TX in less than 10 ms. The call tone sequence received is indicated in \diamond 1.

Basic Parameters for Selective Call Test

The selective call test parameters stored cannot be cancelled by the reset functions given on page 3-2. They can be changed only by overwriting.

Depressing and releasing the RESET key while the OFF key is held produces the following basic setting (not possible over IEEE bus).

ZVEI 1

5 tones

70 ms tone duration

0 ms pause duration

0 % frequency offset

User system cancelled

35 ... 37 Channel Number

Permits calling up channel frequencies by entering channel numbers.

The channels can be numbered in ascending or in descending order. For descending order (channel no. 1 = channel with highest frequency) **ON 44** (ON 44) must be set in conjunction with SPECIALs 35 to 37.

Enter channel pattern:

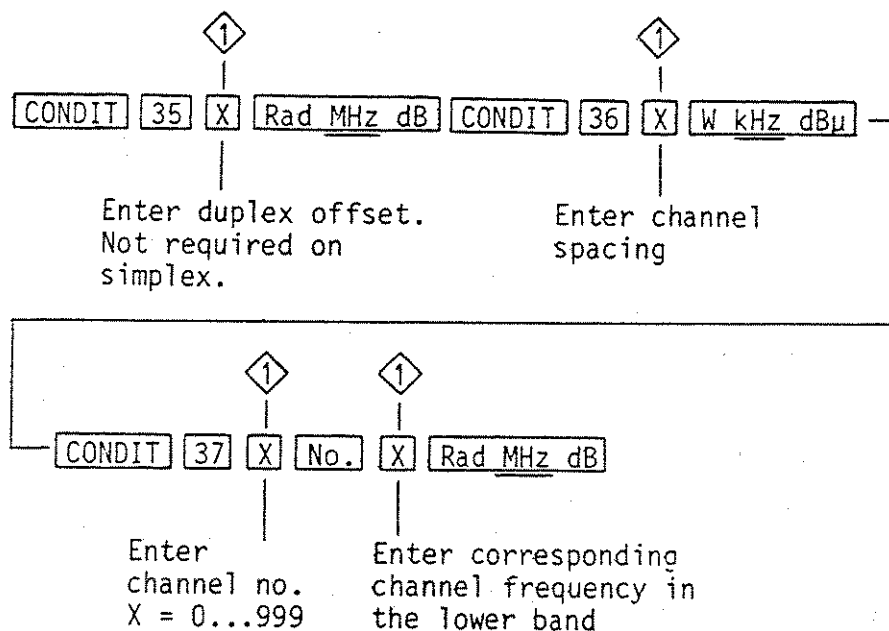

(CO 35 X MH CO 36 X KH CO 37 X NO X MH)

Calling up channel frequencies by the channel number:

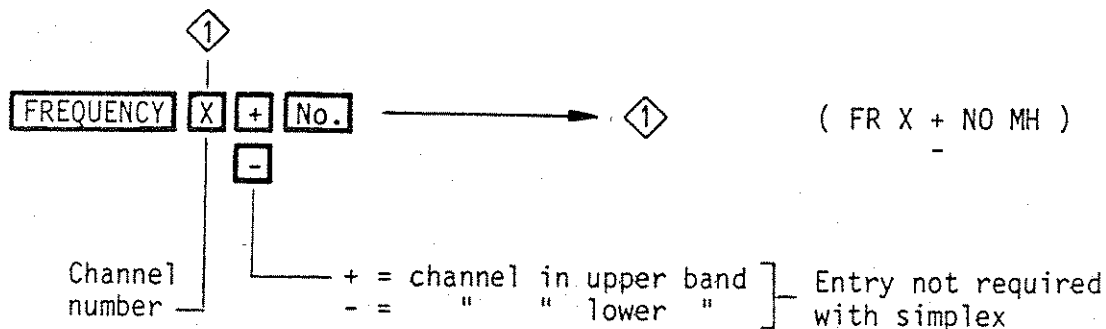

Change-over to frequency display: **Rad MHz dB**

Back to number display: **No.**

The channel numbers called up can be output by the Control Interface and used for frequency control of the transceiver under test (see SPECIAL 29, page 3-39).

39 Concealed SPECIALS

SPECIALS 40 through 47 are not indicated by LEDs on the front panel. With ON 39 it is possible to determine which of these SPECIALS is activated:

ON 39

For activated SPECIALS display **1** shows 1, and for non-activated SPECIALS 0. The SPECIALS are assigned to places 1 through 8:

eg

0	0	1	0	1	0	0	0
---	---	---	---	---	---	---	---

1

Place	1	2	3	4	5	6	7	8	SPECIAL function	Page
									47 SAT MOD/DEMOD -----	3-48
									46 AF generator in RX -----	3-48
									45 AF generator 1 Hz resolution	3-48
									44 Descending channel pattern -	3-46
									43 SNR measurement -----	3-48
									42 Alter units -----	3-27/ 3-29
									41 Cut-out EMF -----	3-29
									40 Shortened measuring times -	3-47

The concealed SPECIALS can be jointly disabled by the following entry:

EDIT **.** **0** **END**

Termination of display ON 39: **FREQUENCY** **Rad MHz dB**

40 Shortened Measuring Times with Controller

By setting **ON 40** the measuring times of the SPECIALS 04, 06 and 07 can be shortened from approx 2.5 to approx 200 ms.

Example:

```
10 DIM A$ (100)
20 OUTPUT 722, "ON 40 ON 06"
30 INPUT 722, A$; DSP A$
40 GO TO 30
50 END
```

Ending by OUTPUT 722, "X" or by any new command.

Shorter integration time of DC measurements: see 3-34

41 Cut-out EMF, see 3-29

42 Alter units, see 3-27/3-29

43 SNR Measurement

When ON 43 is set, then signal-to-noise ratio of the receiver depending on the RF level applied to its input is measured and displayed in 6 (not possible by IEEE488 bus control).

44 Descending Channel Pattern, see 3-46

45 Modulation Generator 1 Hz Resolution (NMT)

If ON 45 is set (see also SPECIAL 39, page 3-47), frequency resolution of 1 Hz can be set for the generator MOD VAR up to a frequency of 4.095 kHz.

Level accuracy and distortion then degrade slightly above 3 kHz.

46 AF Generator in RX mode

By ON 46 level and frequency of the generator MOD VAR can also be set in RX mode.

47 SAT MOD/DEMODO (NMT/AMPS/TACS)

ON 47 serves for measuring the ratio of the SAT modulation to the transceiver/SAT modulation from the transceiver. The dBREL operating mode is set by the routine.

Measurement of the modulation level by external filter on Bu15 (ON 21).

48 Blanking transients of radio transmitter

From software 5.18 onwards, Special ON 48 works in a different way. CONDITION 48 now requires two entries: T1 and T2.

[CONDIT] [48] [XXX] [No] [YYY] [No]

XXX -> T1 Range of entries: 0 to 999 ms
YYY -> T2 Range of entries: 0 to 999 ms

Depending on Special ON 02 (modulation peak storage), the following test operations can be carried out:

ON 02 not activated

STABILOCK 4040 triggers as soon as RF input power is > 50 mW. It then waits for a delay of T1. During T1 the duplex squelch is closed; no signal appears on the MOD socket. After T1 the duplex squelch is opened for the duration T2; the demodulated received signal is output on the MOD socket. After T2 the duplex squelch closes again.

Application example:

Blanking transmitter turn-on peaks in measurements with Radio Code Analyzer 4922/4923.

ON 02 activated

STABILOCK 4040 triggers as soon as RF input power is > 50 mW. It then waits for a delay of T1. During T1 the duplex squelch is closed; no signal appears on the MOD socket. After T1 the peak-responding rectifier is discharged and the duplex squelch opens. During T2 the modulation is measured and the peak value is displayed. The peak modulation value can also be output on P5. The duplex squelch remains open after T2.

Application example:

Measuring peak deviation of a certain tone in a call-tone sequence.

C

C

C

C

51 Preventing automatic switching of relays 2,3,4 and 5

From software 5.20/5.21 onwards (not with SSB option) it is possible to prevent automatic switching of relays 2,3,4, and 5.

[ON] [51] Automatic switching of relays 2,3,4 and 5 is prevented, the relays can be activated by SPECIAL 28 and remain set after the next switchover operation too. (ON 51)

[OFF] [51] Automatic switching is activated again.

94 Disable squelch on duplex stage

From software 5.14/5.15 onwards the squelch on the duplex stage of STABLOCK 4040 can be disabled. The requirement for this is a duplex stage with a squelch switching line. A duplex stage of this kind can be recognized either by a sticker with index "AB" or by the fact that its serial number is ≥ 0196000 .

[ON] [94] Squelch is inactive. Demodulation signal is connected through regardless of RF input level. (ON 94)

[OFF] [94] Squelch is active. Demodulation signal is blocked if RF input level is very low. (OF 94)

Every time the Communication Test Set is powered on and after RESET the SPECIAL is OFF 94 (ie the squelch is active). It is not possible to indicate the status of the squelch, so in cases of doubt the only solution is to call up the SPECIAL with ON or OFF 94.

AUTOTEST

INTRODUCTION

If the STABLOCK 4040 includes the option "memory card interface", the radio communication test set can load and run any user-written test programs. Thus, for example, complete automatic acceptance tests for radios can be performed. The test results can be printed out on a printer with IEEE-488 bus interface (IEEE connector is socket 20, see page 2-10).

The AUTOTEST control panel of the radio communication test set is used to write, edit (correct) and run the test programs. Every newly written program is retained initially only in the non volatile RAM of the 4040. Thus it can then be properly tested before it is finally stored on a memory card.

If a test program is stored in the RAM of the radio communication test set after being reloaded, it can be started, modified, extended or overwritten. Once a test program is stored in the RAM, it remains stored there even after switching off the 4040. After switching on again it can be started without reloading from a memory card. Only a Total-CLEAR (see page 3-2) erases the RAM.

If a test program must control the radio under test as well as settings on the radio communication test set, the option "control interface" (see data sheet) is required. In conjunction with AUTOTEST, all settings like transmitter on/off, squelch on/off or channel selection are then controlled by the radio test set. This guarantees fully automatic measurements in shortest possible time.



MEMORY CARD

A memory card contains 32 KByte RAM. This memory capacity can store up to eight "files", each file can perform up to 50 setting steps. One test program requires at least one file. If however a test program contains more than 50 steps, up to eight files can be linked.

Input slot for memory card

The input slot for the memory card on the 4040 is below the AUTOTEST control panel. Push the card into the slot in the arrow direction with the side marked TOP facing upwards until the stop is reached. Incorrect insertion of the memory card is prevented mechanically.

Battery life

The memory cards carry a battery, which guarantees the storage of the test programs over several years. The "expiry date" of the battery is printed on the memory card. We recommend to transfer the test programs to a "new" memory card before this date is reached.

Formatting

New memory cards must be formatted before they can store data.

Step by step procedure:

1. insert memory card into the slot
2. (ON = ON key in SPECIAL field)

The formatting takes approx. 20 seconds. During this time the AUTOTEST display reads: A - - - -

The formatting is completed when the display goes off. During formatting, bit patterns are written in and read out of all memory cells. If the write and read values are not identical (memory error), the display reads ERR6.

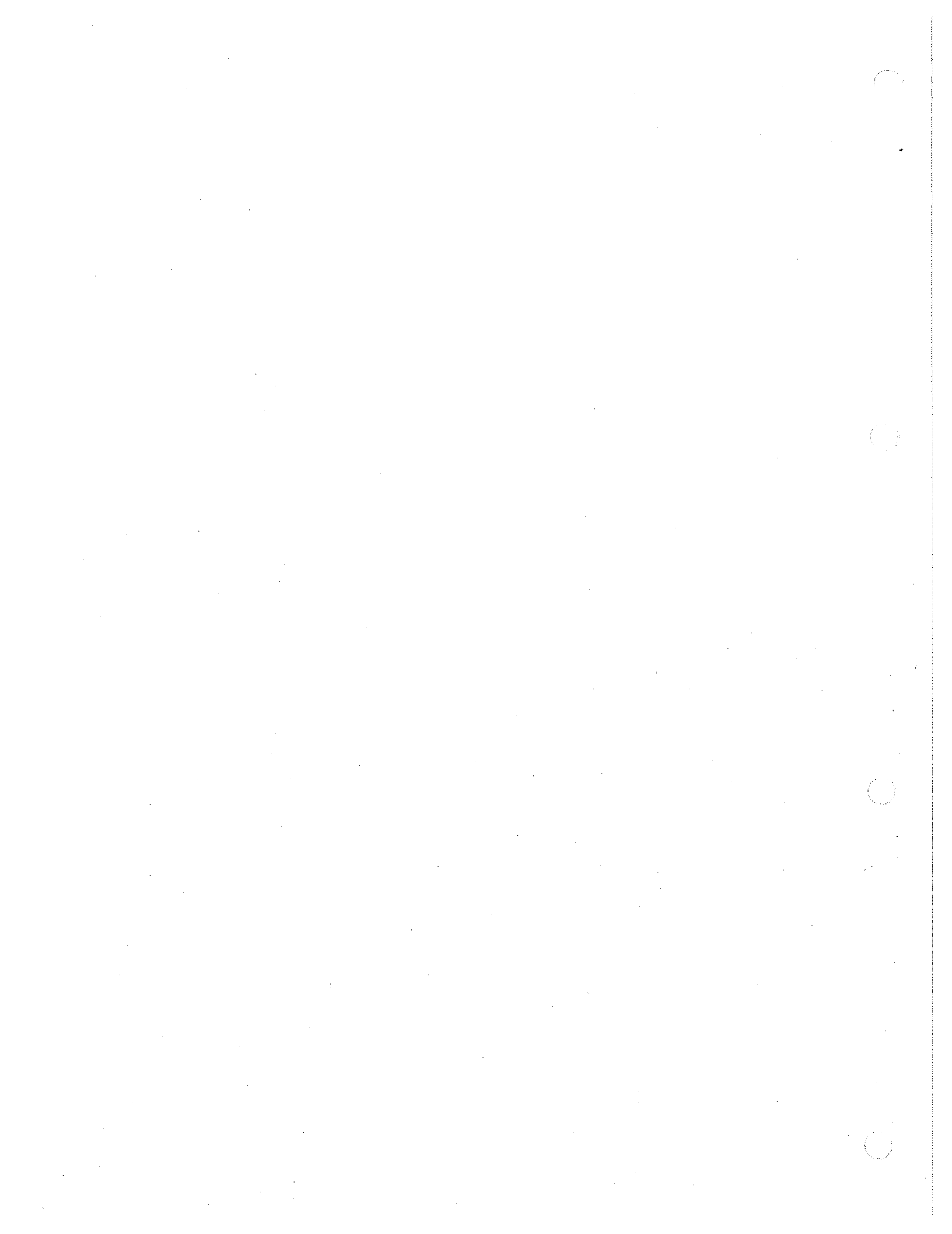

By formatting used memory cards, all data of files which are not write protected - is erased.

How to set WRITE PROTECT and ERASE DATA

Individual files can be write protected, to avoid unwanted overwrite, erasure or alteration of a test program.

ON 91 X set write protection for file X

OFF 91 X clear write protect for file X

X = file number (1...8)

If a file is write protected, it also cannot be erased by formatting. Complete erasure of a memory card is therefore only possible when no file has been write protected.

File status (directory)

ON 92

This command lists all allocated file numbers in the 8 digit display **FREQ**. A decimal point indicates all write protected file numbers. Free files are identified by the "-" sign.

For example:

FREQ. display reads: - - 3 4 5.-7.-

free files: 1, 2, 6 and 8
allocated files: 3, 4, 5 and 7
write protected files: 5 and 7

Caution: To avoid data loss on the memory card the card must not be plugged in when switching on or switching off the test set. It is sufficient to pull back the card approx. 1 cm in order to disconnect the card from the reading/writing device of the test set.

AUTOTEST DISPLAY

The called up file number and the number of the actual step are displayed on the AUTOTEST display. Additional informations about the actual step are displayed in coded form:

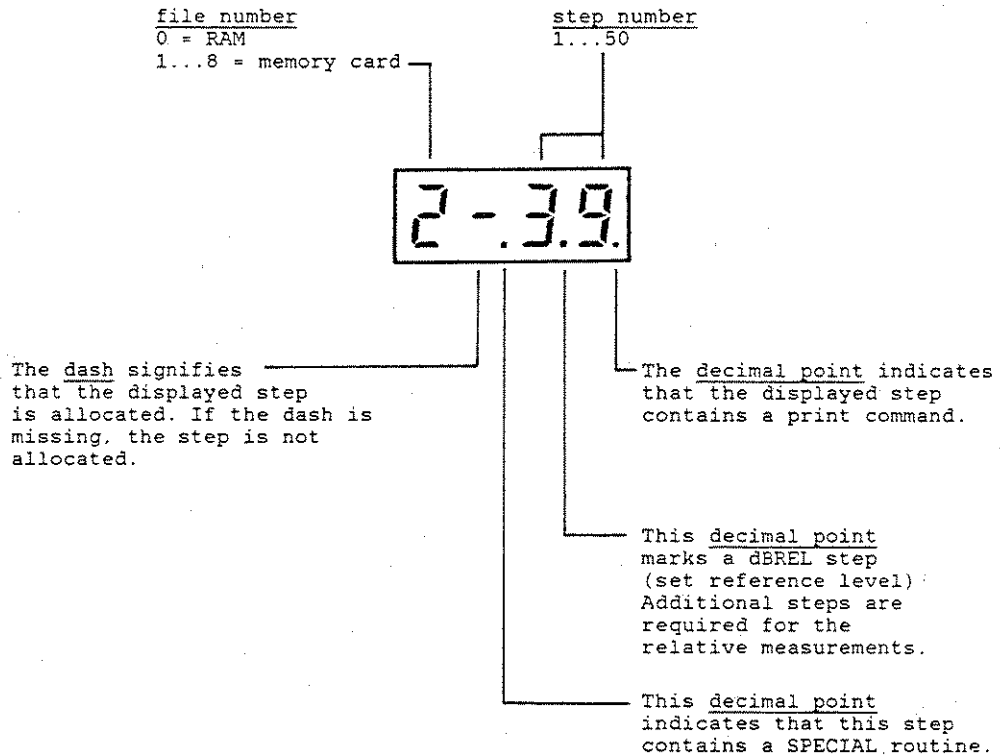

Error messages on the display:

- ERR1 = no memory card inserted
- ERR2 = write protected
- ERR3 = no preamble, for example memory card not formatted
- ERR4 = file not allocated
- ERR5 = error in stored data
- ERR6 = error in test bit pattern
- ERR7 = file not found
- ERR8 = file number > 8
- ERR9 = checksum error (file allocated by radiocode analyzer 4922)

The messages ERR5 to ERR7 indicate a faulty memory card.

WRITING A PROGRAM

Step by step procedure

1. file number 0 (RAM)
and step number 01 are displayed
2. Make settings (for step 01) on the 4040 as usual

Basic settings: RX/TX, frequency, modulation, level etc.

SPECIALs: only one of the following routines is permitted for each step:
01, 04, 05, 06, 07, 11, 12, 13, 14, 16, 19.

In addition, the operating modes 02, 03, 08, 09, 15, 17, 18 and 21 to 29 can be set.

Condition settings of the SPECIALs remain valid for a complete file. Therefore, it is not possible to alter the condition setting of the SPECIALs within a file. Exepted from this restriction are the conditions 09, 22, 23, 24 and 28

Print command: If the measurement result of the actual step is to be printed out, the print command

is required. Y = 1...6; number of display (result field) which presents the measurement result.

Only one print command is permitted per step.

A print command or a wait (see page 3-26) must be set for each step if the program has to run automatically.

3. (next step)
4. Perform settings for step 2
5. (next step) and so on
:
:
:
- X. (program end)



The finished program is now retained in the 4040 RAM. The following command saves it onto a memory card:

EDIT 0 . X END

X = 1...8; file number on the memory card. The file must not be write protected. If the selected file number is already allocated, the new program overwrites the old one.

How to link files

If a program takes more than 50 steps, i.e. more than one file, the next file must be called up at the end of file (last step by ON 99). Input the following command along with the last step:

ON 99

Program repetition

If a program is to be repeated automatically, for example in a continuous test, input the following command at program end along with the last step:

ON 98

The program will then be continuously repeated until the END key is pressed.

CHANNEL FREQUENCY CHANGE

The command ON 90 suppresses the set channel frequency or channel number. In addition, the command provides the input of the actual channel frequency or channel number before program start. Thus, the program can remain unchanged and yet still be used for different channels:

ON 90 FREQUENCY value Rad MHz dB RUN X (frequency)

ON 90 FREQUENCY value +/- No. RUN X (channel)

OFF 90 (The channel frequency or channel number stored in the program is valid again).

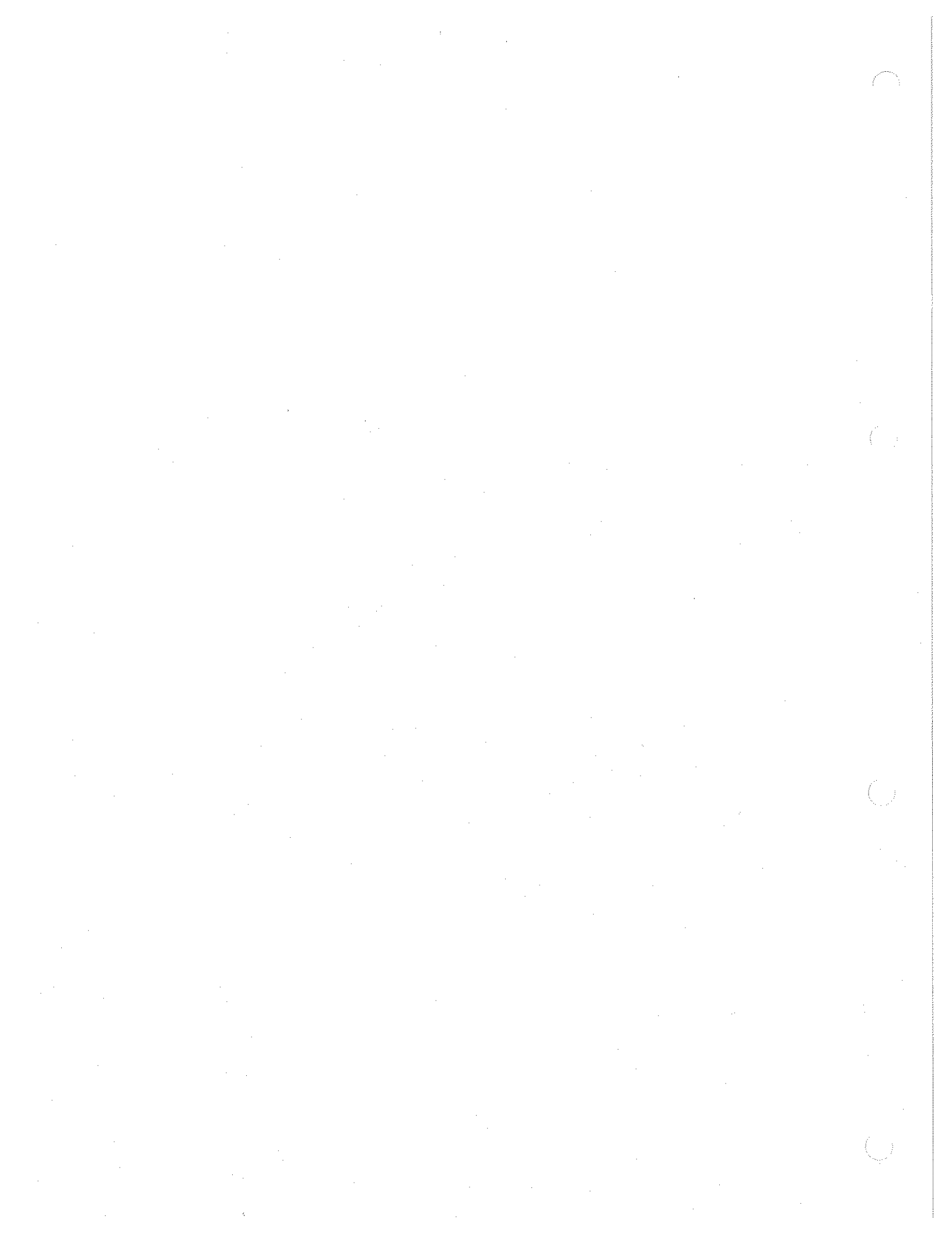

RUN OF TEST PROGRAMS

Step by step procedure

1. Insert memory card with the desired program into the card slot (not necessary if the program is already in the RAM).

2.

X = desired file number; the file is loaded into the RAM. The AUTOTEST display shows file number X and step number 01.

If the program is already in the RAM: X = 0

3. The program is now automatically performed if print commands or waits are set. If not, every step must be called up individually. To do this, press the corresponding key (STEP) on the AUTOTEST control panel.

In automatic run, if the printout mode 9 is set the program stops every time the set limit is exceeded. (see page 3-32). The program run is resumed once the STEP key pointing to the right is pressed.

4. The AUTOTEST display is dimmed at program end.

FILE HANDLING

Erase file

EDIT . X END

X = 1...8; number of file to be erased.

Copy file

If large parts of existing programs are to be inserted in a new program, it is advantageous to copy file contents. The original file contents remain thereby unchanged.

EDIT X . Y END

X = number of original file; Y = number of new file.
The new file must not be write protected.

If the original and new files are not on the same memory card, the RAM (file 0) must be used as temporary memory:

1. Insert memory card with the original file into the card slot.
2. EDIT X . 0 END (file X --> RAM)
3. Insert formatted memory card which is to receive the copy into the card slot.
4. EDIT 0 . Y END (RAM --> file Y).

Every attempt to overwrite a write protected file causes the LED "WRITE PROTECTED" on the AUTOTEST control panel to light up. Change the memory card or find another file which is not write protected by calling up the file directory.



Copying memory cards

Only single files can be copied without external computer. This means that the memory cards have to be exchanged after every file transfer, as previously described.

If your computer has an IEEE bus interface, all files of a card can be loaded into the computer and then copied onto a new formatted memory card.

EDITING STORED PROGRAMS

Overwrite step setting

1. or

X = file number. Press the appropriate key until the number of the desired step is displayed.

2. Change the settings on the 4040.
3.

Insert step

1. or

X = file number. Press the appropriate key until the number preceding the desired step is displayed.

2. (corresponds to)
3. Carry out the settings of the additional step.
4.

The step numbers preceding the insertion are automatically increased by one. A beep indicates when the maximum step number (50) is exceeded.

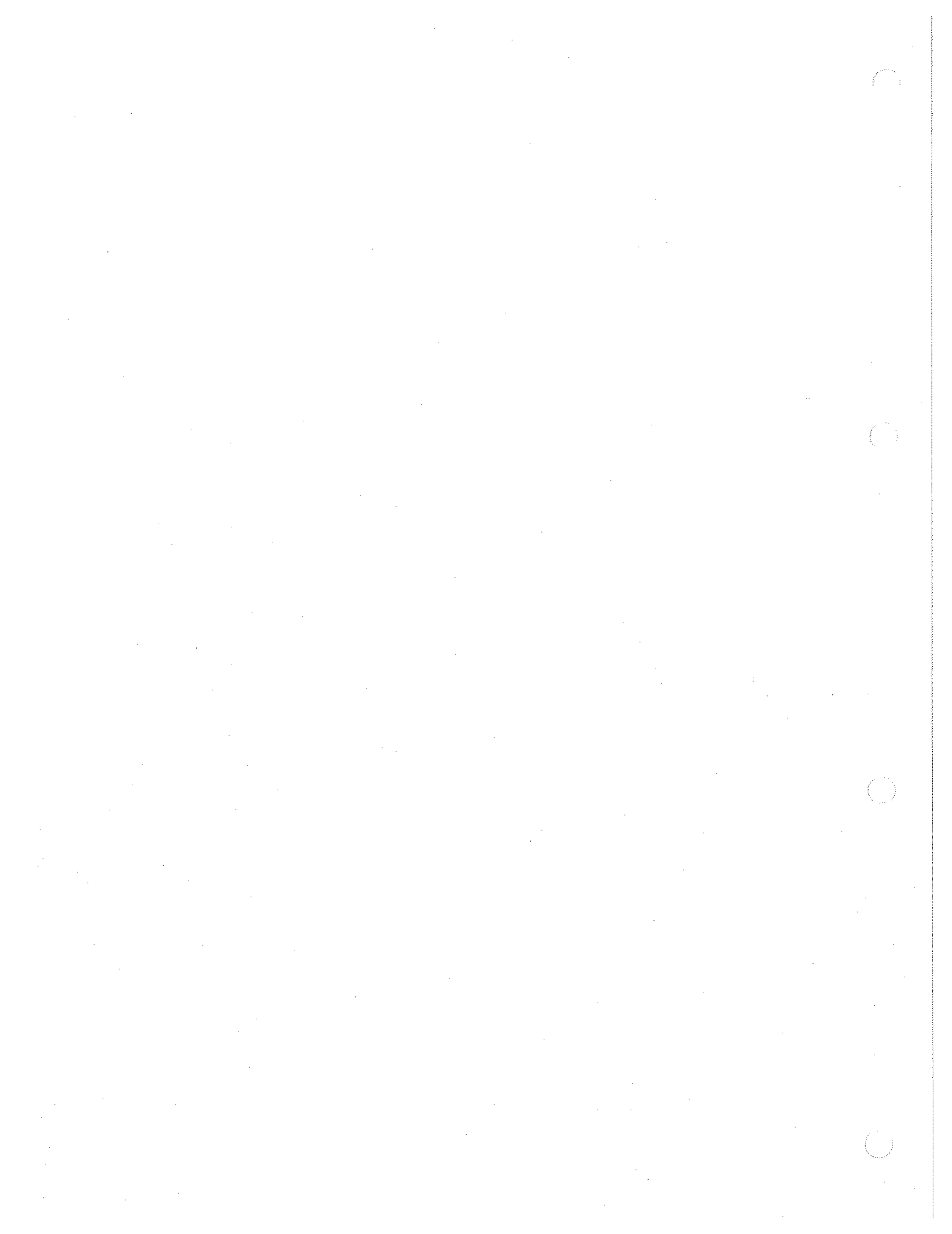

Erase step

1. or

X = file number. Press the appropriate key until the number of the desired step is displayed.

2. (corresponds to DEL STEP)
3.

The step numbers above the erased step are automatically decreased by one.

PROGRAM PRINTOUT

(printout of a complete file)

X = 1...8; file number.

(printout during programming)

TEXT INPUT

If the testsheet is to be supplemented with explanatory text, the option STABITEXTER is required (order number: 248 081). This keyboard for text input is connected to socket 18 (control interface).

The AUTOTEST display functions as a character counter during text input. Max. 20 characters per line are permitted, the remaining number of characters is displayed. The text is always justified left in the testsheet. Each text line and empty line takes one step in the program.

Procedure for Text Entry:

STABITEXTER	STABILOCK
	Set the TALK ONLY mode on the address switch (5-2)
Switch on: ON → LED lights up	File and step number display: LEARN 0 → e.g.: 0 - 0 1
Headlines, text only: START - - - - - END	Display counts characters: - - 2 0 Print command, next step: PRINT ◊ . → 0 - 0 2
Empty line: START Space bar END	Print command, next step: PRINT ◊ . → 0 - 0 3
	Perform all settings for the program step
Accompanying text: START - - - - - Test printout without storing: SHIFT # 3 Repeat entry if error: RESET - - - - - Store text: END	Display counts characters: - - 2 0 " File and step number display
	Printout mode: CONDIT 23 X No. ON 23 X = 4: prints text and result X = 5: prints text and result if out of limit only Print command, next step: PRINT ◊ Y → 0 - 0 4 ◊ = 1 ... 6
and so on	
Switch off: OFF → LED off	

Print out program listing: LEARN X EDIT PRINT ◊

X = file number 0 ... 9

Print out listing during programming: EDIT PRINT ◊

Example: see next page

Example of a Test Record

TEST CERTIFICATE:
FOR MOBILE RADIO:...

A. TRANSM. MEAS.:
FREQUENCY: 146.24981 MHZ
CHANNEL OFFSET: - .327 KHZ
MICRO.SENSITIVITY: 76.8 MV
DISTORTION 1 KHZ: 1.2 % >>>>
MOD.LINEARITY:
0,15 KHZ: - 9.0 DB >>>>
0,30 KHZ: - 1.4 DB >>>>
0,40 KHZ: - .2 DB >>>>
1,0 KHZ: .0 DB <<<<
1,25 KHZ: - .1 DB <<<<
2,7 KHZ: - 1.2 DB >>>>
3,0 KHZ: - 2.3 DB >>>>
6,0 KHZ: - 25.5 DB >>>>

VOLTAGE SUPPLY: - 7.14 V
CURRENT CONS.: - 732 MA

Program Listing:

0-01	P.							TEST CERTIFICATE:
0-02	P.							FOR MOBILE RADIO:...
0-03	P.							-----
0-04	P.							A. TRANSM. MEAS.:
0-05	P1/4	<6>	0000 / 0.000	FREQUENCY:				
0-06	P2/4	<6>	0000 / 0.000	CHANNEL OFFSET:				
0-07	P6/4	SO1 ON	<6>	0000 / 0.000	MICRO.SENSITIVITY:			
0-08	P6/4		<6>	0.800 / 1.000	DISTORTION 1 KHZ:			
0-09	P.				MOD.LINEARITY:			
0-10	DBR							
0-11	P6/4	<6>	1.000 / 0.100	0,15 KHZ:				
0-12	P6/4	<6>	1.000 / 0.100	0,30 KHZ:				
0-13	P6/4	<6>	1.000 / 0.100	0,40 KHZ:				
0-14	P6/4	<6>	1.000 / 0.100	1,0 KHZ:				
0-15	P6/4	<6>	1.000 / 0.100	1,25 KHZ:				
0-16	P6/4	<6>	1.000 / 0.100	2,7 KHZ:				
0-17	P6/4	<6>	1.000 / 0.100	3,0 KHZ:				
0-18	P6/4	<6>	1.000 / 0.100	6,0 KHZ:				
0-19	P.							-----
0-20	P6/4	<6>	0.000 / 0.000	VOLTAGE SUPPLY:				
0-21	P6/4	<6>	0.000 / 0.000	CURRENT CONS.:				

File number	Step number	Result display no.	Printout mode	SPECIAL	Min. tolerance	Max. tolerance	Text
-------------	-------------	--------------------	---------------	---------	----------------	----------------	------

IEEE 488 Bus

GENERAL DATA

In STABLOCK 4040 the remote-control interface is implemented in the form of an IEEE 488 interface. The connector (Bu20 on the rear of the instrument) is 24-way.

All the functions of the interface are handled by the Motorola module M68488 in combination with preconnected data drivers. Available functions: AH1, SH1, L2, T1, SR1, RL1, DC1.

If the GPIB is activated by the control processor, the REMOTE display on the 4040 lights up and all front panel control elements are inoperable. The numerical and mode displays remain in operation.

For some of the measuring sequences the measuring times can be shortened considerably (see SPECIAL 40, page 3-47).

The 4040 is operated with the IEEE 488 Bus by using 2-letter codes which are extremely easy to learn since they are closely related to the clear text used on the front panel of the 4040. The code letters are underscored on the front panel.

ADDRESS SWITCH

The bus address of the STABILOCK 4040 is set at a dip switch on the IEEE 488 Interface 236 040 on the rear panel of the unit using the code table on page 5-3.

Address switch:

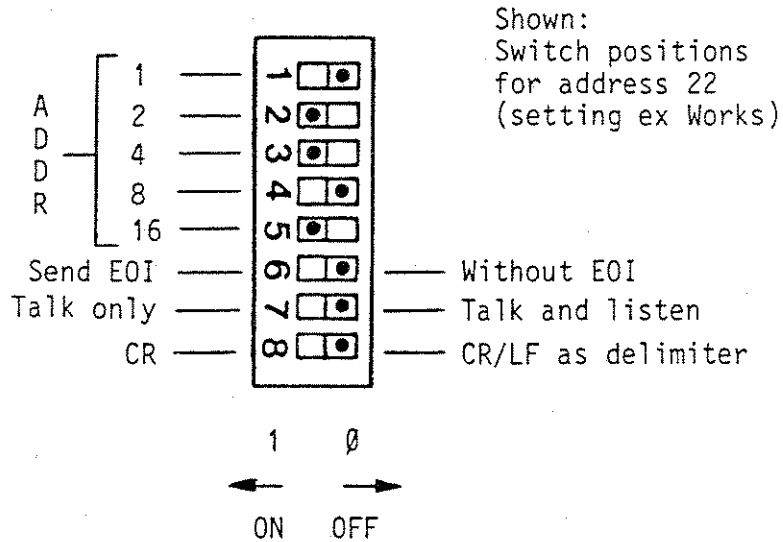

The bus address set can be displayed in field $\diamond 1$ by entering $\square ON \square 64$.

Example with address 22: $\square 5.04 \square -- \square A22 \square$

The reading is by 64 higher as the set address, if the TALK ONLY mode is switched on. In the example above the reading would be A86.

Switch off address display with the RESET key.

Further functions of the address switch:

Switch 6: printout with or without sending EOI

Switch 7: for setting the TALK ONLY mode of the STABILOCK 4040. The TALK ONLY mode has to be switched off, if the 4040 works in conjunction with a controller.

Switch 8: determines if CR/LF or CR (for instance Commdore) is used as delimiter of the print strings.

Address Coding

Address Switch Positions (1 = ON)					Talk Address Character	Listen Address Character	Address Numbers (5 Bit Decimal Value)
Switch No.							
5	4	3	2	1			
0	0	0	0	0	@	SP	00
0	0	0	0	1	A	!	01
0	0	0	1	0	B	"	02
0	0	0	1	1	C	#	03
0	0	1	0	0	D	\$	04
0	0	1	0	1	E	%	05
0	0	1	1	0	F	&	06
0	0	1	1	1	G	.	07
0	1	0	0	0	H	(08
0	1	0	0	1	I)	09
0	1	0	1	0	J	*	10
0	1	0	1	1	K	+	11
0	1	1	0	0	L	,	12
0	1	1	0	1	M	-	13
0	1	1	1	0	N	.	14
0	1	1	1	1	O	/	15
1	0	0	0	0	P	0	16
1	0	0	0	1	Q	1	17
1	0	0	1	0	R	2	18
1	0	0	1	1	S	3	19
1	0	1	0	0	T	4	20
1	0	1	0	1	U	5	21
1	0	1	1	0	V	6	22
1	0	1	1	1	W	7	23
1	1	0	0	0	X	8	24
1	1	0	0	1	Y	9	25
1	1	0	1	0	Z	:	26
1	1	0	1	1	[:	27
1	1	1	0	0	\	<	28
1	1	1	0	1]	=	29
1	1	1	1	0)	>	30

IEEE-488 BUS COMMANDS FOR THE STABILOCK 4040

Mode selection

The GPIB can be used to perform all of the possible mode and numerical settings available on the front panel of the STABILOCK 4040, the AUTO operating mode excepted.

The commands for setting modes consist of one or more code designations each of 2 letters (see front panel). Numerical values are entered together with the related function and unit of measure.

Examples:	Bus Command
Preparing frequency deviation measurement (TX)	MM KH or also FM
Display of positive modulation peak	PO
Retrieving frequency deviation measurement	M5 P5
Frequency setting (RX)	FR 151.65 MH
Frequency deviation setting	MM 2.8 KH
Retrieving frequency setting	P1

General Commands

Signification	Bus Command
Request to the STABILOCK 4040 to perform the measurement. Display of the measured value in field \diamond = 1...6. The execution of measurements called up is confirmed by the MEASUREMENT lamp in the SPECIAL field lighting up.	MY
Wait for transmitter power >50 mW before any measurements (see 5-7)	TR
Retrieving measured values or existing settings on 4040	PY
Request for cyclical measurements without transferring the measured values to the controller	MA
End cyclical measurement. End selective call test	Xv
Examination of the bit pattern test inputs (see 2-8) and result presentation e.g. <div style="text-align: center;"> bit 8 ——— 0 1 1 1 0 0 0 1 ——— bit 1 </div>	P9
Reset 4040 to local mode. For controllers without a direct local command	LC
Total Reset (see 3-2) via IEEE bus	CL
The 4040 gives x times an acoustic signal	PPx
Command starts specials 11,12,13,14 repeatedly up to 3 times if no measuring result has been found (helpful in combination with AUTORUN of 4922). RP is to be set every time again when repeat function desired.	RP

v = space

Bus Commands for Transmitter Measurements

4040 Settings and Calling up Measuring Results	Bus Command (\cup = space)
Operating mode AUTO (automatic RX/TX selection)	not via bus
TRANSMITTER MEASUREMENT	TX (1x for all following transmitter measurements)
Transmitter output: Average power Envelope peak power Call up result From 5.04 also with RX mode, erase result	AV PK M4 P4 AP
Transmitter frequency: Set nominal frequency Call up frequency offset Measure and call up transmitter frequency	FR DATA MH M2 P2 M1 P1
Output of Modulation Generators: Set frequency 30 Hz...30 kHz Set output level (mV) Switch on 1 kHz Generator Set output level Switch on EXT MOD input Set EXT MOD Switch off generators	GR ON MF DATA KH or HZ MM DATA MV GK ON MM DATA MV GX ON ON 27 MM DATA MV GR OF, GK OF, GX OF
Modulation measurement: FM AM ϕ M Positive modulation Negative modulation Average modulation Call up result	MM KH or FM MM % \cup " AM MM RA " PM PO NE PE M5 P5
Measure and call up modulation distortion	M0 DI M6 P6
Relative residual modulation: Set useful reference modulation Switch off modulation Call up residual modulation (CCITT)	M0 RL GR OF or GK OF CC ON M6 P6
Transmitter measurement via RF DIRECT socket Again via RF socket	DR ON DR OF

Bus Commands for Receiver Measurements and DC Measurements

4040 Settings and Calling up Measuring Results	Bus Commands u = space
RECEIVER MEASUREMENT	RX (1x for all following receiver measurements)
Set frequency Set frequency by the channel number (see SPECIAL 35...37) Set frequency offset	FR DATA MH FR DATA (+/-) NO FR +/- DATA KH
RF output level: Set EMF in μ V " " " mV " " " dB μ V Set into 50 Ω voltage in μ V " " " " mV " " " " dB μ V Set output power in dBm Switch off output level Switch on again Call up set value	EM AP DATA UV " " " MV " " " DU IN " " UV " " " MV " " " DU " " " DM LE OF LE ON P4
Modulation: Set mod. frequency 30 Hz...30 kHz Set FM " AM " Φ M Switch on 1 kHz Mod. Generator Set modulation Switch on EXT MOD Set EXT MOD Call up set value Switch off Mod. Generators	MR ON MF DATA KH or HZ MM DATA KH " " % " " RA MK ON as for 30 Hz...30 kHz MX ON ON 27 MM DATA KH, % or RA P5 MR OF, MK OF, MX OF
AF Voltmeter: Measure AF level from receiver " distortion Measure mod. frequency response: Reference level (fmod 1 kHz) Relative measurement Set SINAD display mode Set CCITT weighting Call up result AF frequency measurement	independent of RX/TX AC VA AC DI AC VA RL MF DATA (mod. frequ.) KH AC SI CC ON, CC OF M6 P6 M3 P3
DC Measurement: DC voltage DC current Call up result	VD AD M6 P6



Special routines

The IEEE-bus commands to operate the specials (mentioned in brackets) are described in the front-panel operation instruction starting on page 3-20.

Trigger function at single measurements

Input TR delays the selected single measurement until the TX power has raised from 0 W to >50 mW. If the power does not drop below 50 mW before raising up, single measurements will not be triggered. TR can be used together with any measurement, like for example an RMS measurement.

If no trigger occurs, the waiting position can be left by the time-out of the computer using the IEEE command LOCAL 4040. The command has to be delimited by two fill characters (e.g. "SPC" or "_") or by CR/LF.

Power measurement for instance:

```
wrt722,"TRM4__P4" (bus blocked until power is >50 mW),
```

or

```
wrt722,"TRM4"CR/LF
```

```
wrt722,"P4" (bus free until power exceeds 50 mW)
```

Modulation-peak hold

In remote mode the peak detector is discharged by any set M5 command, if ON02 has been selected before.

Service Request

The commands below can be used to determine the operating conditions in which STABLOCK 4040 should send SRQ:

ON 49 X

(ON 49 X)

- X = 1 SRQ at end of measurement
- X = 2 SRQ with selfcheck error message
- X = 3 SRQ if synthesizer not synchronous

Combination of several operating conditions by addition, for example SRQ at end of a measurement and with selfcheck message: X = 3

Resetting the SRQ function:

OFF 49

(OF 49)

Output Format

Output format of STABLOCK 4040 with IEEE 488 bus

String length: 24 characters + CR LF

Format:

Position

1	2	3	4	5	6	7	8	9	10	11	12	13	14	15	16	17	18	19	20	21	22	23	24	25	26	
10 spaces for perforation*										Measured value Right-justified Maximum 9 positions Filling up with spaces, e.g.:								2 spaces		Unit Left-justified		CR/LF				
u	u	u	u	u	u	u	u	u	u	1	2	3	.	2	5	0	0	0	u	u	M	H	Z			
u	u	u	u	u	u	u	u	u	u	u	u	u	u	u	u	u	.	3	u	u	M	V	u			
u	u	u	u	u	u	u	u	u	u	u	u	u	u	1	7	.	2	7	u	u	W	u	u			

* Not applicable in combination
ON40 + DC (fast DC measurement)

2 spaces or u*
if RF level + U_{in}
is selected

TRANSIENT RECORDER

From software version 5.12 onwards STABLOCK 4040 in conjunction with an IEEE-bus controller offers the extra feature "Transient recorder". Thus the Communication Test Set is able to sample any low-frequency signal, to store the samples in RAM (transient memory) and to output them for further processing to a computer. In this way it is possible, for example, to produce a graphic display of the transient response of a transmitter stage.

Technical data

Sampling rate:	maximum 100 μ s \pm 1 μ s minimum 1000 μ s \pm 1 μ s
Resolution:	8 bits (256 quantizing steps) + sign
Transient memory:	2 Kbytes (2048 samples)
Recording duration:	minimum approx. 205 ms maximum approx. 2.05 s
Gain:	x 1, x 5, x 50
Trigger:	\pm 250 mV

Signal feed-in

Test signal:	The input for the signal to be sampled is the Vdc sockets on the front panel.
Trigger signal:	The input for the trigger signal is socket 15, pin 2 (rear panel). If the voltage level here alters by at least 250 mV, the transient recorder starts to sample the test signal at the same time. Permissible voltage level on socket 15, pin 2: 0 to 5 V.

IEEE control commands

There are five IEEE commands for controlling the transient recorder:

"TM"	Starts the sampling of the test signal and the recording of the samples.
"TR"	Declares the trigger condition for Bu 15/pin 2, ie the program is not started or continued until the voltage on this socket alters by at least 250 mV.
"TP"	Produces output of the 2048 stored samples to the computer. The samples are 3-digit with sign (range of values: \pm 000 to \pm 255). Terminating character = CR/LF.
"Tn"	Extends the maximum sampling rate (100 μ s) by $n \cdot 100 \mu$ s ($n = 0$ to 9).
"Sn"	Sets the gain for the test signal in the DC branch: S1 = x 1 S2 = x 5 S3 = x 50

Program example

```
dim T$[8200]           Dimensioning of output string
wrt 722,"T4"          Sampling rate = 500  $\mu$ s
wrt 722,"TR TM TP"    Wait for trigger pulse, record and output
red 722,T$            Read output string
```

Applications

Below four elementary applications for the transient recorder are outlined schematically. The printouts shown next to the test setups are the result of graphic evaluation of the samples.

Transient response of transmit frequency

The test signal is the transmit signal demodulated by the Communication Test Set; the trigger signal in the test setup shown is derived from the transmit key, but it can also be obtained from Radiocode Analyzer 4922 for testing cellular radios after a command for changing channel.

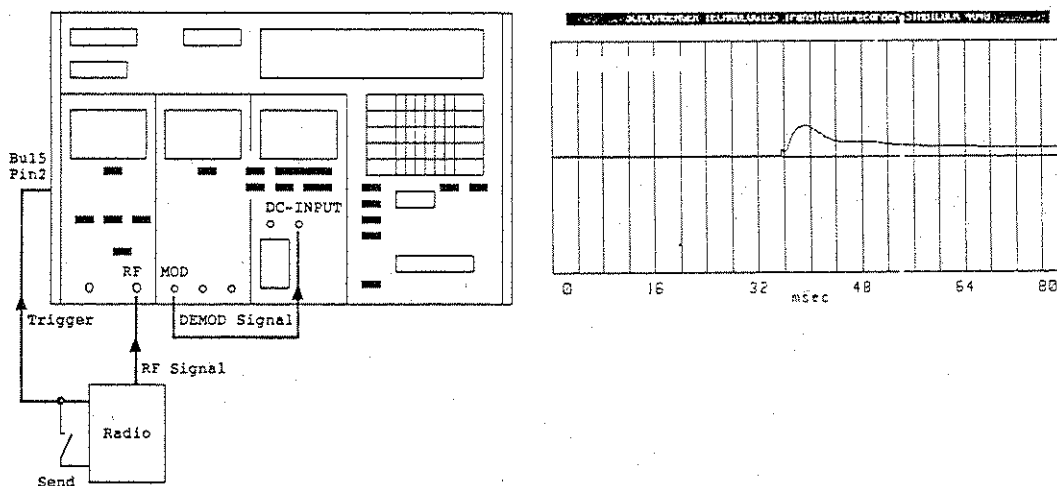

After a dead time of barely 36 ms (transmitter buildup) the deviation of the carrier frequency first increases to three times the standard offset, which is reached after approx. 68 ms.

Delay and increase in transmitting power

Take the test signal from the RF power probe at testpoint M5 on board 461 378 (AF decoder) and apply it to Bu 15, eg the vacant pin 11. Take the trigger signal from the transmit key or Radiocode Analyzer 4922.

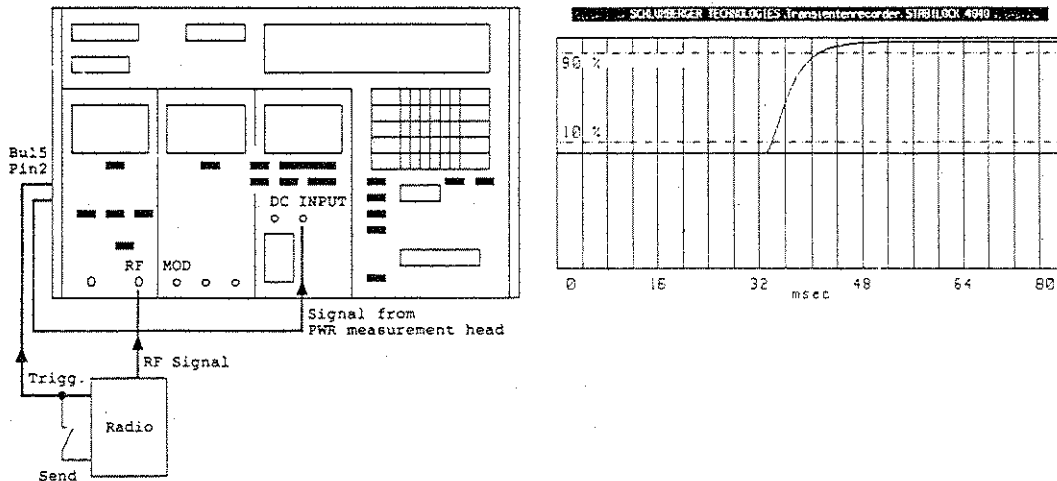

After a dead time of approx. 33 ms the transmitter reaches its nominal power at approx. 52 ms. The increase from 10% to 90% nominal power lasts approx. 8 ms.

Transmitter buildup in calling systems

The test signal is the transmit signal demodulated by the Communication Test Set; the trigger signal is taken from the transmit key.

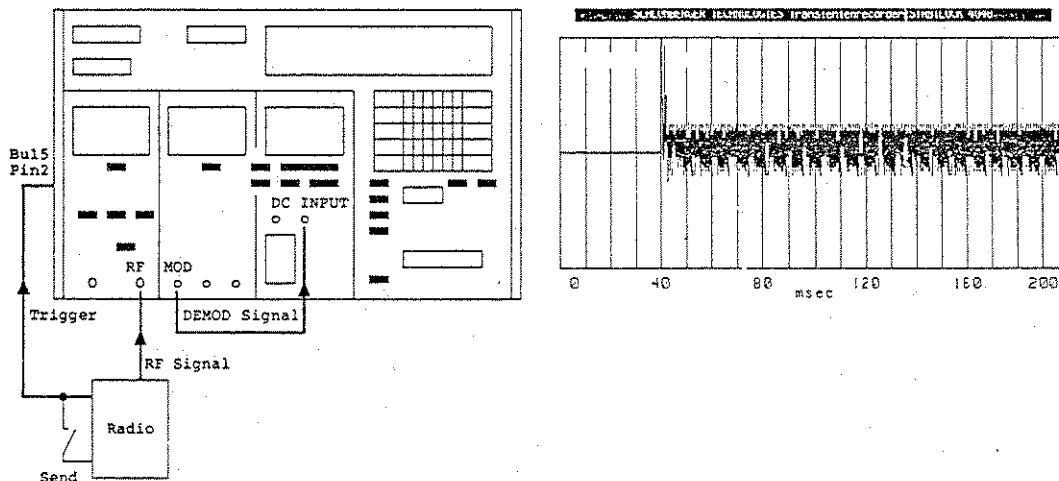

After the transmit key is pressed, it takes 40 ms for the transmitter to issue the call signal. The transmitter buildup in this case is the dead time plus the call delay after applying the power.

Squelch delay

The test signal is the AF output signal of the radio set; this time triggering is not with the TR command via socket Bu 15, but direct by influencing the RF output level of the 4040. For this the RF level must be set beforehand so that it is 10 dB above the switching point of the squelch. By calling up the Special ON15, with -20 dB attenuation of the RF signal, the switching point of the squelch is initially underrun. The trigger instant is when the the RF attenuation is cut out with OF15 and the switching point of the squelch is thus again exceeded. The following program example implements this:

```
wrt 722,"ON15-20DB"  
wait 500  
wrt 722,"OF15 TM"
```

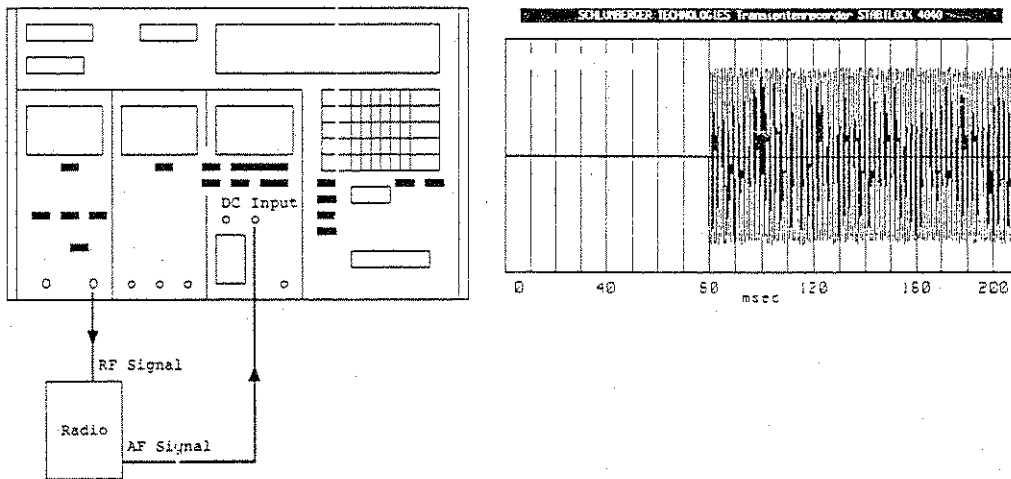

As soon as the trigger condition is fulfilled (switching point of squelch exceeded), the radio set tested here requires 80 ms until the wanted signal appears on the AF output.

Program listing for graphic evaluation

The following pages show the listing of a program that controls the transient recorder and at the same time handles graphic evaluation of the samples. The program (Rocky Mountain BASIC) can run on HP computers of series 200 and 300 and prompts all entries interactively from the user.

```

1000 !=====
1010 !AUFGABE : Transient-recorder 4040
1020 !DISKETTE :
1030 !FILE : Transien_E
1040 !AUTOR : G.Mayrhofer
1050 !DATUM : 28.2.89
1060 !VERSION : 1.00
1070 !COPYRIGHT : SCHLUMBERGER TECHNOLOGIES MUNICH
1080 !=====
1090 !
1100 !
1110 GOSUB Dim
1120 GOSUB Clear_4040
1130 GOSUB Input
1140 GOSUB Grafik
1150 GOSUB Bas_4040
1160 GOSUB Gain
1170 GOSUB Transient
1180 GOSUB Print_out
1190 !
1200 IF Again$="y" OR Again$="Y" THEN
1210 GOTO 1130
1220 ELSE
1230 PRINT "End"
1240 END IF
1250 !
1260 STOP
1270 !
1280 !
1290 !Programm_level1-----
1300 !
1310 Dim: !
1320 DIM R$(8194)
1330 DIM A$(10)
1340 RETURN
1350 !
1360 Clear_4040: !
1370 CLEAR 722
1380 WAIT 2
1390 RETURN
1400 !
1410 !Programm_level2-----
1420 !
1430 !
1440 Input: !
1450 GCLEAR
1460 PRINT CHR$(12)
1470 INPUT "Please enter recording time (max 200 msec)",Input
1480 IF Input>200 THEN 1470
1490 INPUT "powermeasurement y/n ?",Input$
1500 IF Input$="y" OR Input$="Y" THEN Power=1
1510 IF Input$="n" OR Input$="N" THEN Power=0
1520 RETURN
1530 !
1540 !
1550 Bas_4040: !
1560 OUTPUT 722;"TX VD" ! Voltmeter

```



```

1570 RETURN
1580 !
1590 Gain:|
1600 OUTPUT 722;"S3" ! Gain |x50=S3|*5=S2|*1=S1|
1610 RETURN
1620 !
1630 !
1640 Transient:|
1650 !
1660 PRINT TABXY(2,4);CHR$(130);"WAITING FOR TRIGGER";CHR$(128)
1670 OUTPUT 722;"TR TM TP"
1680 PRINT TABXY(2,4);CHR$(128);"
1690 ENTER 722;R$
1700 !
1710 OUTPUT 722;"AC VD" ! Dummy
1720 LOCAL 722
1730 !
1740 RETURN
1750 !
1760 !
1770 !
1780 !
1790 |Programmebene_3-----
1800 !
1810 !
1820 Grafik:|
1830 !
1840 !
1850 PRINT TABXY(0,1);CHR$(128);" SCHLUMBERGER TECHNOLOGIES Transient
recorder STABILOCK 4040 ";CHR$(128)
1860 LINE TYPE 1
1870 Resolution=Input*10
1880 VIEWPORT 0,400,25,90
1890 WINDOW 0,Resolution,-320,255
1900 GRAPHICS ON
1910 GCLEAR
1920 !
1930 MOVE 0,255
1940 DRAW Resolution,255
1950 MOVE 0,-255
1960 DRAW Resolution,-255
1970 MOVE 0,0
1980 DRAW Resolution,0
1990 !
2000 FOR X=0 TO Resolution STEP Resolution/20
2010 MOVE X,-255
2020 DRAW X,255
2030 NEXT X
2040 !
2050 FOR X1=0 TO Resolution STEP Resolution/5
2060 MOVE X1,-290
2070 CSIZE 5,.5
2080 LORG 5
2090 IF X1=0 THEN LORG 2
2100 IF X1=Resolution THEN LORG 8
2110 LABEL X1/10
2120 NEXT X1
2130 !
2140 MOVE Resolution/2,-310
2150 LORG 5

```



```

2160 LABEL "msec"
2170 !
2180 RETURN
2190 !
2200 !
2210 Print_out: !
2220 !
2230 Counter=0
2240 Counter=INT(Counter)
2250 !
2260 FOR X=1 TO Resolution*4 STEP 4
2270     Counter=Counter+1
2280     X1=X+3
2290     A=R$(X,X1)
2300     A=VAL(A)
2310     IF Power=1 THEN A=(A*A)/255
2320     IF Counter=1 THEN MOVE Counter,A
2330     DRAW Counter,A
2340 NEXT X
2350 !
2360 IF Power=1 THEN
2370 !
2380 IF A<10 THEN 2550
2390 !
2400 LINE TYPE 8
2410 P_90=(A/100)*90
2420 P_10=(A/100)*10
2430 MOVE 0,P_90
2440 DRAW Resolution,P_90
2450 MOVE 0,P_10
2460 DRAW Resolution,P_10
2470 LINE TYPE 1
2480 MOVE Resolution/20,P_90
2490 LORG 6
2500 LABEL "90 %"
2510 MOVE Resolution/20,P_10
2520 LORG 4
2530 LABEL "10 %"
2540 LORG 4
2550 END IF
2560 !
2570 INPUT "New recording y/n ?" ,Again$
2580 !
2590 RETURN
2600 !
2610 !
2620 !
2630 END

```

Application Notes

STABILOCK
4040

Contents

RECEIVER MEASUREMENTS

Manually Measuring Sensitivity Based on the Signal/Noise (S/N) Ratio Method -----	6-4
Automatically Measuring Receiver Sensitivity Based on the Signal/Noise Ratio Method Used the S/N Routine -----	6-6
Manually Measuring Receiver Sensitivity Based on the SINAD (SND/ND) Method -----	6-8
Automatically Measuring Receiver Sensitivity Based on the SINAD Method Using SINAD Routines -----	6-10
Manually Measuring the Signal/Noise Ratio or SINAD Ratio with Specified EMF -----	6-12
Manually Measuring Receiver Bandwidth and Receiver Center Frequency Offset -----	6-14
Automatically Measuring Receiver Bandwidth and Receiver Center Frequency Offset Using the SPECIAL 13 Routine -----	6-16
Manually Measuring MODULATION ACCEPTANCE BANDWIDTH -----	6-18
Manually Measuring Squelch -----	6-20
Automatically Measuring Squelch Parameter Using the Integral SQUELCH Routine -----	6-22
Manually Measuring Receiver Frequency Response -----	6-24
Manually Measuring Receiver Signal/Noise Ratio (HUM AND NOISE) -----	6-26
Manually Measuring Receiver AF Output and Distortion Factor -----	6-28
Manually Measuring Limiter Characteristics -----	6-30
Automatically Measuring Reduction in Receiver Sensitivity with DUPLEX Mode -----	6-32

TRANSMITTER MEASUREMENTS

Measuring Transmitter Output -----	6-34
Measuring Transmitter Frequency and Offset of Transmitter Frequency to Set Frequency -----	6-36
Manually Measuring Modulation Sensitivity of Transmitter -----	6-38
Measuring Modulation Sensitivity with Modulation Sensitivity Routine -----	6-40
Manually Measuring Transmitter Modulation Frequency Response and Distortion Factor -----	6-42
Manually Measuring Transmitter Signal/Noise Ratio and Residual Modulation -----	6-44
Manually Measuring Transmitter Modulation Limiter -----	6-46
Measuring Transmitter Harmonics and Spurious Responses -----	6-48
Measuring Transmitter Adjacent Channel Output -----	6-50

<u>DUPLEX MEASUREMENTS</u> -----	6-52
----------------------------------	------

SIGNAL/NOISE (S/N) RATIO METHOD

Receiver sensitivity is the EMF of 4040 at the receiver input, which produces a defined signal/noise ratio (S/N) with standard modulation on the nominal frequency of the receiver at the AF receiver output. Common signal/noise ratios are: With FM/PM= 20 dB S/N, with AM = 10 dB S/N - which are normally measured weighted (CCITTP53 filter).

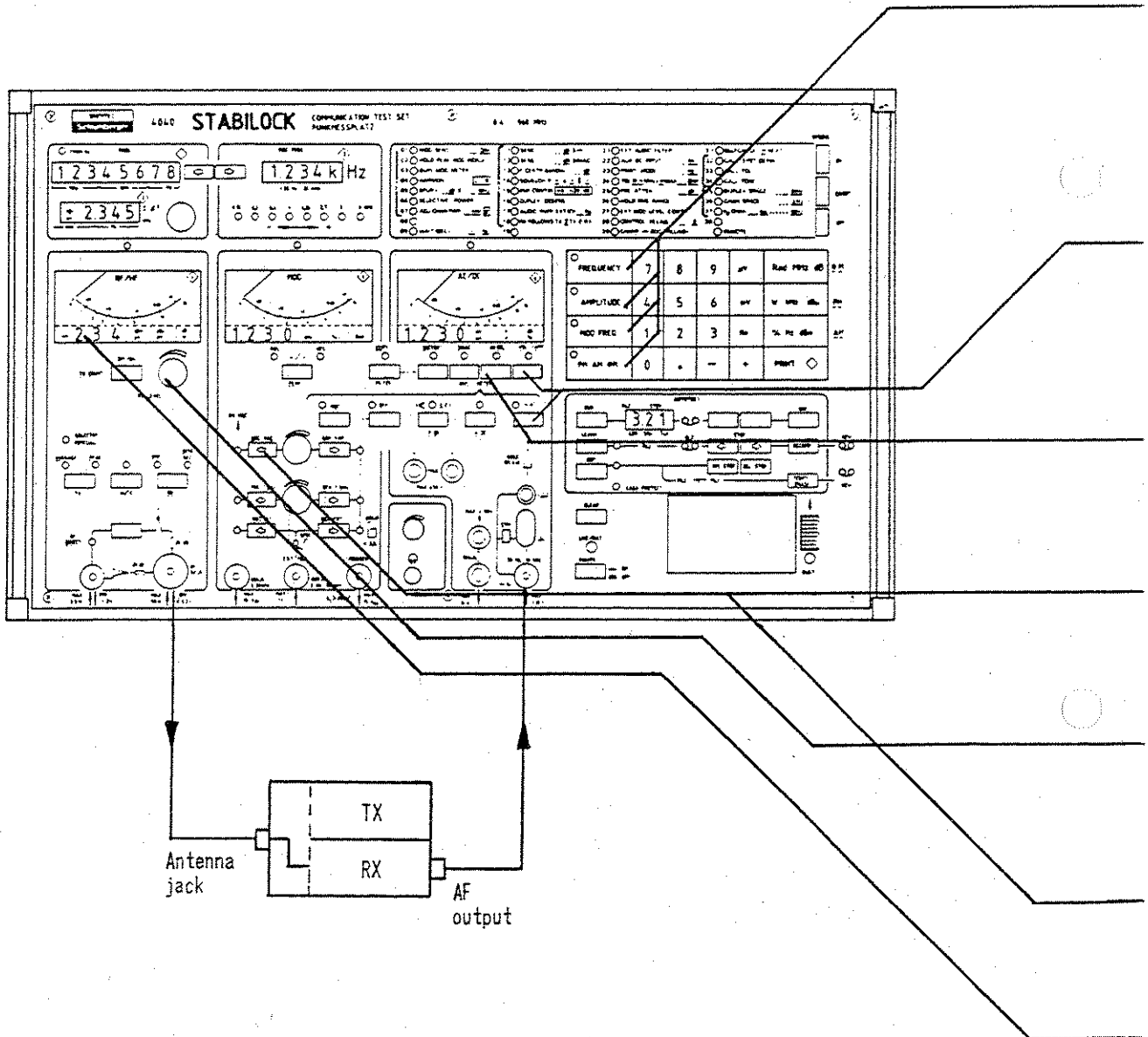
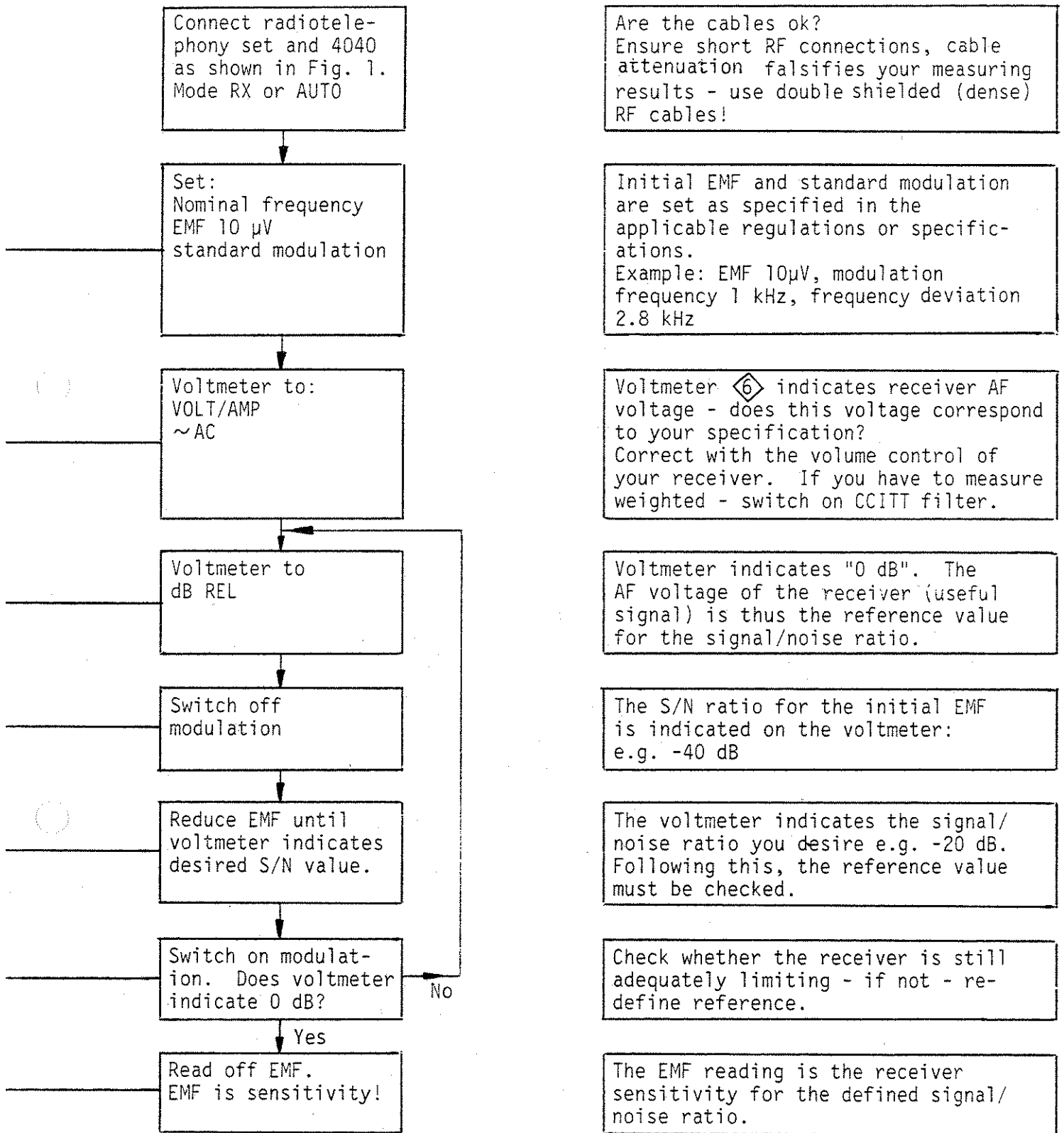

Fig. 1:
Test Configuration for Receiver Measurements



SIGNAL/NOISE RATIO METHOD USING THE S/N ROUTINE

Receiver sensitivity is the EMF of 4040 at the receiver input, which produces a defined signal/noise ratio (S/N) with standard modulation on the nominal frequency of the receiver at the AF receiver output. Common signal/noise ratios are:
With FM/ Φ M= 20 dB S/N, with AM = 10 dB S/N - which are normally measured weighted (CCITTP53 filter).

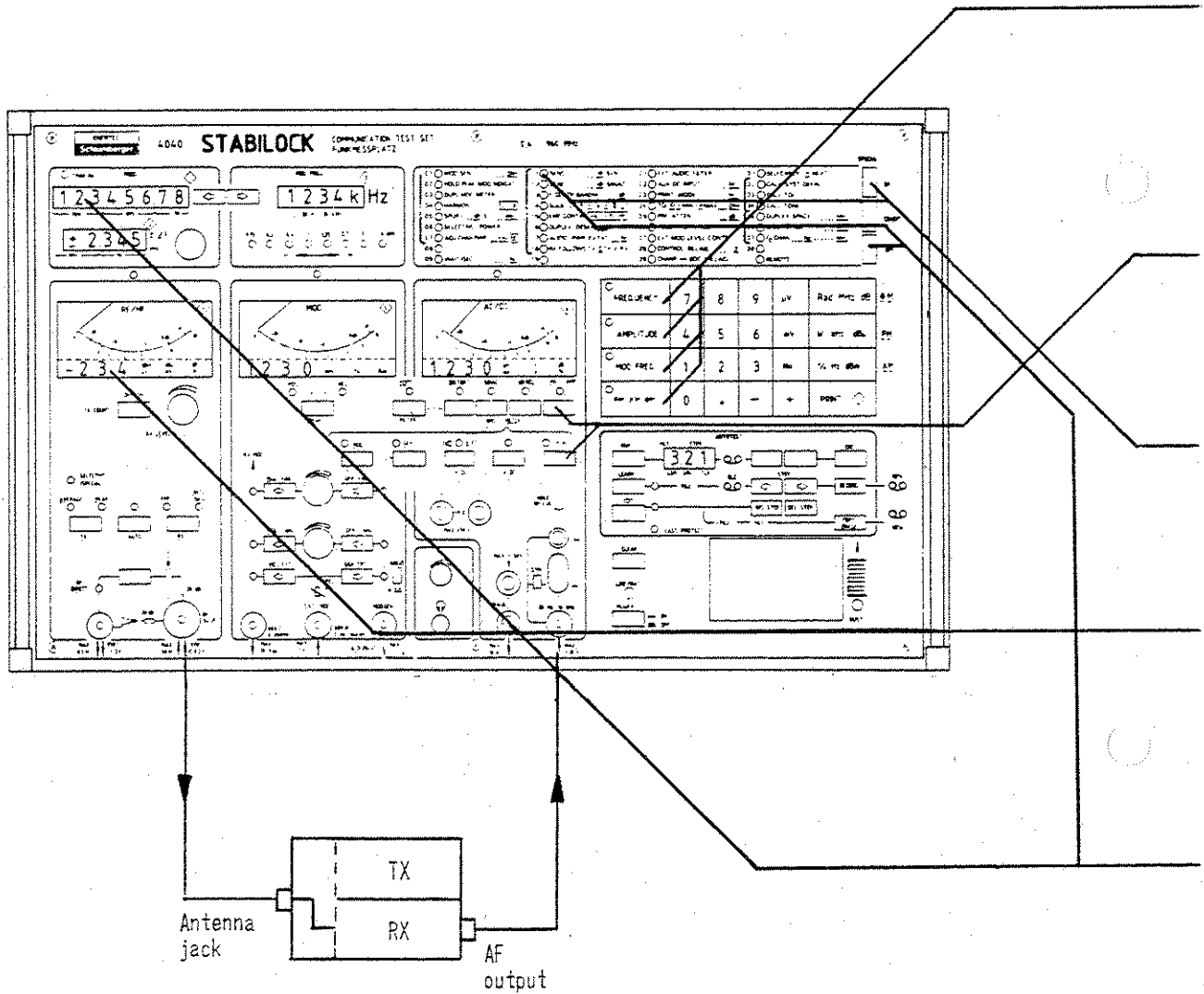
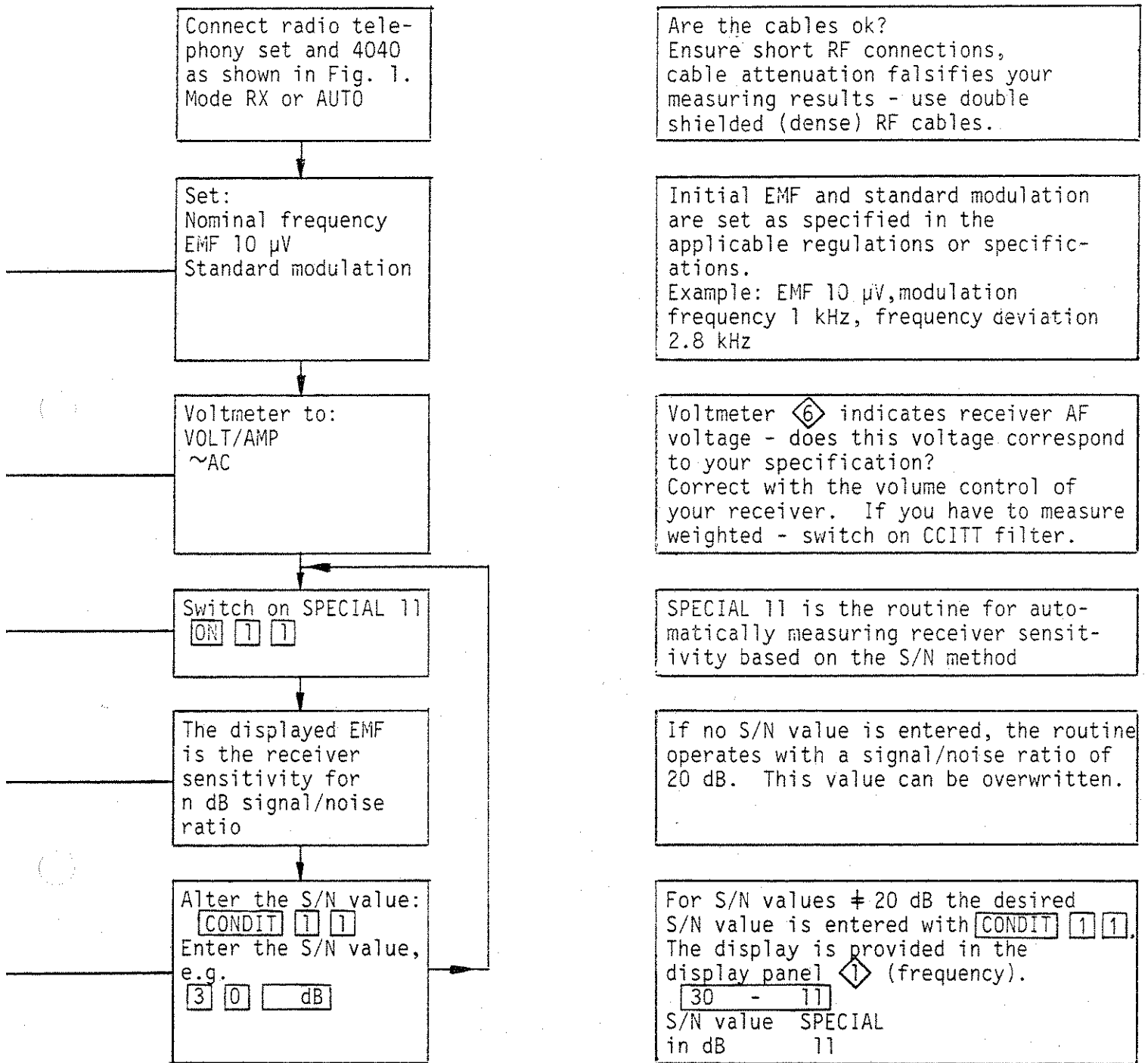

Fig. 1:
Test Configuration for Receiver Measurements

"Step for Step" Test Sequence

Explanations



Are the cables ok?
Ensure short RF connections, cable attenuation falsifies your measuring results - use double shielded (dense) RF cables.

Initial EMF and standard modulation are set as specified in the applicable regulations or specifications.
Example: EMF 10 μV, modulation frequency 1 kHz, frequency deviation 2.8 kHz

Voltmeter ⑥ indicates receiver AF voltage - does this voltage correspond to your specification?
Correct with the volume control of your receiver. If you have to measure weighted - switch on CCITT filter.

SPECIAL 11 is the routine for automatically measuring receiver sensitivity based on the S/N method

If no S/N value is entered, the routine operates with a signal/noise ratio of 20 dB. This value can be overwritten.

For S/N values ≠ 20 dB the desired S/N value is entered with CONDIT 1 1. The display is provided in the display panel ① (frequency).
30 - 11
S/N value SPECIAL
in dB 11

MANUALLY MEASURING RECEIVER SENSITIVITY BASED ON THE SINAD (SND/ND) METHOD

Receiver sensitivity is the EMF of 4040 at the receiver input, which produces a defined SINAD (SND/ND) ratio with standard modulation on the nominal frequency of the receiver at the AF receiver output.

$$\text{SINAD (dB)} = \frac{S+N+D}{N+D}$$

- S = signal
- N = noise
- D = distortion

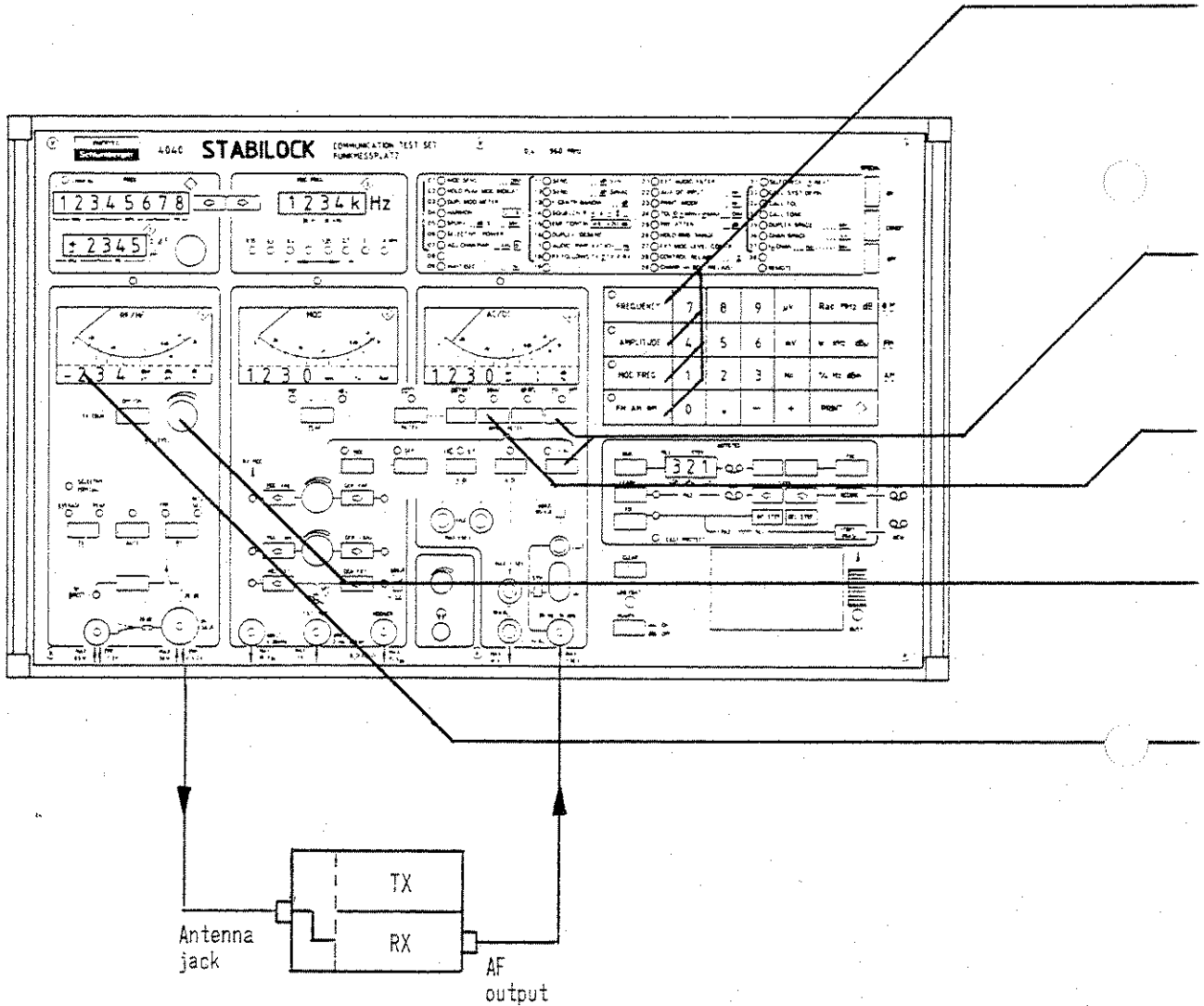
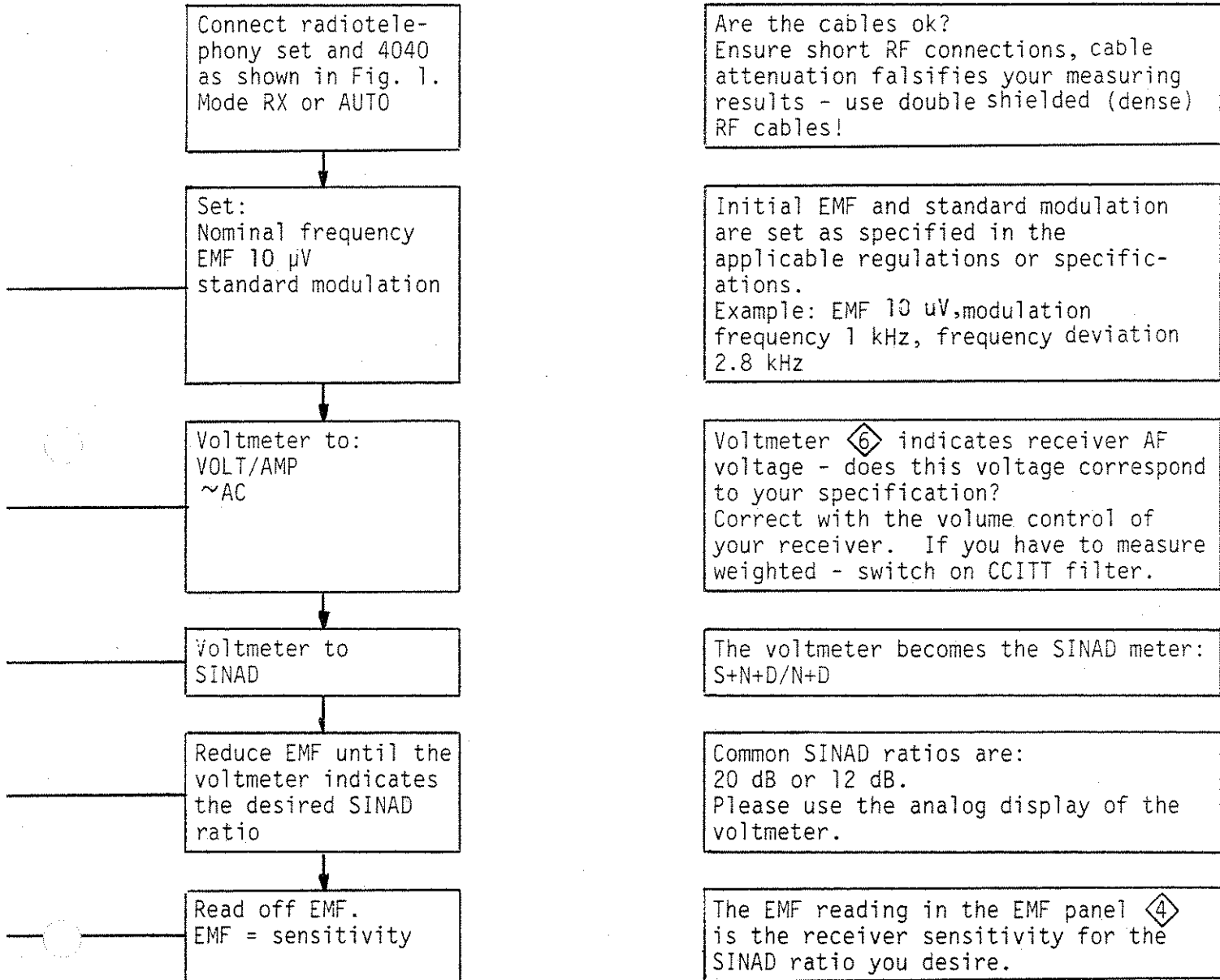

Fig. 1:
Test Configuration for Receiver Measurements



Connect radiotelephony set and 4040 as shown in Fig. 1. Mode RX or AUTO

Are the cables ok?
Ensure short RF connections, cable attenuation falsifies your measuring results - use double shielded (dense) RF cables!

Set:
Nominal frequency
EMF 10 μV
standard modulation

Initial EMF and standard modulation are set as specified in the applicable regulations or specifications.
Example: EMF 10 uV, modulation frequency 1 kHz, frequency deviation 2.8 kHz

Voltmeter to:
VOLT/AMP
~AC

Voltmeter $\diamond 6$ indicates receiver AF voltage - does this voltage correspond to your specification?
Correct with the volume control of your receiver. If you have to measure weighted - switch on CCITT filter.

Voltmeter to
SINAD

The voltmeter becomes the SINAD meter:
 $S+N+D/N+D$

Reduce EMF until the voltmeter indicates the desired SINAD ratio

Common SINAD ratios are:
20 dB or 12 dB.
Please use the analog display of the voltmeter.

Read off EMF.
EMF = sensitivity

The EMF reading in the EMF panel $\diamond 4$ is the receiver sensitivity for the SINAD ratio you desire.

AUTOMATICALLY MEASURING RECEIVER SENSITIVITY BASED ON
THE SINAD METHOD USING SINAD ROUTINES

Receiver sensitivity is the EMF of 4040 at the receiver input, which produces a defined SINAD ratio with standard modulation on the nominal frequency of the receiver at the AF receiver output.

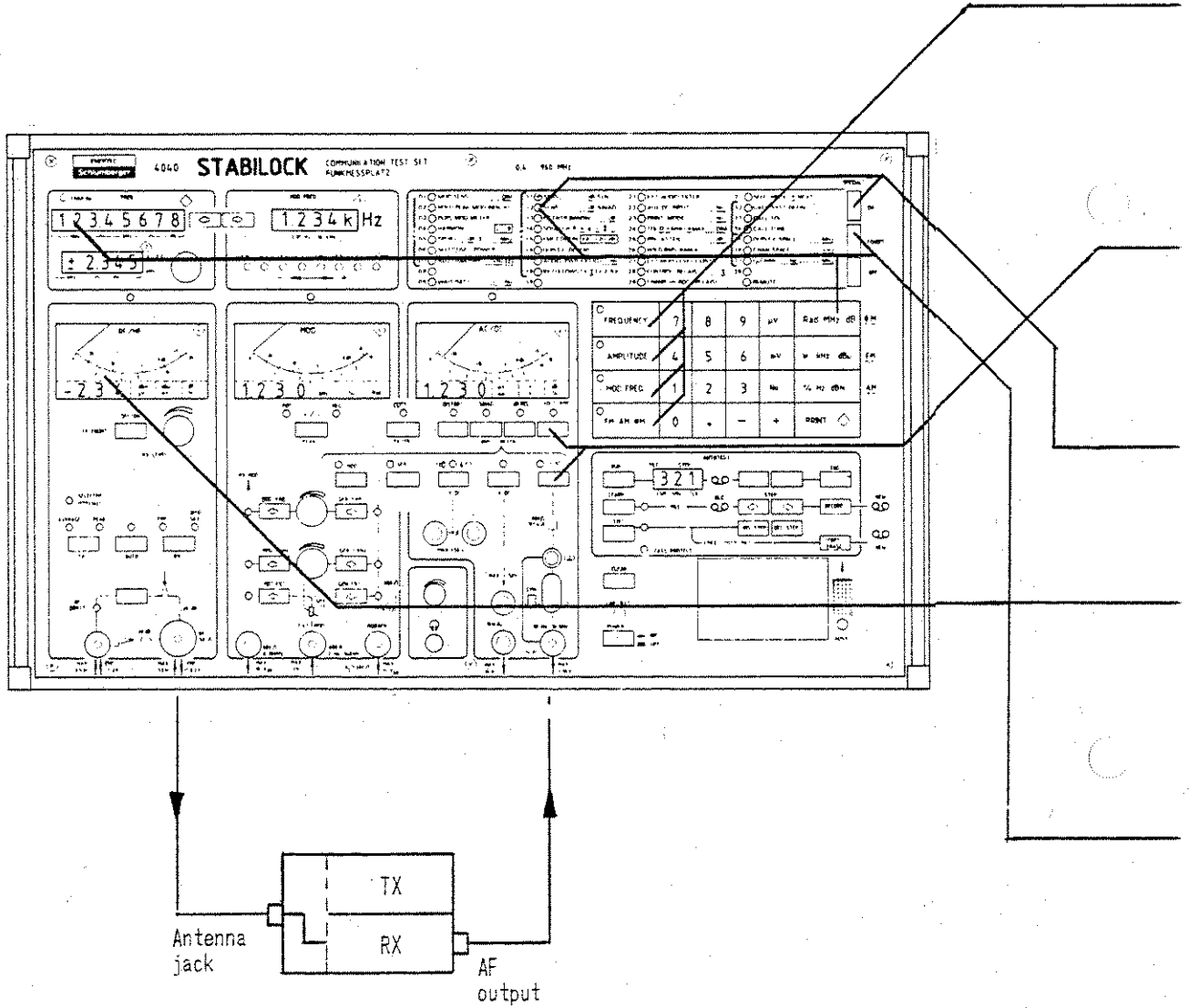
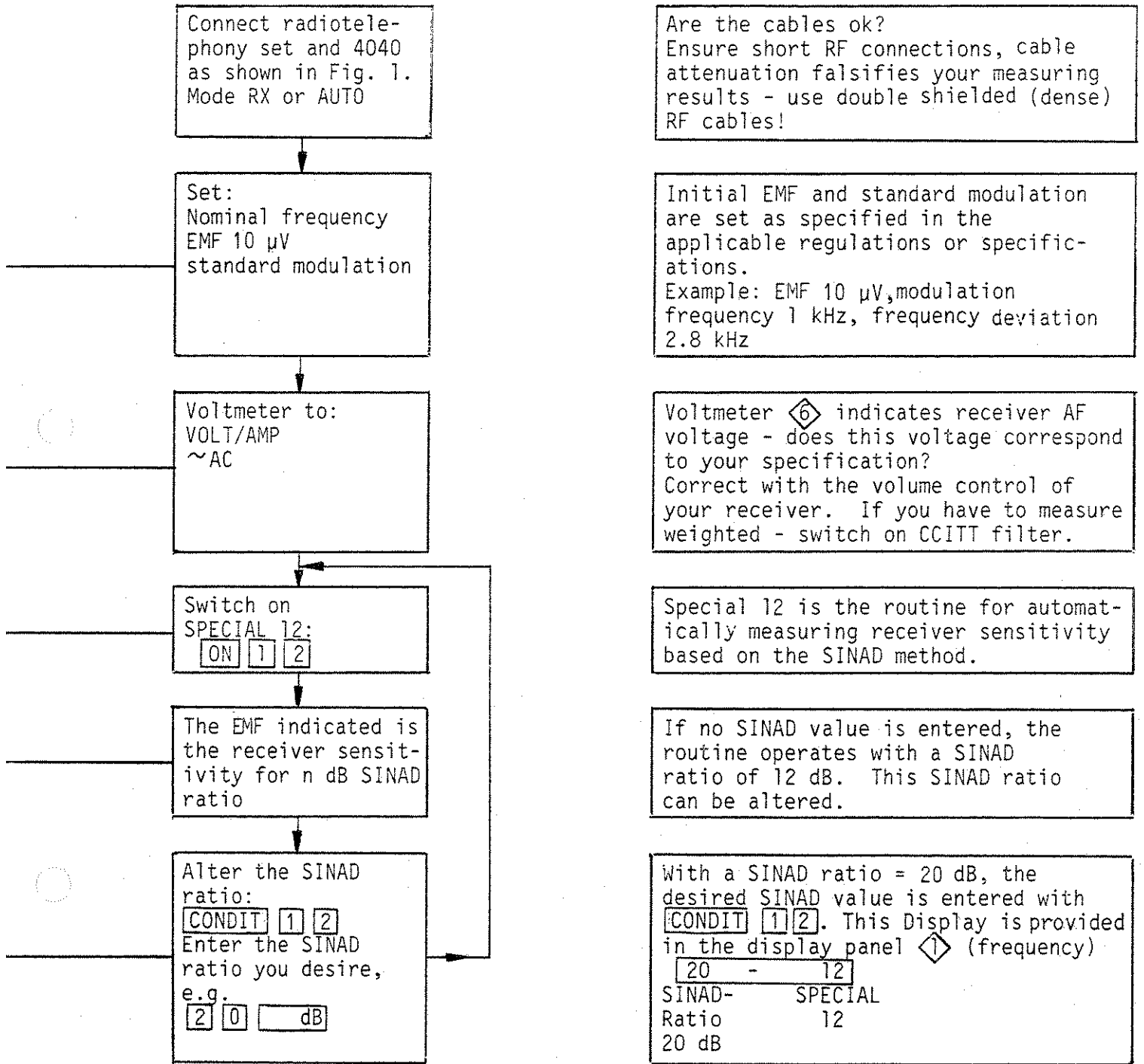

Fig. 1:
Test Configuration for Receiver Measurements



Connect radiotelephony set and 4040 as shown in Fig. 1. Mode RX or AUTO

Are the cables ok?
Ensure short RF connections, cable attenuation falsifies your measuring results - use double shielded (dense) RF cables!

Set:
Nominal frequency
EMF 10 μ V
standard modulation

Initial EMF and standard modulation are set as specified in the applicable regulations or specifications.
Example: EMF 10 μ V, modulation frequency 1 kHz, frequency deviation 2.8 kHz

Voltmeter to:
VOLT/AMP
 \sim AC

Voltmeter \diamond 6 indicates receiver AF voltage - does this voltage correspond to your specification?
Correct with the volume control of your receiver. If you have to measure weighted - switch on CCITT filter.

Switch on
SPECIAL 12:
ON 1 2

Special 12 is the routine for automatically measuring receiver sensitivity based on the SINAD method.

The EMF indicated is the receiver sensitivity for n dB SINAD ratio

If no SINAD value is entered, the routine operates with a SINAD ratio of 12 dB. This SINAD ratio can be altered.

Alter the SINAD ratio:
CONDIT 1 2
Enter the SINAD ratio you desire, e.g.
20 dB

With a SINAD ratio = 20 dB, the desired SINAD value is entered with CONDIT 1 2. This Display is provided in the display panel \diamond (frequency)

20	-	12
SINAD-		SPECIAL
Ratio		12
20 dB		

MANUALLY MEASURING THE SIGNAL/NOISE RATIO OR SINAD RATIO WITH SPECIFIED EMF

The signal/noise ratio or the SINAD ratio, respectively, is measured at a specified EMF.

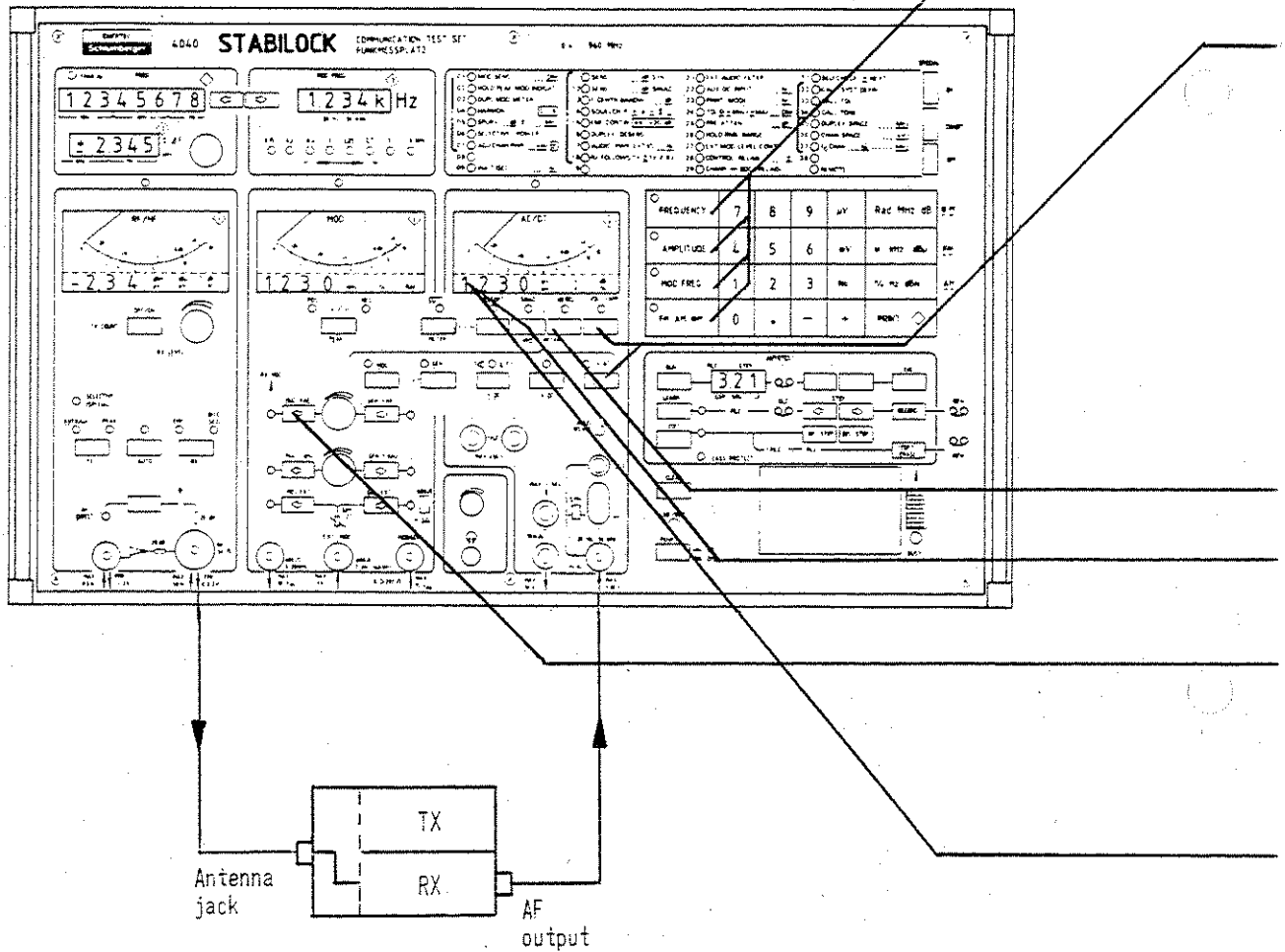
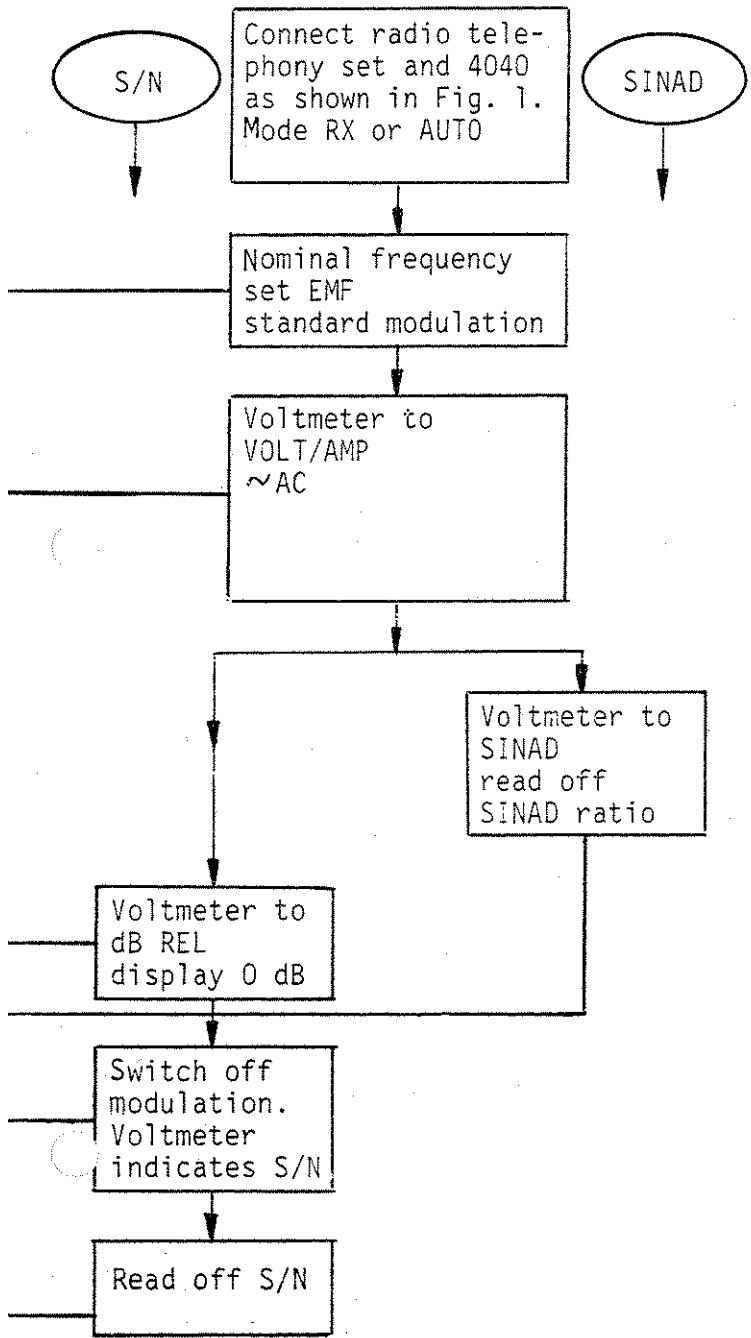

Fig. 1.:
Test Configuration for Receiver Measurements



Are the cables ok?
Ensure short RF connections, cable attenuation falsifies your test result - use double shielded (dense) RF cables.

Set specified EMF (e.g. 2 μ V, 20 μ V etc.) for SINAD measurement, 1 kHz modulation frequency must be set.

Voltmeter $\diamond 6$ indicates receiver AF voltage - does this voltage correspond to your specification?
Correct with the volume control of your receiver. If you have to measure weighted - switch on CCITT filter

The SINAD ratio indicated on the voltmeter is the measuring result sought. Use the analog display of the voltmeter

The S/N ratio reading is the one sought at the specified EMF

MANUALLY MEASURING RECEIVER BANDWIDTH AND RECEIVER CENTRE FREQUENCY OFFSET

The receiver bandwidth is the total of the amounts of the positive and negative frequency detuning of the 4040 related to the nominal frequency of the receiver which, after an increase in EMF of +6 dB, produce the same AF level at the receiver output as existed before increasing the EMF to the nominal frequency. $B = |\Delta f1| + |\Delta f2|$

The centre frequency offset is half the difference of the amounts of the frequency detuning. Centre frequency offset = $\frac{\Delta f1 - \Delta f2}{2}$

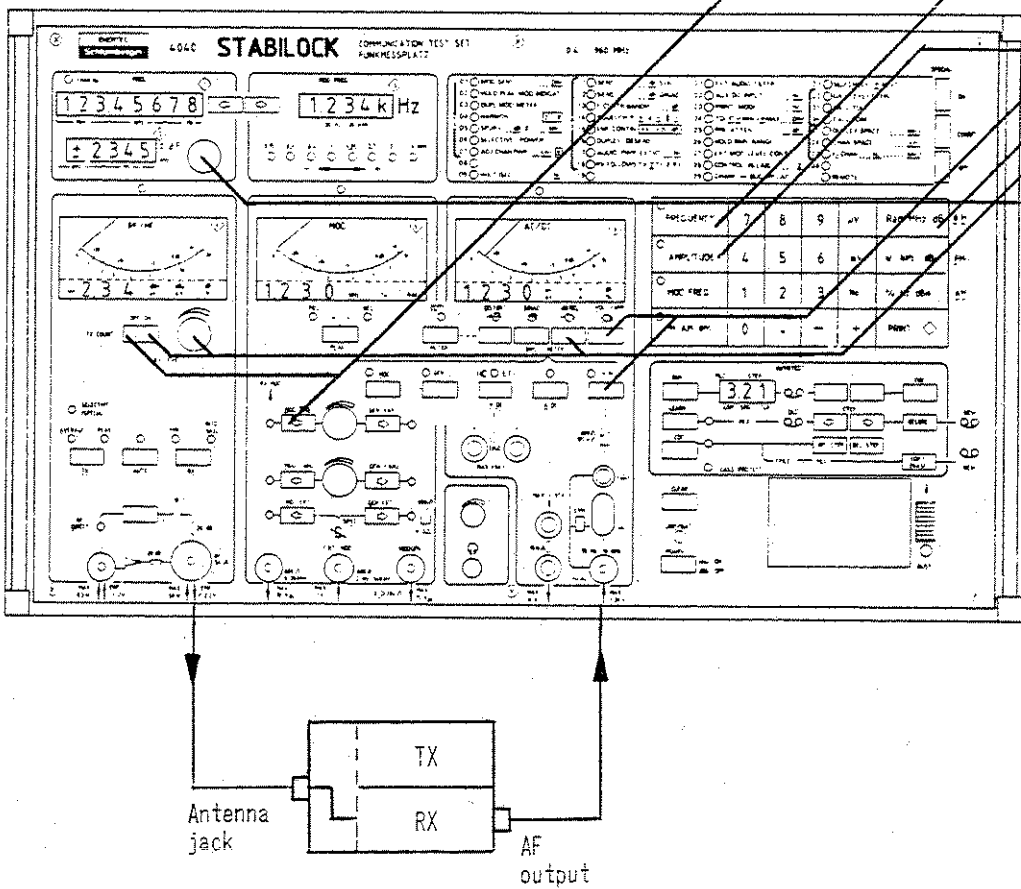
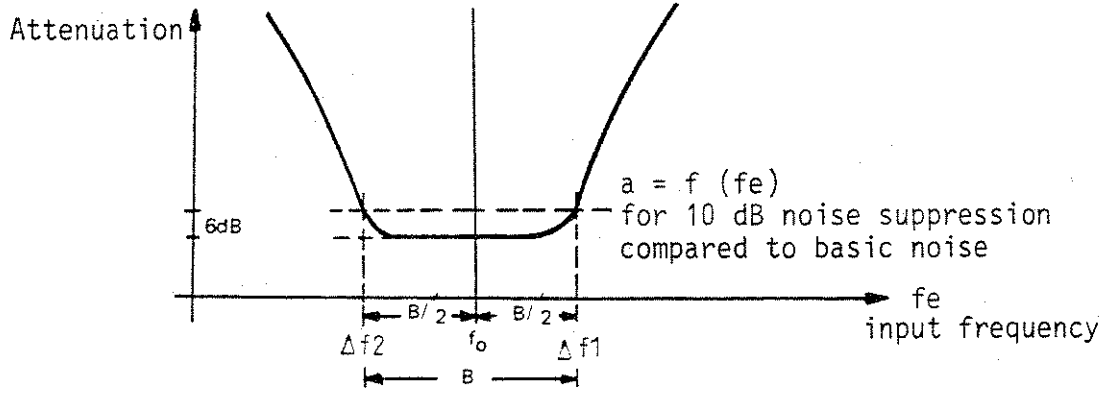
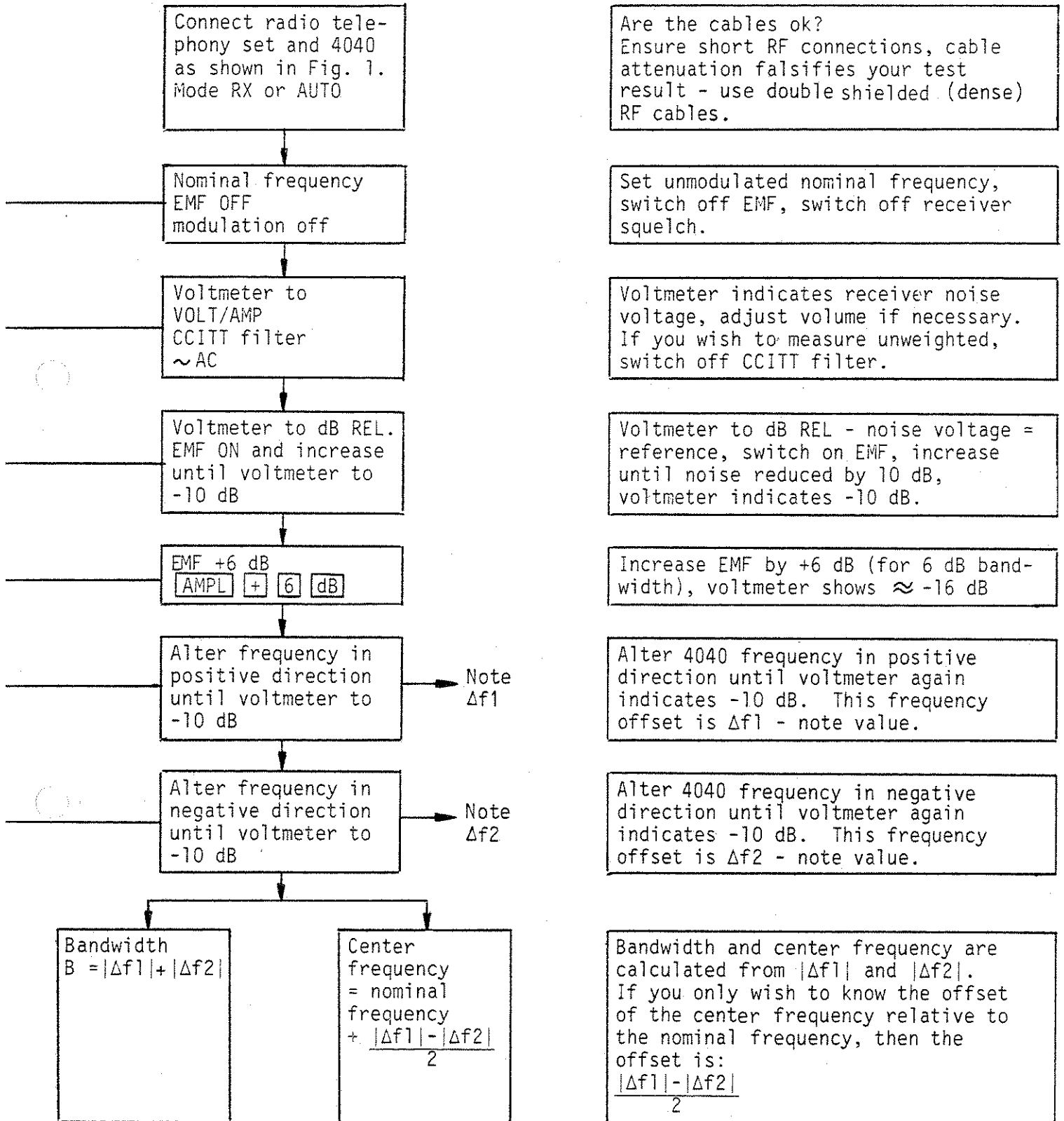

Fig. 1:
Test Configuration for Receiver Measurements



Are the cables ok?
Ensure short RF connections, cable attenuation falsifies your test result - use double shielded (dense) RF cables.

Set unmodulated nominal frequency, switch off EMF, switch off receiver squelch.

Voltmeter indicates receiver noise voltage, adjust volume if necessary. If you wish to measure unweighted, switch off CCITT filter.

Voltmeter to dB REL - noise voltage = reference, switch on EMF, increase until noise reduced by 10 dB, voltmeter indicates -10 dB.

Increase EMF by +6 dB (for 6 dB bandwidth), voltmeter shows \approx -16 dB

Alter 4040 frequency in positive direction until voltmeter again indicates -10 dB. This frequency offset is Δf_1 - note value.

Alter 4040 frequency in negative direction until voltmeter again indicates -10 dB. This frequency offset is Δf_2 - note value.

Bandwidth
 $B = |\Delta f_1| + |\Delta f_2|$

Center frequency
 = nominal frequency
 $+ \frac{|\Delta f_1| - |\Delta f_2|}{2}$

Bandwidth and center frequency are calculated from $|\Delta f_1|$ and $|\Delta f_2|$. If you only wish to know the offset of the center frequency relative to the nominal frequency, then the offset is:
 $\frac{|\Delta f_1| - |\Delta f_2|}{2}$

AUTOMATICALLY MEASURING RECEIVER BANDWIDTH AND RECEIVER CENTER FREQUENCY OFFSET USING THE SPECIAL 13 ROUTINE

The receiver bandwidth is the total of the amounts of the positive and negative frequency detuning of the 4040 related to the nominal frequency of the receiver which, after an increase in EMF of +6 dB, produce the same AF level at the receiver output as existed before increasing the EMF to the nominal frequency. $B = |\Delta f_1| + |\Delta f_2|$

The center frequency offset is half the difference of the amounts of the frequency detuning. Center frequency offset = $\frac{\Delta f_1 - \Delta f_2}{2}$

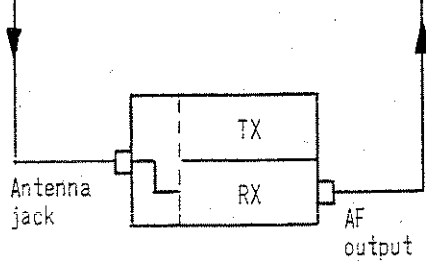
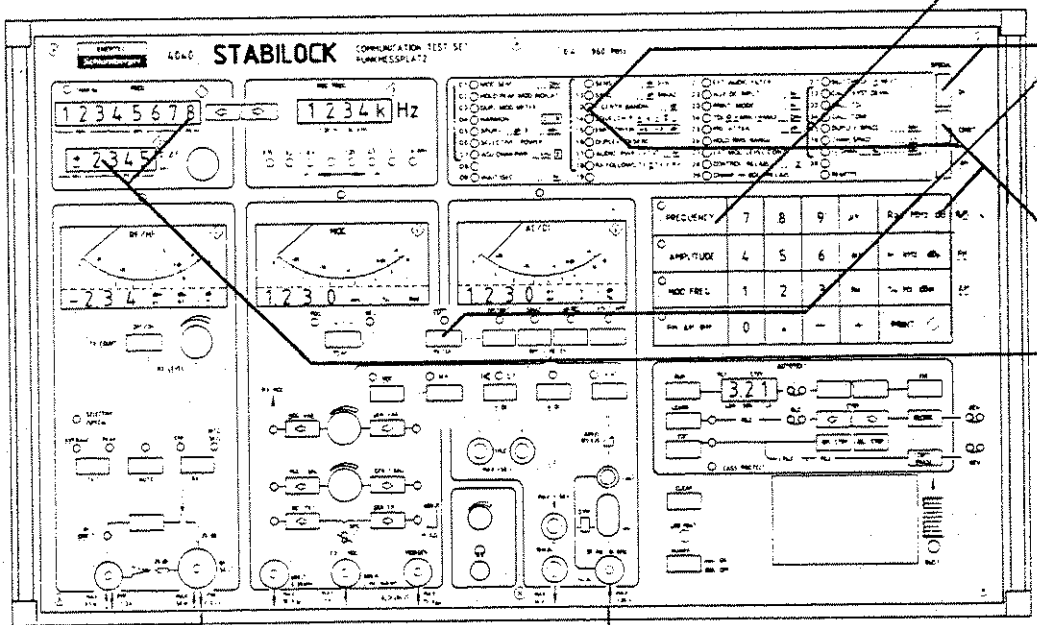
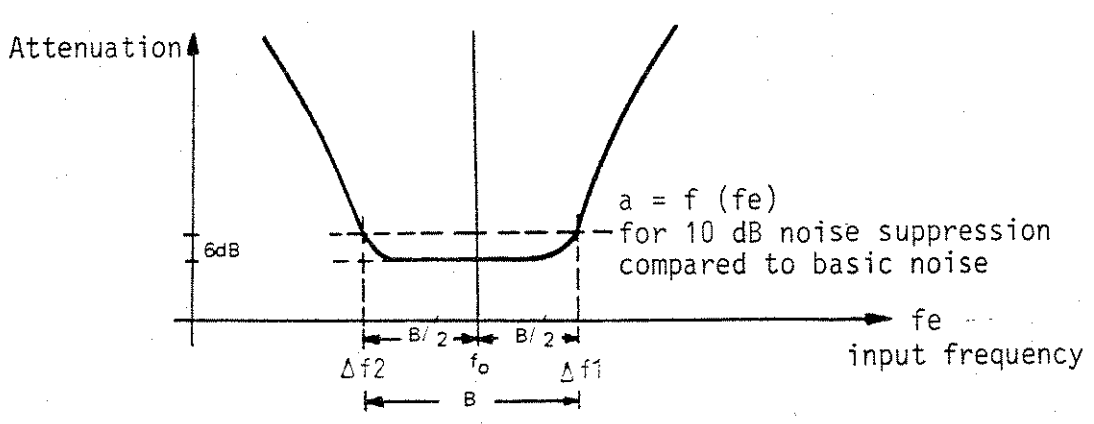

Fig. 1.:
Test Configuration for Receiver Measurements

Connect radio telephony set and 4040 as shown in Fig. 1. Mode RX or AUTO

Are the cables ok?
Ensure short RF connections, cable attenuation falsifies your test result - use double shielded (dense) RF cables.

Set nominal frequency

Set the nominal frequency of the receiver - switch off the receiver squelch. All other settings are performed automatically by the 4040.

CCITT filter?

Check whether your specifications require the measurement to be performed with or without CCITT filter, if not - switch off filter.

Switch on SPECIAL 13
ON 1 3

SPECIAL 13 is the routine for automatically measuring receiver bandwidth and center frequency offset. Without entering a dB value for the 6 dB bandwidth. This value can be altered.

Results of measurement:
Center frequency offset in display panel Δf
[] \diamond 2
Bandwidth in frequency display panel
[] \diamond 1

Alter bandwidth dB value:
CONDIT 13 X dB
X = 0.1...60 dB

MANUALLY MEASURING MODULATION ACCEPTANCE BANDWIDTH

The MODULATION ACCEPTANCE BANDWIDTH of a receiver is the frequency deviation at an EMF of 6 dB above receiver sensitivity which produces the same SINAD ratio at the receiver output as the standard modulation with the EMF of the receiver sensitivity.

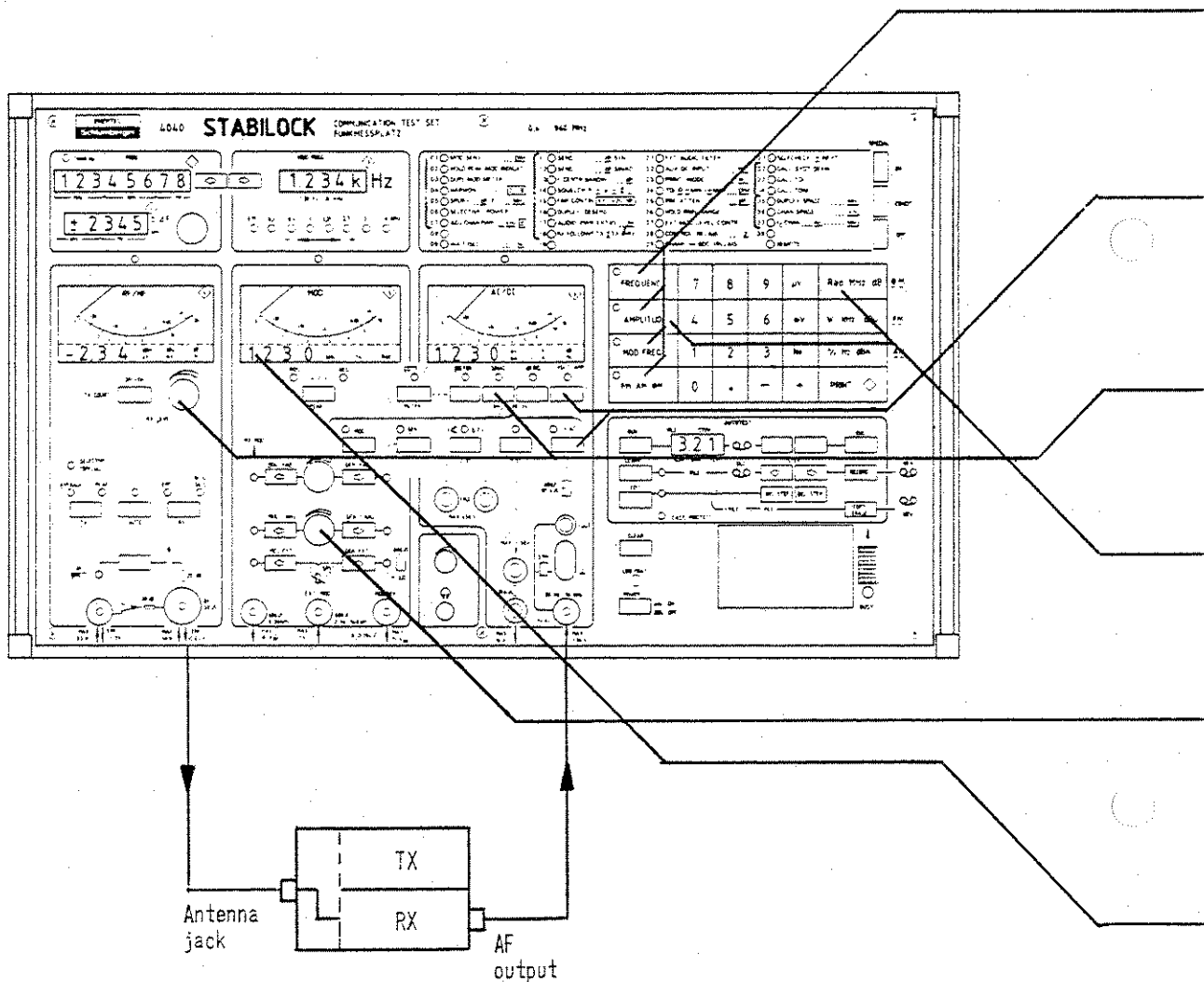
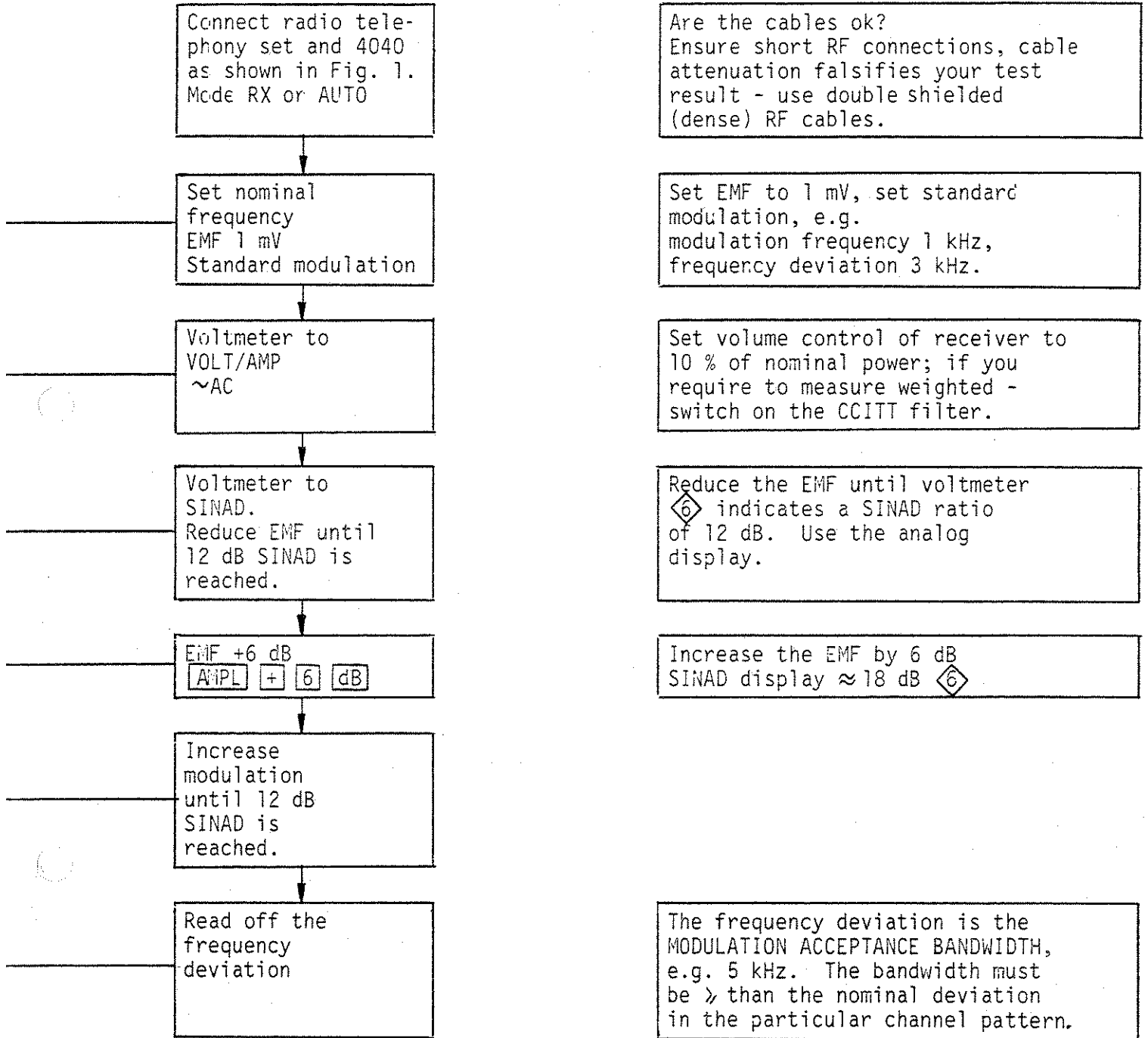

Fig. 1.:
Test Configuration for Receiver Measurements



Squelch level:

EMFI = cut-in EMF at which the squelch clears the AF path.

EMFO = cut-out EMF at which the squelch blocks the AF path.

Hysteresis:

The difference between cut-in and cut-out EMF in dB.

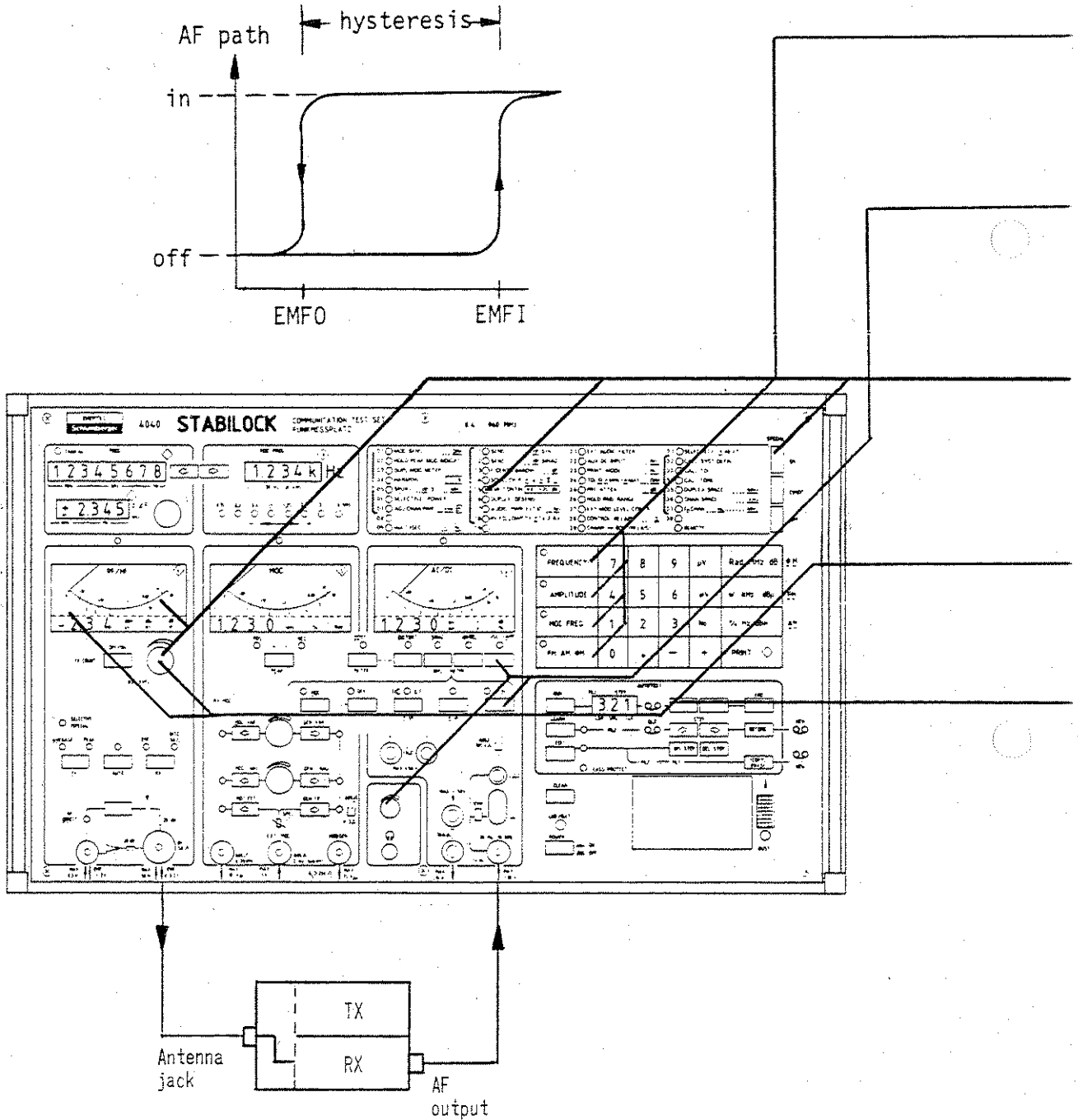

Fig. 1.:

Test Configuration for Receiver Measurements

Connect radio telephony set and 4040 as shown in Fig. 1. Mode RX or AUTO

Are the cables ok?
Ensure short RF connections, cable attenuation falsifies your test result - use double shielded (dense) RF cables.

Set:
Nominal frequency
EMF 10 μ V
Standard modulation

Voltmeter to:
VOLT/AMP
~AC
Set volume control

Increase EMF from 0 μ V until modulation is audible in speaker. ON 15

Switch on interruption free EMF range

Reduce EMF until modulation is inaudible.

→ Note EMFO

Read EMFO from the analog display $\diamond 4$

Increase EMF until modulation is audible in speaker

→ Note EMFI

Read EMFI from the analog display $\diamond 4$

Calculate squelch hysteresis

Hysteresis in μ V = EMFI - EMFO
Hysteresis in dB = $20 \lg \frac{EMFI}{EMFO}$

AUTOMATICALLY MEASURING SQUELCH PARAMETERS USING
THE INTEGRAL SQUELCH ROUTINE

Squelch level:

EMFI = cut-in EMF at which the squelch clears the AF path.

EMFO = cut-out EMF at which the squelch blocks the AF path.

Hysteresis:

The difference between cut-in and cut-out EMF in dB.

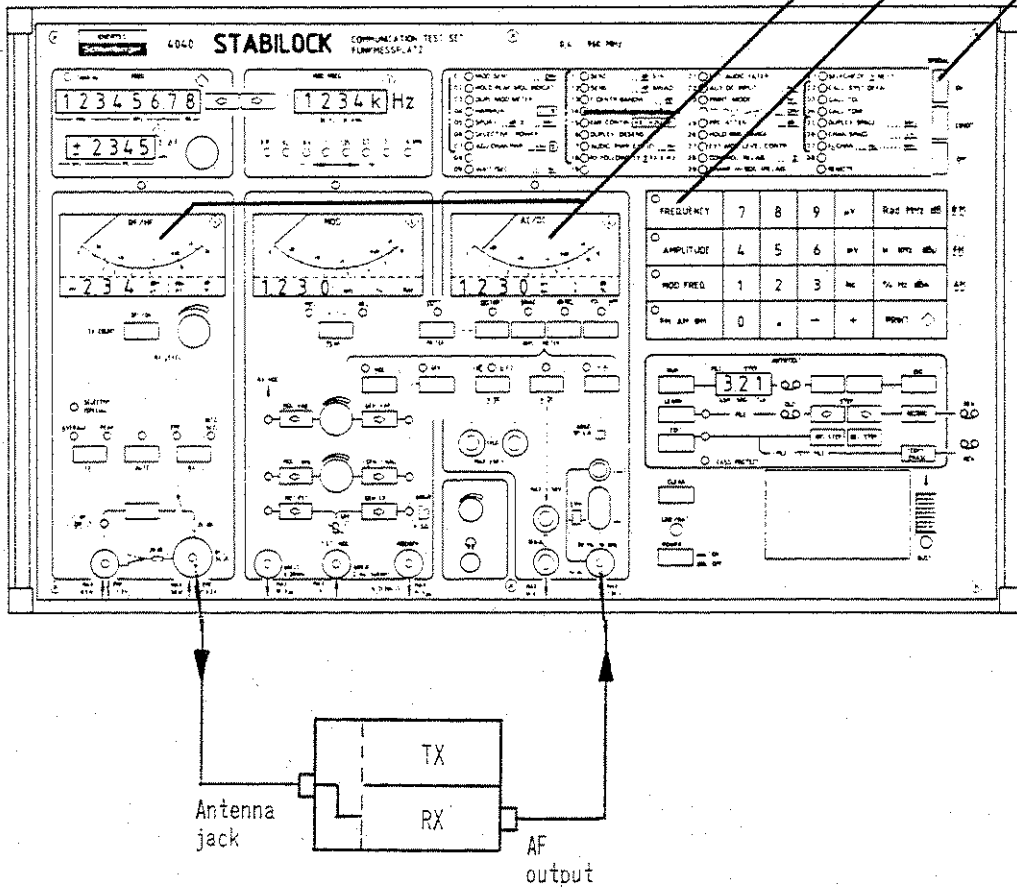
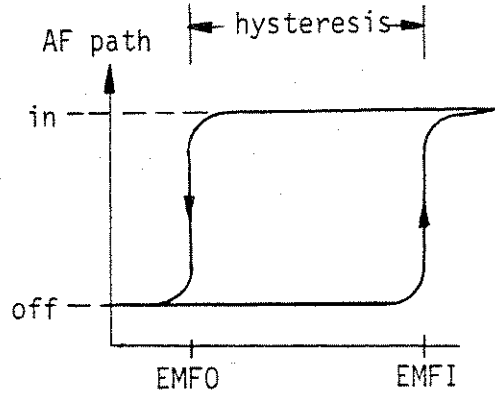

Fig. 1.:
Test Configuration for Receiver Measurements

Connect radio telephony set and 4040 as shown in Fig. 1. Mode RX or AUTO

Are the cables ok?
Ensure short RF connections, cable attenuation falsifies your test result - use double shielded (dense) RF cables.

Set nominal frequency

ON 14
Read off EMFI 4
Read off hysteresis in dB 6

SPECIAL 14 is the routine for automatically measuring the squelch parameters.

ON 41 ON 14
Read off EMFI 4
Read off hysteresis in dB 6

You will get the result for EMFO if you switch on SPECIAL 41 before ON 14
Reset by OFF 41

MANUALLY MEASURING RECEIVER FREQUENCY RESPONSE

The receiver AF frequency response is the change in the AF output level of the receiver dependent on the modulation frequency of the input signal.

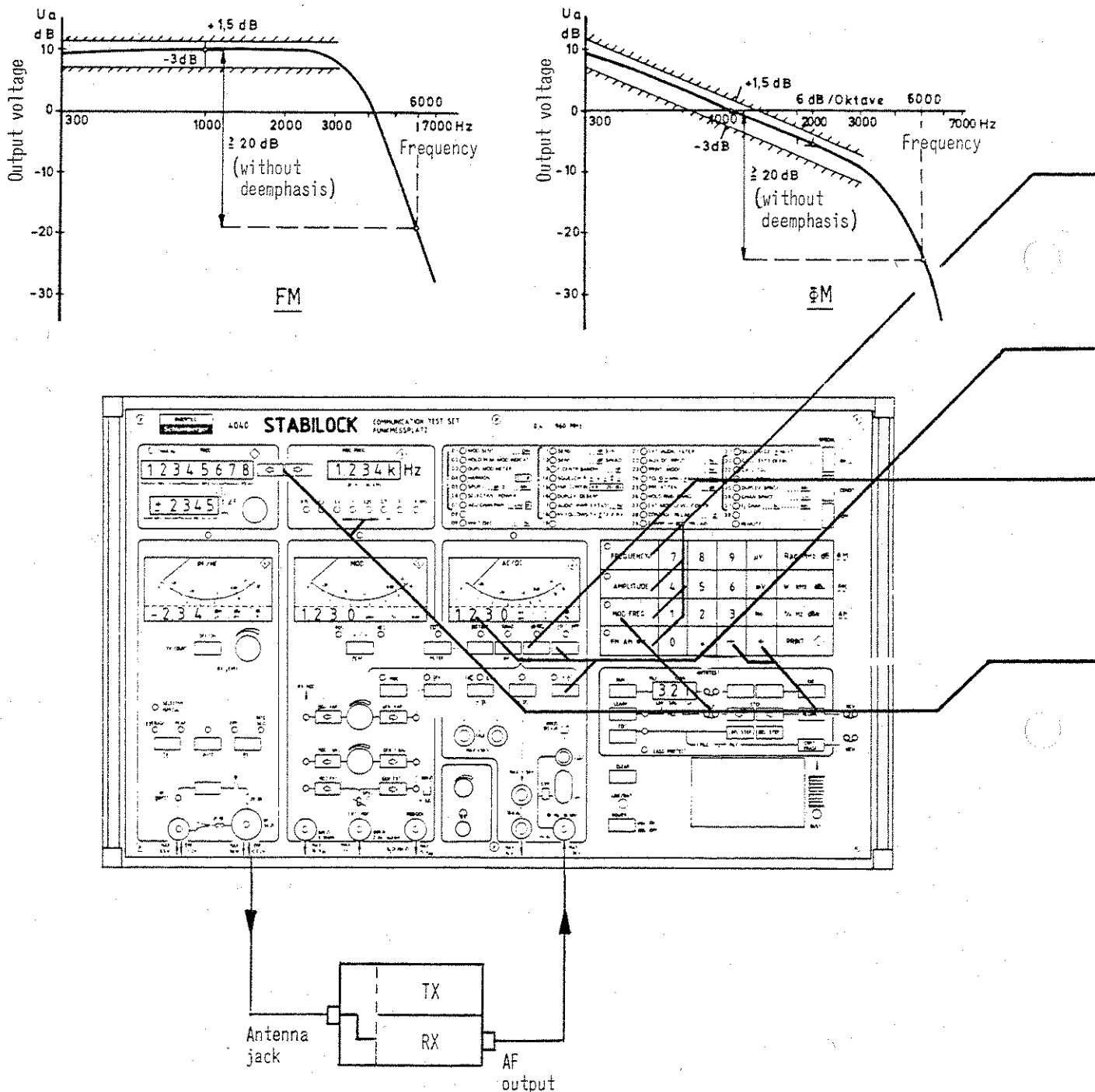
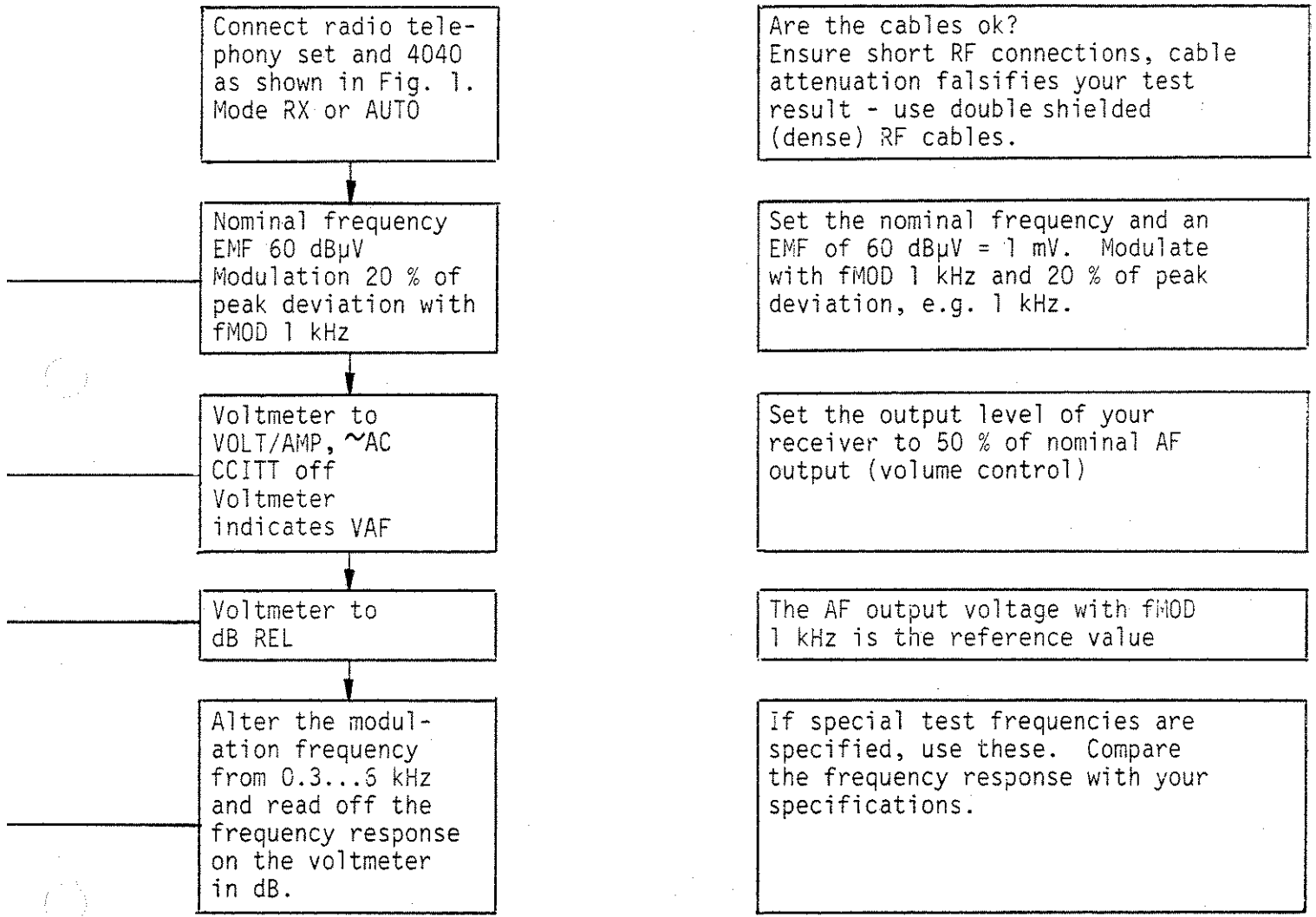

Fig. 1.:
Test Configuration for Receiver Measurements

Simple and Convenient Using the dB REL Function of the Voltmeter



Connect radio telephony set and 4040 as shown in Fig. 1. Mode RX or AUTO

Are the cables ok?
Ensure short RF connections, cable attenuation falsifies your test result - use double shielded (dense) RF cables.

Nominal frequency EMF 60 dBµV
Modulation 20 % of peak deviation with fMOD 1 kHz

Set the nominal frequency and an EMF of 60 dBµV = 1 mV. Modulate with fMOD 1 kHz and 20 % of peak deviation, e.g. 1 kHz.

Voltmeter to VOLT/AMP, ~AC
CCITT off
Voltmeter indicates VAF

Set the output level of your receiver to 50 % of nominal AF output (volume control)

Voltmeter to dB REL

The AF output voltage with fMOD 1 kHz is the reference value

Alter the modulation frequency from 0.3...5 kHz and read off the frequency response on the voltmeter in dB.

If special test frequencies are specified, use these. Compare the frequency response with your specifications.

The signal/noise ratio is the ratio in dB between the AF level of the signal with standard modulation and the unmodulated signal at the receiver output with the same EMF.

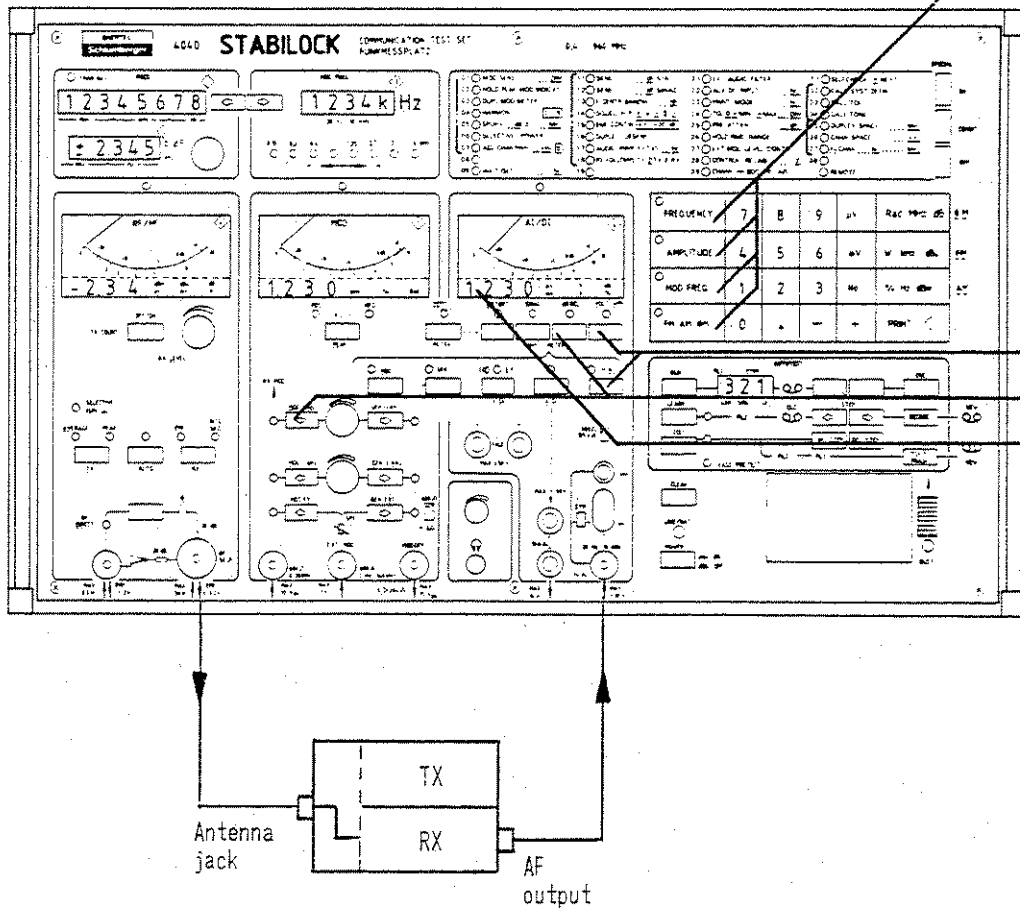
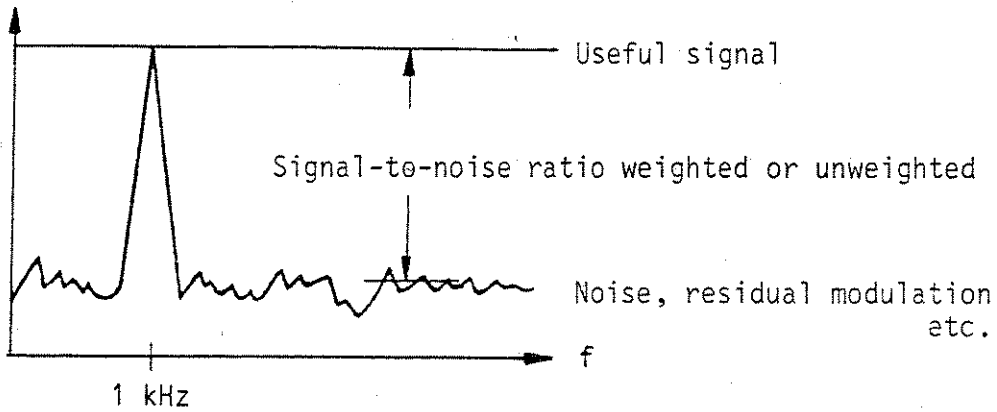

Fig. 1.:
Test Configuration for Receiver Measurements

Connect radio telephony set and 4040 as shown in Fig. 1. Mode RX or AUTO

Are the cables ok?
Ensure short RF connections, table attenuation falsifies your measuring results - use double shielded (dense) RF cables.

Nominal frequency
EMF 30 dB μ V
Standard modulation

Set measuring conditions according to your specifications, e.g. EMF 30 dB μ V, fMOD 1 kHz, frequency deviation 2.8 kHz.

Voltmeter to:
VOLT/AMP
 \sim AC

Do you require to measure weighted? Then switch on CCITT filter. Set volume control of receiver to specified output voltage.

Voltmeter to:
dB REL
Switch off modulation

The specified AF voltage is the reference value for measuring S/N ratio. Switch off the modulation.

Read off S/N ratio at voltmeter, e.g. -40 dB

MANUALLY MEASURING RECEIVER AF OUTPUT AND DISTORTION FACTOR

The AF output of a receiver is generally measured at a load resistance of $5\ \Omega$ (speaker jack) or $200\ \Omega$ (headphone jack). The distortion factor applies to the nominal output specified by the manufacturer and for standard deviation (70 % of peak deviation).

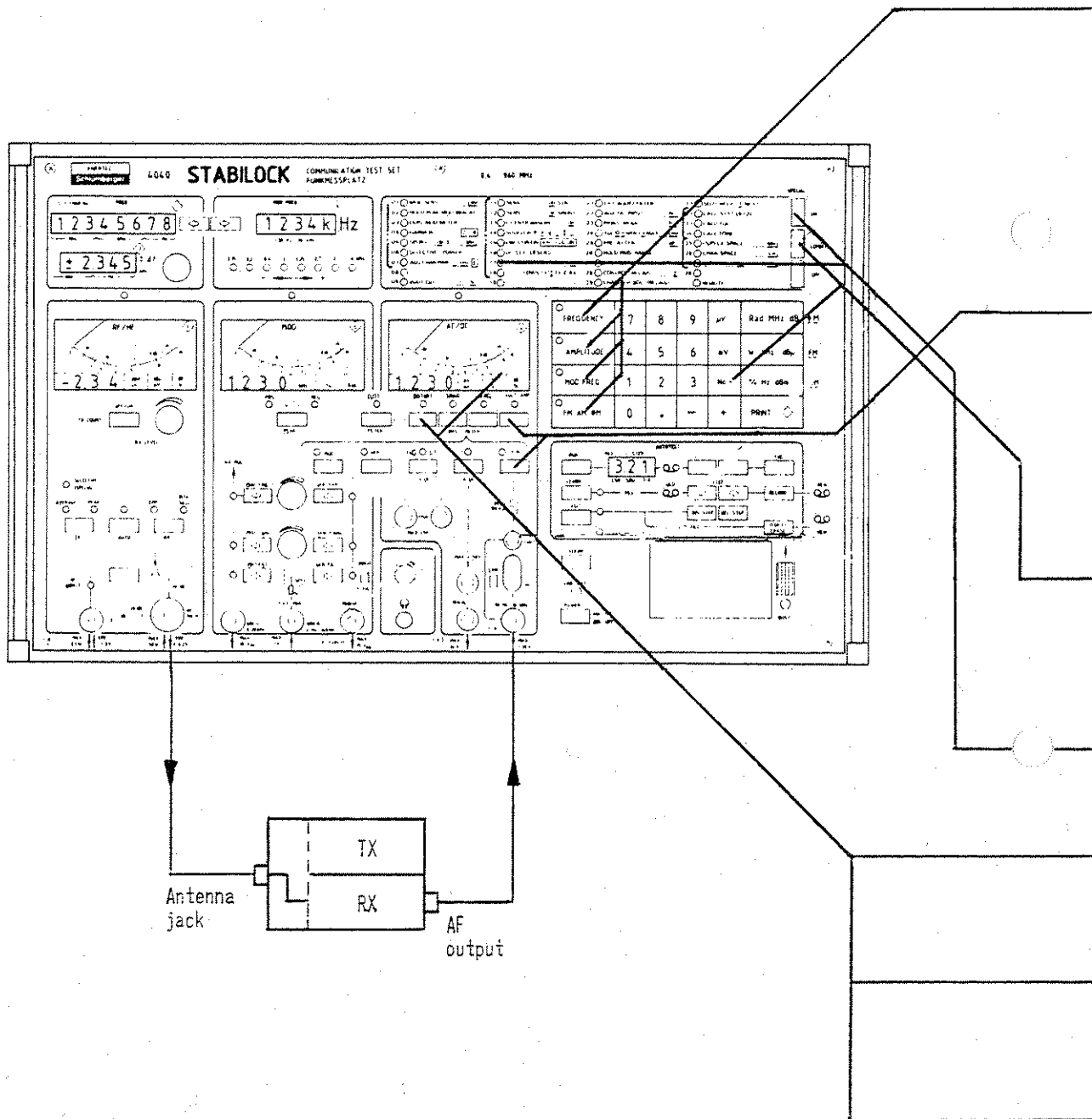
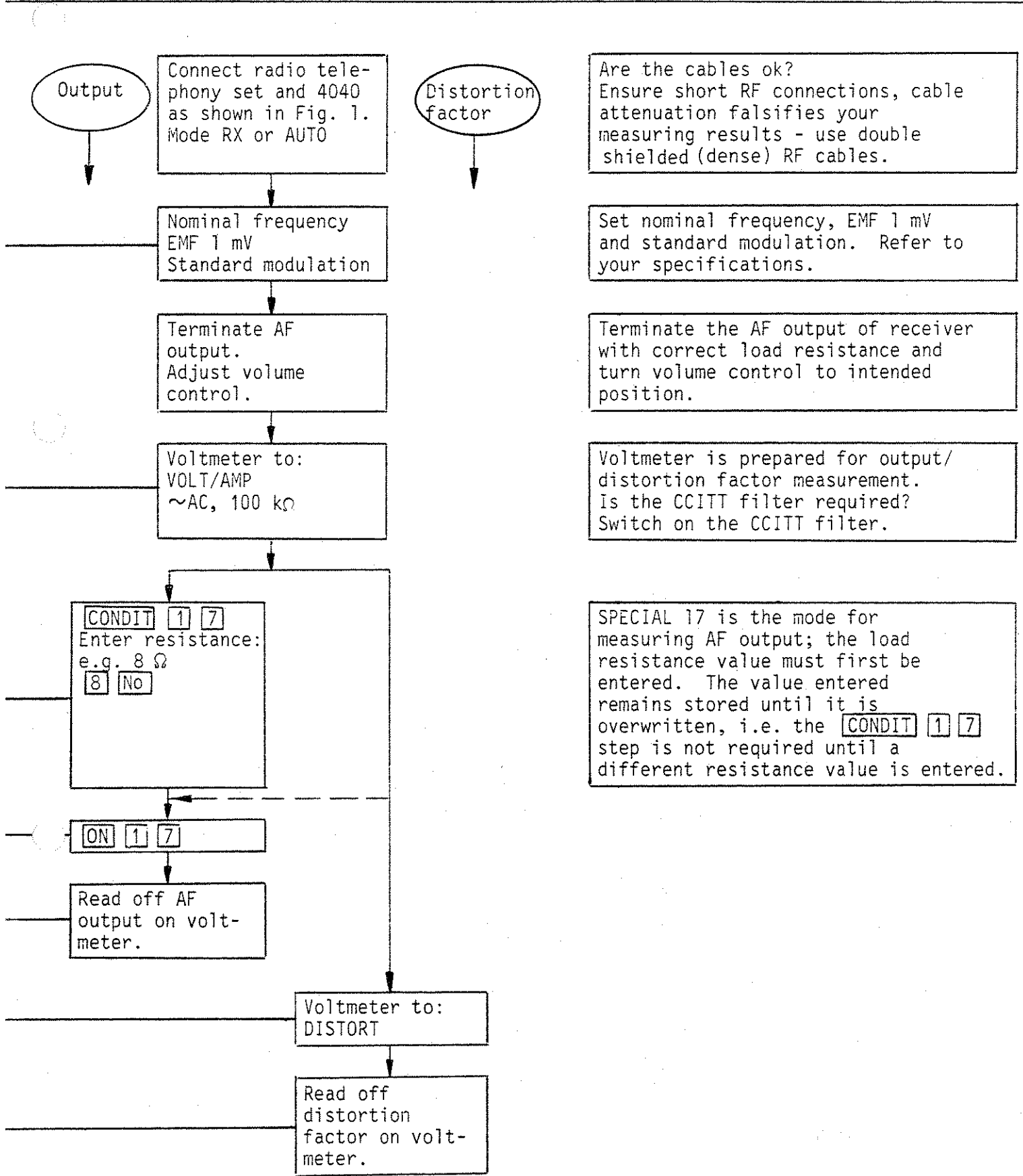

Fig. 1.:
Test Configuration for Receiver Measurements



The limiter characteristics state to what extent the AF output level of the receiver alters when its input signal level is altered by a certain value (e.g. from +6 to +100 dB μ V). Set value ≤ 3 dB. The input signal has standard modulation.

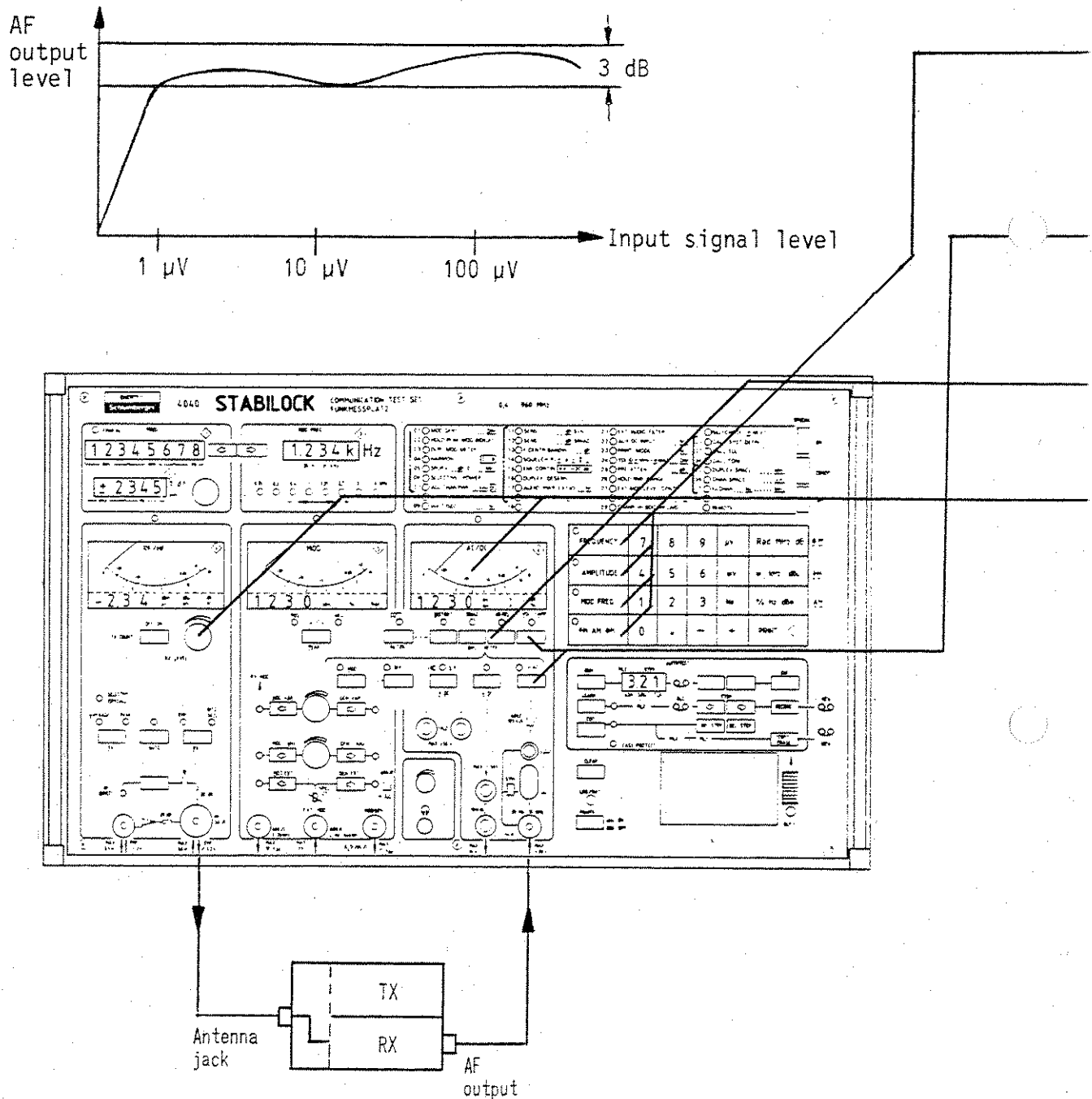
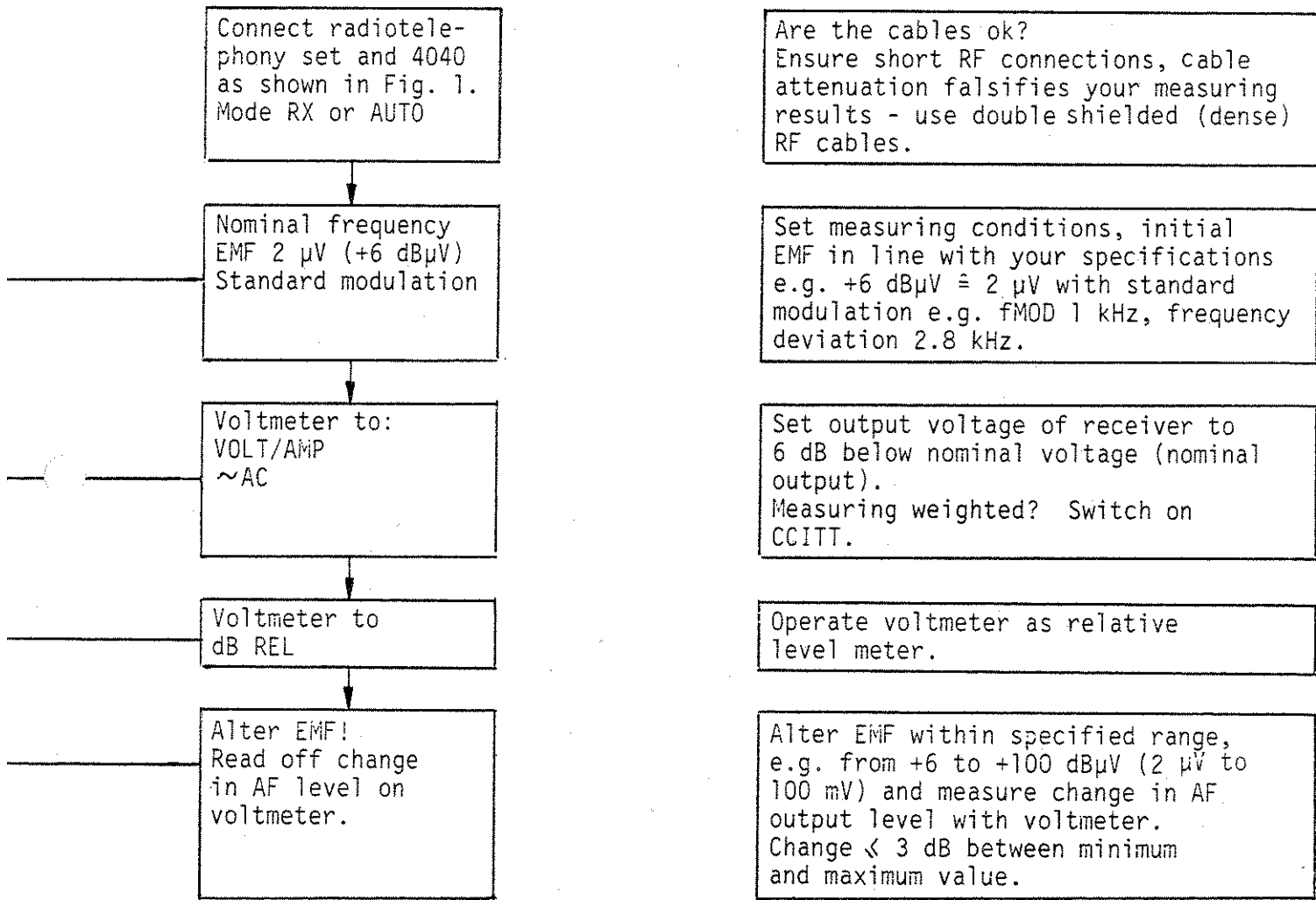

Fig. 1.:
Test Configuration for Receiver Measurements



Connect radiotelephony set and 4040 as shown in Fig. 1. Mode RX or AUTO

Are the cables ok?
Ensure short RF connections, cable attenuation falsifies your measuring results - use double shielded (dense) RF cables.

Nominal frequency
EMF 2 μ V (+6 dB μ V)
Standard modulation

Set measuring conditions, initial EMF in line with your specifications e.g. +6 dB μ V $\hat{=}$ 2 μ V with standard modulation e.g. fMOD 1 kHz, frequency deviation 2.8 kHz.

Voltmeter to:
VOLT/AMP
~AC

Set output voltage of receiver to 6 dB below nominal voltage (nominal output).
Measuring weighted? Switch on CCITT.

Voltmeter to
dB REL

Operate voltmeter as relative level meter.

Alter EMF!
Read off change in AF level on voltmeter.

Alter EMF within specified range, e.g. from +6 to +100 dB μ V (2 μ V to 100 mV) and measure change in AF output level with voltmeter.
Change < 3 dB between minimum and maximum value.

AUTOMATICALLY MEASURING REDUCTION IN RECEIVER SENSITIVITY WITH DUPLEX MODE

The reduction in sensitivity is the difference of the EMF, with or without transmitters switched on.

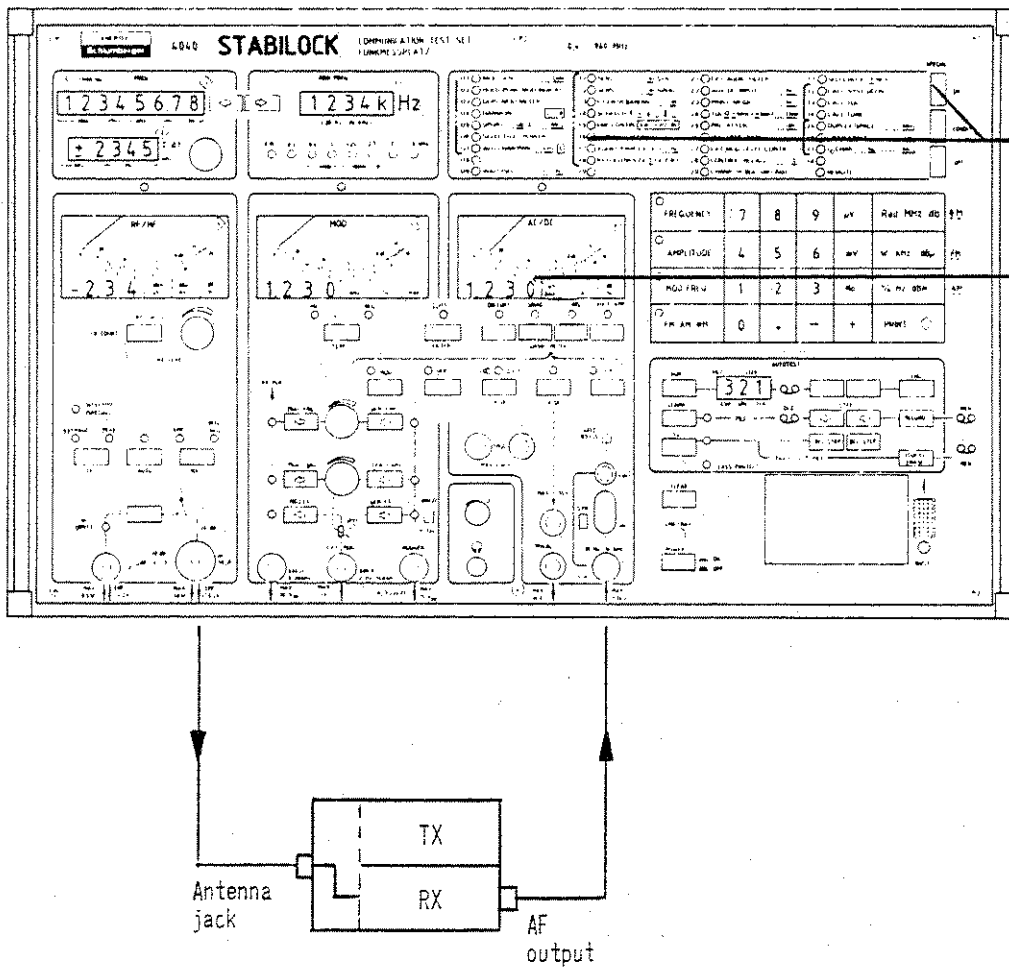

Fig. 1.:
Test Configuration for Receiver Measurements

Connect radiotelephony set and 4040 as shown in Fig. 1. Mode RX

Are the cables ok?
Ensure short RF connections, cable attenuation falsifies your measuring results - use double shielded (dense) RF cables

Sensitivity measurement:
S/N or SINAD

Measure receiver sensitivity S/N or SINAD. Refer to pp. 6-2 and 6-4

Switch on transmitter with Contr. Interface

When using the RX/TX relay in the control interface, it is not necessary to switch on the transmitter manually; the transmitter is automatically switched on after ON 1 6.

ON 1 6

Read off reduction in sensitivity on voltmeter 6 in dB

MEASURING TRANSMITTER OUTPUT

The nominal output is the output of the unmodulated transmitter signal.

A power attenuator (4911) must be connected in front of the STABILOCK 4040 for outputs >50 W. In this case, it is possible to achieve a display of the correct output without conversion by entering the preattenuation.

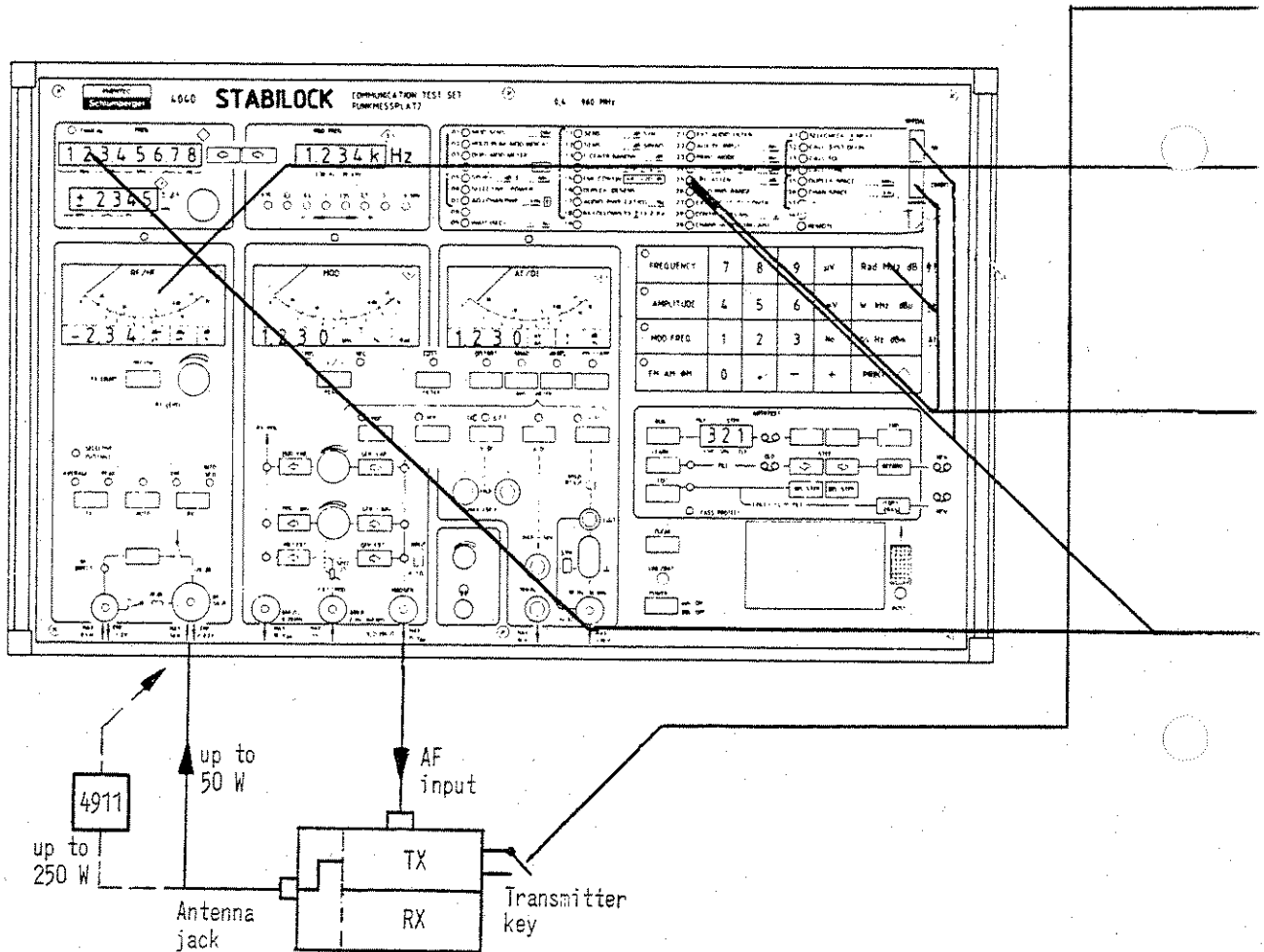
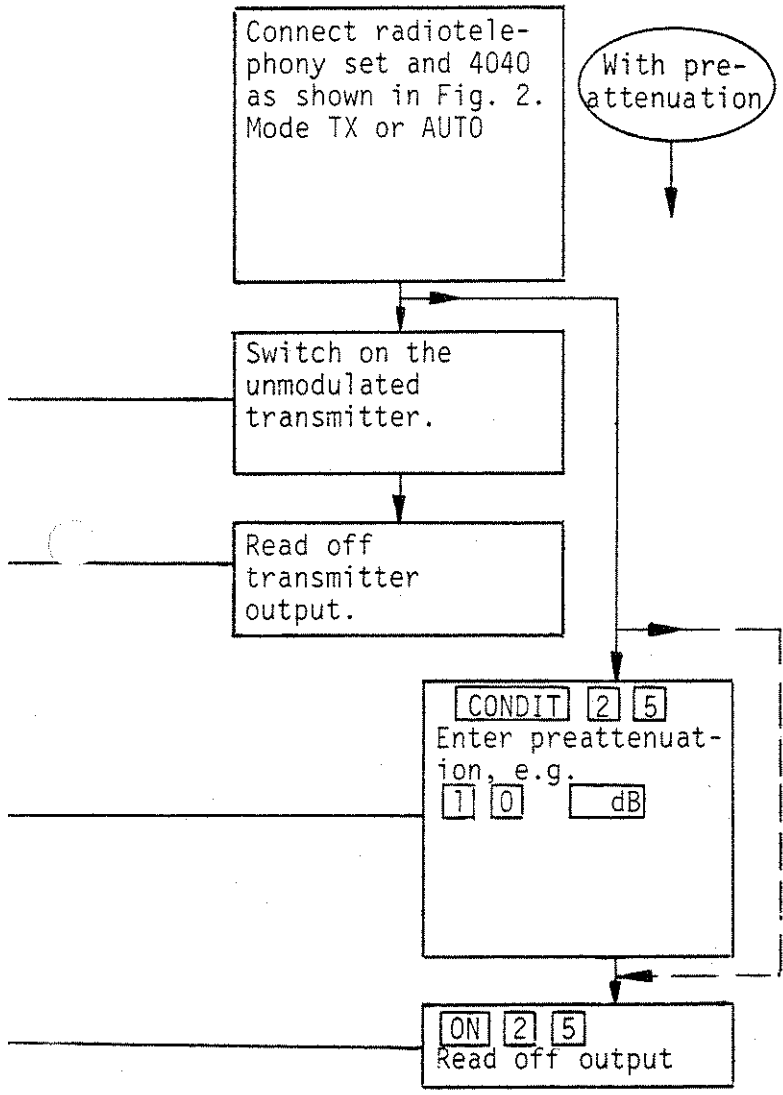

Fig. 2.:

Test Configuration for Transmitter Measurements



All transmitter measurements are performed in the TX or AUTO mode. In the AUTO mode the 4040 automatically switches from the RX mode to TX when the transmitter RF output is >50 mW. Ensure short RF connection since cable attenuation falsifies measuring results.

Note that the STABLOCK 4040 can measure 50 W. For larger outputs, pre-connect a power attenuator e.g. 4911 for outputs up to 250 W.

Transmitter output is displayed in Watts.

Enter the attenuation level of your power attenuator: E.g. 10 dB. This value remains stored until it is overwritten, i.e. the measuring sequence step CONDIT 2 5 is not performed until the preattenuation level is altered.

MEASURING TRANSMITTER FREQUENCY AND OFFSET OF TRANSMITTER FREQUENCY TO SET FREQUENCY

Due to the measuring principle (selective counter), delay lags ≈ 3 sec may occur with the initial measurement, ≈ 0.3 sec with subsequent measurements for frequency spacings < 10 MHz.

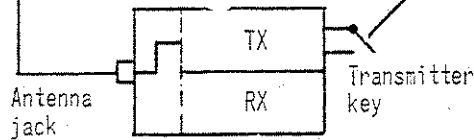
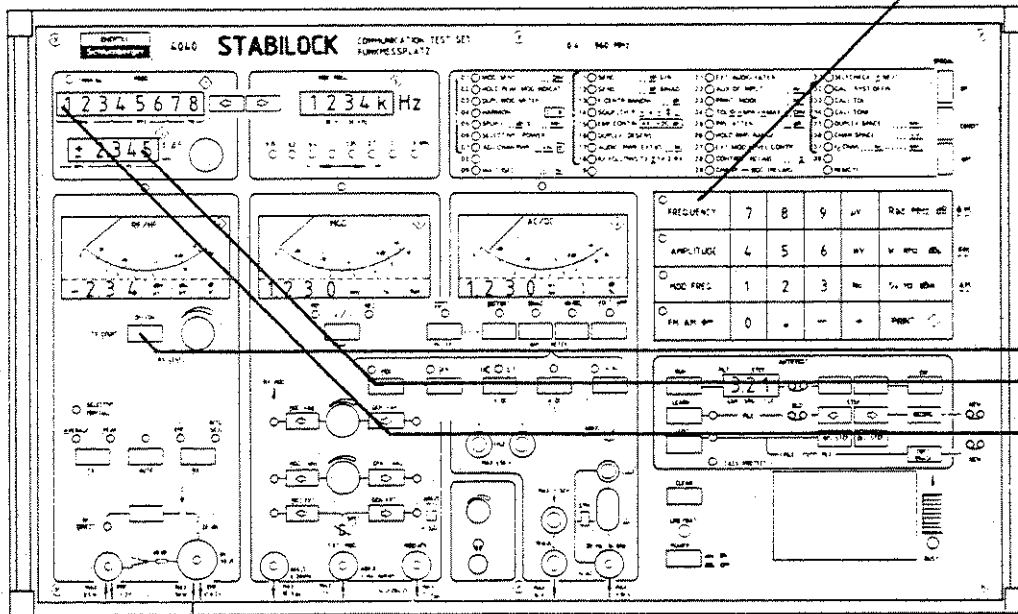
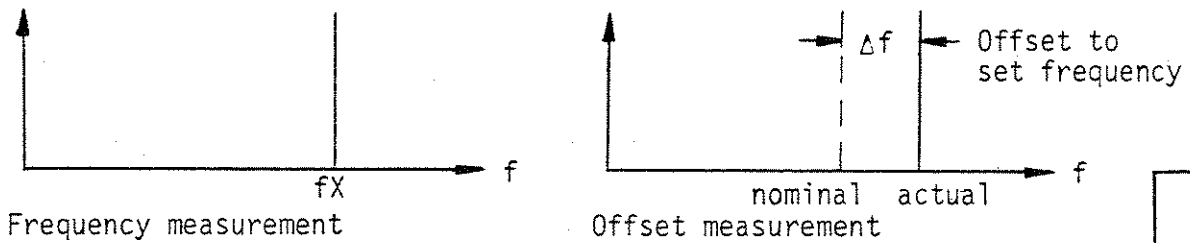
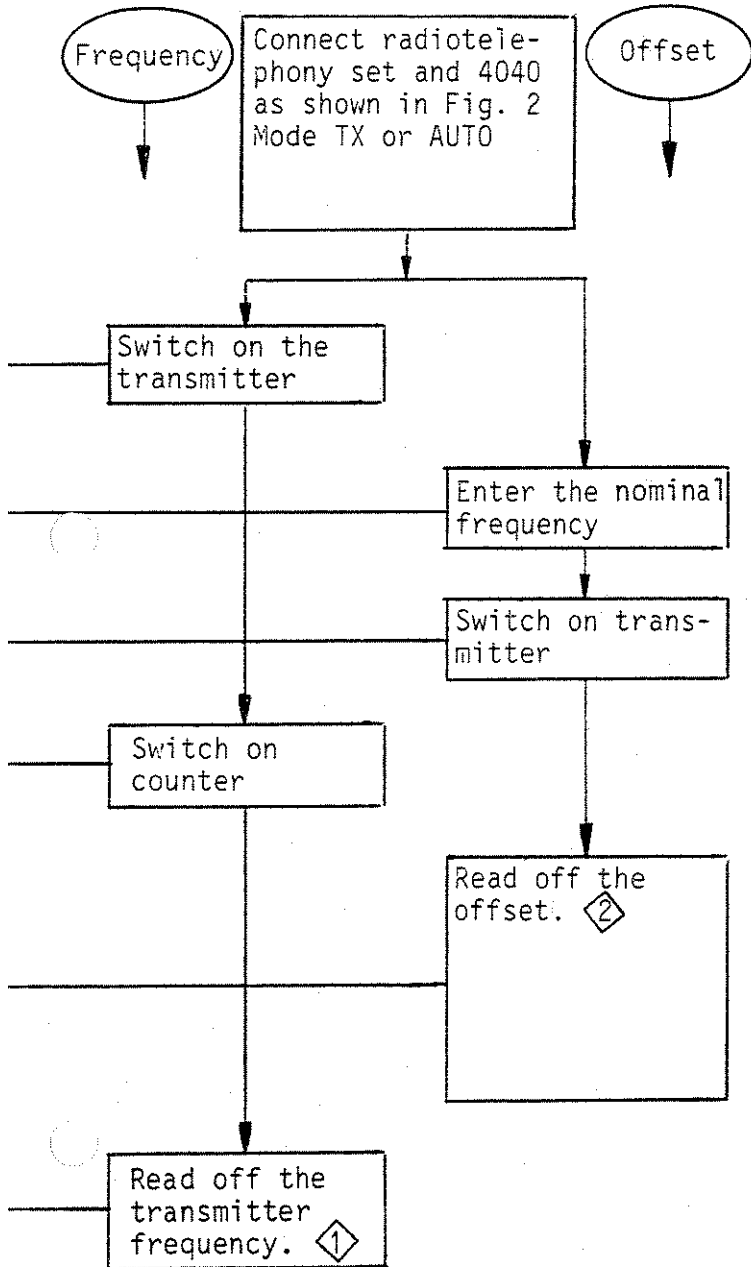

Fig. 2.:
Test Configuration for Transmitter Measurements



All transmitter measurements are performed in the TX or AUTO mode. In the AUTO mode the 4040 automatically switches from the RX mode to TX when the transmitter output is >50 mW.

e.g. 150.610 MHz

Display -9.999 to +9.999 kHz
 resolution 1 Hz
-99.99 to +99.99 kHz
 resolution 10 Hz
---- if
 >100 kHz or level too low

Display ----- counter running
150.61125 frequency measured

MANUALLY MEASURING MODULATION SENSITIVITY OF TRANSMITTER

We distinguish between two methods:

1. We are seeking the modulation voltage which produces a desired modulation intensity (frequency deviation, phase deviation, modulation level). This modulation voltage is the modulation sensitivity.
2. We measure the modulation intensity produced by a defined modulation voltage.

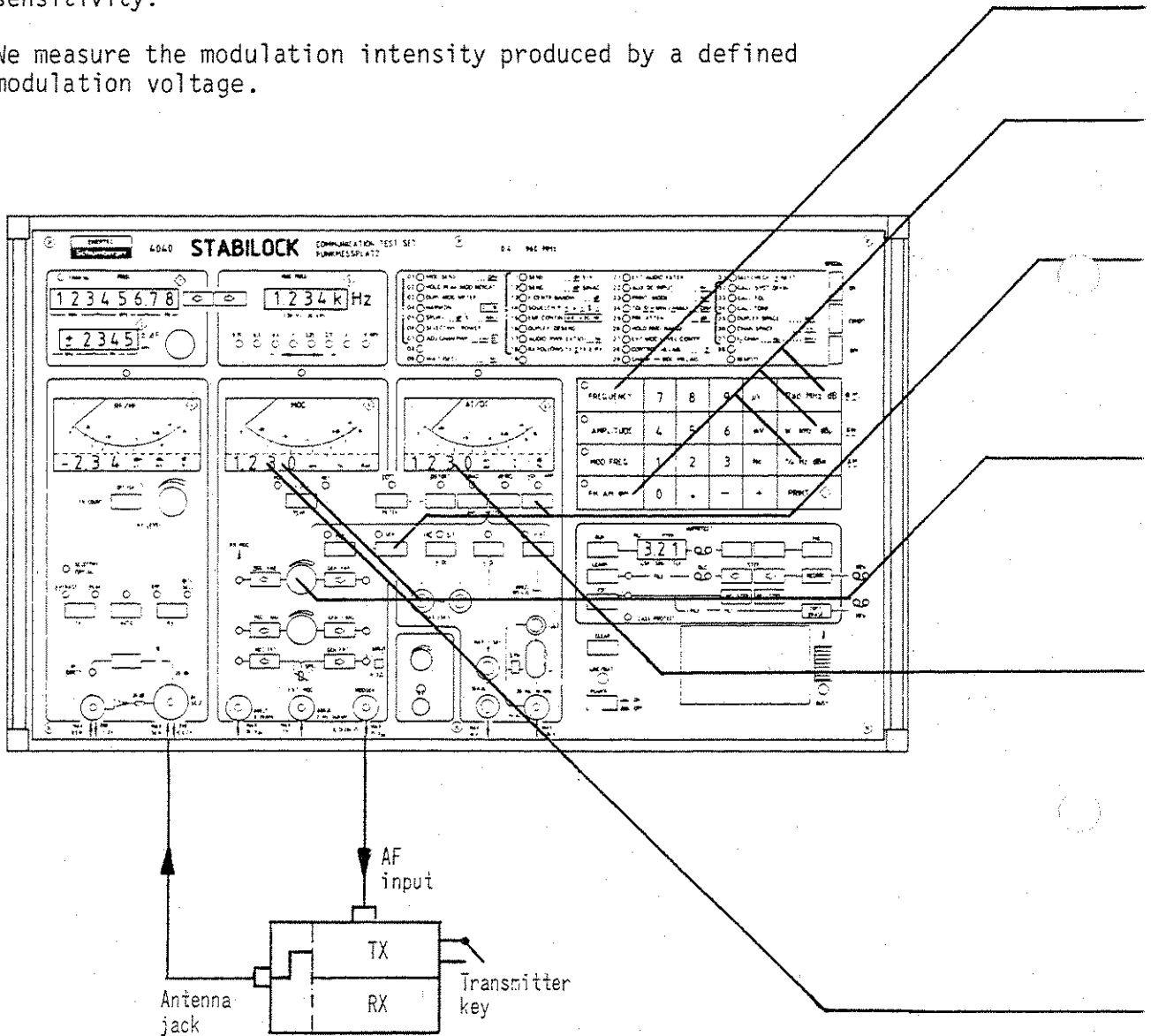
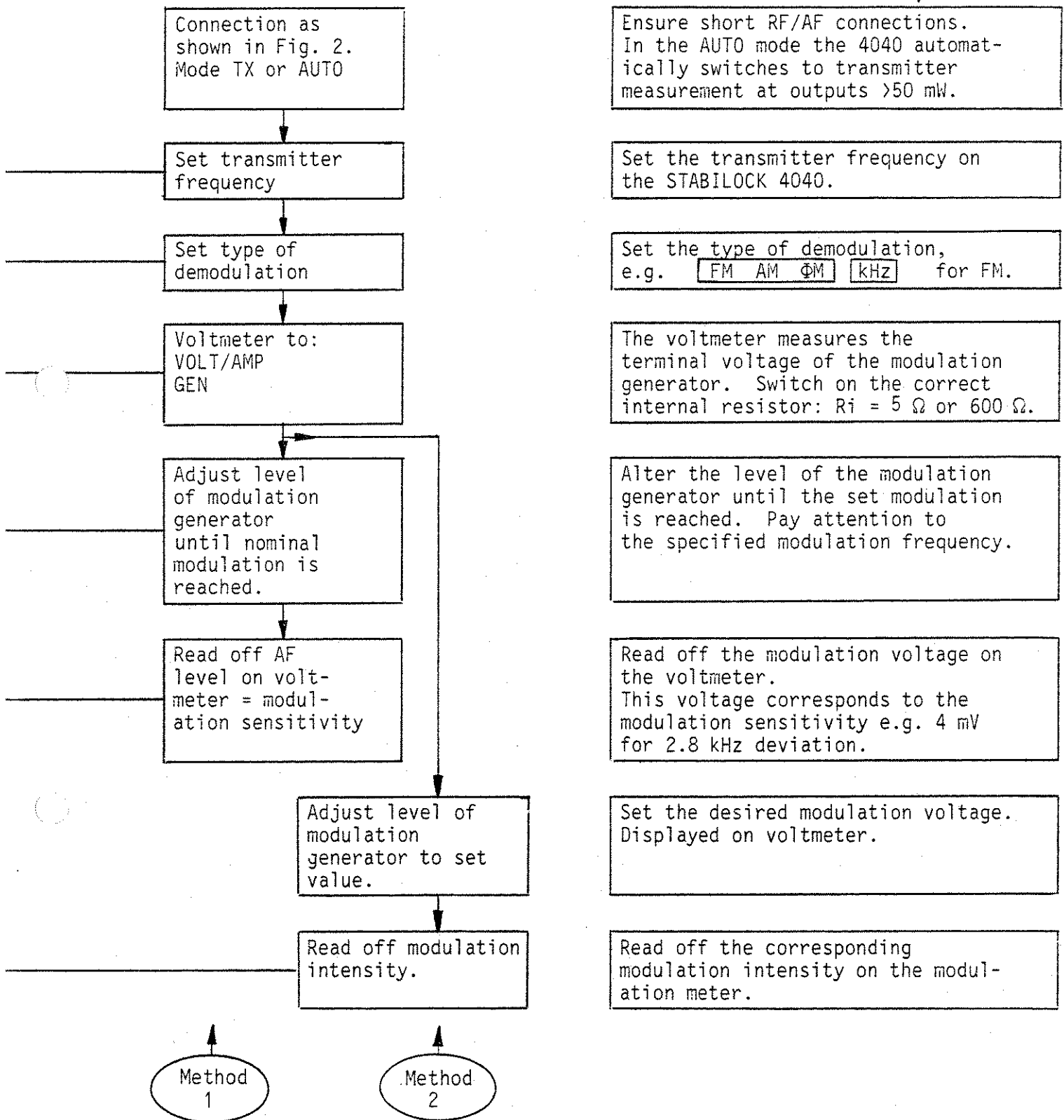

Fig. 2.:
Test Configuration for Transmitter Measurements



MEASURING MODULATION SENSITIVITY WITH MODULATION SENSITIVITY ROUTINE

Measuring method: The modulation voltage is automatically altered until the modulation intensity (deviation or modulation level) defined previously is reached.

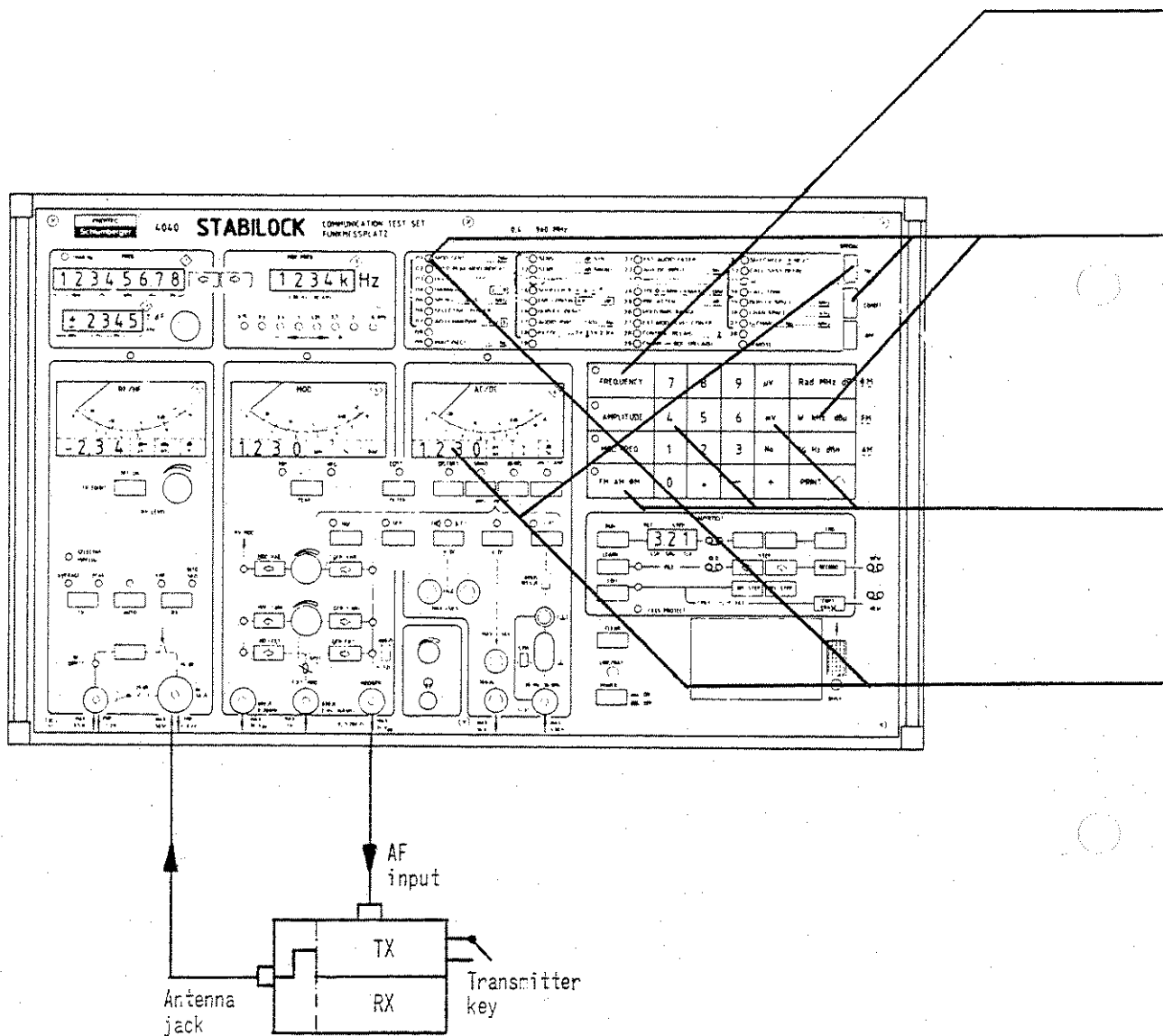
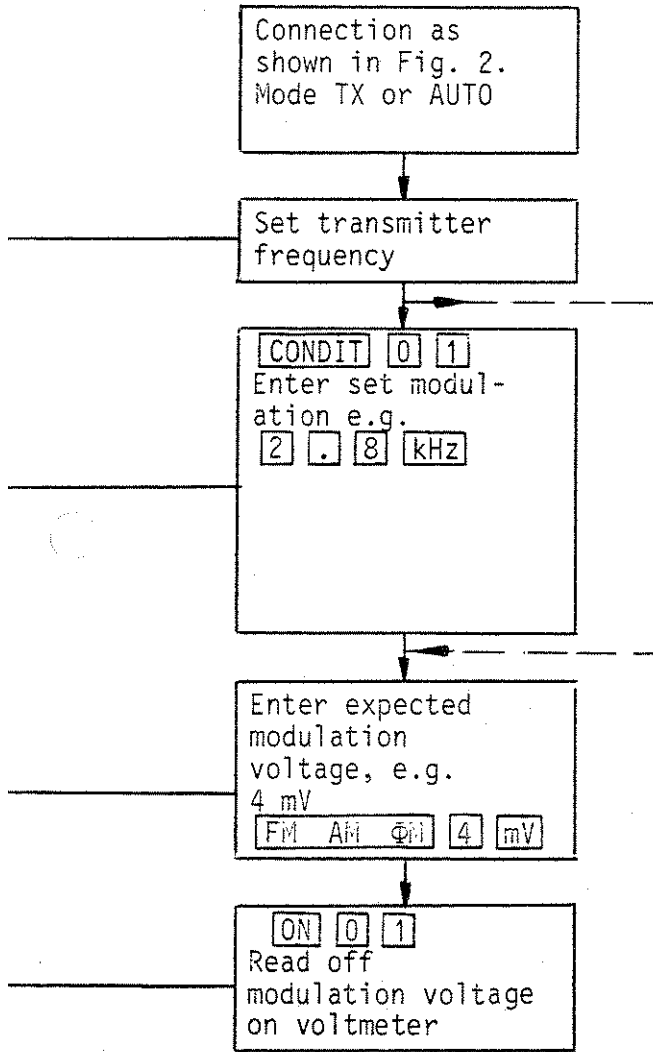

Fig. 2.:
Test Configuration for Transmitter Measurements



Ensure short RF/AF connections. In the AUTO mode the 4040 automatically switches to transmitter measurement at outputs >50 mW.

Set the transmitter frequency on the STABILOCK 4040.

SPECIAL 01 is the routine for automatically measuring the modulation sensitivity of the transmitter. The set value entered with CONDIT 0 1 remains stored until it is overwritten, i.e. CONDIT 0 1 step is not performed until a different set modulation is entered.

MANUALLY MEASURING TRANSMITTER MODULATION FREQUENCY RESPONSE AND DISTORTION FACTOR

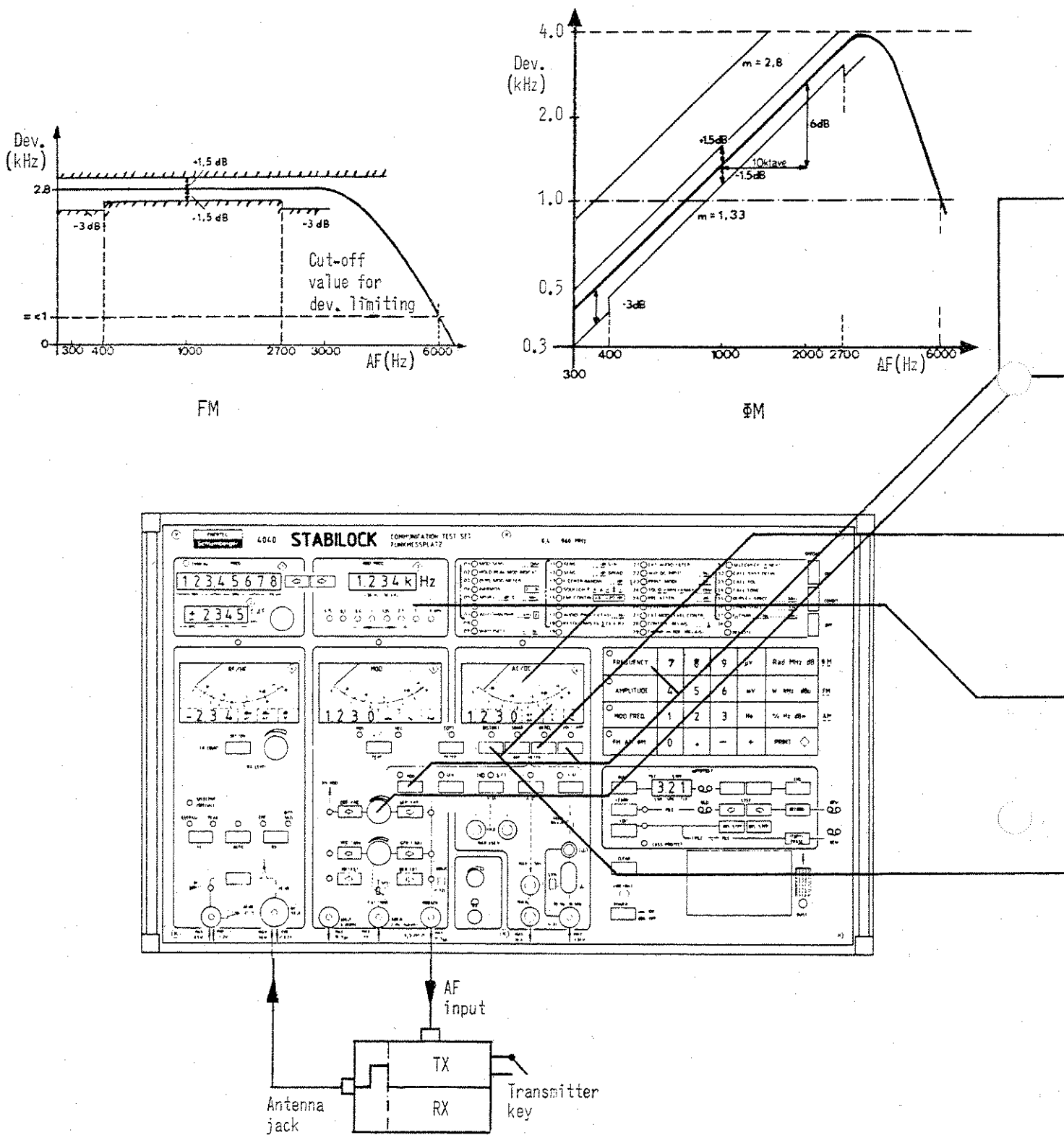
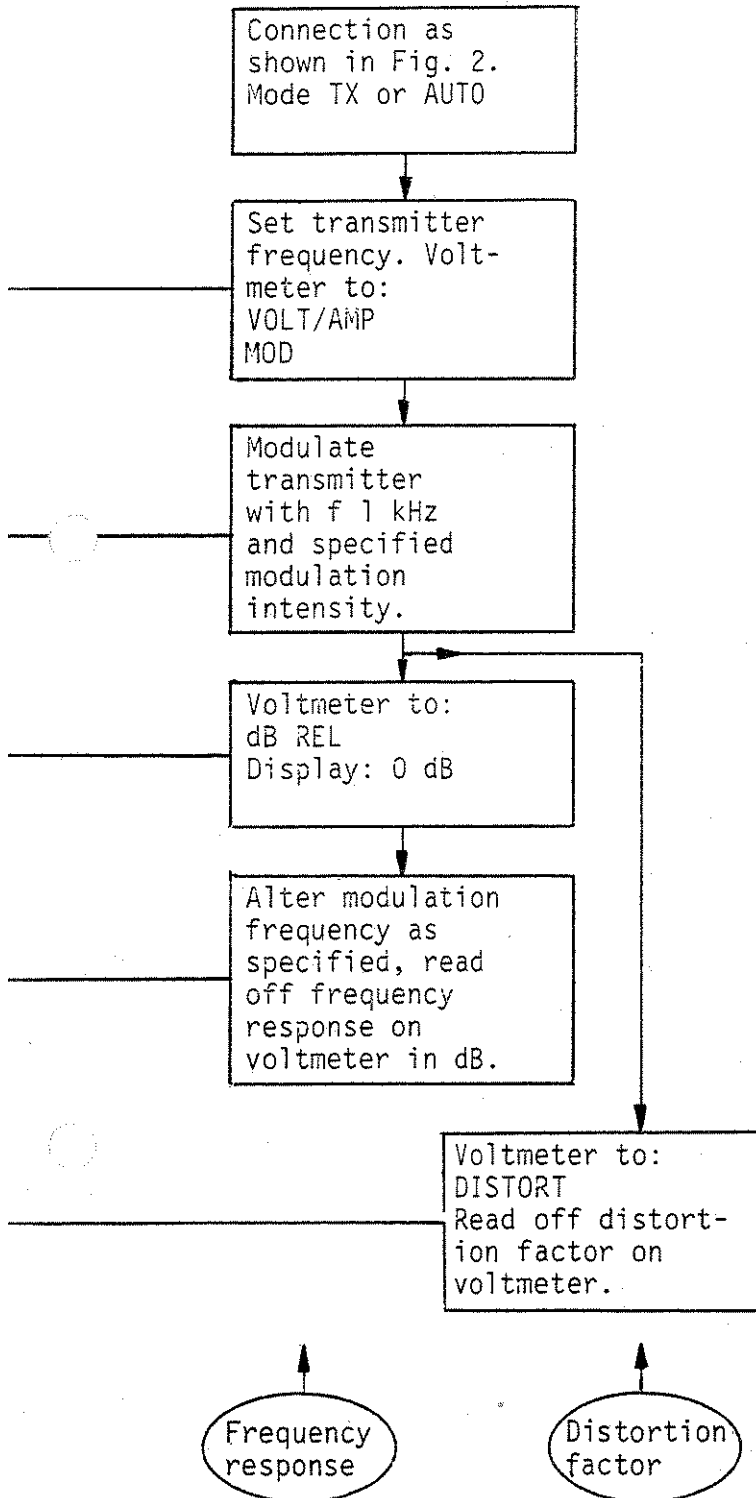

Fig. 2.:
Test Configuration for Transmitter Measurements



Ensure short RF/AF connections. In the AUTO mode the 4040 automatically switches to transmitter measurement at outputs >50 mW.

Set the frequency of the transmitter on STABILOCK 4040; switch the voltmeter to the output of the 4040 modulation meter (DEM0D).

Modulate the transmitter with the specified test modulation e.g. fMOD 1 kHz, deviation 20 % of peak deviation - test modulation is indicated by modulation meter 5.

Switch the voltmeter to dB REL - the modulation frequency response is thus related to the test modulation.

Vary the modulation frequency as stated in your specifications (fixed frequencies or variable frequency modulation generator).

Voltmeter 6 shows you the transmitter distortion factor at the specified test modulation when the DISTORT button is pressed.

For fmod 200 to 600 Hz use the notch filter (order no. 248 079) and SPECIAL 21.

MANUALLY MEASURING TRANSMITTER SIGNAL/NOISE
 RATIO AND RESIDUAL MODULATION

The signal/noise ratio is the ratio of the standard modulation level to the noise level without modulation. It is expressed in dB, e.g. -40 dB i.e. the noise level is 40 dB below the standard modulation level. The signal/noise ratio is measured weighted (CCITT P53).

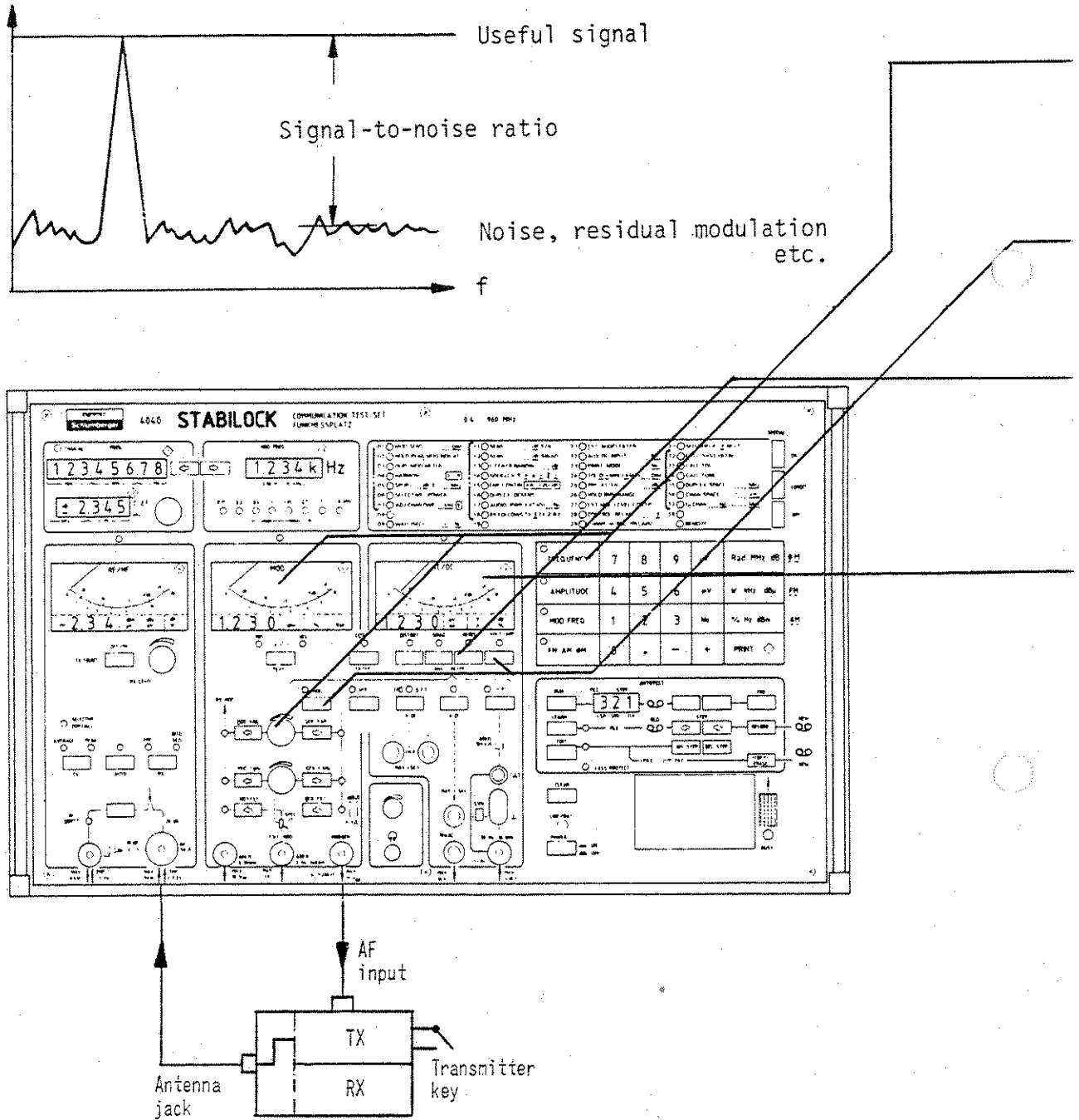
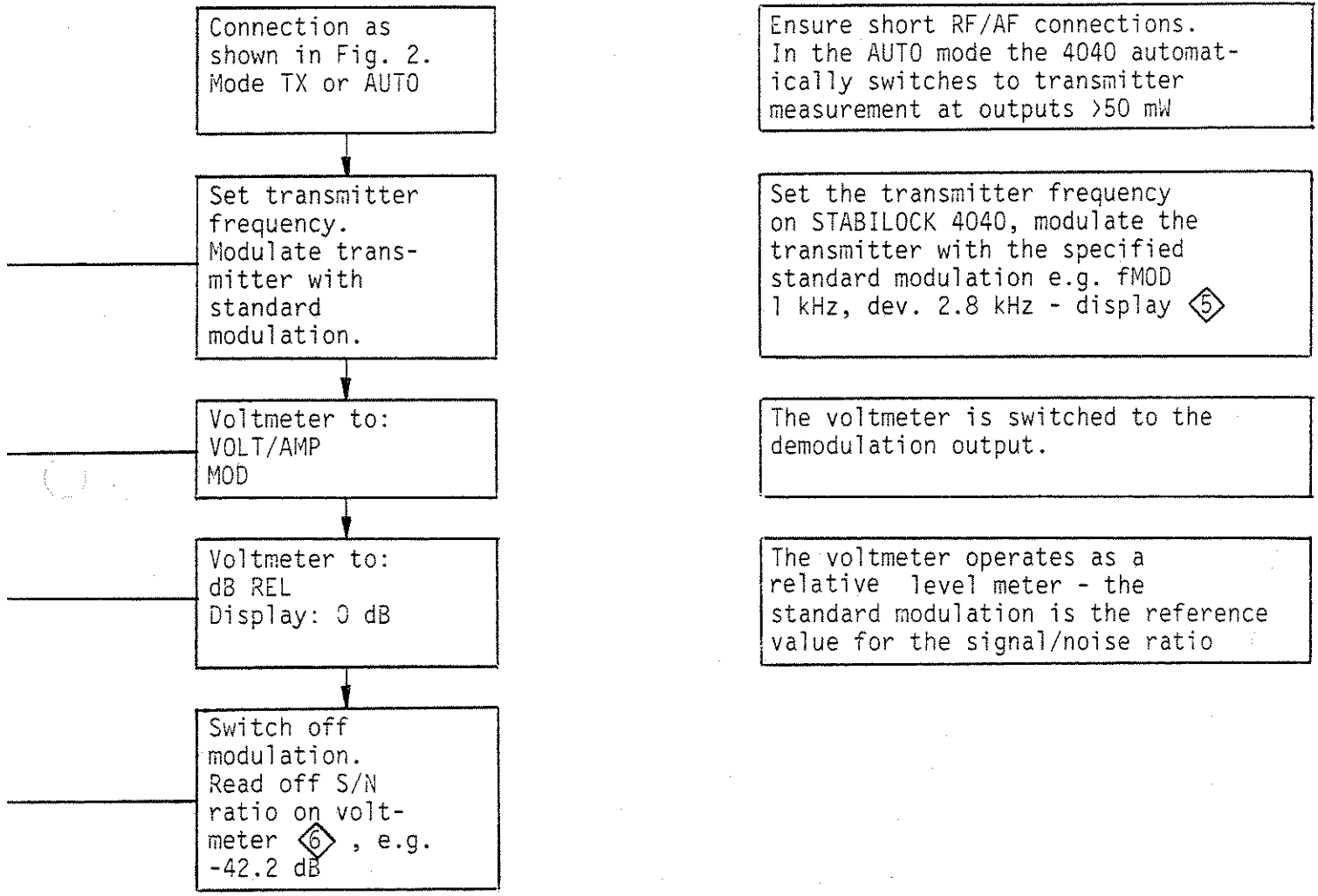

Fig. 2.:
 Test Configuration for Transmitter Measurements



Connection as shown in Fig. 2. Mode TX or AUTO

Ensure short RF/AF connections. In the AUTO mode the 4040 automatically switches to transmitter measurement at outputs >50 mW

Set transmitter frequency. Modulate transmitter with standard modulation.

Set the transmitter frequency on STABILOCK 4040, modulate the transmitter with the specified standard modulation e.g. fMOD 1 kHz, dev. 2.8 kHz - display 5

Voltmeter to: VOLT/AMP MOD

The voltmeter is switched to the demodulation output.

Voltmeter to: dB REL Display: 0 dB

The voltmeter operates as a relative level meter - the standard modulation is the reference value for the signal/noise ratio

Switch off modulation. Read off S/N ratio on voltmeter 5, e.g. -42.2 dB

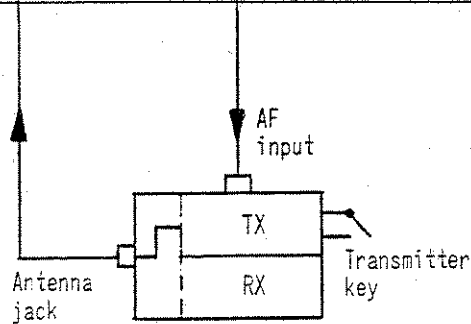
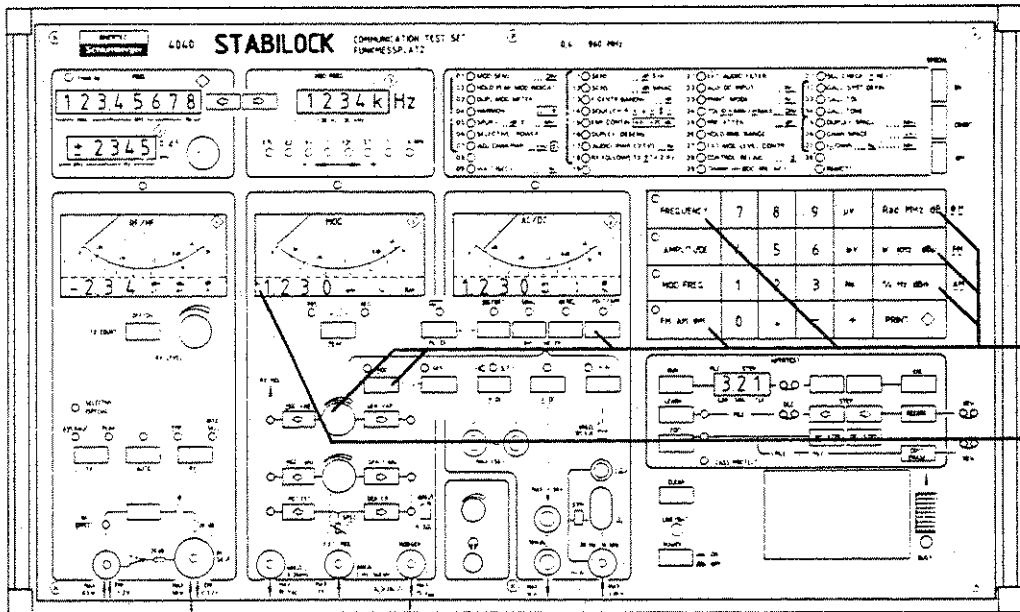
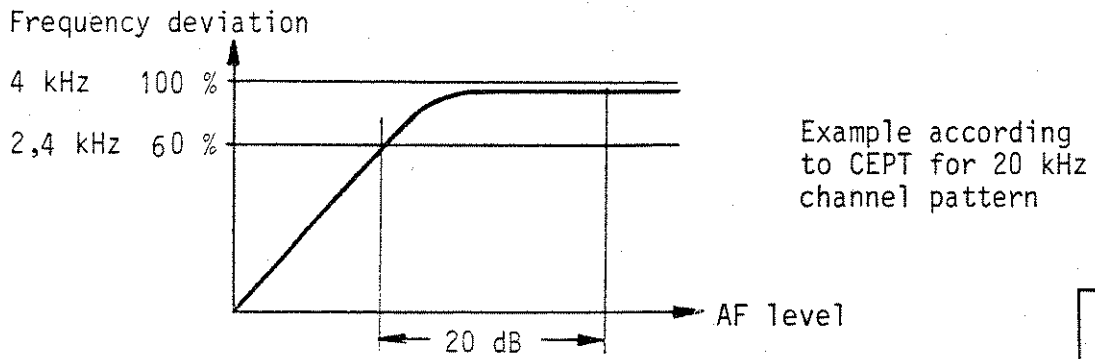
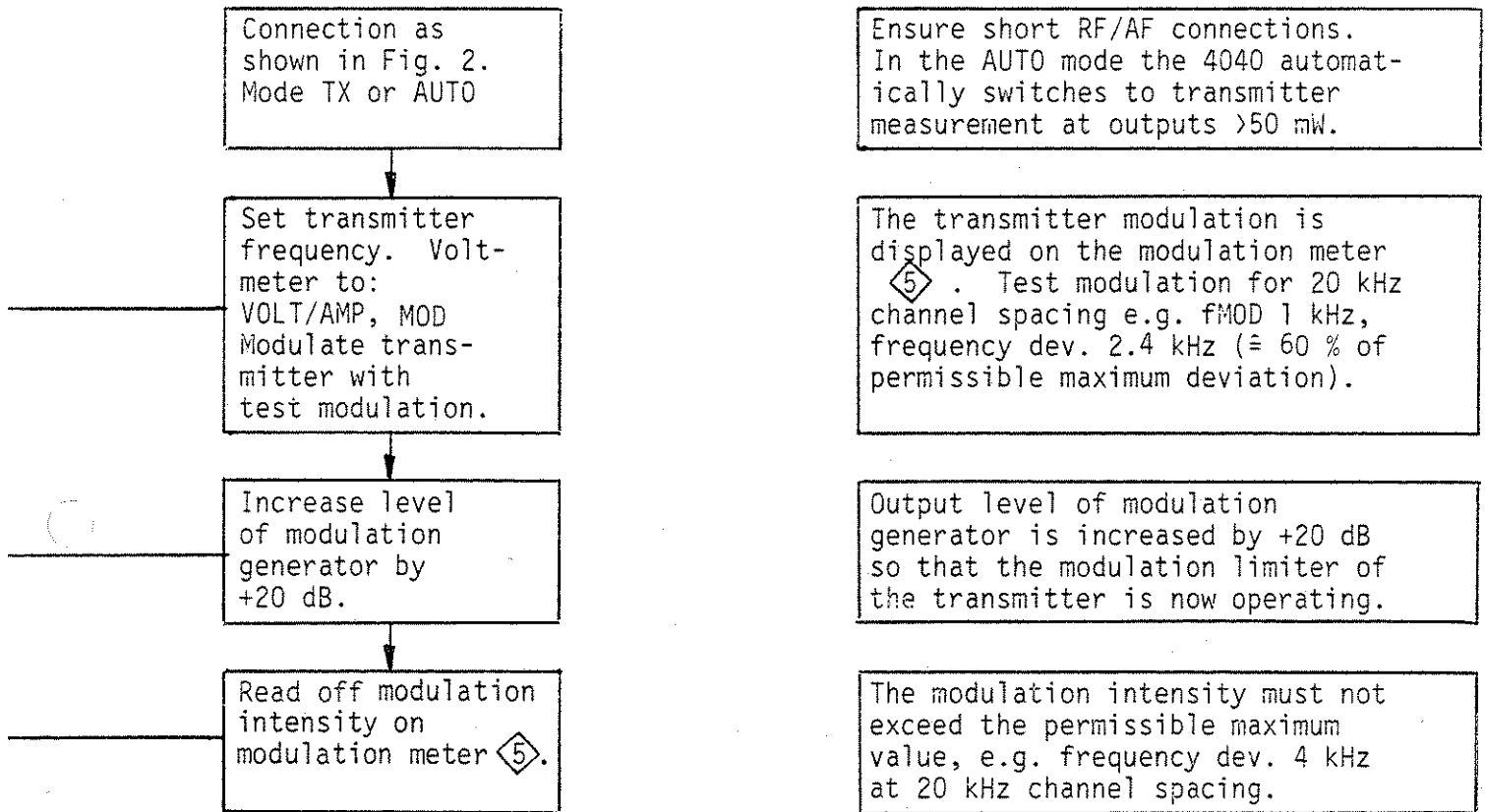
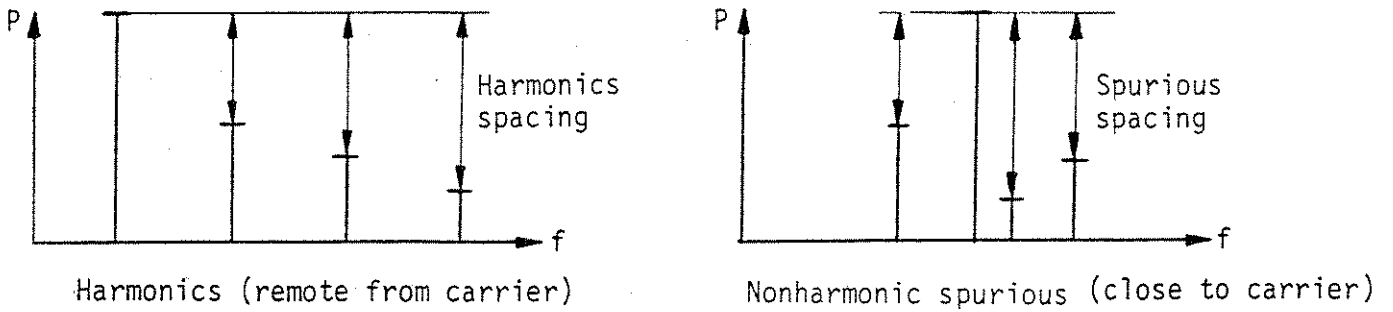

Fig. 2.:
Test Configuration for Transmitter Measurements



MEASURING TRANSMITTER HARMONICS AND SPURIOUS



The STABILOCK 4040 operates as a spectrum analyser; this requires the adjacent channel power meter option. The test bandwidth is approx. 2 kHz.

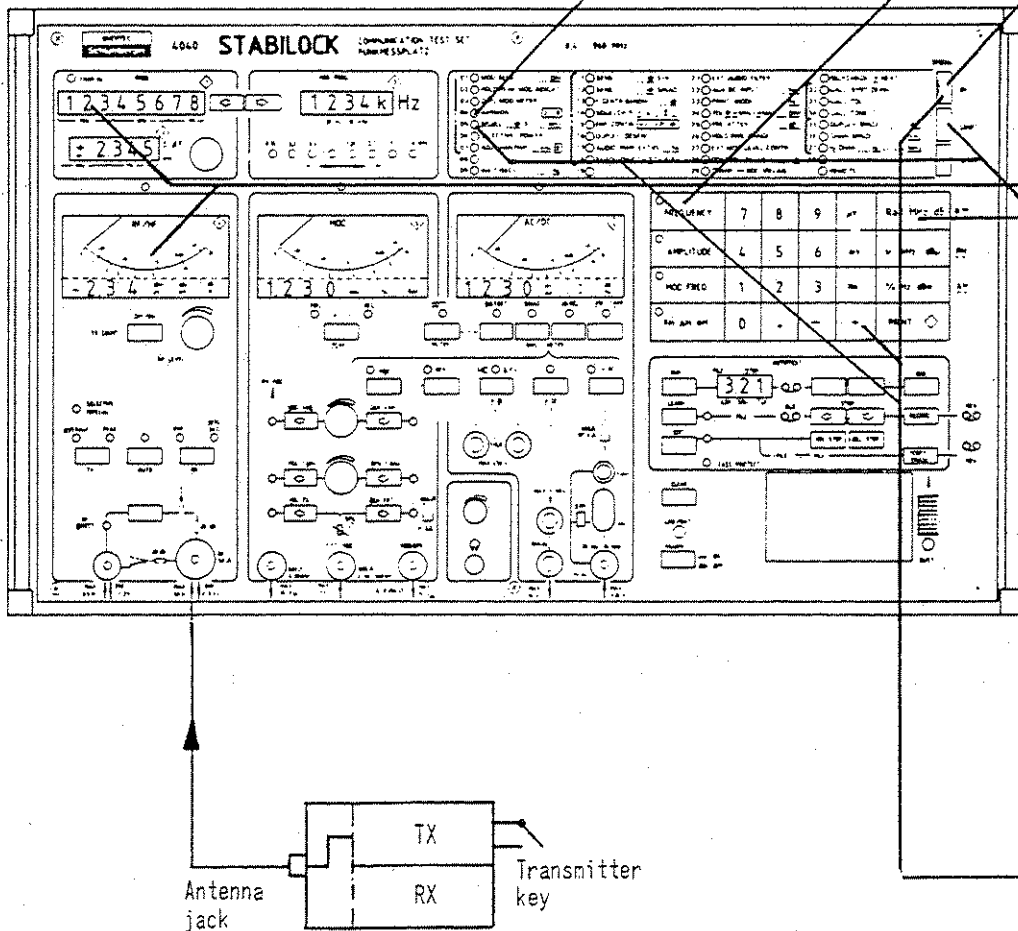
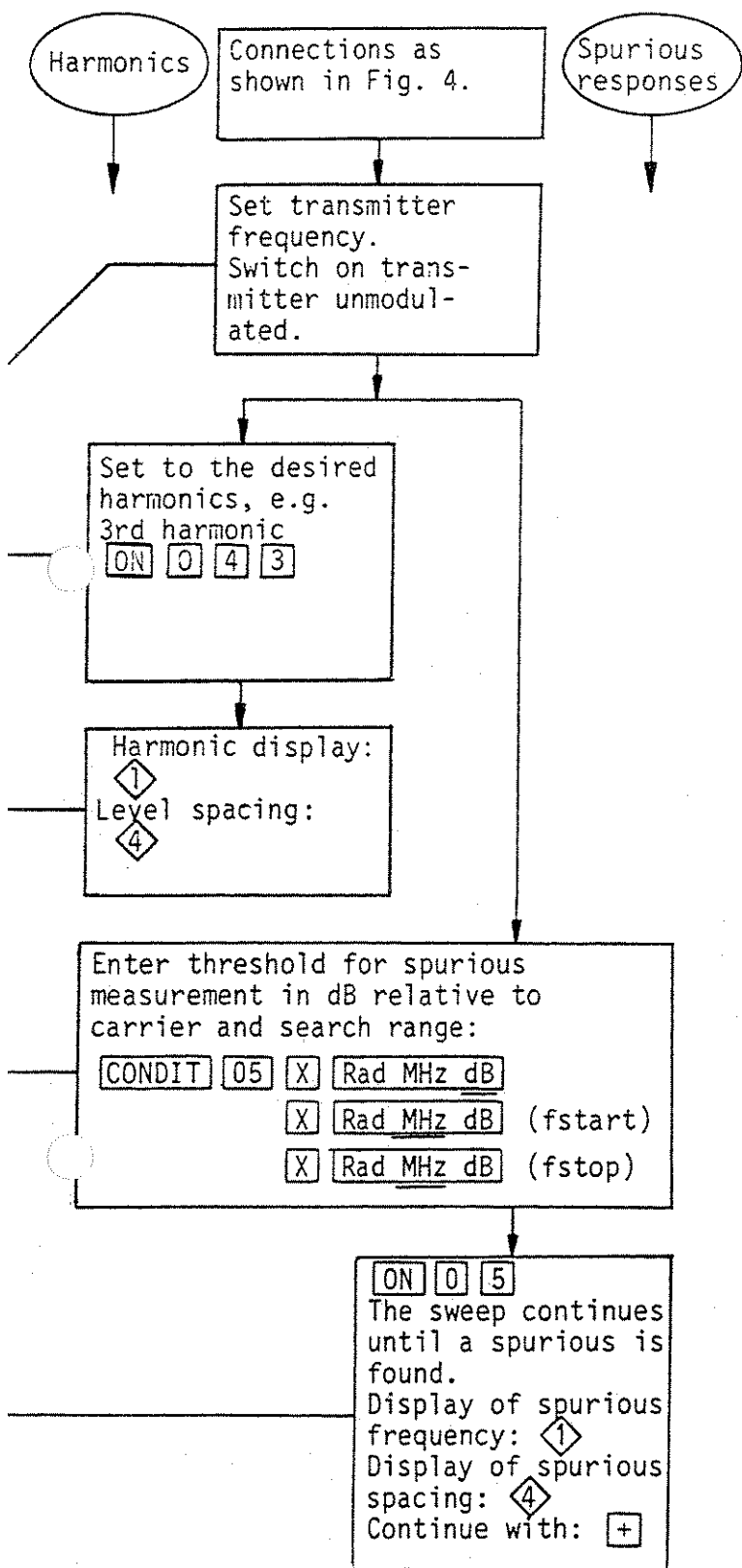

Fig. 4.:
Test Configuration



Ensure short RF connections, switch STABLOCK 4040 to TX mode (transmitter measurement).

The rule here is: The first harmonic (fundamental) is the carrier frequency of the transmitter. Special 04 is the routine for automatically measuring harmonics spacing.

Typical display:
2. [] 1 Number of harmonic
-75.2 dB 4 Harmonics spacing to carrier frequency

SPECIAL 05 is the routine for automatically measuring nonharmonic spurious. The search range and measuring threshold are set with CONDIT 0 5. They remain stored until they are overwritten, i.e. the CONDIT 0 5 step is not performed until the test conditions are altered.

Typical display:
150.61205 1 = spurious frequency
-45.3 dB 4 = spurious spacing
If no spurious is found, the displays read as follows:
----- 1
--- 4

This measurement is only possible with the adjacent channel power meter option.

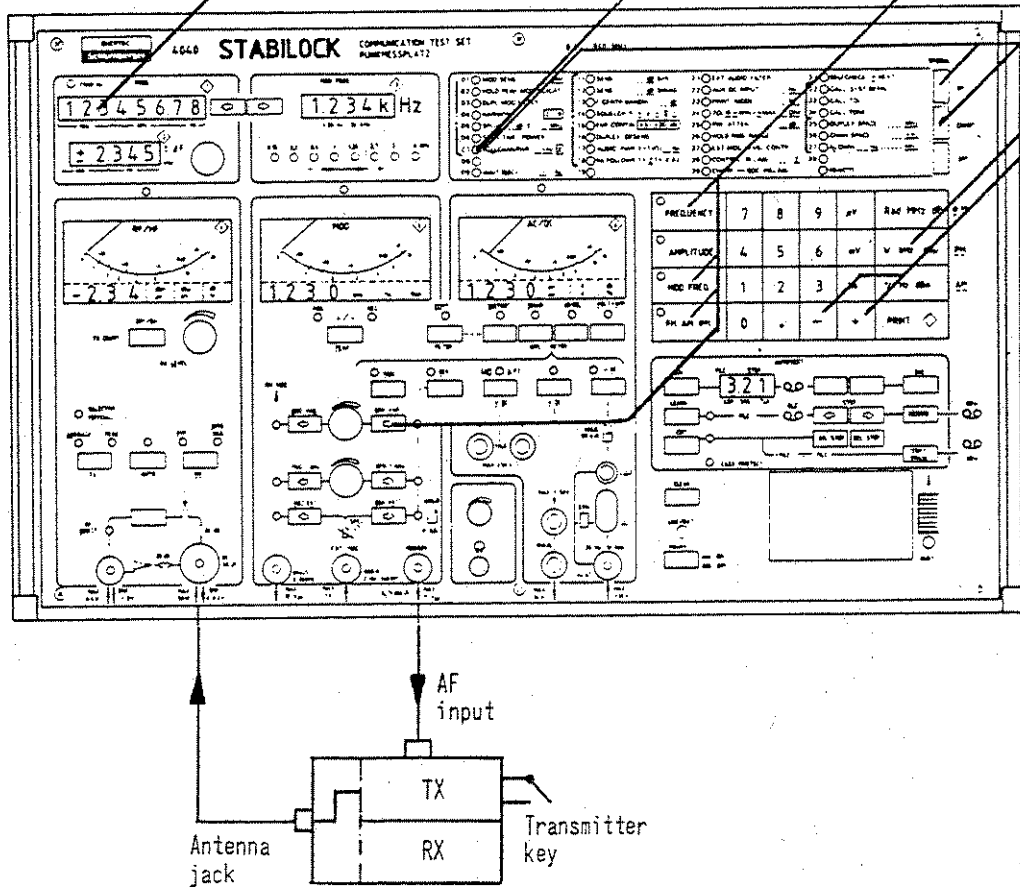
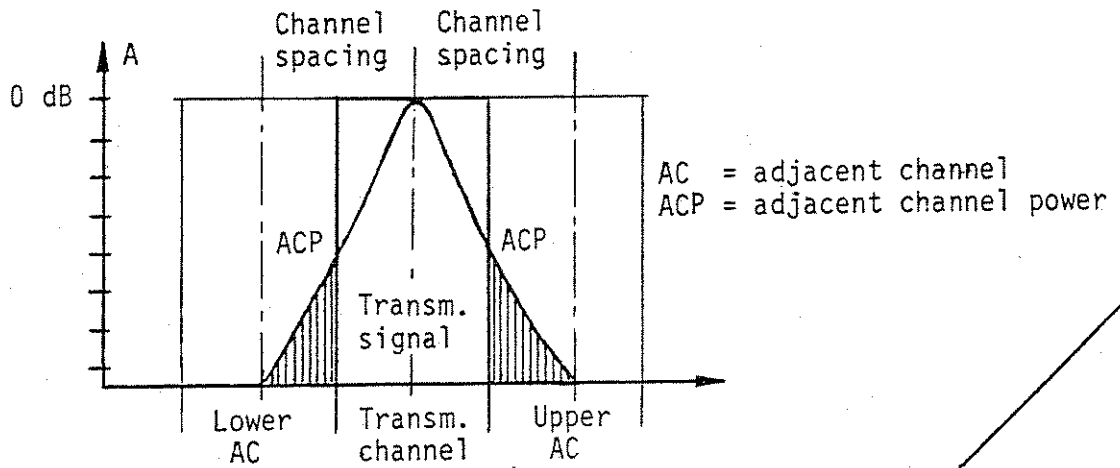
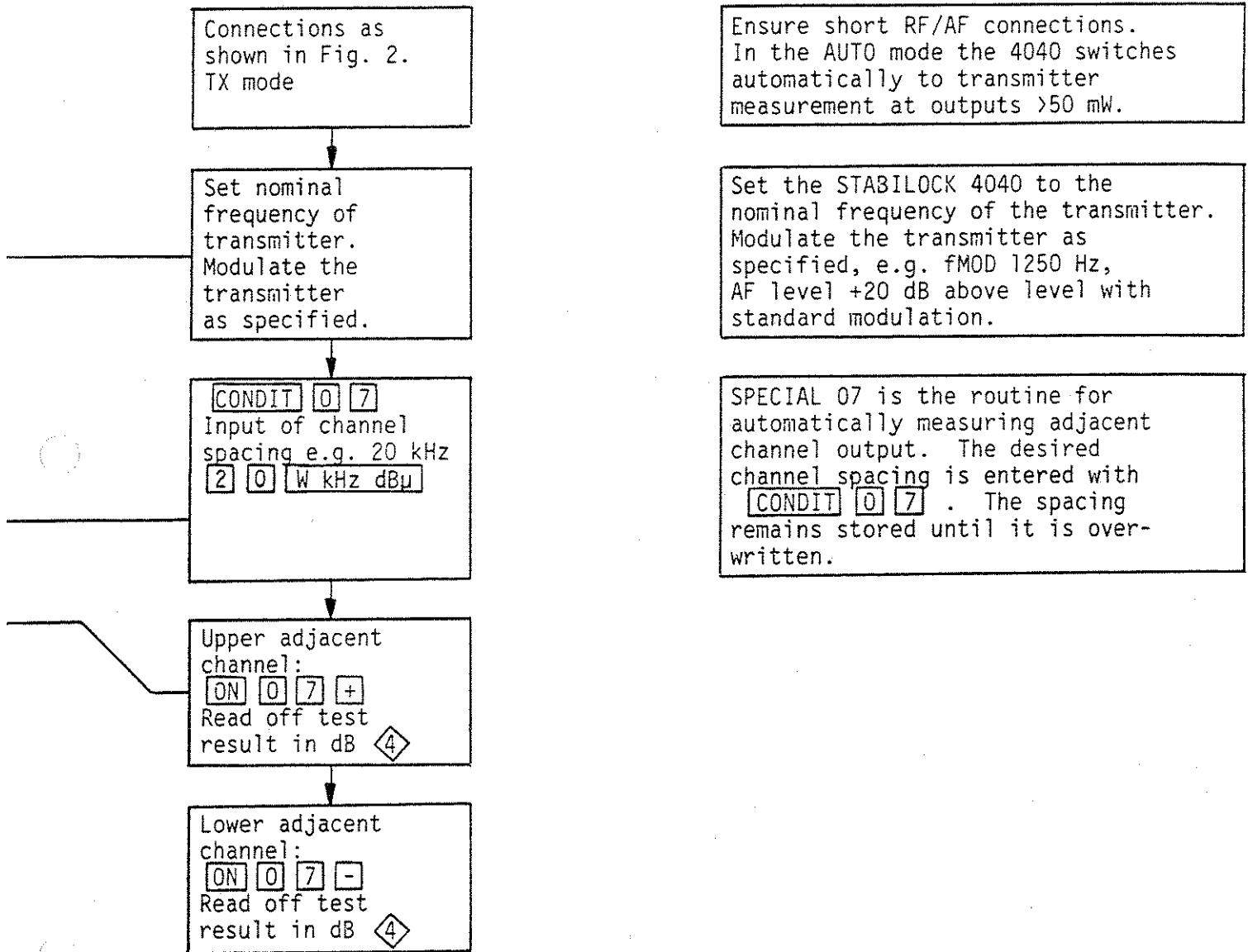

Fig. 2.:
Test Configuration for Transmitter Measurements



DUPLEX MEASUREMENTS

Receiver and transmitter sections of duplex radio sets have to be measured separately as described on the preceding pages. The measurement of duplex desensitisation and adjustment of duplex filters is given on page 3-30.

The modulation transfer characteristics of repeaters can be tested as follows:

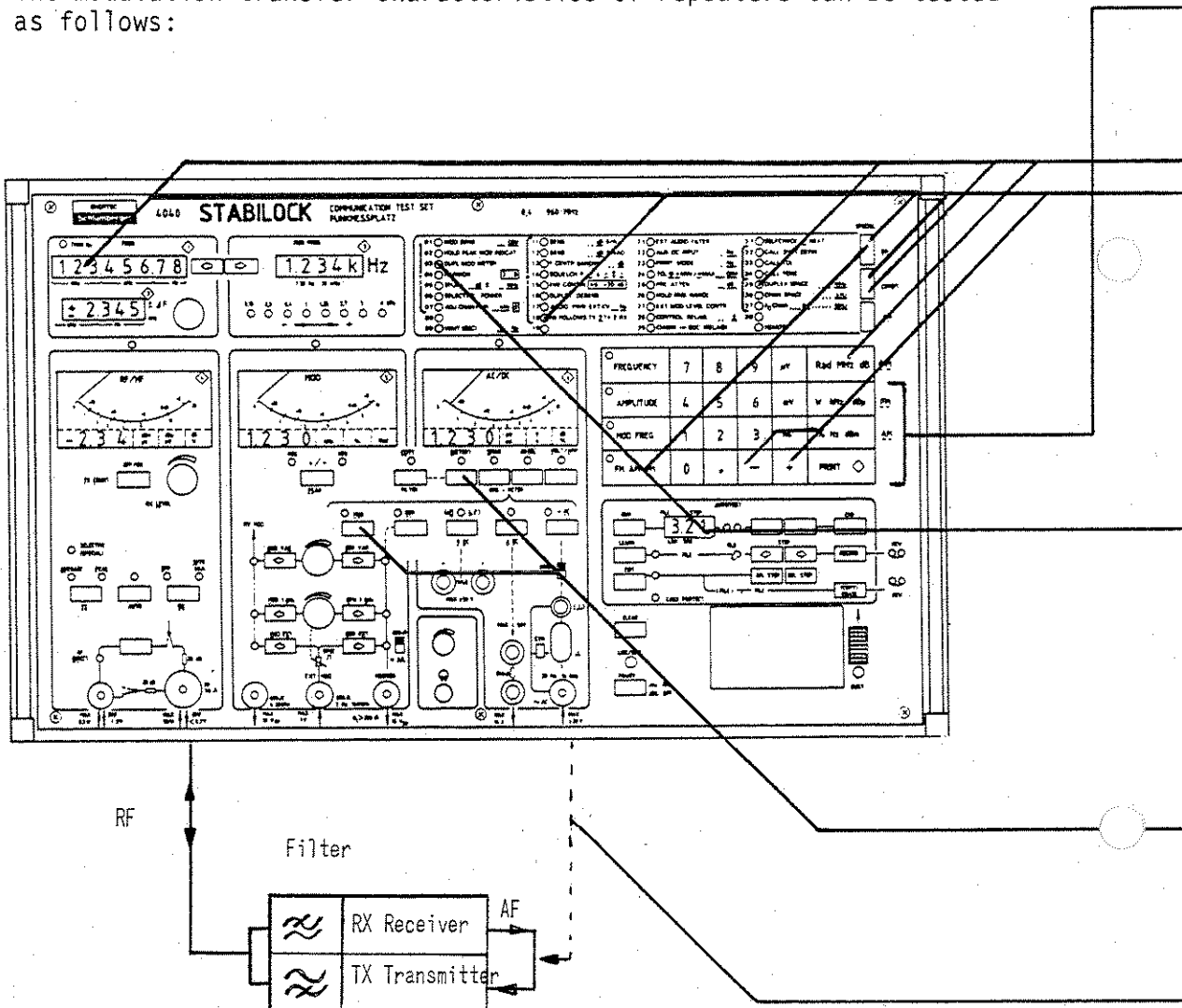
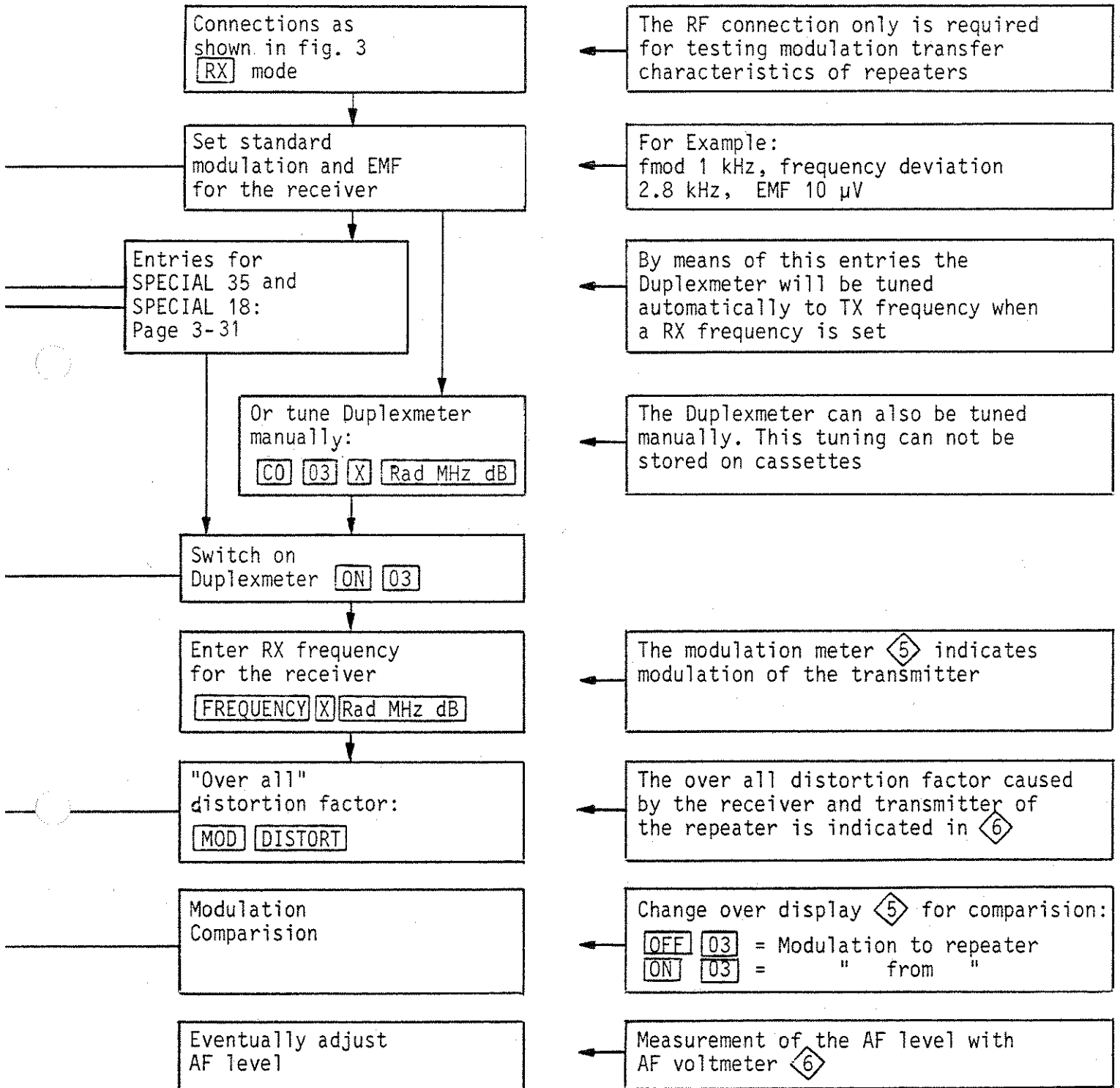

Fig. 3.:
Test Configuration for Repeater Measurements

Test Sequence

Explanations



STABILOCK 4040

Frequency Range Extension 222 040 (option)

Specifications

RECEIVER MEASUREMENT

Carrier Frequency

Frequency range	960...1850 MHz
Resolution	20 Hz
Accuracy	as Reference Oscillator

Output Level

EMF (FM, \emptyset M only)	
at RF socket	-26 dBm \cong 22.4 mV EMF
at RF DIRECT	-6 dBm \cong 224 mV EMF
Level resolution	0.1 dB
EMF error	
at socket RF	\pm 3 dB (960 ...1850 MHz)
at RF DIRECT	\pm 3.5 dB
Impedance	50 Ω
VSWR	<1.3 (Bu RF)
Interruption free setting range	+6 dB...-12 dB

Spectral Purity

Phase noise	-120 dBc/Hz typically 25 kHz off carrier
Spurious signals at 0.01...30 MHz off carrier	<-65 dBc
Harmonics	<-25 dBc
Subharmonics f/2, 3f/2	<-35 dBc
Residual FM in a 50 Hz to 3 kHz bandwidth	\leq 6 Hz eff

FM

Range	0...20 kHz
Resolution	20 Hz, Δf <4 kHz 200 Hz, Δf \geq 4 kHz
Modulation frequency	
internal	30 Hz...30 kHz
external	2 Hz...140 kHz (-3 dB)
Error with Δf <20 kHz and fmod 0.3...3 kHz	<4 % \pm 2 digit
fmod 0.03...30 kHz	<8 % \pm 2 digit
Distortion	<2 % at Δf <10 kHz and fmod 0.3...3 kHz

Wide Band FM
Maximum frequency deviation 0...80 kHz

ØM
Range 0...6 rad
Resolution 0.02 rad
Modulation frequency internal and external 100 Hz...16 kHz (fmod x rad <40 kHz)
Error <4 % ±2 digit (0.3...3 kHz fmod)
Freq. response -3 dB (100 Hz...16 kHz)
Distortion <1 % (0.3...3 kHz fmod)

TRANSMITTER MEASUREMENT

Frequency Offset Measurement

Frequency range 960...1850 MHz
Measuring range 0...±10 kHz/0...±100 kHz
Resolution 1 Hz/10 Hz
Input level range with <10 kHz offset
at socket RF >0 dB
at RF DIRECT >-20 dBm

Power Measurement

Frequency range 960...1850 MHz
Measuring range 20 mW...50 W
Resolution 10 mW <10 W
100 mW ≥10 W

Accuracy with average indication
0.96...1.86 GHz <20 % ±1 digit and input = 0.1...10 W

FM/ØM Measurement

Input level range
at RF socket 50 mW...50 W
at RF DIRECT socket 20 mV...500 mV

Spurious Modulation Measurement

relative to 3 kHz FM
CCITT weighted 0 - 50 dB
Input level range
at RF socket 50 mW...50 W
at RF DIRECT socket >40 mW

RESTRICTIONS

Not possible above 960 MHz:
Measurement of AM, selective level (adjacent channel power, harmonics, spurious signals) and TX frequency.
Measurement of TX frequency offset is possible.

OPERATION

In the extended frequency range (>960 MHz) the 4040 is operated in the same way as in the basic frequency range.

One must simply observe the restriction stated in the technical data.

Because of the doubler function there is frequency resolution of 20 Hz in the frequency range >960 MHz instead of 10 Hz as in the basic frequency range. Although frequencies can be entered with 10 Hz resolution, only output frequencies with even-numbered resolution (00, 20, 40, 60, 80 Hz) are possible. For odd-numbered entries the next even-numbered value down becomes effective.

In the frequency range >960 MHz the modulation sensitivity is twice as high as in the basic frequency range.

Modulation sensitivity on the EXT MOD input (600 Ω):

0.1 V peak = 5.0 kHz FM or 2.00 rad Φ M.

The modulation display $\diamond 5$ shows the set value.

VSWR MEASURING HEAD (option)

This option serves for measuring antenna matching with the Communication Test Sets STABLOCK 4040 (from software 1.06 onwards) and 4039 (from 1.01 onwards). It can be used only in conjunction with the Adjacent Channel Power Meter option 229 042.

With the aid of a directional coupler the forward and reflected power is measured, the VSWR of the antenna is computed from this and indicated in digital form on the RF display panel $\diamond 4$ of the communication test set.

$$VSWR = \frac{1 + \sqrt{P_{refl}/P_{forw}}}{1 - \sqrt{P_{refl}/P_{forw}}}$$

The directional coupler is connected to the sockets RF and RF DIRECT of the communication test set by way of two 10-dB attenuator pads.

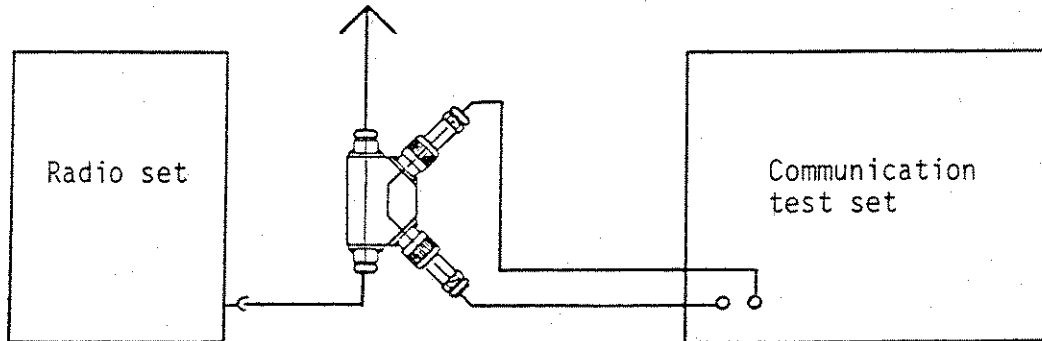

The selective VSWR measurement is performed at the frequency set on the Radiocommunication Tester. On the tester, the TX operating mode and the channel frequency corresponding to the channel number of the radio must be set. Radios of the C-Net system have to be tested in the "Service Mode" (see manufacturers instructions) of the radio.

Entry for measuring VSWR:

CONDIT 061 ON 06 → $\diamond 4$

Technical data:

Frequency range ----- 25 to 500 MHz
Impedance ----- 50 ohms, VSWR ≤ 1.07
Connectors ----- 2 N sockets (radio set and antenna)
VSWR measuring range ---- 1.00 to 9.99
Measuring error ----- $< \frac{VSWR - 0.9}{3}$
Forward power ----- 50 mW to 50 W

Ordering designation ---- VSWR Measuring Head 248 104
including directional coupler,
2 attenuator pads and
2 connecting cables (6 m)

STABILOCK 4040
Block Diagram

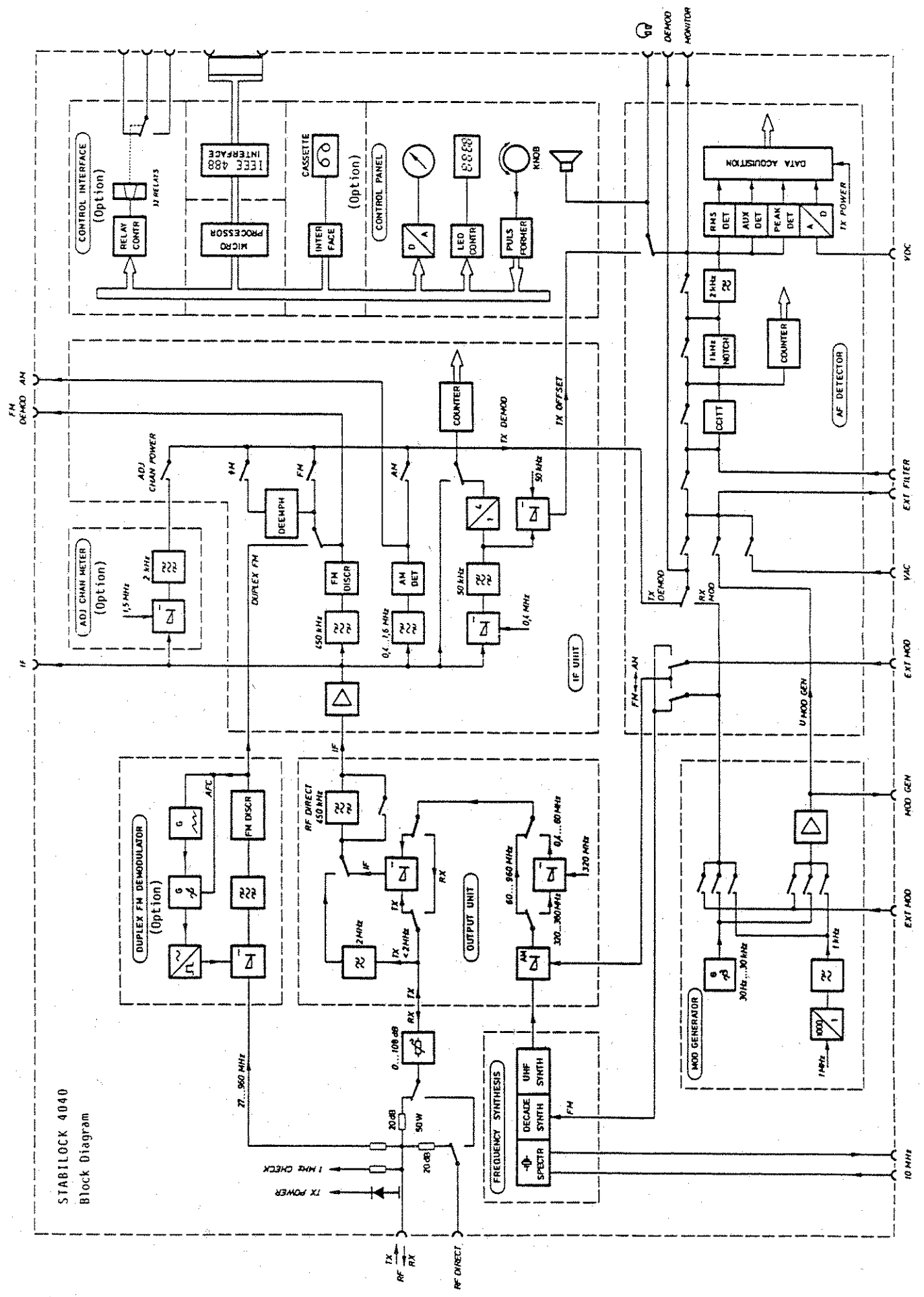

RX Measurement

Setting the STABLOCK 4040 for RX measurement:
 RX or AUTO and TX power <50 mW

Frequency Setting
 Rad MHz dB → ①
 Frequency variation:
 ← → + - → ①
 Fine frequency detuning:
 By knob $\pm f$ → ②
 Polarity: + - → ②

RF Output Level Setting
 → ④
 By knob: RX LEVEL → ④
 Switch off and on: → ④
 Change unit:
 → ④
 EMF or EMF:2 display:
 EMF INTO 50Ω
 RX → ④

Modulation Setting
 Mod frequency display: → ③
 Internal fixed frequencies:
 + - → ③
 Internal 30 Hz...30 kHz:
 → ③
 Vary frequency:
 ← → + - → ③
 Internal 1 kHz: → ③
 External Modulation:
 (ON ② 7) → ③
 Set modulation:
 → ⑤
 UNIT = kHz, % or Rad
 By knob: MOD VAR, MOD 1 kHz (MOD EXT) → ⑤

Superimposing MOD VAR, MOD 1 kHz and MOD EXT after setting separately.

TX Measurement

Setting the STABLOCK 4040 for TX measurement:
 TX or AUTO and TX power >50 mW

TX Power Display → ④
TX Frequency Error Measurement
 Enter nominal TX frequency:
 Rad MHz dB → ①
 Frequency error → ②

TX Frequency Measurement
 Result → ①
 ② = blanked
 Back to error measurement:

Modulation Generators
 Signal at socket MOD GEN
 Frequency display: → ③
 Set fixed frequencies:
 + - → ③
 Set 30 Hz ... 30 kHz:
 → ③
 Vary 30 Hz ... 30 kHz frequencies:
 ← → + - → ③
 Switch on 1 kHz Mod. Generator:
 → ③

AF output level display:
 → ⑥
Set output level digitally:

 By knob: GEN VAR, GEN 1 kHz, → ⑥

Modulation Measurement
 → ⑤
 UNIT: FM = kHz, AM = %, φM = rad

SPECIALS

Calling up measuring modes or starting measuring routines: X
 X = SPECIAL number 01...37

Switch off measuring modes: X
 End of routines: LED extinguishes
 Entry of measuring conditions ... :
 X → ④

Often used Routines
 12: receiver sensitivity at 20 dB SINAD → ④
 13: 6 dB bandwidth → ①
 and centre frequency error → ②
 14: squelch level → ④
 hysteresis → ⑥

AUTOTEST

Calling up Measuring Programs (Files)
 X Test set performs step 01 of program X. X=0: non-volatile storage in 4040, X=1...9: cassette
 Go to next or previous step:
 ← →
 End of AUTOTEST:

Setting up Programs
 X (X as above)
 Set 4040 for the first step and enter waiting times, print mode, tolerances and relay control
 Enter print command for the desired measuring result:
 Y (Y = ①...⑥)
 STEP ← → Set 4040 for the next step
 STEP ← → and so on
 Ending the program:

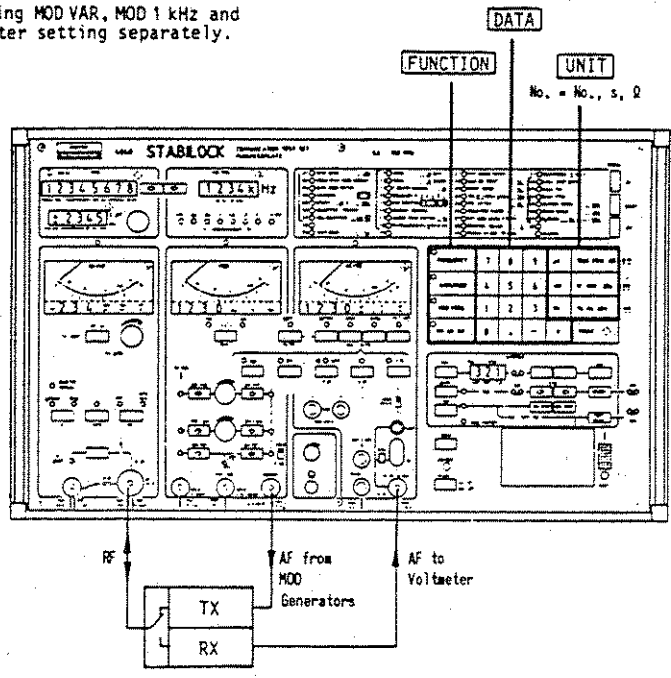

STABLOCK 4040
 Short form operating instruction

