

2553A

Precision DC Calibrator

U S E R ' S M A N U A L

Product Registration

Thank you for purchasing YOKOGAWA products.

YOKOGAWA provides registered users with a variety of information and services. Please allow us to serve you best by completing the product registration form accessible from our website.

<http://tmi.yokogawa.com/>

Thank you for purchasing the 2553A Precision DC Calibrator. The 2553A is a DC calibrator that sources DC voltage, DC current, and resistance. It also sources thermoelectromotive force and resistance that simulate those of a temperature sensor.

DC voltage	± 100 nV to ± 32 V
DC current	± 10 nA to ± 120 mA
Resistance	18 Ω to 400 Ω
Temperature sensor	Thermocouple: R, S, B, J, T, E, K, N, C, A, user-defined RTD: Pt100, user-defined

This user's manual explains the features, operating procedures, and handling precautions of the 2553A. To ensure correct use, please read this manual thoroughly before beginning operation. Keep this manual in a safe place for quick reference in the event that a question arises.

List of Manuals

The following manuals, including this one, are provided as manuals for the 2553A. Please read all manuals.

Manual Title	Manual No.	Description
2553A Precision DC Calibrator User's Manual	IM 2553A-01EN	This manual. The manual explains the handling precautions, features, specifications, communication interfaces, how to operate the 2553A, and so on.
Model 2553A Precision DC Calibrator User's Manual	IM 2553A-92Z1	Document for China

The "EN" and "Z1" in the manual numbers are the language codes.

Contact information of Yokogawa offices worldwide is provided on the following sheet.

Document No.	Description
PIM 113-01Z2	List of worldwide contacts

Notes

- The contents of this manual are subject to change without prior notice as a result of continuing improvements to the instrument's performance and functionality. The figures given in this manual may differ from those that actually appear on your screen.
- Every effort has been made in the preparation of this manual to ensure the accuracy of its contents. However, should you have any questions or find any errors, please contact your nearest YOKOGAWA dealer.
- Copying or reproducing all or any part of the contents of this manual without the permission of YOKOGAWA is strictly prohibited.
- The TCP/IP software of this product and the documents concerning it have been developed/created by YOKOGAWA based on the BSD Networking Software, Release 1 that has been licensed from the Regents of the University of California.

Trademarks

- Microsoft, Internet Explorer, MS-DOS, Windows, Windows NT, Windows XP, Windows Vista, Windows 7, and Windows 8 are either registered trademarks or trademarks of Microsoft Corporation in the United States and/or other countries.
- Adobe and Acrobat are either registered trademarks or trademarks of Adobe Systems Incorporated.
- In this manual, the ® and TM symbols do not accompany their respective registered trademark or trademark names.
- Other company and product names are trademarks or registered trademarks of their respective holders.

Revisions

November 2014	1st Edition
October 2017	2nd Edition

Checking the Contents of the Package

Unpack the box and check the contents before operating the instrument. If the wrong items have been delivered, if items are missing, or if there is a problem with the appearance of the items, contact your nearest YOKOGAWA dealer.

2553A

Check that the product that you received is what you ordered by referring to the model name and suffix code given on the name plate on the rear panel.

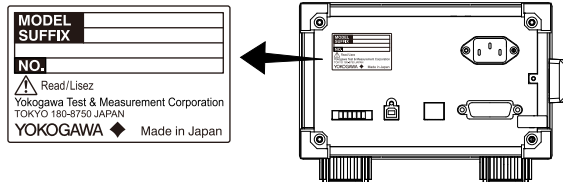

MODEL and SUFFIX Codes

Model	Suffix Code	Specifications
2553A		± 32 VDC, ± 120 mADC
	-VA	Version A
Temperature unit	-UC	Temperature unit Celsius ($^{\circ}\text{C}$)
	-UF	Temperature unit Celsius ($^{\circ}\text{C}$) and Fahrenheit ($^{\circ}\text{F}$)
Power cord*	-D	UL/CSA standard power cord, maximum rated voltage: 125 V
	-F	VDE standard power cord, maximum rated voltage: 250 V
	-R	AS standard power cord, maximum rated voltage: 250 V
	-Q	BS standard power cord, maximum rated voltage: 250 V
	-H	GB standard power cord, maximum rated voltage: 250 V
	-N	NBR standard power cord, maximum rated voltage: 250 V

* Make sure that the attached power cord meets the designated standards of the country and area that you are using it in.

No. (Instrument number)

When contacting the dealer from which you purchased the instrument, please give them the instrument number.

Standard Accessories

The instrument is shipped with the following accessories. Make sure that all accessories are present and undamaged.

Power cord (one cord that matches the suffix code is included)*

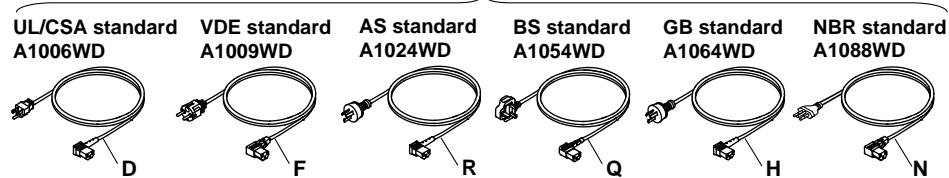

Measurement lead
366961

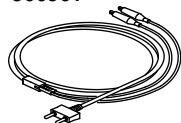

Terminal plug
A2119JT



Rubber leg cap
A9088ZM



Manuals

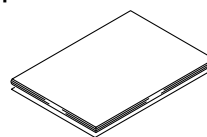

IM 2553A-01EN
User's Manual (this manual)
IM 2553A-92Z1
Document for China
PIM 113-01Z2
List of worldwide contacts

* Make sure that the attached power cord meets the designated standards of the country and area that you are using it in.

Optional Accessories (Sold separately)

The following optional accessories are available for purchase separately.

For information about ordering accessories, contact your nearest YOKOGAWA dealer.

Item	Model/Part No.	Min. Q'ty	Note
Measurement lead set	758933	1 set	Safety terminal cable. Length: 1 m.
Measurement lead set	758917	1 set	Safety terminal cable. Length: 0.75 m.
Measurement lead set	366961	1 set	1:1 Banana-alligator clip cable. Length: 1.2 m.
Alligator clip adapter set	758922	1 set	Safety terminal-to-alligator clip adapter. Rating: 300 V.
Fork terminal adapter set	758921	1 set	Safety terminal-to-fork terminal adapter
RJ Sensor	257875	1	For reference junction compensation. Pt100 sensor.

Safety Precautions

This instrument is an IEC safety class I instrument (provided with a terminal for protective earth grounding).

The general safety precautions described herein must be observed during all phases of operation. If the instrument is used in a manner not specified in this manual, the protection provided by the instrument may be impaired. YOKOGAWA assumes no liability for the customer's failure to comply with these requirements.

The following symbols are used on this instrument.



Warning: handle with care. Refer to the user's manual or service manual. This symbol appears on dangerous locations on the meter which require special instructions for proper handling or use. The same symbol appears in the corresponding place in the manual to identify those instructions.



Ground (earth) or functional ground terminal (do not use this terminal as a protective ground terminal)



Alternating current



On (power)



Off (power)



Power-on state



Power-off state

French



Avertissement : À manipuler délicatement. Toujours se reporter aux manuels d'utilisation et d'entretien. Ce symbole a été apposé aux endroits dangereux de l'instrument pour lesquels des consignes spéciales d'utilisation ou de manipulation ont été émises. Le même symbole apparaît à l'endroit correspondant du manuel pour identifier les consignes qui s'y rapportent.



Borne de terre ou borne de terre fonctionnelle (ne pas utiliser cette borne comme prise de terre)



Courant alternatif



Marche (alimentation)



Arrêt (alimentation)



Marche



Arrêt

Failure to comply with the precautions below could lead to injury or death or damage to the instrument.

WARNING

Use the Instrument Only for Its Intended Purpose

The 2553A is a DC calibrator that sources DC voltage, DC current, and resistance. It also sources thermoelectromotive force and resistance that simulate those of a temperature sensor. Use the 2553A only for these purposes.

Check the Physical Appearance

Do not use the instrument if there is a problem with its physical appearance.

Use the Correct Power Supply

Before connecting the power cord, ensure that the source voltage matches the rated supply voltage of the 2553A and that it is within the maximum rated voltage of the provided power cord.

Use the Correct Power Cord and Plug

To prevent the possibility of electric shock or fire, be sure to use the power cord supplied by YOKOGAWA. The main power plug must be plugged into an outlet with a protective earth terminal. Do not invalidate this protection by using an extension cord without protective earth grounding. Additionally, do not use the power cord supplied with this instrument with another instrument.

Connect the Protective Grounding Terminal

Make sure to connect the protective earth to prevent electric shock before turning on the power. The power cord that comes with the instrument is a three-prong type power cord. Connect the power cord to a properly grounded three-prong outlet.

Do Not Impair the Protective Grounding

Never cut off the internal or external protective earth wire or disconnect the wiring of the protective earth terminal. Doing so may result in electric shock or damage to the instrument.

Do Not Use When the Protection Functions Are Defective

Before using this instrument, check that the protection functions, such as the protective grounding and fuse, are working properly. If you suspect a defect, do not use the instrument.

Do Not Operate in an Explosive Atmosphere

Do not operate the instrument in the presence of flammable gases or vapors. Doing so is extremely dangerous.

Do Not Remove the Covers or Disassemble or Alter the Instrument

Only qualified YOKOGAWA personnel may remove the covers and disassemble or alter the instrument. The inside of the instrument is dangerous because parts of it have high voltages.

Ground the Instrument before Making External Connections

Securely connect the protective grounding before connecting to the target device or to an external control unit. Before touching the target device, turn off this instrument and check that there is no voltage or current being output.

Safety Precautions

Measurement Category

The measurement category of the 2553A terminals is Other (O). Do not use it for main power supply circuits or circuits that fall under Measurement Categories II, III, and IV.

Install or Use the Instrument in Appropriate Locations

- Do not install or use the instrument outdoors or in locations subject to rain or water.
- Install the instrument so that you can immediately remove the power cord if an abnormal or dangerous condition occurs.

Wire Cables Correctly

This instrument sources voltage and current. Not wiring the devices correctly may damage the instrument or the target device. Be careful when you wire the cables, and be sure to check the following points.

Before output (before turning on the output), check that:

- Cables have been wired to the instrument's output terminals correctly.
- Cables have been wired to the target device correctly.
Check that there are no short circuits between terminals or between the cables connected to the terminals.
- The cables are fastened firmly to the terminals.
- There no problems with the terminals, such as the presence of foreign substances.

During output (do not touch the terminals or the connected cables when this instrument is on), check that:

- There no problems with the terminals, such as the presence of foreign substances.
- The terminals are not abnormally hot.

After output (immediately after the output is turned off)

After you output a voltage or current, voltage may remain for some time even after you turn the output off. Do not touch the terminals immediately after you turn the output off. The amount of time that voltage remains varies depending on the target device.

CAUTION

Operating Environment Limitations

This product is a Class A (for industrial environment) product. Operation of this product in a residential area may cause radio interference in which case the user will be required to correct the interference.

French

AVERTISSEMENT

Utiliser l'instrument aux seules fins pour lesquelles il est prévu

Le 2553A est un calibre c.c. qui émet de la tension c.c., du courant c.c. et de la résistance. Il émet également une force thermo-électromotive et une résistance qui stimulent celles des capteurs de température. Utiliser le 2553A à ces fins exclusives.

Inspecter l'apparence physique

Ne pas utiliser l'instrument si son intégrité physique semble être compromise.

Vérifier l'alimentation

Avant de brancher le cordon d'alimentation, vérifier que la tension source correspond à la tension d'alimentation nominale du 2553A et qu'elle est compatible avec la tension nominale maximale du cordon d'alimentation.

Utiliser le cordon d'alimentation et la fiche adaptés

Pour éviter les risques de choc électrique ou d'incendie, utilisez le cordon d'alimentation fourni par YOKOGAWA. La fiche doit être branchée sur une prise secteur raccordée à la terre. En cas d'utilisation d'une rallonge, celle-ci doit être impérativement reliée à la terre. Par ailleurs, n'utilisez pas le cordon d'alimentation fourni pour cet instrument avec un autre appareil.

Brancher la prise de terre

Avant de mettre l'instrument sous tension, penser à brancher la prise de terre pour éviter tout choc électrique. Le cordon d'alimentation livré avec l'instrument est doté de trois broches. Brancher le cordon d'alimentation sur une prise de courant à trois plots et mise à la terre.

Ne pas entraver la mise à la terre de protection

Ne jamais neutraliser le fil de terre interne ou externe, ni débrancher la borne de mise à la terre. Cela pourrait entraîner un choc électrique ou endommager l'instrument.

Ne pas utiliser lorsque les fonctions de protection sont défectueuses

Avant d'utiliser l'instrument, vérifier que les fonctions de protection, telles que le raccordement à la terre et le fusible, fonctionnent correctement. En cas de dysfonctionnement possible, ne pas utiliser l'instrument.

Ne pas utiliser dans un environnement explosif

Ne pas utiliser l'instrument en présence de gaz ou de vapeurs inflammables. Cela pourrait être extrêmement dangereux.

Ne pas retirer le capot, ni démonter ou modifier l'instrument

Seul le personnel YOKOGAWA qualifié est habilité à retirer le capot et à démonter ou modifier l'instrument. Certains composants à l'intérieur de l'instrument sont à haute tension et par conséquent, représentent un danger.

Relier l'instrument à la terre avant de le brancher sur des connexions externes

Connectez le conducteur de terre avant de raccorder le dispositif cible ou une unité de commande externe. Avant de toucher le dispositif cible, mettez l'instrument hors tension, et vérifiez qu'aucune tension ni aucun courant ne sont émis.

Catégorie de mesure

La catégorie de mesure des bornes 2553A est O (Other, Autre). Ne l'utilisez pas pour les circuits d'alimentation principale ou ceux correspondant aux catégories de mesure II, III et IV.

Installer et utiliser l'instrument aux emplacements appropriés

- Ne pas installer, ni utiliser l'instrument à l'extérieur ou dans des lieux exposés à la pluie ou à l'eau.
- Installer l'instrument de manière à pouvoir immédiatement le débrancher du secteur en cas de fonctionnement anormal ou dangereux.

Vérifier le câblage

Cet instrument émet de la tension et du courant. Un câblage inapproprié de cet appareil peut endommager l'instrument ou l'appareil cible. Toujours brancher les câbles correctement et vérifier les points suivants.

Avant le sortie (avant la mise sous tension), vérifier que :

- Les câbles ont été correctement branchés sur les bornes de sortie de l'instrument.
- Les câbles ont été correctement branchés sur l'appareil cible.
Vérifier qu'il n'y a pas de court-circuit entre les bornes ou entre les câbles branchés sur les bornes.
- Les câbles sont fermement vissés sur les bornes.
- Les bornes ne présentent aucune anomalie, telle la présence de corps étrangers.

Pendant la sortie (ne pas toucher les bornes ni les câbles branchés lorsque l'instrument est sous tension), vérifier que :

- Les bornes ne présentent aucune anomalie, telle la présence de corps étrangers.
- Les bornes ne chauffent pas anormalement.

Après la sortie (tout de suite après la mise hors tension)

Après avoir émis une tension ou un courant élevé, une tension résiduelle peut rester un certain temps dans l'appareil mesuré, même après sa mise hors tension. Ne pas toucher les bornes tout de suite après avoir mis l'appareil hors tension. La durée pendant laquelle la tension résiduelle reste dans l'appareil varie selon les appareils.

ATTENTION

Limitations relatives à l'environnement opérationnel

Ce produit est un produit de classe A (pour environnements industriels). L'utilisation de ce produit dans un zone résidentielle peut entraîner une interférence radio que l'utilisateur sera tenu de rectifier.

Sales in Each Country or Region

Waste Electrical and Electronic Equipment



Waste Electrical and Electronic Equipment (WEEE), Directive

(This directive is valid only in the EU.)

This product complies with the WEEE directive marking requirement. This marking indicates that you must not discard this electrical/electronic product in domestic household waste.

Product Category

With reference to the equipment types in the WEEE directive, this product is classified as a “Monitoring and control instruments” product.

When disposing products in the EU, contact your local Yokogawa Europe B. V. office.
Do not dispose in domestic household waste.

Authorized Representative in the EEA

Yokogawa Europe B. V. is the authorized representative of Yokogawa Test & Measurement Corporation in the EEA for this product. To contact Yokogawa Europe B. V., see the separate list of worldwide contacts, PIM 113-01Z2.

Conventions Used in This Manual

Notes

The notes and cautions in this manual are categorized using the following symbols.



Improper handling or use can lead to injury to the user or damage to the instrument. This symbol appears on the instrument to indicate that the user must refer to the user's manual for special instructions. The same symbol appears in the corresponding place in the user's manual to identify those instructions. In the user's manual, the symbol is used in conjunction with the word "WARNING" or "CAUTION."

WARNING

Calls attention to actions or conditions that could cause serious or fatal injury to the user, and precautions that can be taken to prevent such occurrences.

CAUTION

Calls attention to actions or conditions that could cause light injury to the user or cause damage to the instrument or user's data, and precautions that can be taken to prevent such occurrences.

French

AVERTISSEMENT

Attire l'attention sur des gestes ou des conditions susceptibles de provoquer des blessures graves (voire mortelles), et sur les précautions de sécurité pouvant prévenir de tels accidents.

ATTENTION

Attire l'attention sur des gestes ou des conditions susceptibles de provoquer des blessures légères ou d'endommager l'instrument ou les données de l'utilisateur, et sur les précautions de sécurité susceptibles de prévenir de tels accidents.

Note

Calls attention to information that is important for the proper operation of the instrument.

Characters That Appear on the 7-Segment LED

Because this instrument uses a 7-segment LED display, numbers, letters, and mathematical symbols are displayed using special characters. For details, see section 1.2, "Digital Numbers and Characters."

Symbols and Conventions Used in Procedural Explanations

The contents of the procedural explanations are indicated using the following symbols.

Procedure

Carry out the procedure according to the step numbers. All procedures are written under the assumption that you are starting operation at the beginning of the procedure, so you may not need to carry out all the steps in a procedure when you are changing the settings.

Explanation

This section describes the setup items and the limitations regarding the procedures. It may not give a detailed explanation of the feature. For a detailed explanation of the feature, see chapter 2.

<<Command Mnemonic>>

Indicates a communication command that corresponds to some of the features described on the procedural explanation page.

Characters and Terminology Used in Procedural Explanations

Dial and Switches

Bold characters used in the procedural explanations indicate dials and switches on the panel.

Contents

List of Manuals.....	i
Checking the Contents of the Package.....	ii
Safety Precautions.....	iv
Sales in Each Country or Region.....	ix
Conventions Used in This Manual.....	x

Chapter 1 Names and Functions of Parts

1.1 Panels	1-1
1.2 Digital Numbers and Characters	1-3

Chapter 2 Features

2.1 DC Voltage, DC Current, and Resistance Sourcing.....	2-1
2.2 Temperature-Sensor-Simulation Thermoelectromotive-Force and Resistance Sourcing.....	2-3
2.3 Other Features	2-5

Chapter 3 Preparation

3.1 Handling Precautions	3-1
3.2 Installing the 2553A.....	3-3
⚠ 3.3 Connecting to the Power Supply	3-6
3.4 Turning On and Off the Power Switch	3-8
⚠ 3.5 Wiring Precautions	3-10
⚠ 3.6 Connecting Wires.....	3-12

Chapter 4 SETUP Menu

4.1 SETUP Menu Tree Structure.....	4-1
4.2 Using the SETUP Menu	4-3

Chapter 5 Voltage, Current, and Resistance Sourcing

5.1 Selecting the Voltage, Current, or Resistance Range.....	5-1
5.2 Specifying the Output Setting and Polarity.....	5-2
5.3 Turning the Output On and Off.....	5-4

Chapter 6 Temperature-Sensor-Simulation Thermoelectromotive-Force and Resistance Sourcing

6.1 Selecting Thermocouples and RTDs.....	6-1
6.2 Setting the Temperature	6-3
6.3 Turning the Output On and Off.....	6-5
6.4 Writing User-Defined Data.....	6-6
6.5 Setting Reference Junction Compensation.....	6-11
6.6 Selecting the Temperature Unit	6-15

Chapter 7 GP-IB Interface

7.1 GP-IB Interface Features and Specifications	7-1
7.2 Connecting through the GP-IB Interface	7-3
7.3 Configuring the 2553A GP-IB Settings	7-5
7.4 Responses to Interface Messages	7-8

Chapter 8 Ethernet Interface		1
8.1 Ethernet Interface Features and Specifications	8-1	
8.2 Connecting to the Ethernet Interface.....	8-2	2
8.3 Configuring the 2553A Ethernet Settings	8-3	
Chapter 9 USB Interface		3
9.1 USB Interface Features and Specifications.....	9-1	
9.2 Connecting through the USB Interface.....	9-2	4
9.3 Configuring the 2553A USB Interface	9-3	
Chapter 10 Programming Overview		5
10.1 Messages.....	10-1	
10.2 Commands.....	10-3	
10.3 Responses	10-5	6
10.4 Data.....	10-6	
10.5 Synchronization with the Controller.....	10-8	
Chapter 11 Commands		7
11.1 List of Commands	11-1	
11.2 COMMunicate Group	11-3	
11.3 OUTPut Group	11-4	8
11.4 SOURce Group	11-5	
11.5 STATus Group.....	11-10	
11.6 SYSTem Group	11-11	
11.7 Common Command Group	11-13	9
Chapter 12 Status Reports		10
12.1 About Status Reports	12-1	
12.2 Status Byte	12-3	
12.3 Standard Event Register	12-4	
12.4 Extended Event Register.....	12-5	
12.5 Output and Error Queues	12-6	11
Chapter 13 Troubleshooting, Maintenance, and Inspection		12
13.1 Troubleshooting.....	13-1	
13.2 Error Indication	13-2	
13.3 Error Code Descriptions and Corrective Actions	13-4	
13.4 Communication Error Messages	13-5	13
13.5 Displaying the Error Log.....	13-8	
13.6 Instrument Error Detection and Clearance.....	13-10	
13.7 Self-Test	13-11	
13.8 Initializing the Settings.....	13-12	
13.9 Displaying the Product Information	13-13	14
13.10 Calibration and Adjustment	13-15	

1

2

3

4

5

6

7

8

9

10

11

12

13

14

App

Index

Contents

Chapter 14 Specifications

14.1	Source Section	14-1
14.2	Functions	14-5
14.3	External Input	14-6
14.4	Computer Interface.....	14-6
14.5	General Specifications	14-7
14.6	RJ Sensor 257875 Specifications	14-9
14.7	External Dimensions	14-10

Appendix

Appendix 1	Block Diagram.....	App-1
Appendix 2	Thermocouple Calibration Wiring Examples	App-2
Appendix 3	RTD Calibration Wiring Examples.....	App-4
Appendix 4	User Definitions of Thermocouples and RTDs	App-5
Appendix 5	List of Default Settings and Settings That Are Saved	App-9
Appendix 6	About the IEEE 488.2-1992 Standard.....	App-10
Appendix 7	ASCII Character Codes.....	App-11

Index

1.1 Panels

Front Panel

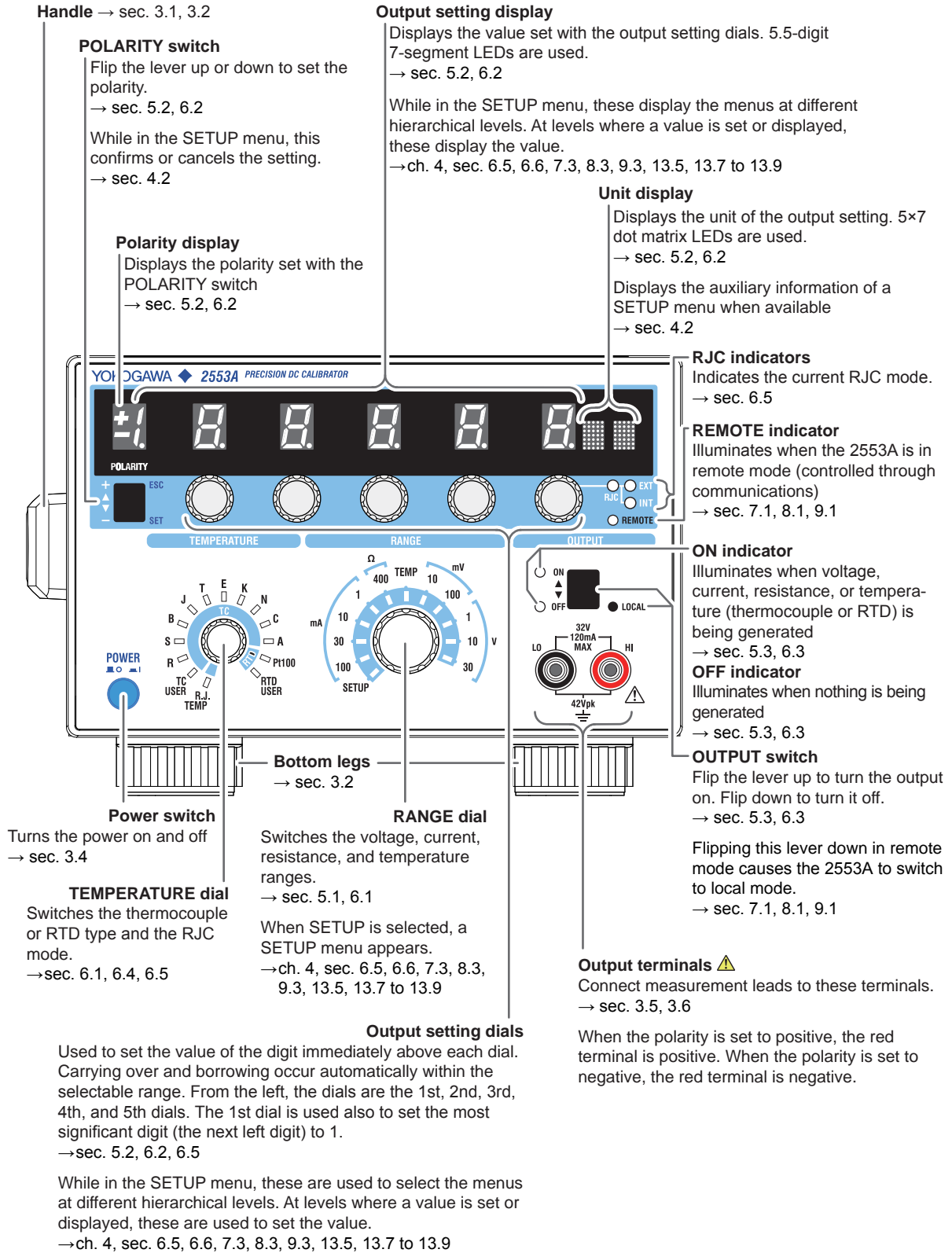

1.2 Digital Numbers and Characters

Because this instrument uses a 7-segment LED display to show output settings, special characters are used to display numbers, letters, and mathematical symbols as shown below. Some of the characters shown below are not used by this instrument.

0 → 0	A → A	K → k	U → U	^(power) → ^
1 → 1	B → b	L → L	V → v	
2 → 2	C → C Lowercase c → c	M → m	W → w	
3 → 3	D → d	N → n	X → x	
4 → 4	E → E	O → o	Y → y	
5 → 5	F → F	P → P	Z → z	
6 → 6	G → G	Q → q	+ → +	
7 → 7	H → H Lowercase h → h	R → r	- → -	
8 → 8	I → i	S → S	x → x	
9 → 9	J → J	T → t	÷ → ÷	

2.1 DC Voltage, DC Current, and Resistance Sourcing

The 2553A is a DC calibrator that sources DC voltage, DC current, and resistance. It also sources thermoelectromotive force and resistance that simulate those of a temperature sensor. This section describes the DC voltage, DC current, and resistance sourcing features. For a description of the thermoelectromotive-force and resistance sourcing features, see section 2.2.

Source and Sink

The 2553A can not only source current but also sink current.^{1, 2} Sinking is possible regardless of whether the source voltage is positive or negative.

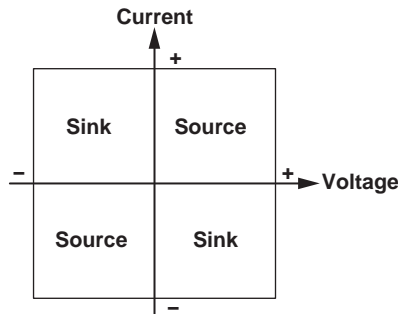

- 1 By absorbing the current from a voltage source such as a distributor, the 2553A can simulate a load, like a two-wire transmitter.
- 2 Excludes the 10 mV range. When using the 10 mV range, do not apply external voltage or current.

DC Voltage Sourcing

The source range and output current for each voltage range are shown below. The 2553A outputs the specified DC voltage, within the range limited by the maximum output current, to the load circuit connected to the output terminals.

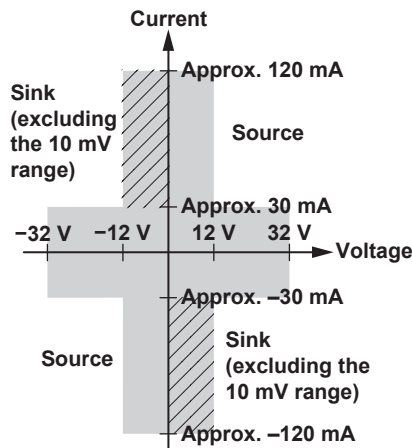

Range	Source Range	Maximum Output Current
10 mV	±12.0000 mV	— ¹
100 mV	±120.000 mV	10 mA or higher ²
1 V	±1.20000 V	Approx. 120 mA
10 V	±12.0000 V	Approx. 120 mA
30 V	±32.000 V	Approx. 30 mA

- 1 Since a voltage divider is used in the 10 mV range, the output resistance is approximately 1 Ω. It is not suitable for connecting to a low-impedance load that requires current to flow through. The output voltage will drop if such a load is connected. Connect a high-impedance load, a load that is sufficiently larger than the output resistance. When using the 10 mV range, do not apply external voltage or current. Doing so may damage the voltage divider.
- 2 In the 100 mV range, the output voltage may drop significantly when the output current exceeds 10 mA. Connect a load that will not cause the output current to exceed 10 mA.

The maximum sink current is the same as the maximum output current of each range except for the 10 mV range.

▨ : Immediately after sinking current in this region, errors exceeding the accuracy specifications may occur due to the increased temperature inside the 2553A.

DC Current Sourcing

The source range and output voltage for each current range are shown below. The 2553A outputs the specified DC current, within the range limited by the maximum output voltage, to the load circuit connected to the output terminals.

1 mA, 10 mA, or 100 mA range

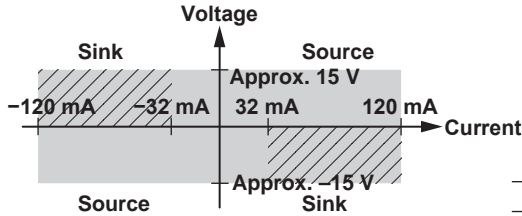

Range	Source Range	Maximum Output Voltage
1 mA	±1.20000 mA	Approx. 15 V
10 mA	±12.0000 mA	Approx. 15 V
30 mA	±32.000 mA	Approx. 30 V
100 mA	±120.000 mA	Approx. 15 V

30 mA range

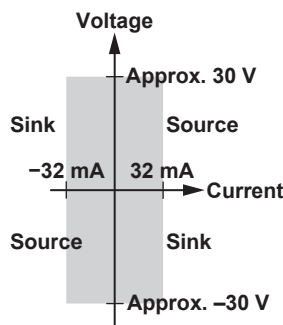

The sink current range is the same as the source range of each range.

☐ : Immediately after sinking current in this region, errors exceeding the accuracy specifications may occur due to the increased temperature inside the 2553A.

Resistance Sourcing

The 2553A sources simulation resistance $R (= V/I)$ by outputting from its output terminals voltage V , which is defined as $R \times I$, where R is the specified resistance and I the excitation current for measuring resistance. The excitation current is supplied to the 2553A output terminals from the device to be calibrated.* For example, if the excitation current is 1 mA and the specified resistance is 100 Ω , the 2553A outputs 0.1 V.

The source range and excitation current for the resistance are shown below.

* Resistance measuring instrument, RTD thermometer, etc.

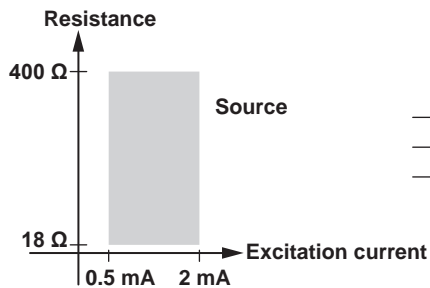

Range	Source Range	Excitation current
400 Ω	18.00 Ω to 400.00 Ω	0.5 mA to 2 mA

Turning the Output On and Off

The specified voltage, current, or resistance output and current sink can be turned on and off.

- ON

The specified voltage, current, or resistance is output from the output terminals. If the output is outside the selectable range, the output cannot be turned on. In current sink mode, sinking is performed.

- OFF

No output is produced. If you change the range or if the overload protection function is activated, the output automatically turns off.

2.2 Temperature-Sensor-Simulation Thermoelectromotive-Force and Resistance Sourcing

For the specified temperature, the 2553A sources thermoelectromotive force and resistance that simulate those of a thermocouple and RTD.

Thermocouple

The 2553A outputs from its output terminals the thermoelectromotive force (voltage) that corresponds to the specified temperature according to the selected thermocouple type. The available thermocouple types are R through A as defined by IEC and JIS standards and are listed in the following table. It is also possible to user-define the relationship between temperature and thermoelectromotive force and output thermoelectromotive force according to the definition.

- * Since a voltage divider is used to set the different thermocouple ranges, the output resistance is approximately 1 Ω . It is not suitable for connecting to a low-impedance load that requires current to flow through. The output voltage will drop if such a load is connected. Connect a high-impedance load, a load that is sufficiently larger than the output resistance. When using thermocouple ranges, do not apply external voltage or current. Doing so may damage the voltage divider.

Type	Source Range
R	-50°C to +1768°C
S	-50°C to +1768°C
B	0°C to +1820°C
J	-210°C to +1200°C
T	-270°C to +400°C
E	-270°C to +1000°C
K	-270°C to +1300°C
N	-270°C to +1300°C
C	0°C to +2315°C
A	0°C to +2500°C
TC USER (user-defined)	-9999.9°C to +9999.9°C

RJC Mode

The RJC mode can be set to auto, internal, or manual input. The 2553A corrects the sourced thermoelectromotive force (RJC) according to the selected mode. It is also possible to source thermoelectromotive force without correction.

- Auto
 - When the 2553A detects that an RJ sensor is connected to the external RJ sensor input terminal on the rear panel, the 2553A sources thermoelectromotive force that is corrected using the temperature measured by the external RJ sensor. The 2553A can measure the terminal temperature of the device to be calibrated that is connected to the 2553A using an RJ sensor and source thermoelectromotive force that is corrected using the measured temperature.
 - If an RJ sensor is not connected to the 2553A or is not detected, the 2553A applies its internal RJC.
 - RJ sensors 257875 are sold separately as accessories. An RTD Pt100 can also be used as an RJ sensor.
- Internal

The 2553A sources thermoelectromotive force that is corrected using the temperature of its output terminals.

2.2 Temperature-Sensor-Simulation Thermoelectromotive-Force and Resistance Sourcing

- Manual input

The 2553A sources thermoelectromotive force that is corrected using the manually input temperature.

If you do not want to apply correction (not use the RJC function), you set the temperature to 0°C.

- * In a thermocouple temperature measurement, the temperature is measured from the thermoelectromotive force that is produced due to the temperature difference between the measurement point and the other contact point. If the other contact point is 0°C, the temperature at the measurement point can be found straight from the thermoelectromotive force. Normally, the other contact point is a terminal on a measuring instrument, so the temperature of that terminal is measured and used for correcting the actual measurement. This is called reference junction compensation.

RTD

The 2553A outputs from its output terminals the resistance of an RTD Pt100 that corresponds to the specified temperature. The 2553A supports Pt100, which is defined by IEC and JIS standards. It is also possible to user-define the relationship between temperature and resistance and output resistance according to the definition.

Type	Source Range
Pt100	-200.0°C to +850.0°C
RTD USER (user-defined)	-9999.9°C to +9999.9°C

Turning the Output On and Off

The output of a thermoelectromotive force or resistance that corresponds to the specified temperature can be turned on and off.

- ON

Thermoelectromotive force or resistance is output from the output terminals. If the output is outside the selectable range, the output cannot be turned on.

- OFF

No output is produced. If you change the thermocouple or RTD type, the output automatically turns off.

User Definition

You can define (user-define) any thermoelectromotive force and resistance that simulate those of thermocouples or RTDs and then source thermoelectromotive force and resistance according to the definitions. User-defined data is created by specifying coefficients of polynomials for each temperature range. The data that you create are written to the 2553A in the following manner.

- Write the user-defined data saved in a file to the 2553A using the USB mass storage feature.
- Transmit the user-defined data for each temperature range using communication commands. The transmitted data is written to the 2553A.

You can assign a type character to distinguish a user definition from other user definitions. The type character is displayed as the second character on the dot matrix LEDs for displaying the unit when a user-defined thermoelectromotive-force or resistance source is selected.

For the user-defined data syntax and setup procedure, see appendix 4.

Temperature Unit

If the suffix code is -UC, the temperature unit is Celsius (°C). If the suffix code is -UF, you can select Celsius (°C) or Fahrenheit (°F). You use the SETUP menu to select it.

2.3 Other Features

Error Log Display

The error log keeps a record of error codes that occur in communication and self-tests while the 2553A is on. You use the SETUP menu to display the error log. The error log is cleared when the power is turned off.

Initialization

You can initialize the 2553A settings to their factory defaults. You use the SETUP menu to do so. Communication settings and a portion of other settings are not initialized. For details on the items that are initialized, see appendix 5.

Displaying the Product Information

The firmware version, serial number, and the like can be displayed. You use the SETUP menu to display them.

- Firmware version
- Logic program version
- Boot program version
- Serial number (instrument number)

3.1 Handling Precautions

Safety Precautions

If you are using the 2553A for the first time, make sure to read "Safety Precautions," on pages iv and vi.

Do Not Remove the Case

Do not remove the case from the instrument. Some parts of the instrument use high voltages and are extremely dangerous. For internal inspection and adjustment, contact your nearest YOKOGAWA dealer.

Unplug If Abnormal Behavior Occurs

If you notice smoke or unusual odors coming from the instrument, immediately turn off the power and unplug the power cord. Also, turn off the power to the target device that are connected to the output terminals. Then, contact your nearest YOKOGAWA dealer.

Do Not Damage the Power Cord

Nothing should be placed on top of the power cord. The power cord should also be kept away from any heat sources. When removing the plug from the power outlet, do not pull on the cord. Pull from the plug. If the power cord is damaged, purchase a replacement with the same part number as the one indicated on page ii.

Correct the Problem If Output Is Automatically Turned Off

If an abnormality is detected in the internal circuit due to a voltage or current overloading, voltage or current output oscillation, and so on, the 2553A will automatically turn off the output and display a warning message (No. 032 to 035) on the output display. For details on the messages, see section 13.3.

In the case of voltage output, remove the cause of the problem, such as the external load, and turn the output on again.

In the case of current output, remove the cause of the problem, such as the external load, short the current terminals, and turn the output on again.

If the output still turns off after you have corrected the problem, the 2553A may be malfunctioning. Contact your nearest YOKOGAWA dealer.

General Handling Precautions

Do Not Place Objects on Top of the Instrument

Never place objects such as other instruments or objects that contain water on top of the instrument. Doing so may damage the instrument. For details on stacking the 2553A, see section 3.2.

Keep Electrically Charged Objects Away from the Instrument

Keep electrically charged objects away from the input and output terminals. They may damage the internal circuitry.

Unplug during Extended Non-Use

Turn off the instrument and remove the power cord from the outlet.

When Carrying the Instrument

First, be sure to turn off the power switch and remove the power cord and other connected lead wires and cables. When carrying the instrument, either hold the handle or hold the instrument with both hands as shown in the figure below, and move it carefully.

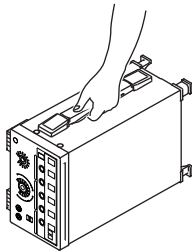

WARNING

- When you hold or put away the handle, be careful not to get your hand caught between the handle and the case.
- When you carry the instrument, be careful not to get your hand caught between the wall, installation surface, or other objects and the instrument.

French

AVERTISSEMENT

- Lorsque vous attrapez ou rabattez la poignée, veillez à ne pas vous coincer la main entre la poignée et l'instrument.
- Lorsque vous déplacez l'instrument, veillez à ne pas vous coincer la main entre l'instrument et le mur, la surface d'installation ou tout autre objet.

When Cleaning the Instrument

When cleaning the case or the operation panel, turn the instrument and remove the instrument's power cord from the outlet. Then, wipe the instrument lightly with a clean dry cloth. Do not use chemicals such as benzene or thinner. Doing so may cause discoloring and deformation.

3.2 Installing the 2553A

WARNING

- Do not install the instrument outdoors or in locations subject to rain or water.
- Install the instrument so that you can immediately remove the power cord if an abnormal or dangerous condition occurs.

CAUTION

If you block the vent holes on the top and bottom of the instrument, the instrument will become hot and may break down.

French

AVERTISSEMENT

- Ne pas installer l'instrument à l'extérieur ou dans des lieux exposés à la pluie ou à l'eau.
- Installer l'instrument de manière à pouvoir immédiatement le débrancher du secteur en cas de fonctionnement anormal ou dangereux.

ATTENTION

Ne pas bloquer les orifices d'aération en haut et en bas de l'instrument pour éviter la surchauffe et la panne.

Installation Conditions

Install the instrument in a place that meets the following conditions.

Vent holes are located on the top and bottom of the instrument. To prevent internal overheating, allow for enough space around the instrument (see the figure below), and do not block the vent holes.

Do not install the instrument in a location where the air from an air conditioning system blows directly on the output terminals or where the instrument will be affected by heat sources. Such environment can cause errors.

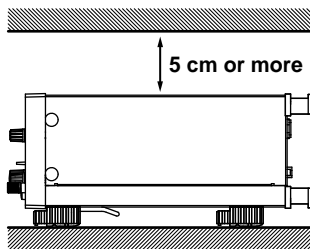

When connecting lead wires or cables, allow for enough space, above and beyond the space shown in the figure above, to carry out the procedure.

Ambient temperature and humidity

Ambient temperature	5°C to 40°C
Ambient humidity	20% RH to 80% RH (no condensation)
	20% RH to 70% RH for ambient temperatures above 30°C

3.2 Installing the 2553A

Note

- Condensation may form when the instrument is moved from a low temperature or humidity environment to a high temperature or humidity environment, or when there is a sudden change in temperature. In such cases, before you use the instrument, allow it to adjust to the surrounding temperature for at least an hour. If you transport the instrument in its packing box, to prevent condensation, allow it to adjust to the new ambient temperature for at least an hour before taking it out of the box.
 - If the instrument has been stored in a hot-temperature, high-humidity environment, warm up the instrument for at least a day before starting use.
-

Installation Orientation

Desktop

Install the instrument on a stable surface that is level in all directions and that is not slippery. The supplied rubber stoppers can be attached to the feet at the rear of the instrument to prevent the instrument from sliding. You can install the instrument in a tilted position using the movable legs.

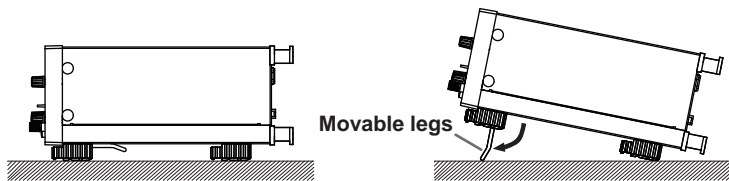

WARNING

- Do not adjust the movable legs in an unstable condition.
 - Do not place the instrument in any position other than those shown in the above figures.
 - Do not stack the instruments with the movable legs pulled out.
 - Only one instrument can be stacked on top of another. Do not stack multiple instruments on top of one instrument.
-

French

AVERTISSEMENT

- Ne pas manipuler les pieds escamotables lorsque l'instrument est instable.
 - Ne pas placer l'instrument dans des positions autres celles indiquées ci-dessus.
 - Ne pas empiler des instruments lorsque les pieds escamotables sont sortis.
 - Seul un instrument peut être empilé sur un autre instrument. Ne pas empiler plusieurs instruments les uns sur les autres.
-

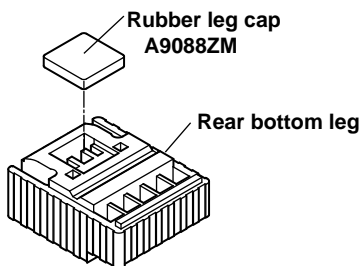

Note

If you attach the front rubber leg cap, you will not be able to stack the 2553A.

Rack Mounting

To mount the instrument on a rack, use a rack mount kit (sold separately).

Item	Model
Model 751533-E3 Rack mount kit (for mounting one 2553A on an EIA standard rack)	751533-E3
Model 751533-J3 Rack mount kit (for mounting one 2553A on a JIS standard rack)	751533-J3
Model 751534-E3 Rack mount kit (for mounting one 2553A on an EIA dual mount rack)	751534-E3
Model 751534-J3 Rack mount kit (for mounting one 2553A on an JIS dual mount rack)	751534-J3

An outline of the mounting procedure is given below. For detailed instructions, see the manual that is included with the rack mount kit.

1. Remove the handles from the sides of the instrument.
2. Remove the four feet from the bottom of the instrument.
3. Remove the four seals covering the rack mount attachment holes. The holes are on the sides of the instrument near the front.
4. Place seals over the feet and handle attachment holes.
5. Attach the rack mount kit to the instrument.
6. Mount the instrument on a rack.

How to remove the handle

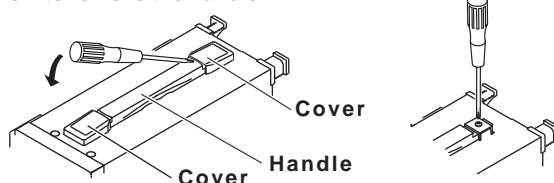

Note

- When rack-mounting the instrument, allow at least 5 cm of space between the top panel and the rack to prevent internal heating.
- Make sure to provide adequate support from the bottom of the instrument. Do not block the vent holes in the process.
- Store the removed parts in a safe place.
- When rack-mounting the instrument, remove the feet from the rear of the instrument if they are coming into contact with the rack and are thus preventing you from rack-mounting the instrument. After you have rack-mounted the instrument, re-attach the feet to the rear of the instrument.
- Dials and output terminals protrude further out than the front panel position. Make sure you do not hit them against the rack when mounting the instrument.

Do Not Install the Instrument in the Following Kinds of Places

- In direct sunlight or near heat sources
- In an environment with excessive amounts of soot, steam, dust, or corrosive gas
- Near strong magnetic field sources
- Near high-voltage equipment or power lines
- In an environment subject to large levels of mechanical vibration
- On an unstable surface
- Outdoors or in locations subject to rain or water
- Where the air from an air conditioning system blows directly on the instrument or where the instrument will be affected by heat sources

3.3 Connecting to the Power Supply

Before Connecting the Power Supply

Make sure to follow the warnings below when connecting the power supply. Failure to do so may cause electric shock or damage to the instrument.



WARNING

- Before connecting the power cord, ensure that the source voltage matches the rated supply voltage of the 2553A and that it is within the maximum rated voltage of the provided power cord.
- Connect the power cord after checking that the power switch of the instrument is turned off.
- To prevent electric shock or fire, be sure to use the power cord for the instrument that is supplied by YOKOGAWA.
- Make sure to connect protective earth grounding to prevent electric shock. Connect the power cord to a three-prong power outlet with a protective earth terminal.
- Do not use an ungrounded extension cord. If you do, the instrument will not be grounded.
- If an AC outlet that conforms to the supplied power cord is unavailable and you cannot ground the instrument, do not use the instrument.

French



AVERTISSEMENT

- Avant de brancher le cordon d'alimentation, vérifier que la tension source correspond à la tension d'alimentation nominale du 2553A et qu'elle est compatible avec la tension nominale maximale du cordon d'alimentation.
 - Brancher le cordon d'alimentation après avoir vérifié que l'interrupteur d'alimentation de l'instrument est sur OFF.
 - Pour éviter tout risque de choc électrique ou d'incendie, utiliser exclusivement le cordon d'alimentation fourni par YOKOGAWA et prévu pour l'instrument.
 - Relier l'instrument à la terre pour éviter tout risque de choc électrique. Brancher le cordon d'alimentation sur une prise de courant à trois plots reliée à la terre.
 - Toujours utiliser une rallonge avec broche de mise à la terre, à défaut de quoi l'instrument ne serait pas relié à la terre.
 - En l'absence de prise secteur conforme au cordon d'alimentation et dans l'impossibilité de mettre l'instrument à la terre, ne pas utiliser l'instrument.
-

Connecting the Power Cord

1. Check that the power switch (POWER) on the front panel of the instrument is turned off.
2. Connect the power cord plug to the power inlet on the rear panel.
3. Connect the other end of the cord to an outlet that meets the following conditions. Use a grounded three-prong outlet.

Item	Specifications
Rated supply voltage*	100 VAC to 120 VAC, 200 VAC to 240 VAC
Permitted supply voltage range	90 VAC to 132 VAC, 180 VAC to 264 VAC
Rated supply frequency	50Hz/60Hz
Permitted supply frequency range	48 Hz to 63 Hz
Maximum power consumption	Approx. 30 VA

* This instrument can use a 100 V or a 200 V power supply. The maximum rated voltage differs according to the type of power cord. Check that the voltage supplied to the instrument is less than or equal to the maximum rated voltage of the power cord provided with the instrument before using it (see page ii for the maximum rated voltage).

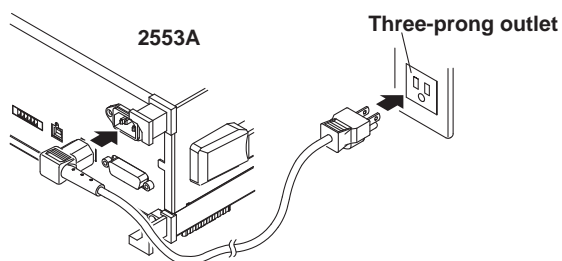

3.4 Turning On and Off the Power Switch

Before Turning On the Power, Check That:

- The instrument is installed properly. → section 3.2, “Installing the 2553A”
- The power cord is connected properly → section 3.3, “Connecting the Power Supply”

Power Switch Location

The power switch is located in the lower left of the front panel.

Turning On and Off the Power Switch

The power switch is a push button. Press the button once to turn the instrument on and press it again to turn the instrument off.

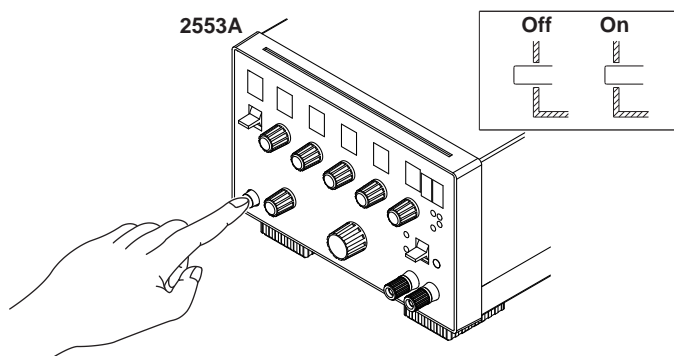

Operations Performed When the Power Is Turned On

When the power switch is turned on, a self-test starts automatically. When the self-test completes successfully, the instrument will be configured with the settings that were in use immediately before the power was turned off. For the settings that are retained even when the power is turned off, see appendix 5.

Check that the instrument has started normally before you use it.

If the 2553A Does Not Start Normally When the Power Is Turned On

Turn off the power switch, and check the following items.

- The power cord is securely connected.
- The correct voltage is coming to the power outlet. → section 3.3, “Connecting to the Power Supply”
- Initialize the 2553A settings → section 13.8, “Initializing the Settings.”

If the 2553A still does not work properly after checking these items, contact your nearest YOKOGAWA dealer for repairs. If an error code is displayed, check the information in section 13.3, and take the appropriate actions.

Note

After turning the power switch off, wait at least 10 seconds before you turn it on again.

To Generate Accurate Output

- Allow the instrument to warm up for at least 30 minutes after turning on the power switch. If the instrument has been stored in a hot-temperature, high-humidity environment, warm up the instrument for at least a day before starting use.
- We recommend that the power be left on at all times.

Operations Performed When the Power Is Turned Off

After the power is turned off, the instrument stores the setup parameters in its memory before shutting down. The same is true when the power cord is disconnected from the outlet. The next time the power is turned on, the instrument powers up using the stored settings (for the settings that are stored, see appendix 5).

3.5 Wiring Precautions



WARNING

- Ground the instrument before connecting the instrument to the target device. The power cord that comes with the instrument is a three-prong type power cord. Insert the power cord into a grounded three-prong outlet.
 - Be sure to turn off the output before connecting or disconnecting the target device.
 - To prevent damage that would occur if the OUTPUT switch is flipped inadvertently during wiring, check that the output setting dials are all set to 0 (zero).
 - Make sure to fasten the output terminal screws securely so that lead wires do not come loose.
 - Do not use lead wires whose conductive parts are exposed due to tears in the insulation or broken cables as they may lead to a short circuit or electric shock.
 - If a large inductive or capacitive load or oscillating circuit is connected to the output terminals, the output may oscillate and cause high voltage to be applied to the output terminals. If the output oscillates, turn off the OUTPUT switch immediately.
-



CAUTION

- Use lead wires that have adequate margins of withstand voltage and current capacity with respect to the voltage or current to be sourced.
 - Use twisted-pair lead wires to prevent oscillation.
 - When using the 10 mV range or any of the thermocouple ranges, do not apply external voltage or current. Doing so may damage the voltage divider inside the 2553A.
-

French

**AVERTISSEMENT**

- Relier l'instrument à la terre avant de le brancher sur l'appareil cible. Le cordon d'alimentation livré avec l'instrument est doté de trois broches. Brancher le cordon d'alimentation sur une prise de courant à trois plots mise à la terre.
- Toujours mettre hors tension avant de brancher ou de débrancher l'appareil cible.
- Pour éviter tout endommagement si le commutateur de SORTIE (OUTPUT) était accidentellement actionné une fois le branchement effectué, vérifier que les paramètres de réglage de la sortie sont tous sur 0 (zéro).
- Serrer suffisamment les vis des bornes de sortie pour éviter que les câbles ne se détachent.
- Pour éviter tout risque de court-circuit ou de choc électrique, ne pas utiliser des câbles endommagés ou dont les fils intérieurs sont visibles.
- En cas de branchement d'une importante charge inductive ou capacitive, ou de circuit oscillant sur les bornes de sortie, la sortie peut osciller et entraîner l'alimentation d'une tension élevée sur les bornes de sortie. En cas d'oscillation de la sortie, mettre le commutateur de SORTIE (OUTPUT) immédiatement hors tension.

**ATTENTION**

- Utiliser des câbles qui ont suffisamment de marge de tension de maintien ou de capacité de courant par rapport à la tension ou au courant à émettre.
- Utiliser une paire torsadée de câbles pour éviter l'oscillation.
- Avec une gamme de mesure de 10 mV ou toute autre valeur de gammes de thermocouples, ne pas alimenter en tension externe, ni courant. Cela pourrait endommager le diviseur de tension à l'intérieur du 2553A.

3.6 Connecting Wires



CAUTION

- Confirm that no foreign materials are caught in the contact area between the output terminals and the lead wires.
- Periodically confirm that the output terminals are not loose and that there are no foreign materials caught in the contact area between the current terminals and the lead wires.
- Attaching the terminal plug upside down to the external RJ sensor input terminal of the 2553A may damage the terminal plug or the external RJ sensor input terminal. Check the orientation before attaching the plug.

French



ATTENTION

- Vérifier l'absence de corps étrangers dans la zone de contact entre les bornes de sortie et les câbles.
- Vérifier régulièrement que les bornes de sortie sont bien serrées et qu'il n'y a aucun corps étrangers dans la zone de contact entre les bornes de courant et les câbles.
- Le branchement à l'envers de la fiche de raccordement sur la borne d'entrée du capteur RJ externe du 2553A peut endommager la fiche de raccordement ou la borne d'entrée du capteur RJ externe. Vérifier l'orientation de la fiche avant de la brancher.

Wire the lead wires from the target device to the output terminals of the 2553A. The output terminals are binding posts with 4 mm banana jacks (female). Wire them in the following manner. To prevent electric shock and damage to the instrument, follow the warnings given in section 3.5, "Wiring Precautions."

Wiring a Voltmeter or Ammeter to the Output Terminals

Wire a voltmeter or ammeter to the output terminals using method a or b explained below.

- The fastening screws are M6. Either wind the conductive part of the lead wire around the output terminal screw or pinch the screw section with the crimping terminal, and then tighten the terminal knob firmly with your hand. The terminal or knob may break if you apply excessive torque.
- Insert the measurement leads with banana plugs into the output terminals.

Wiring Example

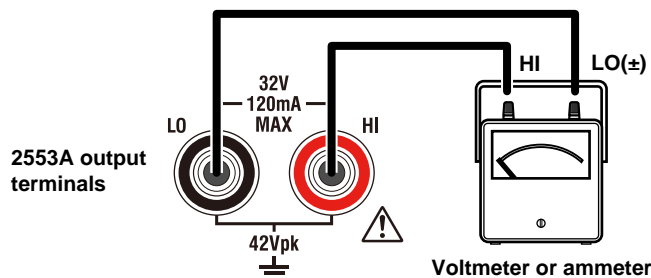

Note

- Current sinking (absorption) is possible in any of the voltage or current ranges. For example, by absorbing the current from a voltage source such as a distributor, the 2553A can simulate a load, like a two-wire transmitter. For the maximum sink current, see “DC Voltage Sourcing” or “DC Current Sourcing” in section 2.1. Immediately after sinking current that exceeds 30 mA, errors exceeding the accuracy specifications may occur due to the increased temperature inside the 2553A.

In the following example, the value is set to 20 mA and the polarity to negative.

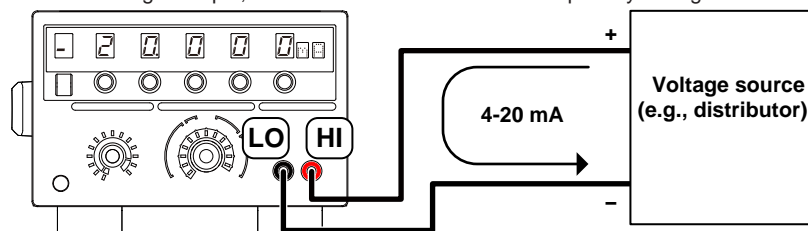

- When using a small output range, such as 10 mV or 100 mV, wind the copper wires directly to the output terminals. If the output terminal temperature changes as a result of making contact with the lead wires, crimping terminals, banana plugs, or other conductors during wiring or due to ambient air movement, errors exceeding the accuracy specifications may occur when a small output range is used. In such situations, wait until the output stabilizes.

Wiring a Thermograph to the Output Terminals

The fastening screws are M6. Wind the thermocouple wire or the RTD lead wire around the output terminal screw, and then tighten the terminal knob firmly with your hand. The terminal or knob may break if you apply excessive torque. For wiring examples, see also appendixes 2 and 3.

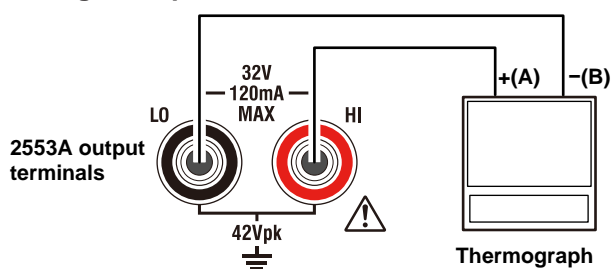
Wiring Example**Note**

If the output terminal temperature changes as a result of making contact when wiring thermocouples, compensating lead wires, and the like; making contact when connecting external RJ sensors; and due to ambient air movement, errors exceeding the accuracy specifications may occur. In such situations, wait until the output stabilizes.

Wiring to the External RJ Sensor Input Terminal

To wire an external reference junction (RJ) sensor to the external RJ sensor input terminal on the rear panel of the 2553A, follow the procedure below.

Wiring an RJ Sensor to the Terminal Plug

- Loosen the screws on the top of the terminal plug (these screws are used to fix lead wires in place), and insert stripped lead wires into the lead wire connection terminals. Insert white lead wires into the white positions of the terminal plug and red lead wires into the red positions.

- Length of stripped wire: 7 mm
- Conductive cross-sectional area

Single wire:	0.14 mm ² to 1.5 mm ²
Twisted wire:	0.14 mm ² to 1.5 mm ²
AWG:	28 to 16

- Tighten the screws to fix the lead wires in place.
Screw tightening torque: 0.22 N•m to 0.25 N•m

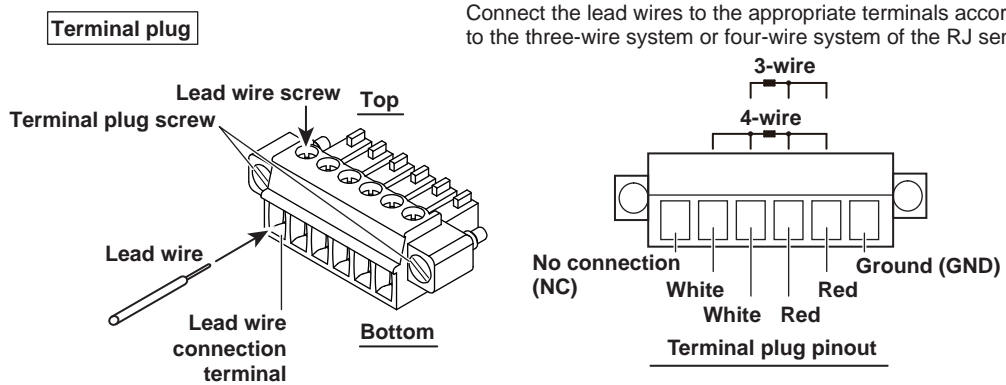

Attaching the Terminal Plug to the External RJ Sensor Input Terminal

- Attach the terminal plug with the RJ sensor to the external RJ sensor input terminal of the 2553A.
The terminal plug cannot be attached upside down. Attach the terminal plug in the proper orientation.
- Tighten the screws on the left and right of the terminal plug to secure the terminal plug to the 2553A.
Screw tightening torque: 0.2 N•m to 0.3 N•m

4.1 SETUP Menu Tree Structure

The SETUP menu appears when you turn the RANGE dial and select SETUP. The available menu items are illustrated in the following tree diagram.

An overview of how to use the SETUP menu is provided in section 4.2. For details of how to operate each menu, see the referenced section in the tree diagram.

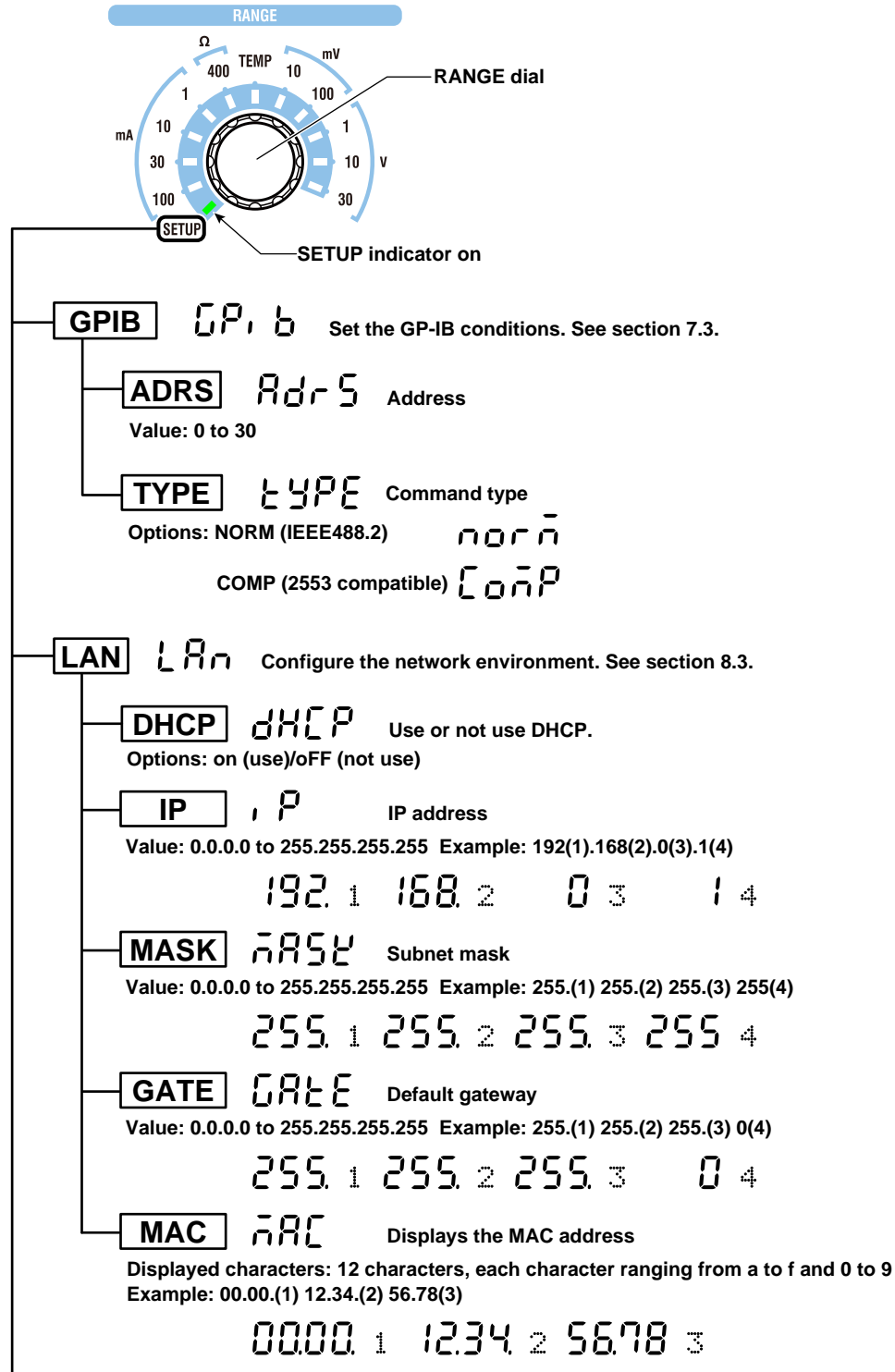

To USB on the next page

4.1 SETUP Menu Tree Structure

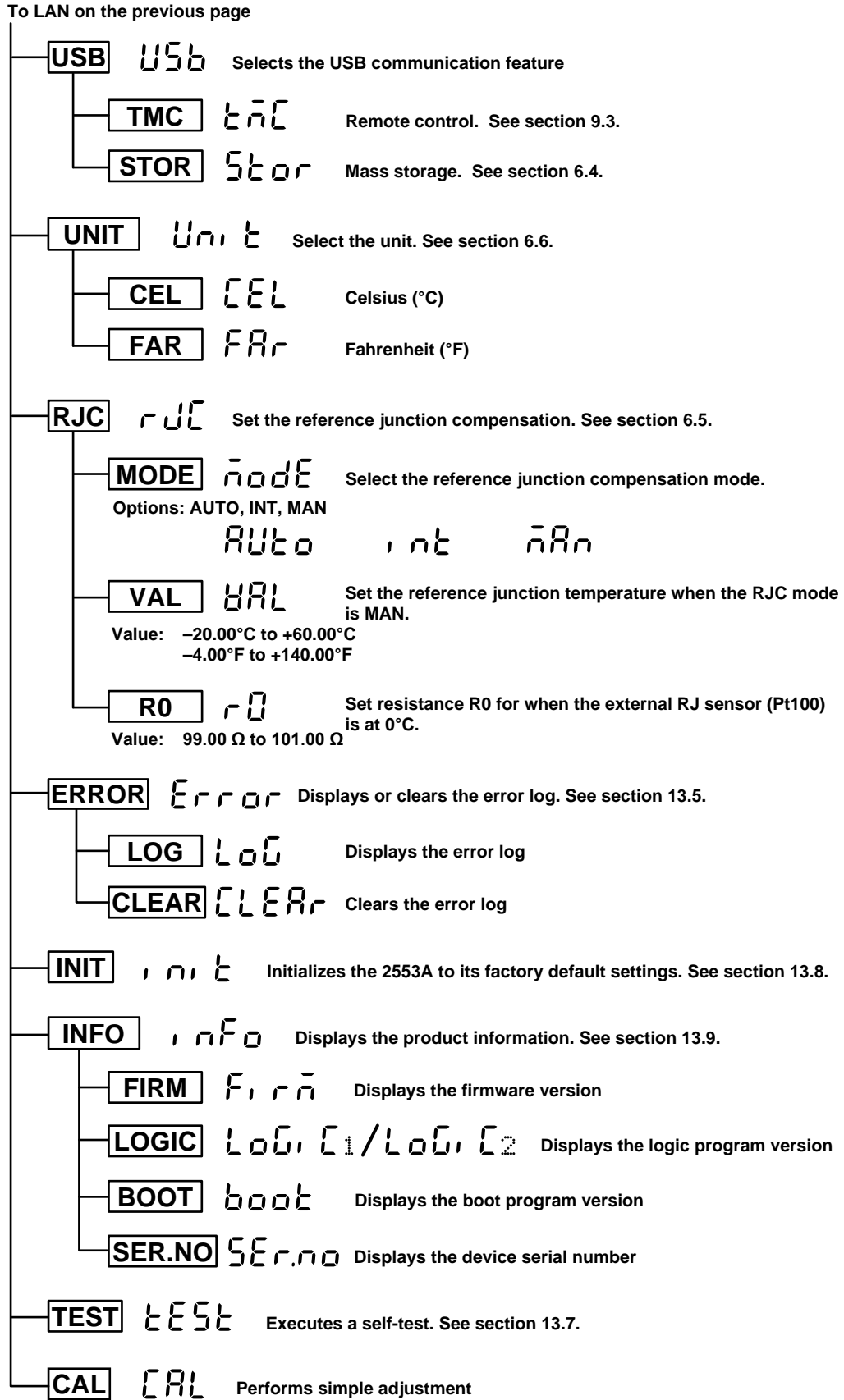

For the simple adjustment procedure, see the following webpage.
<http://tmi.yokogawa.com/products/generators-sources/standard/precision-dc-calibrator-2553a/>

4.2 Using the SETUP Menu

This section provides an overview of how to use the SETUP menu. For detailed explanations of how to configure individual functions with the SETUP menu, see the relevant sections.

When the SETUP menu is displayed, only the dials and switches for setting and displaying the menu items can be used. (Other dials and switches are disabled.) Also, displays that are not used in the SETUP menu do not turn on.

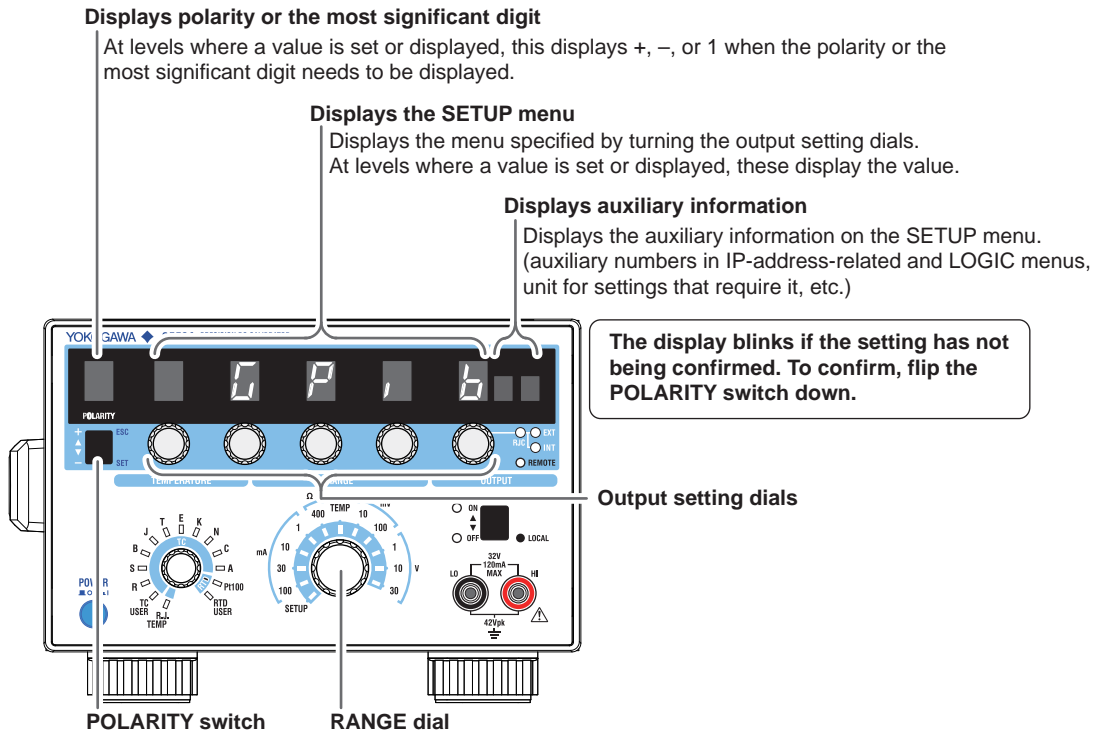

RANGE Dial

First, to enter the SETUP menu, use this dial to select **SETUP**.

Output Setting Dials

You can use any of the output setting dials to set the menu items. However, these dials operate separately in the following situations.

- When a value is being set, each dial sets the value of the digit immediately above it. Carrying over and borrowing occur automatically within the selectable range.
- At the menu level for switching the auxiliary information display, the right-most output setting dial is used to switch the display.

POLARITY Switch

Use this switch to confirm the setting that you have changed or cancel the change and return to the previous menu level.

- Flipping the OUTPUT switch down confirms the displayed setting.
 - If there is a next menu level, the menu proceeds to that level.
 - If there are values or information to be displayed, those are displayed.
 - If you perform this operation on an execution menu, you cannot undo it.
- Flipping the OUTPUT switch up returns the menu to the previous level. If you perform this operation when the display is blinking, the displayed setting will not be confirmed. The setting returns to the original value.

Note

If you clear the error log, initialize the settings, and so forth, you cannot undo it. Confirm that it is okay to perform such operation before execution.

5.1 Selecting the Voltage, Current, or Resistance Range

CAUTION

When using the 10 mV range, do not apply external voltage or current. Doing so may damage the voltage divider inside the 2553A.

French

ATTENTION

Avec une gamme de mesure de 10 mV, ne pas alimenter en tension externe, ni courant. Cela pourrait endommager le diviseur de tension à l'intérieur du 2553A.

Procedure

Turn the **RANGE** dial to set the voltage, current, or resistance range.

- The indicator for the selected range illuminates.
- The unit corresponding to the selected range appears.

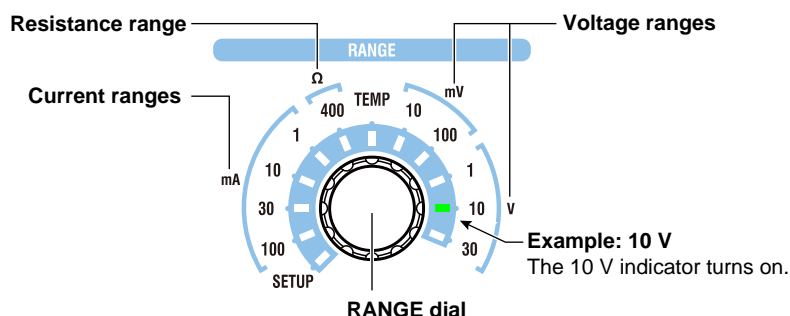

Explanation

Source ranges are shown below. Set the value that you want to output (output setting) within the selected range. For information on how to set the output setting, see section 5.2.

If you change the range when the output is on, the output turns off.

Voltage Ranges

Select from the following.

10 mV, 100 mV, 1 V, 10 V, 30 V

Current Ranges

Select from the following.

1 mA, 10 mA, 30 mA, 100 mA

Resistance Range

400 Ω.

Note

The 2553A does not have an auto range feature that automatically switches the range according to the output setting.

<<Command Mnemonic>>

```
:SOURCE:FUNCTION {VOLTage|CURRent|RESistance}
```

```
:SOURCE:RANGE {<Voltage>|<Current>|<Resistance>}
```

5.2 Specifying the Output Setting and Polarity

Procedure

Specifying the Output Setting

Turn the **output setting** dials to set the source voltage, current, or resistance.
The display shows the specified voltage, current, or resistance.

Setting the Polarity

Flip the **POLARITY** switch up or down to set the polarity.

Example of setting 1.5000 V

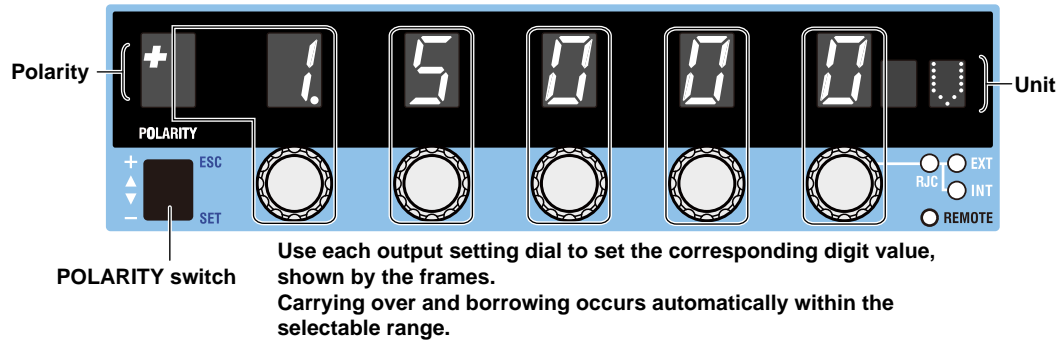

Explanation

Selectable Range

The selectable range and resolution of each range are as follows. For detailed specifications, see section 14.1.

As long as you remain in the same range, you can change the output setting and polarity even while the output is on.

Voltage Ranges

Range	Source Range	Resolution
10 mV	±12.0000 mV	100 nV
100 mV	±120.000 mV	1 μV
1 V	±1.20000 V	10 μV
10 V	±12.0000 V	100 μV
30 V	± 32.000 V	1 mV

Current Ranges

Range	Source Range	Resolution
1 mA	±1.20000 mA	10 nA
10 mA	±12.0000 mA	100 nA
30 mA	± 32.000 mA	1 μA
100 mA	±120.000 mA	1 μA

Resistance Ranges

Range	Selectable Range	Resolution
400 Ω	18.00 Ω to 400.00 Ω	0.01 Ω

Output Setting Display

- The output setting appears flush right at the resolution of each range.
- The ratio of the output setting to the range is passed on to the output setting even when you change the range.

Example: If the output setting is 1.5000 V (15%) at the 10 V range and you change the voltage range to 30 V, the output setting will be 4.500 V.

10 V Range

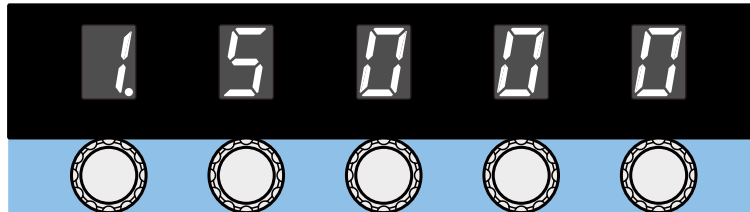

30 V Range

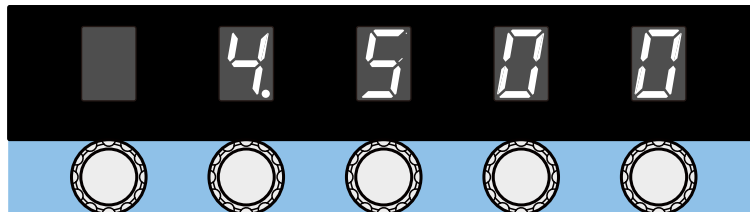

- When you change the range and the specified output setting is outside the selectable range of the new range, the output setting and polarity displays blink. If you turn any of the output setting dials in this condition but the output setting still remains outside the selectable range of the new range, the output setting is set to the maximum or minimum setting of the new range, and the blinking will change to solid.

<<Command Mnemonic>>

```
:OUTPut:POLarity {NORMAL|INVERTed}
:SOURce:FUNction {VOLTage|CURRENT|RESistance}
:SOURce:LEVel {<Voltage>|<Current>|<Resistance>|MINimum|MAXimum}
:SOURce:SLEVel {<Voltage>|<Current>|<Resistance>|MINimum|MAXimum}
```

5.3 Turning the Output On and Off

Procedure

Flip the **OUTPUT** switch up.

- The output turns on. The OFF indicator turns off, and the ON indicator turns on.
- Flipping the OUTPUT switch down while the output is on will turn off the output. The ON indicator will turn off, and the OFF indicator will turn on.

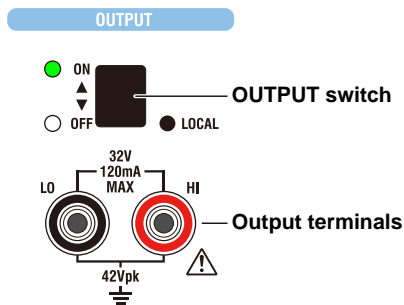

Note

- When outputting current, do not open the output terminals. When outputting voltage, do not short the output terminals. In either case, the overload protection function will be activated, an error code will be displayed, and the output will be turned off. The time it takes for the error to appear depends on the range and output value.
- If the output terminal temperature changes as a result of making contact with the lead wires, crimping terminals, banana plugs, or other conductors during wiring or due to ambient air movement, errors exceeding the accuracy specifications may occur when a small output range is used. In such situations, wait until the output stabilizes. Also while the 2553A is generating output, keep the output terminal temperature from changing due to the effects air conditioning, other heat sources, and the like.

Explanation

Turning the Output On and Off

When the output is turned on, the 2553A will source the specified voltage, current, or resistance from the output terminals.

- If you change the range setting, the output automatically turns off.
- If the output setting is outside the selectable range, the output cannot be turned on.

Indicator and Output States

Output State	ON Indicator (Green)	OFF Indicator (Red)
ON	On	Off
OFF	Off	On

<<Command Mnemonic>>

:OUTPut[:STATe] <Boolean>

6.1 Selecting Thermocouples and RTDs

CAUTION

When using thermocouple ranges, do not apply external voltage or current. Doing so may damage the voltage divider inside the 2553A.

French

ATTENTION

Avec des gammes de thermocouples, ne pas alimenter en tension externe, ni courant. Cela pourrait endommager le diviseur de tension à l'intérieur du 2553A.

Procedure

1. Turn the **RANGE** dial to select TEMP.
The TEMP indicator illuminates, and the TEMPERATURE dial is enabled.
2. Turn the **TEMPERATURE** dial to select a thermocouple (R, S, B, J, T, E, K, N, C, A, TC USER) or RTC (Pt100, RTD USER) type.
 - The indicator for the selected type turns on.
 - The displayed unit will be °C.

2. Select the thermocouple or RTD type.

The indicator for the selected type turns on.

1. Select TEMP.

The TEMP indicator turns on.

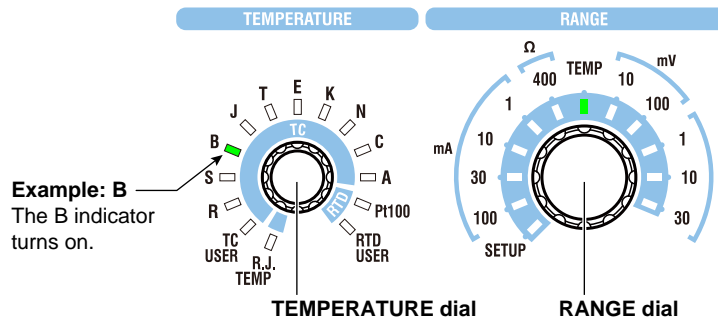

Explanation

The available thermocouple and RTD types are shown below. If you change the type when the output is on, the output turns off.

Thermocouple

Select from the following.

R, S, B, J, T, E, K, N, C, A, TC USER*

- * If you select TC USER, the thermoelectromotive force of a user-defined thermocouple can be sourced. For details how to write user-defined data to the 2553A, see section 6.4. For the data definition specifications, see appendix 4.

RTD

Select from the following.

Pt100, RTD USER*

- * If you select RTD USER, the resistance of a user-defined RTD can be sourced. For details how to write user-defined data to the 2553A, see section 6.4. For the data definition specifications, see appendix 4.

<<Command Mnemonic>>

:SOURCE:FUNCTION {TCouple|RTD}

:SOURCE:TYPE {R|S|B|J|T|E|K|N|C|A|PT100|USER}

6.2 Setting the Temperature

Procedure

Setting the Temperature

Turn the **output setting** dial to set the temperature.
The display shows the specified temperature.

Setting the Polarity

Flip the **POLARITY** switch up or down to set the polarity.

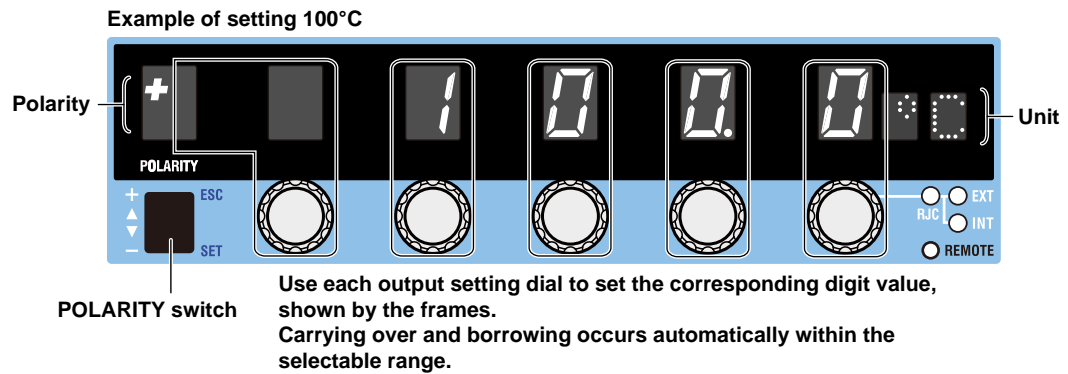

Explanation

Selectable Range

The selectable range and resolution of each thermocouple and RTD are as shown below. For detailed specifications, see section 14.1.

You can change the output setting and polarity even while the output is on. However, if the output setting goes outside the selectable range when you change the polarity, the output turns off, and the output setting and polarity displays blink.

Thermocouple

Type	Source Range	Resolution
R	-50°C to +1768°C	0.1°C
S	-50°C to +1768°C	0.1°C
B	0°C to +1820°C	0.1°C
J	-210°C to +1200°C	0.1°C
T	-270°C to +400°C	0.1°C
E	-270°C to +1000°C	0.1°C
K	-270°C to +1300°C	0.1°C
N	-270°C to +1300°C	0.1°C
C	0°C to +2315°C	0.1°C
A	0°C to +2500°C	0.1°C
TC USER	-9999.9°C to +9999.9°C	0.1°C

* If you select TC USER, the thermoelectromotive force corresponding to the user-defined temperature can be sourced. For a detailed procedure, see section 6.4. For details on definition expressions, see appendix 4.

RTD

Type	Source Range	Resolution
Pt100	-200.0°C to +850.0°C	0.1°C
RTD USER	-9999.9°C to +9999.9°C	0.1°C

* If you select RTD USER, the resistance corresponding to the user-defined temperature can be sourced. For a detailed procedure, see section 6.4. For details on definition expressions, see appendix 4.

Output Setting Display

- The output setting appears flush right at the resolution of each thermocouple or RTD.
- When you change the type or polarity and the specified output setting is outside the selectable range of the new type, the output setting and polarity displays blink. If you turn any of the output setting dials in this condition but the output setting still remains outside the selectable range of the new type, the output setting is set to the maximum or minimum setting of the new type, and the blinking will change to solid.

<<Command Mnemonic>>

```
:OUTPut:POLarity {NORMal|INVerted}  
:SOURce:FUNCTion {TCouple|RTD}  
:SOURce:LEVel {<Temperature>|MINimum|MAXimum}  
:SOURce:SLEVel {<Temperature>|MINimum|MAXimum}
```

6.3 Turning the Output On and Off

Procedure

Flip the **OUTPUT** switch up.

- The output turns on. The OFF indicator turns off, and the ON indicator turns on.
- Flipping the OUTPUT switch down while the output is on will turn off the output. The ON indicator will turn off, and the OFF indicator will turn on.

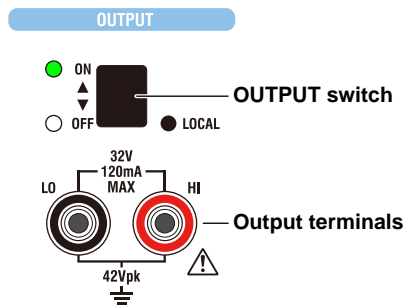

Note

- When outputting temperature, do not short the output terminals.
- If the output terminal temperature changes as a result of making contact when wiring thermocouples, compensating lead wires, and the like; making contact when connecting external RJ sensors; and due to ambient air movement, errors exceeding the accuracy specifications may occur. In such situations, wait until the output stabilizes. Also while the 2553A is generating output, keep the output terminal temperature from changing due to the effects air conditioning, other heat sources, and the like.

Explanation

Turning the Output On and Off

When the output is turned on, the 2553A will source the thermoelectromotive force or resistance corresponding to the specified temperature from the output terminals.

- If you change the type, the output automatically turns off.
- If the output setting is outside the selectable range, the output cannot be turned on.

Indicator and Output States

Output State	ON Indicator (Green)	OFF Indicator (Red)
ON	On	Off
OFF	Off	On

<<Command Mnemonic>>

```
:OUTPut[ :STATE] <Boolean>
```

6.4 Writing User-Defined Data

CAUTION

The USB mass storage feature is used to write user-defined data to the 2553A. To prevent the 2553A from a computer virus infection, before connecting a PC to the 2553A, check that the PC is not infected by a computer virus. Connecting a 2553A that has been infected with a computer virus may infect other devices when they are connected to the 2553A. If you find out that the PC connected to the 2553A is infected with a computer virus, turn off the 2553A. Computer viruses in the 2553A will be erased.

French

ATTENTION

Le dispositif de mémoire de masse USB permet l'écriture dans 2553A de données définies par l'utilisateur. Pour protéger le 2553A contre les virus informatiques, avant de brancher un PC sur le 2553A, vérifier que le PC est exempt de virus. Le branchement du 2553A infecté par un virus informatique aura pour effet d'infecter les autres appareils branchés sur le 2553A. S'il apparaît que le PC branché sur le 2553A est infecté par un virus informatique, mettre le 2553A hors tension. Les virus informatiques contenus dans le 2553A seront supprimés.

Procedure

Start the 2553A and the PC. Check that they have started normally. For details on how to turn the 2553A power switch on and the operations performed when the power is turned on, see section 3.4.

Setting the 2553A's USB Communication Feature to Mass Storage

1. Turn the **RANGE** dial to select SETUP.
The SETUP menu appears.

1. **Select SETUP.**
The SETUP indicator turns on.

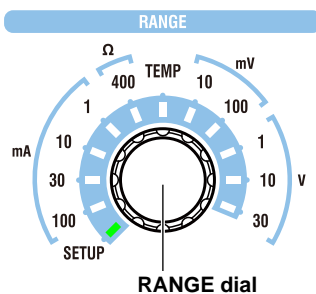

Selecting the USB Interface

2. Turn an **output setting** dial to select USB.
3. Flip the **POLARITY** switch down.
The USB menu appears.

Selecting the Mass Storage Feature

4. Turn an **output setting** dial to select STOR.
5. Flip the **POLARITY** switch down.
The USB feature is confirmed.

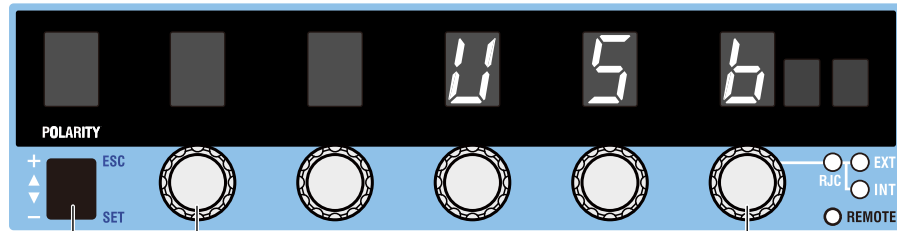

POLARITY switch
3. Display the USB menu.
5. Confirm the USB feature.

Output setting dials (use any)
2. Select USB.
4. Select STOR.

Connecting the 2553A to the PC through USB

6. Using a USB cable, connect the USB port (type B) on the rear panel of the 2553A to the PC.
See the USB interface specifications in section 9.1 and the connection diagram in section 9.2.

Operations on the PC

Opening the Computer Folder

7. Open the **Computer** folder from the Windows **Start** menu.

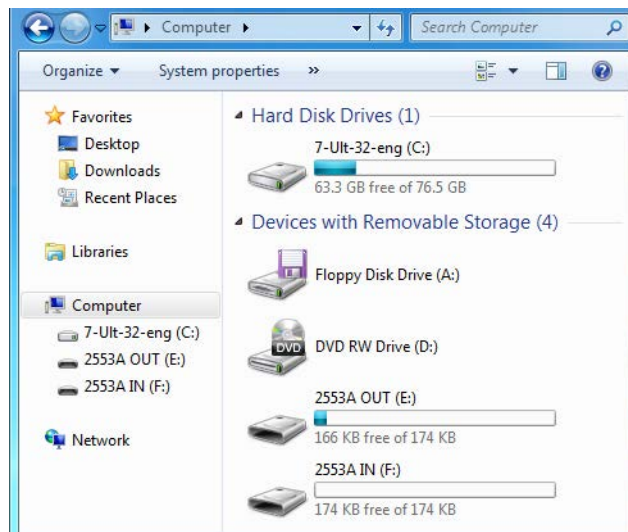

Writing User-Defined Data

8. Double-click the **2553A IN** drive in the computer folder.
The 2553A IN folder opens.
9. Place the user-defined data file (TCUSER.TXT or RTDUSER.TXT) that you created in the 2553A IN folder.
 - For the user-defined data definition specifications, see appendix 4.
 - The user-defined data file name is fixed. When placing the file in the 2553A IN folder, an error will not occur even if a different file name is used. However, make sure to rename the file to TCUSER.TXT or RTDUSER.TXT before performing step 10 on the next page.

Example in Which a Thermocouple User-Defined Data File (TCUSER) Is Placed in the 2553A IN Folder

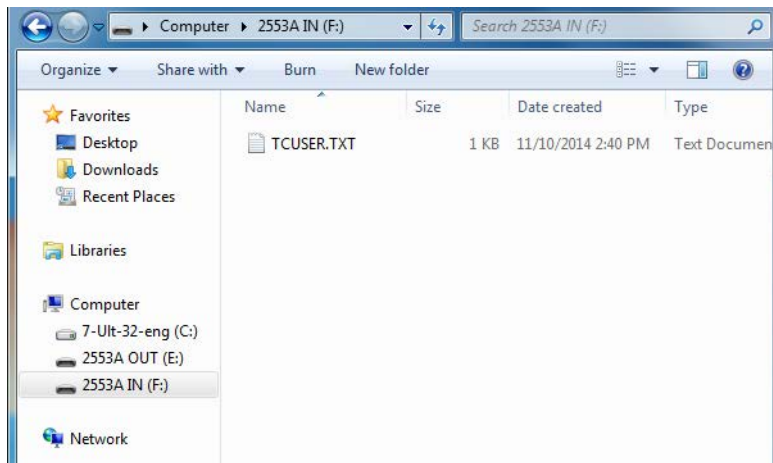

10. Right-click **2553A IN** in the navigation window. On the shortcut menu, click **Eject**.
 - The 2553A IN and 2553A OUT drives are ejected from the computer folder. The user-defined data in the file in the 2553A IN folder is written to the 2553A's internal memory, and then the 2553A IN and 2553A OUT drives appear again in the computer folder.
 - The file in the 2553A IN folder will be deleted.
 - The contents written in the 2553A's internal memory are saved to TCUSER.TXT or RTDUSER.TXT in the 2553A OUT folder.

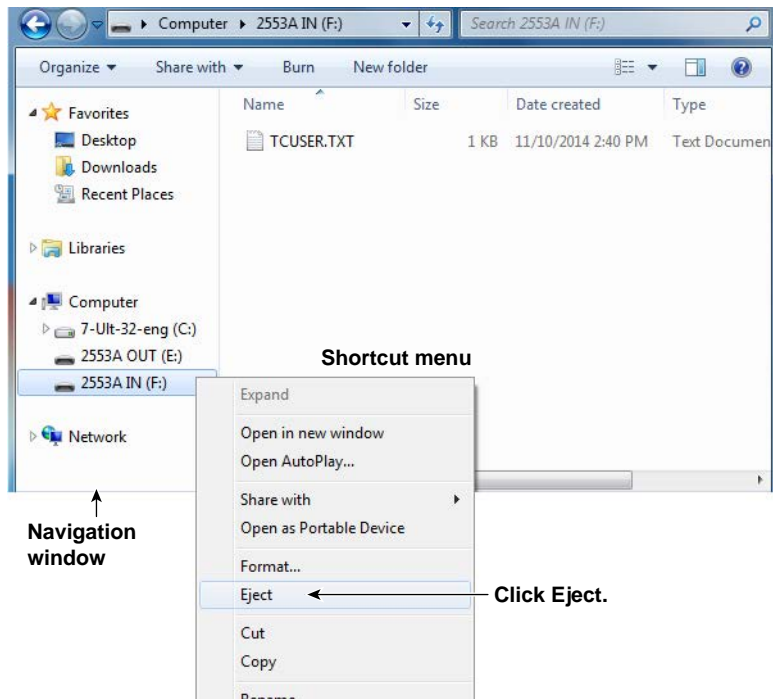

If User-Defined Data Contains Errors

In step 10, the 2553A checks for errors in the data. If an error is found, the 7-segment LED will display an error code, and the contents in the internal memory of the 2553A will not be updated.

Explanation

This section explains how to write user-defined data. After writing user-defined data to the 2553A, you can use the TEMPERATURE dial to set the source type to TC USER or RTD USER and source the user-defined thermocouple thermoelectromotive force or RTD resistance. For the procedure to select the source type, see section 6.1. For the data definition specifications, see appendix 4.

Mass Storage Feature

To exchange user-defined data files between the 2553A and PC, the 2553A's USB communication feature must be set to mass storage.

To remotely control the 2553A with communication commands, the USB communication feature must be set to remote control protocol (TMC). For the procedure, see section 9.3.

Connecting the 2553A to the PC through USB

The USB port on the rear panel of the 2553A is type B. The USB port on the PC is type A. Connect the 2553A to the PC using a USB cable with a type B connector on one end and type A connector on the other.

Note

- You can connect the USB cable before or after the 2553A and PC have started. Do not connect the cable while they are in the middle of the startup procedure.
- Do not connect or remove the USB cable while user-defined data is being written. Doing so may prevent the data from being written correctly. It may also cause the 2553A or PC to run abnormally.

2553A IN and 2553A OUT Folders

If the 2553A and PC are running normally and the 2553A's USB communication feature is set to mass storage, when you connect them with a USB cable, 2553A IN and 2553A OUT drives appear in the computer folder of the PC.

- When the USB cable is connected, the PC's autoplay feature may be activated for the 2553A IN and 2553A OUT drives. If this happens, you can also open the folders by clicking Open folder to view files in the autoplay window.
- The 2553A IN folder is a read/write folder. This is where you place user-defined data files to be written to the 2553A.
- The 2553A OUT folder is a read-only folder. This is where the contents of the user-defined data written in the 2553A's internal memory are saved in a file.

Writing User-Defined Data

The ejection of the 2553A IN drive causes the user-defined data to be written to the 2553A's internal memory. If written data already exists, it will be updated.

- When the data is written, the file in the 2553A IN folder is deleted.
- When the data is written, the data written in the 2553A's internal memory is saved as a file in the 2553A OUT folder. The file data is updated.
- Since the 2553A OUT folder is read-only, you can use a text editor to view the file in the folder, but you cannot save or delete the file.
- You can delete the data written in the 2553A's internal memory by using a communication command. For details on user-definition commands, see "SOURce Group" in chapter 11.

6.4 Writing User-Defined Data

Definition file

The names of the user-defined data files saved in the 2553A IN and 2553A OUT folders are fixed. The name is not case sensitive.

- Thermocouple user-defined data file name: TCUSER.TXT
- RTD user-defined data file name: RTDUSER.TXT

If User-Defined Data Contains Errors

If there is an error in the user-defined data, an error will occur. If an error occurs, the contents in the internal memory of the 2553A will not be updated.

Error File

When an error occurs, the information is saved in a file in the 2553A OUT folder.

- TC USER error file name: ERRORTCUSER.TXT
- RTD USER error file name: ERRORRTDUSER.TXT

For details on errors, see “Definition Specifications” or “User-Definition Error Messages” in appendix 4. If the user-defined data is correct and the contents in the internal memory of the 2553A is updated, the error file is deleted.

When User-Defined Data Is Not Written in Internal Memory

In the factory default condition or when user-defined data is deleted with a communication command, the 2553A will not have data written in its internal memory. If you select to source a user-defined thermoelectromotive force or resistance, the 2553A will respond in the following manner.

Output setting	Blinking bars (----) will appear.
Polarity	Will turn off.
RJC indicators	Solid indicators will change to blinking.
Output (OUTPUT)	The output cannot be turned on.
Output setting query using a communication command	9.91E+37 will be returned.

<<Command Mnemonic>>

• Thermocouple

```
:SOURCE:TCouple:DEFine <String>
:SOURCE:TCouple:DELeTe
:SOURCE:TCouple:SETTing?
:SOURCE:TCouple:TYPE <String>
:SOURCE:TCouple:WRITe
```

• RTD

```
:SOURCE:RTD:DEFine <String>
:SOURCE:RTD:DELeTe
:SOURCE:RTD:SETTing?
:SOURCE:RTD:TYPE <String>
:SOURCE:RTD:WRITe
```

6.5 Setting Reference Junction Compensation

Procedure

- Turn the **RANGE** dial to select TEMP.
The TEMP indicator illuminates, and the TEMPERATURE dial is enabled.
- Turn the **TEMPERATURE** dial to select R.J. TEMP.
 - The R.J. TEMP indicator turns on.
 - The displayed unit will be °C.

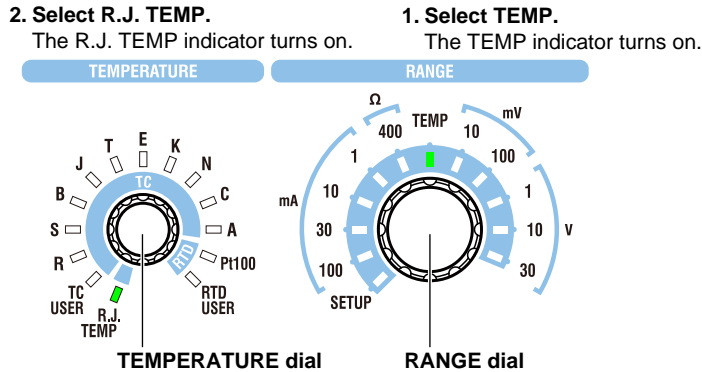

Setting the Reference Junction Compensation Mode

- Turn the right-most **output setting** dial to set the reference junction compensation (RJC) mode to auto, internal, or manual input.
 - The display shows the selected reference junction temperature.
 - You can also select the reference junction compensation mode from the SETUP menu. For the SETUP menu tree structure and operating procedure, see chapter 4.

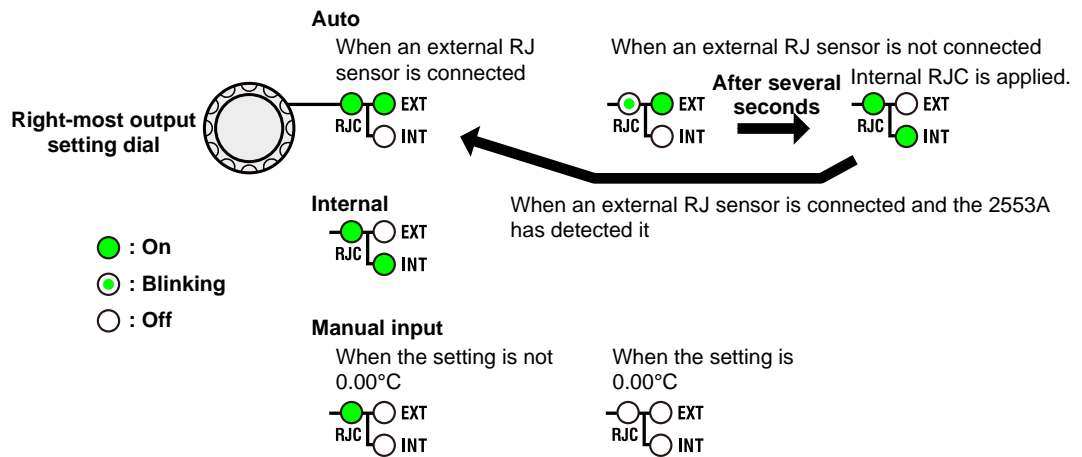

Setting the Reference Junction Temperature When the RJC Mode Is Manual Input

- If you selected manual input, turn an **output setting** dial other than the right-most dial to set the reference junction temperature.

Reference Junction Temperature Display

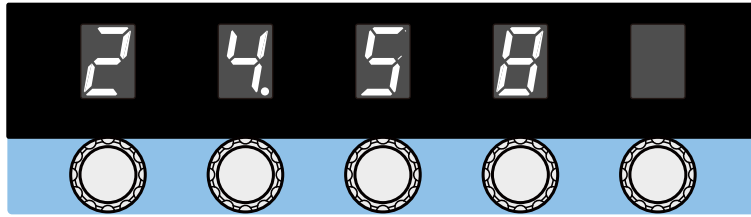

Setting Resistance R0 of an External RJ Sensor

You want to use the measured temperature of an external RJ sensor for the reference junction temperature, set the resistance for when the RJ sensor is at 0°C.

1. Turn the **RANGE** dial to select SETUP.
The SETUP menu appears.

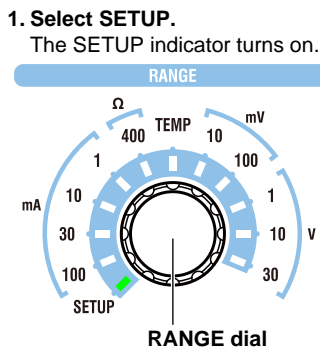

2. Turn an **output setting** dial to select RJC.
The RJC menu appears.
3. Flip the **POLARITY** switch down.
The RJC menu appears.

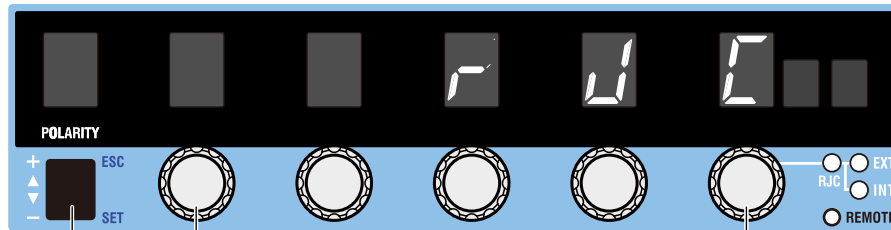

POLARITY switch

3. Displays the RJC menu

Output setting dials (use any)

2. Select RJC.

4. Turn an **output setting** dial to select R0.
5. Flip the **POLARITY** switch down.
The current R0 value appears.

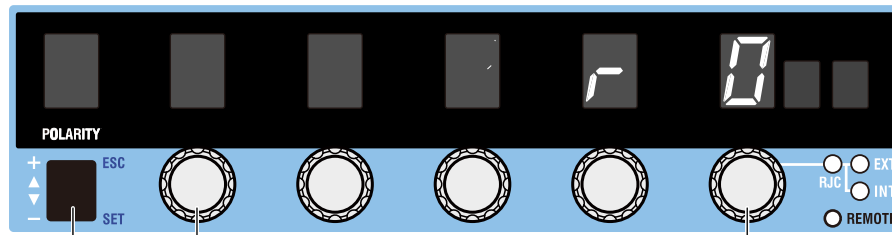

POLARITY switch

5. Display the R0 value.

Output setting dials (use any)

4. Select R0.

6. Turn the four **output setting** dials to set the R0 value.
7. Flip the **POLARITY** switch down.
The R0 value is confirmed.

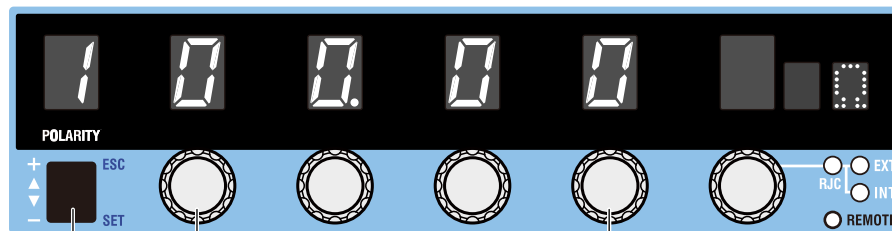

POLARITY switch

7. Confirm the set R0 value.

Output setting dials (four)

6. Set the R0 value.

Explanation

The 2553A can source thermoelectromotive force (voltage) that corresponds to specified temperatures after performing reference junction compensation. It is also possible to source thermoelectromotive force without reference junction compensation.

Reference Junction Compensation Mode

Select the reference junction compensation (RJC) mode from the available options below. The 2553A corrects the sourced thermoelectromotive force (RJC) according to the selected mode.

Auto

- **When an External RJ Sensor Is Detected**

When the 2553A detects that an RJ sensor is connected to the external RJ sensor input terminal on the rear panel, the 2553A sources thermoelectromotive force that is corrected using the temperature measured by the external RJ sensor.

- **When an External RJ Sensor Is Not Detected**

If an RJ sensor is not connected to the 2553A or is not detected, the 2553A applies its internal RJC.

RJ sensors 257875 are sold separately as accessories. An RTD Pt100 can also be used as an RJ sensor.

Internal

The 2553A sources thermoelectromotive force that is corrected using the temperature of its output terminals.

6.5 Setting Reference Junction Compensation

Manual Input

You can set the reference junction temperature with the output setting dials. The 2553A sources thermoelectromotive force that is corrected using the specified temperature. If you do not want to apply correction (not use the RJC function), set the temperature to 0.00°C.

Selectable range: -20.00°C to +60.00°C

Reference Junction Temperature Display

The reference junction temperature is displayed with 0.01° resolution.

- While correcting the source thermoelectromotive force with an external or internal reference junction temperature, if the reference junction temperature goes outside the specification range, the RJC indicator will blink.
- If you change the polarity from positive to negative in manual input mode and the setting goes outside the manual-input selectable range, the setting and polarity displays will blink. If you turn any of the output setting dials in this condition but the setting still remains outside the manual-input selectable range, the setting is changed to -20.00°C, and the blinking will change to solid.

Resistance R0 of the External RJ Sensor

Set the resistance for when the RJ sensor (RTD Pt100) you want to use is at 0°C. The default value is 100.00 Ω.

Selectable range S: 99.00 Ω to 101.00 Ω

<<Command Mnemonic>>

```
:SOURCE:RJC:MODE {AUTO|INTERNAL|MANUAL}
:SOURCE:RJC:STATE?
:SOURCE:RJC:TEMPERATURE:AUTO
:SOURCE:RJC:TEMPERATURE:EXTERNAL?
:SOURCE:RJC:TEMPERATURE:INTERNAL?
:SOURCE:RJC:TEMPERATURE:MANUAL
:SOURCE:RJC:RESISTER?
:SYSTEM:RJC:RESISTER <Resistance>
```

6.6 Selecting the Temperature Unit

Procedure

1. Turn the **RANGE** dial to select SETUP.
The SETUP menu appears.

1. Select SETUP.

The SETUP indicator turns on.

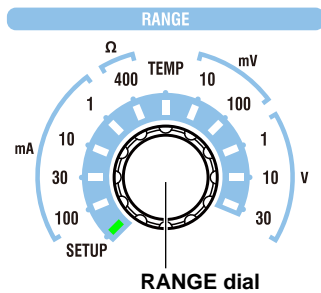

2. Turn an **output setting** dial to select UNIT.
3. Flip the **POLARITY** switch down.
The temperature unit menu appears.
4. Turn an **output setting** dial to select CEL or FAR.
5. Flip the **POLARITY** switch down.
The selected temperature unit is confirmed.

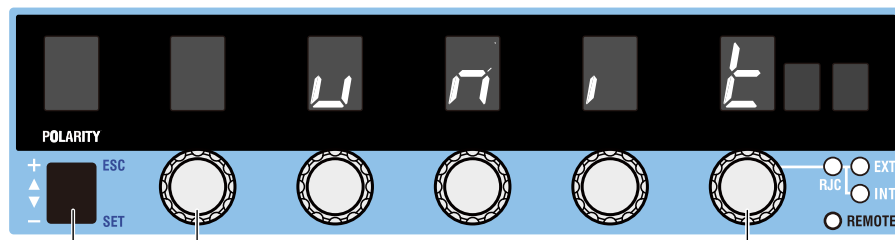

POLARITY switch

3. Display the temperature unit menu.
5. Confirm the selected temperature unit.

Output setting dials (use any)

2. Select UNIT.
4. Select CEL or FAR.

Explanation

On models with the -UF suffix code, you can select the temperature unit.

You can set the temperature using the selected unit.

CEL: °C

FAR: °F

<<Command Mnemonic>>

```
:SYSTEM:UNIT {C|CEL|F|FAR}
```

7.1 GP-IB Interface Features and Specifications

GP-IB Interface Features

Reception Feature

- With the exception of turning the power switch on and off, you can use the reception feature to specify the same settings that you specify by using the front panel keys.
- The 2553A can receive panel setup parameters, error codes, and other output requests from a controller.
- The 2553A can receive status report commands.

Transmission Feature

The 2553A can transmit panel setup parameters, status byte, error codes that occur, and so on.

Note

Talk-only, listen-only, and controller capabilities are not available.

GP-IB Interface Specifications

Item	Specifications
Supported devices	National Instruments Corporation <ul style="list-style-type: none"> • PCI-GPIB or PCI-GPIB+ • PCIe-GPIB or PCIe-GPIB+ • PCMCIA-GPIB or PCMCIA-GPIB+ (not supported on Windows Vista or Windows 7.) • GPIB-USB-HS Driver NI-488.2M Version 2.8.1 and later
Electrical and mechanical	Conforms to IEEE St'd 488-1978
Functional specifications	See the table below.
Protocol	Complies with IEEE St'd 488.2-1992 (when using standard commands)
Code	ISO (ASCII) codes
Mode	Addressable mode
Address	The address can be set in the range of 0 to 30.
Clear remote mode	Clear remote mode by flipping the OUTPUT switch to the LOCAL side. This is not possible when local lockout has been activated by the controller.

Functional Specifications

Function	Subset Name	Description
Source handshaking	SH1	Full source handshaking capability
Acceptor handshaking	AH1	Full acceptor handshaking capability
Talker	T6	Basic talker capability, serial polling, and untalk on MLA (My Listen Address). No talk-only capability.
Listener	L4	Basic listener capability and unlisten on MTA (My Talk Address). No listen-only capability
Service request	SR1	Full service request capability
Remote local	RL1	Full remote/local capability
Parallel polling	PP0	No parallel polling capability
Device clear	DC1	Full device clear capability
Device trigger	DT1	Device trigger capability
Controller	C0	No controller capability
Electric characteristics	E1	Open collector

Switching between Remote and Local Modes

When Switching from Local to Remote Mode

The 2553A switches to remote mode when it is in local mode and receives a REN (Remote Enable) message from the PC.

- The REMOTE indicator turns on.
- All dials and switches are disabled except for the flipping of the **OUTPUT** switch to the LOCAL side to change the 2553A to local mode.
- Settings entered in local mode are retained even when the 2553A switches to remote mode.

When Switching from Remote to Local Mode

When the 2553A is in remote mode and you flip the **OUTPUT** switch to the LOCAL side, the 2553A switches to local mode. This is not possible when local lockout (see section 11.4) has been activated by the controller.

- The REMOTE indicator turns off.
- Dials and switches can be used.
- Settings entered in remote mode are retained even when the 2553A switches to local mode.

Note

You cannot use the GP-IB interface simultaneously with other interfaces (USB or Ethernet).

7.2 Connecting through the GP-IB Interface

GP-IB Cable

The 2553A is equipped with an IEEE St'd 488-1978 24-pin GP-IB connector. Use a GP-IB cable that conforms to this standard.

Connection Method

Connect the cable as shown below.

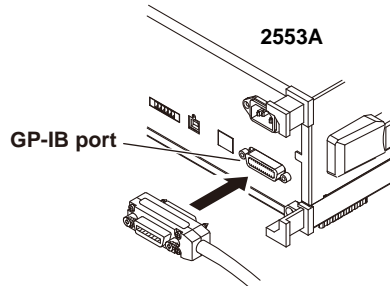

Notes on Connection

- Firmly tighten the screws on the GP-IB cable connector.
- On the PC end, use a GP-IB board (or card) made by National Instruments. For details, see section 7.1.
- The 2553A may not operate properly if the 2553A is connected to the PC through converters (such as a GP-IB to USB converter). For more details, contact your nearest YOKOGAWA dealer.
- Several cables can be used to connect multiple devices. However, no more than 15 devices, including the controller, can be connected on a single bus.
- When connecting multiple devices, you must assign a unique address to each device.
- Use cables that are no longer than 2 m in length to connect devices.
- Make sure the total length of all cables does not exceed 20 m.
- When devices are communicating, have at least two-thirds of the devices on the bus turned on.
- To connect multiple devices, wire them in a daisy-chain or star configuration as shown below. You can also mix these configurations. Loop configuration is not allowed.

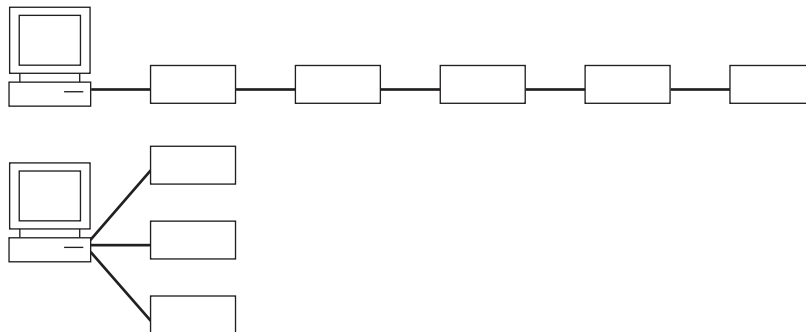

7.2 Connecting through the GP-IB Interface

CAUTION

Be sure to turn off the PC and the 2553A before you connect or remove communication cables. Otherwise, erroneous operation may result, or the internal circuitry may break.

French

ATTENTION

Toujours mettre le PC et le 2553A hors tension avant de brancher ou de débrancher des câbles de communication, pour éviter tout dysfonctionnement ou panne du circuit interne.

7.3 Configuring the 2553A GP-IB Settings

Procedure

1. Turn the **RANGE** dial to select SETUP.
The SETUP menu appears.

1. **Select SETUP.**
The SETUP indicator turns on.

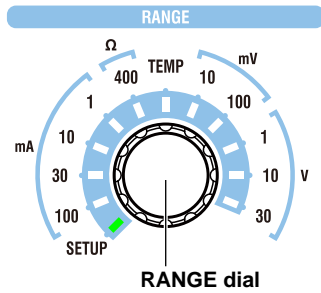

Selecting the GP-IB Interface

2. Turn an **output setting** dial to select GPIB.
3. Flip the **POLARITY** switch down.
The GP-IB menu appears.

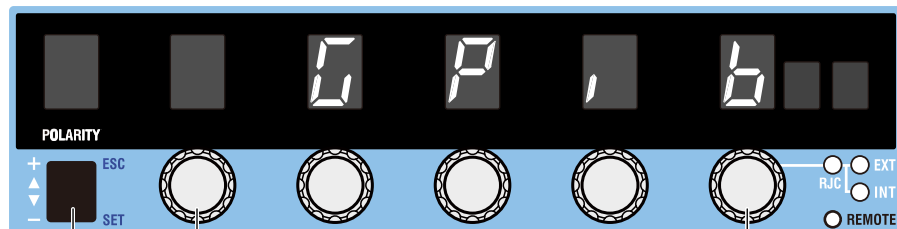

POLARITY switch

Output setting dials (use any)

3. Display the GP-IB menu.

2. Select GPIB.

Setting the GP-IB Address

4. Turn an **output setting** dial to select ADRS.
5. Flip the **POLARITY** switch down.
A GP-IB address appears.

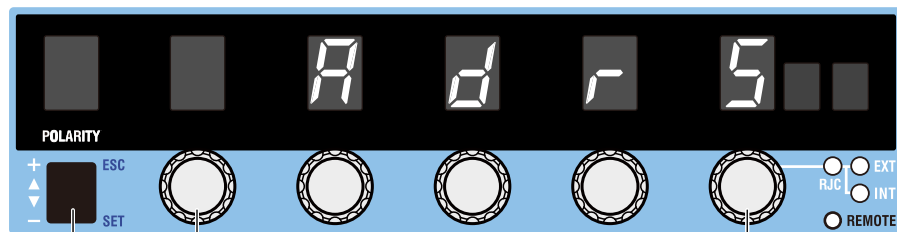

POLARITY switch

Output setting dials (use any)

5. Display the GP-IB address.

4. select ADRS.

7.3 Configuring the 2553A GP-IB Settings

6. Turn the two **output setting** dials on the right to set the GP-IB address.
7. Flip the **POLARITY** switch down.
The GP-IB address is confirmed.
8. Flip the **POLARITY** switch up.
The menu returns to the previous level.

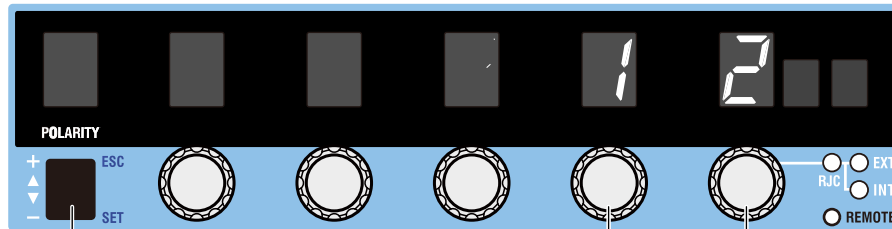

POLARITY switch

7. Confirm the GP-IB address settings.

Output setting dials (the right two)

6. Set the GP-IB address.

Setting the Command Type

4. Turn an **output setting** dial to select TYPE.
5. Flip the **POLARITY** switch down.
The command type menu appears.
6. Turn an **output setting** dial to select NORM or COMP.
7. Flip the **POLARITY** switch down.
The command type is confirmed.

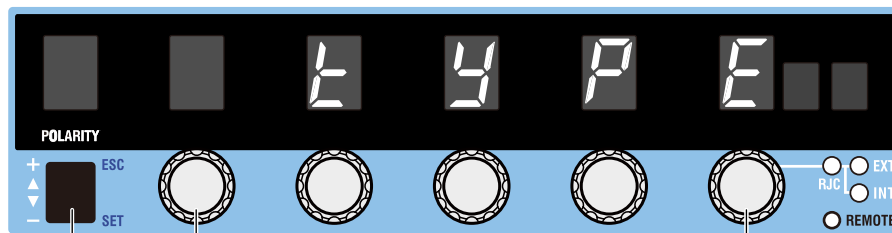

POLARITY switch

5. Display the command type menu.

7. Confirm the command type setting.

Output setting dials (use any)

4. Select TYPE.

6. Select NORM or COMP.

Explanation

To use the GP-IB interface, you must set the GP-IB address and command type.

GP-IB Address

Set the GP-IB address in the following range. Assign a unique address.

0 to 30

Command Type

The 2553A is compatible with the remote control commands of its predecessor model, the 2553. Select the command type depending on your situation.

- NORM: Normal commands. These commands comply with IEEE488.2 (see chapter 11).
- COMP: 2553 compatible commands.

Notes on Using Existing Programs

To use an existing 2553 program on the 2553A, note the following points.

- Insert a wait time of 1 second in operations that change the output. If you do not, the program may not work properly.
- The 2553A stores the polarity and output setting separately for the voltage, current, and temperature. The 2553 stores only a single set of polarity and output setting. As such, to use an existing 2553 program, you need to change the range and then specify the polarity and output setting for the voltage, current, and temperature so that they are congruent with the 2553A settings.

For details on COMP commands, see the 2553 user's manual.

Note

- Only use a single communication interface: USB, GP-IB, or Ethernet. If you send commands simultaneously from more than one communication interface, the 2553A will not execute the commands properly.
- When the controller is communicating with the 2553A or with other devices through GP-IB, do not change the address.
- Each device that is connected in a GP-IB system has its own unique address. This address is used to distinguish between different devices. Therefore, you must assign a unique address to the 2553A when connecting it to a PC or other device.
- The command type setting takes effect when you turn the 2553A off and then back on. If you select COMP, the 2553A will not accept standard commands nor communicate using the USB or LAN interface.

7.4 Responses to Interface Messages

Responses to Interface Messages

Responses to Uni-Line Messages

- **IFC (Interface Clear)**
Clears the talker and listener functions. Stops data transmission if it is in progress.
- **REN (Remote Enable)**
Switches between the remote and local modes.

IDY (Identify) is not supported.

Responses to Multi-Line Messages (Address commands)

- **GTL (Go To Local)**
Switches the instrument to local mode.
- **SDC (Selected Device Clear)**
 - Clears the program message (command) being received and the output queue (see section 12.5).
 - Discards *OPC and *OPC? commands that are being executed.
 - Immediately aborts *WAI and COMMunicate:WAIT commands.
PPC (Parallel Poll Configure) and TCT (Take Control) are not supported.
- **GET (Group Execute Trigger)**
When the GP-IB command type is set to COMP (compatible commands), this command outputs information about configuration changes and operation status.

Responses to Multi-Line Messages (Universal commands)

- **LLO (Local Lockout)**
Prohibits switching to local mode through the use of the OUTPUT key on the front panel.
- **DCL (Device Clear)**
The same operation as the SDC message.
- **SPE (Serial Poll Enable)**
Sets the talker function on all devices on the bus to serial polling mode. The controller will poll each device one by one.
- **SPD (Serial Poll Disable)**
Clears the serial polling mode of the talker function on all devices on the bus.

PPU (Parallel Poll Unconfigure) is not supported.

What Are Interface Messages?

Interface messages are also referred to as interface commands or bus commands. They are commands that are issued by the controller. They are classified as follows:

Uni-line Messages

A single control line is used to transmit uni-line messages. The following three types are available.

- IFC(Interface Clear)
- REN(Remote Enable)
- IDY(Identify)

Multi-line Messages

Eight data lines are used to transmit multi-line messages. The messages are classified as follows:

- **Address Commands**

Some address commands are valid when a device is designated as a listener, and some are valid when it is designated as a talker. The following five commands are available.

Commands that are valid on an instrument that is designated as a listener

- GTL(Go To Local)
- SDC(Selected Device Clear)
- PPC(Parallel Poll Configure)
- GET(Group Execute Trigger)

A command that is valid on an instrument that is designated as a talker

- TCT(Take Control)

- **Universal Commands**

Universal commands are available to all devices regardless of their listener or talker designation. The following five commands are available.

- LLO(Local Lockout)
- DCL(Device Clear)
- PPU(Parallel Poll Unconfigure)
- SPE(Serial Poll Enable)
- SPD(Serial Poll Disable)

There are other interface messages: listener-address, talk-address, and secondary commands.

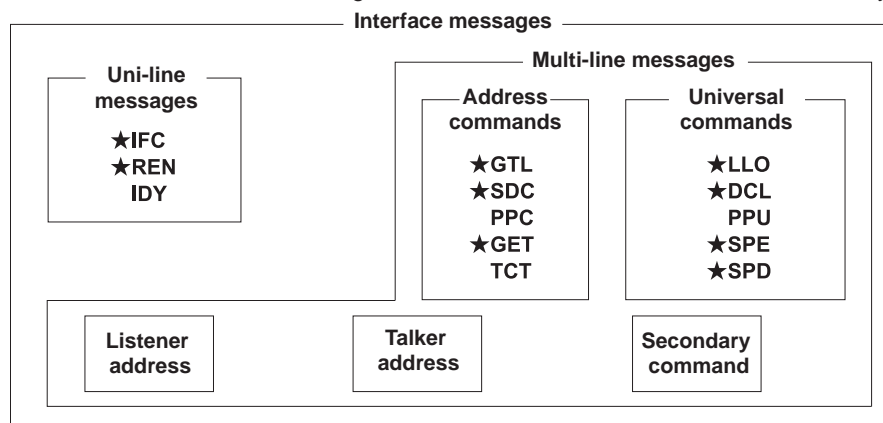

The 2553A supports interface messages marked with a ★.

Note

Difference between SDC and DCL

In multi-line messages, SDC messages are those that require talker or listener designation and DCL messages are those that do not require a designation. Therefore, SDC messages are directed at a particular instrument while DCL messages are directed at all instruments on the bus.

8.1 Ethernet Interface Features and Specifications

Ethernet Interface Features

Reception Feature

- With the exception of turning the power switch on and off, you can use the reception feature to specify the same settings that you specify by using the front panel keys.
- The 2553A can receive panel setup parameters, error codes, and other output requests from a controller.
- The 2553A can receive status report commands.

Transmission Feature

The 2553A can transmit panel setup parameters, status byte, error codes that occur, and so on.

Ethernet Interface Specifications

Item	Specifications
Number of ports	1
Connector type	RJ-45 connector
Electrical and mechanical	IEEE802.3 compliant
Simultaneous connections	3
Transmission system	ETHERNET(100BASE-TX/10BASE-T)
Communication protocol	TCP/IP(VXI-11)
Supported services	VXI-11 server, DHCP client

Switching between Remote and Local Modes

When Switching from Local to Remote Mode

The 2553A switches to remote mode when it is in local mode and receives a `:COMMunicate:REMOte ON` command from the PC.

- The REMOTE indicator turns on.
- All dials and switches are disabled except for the flipping of the **OUTPUT** switch to the LOCAL side to change the 2553A to local mode.
- Settings entered in local mode are retained even when the 2553A switches to remote mode.

When Switching from Remote to Local Mode

When the 2553A is in remote mode and you flip the **OUTPUT** switch to the LOCAL side, the 2553A switches to local mode. However, this does not work if the 2553A has received a `:COMMunicate:LOCKout ON` command from the PC. The 2553A switches to local mode when it receives a `:COMMunicate:REMOte OFF` command from the PC, regardless of the local lockout state.

- The REMOTE indicator turns off.
- Dials and switches can be used.
- Settings entered in remote mode are retained even when the 2553A switches to local mode.

Note

You cannot use the Ethernet interface simultaneously with other interfaces (GP-IB or USB).

8.2 Connecting to the Ethernet Interface

Connection Method

Connect a UTP (Unshielded Twisted-Pair) or STP (Shielded Twisted-Pair) cable that is connected to a hub or other network device to the Ethernet port on the 2553A rear panel.

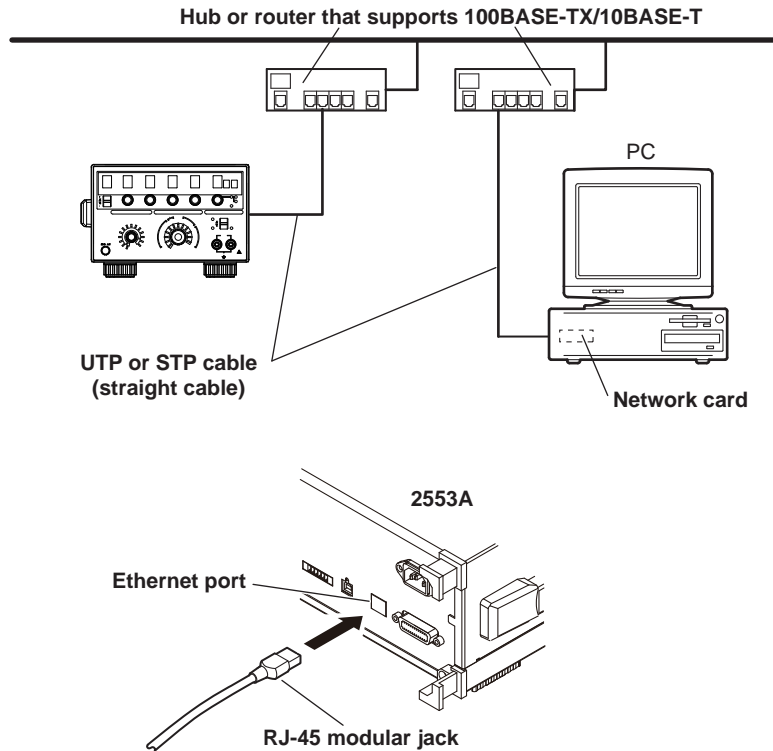

Notes on Connection

- To connect the 2553A to a PC through a hub or router, use straight cables. To directly connect the 2553A to a PC (one-to-one connection), use a crossover cable.
- Use a network cable that supports the data rate of your network.

8.3 Configuring the 2553A Ethernet Settings

Procedure

1. Turn the **RANGE** dial to select SETUP.
The SETUP menu appears.

1. Select SETUP.

The SETUP indicator turns on.

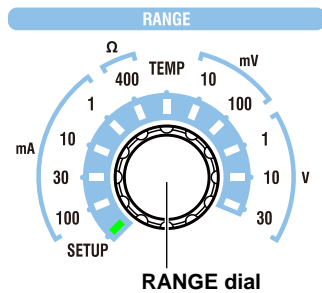

Selecting the Ethernet Interface

2. Turn an **output setting** dial to select LAN.
3. Flip the **POLARITY** switch down.
The LAN menu appears.

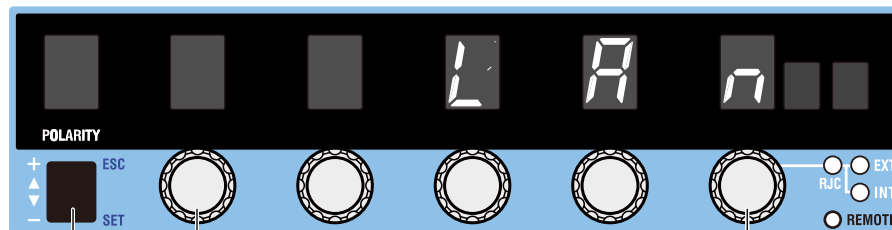

POLARITY switch

Output setting dials (use any)

3. Display the LAN menu.

2. Select LAN.

Turning DHCP On and Off

4. Turn an **output setting** dial to select DHCP.
5. Flip the **POLARITY** switch down.
The DHCP menu appears.
6. Turn an **output setting** dial to select ON or OFF.
7. Flip the **POLARITY** switch down.
The DHCP setting is confirmed.
8. Flip the **POLARITY** switch up.
The menu returns to the previous level.

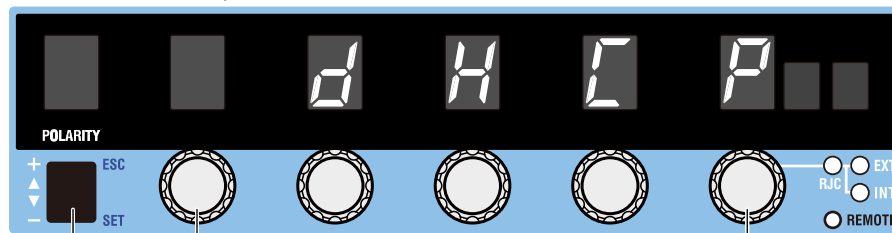

POLARITY switch

Output setting dials (use any)

5. Display the DHCP menu.
7. Confirm the DHCP setting.

4. Select DHCP.
6. Select ON or OFF.

Setting the IP Address, Subnet Mask, and Default Gateway

4. Turn an **output setting** dial to select IP (IP address), MASK (subnet mask), or GATE (default gateway).
5. Flip the **POLARITY** switch down.
Of the four octets of the IP, MASK, or GATE, the first octet appears.

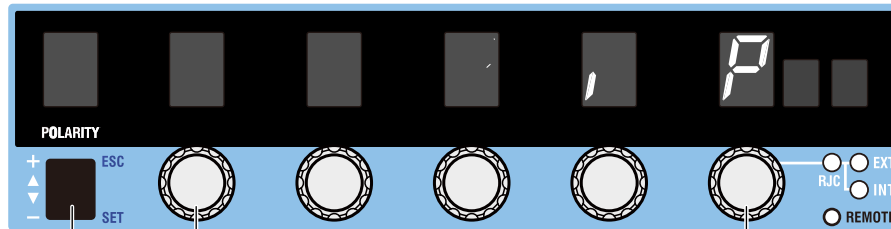

POLARITY switch

5. Display the first octet of the four octets of the IP, MASK, or GATE.

Output setting dials (use any)

4. Select IP, MASK, or GATE.

6. Turn the right-most **output setting** dial to select the octet number (1 to 4) you want to set.
7. Turn the three **output setting** dials to set the selected octet value.
8. Repeat steps 6 and 7 to set the four octets.
9. Flip the **POLARITY** switch down.
The IP, MASK, or GATE setting is confirmed.

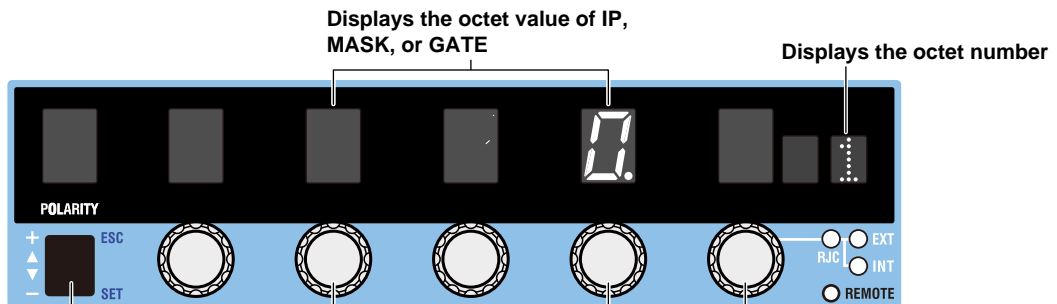

POLARITY switch
9. Confirm the IP, MASK, or GATE setting.

Output setting dials (three)
7. Set the value of the selected octet.
8. Repeat steps 6 and 7.

Right-most output setting dial
6. Select the octet number you want to set.

Explanation

To use the Ethernet interface, you must specify TCP/IP settings.

DHCP

DHCP is a protocol that temporarily allocates necessary information to a device so that it can connect to the Internet.

ON

If you are connecting the 2553A to a network with a DHCP server, you can turn on the DHCP setting. If you do, the IP address will be automatically assigned to the 2553A when it is connected to the network, so you do not have to set the address.

OFF

If you set DHCP to OFF, set the appropriate IP address, subnet mask, and default gateway for your network.

IP Address, Subnet Mask, and Default Gateway

The 2553A displays the IP address, subnet mask, and default gateway in the following manner.

IP address display example

Each octet value	Octet number
↓	↓
1 9 2.	1
1 6 8.	2
0.	3
1	4

MAC Address

The MAC address is a unique ID number assigned to an Ethernet card installed in a device. It is 12 characters long, with each character ranging from a to f and 0 to 9. MAC addresses are expressed in octets in hexadecimal notation.

If the MAC address is 00.00.12.34.56.78, the 2553A displays it in three groups: 00.00, 12.34, and 56.78.

Note

Only use a single communication interface: USB, GP-IB, or Ethernet. If you send commands simultaneously from more than one communication interface, the 2553A will not execute the commands properly.

9.1 USB Interface Features and Specifications

USB Interface Features

Reception Feature

- With the exception of turning the power switch on and off, you can use the reception feature to specify the same settings that you specify by using the front panel keys.
- The 2553A can receive panel setup parameters, error codes, and other output requests from a controller.
- The 2553A can receive status report commands.

Transmission Feature

The 2553A can transmit panel setup parameters, status byte, error codes that occur, and so on.

USB Interface Specifications

Item	Specifications
Number of ports	1
Connector type	Type B connector (receptacle)
Electrical and mechanical	Complies with USB Rev. 2.0
Supported transfer modes	HS (High Speed; 480 Mbps) and FS (Full Speed; 12 Mbps)
Supported protocols	USBTMC-USB488(USB Test and Measurement Class Ver.1.0)

Switching between Remote and Local Modes

When Switching from Local to Remote Mode

The 2553A switches to remote mode when it is in local mode and receives a `:COMMunicate:REMOte ON` command from the PC.

- The REMOTE indicator turns on.
- All dials and switches are disabled except for the flipping of the **OUTPUT** switch to the LOCAL side to change the 2553A to local mode.
- Settings entered in local mode are retained even when the 2553A switches to remote mode.

When Switching from Remote to Local Mode

When the 2553A is in remote mode and you flip the **OUTPUT** switch to the LOCAL side, the 2553A switches to local mode. However, this does not work if the 2553A has received a `:COMMunicate:LOCKout ON` command from the PC. The 2553A switches to local mode when it receives a `:COMMunicate:REMOte OFF` command from the PC, regardless of the local lockout state.

- The REMOTE indicator turns off.
- Dials and switches can be used.
- Settings entered in remote mode are retained even when the 2553A switches to local mode.

Note

You cannot use the USB interface simultaneously with other interfaces (GP-IB or Ethernet).

9.2 Connecting through the USB Interface

Connection Method

Connect the cable as shown below.

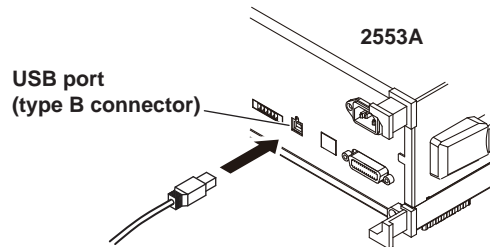

Notes on Connection

- Be sure to insert the USB cable connector firmly into the USB port.
- Do not connect or remove the USB cable from the time when the 2553A is turned on until operation becomes available (approximately 20 to 30 seconds). Doing so may damage the 2553A.

9.3 Configuring the 2553A USB Interface

Procedure

1. Turn the **RANGE** dial to select SETUP.
The SETUP menu appears.

1. **Select SETUP.**
The SETUP indicator turns on.

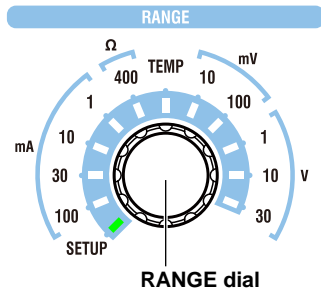

Selecting the USB Interface

2. Turn an **output setting** dial to select USB.
3. Flip the **POLARITY** switch down.
The USB menu appears.

Selecting the Remote Control Feature

4. Turn an **output setting** dial to select TMC.
5. Flip the **POLARITY** switch down.
The USB feature is confirmed.

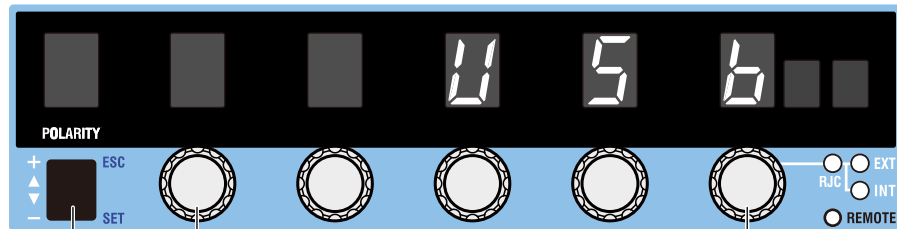

- POLARITY switch**
3. Display the USB menu.
 5. Confirm the USB feature.

- Output setting dials (use any)**
2. Select USB.
 4. Select TMC.

9.3 Configuring the 2553A USB Interface

Explanation

Set the USB communication feature to remote control.
Select the TMC option.

Note

- Only use a single communication interface: USB, GP-IB, or Ethernet. If you send commands simultaneously from more than one communication interface, the 2553A will not execute the commands properly.
 - Install the YOKOGAWA USB TMC (Test and Measurement Class) driver on your PC. For information about how to obtain the YOKOGAWA USB TMC driver, contact your nearest YOKOGAWA dealer. You can also access the YOKOGAWA USB driver download web page and download the driver.
<http://tmi.yokogawa.com/>
 - Do not use USB TMC drivers (or software) supplied by other companies.
-

10.2 Commands

Commands

There are three types of commands (program headers) that a controller may send to the 2553A. The commands differ in their program header formats.

Common Command Header

Commands that are defined in IEEE 488.2-1992 are called common commands. The common command header syntax is shown below. Be sure to include an asterisk (*) at the beginning of a common command.

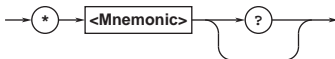

Common command example *CLS

Compound Header

Commands, other than common commands, that are specific to the 2553A are classified and arranged in a hierarchy according to their functions. The compound header syntax is shown below. Be sure to use a colon to specify a lower hierarchical level.

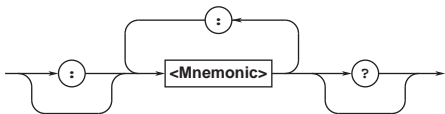

Compound header example :SOURCE:FUNCTION

Simple Header

These commands are functionally independent and are not contained within a hierarchy. The format of a simple header is shown below.



Simple header example :OUTPUT

Note

A <mnemonic> is an alphanumeric character string.

When Concatenating Commands

• Command Groups

A command group is a group of commands that have common compound headers arranged in a hierarchy. A command group may contain sub-groups.

Example Communication interface group

```
:SYSTEM:COMMUNICATE:GPIB:ADDRESS
:SYSTEM:COMMUNICATE:ETHERNET:DHCP
:SYSTEM:COMMUNICATE:ETHERNET:IP
:SYSTEM:COMMUNICATE:USB:FUNCTION
:SYSTEM:RJC:RESISTER
```

• When Concatenating Commands of the Same Group

The 2553A stores the hierarchical level of the command that is currently being executed and processes the next command on the assumption that it belongs to the same level. Therefore, the common header section can be omitted for commands that belong to the same group.

Example

```
:SYSTEM:COMMUNICATE:ETHERNET:DHCP OFF;
IP "10.0.5.8"<PMT>
```

• When Concatenating Commands of Different Groups

If the subsequent command does not belong to the same group, place a colon in front of the header (this colon cannot be omitted).

Example

```
:SOURCE:FUNCTION VOLTAGE;
:SYSTEM:COMMUNICATE:USB:FUNCTION TMC<PMT>
```

• When Concatenating Simple Headers

If a simple header follows another command, place a colon in front of the simple header (this colon cannot be omitted).

Example

```
:SOURCE:LEVEL 1V;:OUTPUT ON<PMT>
```

• When Concatenating Common Commands

Common commands that are defined in IEEE 488.2-1992 are independent of hierarchy. A colon is not needed before a common command.

Example

```
:SOURCE:RANGE 10V ;*CLS;
:SOURCE:LEVEL 1V<PMT>
```

• When Separating Commands with <PMT>

If you separate two commands with a terminator, two program messages will be sent. Therefore, the common header must be specified for each command even when commands belonging to the same command group are being concatenated.

Example

```
:SOURCE:FUNCTION VOLTAGE<PMT>;
SOURCE:RANGE 10V<PMT>
```

10.2 Commands

Upper-level Query

An upper-level query is a query that is made by appending a question mark to a command higher in the group. The controller can receive all of the settings in a group collectively by executing a highest-level query. Some upper-level queries of a group, which may be comprised of more than three hierarchical levels, can cause the 2553A to transmit all the lower level settings.

The response to an upper-level query can be sent back to the 2553A as a program message. This enables the settings that were present when the upper-level query was made to be reproduced later on. However, some upper-level queries do not return setup parameters that are not currently in use. Exercise caution because not all of a group's information is necessarily returned in a response.

Header Interpretation Rules

The 2553A interprets the header that it receives according to the rules below.

- Mnemonics are not case sensitive.

Example

"SOURce" can also be written as "source" or "SOURCE."

- The lower-case characters can be omitted.

Example

"SOURce" can also be written as "SOURc" or "SOUR."

- The question mark at the end of a header indicates that it is a query. You cannot omit the question mark.

Example

The shortest abbreviation for "SYSTEM?" is "SYST?."

- Parts of commands and parameters enclosed in square brackets ([]) can be omitted.

Example

:OUTPut [:STATe] ON
can also be written as "OUTP ON."

However, the last section enclosed in square brackets cannot be omitted in an upper-level query.

Example

"SYSTEM?" and "SYSTEM:COMMunicate?" are different queries.

10.3 Responses

Responses

When the controller sends a query with a question mark, the 2553A returns a response message to the query. The 2553A returns response messages in one of the following two forms.

- **Response Consisting of a Header and Data**
Responses that can be used as program messages without any changes are returned with command headers attached.

Example

```
:SOURCE:FUNCTION?<PMT>  
->:SOURCE:FUNCTION VOLTAGE<RMT>
```

- **Response Only Consisting of Data**
Responses that cannot be used as program messages unless changes are made (query-only commands) are returned without headers. However, there are query-only commands whose responses the 2553A will attach headers to.

Example

```
:SOURCE:RTD:SETTING?<PMT> ->  
" 0.0, 850.0, 1.000000000e+02,  
3.908300000e-01,-5.775000000e-05,  
0.000000000e+00, 0.000000000e+00,  
0.000000000e+00, 0.000000000e+00,  
0.000000000e+00, 0.000000000e+00,  
0.000000000e+00, 0.000000000e+00,  
0.000000000e+00, 0.000000000e+00,  
0.000000000e+00, 0.000000000e+00,  
0.000000000e+00, 0.000000000e+00,  
0.000000000e+00, 0.000000000e+00"  
<RMT>
```

If You Want the 2553A to Return Responses without Headers

You can configure the 2553A so that even responses that have both headers and data are returned without headers. Use the `COMMunicate:HEADer` command for this purpose.

Abbreviated Form

The 2553A normally returns response headers with the lower-case section removed. You can configure the 2553A so that full headers are returned. Use the `COMMunicate:VERBose` command for this purpose. The sections enclosed in square brackets ([]) are also omitted in the abbreviated form.

10.4 Data

Data

Data contains conditions and values that are written after the header. A space separates the data from the header. Data is classified as follows:

Data	Meaning
<Decimal>	A value expressed in decimal notation
<Voltage><Current> <Resistance> <Temperature>	A physical value (Example: Voltage range setting ->:SOURce:RANGe 30V
<Time> <Register>	A register value expressed as binary, octal, decimal, or hexadecimal (Example: Extended event register value ->:STATus:EESE #HFE)
<Character Data>	Predefined character string (mnemonic). Select from the available strings in braces {}. (Example: Select the source function ->:SOURce:FUNction {VOLTage CURRent})
<Boolean>	Indicates on and off. Specify ON, OFF, or a value. (Example: Turn the output on. ->:OUTPut:STATe ON)
<String Data>	User-defined string (Example: Ethernet IP address setting ->:SYSTem:COMMunicate:ETHernet:IP "192.168.0.1")
<Block Data>	Data that contains 8-bit values

<Decimal>

<Decimal> indicates a value expressed as a decimal number, as shown in the table below. Decimal values are written in the NR form as specified in ANSI X3.42-1975.

Symbol	Meaning	Example		
<NR1>	Integer	125	-1	+1000
<NR2>	Fixed-point number	125.0	-.90	+001.
<NR3>	Floating-point number	125.0E+0	-9E-1	+1.1E4
<NRf>	Any of the forms <NR1> to <NR3>			

- The 2553A can receive decimal values that are sent from the controller in any of the forms <NR1> to <NR3>. This is expressed as <NRf>.
- The 2553A returns a response to the controller in one of the forms from <NR1> to <NR3> depending on the query. The same form is used regardless of the size of the value.
- For the <NR3> form, the plus sign after the "E" can be omitted. You cannot omit the minus sign.
- If a value outside the range is entered, the value is adjusted to the closest value within the range.
- If a value has more significant digits than are available, the value will be rounded.

<Voltage>, <Current>, <Resistance>, <Temperature>, and <Time>

<Voltage>, <Current>, <Resistance>, <Temperature>, and <Time> indicate decimal values that have physical significance. A <Multiplier> or <Unit> can be attached to the form that was described earlier. Use one of the following syntaxes.

Syntax	Example
<NRf><Multiplier><Unit>	5MV
<NRf><Unit>	5E-3V
<NRf><Multiplier>	5M
<NRf>	5E-3

<Multiplier>

Multipliers that you can use are indicated in the following table.

Symbol	Word	Multiplier
EX	Exa	10 ¹⁸
PE	Peta	10 ¹⁵
T	Tera	10 ¹²
G	Giga	10 ⁹
MA	Mega	10 ⁶
K	Kilo	10 ³
M	Milli	10 ⁻³
U	Micro	10 ⁻⁶
N	Nano	10 ⁻⁹
P	Pico	10 ⁻¹²
F	Femto	10 ⁻¹⁵

<Unit>

Units that you can use are indicated in the following table.

Symbol	Word	Meaning
V	Volt	Voltage
A	Ampere	Current
OHM	Ohm	Resistance
CEL	Celsius	Temperature °C
FAR	Fahrenheit	Temperature °F (only on models with the -UF suffix code)
S	Second	Time

- <Multiplier> and <Unit> are not case sensitive.
- "U" is used to indicate micro (μ).
- "MA" is used for Mega to distinguish it from Milli. However, "MA" is interpreted as milliampere for current.
- If both <Multiplier> and <Unit> are omitted, the basic unit (V, A, or S) is used.

<Register>

<Register> indicates an integer, and can be expressed in hexadecimal, octal, or binary as well as a decimal number. This is used when each bit of the value has a particular meaning. Use one of the following syntaxes.

Syntax	Example
<NRf>	1
#H<Hexadecimal value made up of the digits 0 to 9 and A to F>	#H0F
#Q<Octal value made up of the digits 0 to 7>	#Q777
#B<Binary value made up of the digits 0 and 1>	#B001100

- <Register> is not case sensitive.
- Response messages are always expressed in the <NR1> form.

<Character Data>

<Character Data> is a specified string of character data (a mnemonic). It is mainly used to indicate options and is chosen from the character strings given in { }. The data interpretation rules are the same as those described in "Header Interpretation Rules" in section 10.2.

Syntax	Example
{VOLTage CURRent}	VOLTage

- As with the header, the COMMunicate:VERBoSe command can be used to select whether to return the response in the full form or in the abbreviated form.
- The COMMunicate:HEADer setting does not affect <Character data>.

<Boolean>

<Boolean> is data that indicates ON or OFF. Use one of the following syntaxes.

Syntax	Example
{ON OFF <NRf>}	ON OFF 1 0

- When <NRf> is expressed in the form, OFF is selected if the rounded integer value is "0" and ON is selected for all other cases.
- A response message is always returned with a "1" if the value is ON and with a "0" if the value is OFF.

<String Data>

<String data> is not a specified character string like <Character data>. It is an arbitrary character string. The character string must be enclosed in single quotation marks (') or double quotation marks (").

Syntax	Example
<String Data>	'ABC' "IEEE488.2-1992"

- If a character string contains a double quotation mark ("), the double quotation mark is expressed as two consecutive quotation marks (" "). This rule also applies to single quotation marks.

- A response message is always enclosed in double quotation marks (").
- <String data> is any character string. Therefore, the instrument assumes that the remaining program message units are part of the character string if no closing single (') or double quotation mark (") is encountered. As a result, no error is detected if a quotation mark is omitted.

<Block Data>

<Block data> contains 8-bit values. It is only used in response messages on the 2553A. The syntax is as follows:

Syntax	Example
#N<N-digit decimal number><Data byte sequence>	#80000010ABCDEFGHIJ

- #N
Indicates that the data is <Block data>. N indicates the number of succeeding data bytes (digits) in ASCII code.
- <N-digit decimal number>
Indicates the number of bytes of data (example: 00000010 = 10 bytes).
- <Data byte sequence>
Expresses the actual data (example: ABCDEFGHIJ).
- Data is comprised of 8-bit values (0 to 255). This means that the ASCII code "0AH," which stands for "NL," can also be included in the data. Hence, care must be taken when programming the controller.

10.5 Synchronization with the Controller

Overlap Commands and Sequential Commands

There are two types of commands: overlap and sequential.

With overlap commands, the execution of the next command may start before the execution of the previous command is finished.

With sequential commands, the execution of the next command is held until the execution of the previous command is finished (even if multiple commands are sent consecutively).

All 2553A commands are sequential commands. However, even sequential commands sometimes require synchronization. For example, if the output value is changed and then measured immediately with a measuring instrument, the measured value may have not yet reached the final value. If this happens, you must use the following method to synchronize to the point in time when the new output value is reached.

Achieving Synchronization without Using Overlap Commands

- **Using the `STATUS:CONDITION?` Query**

`STATUS:CONDITION?` is used to query the contents of the condition register (see section 12.4). You can determine whether approximately 500 ms (response time of the 2553A) has elapsed after the output value is changed by reading bit 3 of the condition register. If bit 3 of the condition register is 1, this indicates that approximately 500 ms has not elapsed since the output value was changed or the output was turned on. If the bit is 0, this indicates that approximately 500 ms has elapsed.

Example

```
:SOURCE:LEVEL 10V<PMT>
```

```
:STATUS:CONDITION?<PMT>
```

(Read the response. If the bit 3 is "1", return to the previous line.)

Next command

The next command is not executed until bit 3 in the condition register becomes "0".

- **Using the Extended Event Register**

The changes in the condition register can be reflected in the extended event register (see section 12.4).

Example

```
:STATUS:FILTER4 FALL;:STATUS:EES 8;  
EESR?;*SRE 8;:SOURCE:LEVEL 10V<PMT>
```

(Read the response to `:STATUS:EESR?`)

(Wait for a service request)

Next command

The `STATUS:FILTER4 FALL` command sets the transition filter so that bit 3 in the extended event is set to "1" when bit 3 in the condition register changes from "1" to "0".

The `:STATUS:EES 4` command is used to only change the status byte based on bit 3 in the extended event register.

The `:STATUS:EESR?` command is used to clear the extended event register.

The `*SRE 8` command is used to generate service requests based only on the changes in the extended event register bits.

The next command is not executed until a service request is generated.

- **Using the `COMMUNICATE:WAIT` Command**

The `COMMUNICATE:WAIT` command is used to wait for a specific event to occur.

Example

```
:STATUS:FILTER4 FALL;:STATUS:EESR?;  
:SOURCE:LEVEL 10V<PMT>
```

(Read the response to `:STATUS:EESR?`)

```
:COMMUNICATE:WAIT #H0008<PMT>
```

Next command

For a description of `:STATUS:FILTER4 FALL` and `:STATUS:EESR?`, see the previous section about the extended event register.

The `:COMMUNICATE:WAIT #H0008` command specifies that the program will wait for bit 3 in the extended event register to be set to "1".

The next command is not executed until bit 3 in the extended event register becomes "1".

11.1 List of Commands

Command	Function	Page
COMMunicate Group		
:COMMunicate?	Queries all communication settings.	11-3
:COMMunicate:HEADer	Sets or queries whether headers are attached to query responses.	11-3
:COMMunicate:LOCKout	Sets/clears local lockout.	11-3
:COMMunicate:REMOte	Sets the 2553A to remote or local mode. On is remote mode.	11-3
:COMMunicate:VERBose	Sets or queries whether the response to a query is returned fully spelled out or in its abbreviated form.	11-3
:COMMunicate:WAIT	Waits for a specified extended event to occur.	11-3
:COMMunicate:WAIT?	Creates the response that is returned when a specified extended event occurs.	11-3
OUTPut Group		
:OUTPut[:STATe]	Sets or queries the output's on/off state.	11-4
:OUTPut:POLarity	Sets or queries the polarity.	11-4
SOURce Group		
:SOURce?	Queries all source settings.	11-5
:SOURce:FUNCTion	Sets or queries the source function.	11-5
:SOURce:LEVEl	Sets or queries the output setting.	11-5
:SOURce:RANGe	Sets or queries the voltage, current, or resistance range.	11-5
:SOURce:RJC?	Queries all reference junction compensation settings.	11-6
:SOURce:RJC:MODE	Sets or queries the reference junction compensation mode.	11-6
:SOURce:RJC:STATe?	Queries the reference junction compensation operating state.	11-6
:SOURce:RJC:TEMPerature?	Queries the reference junction compensation temperature.	11-6
:SOURce:RJC:TEMPerature:AUTO	Sets or queries the reference junction compensation temperature.	11-6
:SOURce:RJC:TEMPerature:EXTern al?	Queries the external reference junction temperature.	11-7
:SOURce:RJC:TEMPerature:INTern al?	Queries the 2553A's internal reference junction (2553A output terminal) temperature.	11-7
:SOURce:RJC:TEMPerature:MANual	Sets or queries the temperature for when the reference junction compensation mode is set to manual input.	11-7
:SOURce:RJC:RESister?	Queries the resistance of the RJ sensor to be used for the external reference junction for 0°C.	11-7
:SOURce:RTD?	Queries all user-defined RTD settings.	11-7
:SOURce:RTD:DEFine	Sets a user-defined RTD.	11-7
:SOURce:RTD:DELeTe	Deletes user-defined RTDs.	11-7
:SOURce:RTD:SETTing?	Queries all temperature range settings that are user-defined for the RTD.	11-7
:SOURce:RTD:TYPE	Sets or queries the type string for distinguishing user-defined RTDs.	11-8
:SOURce:RTD:WRITe	Writes a user-defined RTD.	11-8
:SOURce:SLEVEl	Sets or queries the output setting with polarity information.	11-8
:SOURce:TCouple?	Queries all user-defined thermocouple settings.	11-8
:SOURce:TCouple:DEFine	Sets a user-defined thermocouple.	11-9
:SOURce:TCouple:DELeTe	Deletes user-defined thermocouples.	11-9
:SOURce:TCouple:SETTing?	Queries all temperature range settings that are user-defined for the thermocouple.	11-9
:SOURce:TCouple:TYPE	Sets or queries the type string for distinguishing user-defined thermocouples.	11-9
:SOURce:TCouple:WRITe	Writes a user-defined thermocouple.	11-9
:SOURce:TYPE	Sets or queries the thermocouple or RTD type.	11-9
STATus Group		
:STATus?	Queries all the settings of the communication status feature.	11-10
:STATus:CONDition?	Queries the contents of the condition register.	11-10
:STATus:EESE	Sets or queries the extended event enable register.	11-10
:STATus:EESR?	Queries the contents of the extended event register and clears the register.	11-10
:STATus:ERRor?	Queries the error code and message of the last error that has occurred (top of the error queue).	11-10

11.1 List of Commands

Command	Function	Page
:STATus:FILTER<x>	Sets or queries the transition filter.	11-10
:STATus:QENable	Sets or queries whether messages other than errors will be stored to the error queue (ON) or not (OFF).	11-10
:STATus:QMESSAGE	Sets or queries whether message information will be attached to the response to the STATus:ERRor? query (ON/OFF).	11-10

SYSTEM Group

:SYSTem?	Queries all the system settings.	11-11
:SYSTem:COMMunicate	Queries all the communication settings.	11-11
:SYSTem:COMMunicate:ETHernet?	Queries all the Ethernet communication settings.	11-11
:SYSTem:COMMunicate:ETHernet:DHCP	Sets or queries the Ethernet DHCP on/off state.	11-11
:SYSTem:COMMunicate:ETHernet:GATEway	Sets or queries the Ethernet default gateway.	11-11
:SYSTem:COMMunicate:ETHernet:IP	Sets or queries the Ethernet IP address.	11-11
:SYSTem:COMMunicate:ETHernet:MACAddress	Sets or queries the Ethernet MAC address.	11-11
:SYSTem:COMMunicate:ETHernet:MASK	Sets or queries the Ethernet subnet mask.	11-11
:SYSTem:COMMunicate:GPIB?	Queries all the GP-IB communication settings.	11-12
:SYSTem:COMMunicate:GPIB:ADDRESS	Sets or queries the GP-IB address.	11-12
:SYSTem:COMMunicate:GPIB:TYPE	Sets or queries the GP-IB command type.	11-12
:SYSTem:COMMunicate:USB:FUNCTION	Sets or queries the USB feature (USB-TMC/storage).	11-12
:SYSTem:REBoot	Restarts the 2553A when the specified time elapses.	11-12
:SYSTem:RJC:RESister	Sets or queries the resistance of the sensor to be used for the external reference junction for 0°C.	11-12
:SYSTem:UNIT	Sets or queries the temperature unit.	11-12

Common Command Group

*CLS	Clears the standard event register, extended event register, and error queue.	11-13
*ESE	Sets or queries the standard event enable register.	11-13
*ESR?	Queries and clears the standard event register.	11-13
*IDN?	Queries the instrument model.	11-13
*OPC	Sets bit 0 (the OPC bit) of the standard event register to 1 upon the completion of the specified overlap command.	11-13
*OPC?	Returns ASCII code 1 when the specified overlap command is completed.	11-13
*OPT?	Queries the installed options.	11-13
*RST	Initializes settings.	11-13
*SRE	Sets or queries the service request enable register value.	11-14
*STB?	Queries the Status Byte Register value.	11-14
*TST?	Executes a self-test and queries the result.	11-14
*WAI	Holds the execution of the subsequent command until the specified overlap command is completed.	11-14

11.2 COMMunicate Group

The commands in this group deal with communications.

There are no front panel dials and switches that correspond to the commands in this group.

:COMMunicate?

Function Queries all communication settings.

Syntax :COMMunicate?

:COMMunicate:HEADer

Function Sets or queries whether headers are attached to query responses.

Syntax :COMMunicate:HEADer <Boolean>
:COMMunicate:HEADer?

ON|1: Headers are attached.

OFF|0: Headers are not attached.

Example :COMMUNICATE:HEADER ON
:COMMUNICATE:HEADER?
-> :COMMUNICATE:HEADER 1

:COMMunicate:LOCKout

Function Sets/clears local lockout.

Syntax :COMMunicate:LOCKout <Boolean>
:COMMunicate:LOCKout?

Example :COMMUNICATE:LOCKOUT ON
:COMMUNICATE:LOCKOUT?
-> :COMMUNICATE:LOCKOUT 1

:COMMunicate:REMote

Function Sets the 2553A to remote or local mode. On is remote mode.

Syntax :COMMunicate:REMote <Boolean>
:COMMunicate:REMote?

ON|1: Remote

OFF|0: Local

Example :COMMUNICATE:REMOTE ON
:COMMUNICATE:REMOTE?
-> :COMMUNICATE:REMOTE 1

:COMMunicate:VERBose

Function Sets or queries whether the response to a query is returned fully spelled out or in its abbreviated form.

Syntax :COMMunicate:VERBose <Boolean>
:COMMunicate:VERBose?

ON|1: Returned fully spelled out

OFF|0: Returned in abbreviated form

Example :COMMUNICATE:VERBOSE ON
:COMMUNICATE:VERBOSE?
-> :COMMUNICATE:VERBOSE 1

Description

- Example of a response fully spelled out

:CALIBRATE:RANGE 1.0E+00

- Example of a response in abbreviated form

:CAL:RANG 1.0E+00

:COMMunicate:WAIT

Function Waits for a specified extended event to occur.

Syntax :COMMunicate:WAIT <Register>
<Register> = 0 to 65535

Example :COMMUNICATE:WAIT #H0008

Description

- For details on how to use the :COMMunicate:WAIT command to synchronize the 2553A, see section 10.5.
- For details on the extended event register, see section 12.4.

:COMMunicate:WAIT?

Function Creates the response that is returned when a specified extended event occurs.

Syntax :COMMunicate:WAIT? <Register>
<Register> = 0 to 65535

Example :COMMUNICATE:WAIT? 65535 -> 1

Description For details on the extended event register, see section 12.4.

11.3 OUTPUT Group

The commands in this group deal with the output on/off setting and polarity setting. The commands correspond to the front panel OUTPUT and POLARITY switches.

:OUTPUT[:STATE]

Function Sets or queries the output's on/off state.

Syntax :OUTPUT[:STATE] <Boolean>
:OUTPUT?

ON|1: Enabled
OFF|0: Disabled

Example :OUTPUT ON
:OUTPUT? -> :OUTPUT 1

Description If the source function is RJTemp and you set the output's on/off state, a "221: Setting conflict" error will occur. Set the source function with the :SOURCE:FUNCTION command.

:OUTPUT:POLARITY

Function Sets or queries the polarity.

Syntax :OUTPUT:POLARITY {NORMAL|INVERTED}
:OUTPUT:POLARITY?

NORMAL: Positive polarity
INVERTED: Negative polarity

Example :OUTPUT:POLARITY NORMAL
:OUTPUT:POLARITY?
-> :OUTPUT:POLARITY NORMAL

Description

- If the source function is RJTemp and you set the polarity, a "221: Setting conflict" error will occur. NORMAL is returned as a response to a query. Set the source function with the :SOURCE:FUNCTION command.
- If the output setting goes outside the selectable range of the source function when you change the polarity, the output will turn off. In this condition, the output cannot be turned on.

11.4 SOURce Group

The commands in this group deal with setting the source function (voltage, current, thermocouple, RTD, resistance), setting the output setting, setting the reference junction compensation, and creating user-defined thermocouples and RTDs. The commands correspond to the front panel RANGE dial, TEMPERATURE dial, and output setting dials.

:SOURce?

Function Queries all source settings.
Syntax :SOURce?

:SOURce:FUNction

Function Sets or queries the source function.
Syntax :SOURce:FUNction {VOLTage|CURRent|TCouple|RTD|RESistance|RJTemp}
:SOURce:FUNction?

VOLTage: Voltage
CURRent: Current
TCouple: Thermocouple
RTD: Resistance temperature detector
RESistance: Resistance
RJTemp: Reference junction temperature

Example :SOURCE:FUNCTION VOLTAGE
:SOURCE:FUNCTION? -> VOLTAGE

Description If the front panel is displaying the SETUP menu, "NONE" will be returned in response to a query.

:SOURce:LEVEl

Function Sets or queries the output setting.
Syntax :SOURce:LEVEl {<Voltage>|<Current>|<Temperature>|<Resistance>|MINimum|MAXimum}

<Voltage>: Voltage output setting
<Current>: Current output setting
<Temperature>: Temperature output setting
<Resistance>: Resistance output setting
MINimum: Minimum value in the selectable range*
MAXimum: Maximum value in the selectable range*

* See "Description."

Example :SOURCE:LEVEL 1V
:SOURCE:LEVEL?
-> :SOURCE:LEVEL 1.00000E+00

Description

- Even if you include the plus or minus sign in the setting, the polarity will not be set. The polarity follows the setting specified by the :OUTPut:POLarity command. Therefore, the minimum and maximum values in the selectable range of the :SOURce:LEVEl are the minimum and maximum values of the absolute values on the polarity side specified by the :OUTPut:POLarity command.
- To set the value with the sign, use the :SOURce:SLEVEl command.

- Before setting <Voltage>, use the :SOURce:FUNction command to set the source function to VOLTage. Before setting <Current>, use the :SOURce:FUNction command to set the source function to CURRent. Before setting <Temperature>, use the :SOURce:FUNction command to set the source function to TCouple or RTD. Before setting <Resistance>, use the :SOURce:FUNction command to set the source function to RESistance. If you set an output setting of a different source function, a "131: Invalid suffix" error will occur.
- If the source function is RJTemp and you set the output setting, a "221: Setting conflict" error will occur. 9.91E+37 is returned as a response to a query.
- The selectable range changes depending on the range setting of the voltage, current, or resistance or the type setting of the thermocouple or RTD. Set the voltage, current, or resistance range with the :SOURce:RANGE command. Set the thermocouple or RTD type with the :SOURce:TYPE command.

:SOURce:RANGE

Function Sets or queries the voltage, current, or resistance range.

Syntax :SOURce:RANGE {<Voltage>|<Current>|<Resistance>}
:SOURce:RANGE?

<Voltage>=10mV, 100mV, 1V, 10V, 30V
<Current>=1mA, 10mA, 30mA, 100mA
<Resistance>=400OHM

Example :SOURCE:RANGE 1V
:SOURCE:RANGE?
-> :SOURCE:RANGE 1.0E+00

Description

- Before setting <Voltage>, use the :SOURce:FUNction command to set the source function to VOLTage. Before setting <Current>, use the :SOURce:FUNction command to set the source function to CURRent. Before setting <Resistance>, use the :SOURce:FUNction command to set the source function to RESistance. If you set range of a different source function, a "131: Invalid suffix" error will occur.

11.4 SOURce Group

- If the source function is TCouple, RTD, RJTemp and you set the range, a "221: Setting conflict" error will occur. 9.91E+37 is returned as a response to a query.
- If you change the range, the output turns off.

:SOURce:RJC?

Function Queries all reference junction compensation settings.

Syntax :SOURce:RJC?

:SOURce:RJC:MODE

Function Sets or queries the reference junction compensation mode.

Syntax :SOURce:RJC:MODE {AUTO|INTernal|MANual}

AUTO: Auto
INTernal: Internal
MANual: Manual input

Example :SOURCE:RJC:MODE INTERNAL
:SOURCE:RJC:MODE?
-> :SOURCE:RJC:MODE INTERNAL

Description The 2553A corrects the sourced thermoelectromotive force (RJC) according to the set mode.

- AUTO
If an external RJ sensor is detected, a correction is performed using the measured temperature of the external RJ sensor. Otherwise, a correction is performed using the temperature of the 2553A output terminals (internal).
- INTernal
A correction is performed using the temperature of the 2553A output terminals (internal).
- MANual
A correction is performed using a manually input temperature. You can set the temperature from the 2553A front panel (see section 6.5 and chapter 4). You can also set it with the :SOURce:RJC:TEMPerature:MANual command. If you do not want to apply correction, set the temperature to 0°C.

:SOURce:RJC:STATe?

Function Queries the reference junction compensation operating state.

Syntax :SOURce:RJC:STATe?
-> {EXTernal|INTernal|MANual|OFF}
EXTernal: External
INTernal: Internal
MANual: Manual input
OFF: When manual input is selected and the reference junction temperature is set to 0°C.

Example :SOURCE:RJC:STATe?
-> :SOURCE:RJC:STATE EXTERNAL

Description If the reference junction compensation (RJC) mode is set to AUTO and an external RJ sensor is detected, EXTernal is returned. If an external RJ sensor is not detected, INTernal is returned. If the RJC mode is set to INTernal, INTernal is returned. If the RJC mode is set to MANual and the manually input reference junction temperature is not 0°C, MANual is returned. If the temperature is set to 0°C, OFF is returned.

:SOURce:RJC:TEMPerature?

Function Queries the reference junction compensation temperature.

Syntax :SOURce:RJC:TEMPerature?
Example :SOURce:RJC:TEMPerature?
-> :SOURCE:RJC:TEMPERATURE:MANUAL 0.0

Description The manual-input reference junction temperature is returned.

:SOURce:RJC:TEMPerature:AUTO

Function Sets or queries the reference junction compensation temperature.

Syntax :SOURce:RJC:TEMPerature:AUTO
<Temperature>
:SOURce:RJC:TEMPerature:AUTO?
Example :SOURCE:RJC:TEMPERATURE:AUTO 0.0
:SOURCE:RJC:TEMPERATURE:AUTO?
-> :SOURCE:RJC:TEMPERATURE:AUTO 0.0

Description • If the reference junction compensation (RJC) mode is set to MANual, you can set the reference junction temperature. You can also query the value. If the RJC mode is set to AUTO or INTernal, you cannot set the reference junction temperature. A "221: Setting conflict" error will occur. You can query the reference junction temperature.

- If the reference junction temperature is outside the measurement range, 9.9E+37 or -9.9E+37 is returned in response to a query.

:SOURce:RJC:TEMPerature:EXTErnal?

Function Queries the external reference junction temperature.

Syntax :SOURCE:RJC:TEMPerature:EXTErnal?

Example :SOURCE:RJC:TEMPERATURE:EXTErnal?
-> :SOURCE:RJC:TEMPERATURE:
EXTERNAL 0.0

Description If the reference junction temperature is outside the measurement range, 9.9E+37 or -9.9E+37 is returned.

:SOURce:RJC:TEMPerature:INTernal?

Function Queries the 2553A's internal reference junction (2553A output terminal) temperature.

Syntax :SOURCE:RJC:TEMPerature:INTernal?

Example :SOURCE:RJC:TEMPERATURE:INTernal?
-> :SOURCE:RJC:TEMPERATURE:
INTERNAL 0.0

Description If the reference junction temperature is outside the measurement range, 9.9E+37 or -9.9E+37 is returned.

:SOURce:RJC:TEMPerature:MANual

Function Sets or queries the temperature for when the reference junction compensation mode is set to manual input.

Syntax :SOURCE:RJC:TEMPerature:
MANual <Temperature>
:SOURCE:RJC:TEMPerature:MANual?

Example :SOURCE:RJC:TEMPERATURE:MANUAL 0.0
:SOURCE:RJC:TEMPERATURE:MANUAL?
-> :SOURCE:RJC:TEMPERATURE:MANUAL 0.0

:SOURce:RJC:RESister?

Function Queries the resistance of the RJ sensor to be used for the external reference junction for 0°C.

Syntax :SOURCE:RJC:RESister?

Example :SOURCE:RJC:RESISTER?
-> :SOURCE:RJC:RESISTER 100.00

:SOURce:RTD?

Function Queries all user-defined RTD settings.

Syntax :SOURCE:RTD?

:SOURce:RTD:DEFine

Function Sets a user-defined RTD.

Syntax :SOURCE:RTD:DEFine <String>
<String>: Definition of the relationship between the temperature range and resistance.
For details on string syntax, see appendix 4.

Example :SOURCE:RTD:
DEFINE "-100.0,0.0,100.0,1.0"

Description • You can create a user definition for a single temperature range. To set multiple temperature ranges, repeat this command.

- After creating user definitions for the required temperature ranges, to source the resistance of the user-defined RTD, execute the commands in the following table.

```
:SOURCE:RTD:WRITE
Writes the user definitions to the 2553A's
internal memory. The user definitions take
effect.
:SOURCE:FUNCTION RTD
Sets the source function to RTD.
:SOURCE:TYPE USER
Sets the type to USER.
:OUTPUT ON
Finally, when you turn the output on, the
2553A sources the resistance of the user-
defined RTD.
```

:SOURce:RTD:DELEte

Function Deletes user-defined RTDs.

Syntax :SOURCE:RTD:DELEte

Example :SOURCE:RTD:DELETE

Description This command deletes all user definitions created with the :SOURce:RTD:DEFine command. To create a new user definition, delete existing user definitions with this command.

:SOURce:RTD:SETTing?

Function Queries all temperature range settings that are user-defined for the RTD.

Syntax :SOURCE:RTD:SETTing?

Example :SOURCE:RTD:SETTING?
-> "...;100.0,200.0,100.00,-1.0E+3;
..."

Description All the temperature range settings that have been user-defined are returned in a single character string with each setting delimited by a semicolon. For details on string syntax, see appendix 4.

11.4 SOURce Group

:SOURce:RTD:TYPE

Function	Sets or queries the type string for distinguishing user-defined RTDs.
Syntax	<code>:SOURce:RTD:TYPE <String></code> <code>:SOURce:RTD:TYPE?</code> <code><String></code> : No character or a single ASCII code character in the range of 20 to 7E (hexadecimal) For the characters that correspond to ASCII codes 20 to 7E, see appendix 7.
Example	<code>:SOURCE:RTD:TYPE "p"</code> <code>:SOURCE:RTD:TYPE?</code> <code>-> :SOURCE:RTD:TYPE "p"</code>
Description	If set to "No character," the two characters "o" and "C" will be displayed in the dot matrix LEDs of the 2553A front panel. If set to a single character, "oC" will be displayed in the first character of the dot matrix LEDs and the specified character in the second. If the unit is set to °F on a model with the -UF suffix code, F is displayed in place of C. You can change the temperature unit from the 2553A front panel (see section 6.6). You can also use the <code>:SYSTEM:UNIT</code> command.

:SOURce:RTD:WRITE

Function	Writes a user-defined RTD.
Syntax	<code>:SOURce:RTD:WRITE</code>
Example	<code>:SOURCE:RTD:WRITE</code>
Description	The user definition set with the <code>:SOURce:RTD:DEFine</code> command is written to the 2553A's internal memory.

:SOURce:SLEVel

Function	Sets or queries the output setting with polarity information.
Syntax	<code>:SOURce:SLEVel {<Voltage> <Current> <Temperature> <Resistance> MINimum MAXimum}</code> <code>:SOURce:SLEVel?</code> <code><Voltage></code> : Voltage output setting <code><Current></code> : Current output setting <code><Temperature></code> : Temperature output setting <code><Resistance></code> : Resistance output setting MINimum: Minimum value in the selectable range MAXimum: Maximum value in the selectable range
Example	<code>:SOURCE:SLEVEL -1V</code> <code>:SOURCE:SLEVEL -> -1.00000E+00</code>
Description	<ul style="list-style-type: none">• If you attach a minus sign to the setting, the polarity is set to negative. If you attach a plus sign or do not attach any sign, the polarity is set to positive.• Before setting <code><Voltage></code>, use the <code>:SOURce:FUNCTION</code> command to set the source function to <code>VOLTage</code>. Before setting <code><Current></code>, use the <code>:SOURce:FUNCTION</code> command to set the source function to <code>CURRent</code>. Before setting <code><Temperature></code>, use the <code>:SOURce:FUNCTION</code> command to set the source function to <code>TCouple</code> or <code>RTD</code>. Before setting <code><Resistance></code>, use the <code>:SOURce:FUNCTION</code> command to set the source function to <code>RESistance</code>. If you set an output setting of a different source function, a "131: Invalid suffix" error will occur.• If the source function is <code>RJTemp</code> and you set the output setting, a "221: Setting conflict" error will occur. <code>9.91E+37</code> is returned as a response to a query.• The selectable range changes depending on the range setting of the voltage, current, or resistance or the type setting of the thermocouple or RTD. Set the voltage, current, or resistance range with the <code>:SOURce:RANGe</code> command. Set the thermocouple or RTD type with the <code>:SOURce:TYPE</code> command.

:SOURce:TCouple?

Function	Queries all user-defined thermocouple settings.
Syntax	<code>:SOURce:TCouple:?</code>

:SOURce:TCouple:DEFine

Function Sets a user-defined thermocouple.

Syntax :SOURce:TCouple:DEFine <String>
<String>: Definition of the relationship between the temperature range and thermoelectromotive force.
For details on string syntax, see appendix 4.

Example :SOURCE:TCOUPLE:
DEFINE "-100.0,0.0,-100.0,1.0"

Description

- You can create a user definition for a single temperature range. To set multiple temperature ranges, repeat this command.
- After creating user definitions for the required temperature ranges, to source the thermoelectromotive force of the user-defined thermocouple, execute the commands in the following table.

```
:SOURCE:TCOUPLE:WRITE
  Writes the user definitions to the 2553A's
  internal memory. The user definitions take
  effect.
:SOURCE:FUNCTION TCOUPLE
  Sets the source function to TCouple.
:SOURCE:TYPE USER
  Sets the type to USER.
:OUTPUT ON
  Finally, when you turn the output on, the
  2553A sources the thermoelectromotive
  force of the user-defined thermocouple.
```

:SOURce:TCouple:DELEte

Function Deletes user-defined thermocouples.

Syntax :SOURce:TCouple:DELEte

Example :SOURCE:TCOUPLE:DELETE

Description This command deletes all user definitions created with the :SOURce:TCouple:DEFine command. To create a new user definition, delete existing user definitions with this command.

:SOURce:TCouple:SETTing?

Function Queries all temperature range settings that are user-defined for the thermocouple.

Syntax :SOURce:TCouple:SETTing?

Example :SOURCE:TCOUPLE:SETTING?
-> "...;100.0,200.0,1.0E+5,-1.0E+3;
..."

Description All the temperature range settings that have been user-defined are returned in a single character string with each setting delimited by a semicolon. For details on string syntax, see appendix 4.

:SOURce:TCouple:TYPE

Function Sets or queries the type string for distinguishing user-defined thermocouples.

Syntax :SOURce:TCouple:TYPE <String>
:SOURce:TCouple:TYPE?
<String>: No character or a single ASCII code character in the range of 20 to 7E (hexadecimal)
For the characters that correspond to ASCII codes 20 to 7E, see appendix 7.

Example :SOURCE:TCOUPLE:TYPE "k"
:SOURCE:TCOUPLE:TYPE?
-> :SOURCE:TCOUPLE:TYPE "k"

Description If set to "No character," the two characters "o" and "C" will be displayed in the dot matrix LEDs of the 2553A front panel.
If set to a single character, "oC" will be displayed in the first character of the dot matrix LEDs and the specified character in the second.
If the unit is set to °F on a model with the -UF suffix code, F is displayed in place of C. You can change the temperature unit from the 2553A front panel (see section 6.6). You can also use the :SYSTem:UNIT command.

:SOURce:TCouple:WRITE

Function Writes a user-defined thermocouple.

Syntax :SOURce:TCouple:WRITE

Example :SOURCE:TCOUPLE:WRITE

Description The user definition set with the :SOURce:TCouple:DEFine command is written to the 2553A's internal memory.

:SOURce:TYPE

Function Sets or queries the thermocouple or RTD type.

Syntax :SOURce:TYPE {R|S|B|J|T|E|K|N|C|A|PT100|USER}

Example :SOURCE:TYPE B
:SOURCE:TYPE? -> :SOURCE:TYPE B

Description Before setting the type, use the :SOURce:FUNCTion command to set the source function to TCouple or RTD. If the source function is VOLTage, CURRent, RESistance, or RJTemp and you set the type, a "221: Setting conflict" error will occur. "NONE" is returned as a response to a query.

11.5 STATUS Group

The commands in this group are used to make settings and queries related to the communication status feature. There are no front panel dials and switches that correspond to the commands in this group. For information about status reports, see chapter 12.

:STATUS?

Function Queries all the settings of the communication status feature.

Syntax :STATUS?

:STATUS:CONDition?

Function Queries the contents of the condition register.

Syntax :STATUS:CONDition?

Example :STATUS:CONDITION?
-> :STATUS:CONDITION 16

Description For information about the condition register, see chapter 12, "Status Reports."

:STATUS:EESE

Function Sets or queries the extended event enable register.

Syntax :STATUS:EESE {<Register>}
:STATUS:EESE?
<Register> = 0 to 65535

Example :STATUS:EESE #7659
:STATUS:EESE? -> :STATUS:EESE #7659

Description For information about the extended event enable register, see chapter 12, "Status Reports."

:STATUS:EESR?

Function Queries the contents of the extended event register and clears the register.

Syntax :STATUS:EESR?

Example :STATUS:EESR? -> :STATUS:EESR 1

Description For information about the extended event register, see chapter 12, "Status Reports."

:STATUS:ERROR?

Function Queries the error code and message of the last error that has occurred (top of the error queue).

Syntax :STATUS:ERROR?

Example :STATUS:ERROR?
-> 113, "Undefined header"

:STATUS:FILTer<x>

Function Sets or queries the transition filter.

Syntax :STATUS:FILTer<x> {BOTH|FALL|NEVer|RISE}
:STATUS:FILTer<x>?
<x> = 1 to 16

Example :STATUS:FILTER2 RISE
:STATUS:FILTER2?
-> :STATUS:FILTER1 RISE

Description • Set how each bit in the condition register must change to trigger the setting of an event. For example, if you specify RISE, a change from 0 to 1 triggers the setting of an event.
• For information about the transition filter, see chapter 12, "Status Reports."

:STATUS:QENable

Function Sets or queries whether messages other than errors will be stored to the error queue (ON) or not (OFF).

Syntax :STATUS:QENable {<Boolean>}
:STATUS:QENable?

Example :STATUS:QENABLE ON
:STATUS:QENABLE?
-> :STATUS:QENABLE 1

:STATUS:QMESsage

Function Sets or queries whether message information will be attached to the response to the STATUS:ERROR? query (ON/OFF).

Syntax :STATUS:QMESsage {<Boolean>}
:STATUS:QMESsage?

Example :STATUS:QMESSAGE OFF
:STATUS:QMESSAGE?
-> :STATUS:QMESSAGE 0

11.6 SYSTEM Group

The commands in this group are used to make settings and queries related to the communication interface, such as GP-IB, Ethernet, and USB. These commands correspond to the SETUP menu commands.

:SYSTEM?

Function Queries all the system settings.
Syntax :SYSTEM?

:SYSTEM:COMMunicate

Function Queries all the communication settings.
Syntax :SYSTEM:COMMunicate?

:SYSTEM:COMMunicate:ETHernet?

Function Queries all the Ethernet communication settings.
Syntax :SYSTEM:COMMunicate:ETHernet?

:SYSTEM:COMMunicate:ETHernet:DHCP

Function Sets or queries the Ethernet DHCP on/off state.
Syntax :SYSTEM:COMMunicate:ETHernet:
DHCP <Boolean>
:SYSTEM:COMMunicate:ETHernet:DHCP?
ON|1: DHCP is enabled.
OFF|0: DHCP is disabled.

Example :SYSTEM:COMMunicate:ETHernet:DHCP ON
:SYSTEM:COMMunicate:ETHernet:DHCP?
-> :SYSTEM:COMMunicate:ETHernet:
DHCP 1

:SYSTEM:COMMunicate:ETHernet:GATEway

Function Sets or queries the Ethernet default gateway.
Syntax :SYSTEM:COMMunicate:ETHernet:
GATEway <String>
:SYSTEM:COMMunicate:ETHernet:
GATEway?

Example :SYSTEM:COMMunicate:ETHernet:
GATEway "192.168.0.1"
:SYSTEM:COMMunicate:ETHernet:
GATEway?
-> :SYSTEM:COMMunicate:ETHernet:
GATEway "192.168.0.1"

:SYSTEM:COMMunicate:ETHernet:IP

Function Sets or queries the Ethernet IP address.
Syntax :SYSTEM:COMMunicate:ETHernet:
IP <String>

:SYSTEM:COMMunicate:ETHernet:IP?
<String> = "x.x.x.x": x = 0 to 255

Example :SYSTEM:COMMunicate:ETHernet:
IP "192.168.0.1"
:SYSTEM:COMMunicate:ETHernet:IP?
-> :SYSTEM:COMMunicate:ETHernet:
IP "192.168.0.1"

:SYSTEM:COMMunicate:ETHernet:MACaddre ss

Function Sets or queries the Ethernet MAC address.
Syntax :SYSTEM:COMMunicate:ETHernet:
MACaddress?

<String> = "xx:xx:xx:xx:xx:xx"
where xx is a value between 0 and FF

Example :SYSTEM:COMMunicate:ETHernet:
MACADDRESS "00:00:64:01:01:01"
:SYSTEM:COMMunicate:ETHernet:
MACADDRESS?
-> :SYSTEM:COMMunicate:ETHernet:
MACADDRESS "00:00:64:01:01:01"

:SYSTEM:COMMunicate:ETHernet:MASK

Function Sets or queries the Ethernet subnet mask.
Syntax :SYSTEM:COMMunicate:ETHernet:
MASK <String>

:SYSTEM:COMMunicate:ETHernet:MASK?
<String> = "x.x.x.x": x = 0 to 255

Example :SYSTEM:COMMunicate:ETHernet:
MASK "255.255.255.0"
:SYSTEM:COMMunicate:ETHernet:MASK?
-> :SYSTEM:COMMunicate:ETHernet:
MASK "255.255.255.0"

11.6 SYSTem Group

:SYSTem:COMMunicate:GPIB?

Function Queries all the GP-IB communication settings.
Syntax :SYSTem:COMMunicate:GPIB?

:SYSTem:COMMunicate:GPIB:ADDRESS

Function Sets or queries the GP-IB address.
Syntax :SYSTem:COMMunicate:GPIB:ADDRESS <NRf>
:SYSTem:COMMunicate:GPIB:ADDRESS? <NRf> = 0 to 30
Example :SYSTEM:COMMUNICATE:GPIB:ADDRESS 1
:SYSTEM:COMMUNICATE:GPIB:ADDRESS?
-> :SYSTEM:COMMUNICATE:GPIB:ADDRESS 1

:SYSTem:COMMunicate:GPIB:TYPE

Function Sets or queries the GP-IB command type.
Syntax :SYSTem:COMMunicate:GPIB:TYPE {NORMAL|COMPATIBLE}
:SYSTem:COMMunicate:GPIB:TYPE?
NORMAL: Standard commands that comply with IEEE488.2-1992
COMPATIBLE: Model 2553 compatible commands
Example :SYSTEM:COMMUNICATE:GPIB:TYPE COMPATIBLE
:SYSTEM:COMMUNICATE:GPIB:TYPE?
-> :SYSTEM:COMMUNICATE:GPIB:TYPE COMPATIBLE

:SYSTem:COMMunicate:USB:FUNCTION

Function Sets or queries the USB feature (USB-TMC/storage).
Syntax :SYSTem:COMMunicate:USB:FUNCTION {TMC|STORAGE}
:SYSTem:COMMunicate:USB:FUNCTION?
TMC: USB-TMC command control feature
STORAGE: Storage feature
Example :SYSTEM:COMMUNICATE:USB:FUNCTION STORAGE
:SYSTEM:COMMUNICATE:USB:FUNCTION?
-> :SYSTEM:COMMUNICATE:USB:FUNCTION STORAGE

:SYSTem:REBoot

Function Restarts the 2553A when the specified time elapses.
Syntax :SYSTem:REBoot <Time>
<Time> = 0 (S) to 60 (S)
Example :SYSTEM:REBOOT 3

:SYSTem:RJC:RESister

Function Sets or queries the resistance of the sensor to be used for the external reference junction for 0°C.
Syntax :SYSTem:RJC:RESister <Resistance>
:SYSTem:RJC:RESister?
Example :SYSTEM:RJC:RESISTER 100.00
:SYSTEM:RJC:RESISTER?
-> :SYSTEM:RJC:RESISTER 100.00

:SYSTem:UNIT

Function Sets or queries the temperature unit.
Syntax :SYSTem:UNIT {C|CEL|F|FAR}
C, CEL: °C (Celsius)
F, FAR: °F (Fahrenheit)
Example :SYSTEM:UNIT C
:SYSTEM:UNIT? -> :SYSTEM:UNIT C
Description On models with the -UC suffix code, this command is invalid. The unit is fixed at °C (Celsius). On models with the -UF suffix code, you can set the unit to °C (Celsius) or °F (Fahrenheit).

11.7 Common Command Group

The commands in this group are defined in IEEE 488.2-1992 and are independent from the instrument's individual functions. There are no front panel dials and switches that correspond to the commands in this group.

*CLS

- Function Clears the standard event register, extended event register, and error queue.
- Syntax *CLS
- Example *CLS
- Description
- If the *CLS command is located immediately after the program message terminator, the output queue is also cleared.
 - For information about each register and queue, see chapter 12, "Status Reports."

*ESE

- Function Sets or queries the standard event enable register.
- Syntax *ESE {<NRf>}
*ESE?
- Example *ESE 251
*ESE? -> 251
- Description
- Specify the value as a sum of the values of each bit in decimal format.
 - For example, specifying *ESE 251 will cause the standard enable register to be set to 11111011. In this case, bit 2 of the standard event register is disabled. This means that bit 5 (ESB) of the status byte register is not set to 1, even if a query error occurs.
 - The default value is *ESE 0 (all bits disabled).
 - A query using *ESE? will not clear the contents of the standard event enable register.
 - For information about the standard event enable register, see section 12.1.

*ESR?

- Function Queries and clears the standard event register.
- Syntax *ESR?
- Example *ESR? -> 32
- Description
- A sum of the values of each bit is returned in decimal format.
 - When an SRQ is sent, you can check what types of events have occurred.
 - For example, if a value of 32 is returned, this indicates that the standard event register is set to 00100000. This means that the SRQ occurred due to a command syntax error.
 - A query using *ESR? will clear the contents of the Standard Event Register.
 - For information about the standard event register, see section 12.3.

*IDN?

- Function Queries the instrument model.
- Syntax *IDN?
- Example *IDN?
-> YOKOGAWA,2553A,123456789,1.01
- Description
- The information is returned in this form: <manufacture>, <model>, <serial number>, <firmware version>.
 - For details on the model, see "Checking the Package Contents."

*OPC

- Function Sets bit 0 (the OPC bit) of the standard event register to 1 upon the completion of the specified overlap command.
- Syntax *OPC
- Example *OPC
- Description The 2553A does not have overlap commands. The OPC bit is always set to 1.

*OPC?

- Function Returns ASCII code 1 when the specified overlap command is completed.
- Syntax *OPC?
- Example *OPC? -> 1
- Description The 2553A does not have overlap commands. 1 is always returned.

*OPT?

- Function Queries the installed options.
- Syntax *OPT?
- Example *OPT? -> NONE
- Description The command returns the presence or absence of options. Because the 2553A does not have any options, "NONE" is always returned. The *OPT? query must be the last query of a program message. An error occurs if there is a query after this query.

*RST

- Function Initializes settings.
- Syntax *RST
- Example *RST
- Description All settings except communication settings are reset to their factory default values. For the default values, see appendix 5.

11.7 Common Command Group

*SRE

- Function** Sets or queries the service request enable register value.
- Syntax** *SRE {<Nrf>}
*SRE?
- Example** *SRE 239
*SRE? -> 175 (because the bit 6, MSS, setting is ignored)
- Description**
- Specify the value as a sum of the values of each bit in decimal format.
 - For example, specifying *SRE 239 will cause the standard enable register to be set to 11101111.
In this case, bit 4 of the service request enable register is disabled. This means that bit 4 (MAV) of the status byte register is not set to 1, even if the output queue is not empty.
 - Bit 6 (MSS) of the status byte register is the MSS bit itself and is therefore ignored.
 - The default value is *SRE 0 (all bits disabled).
 - A query using *SRE? will not clear the contents of the service request enable register.
 - For information about the service request enable register, see section 12.1.

*STB?

- Function** Queries the Status Byte Register value.
- Syntax** *STB?
- Example** *STB? -> 4
- Description**
- A sum of the values of each bit is returned as a decimal value.
 - Because the register is read without executing serial polling, bit 6 is an MSS bit, not an RQS bit.
 - For example, if a value of 4 is returned, this indicates that the status byte register is set to 00000100.
This means that the error queue is not empty (in other words, an error occurred).
 - A query using *STB? will not clear the contents of the status byte register.
 - For information about the status byte register, see section 12.2.

*TST?

- Function** Executes a self-test and queries the result.
- Syntax** *TST?
- Example** *TST? -> 0
- Description**
- For details on the self-test, see section 13.7.
 - This command returns 0 if the self-test is successful and 1 otherwise.
 - It takes approximately 1 seconds for the test to complete. When receiving a response from the 2553A, set the timeout to a relatively large value.

*WAI

- Function** Holds the execution of the subsequent command until the specified overlap command is completed.
- Syntax** *WAI
- Example** *WAI
- Description** The 2553A does not have overlap commands. This command will be ignored.

12.1 About Status Reports

Status Reports

The figure below shows the format of status reports that are read by serial polling. This status report format is an extended version of the status report format defined in IEEE 488.2-1992.

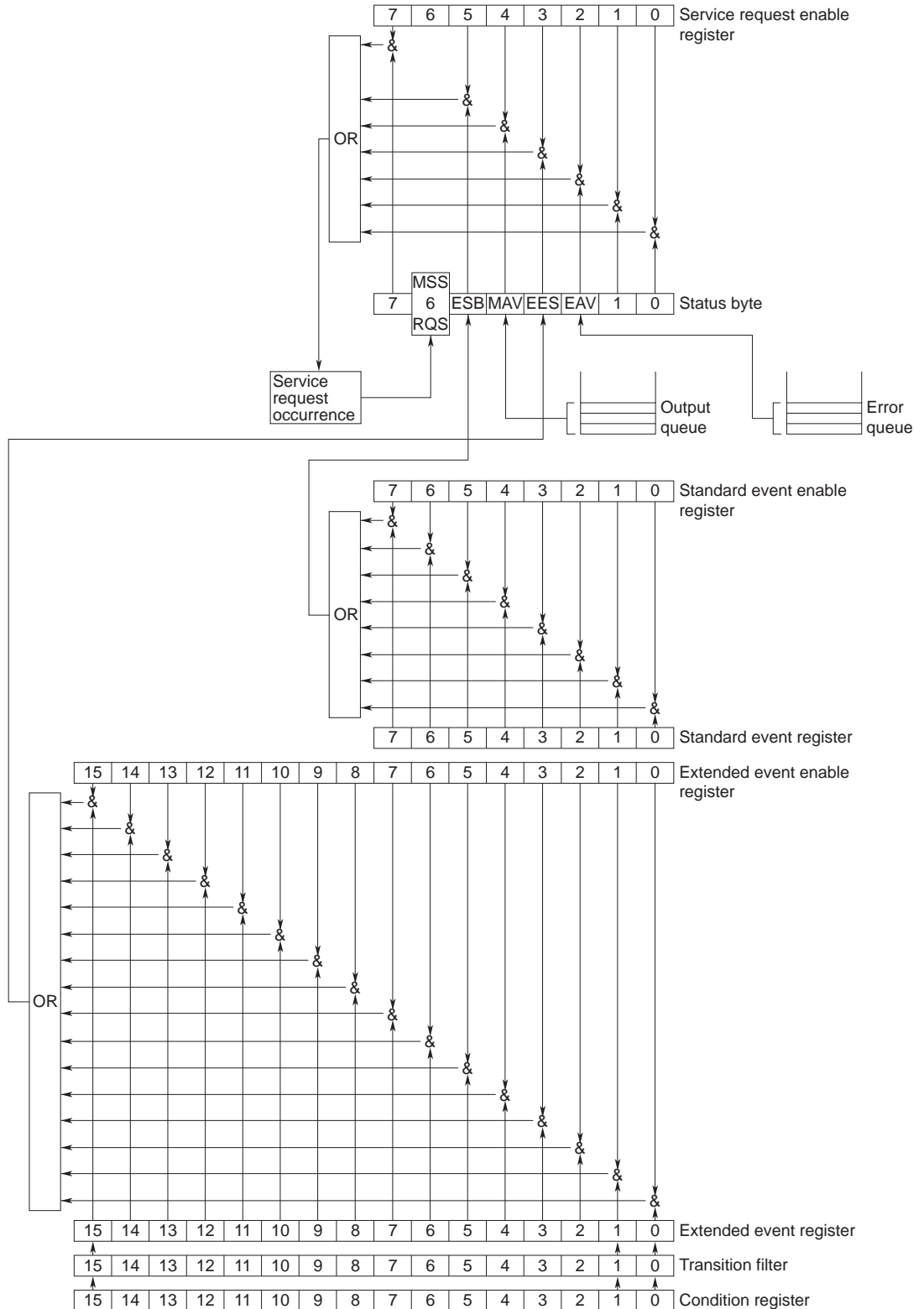

Overview of Registers and Queues

Name	Function	Write	Read
Status byte	—	—	Serial polling (RQS), *STB?(MSS)
Service request enable register	Status byte mask	*SRE	*SRE?
Standard event register	Indicates device status changes	—	*ESR?
Standard event enable register	Standard event register mask	*ESE	*ESE?
Extended event register	Indicates device status changes	—	STATUS:EESR?
Extended event enable register	Extended event register mask	STATUS:EESE	STATUS:EESE?
Condition register	Current device status	—	STATUS:CONDition?
Transition filter	Conditions that change the extended event register	STATUS:FILTer<x>	STATUS:FILTer<x>?
Output queue	Stores response messages for queries	Query commands	
Error queue	Stores error numbers and messages	—	STATUS:ERror?

Registers and Queues That Affect the Status Byte

The following registers affect the status byte bits.

Register	Affected Status Byte Bit
Standard event register	Sets bit 5 (ESB) to 1 or 0
Output queue	Sets bit 4 (MAV) to 1 or 0
Extended event register	Sets bit 3 (EES) to 1 or 0
Error queue	Sets bit 2 (EAV) to 1 or 0

Enable Registers

The following registers are used to mask a bit so that the bit will not affect the status byte even when it is set to 1.

Masked Register	Mask Register
Status byte	Service request enable register
Standard event register	Standard event enable register
Extended event register	Extended event enable register

Reading and Writing to Registers

For example, use the *ESE command to set the standard event enable register bits to 1 and 0. You can use the *ESE? command to query whether the standard event enable register bits are ones or zeros. For details on these commands, see chapter 11.

12.2 Status Byte

Status Byte



- **Bits 0, 1, and 7**
Not used (always 0)
- **Bit 2 EAV (Error Available)**
This bit is 1 when the error queue is not empty. In other words, this bit is set to 1 when an error occurs. See section 12.5.
- **Bit 3 EES (Extend Event Summary Bit)**
This bit is set to 1 when the logical AND of the extended event register and the extended event enable register is 1. In other words, this bit is set to 1 when a certain event takes place inside the instrument. See section 12.4.
- **Bit 4 MAV (Message Available)**
This bit is 1 when the output queue is not empty. In other words, this bit is set to 1 when there is data to be transmitted in response to a query. See section 12.5.
- **Bit 5 ESB (Event Summary Bit)**
This bit is set to 1 when the logical AND of the standard event register and the standard event enable register is 1. In other words, this bit is set to 1 when a certain event takes place inside the instrument. See section 12.3.
- **Bit 6 RQS (Request Service)/MSS (Master Status Summary)**
This bit is 1 when the logical AND of the status byte excluding bit 6 and the service request enable register is 1. In other words, this bit is set to 1 when the instrument requests service from the controller. RQS is set to 1 when the MSS bit changes from 0 to 1 and is cleared when serial polling is carried out or when the MSS bit changes to 0.

Bit Masking

To mask a bit in the status byte so that it does not cause an SRQ, set the corresponding bit of the service request enable register to 0.

For example, to mask bit 2 (EAV) so that service is not requested when an error occurs, set bit 2 of the service request enable register to 0. Do this using the *SRE command. To query whether each bit of the service request enable register is 1 or 0, use *SRE?. For details on the *SRE command, see chapter 11.

Status Byte Operation

A service request is issued when bit 6 in the status byte becomes 1. Bit 6 is set to 1 when any other bit becomes 1 (when the corresponding bit of the service request enable register is also set to 1). For example, if an event occurs and the logical OR of a standard event register bit and its corresponding enable register bit is 1, then bit 5 (ESB) is set to 1. At this point, if bit 5 of the service request enable register is 1, bit 6 (MSS) is set to 1, and the 2553A requests service from the controller.

You can check what type of event occurred by reading the contents of the status byte.

Reading the Status Byte

There are two ways to read the contents of the status byte.

- ***STB? Query**
Bit 6 functions as MSS when a query is made using *STB?. This causes the MSS to be read. This query does not cause any of the status byte bits to be cleared after the status byte is read.
- **Serial Polling**
Serial polling causes bit 6 to function as an RQS bit. This causes the RQS to be read. After the status byte is read, only the RQS bit is cleared. You cannot read the MSS bit when serial polling is used.

Clearing the Status Byte

There is no way to clear all the bits in the status byte. The bits that are cleared for each operation are shown below.

- ***STB? Query**
None of the bits are cleared.
- **Serial Polling**
Only the RQS bit is cleared.
- **When a *CLS Command Is Received**
When a *CLS command is received, the status byte itself is not cleared, but the contents of the standard event register, which affects the bits in the status byte, are cleared. As a result, the corresponding status byte bits are cleared. Because the output queue is not cleared with a *CLS command, bit 4 (MAV) in the status byte is not affected. However, the output queue will be cleared if the *CLS command is received just after a program message terminator.

12.3 Standard Event Register

Standard Event Register

7	6	5	4	3	2	1	0
PON	URQ	CME	EXE	DDE	QYE	RQC	OPC

- **Bit 7 PON (Power ON)**
This bit is set to 1 when the instrument is turned on.
- **Bit 6 URQ (User Request)**
Not used (always 0)
- **Bit 5 CME (Command Error)**
This bit is set to 1 when there is a command syntax error.
Example
Command names are misspelled, or character data that is not one of the available options has been received.
- **Bit 4 EXE (Execution Error)**
This bit is set to 1 when the command syntax is correct, but the command cannot be executed in the current state.
Example
A command whose parameter is outside the allowable range was received.
- **Bit 3 DDE (Device Error)**
This bit is set to 1 when a command cannot be executed for internal reasons other than a command syntax error or command execution error.
- **Bit 2 QYE (Query Error)**
This bit is set to 1 when a query command is received, but the output queue is empty or the data is lost.
Example
There is no response data, or data is lost due to an overflow in the output queue.
- **Bit 1 RQC (Request Control)**
Not used (always 0)
- **Bit 0 OPC (Operation Complete)**
This bit is set to 1 upon the completion of the operation designated by the *OPC command (see chapter 11 for details).

Bit Masking

To mask a certain bit of the standard event register so that it does not cause bit 5 (ESB) in the status byte to change, set the corresponding bit of the standard event enable register to 0.

For example, to mask bit 2 (QYE) so that ESB will not be set to 1 even if a query error occurs, set bit 2 of the standard event enable register to 0. Do this using the *ESE command. To query whether each bit of the standard event enable register is 1 or 0, use *ESE?. For details on the *ESE command, see chapter 11.

Standard Event Register Operation

The standard event register indicates eight types of events that occur inside the instrument. When one of the bits in this register becomes 1 (and the corresponding bit of the standard event enable register is also 1), bit 5 (ESB) in the status byte is set to 1.

Example

1. A query error occurs.
2. Bit 2 (QYE) is set to 1.
3. When bit 2 of the standard event enable register is 1, bit 5 (ESB) in the status byte is set to 1.

You can also check what type of event occurred in the 2553A by reading the contents of the standard event register.

Reading the Standard Event Register

You can use the *ESR? command to read the contents of the standard event register. The register is cleared after it is read.

Clearing the Standard Event Register

The standard event register is cleared in the following three cases.

- When the contents of the standard event register are read using the *ESR command.
- When a *CLS command is received.
- When the 2553A is restarted.

12.4 Extended Event Register

The extended event register receives information about changes in the condition register, which indicates the instrument's internal condition. The information is the result of edge detection performed by the transition filter.

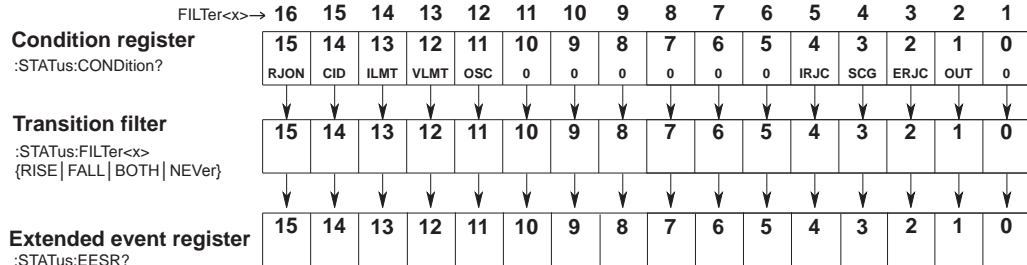

The condition register bits are described below.

Bit 0	–	Always 0
Bit 1	OUT (Output On)	Set to 1 when output is on.
Bit 2	ERJC (External Rjc Valid)	Set to 1 when the measured value of the external reference junction is within the measurement range.
Bit 3	SCG (Source Change)	Set to 1 when the output is turned on or the output setting is changed and changes to 0 after approximately 500 ms.
Bit 4	IRJC (Internal Rjc Valid)	Set to 1 when the measured value of the internal reference junction is within the measurement range.
Bit 5	–	Always 0
Bit 6	–	Always 0
Bit 7	–	Always 0
Bit 8	–	Always 0
Bit 9	–	Always 0
Bit 10	–	Always 0
Bit 11	OSC (Oscillating)	Set to 1 when an amplifier oscillation error is detected.
Bit 12	VLMT (Voltage Limiting)	Set to 1 when an overvoltage load is detected.
Bit 13	ILMT (Current Limiting)	Set to 1 when an overcurrent load is detected.
Bit 14	CID (Current Input Detected)	Set to 1 when an excessive current input is detected.
Bit 15	RJON (RJ Connect)	Set to 1 when an external reference junction (RJ) sensor is connected.

The transition filter parameters detect changes in the specified condition register bits (numeric suffixes 1 to 16) and overwrite the extended event register in the following ways.

RISE	The specified extended event register bit is set to 0 when the corresponding condition register bit changes from 0 to 1.
FALL	The specified extended event register bit is set to 1 when the corresponding condition register bit changes from 1 to 0.
BOTH	The specified extended event register bit is set to 1 when the corresponding condition register bit changes from 0 to 1 or from 1 to 0.
NEVer	Always zero.

12.5 Output and Error Queues

Output Queue

The output queue stores query response messages. For example, if you send a `:SOURCE:LEVEL?` command, which requests for the transmission of voltage or current output value, the response message is stored in the output queue until it is read.

As shown below, error messages are stored in order and read from the oldest message first. The output queue is cleared in the following cases.

- When a new message is received from the controller.
- When a deadlock occurs (see section 10.1).
- When a device clear command (DCL or SDC) is received.
- When the 2553A is restarted.

The `*CLS` command does not clear the output queue. You can determine whether or not the output queue is empty by checking bit 4 (MAV) in the status byte.

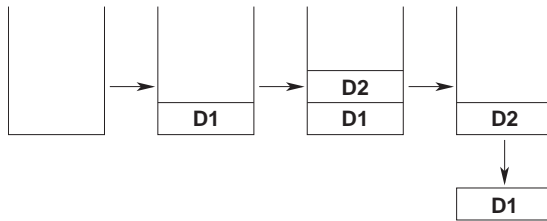

Error Queue

When an error occurs, the error queue stores the error number and message. For example, if the instrument receives an incorrect program message from the controller, the error number (113) and the error message (“Undefined header”) are stored in the error queue when the instrument displays the error message.

You can use the `:STATUS:ERROR?` query to read the contents of the error queue. Like the output queue, the messages in the error queue are read from the oldest one first.

If the error queue overflows, the last message is replaced with the following message: 350, “Queue overflow”

The error queue is cleared in the following cases.

- When a `*CLS` command is received.
- When the 2553A is restarted.

You can determine whether or not the error queue is empty by checking bit 2 (EAV) in the status byte.

13.1 Troubleshooting

Faults and Corrective Actions

If an error code appears on the output display, see section 13.3.

- If servicing is necessary, or if the instrument does not operate properly even after you have attempted to deal with the problem according to the instructions in this section, contact your nearest YOKOGAWA dealer.

Problems and Solutions	Refer To
Nothing appears on the 7-segment LED display when the power is turned on.	
Securely connect the power cord to the 2553A and to the power outlet.	3.3
Set the supply voltage and frequency to within the permitted range.	3.3
The output does not turn on.	
Confirm that the load is within the specified range.	2.1
In the case of resistance sourcing, confirm that the excitation current is within the specified range.	2.1
Confirm that the ambient temperature and humidity are within their specified ranges.	3.2
Check the wiring system.	3.6
Set the output setting within the selectable range. If the setting goes outside the source range when the polarity is changed or if the range or type is changed, the output turns off.	5.3, 6.3
Turn the power off and then on again.	3.4
Dials and switches do not work.	
Check the REMOTE indicator. If the REMOTE indicator is on, flip the OUTPUT switch down to turn off the indicator.	1.1
The source value is odd (common).	
Use the 2553A in a stable environment within the ambient temperature and humidity ranges indicated in the specifications.	3.2
Use the 2553A in an environment free of noise.	3.2
After turning the power on, warm-up the 2553A for at least 30 minutes.	3.4
Check whether the load is an inductive or capacitive load that is within the allowable range.	14.1
The voltage or current source value is odd.	
Confirm that the load is within the specified range.	2.1
While sourcing, keep the output terminal temperature from changing.	3.2, 3.5, 3.6
Be especially careful when using the 10 mV or 100 mV range.	
The source value of thermocouple's thermoelectromotive force is odd.	
Confirm that the load is within the specified range.	2.2
While sourcing, keep the output terminal temperature from changing.	3.2, 3.5, 3.6
Confirm that the reference junction compensation mode is set correctly.	2.2, 6.5
If the RJ sensor 257875 is connected directly to the input terminals of the measuring instrument to be calibrated and the temperature of the terminals is different from the ambient temperature, the temperature imbalance will cause the temperature of the terminals to change. This may prevent accurate reference junction compensation. In such a situation, use a relay terminal block that is at the same temperature as the ambient temperature. However, you will need a thermocouple or compensating lead wire.	Appendix 2
The resistance source value or the RTD's resistance source value is odd.	
Confirm that a correct wiring system, three-wire or four-wire, is being used for the measurement instrument to be calibrated.	Appendix 3
Confirm that the excitation current is within the specified range.	2.1
Unable to write the user definition file.	
Set the USB communication feature to mass storage (STOR).	6.4
Unable to configure or control the instrument through the communication interface.	
Check to make sure that the GP-IB address setting matches the specifications.	7.3
Check to make sure that the TCP/IP settings match the specifications.	8.3
Confirm that the interface meets the electrical and mechanical specifications.	8.1, 7.1

13.2 Error Indication

The polarity or output setting display on the 2553A blinks or turns off if a setting is outside the selectable range or if a setting inconsistent with other settings is specified. This section explains the indications, possible causes, and their corrective actions.

Output

The polarity, output setting, and unit displays are blinking, and the output turns off (when the polarity is changed). The output cannot be turned on.

Cause	The range, temperature type, or polarity change caused the output setting to go outside the selectable range. Examples: <ul style="list-style-type: none">• Changing the range to 30 V when the output setting is 1.20000 V in the 1 V range• Changing the polarity to negative when the temperature type is K and the output setting is 1000.0°C
Correction	Operate an output setting dial. The output setting will change to the maximum setting in the appropriate polarity of the range or temperature type or within the selectable range.

The output setting display shows a blinking “----.-,” and the polarity and unit displays are off.

Cause	The temperature type was set to TC USER or RTD USER when user-defined thermocouple or RTD is not available. For example, this will occur if the user definitions have been deleted with a communication command.
Correction	Set the temperature type to a type other than TC USER or RTD USER, or create user definitions.

The polarity, output setting, and unit displays and the indicator for the selected range or temperature type are blinking. The output remains on, and the maximum value in the range is output.

Cause	The output exceeded the source range. For example, this will occur when the source range of the user-defined output range is exceeded as a result of applying reference junction compensation.
Correction	Change the output setting so that it is within the source range.

An error code is displayed in the 7-segment LEDs for displaying the output setting, and the polarity and unit displays are off. Several error codes may be displayed alternately. The output turns off.

Cause	An overvoltage or overcurrent was detected, and the protection function tripped.
Correction	Eliminate the cause. Then, flip the OUTPUT switch down (OFF) to clear the warning display. Flip the OUTPUT switch up (ON) to clear the warning display and turn the output on.

Reference Junction Compensation

Of the RJC, EXT, and INT indicators, the one that was on is blinking.

Cause The temperature type was set to TC USER or RTD USER when user-defined thermocouple or RTD is not available. (This excludes the case when the reference junction compensation mode is set to manual input (MAN) and the correction value is set to 0.00°C.)
For example, this will occur if the user definitions of thermocouple output have been deleted with a communication command.

Correction Set the temperature type to a type other than TC USER or RTD USER, or create user definitions.

Cause The reference junction temperature setting when the reference junction compensation mode is set to manual input (MAN) or the measured reference junction temperature went outside the range defined by the selected thermocouple type. (This excludes the case when the reference junction compensation mode is set to manual input (MAN) and the correction value is set to 0.00°C.)
For example, this will occur if the thermocouple type is B and the reference junction temperature is -20°C.

* Even if it goes outside the defined range, the 2553A will expand the definition up to the reference junction temperature setting or the measured reference junction temperature and output thermoelectromotive force after applying reference junction compensation.

Correction Set the reference junction temperature within the defined range.

Cause The reference junction temperature setting when the reference junction compensation mode is set to manual input (MAN) or the measured reference junction temperature went outside the range defined by the user definition.

For example, this will occur if the reference junction temperature is set to -20.0 °C when the source range is ±10.0°C in the user definition.

* Even if it goes outside the defined range, the 2553A will assume the reference junction temperature to be 0.00°C (no reference junction compensation) and output thermoelectromotive force after applying reference junction compensation.

Correction Set the reference junction temperature within the user-defined range, or set the user definition that includes the reference junction temperature.

The reference junction compensation setting (polarity, setting, and unit) displays are blinking, and the RJC indicator is also blinking.

Cause The reference junction temperature setting was set outside the range (-20°C to +60°C) when the reference junction compensation mode is manual input (MAN).
For example, this will occur if you change the setting from +60°C to -60°C by changing the polarity.

Correction Operate an output setting dial. The setting will change to the maximum setting in the appropriate polarity or within the selectable range.

The RJC indicator is blinking, and the reference junction temperature display is showing -199.99 or +199.99.

Cause The measured reference junction temperature went outside the range (-20°C to +60°C).
If the measured temperature is less than -20°C, the reference junction temperature display shows -199.99. If the measured temperature is greater than +60°C, the reference junction temperature display shows +199.99.

13.3 Error Code Descriptions and Corrective Actions

This section explains error codes that may appear on the front panel.

Error Codes That Appear at Power-on or during the Self-test

If any of the following error codes appears, servicing is required.

Code	Description
E.911 to E.914	An internal circuit error was detected.

Warning Codes

Code	Description	Corrective Action	Refer To
E.032	Excessive input was detected during resistance sourcing.	Check the connection conditions or load.	3.5, 3.6
E.033	An oscillation error was detected in the voltage or current amplifier.	Check the connection conditions or load.	3.5, 3.6
E.034	An overvoltage load was detected.	Check the connection conditions or load.	3.5, 3.6
E.035	An overcurrent load was detected.	Check the connection conditions or load.	3.5, 3.6
E.040	An error was detected in the user definition file.	Check the syntax.	Appendix 4

13.4 Communication Error Messages

This section explains communication error messages.

- Error messages that are read from a PC such as through the :STATUS:ERROR? command are output in English.
- If servicing is necessary to solve the problem indicated by a message, contact your nearest YOKOGAWA dealer.
- The error messages described here are only those that you can read with the :STATUS:ERROR? command from a PC. For other messages, which are displayed on the front panel, see section 13.3.

Error in communication command (100 to 199)

Code	Message	Corrective Action	Page
102	Syntax error.	A syntax error not covered by error codes 100 to 199.	ch. 10, ch. 11
103	Invalid separator.	Separate data values with a comma.	10-1
104	Data type error.	Use a correct data type.	10-6 and 10-7
108	Parameter not allowed.	Check the number of data values.	10-6 and ch. 11
109	Missing parameter.	Be sure to include all necessary data values.	10-6 and ch. 11
111	Header separator error.	Use a comma to separate each header from its data.	10-1
112	Program mnemonic too long.	Check the command length.	ch. 11
113	Undefined header.	Check the header.	ch. 11
114	Header suffix out of range.	Check the header.	ch. 11
120	Numeric data error.	A value must be specified where the syntax contains <NRf>.	10-6
123	Exponent too large.	Where the syntax contains <NR3>, make the exponent that follows E smaller.	10-6 and ch. 11
124	Too many digits.	Limit numeric values to 255 digits or less.	10-6 and ch. 11
128	Numeric data not allowed.	Use a data type other than <NRf>.	10-6 and ch. 11
131	Invalid suffix.	Check the unit of <Voltage>, <Current>, <Resistance>, <Temperature>, or <Time>.	10-6
134	Suffix too long.	Check the unit of <Voltage>, <Current>, <Resistance>, <Temperature>, or <Time>.	10-6
138	Suffix not allowed.	Units other than <Voltage>, <Current>, <Resistance>, <Temperature>, and <Time> cannot be used.	10-6
141	Invalid character data.	Be sure to select one of the listed choices when the syntax contains {...}.	ch. 10, ch. 11
144	Character data too long.	Check the spelling of the strings when the syntax contains {...}.	ch. 11
148	Character data not allowed.	Use a data type other than {...}.	ch. 11
150	String data error.	Enclose parameters with single or double quotation marks where the syntax contains <String>.	10-7
151	Invalid string data.	The <String> is either too long, or it contains an unusable character.	ch. 11
158	String data not allowed.	Use a data type other than <String>.	ch. 11
161	Invalid block data.	<Block data> cannot be used.	10-7 and ch. 11
168	Block data not allowed.	<Block data> cannot be used.	10-7 and ch. 11
171	Missing Right	Mathematical operations cannot be used.	—
172	Invalid expression.	Mathematical operations cannot be used.	ch. 11
178	Expression data not allowed.	Mathematical operations cannot be used.	ch. 11
181	Invalid outside macro definition.	The 2553A does not support the IEEE 488.2 macro specifications.	—

Error in communication execution (200 to 299)

Code	Message	Corrective Action	Page
203	Command protected	See "Adjustment and Calibration" in section 13.10.	13-14
221	Setting conflict.	Check settings that are related to each other.	ch. 11
222	Data out of range.	Check the ranges of the settings.	ch. 11
223	Too much data.	Check data byte lengths.	ch. 11
224	Illegal parameter value.	Check the ranges of the settings.	ch. 11
225	OverFlow.	Keep program messages to 1024 bytes or less in length, 10-2 including <PMT>.	
226	Out Of Memory.	Keep program messages to 1024 bytes or less in length, 10-2 including <PMT>.	
241	Hardware missing.	Check that the specified options are all installed.	—
260	Expression error.	Mathematical operations cannot be used.	—
270	Macro error.	The 2553A does not support the IEEE 488.2 macro specifications.	—
272	Macro execution error.	The 2553A does not support the IEEE 488.2 macro specifications.	—
273	Illegal macro label.	The 2553A does not support the IEEE 488.2 macro specifications.	—
275	Macro definition too long.	The 2553A does not support the IEEE 488.2 macro specifications.	—
276	Macro recursion error.	The 2553A does not support the IEEE 488.2 macro specifications.	—
277	Macro redefinition not allowed.	The 2553A does not support the IEEE 488.2 macro specifications.	—
278	Macro header not found.	The 2553A does not support the IEEE 488.2 macro specifications.	—

Error in communication Query (400 to 499)

Code	Message	Corrective Action	Page
410	Query INTERRUPTED.	Check the transmission and reception order.	10-2
420	Query UNTERMINATED.	Check the transmission and reception order.	10-2
430	Query DEADLOCKED.	Keep program messages to 1024 bytes or less in length, 10-2 including <PMT>.	
440	Query UNTERMINATED after indefinite response.	Do not write a query after *IDN? or *OPT?.	—

Error in System Operation (300, 399)

Code	Message	Corrective Action	Page
300	Communication device-specific error.	Servicing is required.	—
399	Fatal error in the communication driver.	Servicing is required.	—

Warning (50)

Code	Message	Corrective Action	Page
50	*OPC/? exists in message.	Write *OPC or *OPC? at the end of program messages.	—

Other Error (350)

Code	Message	Corrective Action	Page
350	Queue overflow.	Read the error queue.	12-6

Note

Code 350 occurs when the error queue overflows.

Execution Errors (800 to 899)

Code	Message	Corrective Action	Page
802	Invalid command.	CAL on the SETUP menu cannot be executed during adjustment mode.	4-2
804	Invalid command.	Cannot be executed because the communication command type is set to COMP (compatible mode).	7-7
805	Invalid command.	Communication commands cannot be executed because — the RANGE dial is set to SETUP.	

System Errors (900/999)

Code	Message	Corrective Action	Page
911 to 999	CPU board error.	For details about the message and corrective action, see section 13.3.	13-4

13.5 Displaying the Error Log

Procedure

Displaying the Error Log Menu

1. Turn the **RANGE** dial to select SETUP.
The SETUP menu appears.

1. Select **SETUP**.
The SETUP indicator turns on.

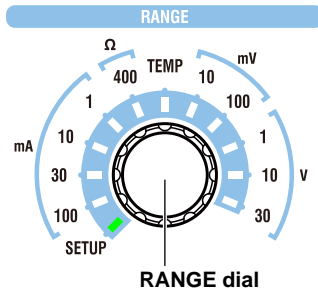

2. Turn an **output setting** dial to select ERROR.
The error log menu appears.

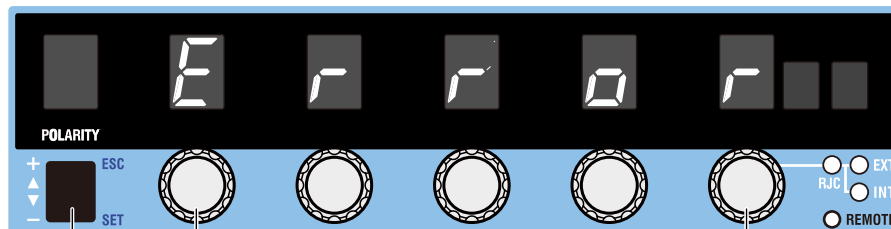

3. Display the error log menu.
2. Select **ERROR**.

Displaying the Error Log

4. Turn an **output setting** dial to select LOG.
If there are no error log entries, NO is displayed.
If there are, an error code and log number are displayed. If there are multiple logged errors, turn the **output setting** dial to select a log number. The error code corresponding to the log number will be displayed.

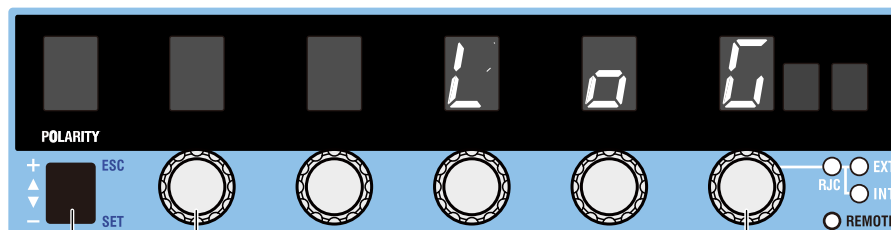

5. Display the error log.
4. Select **LOG**.

Clearing the Error Log

4. Turn an **output setting** dial to select CLEAR.
5. Flip the **POLARITY** switch down.
EXEC appears.
6. Flip the **POLARITY** switch down again.
The error log will be cleared.

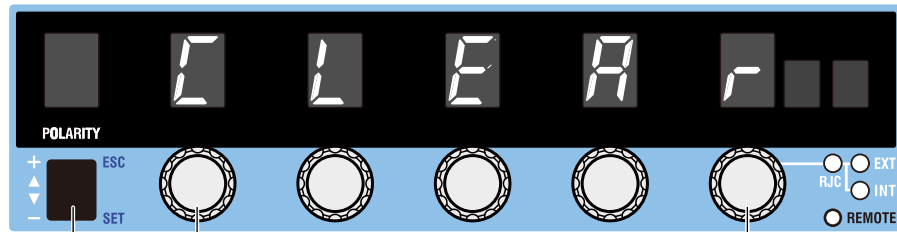

Note

Once you clear the error log, you cannot undo it. Confirm that it is okay to perform such operation before execution.

Explanation

Displaying the Error Log

The error log can be displayed.

- If there are no error log entries, NO is displayed.



- If there are, an error code and log number are displayed. If there are multiple logged errors, you can turn the output setting dial to select a log number. The error code corresponding to the log number will be displayed. Log numbers are assigned in chronological order.

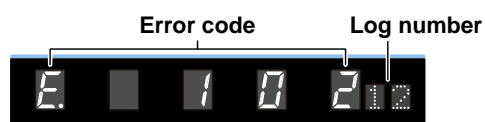

Note

- For details on error codes, see sections 13.3 and 13.4.
- The warning codes in section 13.3 are not logged, so they do not appear in the error log.
- Log numbers range from 1 to 64. Up to 64 errors can be logged. If more than 64 errors occur, communication error code 350 will occur. Check by connecting the 2553A to a PC through a communication interface.

Clearing the Error Log

You can clear the error log. When you clear the error log, every entry is cleared. Once you delete the error log, you cannot recover it.

13.6 Instrument Error Detection and Clearance

Warning Detection (Trip detection)

If an overvoltage load, overcurrent load, or excessive input is detected, the output automatically turns off (trips). If tripping occurs, a warning code is displayed. Check the connection conditions or load, and eliminate the cause. For details on warning codes, see section 13.3.

Clearing the Warning

If a warning is detected and the 2553A trips, eliminate the cause, and then clear the warning display.

- Flip the OUTPUT switch down (OFF) to clear the warning display.
- Flip the OUTPUT switch up (ON) to clear the warning display and turn the output on.

13.7 Self-Test

Procedure

1. Turn the **RANGE** dial to select SETUP.
The SETUP menu appears.

1. **Select SETUP.**
The SETUP indicator turns on.

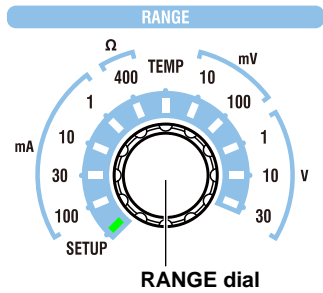

2. Turn an **output setting** dial to select TEST.
3. Flip the **POLARITY** switch down.
EXEC appears.
4. Flip the **POLARITY** switch down again.
The self-test starts.

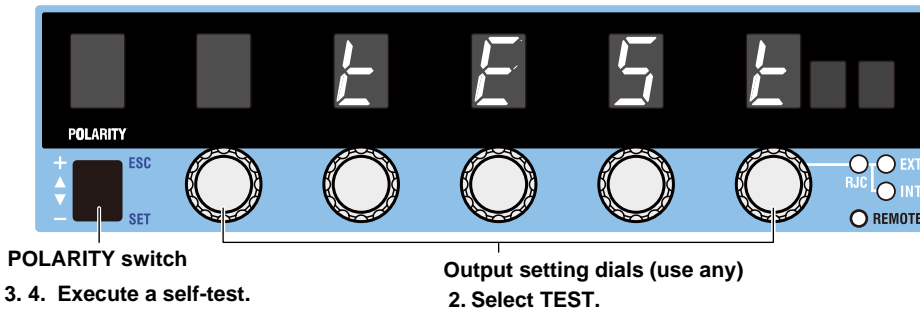

Explanation

You can execute a self-test. While the self-test is in progress, a test number is displayed.

- When a self-test completes successfully, "DONE" will be displayed.



- If an error is detected, an error code will be displayed.

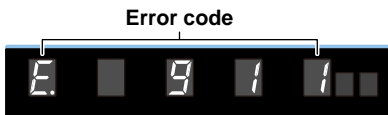

Note

- For details on error codes, see section 13.3.
- If multiple errors occur, the error codes are displayed alternately.

13.8 Initializing the Settings

Procedure

1. Turn the **RANGE** dial to select SETUP.
The SETUP menu appears.

1. **Select SETUP.**
The SETUP indicator turns on.

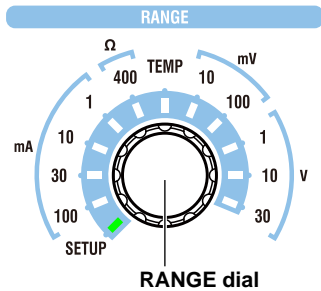

2. Turn an **output setting** dial to select INIT.
3. Flip the **POLARITY** switch down.
EXEC appears.
4. Flip the **POLARITY** switch down again.
The 2553A settings are initialized.

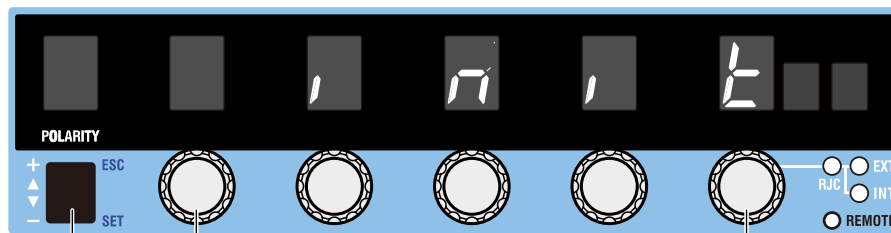

POLARITY switch

Output setting dials (use any)

3. 4. Execute initialization.

2. Select INIT.

Note

You cannot undo an initialization. Confirm that it is okay to perform this operation before execution.

Explanation

You can reset the settings to their factory default values. Communication settings and a portion of other settings are not initialized. For details on the items that are initialized, see appendix 5.

13.9 Displaying the Product Information

Procedure

1. Turn the **RANGE** dial to select SETUP.
The SETUP menu appears.

1. **Select SETUP.**
The SETUP indicator turns on.

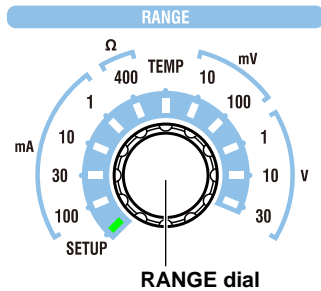

2. Turn an **output setting** dial to select INFO.
3. Flip the **POLARITY** switch down.
The product information menu appears.

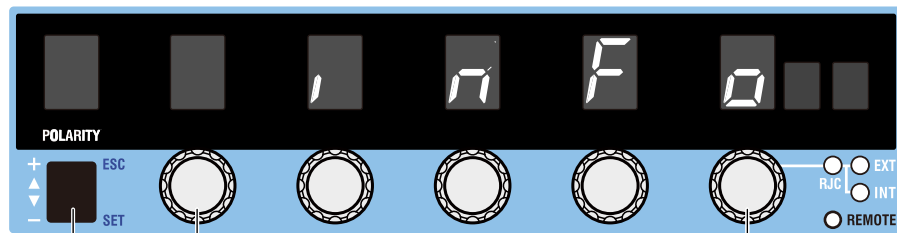

POLARITY switch

Output setting dials (use any)

3. Display the product information menu.

2. Select INFO.

4. Turn an **output setting** dial to select the product information you want displayed. Select FIRM, LOGIC1, LOGIC2, BOOT, or SER.NO.

If you selected FIRM, LOGIC1, LOGIC2, or BOOT in step 4, proceed to step 5.

If you selected SER.NO in step 4, proceed to step 6.

If You Selected FIRM, LOGIC1, LOGIC2, or BOOT in Step 4

5. Flip the **POLARITY** switch down.
The selected product information is displayed.

Display Example

Selected LOGIC1 in step 4



Displays the LOGIC1 version



Flip the POLARITY switch down.

Proceed to step 8.

If You Selected SER.NO in Step 4

6. Flip the **POLARITY** switch down.
The serial number (instrument number) appears.
7. Turn an **output setting** dial to display the remaining serial number that was not displayed in step 6.

Display Example

Selected SER.NO in step 4



Displays the serial number



Flip the POLARITY switch down.

Turning an output setting dial to the left shows the higher digits of the serial number.
Turning an output setting dial to the right shows the lower digits of the serial number.

8. To display other product information, flip the **POLARITY** switch up.
The menu returns to the previous level.
9. Repeat steps 4 to 8 to display the product information.

Explanation

Firmware (FIRM), Logic (LOGIC1 and LOGIC2) and Boot (BOOT) Information

The version of each program for controlling the 2553A system is displayed. You may need to check these when you update or repair the system.

Serial Number (SER.NO)

You can view the 2553A serial number (instrument number).

The serial number is a combination of alphabet letters and numbers. When communicating with another device through USB, use uppercase letters to specify the serial number.

13.10 Calibration and Adjustment

Calibration

We recommend that you calibrate the 2553A once a year to maintain its accuracy (1 year accuracy). Contact your nearest YOKOGAWA dealer to have your 2553A calibrated.

Adjustment

Contact your nearest YOKOGAWA dealer to have your 2553A adjusted. You can also adjust the 2553A by yourself. Have a qualified engineer adjust the 2553A at a facility with sufficient precision. A manual explaining the simple adjustment procedure of the 2553A is available for downloading from the following webpage. To download the information, you need to register.

<http://tmi.yokogawa.com/products/generators-sources/standard/precision-dc-calibrator-2553a/>

14.1 Source Section

DC Voltage Source

Range	Source Range	Resolution	Maximum Output Current	Output Resistance
10 mV	±12.0000 mV	100 nV	-	Approx. 1 Ω
100 mV	±120.000 mV	1 μV	10 mA or higher	10 mΩ or lower
1 V	±1.20000 V	10 μV	Approx. 120 mA	10 mΩ or lower
10 V	±12.0000 V	100 μV	Approx. 120 mA	10 mΩ or lower
30 V	± 32.000 V	1 mV	Approx. 30 mA	10 mΩ or lower

Range	Stability (1h) ¹ ±(ppm of setting + μV)	Accuracy (180 days) ² ±(ppm of setting + μV)	Accuracy (1 year) ² ±(ppm of setting + μV)	Temperature Coefficient ±(ppm of setting + μV)/°C
10 mV	20 + 3	40 + 4	60 + 4	10 + 0.1
100 mV	20 + 3	40 + 4	60 + 4	5 + 0.3
1 V	5 + 10	40 + 10	60 + 15	3 + 1.5
10 V	5 + 100	40 + 100	60 + 150	3 + 15
30 V	5 + 300	40 + 300	60 + 450	3 + 45

- 1 Specifications under standard operating conditions but at an ambient temperature of 23°C±1°C.
- 2 Specifications under standard operating conditions. If the ambient temperature is between 5°C to 18°C or 28°C to 40°C, add the temperature coefficient compensation to the accuracy. Immediately after sinking current that exceeds 30 mA, errors exceeding the accuracy specifications may occur due to the increased temperature inside the 2553A.

Range	Output Noise	
	0.1 Hz to 10 Hz	10 Hz to 10 kHz
10 mV	1 μVrms	10 μVrms
100 mV	2 μVrms	10 μVrms
1 V	2 μVrms	20 μVrms
10 V	15 μVrms	30 μVrms
30 V	20 μVrms	50 μVrms

DC Current Source

Range	Source Range	Resolution	Maximum Output Voltage	Output Resistance
1 mA	±1.20000 mA	10 nA	Approx. 15 V	100 MΩ or higher
10 mA	±12.0000 mA	100 nA	Approx. 15 V	100 MΩ or higher
30 mA	± 32.000 mA	1 μA	Approx. 30 V	10 MΩ or higher
100 mA	±120.000 mA	1 μA	Approx. 15 V	10 MΩ or higher

Range	Stability (1h) ¹ ±(ppm of setting + μA)	Accuracy (180 days) ² ±(ppm of setting + μA)	Accuracy (1 year) ² ±(ppm of setting + μA)	Temperature Coefficient ±(ppm of setting + μA)/°C
1 mA	5 + 0.015	50 + 0.03	80 + 0.04	3 + 0.0015
10 mA	5 + 0.15	70 + 0.4	100 + 0.5	5 + 0.015
30 mA	10 + 0.9	70 + 1.2	100 + 1.5	7 + 0.045
100 mA	10 + 3	70 + 4	100 + 5	10 + 0.15

- 1 Specifications under standard operating conditions but at an ambient temperature of 23°C±1°C.
- 2 Specifications under standard operating conditions. If the ambient temperature is between 5°C to 18°C or 28°C to 40°C, add the temperature coefficient compensation to the accuracy. Immediately after sinking current that exceeds 30 mA, errors exceeding the accuracy specifications may occur due to the increased temperature inside the 2553A.

Range	Output Noise	
	0.1 Hz to 10 Hz	10 Hz to 10 kHz
1 mA	0.015 μArms	0.5 μArms
10 mA	0.03 μArms	1 μArms
30 mA	0.05 μArms	2 μArms
100 mA	0.3 μArms	10 μArms

14.1 Source Section

Resistance Source

Range	Source Range	Resolution	Excitation Current
400 Ω	18.00 Ω to 400.00 Ω	0.01 Ω	0.5 mA to 2 mA

Range	Stability (1h) ¹ \pm (ppm of setting + Ω)	Accuracy (180 days) ² \pm (ppm of setting + Ω)	Accuracy (1 year) ² \pm (ppm of setting + Ω)	Temperature Coefficient $\pm\Omega/^\circ\text{C}$
400 Ω	5 + 0.005	55 + 0.015	75 + 0.015	0.002

- 1 Specifications under standard operating conditions but at an ambient temperature of $23^\circ\text{C}\pm 1^\circ\text{C}$ and excitation current of 1 mA.
- 2 Specifications under standard operating conditions. If the ambient temperature is between 5°C to 18°C or 28°C to 40°C , add the temperature coefficient compensation to the accuracy.

Thermocouple Thermoelectromotive Force Source

The 2553A sources thermoelectromotive force that corresponds to the specified temperature.

Type	Source Range	Resolution	Output Resistance
R	-50°C to $+1768^\circ\text{C}$	0.1 $^\circ\text{C}$	Approx. 1 Ω
S	-50°C to $+1768^\circ\text{C}$	0.1 $^\circ\text{C}$	Approx. 1 Ω
B	0°C to $+1820^\circ\text{C}$	0.1 $^\circ\text{C}$	Approx. 1 Ω
J	-210°C to $+1200^\circ\text{C}$	0.1 $^\circ\text{C}$	Approx. 1 Ω
T	-270°C to $+400^\circ\text{C}$	0.1 $^\circ\text{C}$	Approx. 1 Ω
E	-270°C to $+1000^\circ\text{C}$	0.1 $^\circ\text{C}$	Approx. 1 Ω
K	-270°C to $+1300^\circ\text{C}$	0.1 $^\circ\text{C}$	Approx. 1 Ω
N	-270°C to $+1300^\circ\text{C}$	0.1 $^\circ\text{C}$	Approx. 1 Ω
C	0°C to $+2315^\circ\text{C}$	0.1 $^\circ\text{C}$	Approx. 1 Ω
A	0°C to $+2500^\circ\text{C}$	0.1 $^\circ\text{C}$	Approx. 1 Ω
TC USER (user-defined)	-9999.9°C to $+9999.9^\circ\text{C}$	0.1 $^\circ\text{C}$	Approx. 1 Ω

Compliant thermocouple standards JIS C1602 R, S, B, J, T, E, K, N
 IEC 60584-1 R, S, B, J, T, E, K, N, C, A

Accuracies are shown in the following table.

Type	Set Temperature $^\circ\text{C}$	Stability (1h) ¹ $\pm^\circ\text{C}$	Accuracy (1 year) ² $\pm^\circ\text{C}$	Temp. Coefficient $\pm(\times 10^{-3}\text{C})/^\circ\text{C}$	RJC Error ³ $\pm^\circ\text{C}$
R	-50	0.50	1.10	0.88	0.56
	0	0.30	0.80	0.00	0.41
	100	0.25	0.55	0.88	0.28
	600	0.15	0.40	3.40	0.19
	1600	0.15	0.40	8.52	0.16
S	1768	0.20	0.45	8.69	0.18
	-50	0.40	1.03	0.93	0.52
	0	0.30	0.75	0.00	0.38
	100	0.25	0.56	0.90	0.28
	400	0.20	0.47	3.43	0.22
B	1600	0.20	0.44	8.54	0.18
	1768	0.20	0.51	10.46	0.20
	400	0.40	1.00	0.90	0.04
	600	0.30	0.70	1.75	0.03
	1000	0.20	0.50	3.40	0.02
J	1200	0.20	0.44	4.27	0.02
	1820	0.20	0.44	6.91	0.02
	-210	0.10	0.25	2.83	0.84
	-100	0.05	0.11	0.86	0.40
	0	0.05	0.08	0.00	0.32
T	1200	0.10	0.15	6.68	0.29
	-250	0.30	0.72	5.98	2.13
	-200	0.15	0.29	2.55	0.86
	-100	0.10	0.16	0.86	0.50
	100	0.05	0.10	0.85	0.30
	400	0.05	0.09	1.92	0.22

Type	Set Temperature °C	Stability (1h) ¹ ±°C	Accuracy (1 year) ² ±°C	Temp. Coefficient ±(×10 ⁻³ °C)/°C	RJC Error ³ ±°C
E	-250	0.20	0.50	5.95	2.07
	-200	0.10	0.20	2.56	0.82
	-100	0.05	0.10	0.85	0.44
	0	0.05	0.07	0.00	0.34
	1000	0.05	0.12	5.53	0.27
K	-250	0.40	0.94	7.71	2.65
	-200	0.15	0.30	2.55	0.84
	-100	0.10	0.15	0.86	0.44
	0	0.05	0.11	0.00	0.35
	800	0.10	0.15	4.26	0.32
N	1300	0.10	0.21	7.67	0.38
	-240	0.40	1.00	5.10	1.99
	-200	0.20	0.44	2.55	0.87
	-100	0.10	0.21	0.86	0.43
	0	0.10	0.16	0.00	0.34
C	800	0.10	0.15	3.92	0.22
	1300	0.10	0.20	7.32	0.25
	0	0.15	0.30	0.00	0.34
	200	0.10	0.26	1.72	0.27
	600	0.10	0.25	3.40	0.24
A	1000	0.15	0.30	6.81	0.25
	2000	0.20	0.51	15.30	0.37
	2315	0.25	0.70	20.72	0.51
	0	0.15	0.34	0.00	0.35
	100	0.10	0.29	0.87	0.29
A	600	0.10	0.28	3.42	0.25
	1600	0.15	0.47	11.09	0.35
	2500	0.20	0.79	22.67	0.54

Type	Source Voltage Range	Stability (1h) ⁴ ±(ppm of setting + μV)	Accuracy (1 year) ⁵ ±(ppm of setting + μV)	Temperature Coefficient ±(ppm of setting + μV)/°C
TC USER	± 120.000 mV	20 + 3	60 + 4	5 + 0.3

- Specifications without using the reference junction compensation feature (0.00°C in manual input mode), under standard operating conditions, but at an ambient temperature of 23°C±1°C.
- Specifications without using the reference junction compensation feature (0.00°C in manual input mode), under standard operating conditions. If the ambient temperature is between 5°C to 18°C or 28°C to 40°C, add the temperature coefficient compensation to the accuracy.
- If the reference junction compensation feature is used, when the input terminal temperature is balanced, add the reference junction compensation error to the accuracy for every ±0.3°C of reference junction temperature measurement error.
 - The 2553A's internal reference junction temperature measurement accuracy is ±0.3°C.
 - The external reference junction temperature measurement accuracy when the RJ sensor 257875 (sold separately) is used with the 2553A is ±0.3°C (typical value).
- Specifications under standard operating conditions but at an ambient temperature of 23°C±1°C.
- Specifications under standard operating conditions. If the ambient temperature is between 5°C to 18°C or 28°C to 40°C, add the temperature coefficient compensation to the accuracy.
 - Does not include the thermocouple error.
 - The stability and accuracy for the temperatures between the set temperatures are those obtained by linear interpolation.
 - To add the temperature coefficient compensation or the reference junction compensation error to the accuracy figure for a temperature between the set temperatures, linearly interpolate the accuracies obtained after adding the compensation.
 - The thermoelectromotive force for temperatures not listed in the table will be ±(60ppm of V_T + 4 μV) with respect to standard thermoelectromotive force V_T of the interpolating polynomial of IEC 60584-1.
 - On models with the -UF suffix code, °F display is possible. Convert the source range, set temperature, stability, accuracy, temperature coefficient, and reference junction compensation error using the following expression. The resolution is 0.1°F.

$$^{\circ}\text{F} = \frac{9}{5} \times (^{\circ}\text{C}) + 32$$

14.1 Source Section

RTD Resistance Source

The 2553A sources resistance that corresponds to the specified temperature.

Type	Source Range	Resolution	Excitation Current
Pt100	-200.0°C to +850.0°C	0.1°C	0.5 mA to 2 mA
RTD USER (user-defined)	-9999.9°C to +9999.9°C	0.1°C	0.5 mA to 2 mA

Compatible RTD standards	JIS C1604 IEC 60751-1	Pt100 Pt100
--------------------------	--------------------------	----------------

Type	Accuracy (180 days)* ±°C	Accuracy (1 year)* ±°C	Temperature Coefficient ±°C/°C
Pt100	0.1	0.15	0.006

* Specifications under standard operating conditions. If the ambient temperature is between 5°C to 18°C or 28°C to 40°C, add the temperature coefficient compensation to the accuracy.

Output Terminals

Item	Specifications
Terminal type	Binding posts, equipped with a HI (red) and a LO (black) output terminal
Maximum common-mode voltage	±42 Vpk between output terminals and the case

Response Time

Item	Specifications
Voltage or current source	500 ms or less (Time for the setting to change from 0% to ±100% of each range at no load. The time from when the change starts to when the setting reaches 0.01% of the final setting.)
Resistance or RTD source	0.1 ms or less (time constant corresponding to the change in excitation current)

LC Load (Voltage or Current Source)

Item	Specifications
Inductive (L) load	1 mH or less
Capacitive (C) load	10 µF or less

Common Mode Rejection Ratio (Voltage or Current Source)

Item	Specifications
Voltage output	120 dB or higher (for DC or 50/60 Hz signal)
Current output	0.1 µA/V or higher (for DC or 50/60 Hz signal)

14.2 Functions

Item	Specifications
Source range	Numerous ranges are available for DC voltage, DC current, resistance, temperature (thermocouple and RTD).
Output display	Value: 5.5 digits Polarity: + or – Unit: mV, V, mA, Ω, °C, °F °F is available on models with the -UF suffix code.
Reference junction compensation (RJC) (Thermocouple thermoelectromotive force source)	The following three modes are available. The 2553A corrects the sourced thermoelectromotive force (RJC) according to the selected mode. Auto (AUTO) If an external RJ sensor is detected, a correction is performed using the measured temperature of the external RJ sensor. Otherwise, a correction is performed using the temperature of the 2553A output terminals (internal). For the accuracy specifications when RJ sensor 257875 is used and other specifications of the 257875, see section 14.6. Internal (INT): A correction is performed using the temperature of the 2553A output terminals (internal). For the specifications of the 2553A's internal reference junction temperature measurement accuracy and reference junction compensation errors, see section 14.1. Manual input (MAN): A correction is performed using a manually input temperature. You can set the temperature from the 2553A front panel (see section 6.5 and chapter 4). To not apply correction, set the temperature to 0.00°C. Selectable range: –20.00°C to +60.00°C
User definitions	Thermocouple Thermoelectromotive force corresponding to the set temperature can be sourced according to the user-defined polynomial. RTD Resistance corresponding to the set temperature can be sourced according to the user-defined polynomial.
Saving setup parameters	Saves setup parameters immediately before (approx. 1 s before) the power switch is turned off. The next time the power is turned on, the 2553A starts with those settings.
Error log	Logs the error codes of the errors that the 2553A detects. The error log can also be displayed.
Self-test	Performs a self-test on its condition.
Initialization	Resets the 2553A to its factory default settings.
Product information display	Displays the firmware version, serial number, and the like.
Communication	Communication commands can be used to remotely control the 2553A. Select the communication interface from GP-IB, Ethernet, and USB.
Instrument protection	Trip function based on overvoltage, overcurrent, and oscillation detection are available.

14.3 External Input

Item	Specifications
External RJ sensor input terminal	Supports three-wire and four-wire systems
Input connector	Connect the supplied terminal plug A2119JT. The input terminals of the terminal plug A2119JT are screw type. Connect an RJ sensor 257875 or a general RTD Pt100 to the terminal plug A2119JT.
Excitation current	Approx. 1 mA

14.4 Computer Interface

GP-IB

Item	Specifications
Electrical and mechanical	Complies with IEEE St'd 488-1978
Functional specifications	SH1, AH1, T6, L4, SR1, RL1, PP0, DC1, DT1, and C0
Protocol	Complies with IEEE St'd 488.2-1992
Address	0 to 30

Ethernet

Item	Specifications
Number of ports	1
Connector type	RJ-45 connector
Electrical and mechanical	Conforms to IEEE 802.3
Transmission system	Ethernet(100BASE-TX/10BASE-T)
Transfer rate	100 Mbps max.
Protocol	TCP/IP
Supported services	VXI-11 server, DHCP client

USB for PC Connection

Item	Specifications
Number of ports	1
Connector type	Type B connector (receptacle)
Electrical and mechanical	Conforms to USB Revision 2.0
Supported transfer modes	HS (High Speed; 480 Mbps) and FS (Full Speed; 12 Mbps)
Supported protocols	USBTMC-USB488 (USB Test and Measurement Class Ver.1.0) GP-IB commands can be used through USB. Mass Storage Class Ver. 1.1 The 2553A can be accessed from a PC.

14.5 General Specifications

Item	Specifications
Standard operating conditions	Ambient temperature: 23°C±5°C Ambient humidity: 20%RH to 80% RH (no condensation) After warm-up time has passed
Warm-up time	Approx. 30 minutes (after acclimatizing the 2553A to the operating environment for at least an hour) If the instrument has been stored in a hot-temperature, high-humidity environment, warm up the instrument for at least a day.
Operating environment	Temperature: 5°C to 40°C Humidity: 20%RH to 80% RH (no condensation) 20% RH to 70% RH for ambient temperatures above 30°C
Storage environment	Temperature: -15°C to 60°C Humidity: 20%RH to 80% RH (no condensation)
Operating altitude	2000 m or less
Installation location	Indoors
Installation orientation	Horizontal or tilted using the movable leg
Rated supply voltage	100 VAC to 120 VAC, 200 VAC to 240 VAC
Permitted supply voltage range	90 VAC to 132 VAC, 180 VAC to 264 VAC
Rated supply frequency	50 Hz/60 Hz
Permitted power supply frequency range	48 Hz to 63 Hz
Maximum power consumption	Approx. 30 VA
Withstand voltage	1500 VAC for 1 minute between the power supply and case For the withstand voltage between the measurement section and case for the external RJ sensor 257875 when it is connected, see section 14.6.
Insulation resistance	100 MΩ or higher at 500 VDC between the power supply and case 100 MΩ or higher at 500 VDC between the output terminals and case
External dimensions	213 mm (W) × 132 mm (H) × 300 mm (D), excluding protrusions
Weight	Approx. 3 kg
Safety standard	Compliant standard EN61010-1 Overvoltage Category II ¹ Pollution degree 2 ² EN61010-2-030 Measurement category: Other (O) ³
Emissions	Compliant standards EN61326-1 Class A EN55011 class A, group 1 EMC standards of Australia and New Zealand EN 55011 Class A, Group 1 Korea Electromagnetic Conformity Standard (한국 전자파적합성기준) EN61000-3-2 EN61000-3-3 This product is a Class A (for industrial environment) product. Operation of this product in a residential area may cause radio interference in which case the user will be required to correct the interference.
	Test conditions Voltage output: 12 V output at the 10 V range setting, load: 100 Ω
	Cable conditions GP-IB connector (GP-IB) Use a shielded cable that is 3 m in length or less. Ethernet port (ETHERNET) Use a category 5 or better Ethernet cable (STP) that is 30 m in length or less. USB port for PCs (USB) Use a shielded USB cable that is 3 m in length or less. Output terminals (HI, LO) Use the included 366961 measurement leads (length: 1.2 m). External RJ sensor terminal (EXT RJ SENSOR Pt100) Use the RJ sensor 257875, sold separately.

14.5 General Specifications

Item	Specifications
Immunity	Compliant standards
	EN61326-1 Table 2 (for use in industrial locations)
	Influence in the immunity test environment
	Within $\pm 15\%$ of the range setting
Test conditions	18 Ω at the resistance output range setting
	All other settings are at factory default.
	Cable conditions
	Same as the emission cable conditions.
Environmental standard	Compliant standard
	EN50581 Monitoring and control instruments

- 1 The overvoltage category (installation category) is a value used to define the transient overvoltage condition and includes the rated impulse withstand voltage. The overvoltage category II applies to electrical equipment that is powered through a fixed installation, such as a switchboard.
- 2 Pollution degree refers to the degree of adhesion of a solid, liquid, or gas which deteriorates withstand voltage or surface resistivity. Pollution degree 2 applies to normal indoor atmospheres (with only non-conductive pollution).
- 3 The measurement category of the 2553A terminals is Other (O). Do not use it to measure the main power supply or for Measurement Categories II, III, and IV.
Measurement category O applies to measurement of circuits that are not directly connected to a main power source. This category applies to measurement of secondary electric circuits in equipment across a transformer. The estimated transient overvoltage that may appear at the 2553A signal input terminals is 1500 V.
Measurement category II applies to measurement of circuits, such as household electric appliances and portable electric tools, that are connected to low-voltage installations.
Measurement category III applies to measurement of facility circuits, such as distribution boards and circuit breakers.
Measurement category IV applies to measurement of power source circuits, such as entrance cables to buildings and cable systems, for low-voltage installations.

14.6 RJ Sensor 257875 Specifications

Item	Specifications
Measurement range	-20°C to +60°C
Accuracy	±0.3°C (typical value), in combination with the 2553A
Excitation current	Approx. 1 mA
Withstand voltage	100 VAC for 1 minute between the 257875 measurement section and the 2553A case (Withstand voltage when the sensor is connected to the 2553A's external RJ sensor input terminal)
Cord length	Approx. 1.95 m

- Only connect the RJ sensor 257875 to the 2553A or other designated instruments.
- If the RJ sensor 257875 is connected directly to the input terminals of the measuring instrument to be calibrated and the temperature of the terminals is different from the ambient temperature, the temperature imbalance will cause the temperature of the terminals to change. This may prevent accurate reference junction compensation.

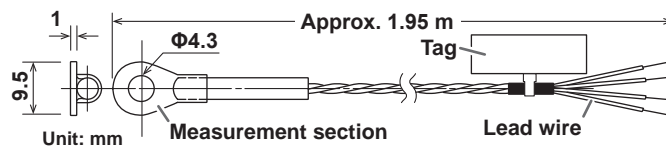

14.7 External Dimensions

Unit: mm

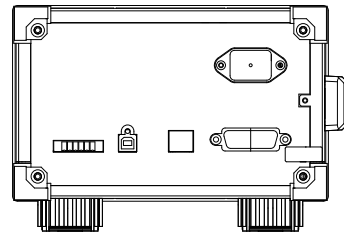
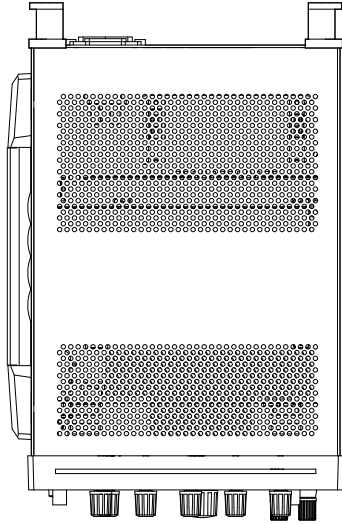

Rear view

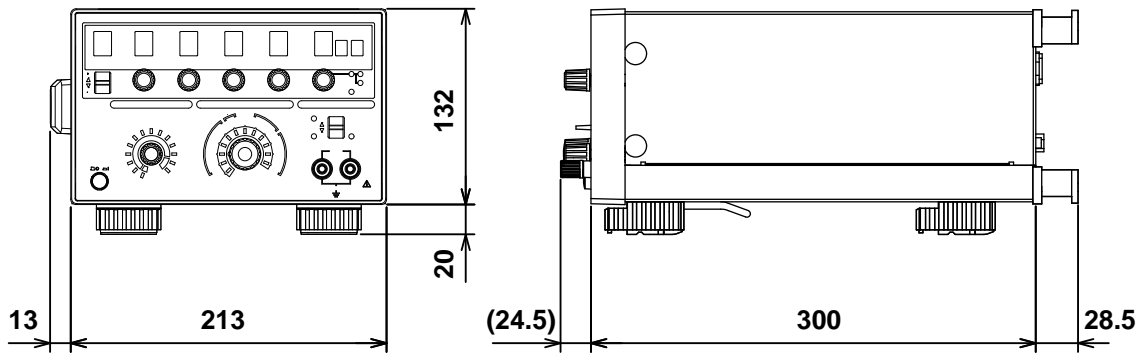

Unless otherwise specified, tolerances are $\pm 3\%$ (however, tolerances are ± 0.3 mm when below 10 mm).

Appendix 1 Block Diagram

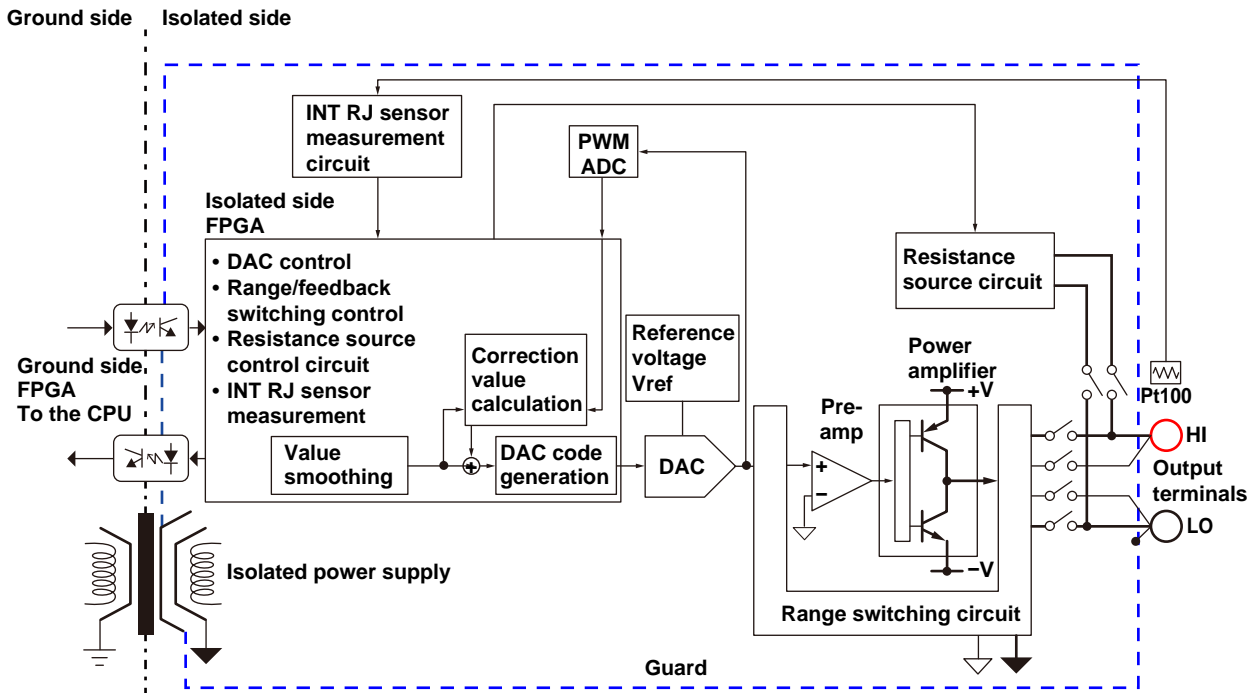

When the output is turned on or when the source value is changed, a source code for setting the DAC is sent from the CPU/FPGA on the ground side to the FPGA on the isolated side. To the source code, the FPGA on the isolated side applies overshoot suppression and rising slope control (smoothing) for reducing inrush current for when a capacitive load is connected. Then, the FPGA sends the source code to the DAC.

On the other hand, the high-speed PWM ADC is sequentially measuring reference voltage V_{ref} , the zero level (circuit ground), and the output of its own DAC. The source code is compared and corrected with these values and continuously transferred from the FPGA on the isolated side to the DAC. This method provides stable DAC output.

The amplifier output is connected to the HI terminal side during voltage sourcing and LO terminal during current sourcing. The pre-amp employs a low-noise, high-precision amplifier that accurately amplifies the DAC output. The power amplifier employs a power-transistor-based push-pull-output amplifier that enables sink operation.

The 2553A does not use relays to invert the polarity, so glitches due to polarity switching do not occur. The isolated side is surrounded by a guard potential to suppress the effects of common-mode noise. The guard is connected to the LO terminal.

Appendix 2 Thermocouple Calibration Wiring Examples

Thermocouple calibration wiring examples are shown below.

When Using 0°C Reference Junction Wiring Example

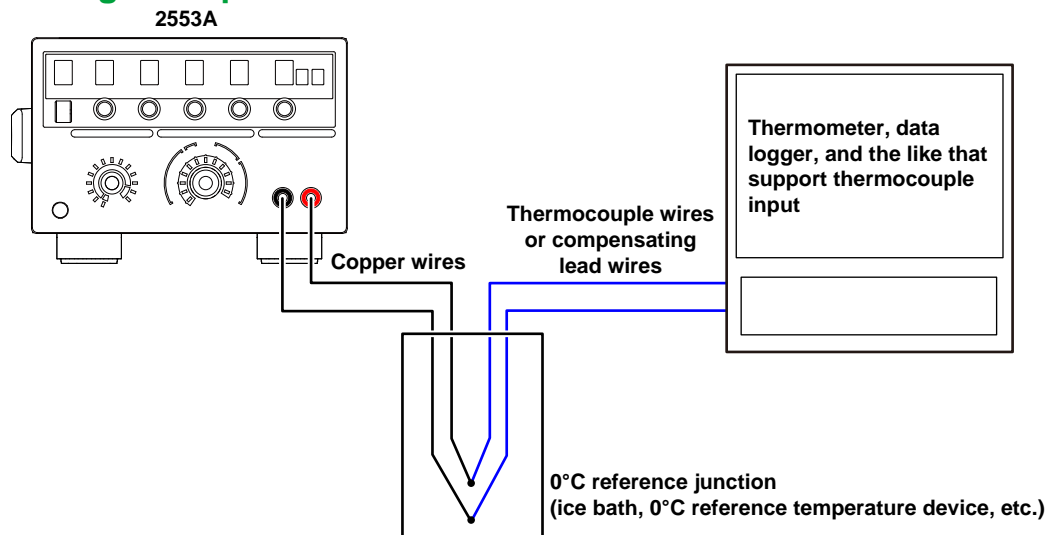

Configuring the 2553A

1. Set the reference junction compensation mode to manual input (MAN) and the reference junction temperature to 0.00°C.
For details on the configuration procedure, see section 6.5.
2. Set the thermocouple type, temperature, and the like, and calibrate.
For details on the configuration procedure, see sections 6.1 to 6.3.

When Using the Internal Reference Junction Compensation Wiring Example

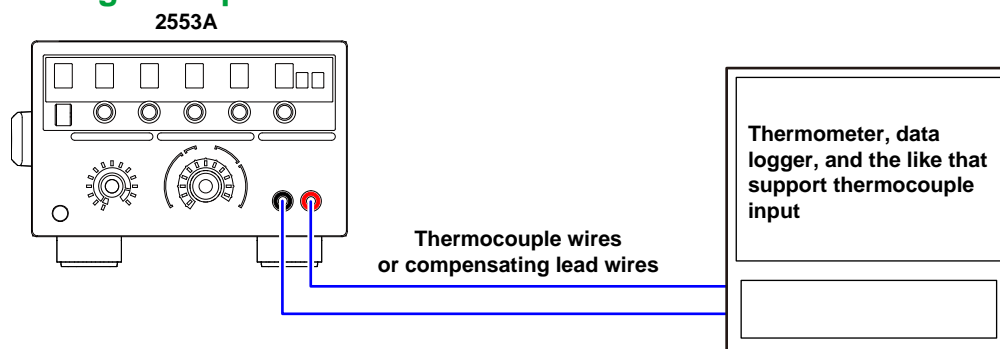

Configuring the 2553A

1. Set the reference junction compensation mode to internal (INT).
For details on the configuration procedure, see section 6.5.
2. Set the thermocouple type, temperature, and the like, and calibrate.
 - For details on the configuration procedure, see sections 6.1 to 6.3.
 - Reference junction compensation error is added to the thermocouple temperature source accuracy.

When Using an External Reference Junction Compensation Wiring Example

When Connecting an RJ Sensor Directly to the Device to Be Calibrated

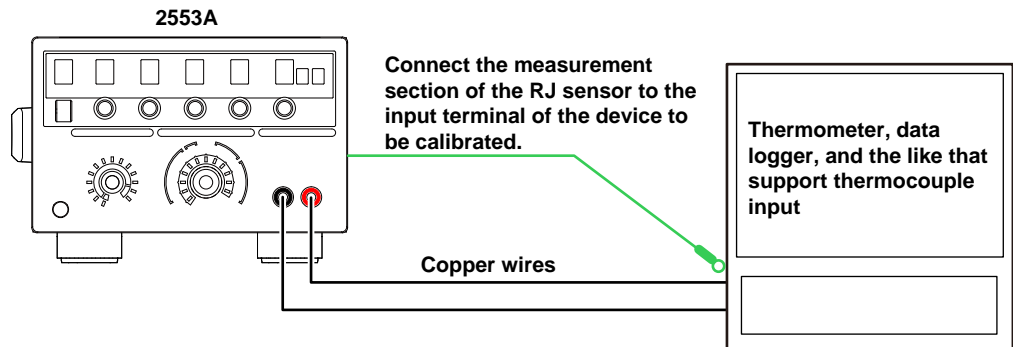

When Connecting an RJ Sensor to a Relay Terminal Block

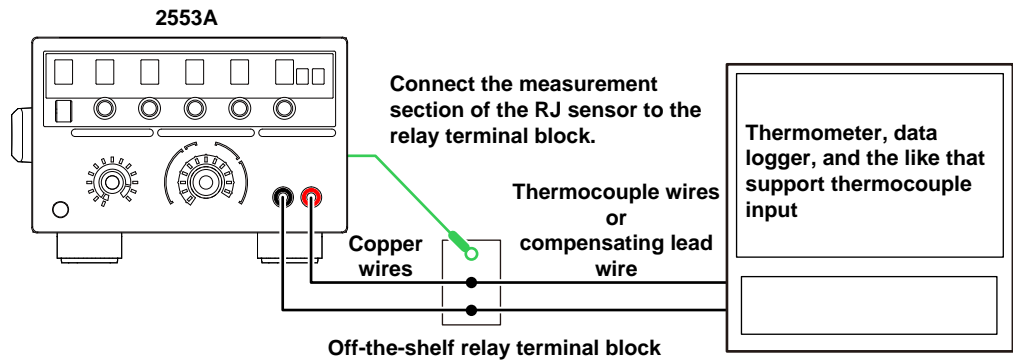

If the measurement section of an RJ sensor is connected to the input terminals of the device to be calibrated and the temperature of the terminals is different from the ambient temperature, the temperature imbalance will cause the temperature of the terminals to change. This may prevent accurate reference junction compensation. In such a situation, use a relay terminal block that is at the same temperature as the ambient temperature. However, you will need a thermocouple or compensating lead wire.

Configuring the 2553A

1. Connect an external reference junction (RJ) sensor to the external RJ sensor input terminal on the rear panel.
 - For the wiring details, see section 3.6.
 - The measurement section of the external RJ sensor is connected to the input terminal or the relay terminal block of the device to be calibrated.
2. Set the reference junction compensation mode to AUTO.
 - For details on the configuration procedure, see section 6.5.
3. Set the thermocouple type, temperature, and the like, and calibrate.
 - For details on the configuration procedure, see sections 6.1 to 6.3.
 - Reference junction compensation error is added to the thermocouple temperature source accuracy.

Appendix 3 RTD Calibration Wiring Examples

RTD calibration wiring examples are shown below.

Three-wire System Wiring Example

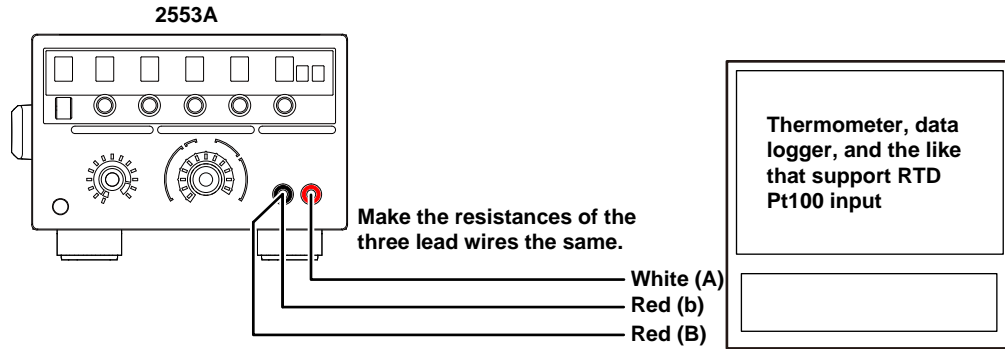

Red, white, A, and B are defined in IEC 60751: 2008 and JIS C 1604: 2013.

Configuring the 2553A

Set the RTD, temperature, and the like, and calibrate.

For details on the configuration procedure, see sections 6.1 to 6.3.

Four-wire System Wiring Example

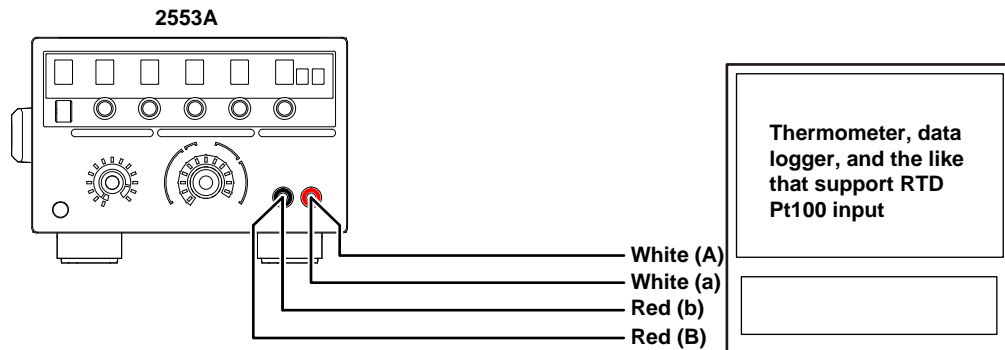

Red, white, A, and B are defined in IEC 60751: 2008 and JIS C 1604: 2013.

Configuring the 2553A

Set the RTD, temperature, and the like, and calibrate.

For details on the configuration procedure, see sections 6.1 to 6.3.

Note

To calibrate more accurately, use the fork terminal adapter set 758921 (sold separately) to connect the lead wires (A and B) on the sensing side to the fastening sections of the 2533A output terminals.

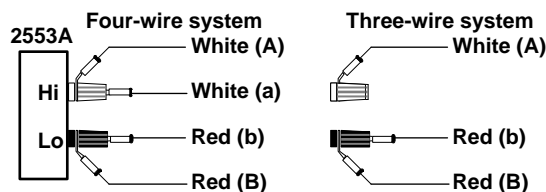

Appendix 4 User Definitions of Thermocouples and RTDs

On the 2553A, you can define (user-define) thermoelectromotive force and resistance that simulate those of thermocouples or RTDs and source thermoelectromotive force and resistance according to the definitions.

Features

Thermoelectromotive Force of a Thermocouple

You can define a thermocouple's thermoelectromotive force source for every temperature range using polynomials. For details on the polynomial syntax, see "Definition Specifications" later in this section.

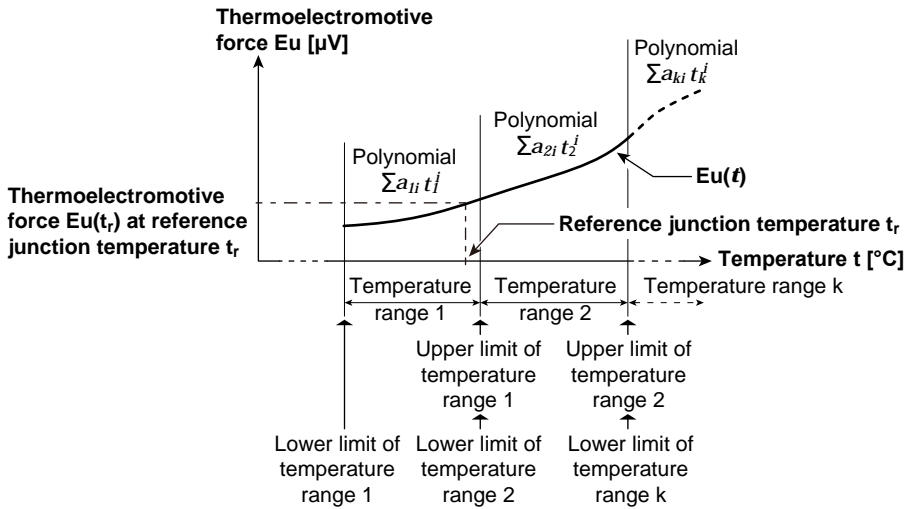

The 2553A calculates thermoelectromotive force $E_{u_{out}}$ [μV] at temperature t [$^{\circ}\text{C}$] using the polynomial and the following expression and outputs the resultant value. If the reference junction temperature is not in any of the user-defined temperature ranges, the temperature is assumed to be 0.0°C for the calculation (reference junction compensation).

$$E_{u_{out}} = E_u(t) - E_u(t_r)$$

Resistance of an RTD

You can define an RTD's resistance source for every temperature range using polynomials. For details on the polynomial syntax, see "Definition Specifications" later in this section.

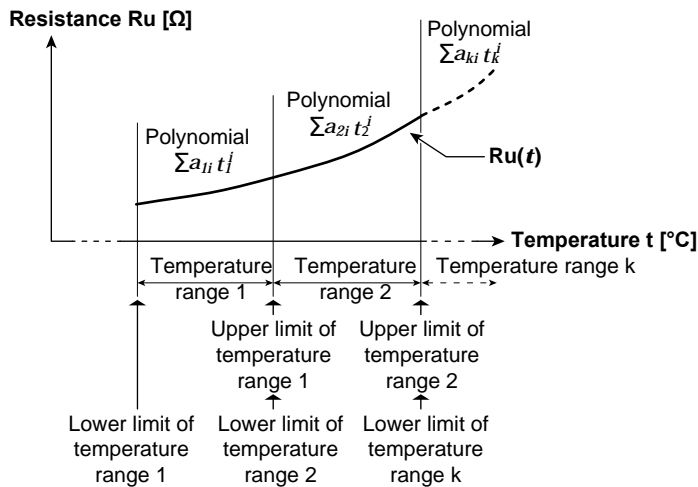

The 2553A calculates resistance R_u [Ω] at temperature t [$^{\circ}\text{C}$] using the polynomial and outputs the resultant value.

Creating Data

User-defined data is created in text format as shown in the figure below. User-defined data contains characters that indicate the type for distinguishing user definitions (type characters), upper and lower limits of temperature ranges, coefficients of polynomials, and the like. For details on the syntax, see “Definition Specifications” later in this section.

The following webpage provides user-defined data samples.

<http://tmi.yokogawa.com/products/generators-sources/standard/precision-dc-calibrator-2553a/>

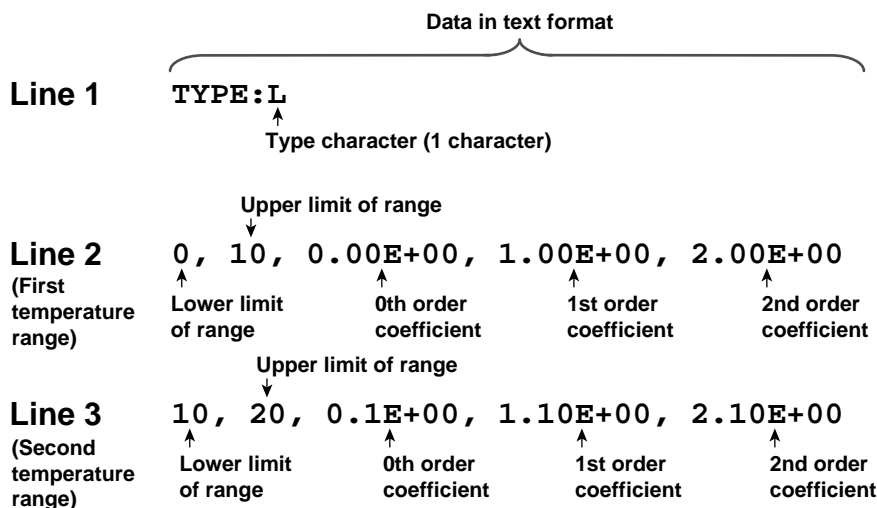

Files That Are Saved

The text data that you create is saved as a definition file. The definition file name is fixed. The name is not case sensitive.

- TC USER definition file name: TCUSER.TXT
- RTD USER definition file name: RTDUSER.TXT

Writing to the 2553A

Write the user-defined data from a definition file to the 2553A using the USB mass storage feature. Before the data is written, the 2553A checks for errors in the data. If there are no errors, the data will be written to the 2553A's internal memory. If data is already written, it is updated. If there is an error, the contents in the internal memory will not be updated.

Writing with Communication Commands

You can use communication commands to write user-defined data to the 2553A. A character string is sent for each temperature range using communication commands. A character string must be enclosed in single quotation marks or double quotation marks. To use communication commands to source the thermoelectromotive force or resistance according to the user-defined data, a sequence of commands needs to be executed. For details, see the description of the :SOURCE:RTD:DEFine or :SOURCE:TCouple:DEFine command in the SOURCE group.

Example: A character string sent using a communication command

```
'0, 10, 0.00E+00, 1.00E+00, 2.00E+00'  
"0, 10, 0.00E+00, 1.00E+00, 2.00E+00"
```

Definition Specifications

Item	Specifications
Number of user definitions	Thermocouple user definition (TC USER): 1 set, RTD user definition (RTD USER): 1 set
Temperature range	Lower limit: -9999.9°C, Upper limit: +9999.9°C
Number of temperature ranges	Up to 100
Output unit	TC USER: μV , RTD USER: Ω
Output range	TC USER: -120.000 mV to +120.000 mV, RTD USER: 18.00 Ω to 400.00 Ω
Temperature unit displayed on the panel	Unit set on the SETUP menu (User definitions of thermoelectromotive force and resistance are in terms of °C. If the unit is changed to °F, the temperatures converted to °F will be displayed.)
Polynomial	Create TC USER and RTD USER definition expressions using single-variable high-order polynomials. $\sum_{i=0}^n a_i t^i$ <p>n: Up to 20 a: Coefficient. Can be set using a fixed-point number or floating-point number. If omitted, it is assumed to be zero. t: Temperature Unit: μV for TC USER, Ω for RTD USER</p> Limitations on creating polynomials <ul style="list-style-type: none"> It is assumed that the thermoelectromotive force and resistance polynomials will be written in terms of °C for both TC USER and RTD USER user definitions. For TC USER, create the polynomial so that 0 V is output at 0°C.
Syntax	Line 1 TYPE:<type><line feed> Line 2 <temperature range 1><line feed> Line 3 <temperature range 2><line feed> Line 4 <temperature range 3><line feed> ⋮ Line 101 <temperature range 100><line feed> <ul style="list-style-type: none"> Keep the number of characters in line 1 within 512. The maximum number of temperature ranges is 100. Temperature ranges beyond 100 are ignored. <type> No character or a single ASCII code character in the range of 20 to 7E (hexadecimal). For the characters that correspond to ASCII codes 20 to 7E, see appendix 7. <temperature range 1 to 100> [Lower limit], upper limit [, 0th order coefficient [, 1st order coefficient [, 2nd order coefficient . . . [, 20th order coefficient] . . .]] <ul style="list-style-type: none"> Use a comma to delimit values. Parts in square brackets ([]) can be omitted. Lower limit Set the lower temperature limit of each temperature range. Can be set using a fixed-point number or floating-point number. Selectable range:-9999.9°C to +9999.9°C If omitted, -9999.9°C is set. If the selectable range overlaps with the next lower temperature range, the lower limit is set to the same value as the upper limit of the next lower temperature range. If the selectable range is higher than the upper limit of the next lower temperature range, the lower limit is also set to the upper limit of the next lower temperature range. Upper limit Set the upper temperature limit of each temperature range. Can be set using a fixed-point number or floating-point number. Selectable range:-9999.9°C to +9999.9°C You cannot omit the upper limit. Make sure that the lower limit is less than or equal to the upper limit. nth order coefficients Set the nth order coefficients of the polynomial for each temperature range. Can be set using a fixed-point number or floating-point number. If omitted, 0 is set. Up to 21 coefficients can be set. Use a comma to delimit the coefficients. Set the coefficients so that the thermoelectromotive force or resistance do not exceed the maximum output.

Appendix 4 User Definitions of Thermocouples and RTDs

Item	Specifications
	<p><line feed> CR, LF, and CR+LF can be used.</p> <ul style="list-style-type: none"> • Even if a temperature range is lower than that of the previous line, the ranges are sorted before they are written in the 2553A. • A line whose first character is a sharp (#) is handled as an empty line. • Lines that only contain a line feed are ignored. • Spaces after a comma or value are ignored. • Do not insert a space immediately after a polarity sign (– or +).
Definition file	<p>User-defined data that you create according to the syntax are saved in a text file with the following name. The user-defined data file name is fixed. The name is not case sensitive.</p> <p>TC USER definition file name: TCUSER.TXT RTD USER definition file name: RTDUSER.TXT</p>
Error file	<p>If there is an error in the user definition, an error will occur. Errors are saved to the following files in the 2553A OUT folder. The error file name is fixed.</p> <p>TC USER error file name: ERRORTCUSER.TXT RTD USER error file name: ERRORRTDUSER.TXT</p>
Error file syntax	<p>LINE x, CHAR y : error message</p> <ul style="list-style-type: none"> • LINE x: Indicates the error line number in the definition text data. • CHAR y: Indicates the error character number in the error line. • Error message: See “User-Definition Error Messages” below.
Setting user definitions using communication commands	<p>You can use communication commands to set TC USER and RTD USER user definitions. For details on user-definition commands, see “SOURce Group” in chapter 11.</p> <ul style="list-style-type: none"> • TC USER and RTD USER user definitions are set using separate commands. • A character string is set for each temperature range. You must send a character string enclosed in single quotation marks (') or double quotation marks ("). • You can assign a character to identify among different types of user definitions. • You can delete the user-defined data written in the 2553A's internal memory.

User-Definition Error Messages

Error Message

There is no TYPE description.

The number of characters for TYPE is not correct.

The character type used in TYPE is not correct.

The output is outside the possible range.

The number of characters in a line exceeds 512.

The upper limit of the temperature range is omitted.

The upper or lower limit of the temperature range is outside the allowed range.

The upper limit of the temperature range is less than the lower limit.

A polynomial coefficient is not specified.

The format of the upper limit, lower limit, or polynomial coefficient is not correct.

The number of polynomial coefficients exceeds 21.

Appendix 5 List of Default Settings and Settings That Are Saved

Setting		Factory Default Value	Initialized When Settings Are Initialized or with a *RST Command? Yes: Initialized No: Not initialized	Value Saved When Powered Off? Yes: Saved No: Not saved
Output		OFF	Yes	No
Range		1V	Yes	Yes
Temperature type		Thermocouple K	Yes	Yes
Output setting	Voltage, current	0.00000	Yes	Yes The decimal place depends on the range setting.
	Temperature	0.0	Yes	Yes
	Resistance	18.00	Yes	Yes
Polarity	Voltage, current	+	Yes	Yes
	Temperature	+	Yes	Yes
Reference Junction Compensation (RJC)	Mode (MODE)	AUTO	Yes	Yes
	Manual input compensation value (VAL)	0.00°C	Yes On models with the -UF suffix code, "0.00°C" or "32.00°F" is displayed according to the temperature unit setting.	Yes
	Resistance (R0) of the external RJ sensor (Pt100)	100.00Ω	No	Yes
Temperature unit		°C	No	Yes
User definitions	Thermocouple	None	No	Yes
	RTD	None	No	Yes
GP-IB interface	Address	1	No	Yes
	Command type (TYPE)	NORMAL	No	Yes
Ethernet interface (LAN)	DHCP	ON	No	Yes
	IP address	192.168.0.1	No	Yes
	Subnet mask	255.255.255.255	No	Yes
	Default gateway	0.0.0.0	No	Yes
USB interface		TMC	No	Yes

Appendix 6 About the IEEE 488.2-1992 Standard

The 2553A's GP-IB interface conforms to the IEEE 488.2-1992 standard. This standard specifies that the following 23 items be stated in the document. This section describes these items.

- (1) Of the IEEE 488.1 interface functions, the subsets that are supported**
See section 7.1, "GP-IB Interface Features and Specifications."
- (2) The operation of the device when it is assigned an address outside the 0 to 30 range.**
The address of this instrument cannot be set to an address outside the 0 to 30 range.
- (3) Reaction of the device when the user changes the address**
The address change is detected when the user uses the RANGE dial > SETUP > GP-IB menu > ADRS menu and changes the address. The new address is valid until the next time it is changed.
- (4) Device settings at power-up. The commands that can be used at power-up.**
As a basic rule, the previous settings (the settings that were in use when the 2553A was turned off) are used.
There are no limitations on the commands that can be used at power-up.
- (5) Message exchange options**
 - (a) Input buffer size**
1024 bytes.
 - (b) Queries that return multiple response messages**
See the example of the commands given in chapter 11.
 - (c) Queries that create response data when the command syntax is being analyzed**
All queries create response data when the command syntax is analyzed.
 - (d) Queries that create response data during reception**
There are no queries of which the response data are created upon receiving a send request from the controller.
 - (e) Commands that have parameters that restrict one another**
See the example of the commands given in chapter 11.
- (6) Items that are included in the functional or composite header elements constituting a command**
See chapters 10 and 11.
- (7) Buffer sizes that affect block data transmission**
When block data is being transmitted, the output queue is expanded to match the size of the data that is being transmitted.
- (8) A list of program data elements that can be used in equations and their nesting limitations**
Equations cannot be used.
- (9) Syntax of the responses to queries**
See the example of the commands given in chapter 11.
- (10) Communication between devices that do not follow the response syntax**
Not supported.
- (11) Size of the response data block**
0 bytes
- (12) A list of supported common commands**
See section 11.7, "Common Command Group."
- (13) Device condition after a successful calibration**
*CAL is not supported.
- (14) The maximum length of block data that can be used for the *DDT trigger macro definition**
Not supported.
- (15) The maximum length of the macro label for defining macros, the maximum length of block data that can be used for the macro definition, and the process when recursion is used in macro definitions**
Macro functions are not supported.
- (16) Reply to the *IDN? query**
See section 11.7, "Common Command Group."
- (17) Size of storage area for protected user data for *PUD and *PUD?**
*PUD and *PUD? are not supported.
- (18) The length of the *RDT and *RDT? resource names**
*RDT and *RDT? are not supported.
- (19) The change in the status due to *RST, *LRN?, *RCL, and *SAV**
***RST**
See section 11.7, "Common Command Group."
***LRN?, *RCL, *SAV**
These common commands are not supported.
- (20) The extent of the self-test using the *TST? command**
See section 11.7, "Common Command Group."
- (21) The structure of the extended return status**
See chapter 12.
- (22) Whether each command is processed in an overlapped manner or sequentially**
See section 10.5, "Synchronization with the Controller" and chapter 11.
- (23) The description of the execution of each command**
See the functions of the commands given in chapter 11.

Appendix 7 ASCII Character Codes

This section provides a table of ASCII character codes.

	0	1	2	3	4	5	6	7
0	0 NUL	20 DEL	40 SP	60 0	80 @	100 P	120 '	140 p
1	1 SOH	21 DC1	41 !	61 1	81 A	101 Q	121 a	141 q
2	2 STX	22 DC2	42 "	62 2	82 B	102 R	122 b	142 r
3	3 ETX	23 DC3	43 #	63 3	83 C	103 S	123 c	143 s
4	4 EOT	24 DC4	44 \$	64 4	84 D	104 T	124 d	144 t
5	5 ENQ	25 NAK	45 %	65 5	85 E	105 U	125 e	145 u
6	6 ACK	26 SYN	46 &	66 6	86 F	106 V	126 f	146 v
7	7 BEL	27 ETB	47 ,	67 7	87 G	107 W	127 g	147 w
8	8 BS	28 CAN	48 (68 8	88 H	108 X	128 h	148 x
9	9 HT	29 EM	49)	69 9	89 I	109 Y	129 i	149 y
A	10 LF	30 SUB	50 *	70 :	90 J	110 Z	130 j	150 z
B	11 VT	31 ESC	51 +	71 ;	91 K	111 [131 k	151 {
C	12 FF	32 FS	52 ,	72 <	92 L	112 \	132 l	152
D	13 CR	33 GS	53 -	73 =	93 M	113]	133 m	153 }
E	14 SO	34 RS	54 .	74 >	94 N	114 ^	134 n	154 ~
F	15 SI	35 US	55 /	75 ?	95 O	115 _	135 o	155 DEL (RUBOUT)
	Address commands	Universal commands	Listener addresses	Talker addresses	Secondary commands			

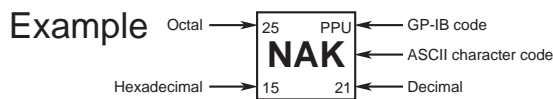

Index

Numeric Page

5x7 dot matrix LEDs.....	1-1
7 segment.....	1-3
7-segment LED.....	1-1
10BASE-T.....	1-2
10BASE-TX.....	1-2

A Page

abbreviated form.....	10-5
accessories.....	iii
ambient humidity.....	14-7
ambient temperature.....	14-7
authorized representative.....	ix

B Page

block data.....	10-7
Boolean.....	10-7
bottom legs.....	1-1
bottom panel.....	1-2

C Page

caution mark.....	x
character data.....	10-7
compatible commands.....	7-7
compatible commands (COMPAtible).....	11-12
condensation.....	14-7
conventions.....	x
current ranges.....	5-1

D Page

DCL (Device Clear).....	7-8
deadlock.....	10-2
decimal.....	10-6
default gateway.....	8-4, 11-11
DHCP.....	8-3, 11-11
digital letters.....	1-3
digital numbers.....	1-3
Directive.....	ix
dot matrix LEDs.....	1-1

E Page

emissions.....	14-7
error log.....	2-5, 13-8
ETHERNET port.....	1-2
external dimensions.....	14-10
external RJ sensor input terminal.....	1-2

F Page

firmware version.....	11-13
front panel.....	1-1

G Page

GET (Group Execute Trigger).....	7-8
GP-IB address.....	7-5, 11-12
GP-IB port.....	1-2
GTL (Go To Local).....	7-8

H Page

handle.....	1-1
humidity.....	14-7

I Page

IFC (Interface Clear).....	7-8
immunity.....	14-8
initialization.....	2-5, 11-13
installation.....	14-7
installation conditions.....	3-3
instrument number.....	ii
insulation resistance.....	14-7
intended purpose.....	v
IP address.....	8-4, 11-11

L Page

LLO (Local Lockout).....	7-8
Local.....	7-2, 8-1, 9-1

M Page

MAC address.....	11-11
measurement category.....	14-7
measurement lead.....	ii
messages.....	10-1
MODEL.....	ii
multiplier.....	10-6

N Page

nameplate.....	1-2
normal commands.....	7-7
normal commands (NORMAL).....	11-12

O Page

OFF indicator.....	1-1
ON indicator.....	1-1
operating altitude.....	14-7
operating environment.....	14-7
options.....	11-13
orientation.....	14-7
output on and off.....	2-2, 2-4
output setting.....	11-5
output setting dials.....	1-1
output setting display.....	1-1
OUTPUT switch.....	1-1, 11-4
output terminals.....	1-1, 3-12
overlap commands.....	10-8

P Page

panels.....	1-1
PMT.....	10-1
polarity display.....	1-1
POLARITY switch.....	1-1, 11-4
pollution degree.....	14-7
power consumption.....	14-7
power cord.....	ii
power switch.....	1-1
precautions.....	v
program data.....	10-1
program header.....	10-1

Index

program messages.....	10-1
protective earth.....	v
purpose.....	v

R Page

rack mount.....	3-5
RANGE dial.....	1-1
rated supply frequency.....	14-7
rated supply voltage.....	14-7
rear legs.....	1-2
rear panel.....	1-2
register.....	10-7
Register.....	10-7
REMOTE indicator.....	1-1
REN (Remote Enable).....	7-8
resistance range.....	5-1
response data.....	10-2
response header.....	10-2
response messages.....	10-1
RJC indicators.....	1-1
RJ sensor.....	iii
RMT.....	10-1
RTD.....	6-2
rubber.....	ii
rubber leg cap.....	ii, 3-4

S Page

safety precautions.....	iv
safety standard.....	14-7
SDC (Selected Device Clear).....	7-8
segment LED.....	1-1
self-test.....	11-14, 13-11
sequential commands.....	10-8
serial number.....	2-5, 11-13
SETUP menu.....	11-11
sold separately.....	iii
source function.....	11-5
SPD (Serial Poll Disable).....	7-8
special characters.....	1-3
SPE (Serial Poll Enable).....	7-8
standard accessories.....	ii
standard operating conditions.....	14-7
storage environment.....	14-7
string data.....	10-7
subnet mask.....	8-4, 11-11
SUFFIX.....	ii
suffix code.....	ii
symbols.....	iv
symbols (in the manual).....	x

T Page

temperature.....	10-6, 14-7
TEMPERATURE dial.....	1-1
terminal plug.....	ii
thermocouple.....	6-2
top panel.....	1-2
type B connector.....	1-2

U Page

unit.....	10-6
unit display.....	1-1
USB driver.....	9-4
USB port.....	1-2

V Page

vent holes.....	1-2
version.....	2-5
voltage.....	10-6
voltage ranges.....	5-1

W Page

warm-up.....	3-8
warm-up time.....	14-7
Waste Electrical and Electronic Equipment Directive.....	ix
WEEE directive.....	ix
weight.....	14-7
withstand voltage.....	14-7