

PRECISION VOLTAGE COMPARATORS

DESCRIPTION

The μ PC311 is a voltage comparator that has input currents more than a hundred times lower than devices like conventional standard type of 710. It is also designed to operate over a wide range of supply voltages; from ± 15 V op amp supplies down to the single 5 V supply used for IC logic. Its output is compatible with HNIL, DTL and TTL as well as MOS circuits.

FEATURES

- Operate from single 5 V supply
- Maximum input current: 250 nA
- Maximum offset current: 50 nA
- Fast transient response: 200 ns TYP.

EQUIVALENT CIRCUIT

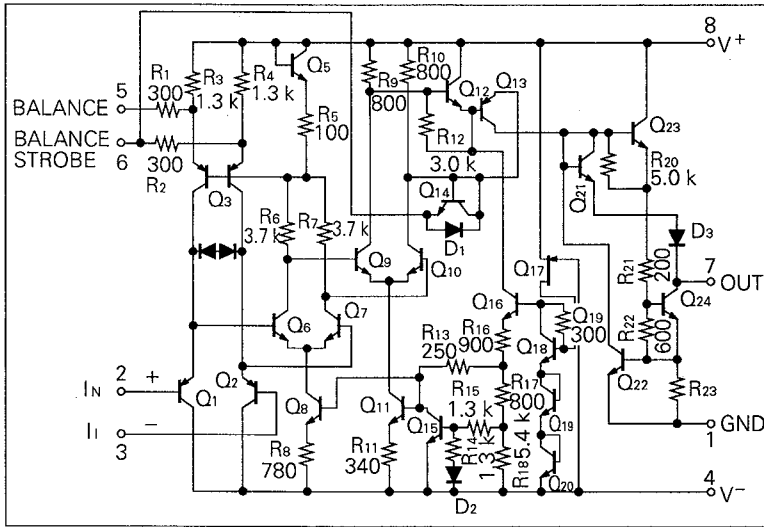

CONNECTION DIAGRAM (Top View)

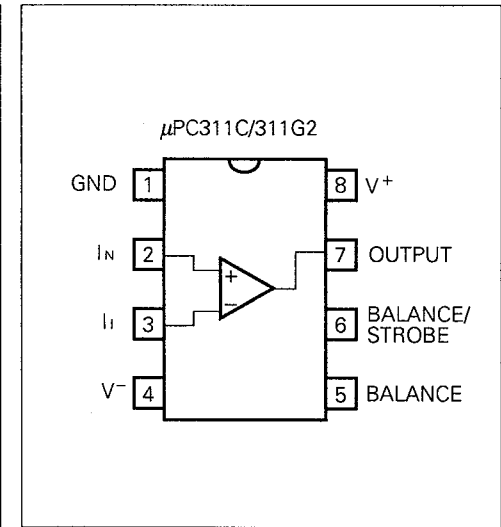

ORDERING INFORMATION

PART NUMBER	PACKAGE	QUALITY GRADE
μ PC311C	8 PIN PLASTIC DIP (300 mil)	Standard
μ PC311G2	8 PIN PLASTIC SOP (225 mil)	Standard

Please refer to "Quality grade on NEC Semiconductor Devices" (Document number IEI-1209) published by NEC Corporation to know the specification of quality grade on the devices and its recommended applications.

ABSOLUTE MAXIMUM RATINGS (Ta = 25 °C)

PARAMETER		SYMBOL	μPC311	UNIT
Voltage between V ⁺ and V ⁻		(Note 1) V ⁺ - V ⁻	-0.3 to +36	V
Differential Input Voltage		V _{ID}	±30	V
Input Voltage		(Note 2) V _I	V ⁻ -0.3 to V ⁺ +0.3	V
Output to Negative Supply Voltage		(Note 3) V _O - V ⁻	-0.3 to +40	V
Ground to Negative Supply Voltage		(Note 3) V _{GND} - V ⁻	-0.3 to +30	V
Power Dissipation	C Package	(Note 4) P _T	350	mW
	G2 Package	(Note 5)	440	mW
Output Short Circuit Duration		(Note 6)	10	sec
Operating Temperature Range		T _{opt}	-20 to +80	°C
Storage Temperature Range		T _{stg}	-55 to +125	°C

Note 1. Reverse connection of supply voltage can cause destruction.

Note 2. The input voltage should be allowed to input without damage or destruction. Even during the transition period of supply voltage, power on/off etc., this specification should be kept. The normal operation will establish when the both inputs are within the Common Mode Input Voltage Range of electrical characteristics.

Note 3. This specification is the voltage which should be allowed to supply to the output and GND terminal from external without damage or destructive. Even during the transition period of supply voltage, power on/off etc., this specification should be kept.

Note 4. Thermal derating factor is -5.0 mV/°C when ambient temperature is higher than 55 °C.

Note 5. Thermal derating factor is -4.4 mV/°C when ambient temperature is higher than 25 °C.

Note 6. Pay careful attention to the total power dissipation not to exceed the absolute maximum ratings, Note 4 and Note 5.

RECOMMENDED OPERATING CONDITIONS

CHARACTERISTIC	SYMBOL	MIN.	TYP.	MAX.	UNIT
Supply Voltage (Split)	V [±]	±4		±16	V
Supply Voltage (V ⁻ = GND)	V ⁺	+5		+32	V

TYPICAL CONNECTIONS

OFFSET VOLTAGE NULL CIRCUIT

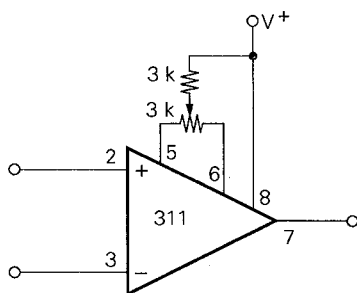

STROBING CIRCUIT

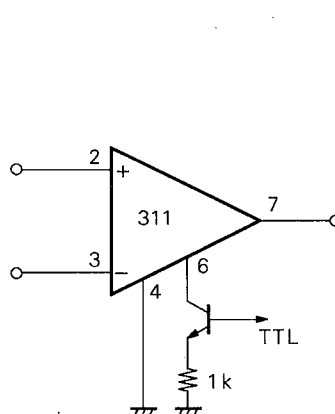

FAST RESPONSE CIRCUIT
(INCREASING INPUT STAGE CURRENT)

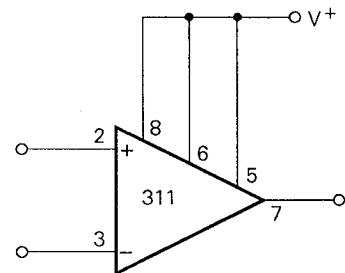

ELECTRICAL CHARACTERISTICS (T_a = 25 °C, V[±] = ±15 V)

CHARACTERISTIC	SYMBOL	MIN.	TYP.	MAX.	UNIT	CONDITIONS
Input Offset Voltage	V _{IO}		±2.0	±7.5	mV	V ⁺ - V ⁻ = 5 V to 30 V, R _s ≤ 50 kΩ
Input Offset Current	I _{IO}		±6.0	±50	nA	V ⁺ - V ⁻ = 5 V to 30 V
Input Bias Current	I _B		100	250	nA	V ⁺ - V ⁻ = 5 V to 30 V
Voltage Gain	A _v		200		V/mV	R _L = 1.0 kΩ
Response Time			200		ns	Input step 100 mV, Overdrive 5 mV
Output Saturation Voltage	V _{OL}		0.75	1.5	V	V _{IN} ≤ 10 mV, I _o = 50 mA
Strobe ON Current			3.0		mA	
Output Leakage Current	I _{O LEAK}		0.2	50	nA	V _{IN} ≥ 10 mV, V _o = 35 V
Positive Supply Current	I ⁺		5.1	7.5	mA	I _o = 0 A
Negative Supply Current	I ⁻		4.1	5.0	mA	I _o = 0 A
Input Offset Voltage	V _{IO}			±10	mV	V ⁺ - V ⁻ = 5 to 30 V, R _s ≤ 50 kΩ, T _a = 0 to 70 °C
Input Offset Current	I _{IO}			±70	nA	V ⁺ - V ⁻ = 5 to 30 V, T _a = 0 to 70 °C
Input Bias Current	I _B			300	nA	V ⁺ - V ⁻ = 5 to 30 V, T _a = 0 to 70 °C
Common Mode Input Voltage Range	V _{ICM}	+13.0 -14.5	+13.8 -14.7		V	
Output Saturation Voltage	V _{OL}		0.23	0.4	V	V ⁺ ≥ 4.5 V, V ⁻ = 0 V, V _{IN} ≤ -10 mV, I _o = 8 mA

TYPICAL APPLICATION CIRCUIT

OPEN COLLECTOR OUTPUT

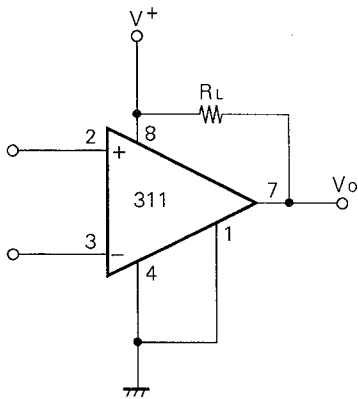

EMITTER FOLLOWER OUTPUT

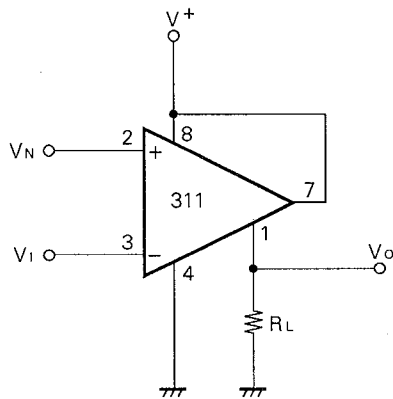

Input polarity is reversed when 1pin (GND) is used as an output
 $V_N > V_I \rightarrow V_o$: Low

COMPARATOR with HYSTERESIS CIRCUIT

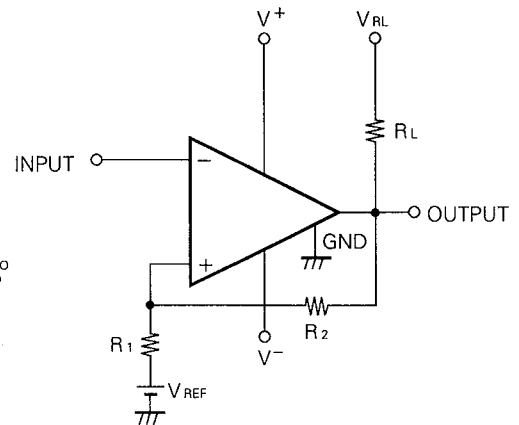

Threshold Voltage

$$V_{TH(High)} \doteq V_{REF} + \frac{R_1}{R_L + R_2 + R_1} (V_{RL} - V_{REF})$$

$$V_{TH(Low)} \doteq V_{REF} - \frac{R_1}{R_1 + R_2} (V_{REF} - V_{OL})$$

(V_{RL} > V_{REF} > V_{OL})

TYPICAL PERFORMANCE CHARACTERISTICS ($T_a = 25^\circ\text{C}$, TYP.)

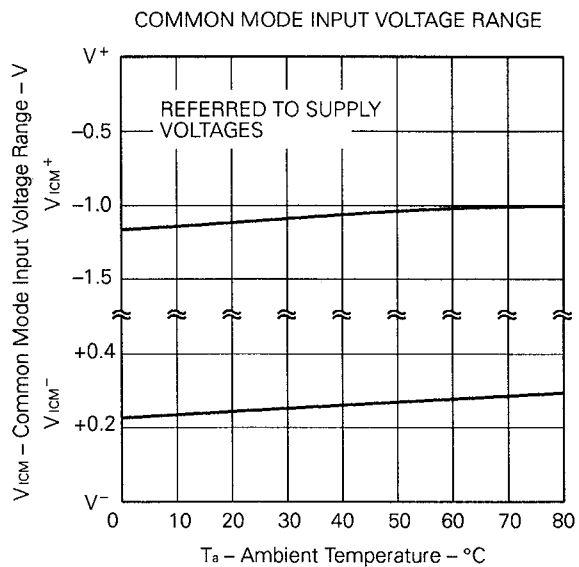
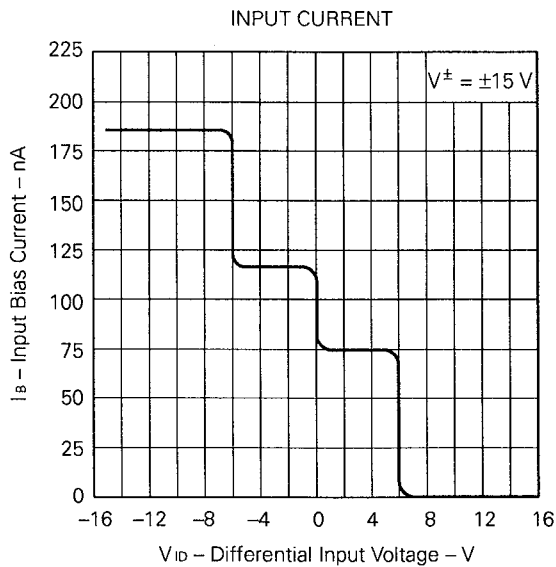
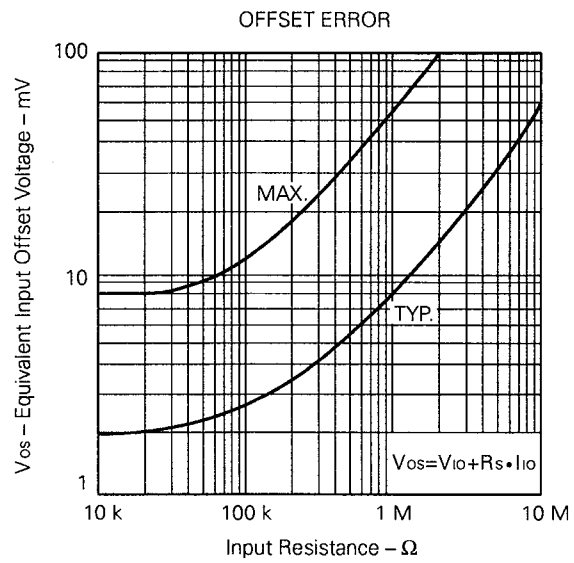
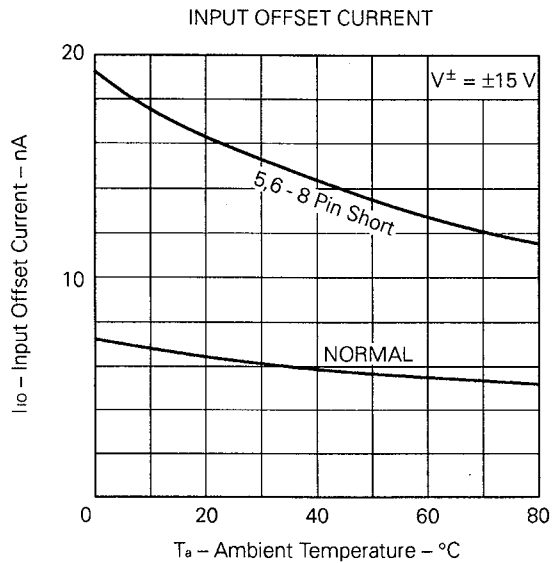
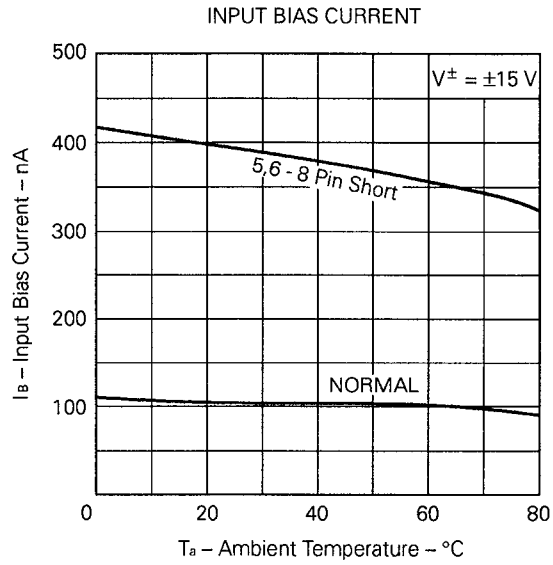
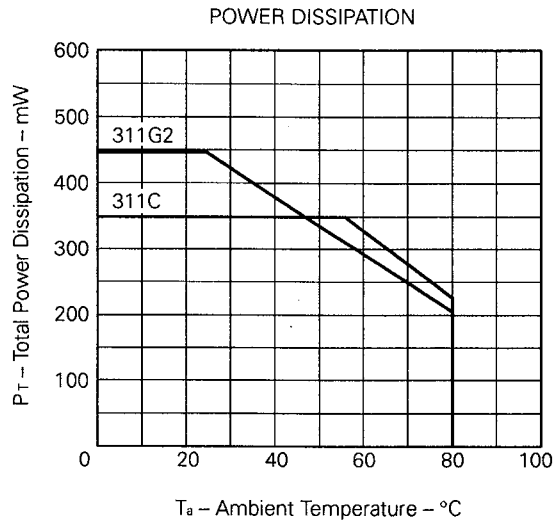

TRANSFER FUNCTION

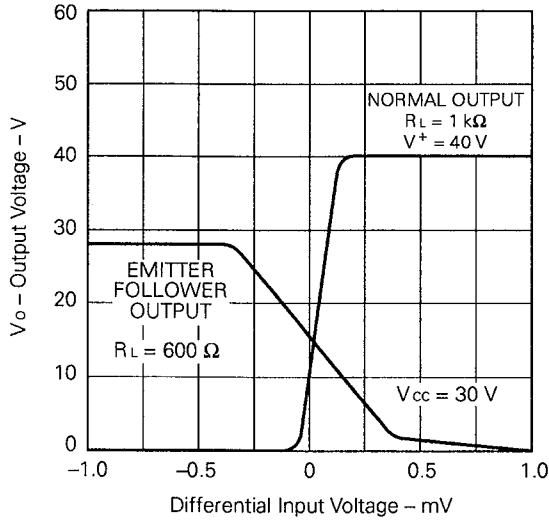

RESPONSE TIME FOR VARIOUS INPUT OVERDRIVES

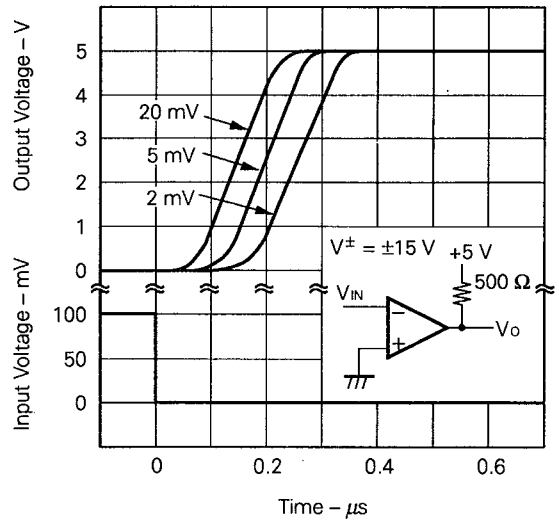

RESPONSE TIME FOR VARIOUS INPUT OVERDRIVES

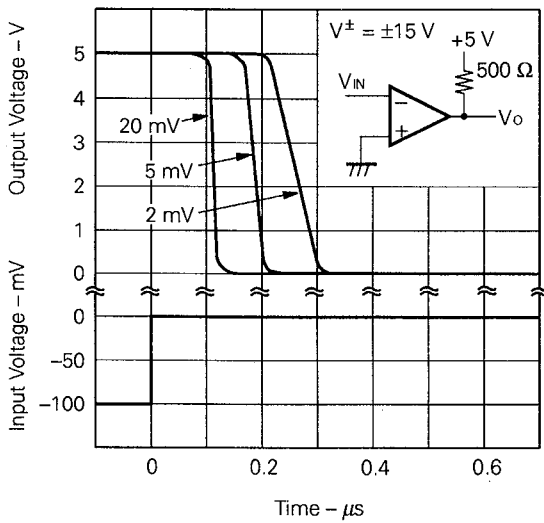

RESPONSE TIME FOR VARIOUS INPUT OVERDRIVES

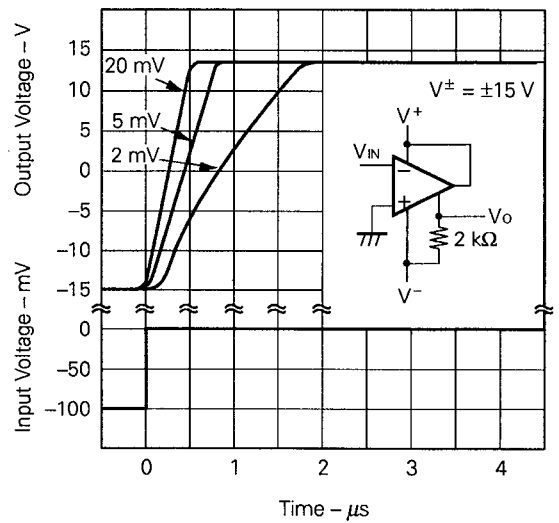

RESPONSE TIME FOR VARIOUS INPUT OVERDRIVES

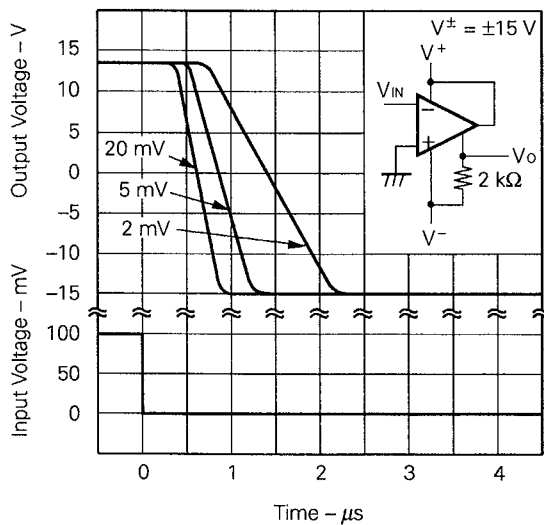

OUTPUT SATURATION VOLTAGE

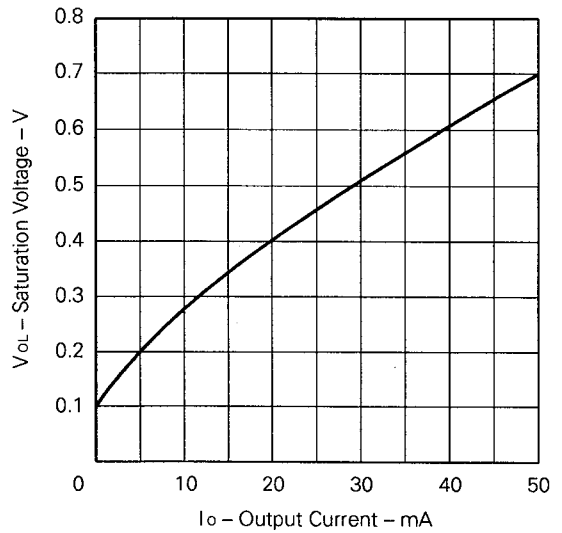

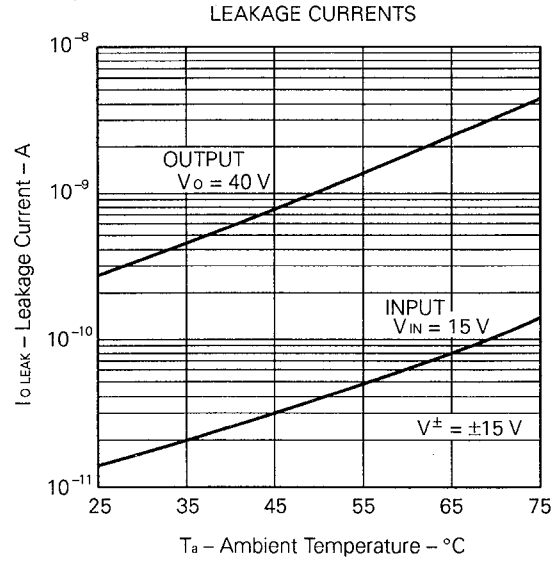
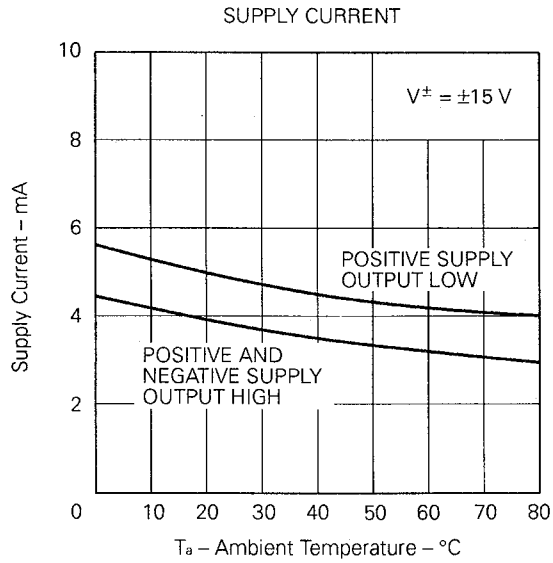
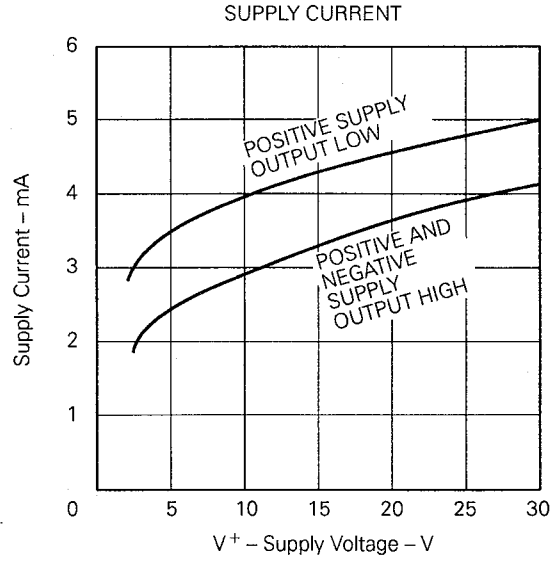
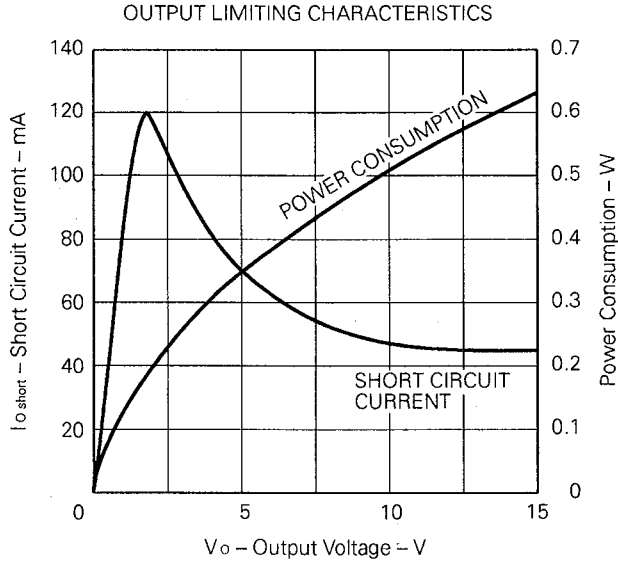

8PIN PLASTIC DIP (300 mil)

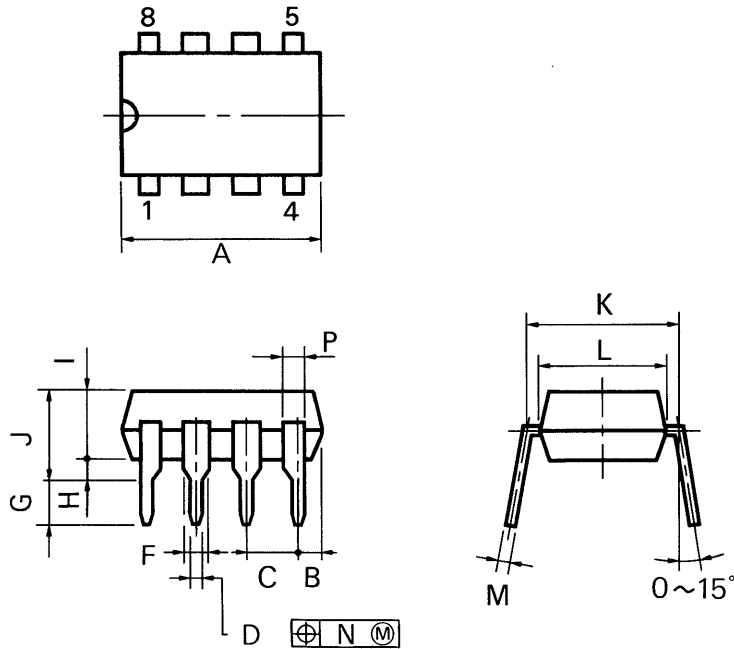

P8C-100-300B,C

NOTES

- 1) Each lead centerline is located within 0.25 mm (0.01 inch) of its true position (T.P.) at maximum material condition.
- 2) Item "K" to center of leads when formed parallel.

ITEM	MILLIMETERS	INCHES
A	10.16 MAX.	0.400 MAX.
B	1.27 MAX.	0.050 MAX.
C	2.54 (T.P.)	0.100 (T.P.)
D	0.50 ^{±0.10}	0.020 ^{±0.004}
F	1.4 MIN.	0.055 MIN.
G	3.2 ^{±0.3}	0.126 ^{±0.012}
H	0.51 MIN.	0.020 MIN.
I	4.31 MAX.	0.170 MAX.
J	5.08 MAX.	0.200 MAX.
K	7.62 (T.P.)	0.300 (T.P.)
L	6.4	0.252
M	0.25 ^{±0.10}	0.010 ^{±0.004}
N	0.25	0.01
P	0.9 MIN.	0.035 MIN.

8 PIN PLASTIC SOP (225 mil)

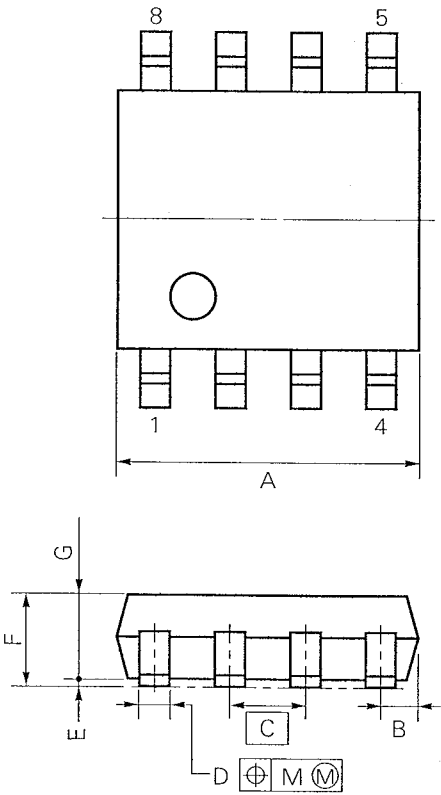

detail of lead end

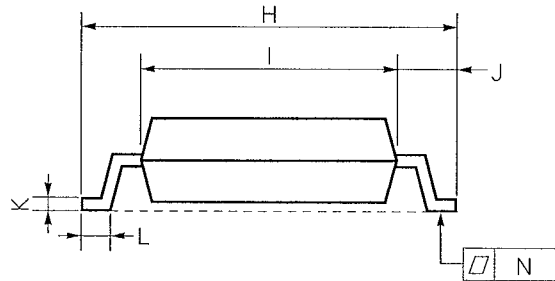
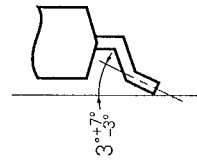

S8GM-50-225B-2

NOTE

Each lead centerline is located within 0.12 mm (0.005 inch) of its true position (T.P.) at maximum material condition.

ITEM	MILLIMETERS	INCHES
A	5.37 MAX.	0.212 MAX.
B	0.78 MAX.	0.031 MAX.
C	1.27 (T.P.)	0.050 (T.P.)
D	0.40 ^{+0.10} _{-0.05}	0.016 ^{+0.004} _{-0.003}
E	0.1±0.1	0.004±0.004
F	1.8 MAX.	0.071 MAX.
G	1.49	0.059
H	6.5±0.3	0.256±0.012
I	4.4	0.173
J	1.1	0.043
K	0.15 ^{+0.10} _{-0.05}	0.006 ^{+0.004} _{-0.002}
L	0.6±0.2	0.024 ^{+0.008} _{-0.009}
M	0.12	0.005
N	0.15	0.006

RECOMMENDED SOLDERING CONDITIONS

The following conditions (see tables below) must be met when soldering this product.

Please consult with our sales offices in case other soldering process is used, or in case other soldering is done under different conditions.

TYPES OF SURFACE MOUNT DEVICE

For more details, refer to our document "SEMICONDUCTOR DEVICE MOUNTING TECHNOLOGY MANUAL" (IEI-1207).

[μPC311G2]

Soldering method	Soldering conditions	Recommended condition symbol
Infrared ray reflow	Peak package's surface temperature: 230 °C or below, Reflow time: 30 seconds or below (210 °C or higher), Number of reflow process: 1, Exposure limit*: None	IR30-00-1
VPS	Peak package's surface temperature: 215 °C or below, Reflow time: 40 seconds or below (200 °C or higher), Number of reflow process: 1, Exposure limit*: None	VP15-00-1
Wave soldering	Solder temperature: 260 °C or below, Flow time: 10 seconds or below, Number of flow process: 1, Exposure limit*: None	WS15-00-1
Partial heating method	Terminal temperature: 300 °C or below, Flow time: 10 seconds or below, Exposure limit*: None	

*: Exposure limit before soldering after dry-pack package is opened.
Storage conditions: 25 °C and relative humidity at 65 % or less.

Note: Do not apply more than a single process at once, except for "Partial heating method".

TYPES OF THROUGH HOLE DEVICE

[μPC311C]

Soldering method	Soldering conditions	Recommended condition symbol
Wave soldering	Solder temperature: 260 °C or below, Flow time : 10 seconds or below	

[MEMO]

No part of this document may be copied or reproduced in any form or by any means without the prior written consent of NEC Corporation. NEC Corporation assumes no responsibility for any errors which may appear in this document.

NEC Corporation does not assume any liability for infringement of patents, copyrights or other intellectual property rights of third parties by or arising from use of a device described herein or any other liability arising from use of such device. No license, either express, implied or otherwise, is granted under any patents, copyrights or other intellectual property rights of NEC Corporation or others.

The devices listed in this document are not suitable for use in aerospace equipment, submarine cables, nuclear reactor control systems and life support systems. If customers intend to use NEC devices for above applications or they intend to use "Standard" quality grade NEC devices for applications not intended by NEC, please contact our sales people in advance.

Application examples recommended by NEC Corporation.

Standard: Computer, Office equipment, Communication equipment, Test and Measurement equipment, Machine tools, Industrial robots, Audio and Visual equipment, Other consumer products, etc.

Special: Automotive and Transportation equipment, Traffic control systems, Antidisaster systems, Anticrime systems, etc.