

The New Standard
 COLOR, Advanced Functions, Readability and Portability

Digital Oscilloscope
DL1540C/DL1540CL



- 200 MS/s maximum sampling rate ● 150 MHz analog bandwidth
- Maximum record length: 2 M words for DL1540CL, 120 k words for DL1540C
- 6.4-inch color TFT LCD with wide viewing angle ● Small and lightweight (Approx. 5 kg)
 - Footprint smaller than A4
- VGA output (option) ● Built - in printer (option)

DL1540CL
 2.1GB internal hard disk drive,
 I²C bus analysis function New!



The New Standard in Portable Digital Oscilloscopes for the Ultimate in Advanced Features, Screen Readability, and Portability

The DL1540C/DL1540CL is a new portable digital oscilloscope that has a color TFT LCD and packs many advanced features into a small case. In addition to impressive basic specifications, we have maintained the multi-channel and long memory features common to all YOKOGAWA oscilloscopes. The color display makes it easier to read oscilloscope data, and the unit is about 1 kg lighter than conventional digital oscilloscopes. These improvements make it easier to efficiently measure increasingly complex and diverse signals, helping to improve the efficiency of the development process.

- **6.4-inch color TFT LCD with wide viewing angle**

The display clearly identifies waveforms displayed on multiple channels.

- **Small and lightweight (approx. 5 kg)**

The unit weighs about 1 kg less than conventional models.

- **200 MS/s maximum sampling rate, 150 MHz analog bandwidth**

- **Maximum record length: 2 M words for DL1540CL, 120 k words for DL1540C**

- **Maximum screen refresh rate: 60 Hz**

- **Color printing feature**

The oscilloscope can be connected to an external color printer through a commercially available GP-IB/Centronics conversion adapter for direct color printing.

- **2.1GB internal hard disk drive (option for DL1540CL only)**

NEW!

- **Built-in printer (option)**

The built-in printer can be used to print out screen shots and enlarged waveforms (long copies), and for real-time printing.

- **Pulse counting function**

This function automatically counts the number of pulse waveforms in a specified interval.

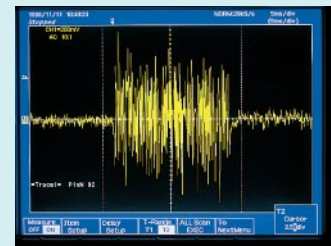

NEW! The DL1540CL, is available with a new I²C*1 bus analysis option. This turns the DL1540CL into an I²C bus analyzer.

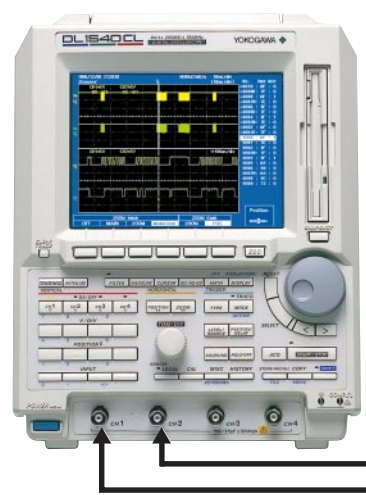

Example application : I²C bus of VTR

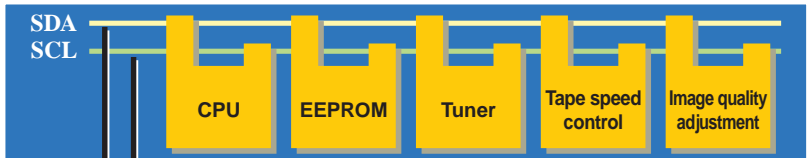

*1 Serial interfaces between ICs are widely used in consumer electronics. Applications include computers, personal digital assistants (PDAs), and multimedia devices such as DVD players and car navigation systems.

■ A variety of trigger functions
Trigger types are start condition, Non-Ack, combination of address and data pattern

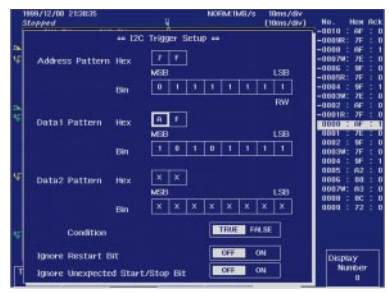

■ Powerful data analysis functions
Waveform data are analyzed in a time series, and analyzed results are decoded and displayed one byte at a time.

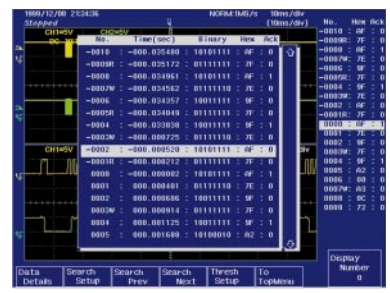

■ Rapidly data search functions
This functions rapidly search for specified addresses and data in the analyzed result.

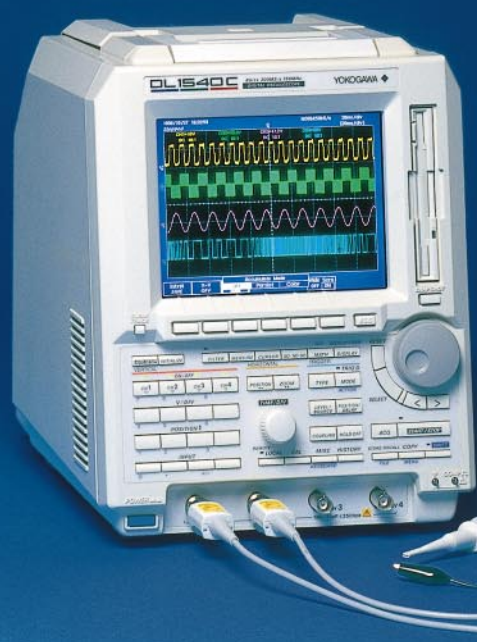
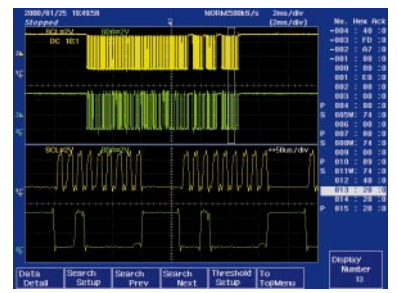

DL1540C
DL1540CL



Waveform Capturing Functions

Long Memory

For high-fidelity signal capturing or extended waveform capturing

The DL1540C/DL1540CL can capture targeted waveforms in long memory. The maximum capacity is 120 k words for the DL1540C and 2 M words for the DL1540CL. All measurements taken by the DL1540C/DL1540CL are divided into fixed intervals. Only the maximum and minimum values in each interval are displayed on the screen (peak-to-peak (P-P) compression). Compression makes it possible to display more waveform data on a single screen.

At a given sampling rate, a longer measurement memory makes it possible to capture signals at a finer time resolution so as to display higher fidelity waveforms. During repeat measurements, a portion of memory can be used for signal capturing. The maximum amount is 10 k words with the DL1540C and 100 k words with the DL1540CL. This feature is useful for purposes such as capturing the signals on a single track in a single step during the process of developing and evaluating optical recording media.

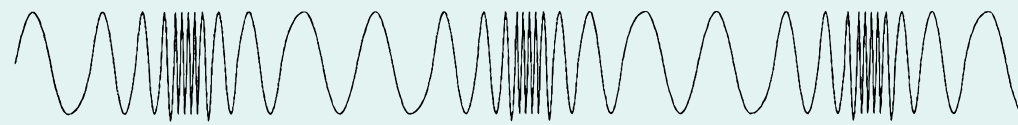

Two Functions to Make Long Memory More Effective

Zoom Function

Simultaneously displays entire waveform and waveform enlargement

The DL1540C/DL1540CL compresses all measurements captured in long memory and then displays the measurements on the screen. The zoom feature is not used to enlarge data on the Main screen (P-P compressed data). Instead, it allows you to select and zoom in on a particular portion of the entire amount of data stored in acquisition memory.

An entire waveform and an enlarged area are simultaneously displayed on the Main Zoom screen, so the enlarged area in the Main Zoom box is easy to identify. The optional built-in printer can be used to print just the enlarged portion of the waveform.



History Memory Time Stamp Display

Time Stamp	Time Stamp	Time Stamp	Time Stamp	Time Stamp
#-68 18:31:58	#-78 18:31:58	#-88 18:31:58	#-98 18:32:00	#-18 18:32:00
#-69 18:31:59	#-79 18:31:59	#-89 18:31:59	#-99 18:32:00	#-19 18:32:00
#-67 18:31:59	#-77 18:31:59	#-87 18:31:59	#-97 18:32:00	#-17 18:32:00
#-66 18:31:59	#-76 18:31:59	#-86 18:31:59	#-96 18:32:00	#-16 18:32:00
#-65 18:31:59	#-75 18:31:59	#-85 18:31:59	#-95 18:32:00	#-15 18:32:00
#-64 18:31:59	#-74 18:31:59	#-84 18:31:59	#-94 18:32:00	#-14 18:32:00

History Memory Function

Stores captured waveform screens and redisplay the desired waveform

When waveforms are displayed on an oscilloscope while troubleshooting an electric circuit, an abnormal waveform that appears momentarily will unfortunately disappear quickly from the screen and be replaced by the next waveform. The history memory function is designed to overcome this problem. It stores a maximum of 100 past waveform screens (extending back from the currently observed waveform), making it possible to redisplay an abnormal waveform that is no longer on the screen. It is also possible to stack all of the screens stored history memory on the LCD. The history memory function splits up long memory so that it can be used more effectively.

The sequential store function is also useful. This function displays waveforms meeting certain preset conditions after they are measured a specified number of times. By eliminating the need to display a waveform after every single measurement, the sequential store function reduces the dead time involved in signal capturing.

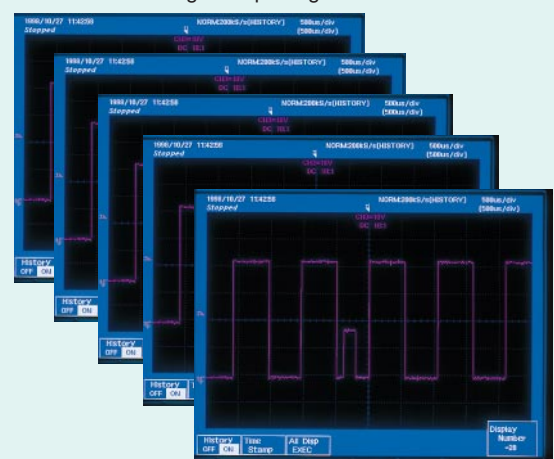

Fast Screen Refresh Rate

Screen refreshing is fast even with a large number of observed waveforms or during simultaneous waveform processing

Oscilloscopes with fast screen refresh rates normally experience a slowdown in the refresh rate when the number of observed waveforms is increased or during processes such as automated measurement of waveform parameters. The DL1540C/DL1540CL was designed first and foremost to minimize the waveform acquisition interval in order to ensure that the desired waveforms are reliably captured. The maximum screen refresh rate is 60 Hz, even when all channels are used. Signal processing may even be added without lowering the screen refresh rate during waveform observation.

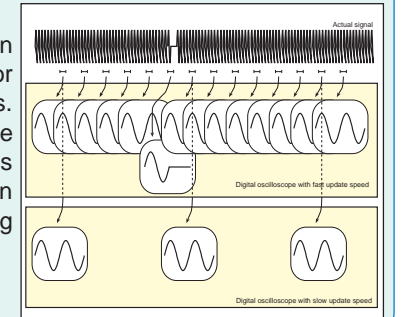

Color Accumulate

Effective during jitter measurement and evaluation

The DL1540C/DL1540CL has a 6.4-inch color TFT LCD with a wide viewing angle to facilitate waveform identification. The color accumulate feature makes it possible to identify the rate of incidence of a given measurement based on the color assigned to it. As a result, it is easy to distinguish between normal and rare abnormal signals and to perform jitter evaluations.

The color accumulate feature makes it possible to display rates of incidence of various measurements in addition to voltage levels and time-axis data.

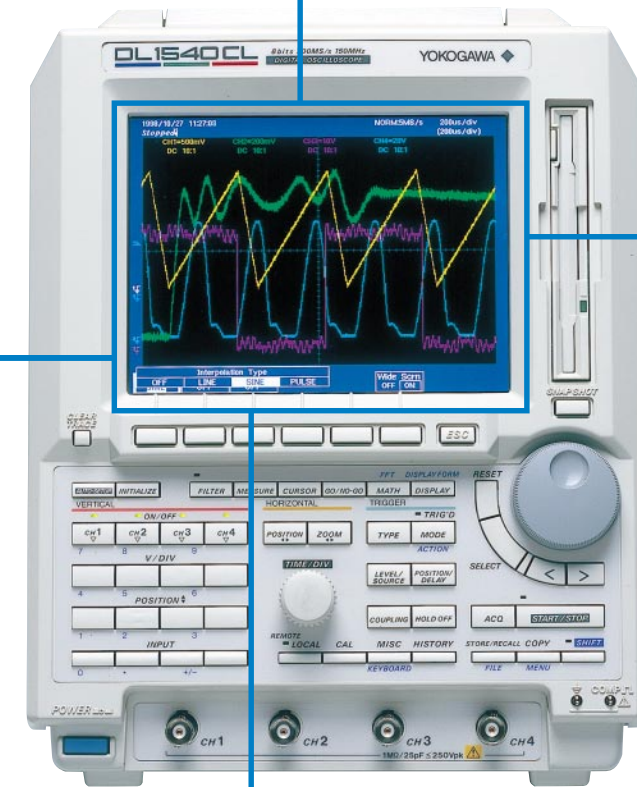

Envelope and Roll Modes

Select the optimum display mode based on the measured signal speed

The envelope mode always captures signals at a fast 100 MS/s sampling rate, regardless of the time-axis setting. This function is effective for purposes such as observing high-frequency noise on a measured signal, and observing surge signals that occur intermittently.

The roll mode is used to display low-speed signals on the screen as if they were being recorded on recorder chart paper. In roll mode, a waveform flows from right to left on the screen. The oscilloscope always keeps two screens of data in memory, so a waveform can be redisplayed after it disappears from the left side of the screen.



Roll Mode Display

Waveform Analysis Functions

Automated Measurement of Display Parameters

Select from over 20 different parameters

Waveform parameters such as maximum voltage, frequency, duty ratio, and RMS can be measured automatically. Parameter measurements are automatically calculated inside the oscilloscope to prevent human reading errors from affecting measurements. The ALL Scan EXEC function, which measures all points in the acquisition data captured in long memory, can be used for highly precise waveform parameter calculations. A total of 24 automatically measured parameters can be displayed on four channels.

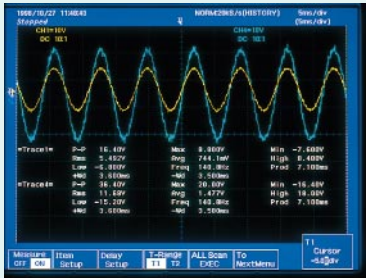

Pulse Counting Function

Calculates and displays the number of pulses automatically

This feature can be used to automatically calculate the number of pulses for waveforms in a range specified by the cursor. This function automatically counts pulse signals from stepping motors and other equipment, providing rotational angle data. It can also count track error signals from optical disks and other media in order to evaluate the amount of pickup movement. The pulse count function is also useful for counting interrupt signals during software debugging. The ALL Scan EXEC function can be used for accurate counting even on P-P compressed waveforms.

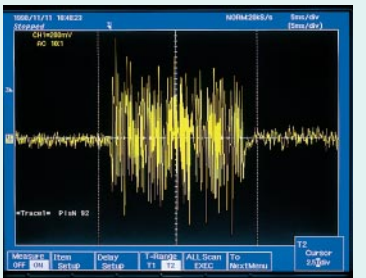

Measurement of Track Error Signal on an Optical Disk

Waveform Calculation Function

For calculating power and other parameters

The waveform calculation function can be used to perform calculations such as addition, subtraction, and multiplication between channels. The phase shift between channels can be applied to calculations with the phase shift feature. It is also possible to correct the phase shift between input signals in calculating parameters such as consumed power.

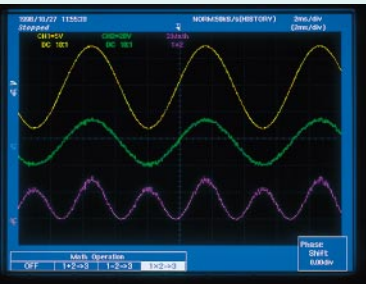

MATH Calculation Waveform Example

FFT Analysis

For analysis of frequency components

The FFT function is used in combination with the cursor to read signal parameters such as frequency components and signal level. A rectangular window (RECT) or a Hanning window (HANNING) can be selected as the time window. It is easy to measure the frequency or level at a given position using the cursor.

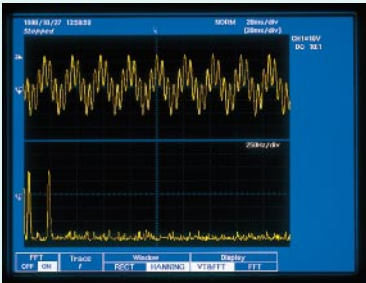

FFT Calculation Waveform Example

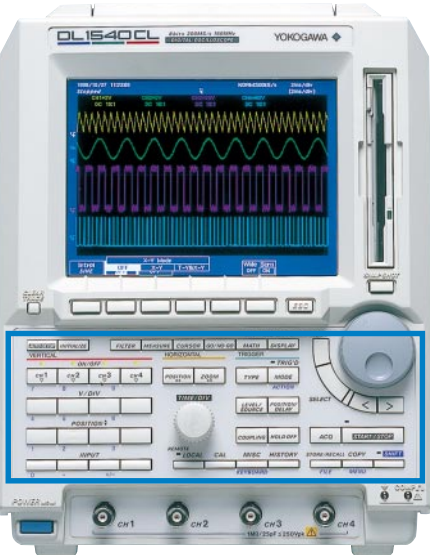

Linear Scaling Function

Allows the user to convert voltage units into physical values

This feature converts measured voltages to physical values, allowing sensor signal outputs to be read directly. When a set scaling coefficient A and an offset B are entered, the scaled value is calculated based on the following equation:

$$Y \text{ (scaled value)} = A \cdot X \text{ (measurement)} + B$$

Parameters can then be measured automatically based on the scaling value. Scaled values can be set in the desired unit of measurement (e.g., mA, A, kg, Pa, rpm, m/s). This feature is useful for directly reading sensor signal outputs.



Cursor Measurement

Measurement lines that move over the screen

When vertical or horizontal cursors are set on the screen, a parameter difference (e.g., time difference or voltage difference) between the cursors can be read as a physical value. The degree cursor function can be used to display a phase offset from a reference position as a degree (deg) value. This function is useful with measurements that require measuring a phase difference, such as measurements involving an encoder, motor or engine. Cursors can be combined with the zoom function to obtain higher-resolution measurements.

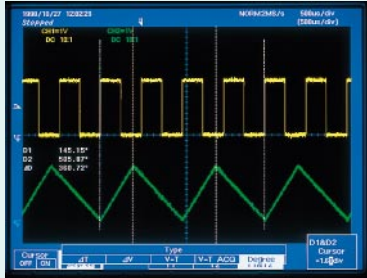

GO/NO-GO Evaluation

Waveform check and automatic identification of abnormal waveforms

With this function, a zone or waveform parameter is specified for a measured waveform, and the measured signal is evaluated to automatically determine which action to perform. The following actions can be selected based on this evaluation:

- Print data on the built-in printer
- Save acquisition data or P-P compressed data (to a floppy disk or an internal HDD*)
- Save screen image data (to a floppy disk or an internal HDD*)

Evaluations can be performed on four channels simultaneously, and it is possible to set AND or OR conditions for an evaluation.

*An optional internal hard disk drive is available with the DL1540CL.

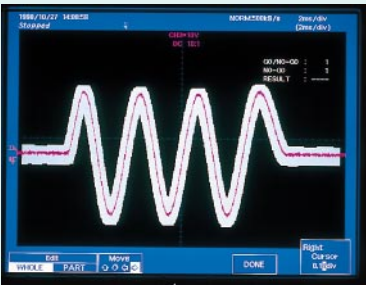

Zone Evaluation Measurement Example

A created area is used as a reference in evaluating an input signal. Vertical and horizontal ranges are established around the reference waveform to create the evaluation area. Area data on as many as four waveforms can be stored internally. An evaluation can be made based on the input signal when it enters the evaluation area, or when it exits the evaluation area.



Parameter Evaluation Setting Screen

A range is set for the parameter selected for waveform parameter measurement. An evaluation can be made when an input signal enters or exits the range.

Waveform Recording

* An optional built-in printer is required to print captured waveforms.

Hard Copies, Long Copies and Real-time Printing

Printing screen waveforms

The optional built-in printer can be used to print screenshots. The printer can output hard copies on 112 mm (width) thermal paper. In addition to screenshot hard copies, settings and parameter measurements can be printed at the same time.

The long copy function allows you to print an enlarged waveform spread over multiple pages (several tens of pages). This feature can be used to zoom in on a desired area and print just that area.

The built-in printer can also be used like a recorder to continuously print low-speed signals. The chart speed can be varied based on the time-axis range setting. The maximum speed is 16.7 mm per second. When used in envelope mode, this function can be used to print even high-speed surge signals (microsecond- and nanosecond-order signals) that cannot be captured with a recorder.

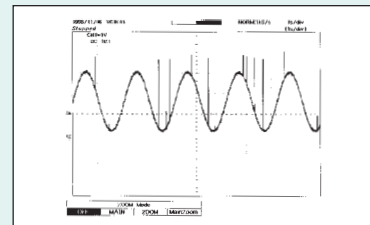

Hard Copy Printout Example

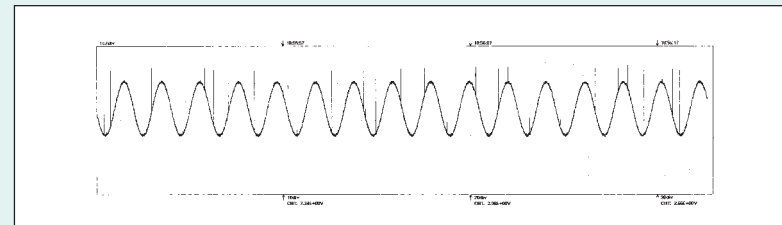

Real-time Printout Example

Saving and Loading Waveform Data and Settings

Saving in binary and ASCII formats

Displayed waveform data and settings can be saved and loaded through the methods shown below.

- Saving and loading waveform data
 - P-P compressed data can be saved and acquisition data can be saved to floppy disks or internal HDD* in both binary and ASCII formats.
 - P-P compressed data can be loaded and acquisition data can be loaded from floppy disks or internal HDD* in binary format only.
 - As many as four waveforms can be stored in or recalled from nonvolatile memory (P-P compressed data only).
- Saving and loading settings
 - Settings can be saved to and loaded from floppy disks or internal HDD*.
 - As many as four settings can be stored in or recalled from nonvolatile memory.

*An optional internal hard disk drive is available with the DL1540CL.

Output to an External Color Printer

To print color screens on A4 paper



A commercially available GP-IB/Centronics conversion adapter can be connected to the standard GP-IB interface on the oscilloscope to print data on an external color printer.

The following printer commands are supported: BJ (black and white and color), ESC-P (black and white and color), ESC-P2 (ESC-P raster: black and white and color), LIPS3 (black and white), PR201 (black and white), PCL5 (black and white and color)

Optional 2.1GB internal hard disk drive (available with DL1540CL) **NEW!**

An optional 2.1GB internal hard disk drive is available with the DL1540CL large recording memory model, which has a maximum memory length of 2 Mwords. The hard disk drive makes it easy to save and load long memory data measured in a single shot, as well as large amounts of data representing repeated measurements.

Snap shot

The color display makes waveform comparison easier

The snap shot function makes it easy to compare waveforms on the screen. It allows a displayed waveform to be saved on the screen through a single touch action. Saved waveforms can be compared with newly captured waveforms.

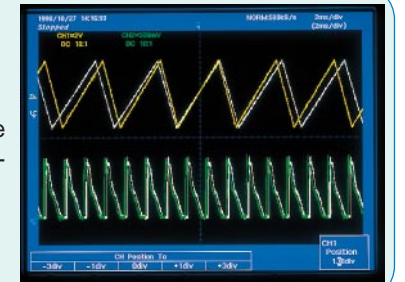

Color Image Files

To add color images to your reports

With the DL1540C/DL1540CL, screenshots can be saved to the standard floppy disk or optional internal HDD* as image files. Screenshot files can be saved in BMP, PostScript, TIFF and HP-GL formats. It is easy to create a report containing waveform images by simply inserting screenshots when creating the report in a word processor. Screenshots can be enlarged or reduced as desired, eliminating the need for cutting and pasting. Screenshot image files can also be sent as email attachments.

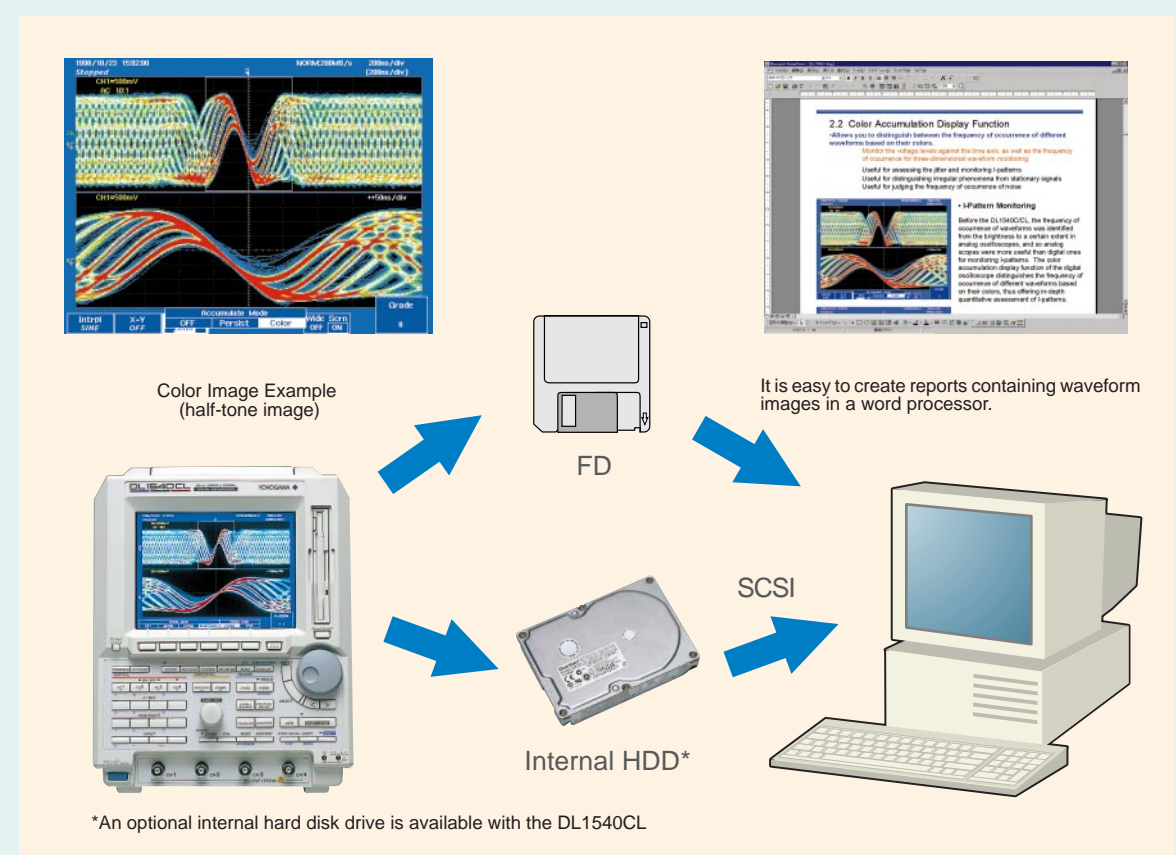

*An optional internal hard disk drive is available with the DL1540CL

A Wealth of Trigger Functions

The DL1540C/DL1540CL supports a wide variety of triggers.

Edge trigger This trigger is activated by ordinary edges.

Window trigger This trigger is set as a given fixed voltage range (window). It is activated when the trigger source level either enters or exits the voltage range.

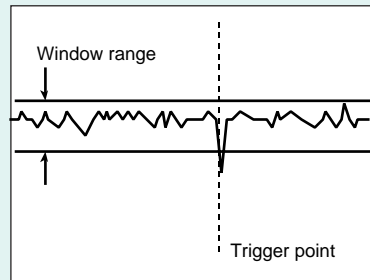

TV trigger This trigger is used to capture video signals (NTSC, PAL, HDTV).

OR trigger (optional) This trigger is activated when any of the trigger conditions set on a given channel is established.

Pattern trigger (optional) With this trigger, conditions are set on each channel. It is activated when a combination of trigger conditions among the channels is established.

Pulse width trigger (optional) This trigger is activated based on a comparison of the input pulse width against a specified time span which determines whether the pulse width is short or long. It is also possible to set a time-out trigger, which is activated when a specified time span elapses without a change in a pulse state (high level or low level).

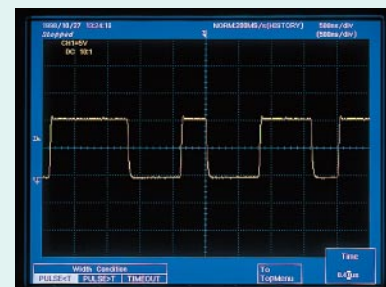
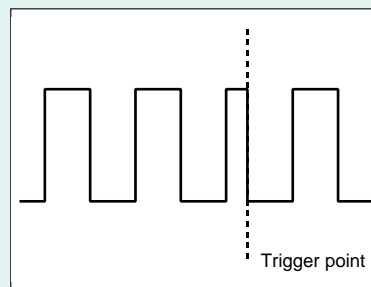
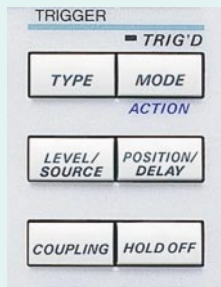

Action On Trigger

To reliably and automatically record (save) captured waveform data

Each time a trigger is activated and a waveform is captured and displayed on the screen, this feature automatically prints the waveform on the built-in printer or saves it as a file. The Action On trigger is useful for purposes such as data acquisition during automated continuous tests.



Action On Trigger Setting Screen

Connecting the DL1540C/DL1540CL to Peripheral Units

VGA Output (Optional)

The VGA output port can be connected to an external monitor to display waveforms on the monitor. A commercially available VGA/NTSC converter can be used for extended waveform recording in video format.



GO/NO-GO Evaluation Output (for DL1540CL only; when option /C8 is selected)

NEW!

Waveform evaluations made with the GO/NO-GO function are output as TTL level signals. If option /C8 is not selected, then option /V1 can be selected to add a VGA output connector.

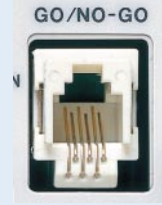

GP-IB Interface

An external printer can be directly connected to the oscilloscope via a commercially available GP-IB /Centronics conversion adapter.

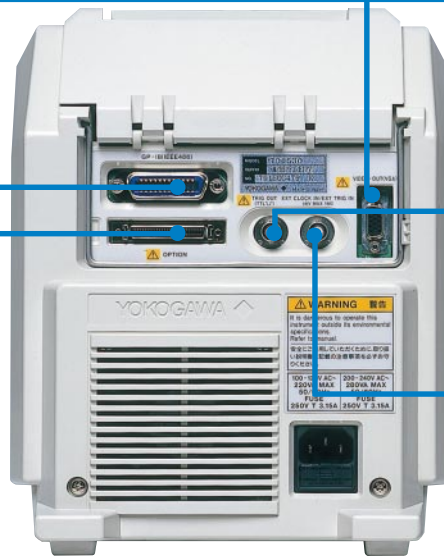

Trigger Output

The trigger output port can be used to output a signal to an external device when a trigger is activated.

Trigger Input/External Clock Input

This port is used to input an external input signal or a clock signal serving as a time reference.

SCSI interface (for DL1540CL only; when option /C8 is selected)

The SCSI interface lets you connect external SCSI devices, such as magneto-optical drives or hard disk drives. If option /C8 is not selected, an option box connector is provided as a standard feature.

NEW!



Option Box Connector

The option box connector is used to control a 700926 isolator or SCSI interface unit through the oscilloscope. It can also be used as an output terminal for the GO/NO-GO evaluation.

Connection with Isolator (700926) (Sold separately)

An insulated input unit can be combined with the DL1540C/DL1540CL for isolated input measurement of floating signals or other signals at a maximum rate of 200 MS/s.



Connection with RS-232-C Unit (700927) (Sold separately)

The unit has a terminal for outputting a GO/NO-GO evaluation signal.



Connection with SCSI Interface Unit (700930) (Sold separately)

This unit lets you connect external SCSI devices, such as magneto-optical drives and hard disk drives.



DL1540C / DL1540CL

Specifications

Vertical Unit

Number of input channels:	4
Vertical resolution:	8 bits (in normal mode) (25 LSB/div) 9 bits (in smoothing mode) 12 bits (after averaging with a 256 weighting)
Maximum sampling rate:	Normal 200 MS/s (using half of the available channels) 100 MS/s (using all channels) Equivalent time: 20 GS/s
Effective storage frequency (-3dB):	Repeated waveform DC to 150 MHz ⁽¹⁾ Single waveform DC to 80 MHz ⁽²⁾ (using half of the available channels) DC to 40 MHz ⁽²⁾ (using all channels)
Sensitivity:	1 mV/div ⁽³⁾ to 5 V/div
DC accuracy ⁽⁴⁾ :	At 100 mV/div $\pm(1.5\%$ of 8 div + 1 LSB) At 1 mV/div $\pm(5\%$ of 8 div + 1 LSB) Other ranges $\pm(2.5\%$ of 8 div + 1 LSB)
Offset voltage accuracy:	1 m to 50 mV/div $\pm(2.5\%$ of setting + 0.2 mV) 100 m to 500 mV/div $\pm(1\%$ of setting + 2 mV) 1 to 5 V/div $\pm(2.5\%$ of setting + 20 mV) Inter-channel isolation: -40 dB (typical value ⁽⁵⁾ for the same range)
Maximum input voltage:	250 V (DC + AC peak) (max. 1 kHz) (CAT I & II, 177 V rms)
Input impedance:	1 MW $\pm 1.5\%$ (approximately 25 pF)
Input coupling:	AC / DC / GND

Horizontal Unit

Sweep time:	5 ns/div to 50 s/div
Time-axis accuracy:	$\pm(0.01\% + 500 \text{ ps})$ ⁽⁶⁾
Maximum record length (DL1540CL):	2 M words (2 channels at the same time) 1 M word (3 or 4 channels at the same time)
Maximum record length (DL1540C):	120 k words (2 channels at the same time) 56 k words (3 or 4 channels at the same time)
External clock input:	EXT CLOCK IN input 40 Hz to 15 MHz ⁽⁷⁾ CH4 input ⁽¹¹⁾ 40 Hz to 80 MHz ⁽⁷⁾

Trigger

Modes:	AUTO / AT-LVL / NORMAL SGL (S) ⁽⁹⁾ / SGL (L) ⁽⁹⁾ SINGLE ⁽¹⁰⁾ / N-SGL: sequential store
Sources:	CH1 / CH2 / CH3 / CH4 / EXT / LINE
Coupling:	AC / DC / HF Rej
Sensitivity:	1 div p-p (DC to 150 MHz)
Types:	Edge NTSC / PAL / HDTV Window ⁽⁸⁾ OR (optional) Pattern (optional) Pulse width (optional)
External trigger input:	Range $\pm 6 \text{ V}$ Level 1.5V / 0.15 V Frequency band DC to 15 MHz

Screen Refresh Rate

Using one channel:	Maximum 60 Hz
Using all channels:	Maximum 60 Hz

Display

Display:	6.4-inch color TFT LCD with wide viewing angle
Resolution:	640 × 480 (Approximately 0.02% of the total number of pixels in the LCD unit may be defective.)
Waveform resolution:	501 × 401 (601 × 401 in wide display mode)
Display types:	Zoom MAIN / ZOOM / Main Zoom X-Y T-Y / X-Y / T-Y & X-Y
Accumulate display (stack):	PERSIST Stacking in one color. COLOR Stacking in eight colors encoded according to the rate of incidence of various measurements.
Number of display traces:	Maximum 8 traces Four captured waveforms and four enlarged waveforms (in Zoom mode)

Extended Functions

Calculation:	Addition, subtraction, multiplication, FFT (1000-point power spectrum)
GO/NO-GO evaluation:	Zone evaluation: All waveforms can be evaluated at the same time.
Parameter evaluation:	Evaluations can be made based on a combination of four parameters.
Automated measurement of waveform parameters:	As many as 23 parameters can be measured per trace. Parts can be measured simultaneously on all traces, and automated measurements can be displayed on the screen. As many as 24 parameters can be displayed.
Measured parameters:	Peak to Peak (P-P), maximum value (MAX), minimum value (MIN), most frequent high voltage value (HIGH), most frequent low voltage value (LOW), average value (AVG), root mean square (RMS), overshoot (OVERSHOOT), undershoot (UNDERSHOOT), rise time (RISE), fall time (FALL), frequency (FREQ), period (PERIOD), +duty (High duty ratio), +WIDTH (High pulse width), -WIDTH (Low pulse width), INTEG1 TY, INTEG2 TY (area calculated TY), INTEG1 XY, INTEG2 XY (area calculated XY), DELAY (edge rise or fall time difference), burst width (BURST), pulse count (PlsN)
Supported image formats for saving data:	HP-GL, PostScript, TIFF, BMP
Snapshot:	An unlimited number of waveforms can be accumulated on the screen by pressing the snapshot key.

I²C bus analysis function (option for DL1540CL only)

• Applicable bus	I ² C bus:	Bus transfer rate: Maximum 400 kbps Address mode: 7 bit Complies with System Management Bus
• Analysis Functions	SM bus:	Complies with System Management Bus
Detailed data display mode:	Data transferred time starting at trigger point Data (simultaneous binary and hex notation) Acknowledgement exist/not exist	
Waveform & data display mode:	Simultaneous display of data (hex notation) and waveform	
Maximum analyzed data size:	1000 bytes before and after a trigger point	
• Trigger	Trigger source:	CH1: SCL CH2: SDA CH3, CH4: Analog signal inputs
Start trigger:	Based on start conditions	
Non-ACK trigger:	When there is no acknowledgement	
Address trigger:	Comparison with set address	
Data trigger:	Comparison with set data (one or two bytes can be set)	
Byte count trigger:	Maximum count setting is 8191	
Combination trigger:	Address, Data and Byte Count trigger types combined	
Mixed pattern trigger:	Trigger consisting of parallel pattern of CH3/CH4 analog signals and I ² C bus analysis trigger types can be set	

External Interfaces

- GP-IB interface

Electrical and mechanical specifications:

Conforming to IEEE std. 488-1978

Protocol: Conforming to IEEE std. 488.2-1987

- RS-232-C interface (available through RS-232-C interface unit)

Baud rates: 75 / 150 / 300 / 600 / 1200 / 2400 / 4800 / 9600 / 19200

- Centronics interface

Supported print commands:

BJ, ESC-P, ESC-P2, LIPS3, PR201, PCL5
(available through GPIB/Centronics adapter)

SCSI Interface (DL1540CL, when option /C8 is selected)

Standard: SCSI, ANSI X3. 131-1986

Connector Type: Half-pitch 50-pin

Connector pin assignment: Unbalanced (single-end)

(or available through special SCSI interface unit)

Signal I/O

- TRIG OUT: TTL level

- GO/NO-GO evaluation: TTL level (through option box connector)

- VGA video signal output (optional)

Connector type: D-Sub 15-pin (VGA VIDEO OUT)

Output format: VGA compatible

3.5-inch FDD

Usable disk types: 640 kB / 720 kB / 1.2 MB / 1.44 MB

Format: MS-DOS*

Internal Hard Disk Drive (option for DL1540CL only)

Number of Drive: 1

Size: 3.5 inches

Capacity: 2.1 GB

Windows compatibility: The internal Hard Disk Drive can be connected to a PC running Windows95, Windows98 or WindowsNT via the SCSI interface.

SCSI ID: 4 (fixed)

Built-in printer (optional)

Printer type: Thermal head

Dot density: 6 dots per mm

Paper width: 112 mm

Real-time printing: Maximum chart speed is 16.7 mm per second.
(Works with time-axis ranges slower than 500 ms/div.)

General Specifications

Operating temperature range: 5 to 40°C

Operating humidity range: 20 to 85% RH (without printer)

35 to 85% RH (with printer)

Source voltage: 100 to 120 V AC / 220 to 240 V AC (switches automatically)

Source frequency: 50 / 60 Hz

Power consumption: 280 VA max

External dimensions: 216 mm (W) × 268 mm (H) × 278 mm (D)
(excluding protrusions)

Weight: Approximately 4.9 kg (DL1540C)

Approximately 5.2 kg (DL1540CL)

*1: In range of 5 V/div to 10 mV/div. DC to 80 MHz at 5 mV/div; DC to 20 MHz at 2 mV/div or 1 mV/div.

*2: In range of 5 V/div to 5 mV/div. DC to 20 MHz at 2 mV/div or 1 mV/div.

*3: 1 mV/div can be obtained by 2 mV/div zooming.

*4: At reference temperature (23 ±2°C, 55 ±10% RH)
30 minutes after warmup, following calibration.

*5: A typical value is a common or average value; there is no guarantee of a precise value.

*6: At reference temperature (23 ±2°C, 55 ±10% RH)
30 minutes after warmup.

*7: Continuous clock signal only.

*8: Only works with CH1.

*9: DL1540C

*10: DL1540CL

* MS-DOS, Windows, and MS Word are registered trademarks of Microsoft Corporation.

* PostScript is a registered trademark of Adobe Systems Incorporated.

* HP-GL is a registered trademark of Hewlett-Packard Company.

Soft case (for probes, etc.)



Carrying case



PC Utility Software for DL Series

Waveform Viewer for DL series

Waveform Viewer for DL series is a software program that allows a PC to display waveform files (with “wvf” extension) from measurements made with a DL series digital oscilloscope. The program can display as many as 24 analog waveforms at the same time.

•Zoom and scrolling display

The display can be zoomed to a specified enlargement magnification. It is also easy to zoom along the vertical axis of a waveform using the mouse, and the zoom box can be moved (scrolled) automatically and continuously. Scroll speed is adjustable.

•History display and X-Y display

History mode allows you to display a list of multiple waveforms captured in history memory. You can also stack multiple displayed waveforms, and select which waveforms to stack.

X-Y display mode lets you create a graph with any waveform set on the X-axis.

•Conversion to ASCII format

Waveform files can be converted to ASCII format (CSV format). You can convert all of the data in a file, or just a zoomed area.

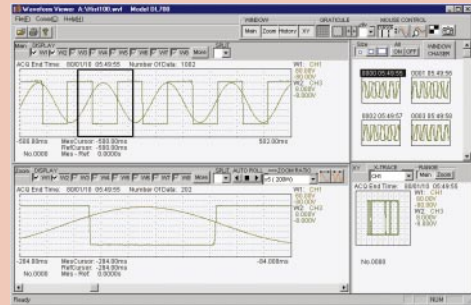

■ Specifications

Waveform Display

- File types: Waveform files in waveform format (with “wvf” extension) and waveform files recorded in real-time (when “rtm” extension)
- Data transfer methods:
 - ① Via SCSI interface (access the DL hard drive from your PC)
 - ② Via floppy disk
 - ③ Via GP-IB interface (National Instruments GP-IB boards and PCMCIA boards supported)
 - ④ Via RS-232 interface
- Number of displayed waveforms: Maximum 24 simultaneous analog waveforms + maximum 24 zoom waveforms (file specified); logic waveform display capability
- File capacity: A maximum of 512 M of P-P compressed data can be displayed.
- Zooming: The zoom magnification can be specified. Zooming is possible on both the vertical and horizontal axes.
- Zoom window scrolling: The zoom position moves (scrolls) continuously in the time-axis direction. The scroll speed can be adjusted (5 levels).
- Waveform movement: Drag a waveform with the mouse to move it up or down in the window. (as many as 14 waveforms)
- Screen dividing: The screen can be divided into as many as 16 different windows (Main and Zoom screens).
- Display scale setting: The upper and lower limits for the waveform display window can be entered (modified) directly.
- History display: Multiple waveforms can be displayed at the same time, and can be stacked.
- X-Y display: Put any waveform on the X-axis.
- Saving image files: A displayed waveform window can be saved in BMP format.

Calculation Function

- Cursor measurement

Printing Function

- Displayed waveforms can be output to a printer, and comments can be entered.

Waveform Data Conversion

- Real-time data files (with “rtm” extension) can be converted to waveform format (“wvf” extension). (Files can be compressed to 1/100 or 1/1000 when saved.)
- Real-time data files and waveform files can be converted to ASCII (CSV) format. It is also possible to convert just a zoomed area.

You can download a trial version of Waveform Viewer for DL series from Yokogawa’s web site. Point your browser to <http://www.yokogawa.co.jp/Measurement/English/TI-e/700919/700919-e.html> See our site for detailed product information.

■ Model and Suffix Code

Model	Description
700919	Waveform Viewer for DL series

DL1540C/DL1540CL Model and Suffix Codes

Model	Suffix Code	Model
701530		DL1540C digital oscilloscope
701540		DL1540CL digital oscilloscope
Power cable	- D	UL, CSA standard
	- F	VDE standard
	- Q	BS standard
	- R	SAA standard
Options	/B5	Built-in printer *1
	/F1	Enhanced trigger *2
	/F5	I ² C bus analysis function *2 (701540 only)
	/E1	Additional probes (2) *3
	/V1	VGA output *4
	/C8	2.1-GB internal hard drive *4, *5 (701540 only)

*1) One roll of paper (B9850NX) is included.

*2) /F1 and /F5 cannot both be selected. /F5 includes /F1 (extended trigger function).

*3) Two probes (700998) are included with the oscilloscope.

*4) /V1 and /C8 cannot both be selected. The option box cannot be used when /C8 is selected.

*5) When option /C8 is selected, the SCSI interface and GO/NO-GO output connector are included.

Accessories (optional)

Product	Code	Specifications	Order Quantity
Carrying case	700915	340 mm (W) × 290 mm (H) × 225 mm (D)	1
RS-232-C interface unit	700927	Option box connector connection	1
SCSI interface unit	700930	Option box connector connection	1
Front cover	700917	Transparent type	1

Related Products

Product	Code	Specifications	Order Quantity
Isolator	700926	2CH, DC to 30 MHz (-3 dB)	1
Insulated probe	700929	For insulated input unit	1
Differential probe	700924	100 MHz bandwidth	1

Standard Accessories

Product	Quantity
Power cable	1
Probe (700998)	2
Set of manual	1
Soft case (B9918EZ; for probes, etc.)	1
Front cover (B9957DG)	1

See the DL series accessory catalog for other accessories.

Spare Parts

Product	Code	Specifications	Order Quantity
Roll paper for printer	B9850NX	30 meters (one roll = 1 unit)	5
150 MHz passive probe	700998	Switching between 10:1 and 1:1; 1.5 meters	1
Soft case	B9918EZ	For probes, etc.	1
Front cover	B9957DG	For protecting TFT LCD and front panel	1

Accessories for 700998 Probe (optional)

Product	Code	Specifications	Order Quantity
Miniclip converter	B9852CR	Probe accessory (1/unit)	1
BNC adapter	B9852CS	Probe accessory (1/unit)	1
Ground lead (miniclip type)	B9852CT	Probe accessory (1/unit)	1
50 Ω terminator	700976	Through type	1

Dimensions

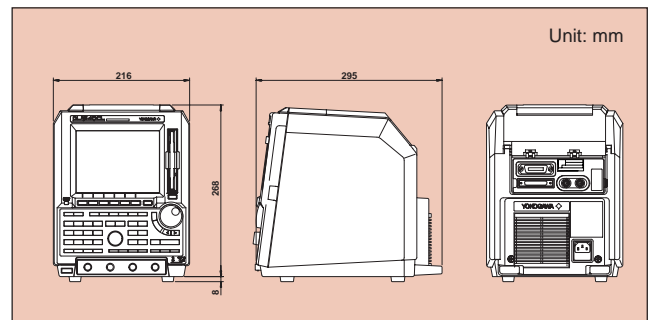

Related Models

Digital Oscilloscope DL1520,DL1520L

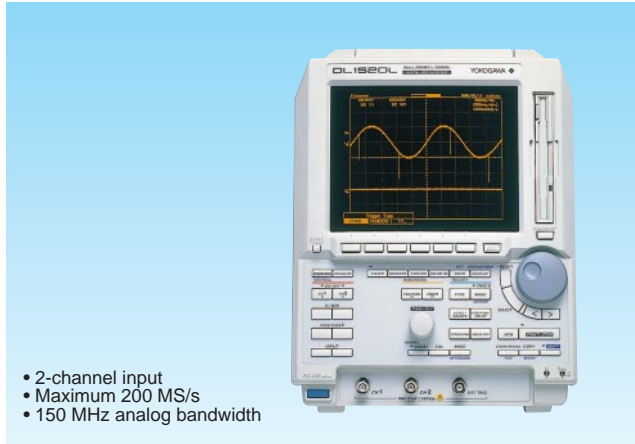

- 2-channel input
- Maximum 200 MS/s
- 150 MHz analog bandwidth

Digital scope DL708E

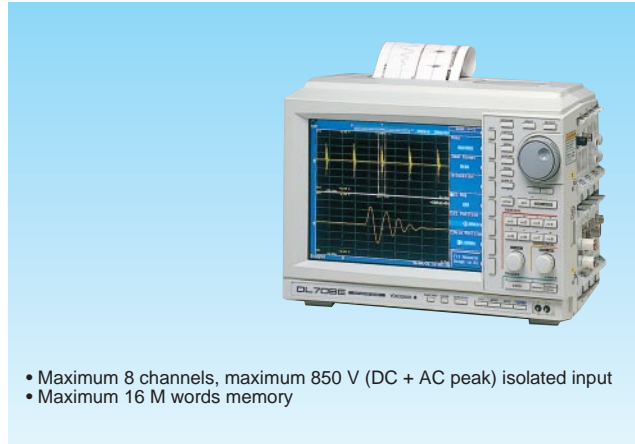

- Maximum 8 channels, maximum 850 V (DC + AC peak) isolated input
- Maximum 16 M words memory

Digital Oscilloscope DL2700

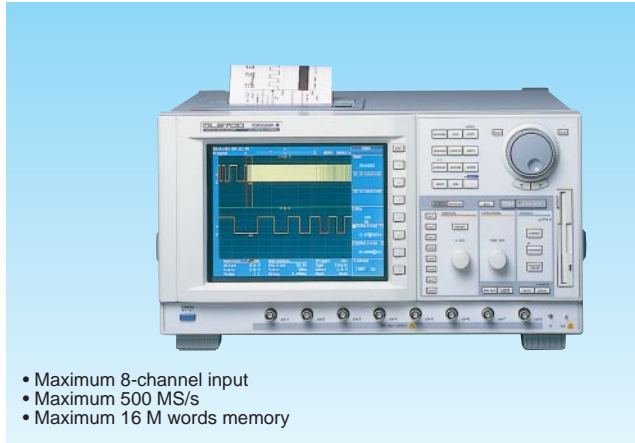

- Maximum 8-channel input
- Maximum 500 MS/s
- Maximum 16 M words memory

Time Interval Analyzer TA520

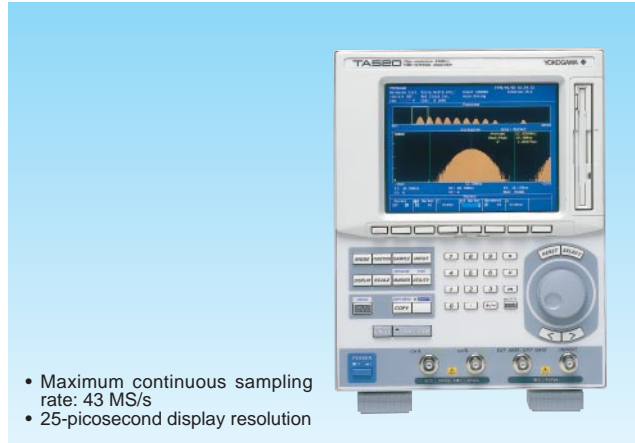

- Maximum continuous sampling rate: 43 MS/s
- 25-picosecond display resolution



YOKOGAWA ELECTRIC CORPORATION Measurement Sales Dept.

9-32, Nakacho 2-chome, Musashino-shi,
Tokyo 180-8750, JAPAN

Phone: 81-422-52-6614, Fax: 81-422-52-6624

YOKOGAWA CORPORATION OF AMERICA

2 Dart Road, Newnan, Georgia 30265, U.S.A.
Phone: 770-253-7000, Fax: 770-251-2088

YOKOGAWA EUROPE B.V.

Vanadiumweg 11, 3812 PX Amersfoort, THE NETHERLANDS
Phone: 31-33-4-641611, Fax: 31-33-4-631202

YOKOGAWA ENGINEERING ASIA PTE. LTD.

11 Tampines Street 92, Singapore 1852, SINGAPORE
Phone: 65-783-9537, Fax: 65-786-6650

YOKOGAWA ELECTRIC CORPORATION

Test & Measurement Business Division
155 Takamuro-cho, Kofu-shi, Yamanashi-ken, 400-8558 Japan
Phone: 81-552-43-0310, Fax: 81-552-43-0396

Represented by :

ML-06E