**Service
Manual**

**DL1720E/DL1740E/DL1740EL
Digital Oscilloscope**

Important Notice to the User

This manual contains information for servicing YOKOGAWA's DL1720E/DL1740E/DL1740EL Digital Oscilloscope. Check the serial number to confirm that this is the correct service manual for the instrument to be serviced. *Do not use the wrong manual.* Before any maintenance and servicing, read all safety precautions carefully. *Only properly trained personnel* may carry out the maintenance and servicing described in this service manual. *Do not disassemble the instrument or its parts*, unless otherwise clearly permitted by this service manual. *Do not replace any part or assembly*, unless otherwise clearly permitted by this service manual.

In principle, Yokogawa Electric Corporation (YOKOGAWA) does not supply parts other than those listed in the customer maintenance parts list in this service manual (mainly *modules* and *assemblies*). Therefore if an assembly fails, the user should replace the whole assembly and not components within the assembly (see "Note"). If the user attempts to repair the instrument by replacing individual components within the assembly, YOKOGAWA assumes no responsibility for any consequences such as defects in instrument accuracy, or functionality, reliability, or for user safety hazards. YOKOGAWA does not offer more detailed maintenance and service information than that contained in this service manual.

All reasonable efforts have been made to assure the accuracy of the content of this service manual. However, there may still be errors such as clerical errors or omissions. YOKOGAWA assumes no responsibility of any kind concerning the accuracy or contents of this service manual, nor for the consequences of any errors.

All rights reserved. No part of this service manual may be reproduced in any form or by any means without the express written prior permission of YOKOGAWA. The contents of this manual are subject to change without notice.

Note

YOKOGAWA instruments have been designed in a way that the replacement of electronic parts can be done on an assembly (module) basis by the user. YOKOGAWA instruments have also been designed in a way that troubleshooting and replacement of any faulty assembly can be done easily and quickly. Therefore, YOKOGAWA strongly recommends replacing the entire assembly over replacing parts or components within the assembly. The reasons are as follows:

- Repair of components can only be performed by specially trained and qualified maintenance personnel with special tools. In addition, repair of components requires various special parts and components, including costly ones. It also requires facilities where highly-accurate and expensive maintenance equipment and special tools are provided.
 - When taking the service life and cost of the instruments into consideration, the replacement of assemblies offers the user the possibility to use YOKOGAWA instruments more effectively and economically with a minimum in downtime.
-

Trademark

- Adobe and Acrobat are trademarks of Adobe Systems Incorporated.
- For purposes of this manual, the TM and ® symbols do not accompany their respective trademark names or registered trademark names.
- Other company and product names are trademarks or registered trademarks of their respective companies.

Revisions

1st Edition: October 2004

2nd Edition: June 2005

Safety Precautions

The following general safety precautions must be observed during all phases of operation, service, and repair of this instrument. Failure to comply with these precautions or with specific warnings given elsewhere in this manual violates safety standards of design, manufacture, and intended use of the instrument. Yokogawa Electric Corporation assumes no liability for the customer's failure to comply with these requirements.

WARNING

This service manual is to be used by properly trained personnel only. To avoid personal injury, do not perform any servicing unless you are qualified to do so. Refer to the safety precautions prior to performing any service. Even if servicing is carried out by qualified personnel according to this service manual, YOKOGAWA assumes no responsibility for any result occurring from this servicing.

Use the Correct Power Supply

Ensure the source voltage matches the voltage of the power supply before turning ON the power.

Use the Correct Power Cord and Plug

To prevent an electric shock or fire, be sure to use the power cord supplied by YOKOGAWA. The main power plug must be plugged into an outlet with a protective grounding terminal. Do not disable protection by using an extension cord without protective grounding.

Connect the Protective Grounding Terminal

The protective grounding terminal must be connected to ground to prevent an electric shock before turning ON the power.

Do Not Impair the Protective Grounding

Never cut off the internal or external protective grounding wire or disconnect the wiring of the protective grounding terminal. Doing so creates a potential shock hazard.

Do Not Operate with Defective Protective Grounding or Fuse

Do not operate the instrument if you suspect the protective grounding or fuse might be defective.

Use the Correct Fuse

To prevent fire, make sure to use a fuse of the specified rating for current, voltage, and type. Before replacing the fuses, turn OFF the power and disconnect the power source. Do not use a different fuse or short-circuit the fuse holder.

Do Not Operate Near Flammable Materials

Do not operate the instrument in the presence of flammable liquids or vapors. Operation of any electrical instrument in such an environment constitutes a safety hazard.

Do Not Remove Any Covers

There are some components inside the instrument containing high voltage. Do not remove any cover if the power supply is connected. The cover should be removed by qualified personnel only.

Ground the Instrument before Making External Connections

Connect the protective grounding before connecting the instrument to a measurement or control unit.

Safety Symbols Used on Equipment and in Manuals



Improper handling or use can lead to injury to the user or damage to the instrument. This symbol appears on the instrument to indicate that the user must refer to the user's manual for special instructions. The same symbol appears in the corresponding place in the user's manual to identify those instructions. In the manual, the symbol is used in conjunction with the word "WARNING" or "CAUTION."



This symbol represents a functional grounding terminal. Such terminals should not be used as protective grounding terminals.

WARNING

Describes precautions that should be observed to prevent serious injury or death to the user.

CAUTION

Describes precautions that should be observed to prevent minor or moderate injury, or damage to the instrument.

Note

Provides important information for the proper operation of the instrument.

Overview of This Manual

This manual is meant to be used by qualified personnel only. Make sure to read the safety precautions at the beginning of this manual and the warnings/cautions contained in any referenced chapter prior to carrying out any servicing.

This manual contains the following chapters:

1 Principles of Operations

Describes the functions of various assemblies and lists safety considerations.

2 Performance Testing

Describes the tests for checking performance of the instrument.

3 Adjustments

Describes the adjustments which can be performed by users.

4 Troubleshooting

Describes procedures for troubleshooting and what to do in case parts need to be replaced.

5 Schematic Diagram

A diagram of the system configuration.

6 Customer Maintenance Parts List

Contains exploded views and a list of replaceable parts.

7 Procedures for Disassembly

Lists the steps required to remove parts from the instrument.

Specifications are not included in this manual. For specifications, refer to IM 701730-01E.

Contents

	Safety Precautions	ii
	Overview of This Manual	iv
Chapter 1	Principles of Operation	
	1.1 Block Diagram	1-1
	1.2 Function of Each Assembly	1-2
	1.3 Function of Each ASIC	1-6
Chapter 2	Performance Testing	
	2.1 Introduction	2-1
	2.2 Tests for the DL1720E/DL1740E/DL1740EL	2-2
	2.2.1 Grounding Test	2-3
	2.2.2 Insulation Resistance Test	2-4
	2.2.3 Withstand Voltage	2-4
	2.2.4 Selftest	2-4
	2.2.5 GP-IB Test	2-5
	2.2.6 Rear Panel Probe Power Supply Test	2-6
	2.2.7 LINE Trigger, Trigger LED, and Hold Off Test	2-6
	2.2.8 Probe Compensation Output and Auto Setup Test	2-6
	2.2.9 Timebase Accuracy Test	2-7
	2.2.10 Input Signal Bandwidth	2-7
	2.2.11 Trigger Sensitivity Test	2-8
	2.2.12 Offset Accuracy	2-8
	2.2.13 DC Accuracy	2-9
	2.2.14 EXT Trigger Level Accuracy Test	2-10
	2.2.15 EXT Trigger Sensitivity and Trigger Out Test	2-11
	2.2.16 EXT Clock Input Test	2-12
Chapter 3	Adjustments	
	3.1 Introduction	3-1
	3.2 Test Environment	3-2
	3.3 Equipment Required	3-3
	3.4 DC Offset Adjustment on the AD Board	3-4
	3.5 Flatness Adjustment on the Analog Board	3-7
Chapter 4	Troubleshooting	
	4.1 Introduction	4-1
	4.2 Flow Chart	4-2
	4.3 Assemblies to Check When an Error Occurs	4-3
	4.4 Power Supply Secondary Voltage	4-6
Chapter 5	Schematic Diagram	
	5.1 Schematic Diagram	5-1
Chapter 6	Customer Maintenance Parts List	
	6.1 Customer Maintenance Parts List	6-1
	6.2 Standard Accessories	6-5

Chapter 7

Procedures for Disassembly

7.1	Flow Chart of Disassembly	7-1
7.2	Removing the Top Cover	7-2
7.3	Removing the Fan Assy	7-3
7.4	Removing the Printer Case	7-4
7.5	Removing the CPU Board Assy	7-5
7.6	Removing the Printer Unit	7-6
7.7	Removing the Inverter Assy	7-9
7.8	Removing the Front Bezel	7-10
7.9	Removing the PC Card Drive/FDD Assy	7-11
7.10	Removing the Key Board Assy	7-12
7.11	Removing the LCD	7-13
7.12	Removing the Power Supply Assy	7-14
7.13	Removing the Input Assy	7-16
7.14	Removing the AD Board Assy	7-19
7.15	Removing the Analog Assy/ET2 Assy	7-21
7.16	Removing the ACQ Board Assy	7-22
7.17	Removing the Ether Board Assy	7-23

1.1 Block Diagram

Block Diagram of the DL1720E/DL1740E/DL1740EL

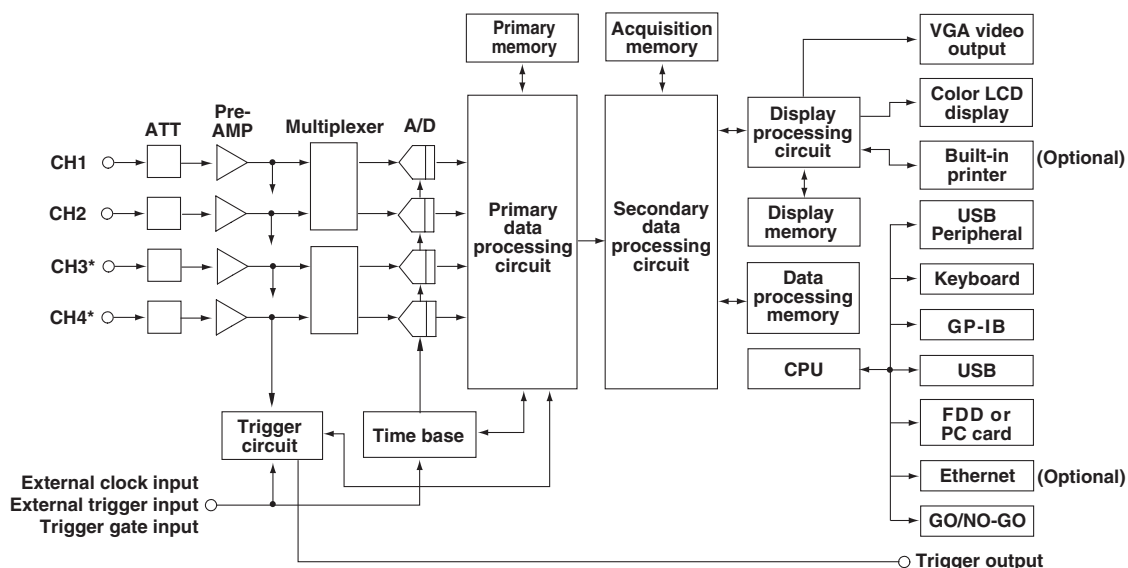

Signal Flow

The signal applied to each signal input terminal is first passed to the vertical control circuit consisting of an attenuator (ATT) and pre-amplifier. At the attenuator and pre-amplifier, the voltage and amplitude of each input signal is adjusted according to the settings such as the input coupling, probe attenuation/current-to-voltage conversion ratio, V/div, and offset voltage. The adjusted input signal is then passed to the multiplexer. The signal input to the multiplexer is passed to the A/D converter according to the time axis and other settings.

At the A/D converter, the received voltage level is converted into digital values. The digital data is written to the primary memory by the primary data processing circuit at the sample rate that matches the time axis setting. The data written to the primary memory is processed (averaged, for example) by the secondary data processing circuit and written to the acquisition memory.

The data written to the acquisition memory is converted into waveform display data by the secondary data processing circuit, transferred to the waveform processing circuit, and stored to the display memory. The waveforms are displayed on the LCD using the data stored to the display memory.

The block diagrams of the DL1720E are shown in figure 1.1 and figure 1.2. The block diagrams of the DL1740E/DL1740EL are shown in figure 1.3 and figure 1.4. Figure 1.1 and figure 1.3 are block diagrams of the circuit from the analog input to the A/D conversion circuit and trigger circuit including the attenuator, one-chip amplifier, analog multiplexer, time base circuit, A/D converter, trigger comparator, and trigger circuit. Figure 1.2 and figure 1.4 are block diagrams of (1) the data processing section which processes the acquired data and displays the waveform, (2) the CPU, and (3) the peripheral circuitry.

1.2 Function of Each Assembly

Analog Board Assembly

The analog board assembly has a coupling switch for AC/DC, 1 M Ω /50 Ω , and GND/Measure and a switch circuit for the attenuator (1:1, 10:1, 100:1, 200:1). Relays are used to make the switch. In addition, a one-chip amplifier IC and an analog multiplexer IC are onboard.

The one-chip amplifier IC has a gain switch circuit, a low-pass filter circuit (external capacitor), a trigger coupling circuit (external capacitor), and a trigger bandwidth limiting circuit (external capacitor). In addition, the input offset voltage and the trigger level are varied using an external DC voltage input. The frequency bandwidth of the IC is approximately 600 MHz.

As indicated in figure 1.1 or figure 1.3, the vertical sensitivity from 10 V/div to 2 mV/div is achieved by switching the gain on the attenuator and the one-chip amplifier IC.

The analog multiplexer IC is used to achieve the interleave operation. During the interleave operation, the input signal of CH1 (CH3) is supplied to the A/D converter of CH2 (CH4). The frequency bandwidth of the IC is approximately 2 GHz.

The above-mentioned control signal, offset, and DC voltage for the trigger level are supplied by the analog front-end controller (AFC) IC on the AD4 board (or the AD2 board for the DL1720E) assembly.

Table 1.1 Setting Range and Amplifying Level

Setting Range	Attenuator Division Ratio	Amplifying Rate
2 mV/div	1/1	$\times 25$
5 mV/div	1/1	$\times 10$
10 mV/div	1/1	$\times 5$
20 mV/div	1/1	$\times 2.5$
50 mV/div	1/1	$\times 1$
100 mV/div	1/10	$\times 5$
200 mV/div	1/10	$\times 2.5$
500 mV/div	1/10	$\times 1$
1 V/div	1/100	$\times 5$
2 V/div	1/100	$\times 2.5$
5 V/div	1/100	$\times 1$
10 V/div	1/200	$\times 1$

The setting range here is for the 1:1 probe setting.

AD4 Board (or AD2 Board for the DL1720E) Assembly

The AD4 board (or AD2 board for the DL1720E) assembly has the time base, trigger, A/D converter, and analog control circuits onboard.

The time base is of a PLL configuration. 1 GHz and 800 MHz can be switched. On the DL1720E/DL1740E/DL1740EL, the frequency of the clock is converted to 500 MHz or 400 MHz using high-speed ECL logic and distributed to each channel. When in interleave mode, the clock for CH2 and CH4 is delayed by 1 ns with respect to the clock for CH1 and CH3, respectively (the DL1720E is not equipped with CH3 and CH4). For making minute time measurements of phase difference between the trigger and sampling clock (needed during repetitive sampling mode, for example), the T-V converter (TVC) is used.

The trigger section consists of a comparator, fast trigger logic (FTL), and pulse width detector (PWD). It also has a TV trigger circuit used only on CH1. The comparator has a window comparator function that allows window triggering. The window width is controlled by an external DC voltage input. The frequency bandwidth of the comparator IC is approximately 1 GHz.

The A/D converter operates at 500 MHz only when the sampling rate is 500 MS/s or when in 1 GS/s interleave mode. In all other cases, the A/D converter operates at 400 MHz. Sampling rates of 200 MS/s or lower are attained by extracting a portion of the data sampled at 400 MHz using the RBC on the ACQ4 board (or the ACQ2 board for the DL1720E) assembly.

The analog control circuit consists of an analog front-end controller (AFC), a PWM D/A converter, and a serial/parallel converter. This circuit controls the analog section of the analog board assembly and the AD board assembly. There are also EXT CLOCK IN, EXT TRIG IN, and TRIG GATE IN functions, as well as an active probe power supply (/P4 or /P2 for the DL1720E) circuit.

ACQ4 Board (or ACQ2 Board for the DL1720E) Assembly

The ACQ4 board (or the ACQ2 board for the DL1720E) assembly has a primary data processing section, a secondary data processing section, and a display section (for displaying waveforms and other information).

The primary data processing section consists of the ring buffer memory (PBSRAM) and controller (RBC). The RBC receives the data that is transferred from the A/D converter on the ACQ4 board (or the ACQ2 board for the DL1720E) assembly and performs the primary data processing such as the above-mentioned data extraction of sampled data, envelope, and box averaging, then stores the data in the ring buffer memory. The written data are transferred to the acquisition memory interface (AMI) in the secondary data processing section according to the trigger address. The DL1720E uses 2 Mbit PBSRAM for the ring buffer memory, the DL1740E uses 4 Mbit PBSRAM, and the DL1740EL uses 16 Mbit PBSRAM.

The secondary data processing section consists of the AMI, work memory (PBSRAM), and the acquisition memory (synchronous DRAM). The AMI processes the data (averaging, for example) that is transferred from the RBC and stores the result in the acquisition memory. Then, the AMI converts the stored data to display data by performing additional processing such as compression and interpolation. The resultant data are transferred to the graphic control process (GCP) on the CPU board assembly according to the display update interval. The AMI also has computation functions (addition, subtraction, multiplication, division, differentiation, integration, etc.) and auxiliary functions such as automated measurement of waveform parameters.

1.2 Function of Each Assembly

CPU Board Assembly

The CPU board consists of each circuit block's control circuit, an I/O circuit, other peripheral circuits, and a display section (for displaying waveforms and other information).

A Hitachi HD6417750SF is used for the CPU. The actions of each circuit block connected to the CPU bus are controlled by the CPU.

The main memory (synchronous DRAM) and Flash memory are included in the CPU's peripheral circuits.

In the I/O circuit, the following circuits carry out control through the CIO (CPU I/O interface IC). They are the backup memory, keyboard, floppy disk drive controller, GP-IB controller, USB I/F circuit, and PC card. On the CPU bus, they are the Ethernet I/F (option: /C10) circuit.

The display section consists of a GCP, graphic memory (synchronous GRAM), character memory (fast SRAM), and VGA VIDEO OUT circuits. The GCP writes the waveform data that are transferred from the AMI to the graphic memory. It synthesizes the contents of the graphic memory and the character memory and displays them on the TFT color LCD. The GCP also controls the built-in printer.

Key Board Assembly

Key switches, LEDs, the rotary encoder, and the jog shuttle are installed on the key board assembly.

Mother Board Assembly

Controls the exchange of signals between the CPU, KEY, ACQ4 (or the ACQ2 for the DL1720E), and a printer assembly. Supplies output from the power supply unit to the CPU, KEY, ACQ4 board (or the ACQ2 board for the DL1720E) assemblies, AD4 board (or the AD2 board for the DL1720E) assemblies, and a printer assembly. +12 V generation takes place on this board.

LCD Board Assembly

The LCD board assembly converts the connector of the LCD signal cable.

LCD Assembly

6.4-inch color TFT LC display
Full display resolution: 640 × 480
Waveform display resolution: 500 × 384

Printer Assembly (Optional)

The printer is of a thermal sensitivity type that prints 8 dots per mm and 832 dots per line. A hardcopy of the display is printed in approximately 12 seconds.

FDD Assembly (-J1)

The FDD assembly supports 3.5-inch floppy disks (1.44 MB formats).

PCMCIA Board Assembly (-J3)

The PCMCIA board assembly connects a Type II PC card with the CPU board.

Ether Board Assembly (Optional)

Option /C10 consists of an Ethernet interface section. The Ethernet interface section has an Ethernet controller. These interfaces are controlled by the CPU and CPU I/O interface (CIO) that are on the CPU board assembly.

OPT TRIG Board Assembly (Optional)

The OPT TRIG board assembly is equipped with a serial bus trigger logic (STL). The STL can generate two types of trigger signals: I²C bus triggers and SPI bus triggers.

1.3 Function of Each ASIC

The following items describe the IC and the gate array function used in each assembly.

Analog Front-End Controller (AFC)

The AFC is a Bi-CMOS gate array. Its main functions are controlling the analog front-end circuit and assisting the trigger circuit. It includes a PWM signal output circuit used for D/A conversion, a parallel port, a serial port, a trigger hold-off circuit, an auto trigger circuit, a TV trigger generator, a fast counter, and a slow counter.

Fast Trigger Logic (FTL)

The FTL is an ECL gate array. Its main functions include generation of trigger signals according to the trigger functions, a trigger hold-off function, and control of the time-to-voltage converter (TVC).

Pulse Width Detector (PWD)

The PWD is an analog IC. Using an internally-startable oscillator and an external counter (AFC), it detects the pulse width for width triggering.

Time-to-Voltage Converter (TVC)

This is the analog IC that measures the internal sampling clock and trigger time, and converts time to voltage.

Ring Buffer Memory Controller (RBC)

The RBC is a Bi-CMOS gate array. It performs primary processing of the data such as the extraction of the sampled data, envelope, and box averaging. It also provides functions for controlling the ring buffer memory and the interface to the acquisition memory interface (AMI).

Acquisition Memory Interface (AMI)

The AMI is a CMOS gate array. Its functions include interfacing to the ring buffer memory controller (RBC), interfacing to the graphic control processor (GCP), averaging, history control, waveform computation, and auxiliary functions for the automated measurement of waveform parameters.

Graphic Control Processor (GCP)

The GCP is a CMOS gate array. Its functions include interfacing to the acquisition memory interface (AMI), graphic memory and character memory control, a waveform drawing function (accumulated display, for example), built-in printer control, and display data generation for the LCD.

CPU I/O Interface (CIO)

The CIO is a CMOS gate array. Its functions include interfacing to the CPU (HD6417750SF) and the peripheral ICs, keyboard control, LED control, interrupt control, and DMA selection.

Serial Bus Trigger Logic (STL)

The STL is a field programmable gate array. The STL can generate two types of serial bus triggers: I²C bus triggers and SPI bus triggers.

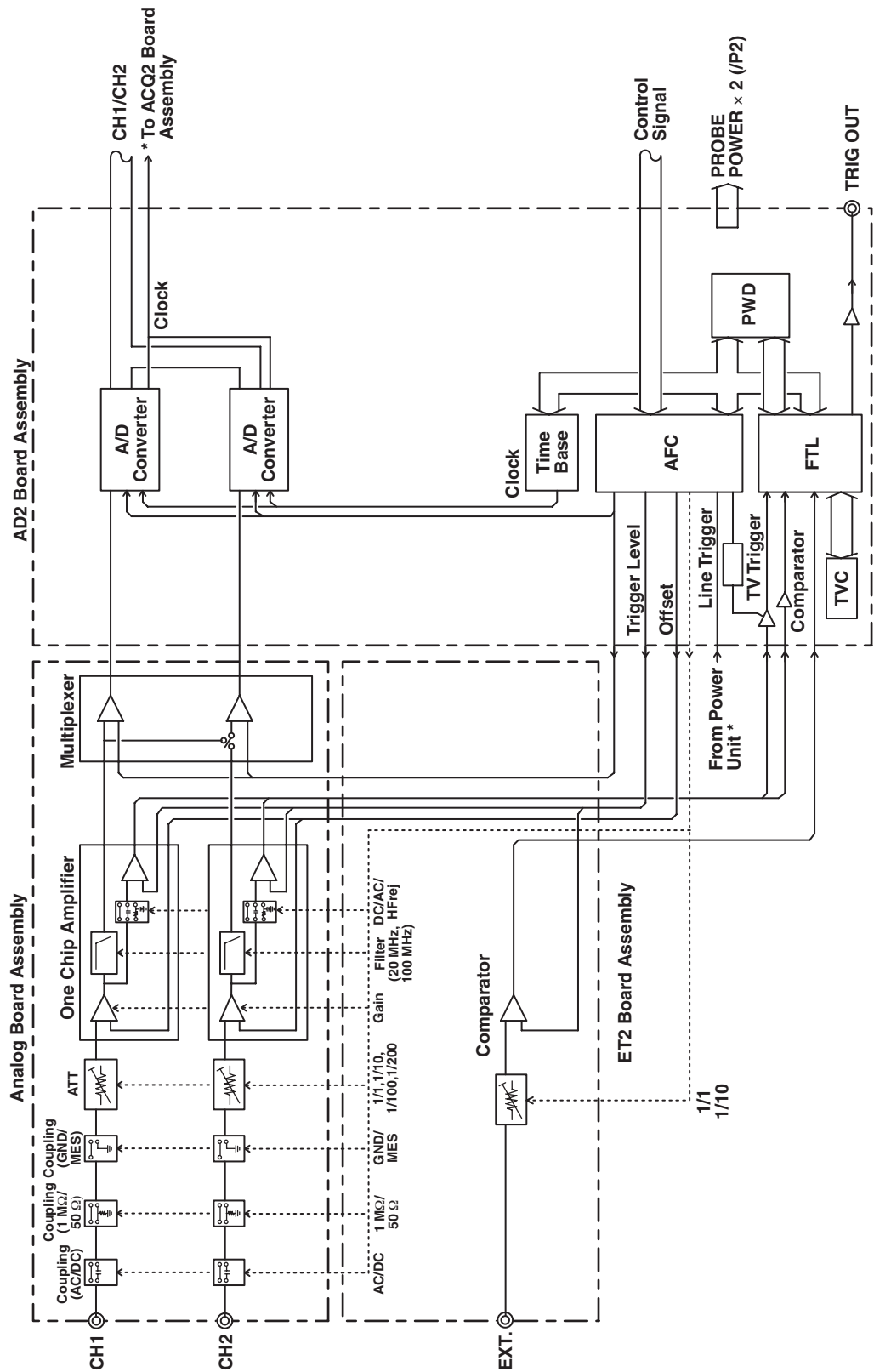

Figure 1.1 Block Diagram (Analog Section) of the DL1720E

1.3 Function of Each ASIC

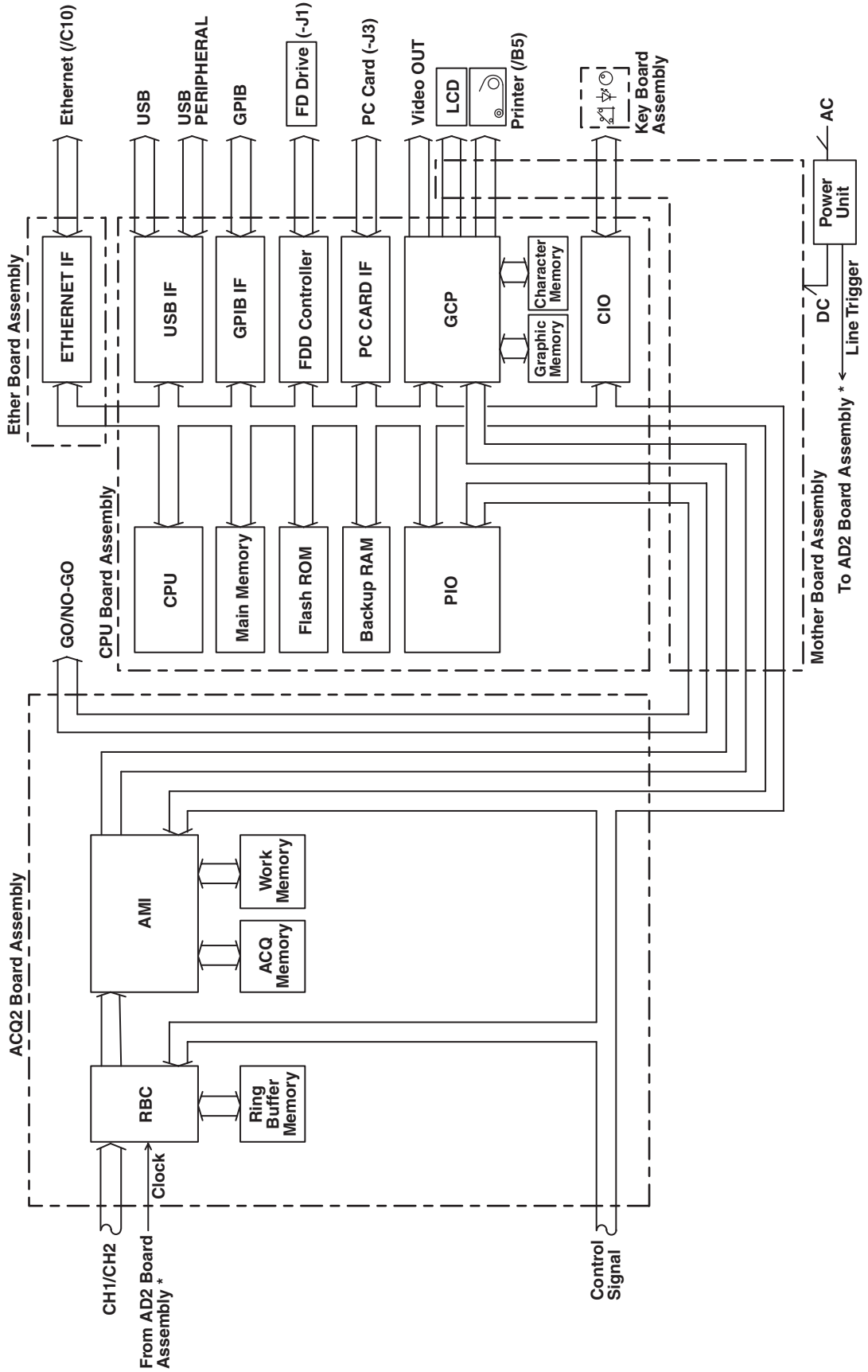

Figure 1.2 Block Diagram (Digital Section) of the DL1720E

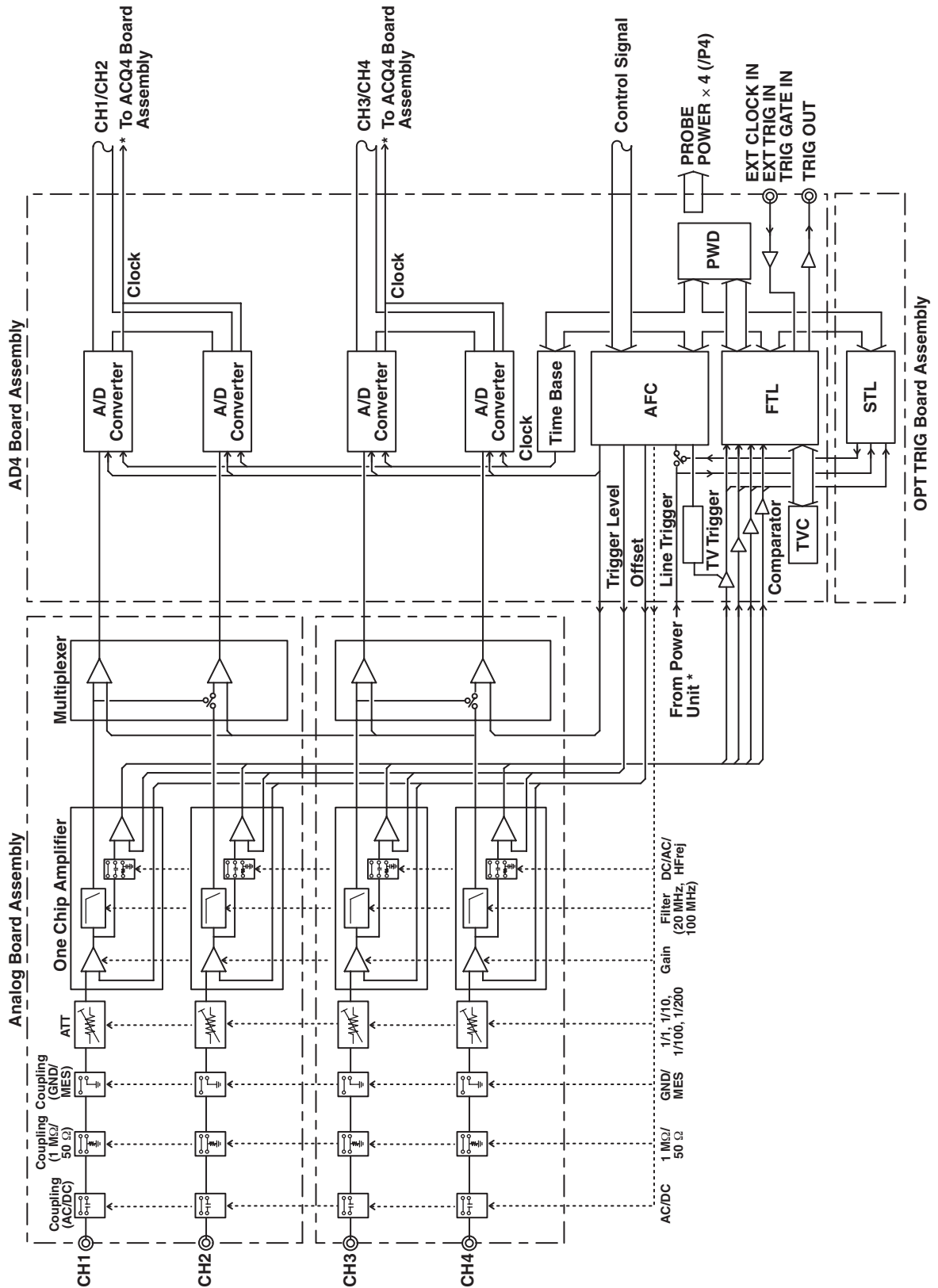

Figure 1.3 Block Diagram (Analog Section) of the DL1740E/DL1740EL

1.3 Function of Each ASIC

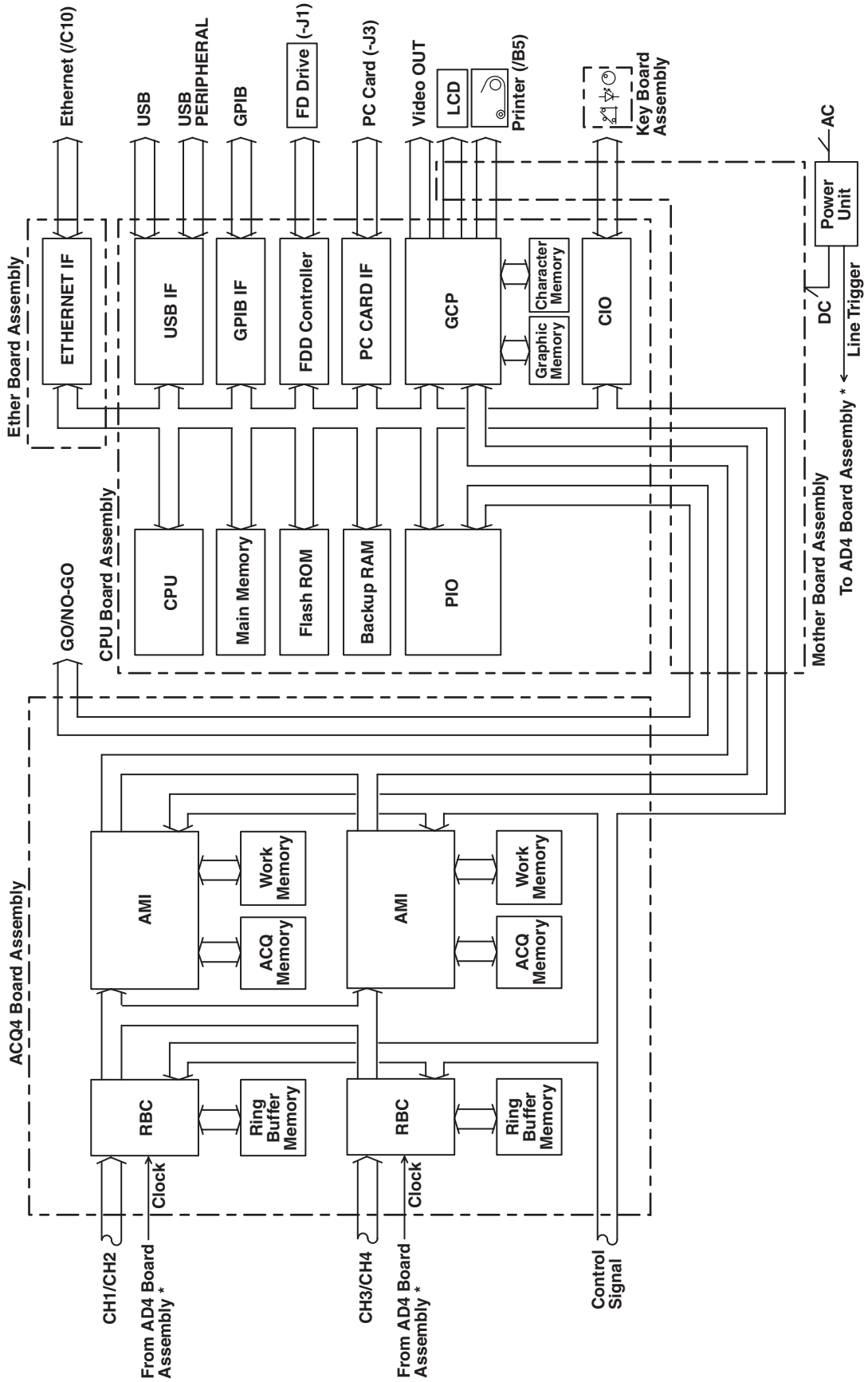

Figure 1.4 Block Diagram (Digital Section) of the DL1740E/DL1740EL

2.1 Introduction

The aim of the tests in this chapter is to check the basic performance of the instrument. The order of the test procedures is just for convenience and does not need to be adhered to strictly. Please use the recommended equipment or their equivalents.

Test Environment

Operating Conditions

- Ambient temperature: $23\pm 2^{\circ}\text{C}$
- Humidity: $55\pm 10\%\text{RH}$
- Voltage of power supply: Specified voltage $\pm 1\%$
- Frequency of power supply: Specified frequency $\pm 1\%$

Warm Up Time

- More than thirty minutes after turning ON the instrument.
- Confirm that self calibration is correctly executed after the thirty-minute warm up.
(Be sure to pay attention to the warm up time of all equipment that will be used in the test.)

2.2 Tests for the DL1720E/DL1740E/DL1740EL

Tests

- 2.2.1 Grounding Test
- 2.2.2 Insulation Resistance Test
- 2.2.3 Withstand Voltage
- 2.2.4 Selftest
 - Memory Test
 - Keyboard Test
 - Printer Test (Only When the /B5 Option Is Installed)
 - Floppy Disk Test (Only When the -J1 Option Is Installed)
 - PC Card IF Test (Only When the -J3 Option Is Installed)
 - Self-Calibration Test
- 2.2.5 GP-IB Test
- 2.2.6 Rear Panel Probe Power Supply Test
- 2.2.7 LINE Trigger, Trigger LED, and Hold Off Test
- 2.2.8 Probe Compensation Output and Auto Setup Test
- 2.2.9 Timebase Accuracy Test
- 2.2.10 Input Signal Bandwidth
- 2.2.11 Trigger Sensitivity Test
- 2.2.12 Offset Accuracy
- 2.2.13 DC Accuracy
- 2.2.14 Ext Trigger Level Accuracy Test
- 2.2.15 EXT Trigger Sensitivity and Trigger Out Test
- 2.2.16 Ext Clock Input Test

Instruments Used

Model Name	Recommended Device
AC low resistance tester	Kikusui TOS6100
Insulation tester	YOKOGAWA 2407
Withstanding voltage tester	Kikusui TOS-8750
Calibrator	FLUKE (WAVETEK) 9500
Programmable head	FLUKE (WAVETEK) 9520, 5 pc.
BNC cable	
50 Ω terminator	
Accessory probe	700988
FET probe	YOKOGAWA 700939
Printer paper	B9850NX
3.5" floppy disk	Formatted 2 HD 1.4 M disk
Flash ATA card	JT**MA3-BD: Fujisoku
PC	
Equivalent instruments may be used	

Before Testing

- Unless specified within, use the default settings on the main unit during testing.
- The DL1740E and DL1740EL accept 4-channel input, so testing should be performed on channels 1 through 4. However, the DL1720E has 2-channel input, so testing should be performed on channels 1 and 2.
- Before testing, restart the unit while holding down the Reset key to initialize the instrument.
- During testing, also hold down the Reset key when restarting.

2.2.1 Grounding Test

Product specification: 0.1 Ω or less

Confirm that a current of 30 A flows between the FG inlet of the AC power supply input and channel 4 of the BNC ground (or between FG and EXT. for the DL1720E), and that the resistance value is 0.1 Ω or less.

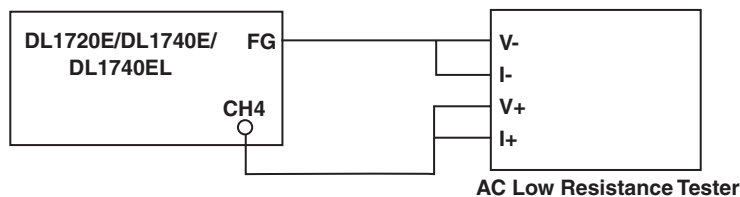

2.2.2 Insulation Resistance Test

Specifications: For DC 500 V, 10 MΩ or higher

Testing Procedure

Measure the insulation resistance between the AC power supply input signals below when the power switch is turned ON.

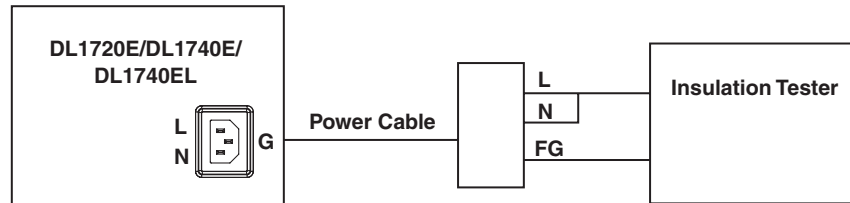

When the Ethernet (/C10) option is installed, also measure the insulation resistance across the following signals. (Note: the ETHERNET input terminal should be shorted across all terminals.)

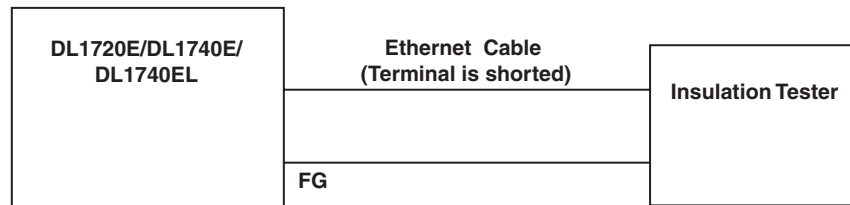

2.2.3 Withstand Voltage

Testing Procedure

Measure the withstand voltage between the AC power supply input signals below when the power switch is turned ON.

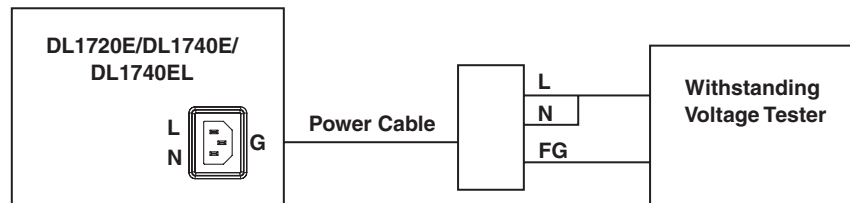

Items to Be Checked

That the product specification is met.

Specification: AC 1.5 kV for 1 minute

2.2.4 Selftest

The selftest is performed in the STOP condition.

Test the following items.

Testing Procedure

1. Perform the following test items while referring to “Performing a Self-Test” in the DL1720E/DL1740E/DL1740EL user’s manual (IM701730-01E).
 - Memory Test
 - Keyboard Test
 - Printer Test (only when the /B5 option is installed)
 - Floppy Disk Test (only when the -J1 option is installed)
 - PC Card IF Test (only when the -J3 option is installed)
2. Confirm that all tests were completed normally and that no errors occurred.
3. Perform the self-calibration, referring to “Performing Calibration” in the DL1720E/DL1740E/DL1740EL user’s manual (IM 701730-01E).
4. Confirm that “CAL” in the upper left part of the screen disappears, and that calibration completed without errors.

2.2.5 GP-IB Test

Test Items

- APC with support for GP-IB
- GP-IB cable

Testing Procedure

1. Connect the PC to the main unit with the GP-IB cable.
2. Press **MISC**. The MISC menu appears.
3. Press the **Remote Control** soft key. The Remote Cntl menu appears.
4. Press the **Device** soft key. The Device menu appears.
5. Press the **GP-IB** soft key.
6. Turn the jog shuttle to set the GP-IP address.
7. Select Format, Rx-Tx, or Terminator as required.
8. Execute a program like the one below.

The following program was written in Visual Basic. Your program may differ depending on the language used.

Private Sub Command2_Click() 'GPIB-TEST

===== Initialize GP-IB =====

```
Call ibfind("DEV1", dl%)
Call ibsic(dl%)
```

```
vol$ = 0
vol$ = Space$(10)
```

===== Send command =====

```
Call ibwrt(dl%, "COMM:HEAD OFF" + vbCrLf)
DoEvents
Call ibwrt(dl%, "ACQ:MODE NORM" + vbCrLf)
DoEvents
Call ibwrt(dl%, "ACQ:MODE?" + vbCrLf)
DoEvents
```

===== Receive data =====

```
Call ibrd(dl%, vol$)
DoEvents
```

===== Display data =====

```
Text1.Text = Mid(vol$, 1, 4)
```

End Sub

Items to Be Checked

That "NORM" is displayed on the PC screen.

Display Screen Example

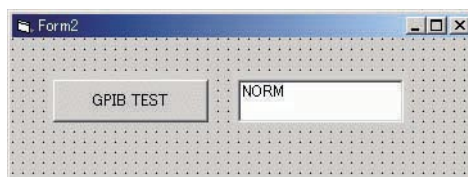

2.2.6 Rear Panel Probe Power Supply Test

Testing Procedure

Connect the FET probe (700939) to the main unit, and confirm that the probe compensation signal appears correctly.

2.2.7 LINE Trigger, Trigger LED, and Hold Off Test

Testing Procedure

1. Initialize the unit. See section 4.4, "Initializing Settings" in the DL1720E/DL1740E/DL1740EL user's manual (IM 701730-01E) for the operating procedure.
2. Enter the following settings.

SIMPLE (Trigger)	Source:	Line
	Hold off:	1 s

Items to Be Checked

That the trigger LED blinks at 1 second intervals.

2.2.8 Probe Compensation Output and Auto Setup Test

Testing Procedure

1. Connect the accessory probe (10:1) to the Probe Compensation terminal and input to an arbitrary channel.
2. Execute Auto Setup. See section 4.5, "Executing Auto Setup" in the DL1720E/DL1740E/DL1740EL user's manual (IM 701730-01E) for the operating procedure.

Probe Compensation Test Waveform

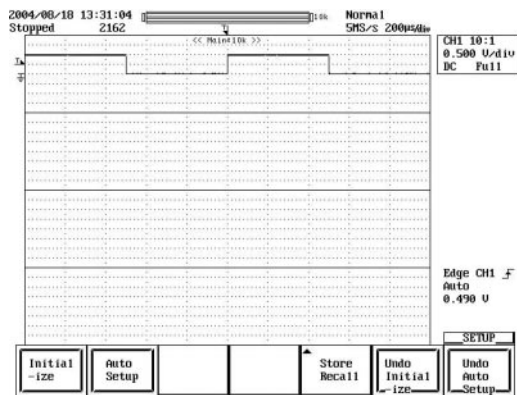

Items to Be Checked

Confirm that a square wave of approximately 1 V_{P-P} and 1 kHz appears on screen.

2.2.9 Timebase Accuracy Test

Testing Procedure

- Enter the following settings on the DL1720E/DL1740E/DL1740EL.

CH1	Display:	ON
	V/div:	50 mV/div
	Coupling:	DC 50 Ω
Other than CH1	Display:	OFF
DISPLAY	Format:	Single
ACQ	Record Length:	10 k
TIME/DIV	2 μ s/div	
MEASURE	Mode:	ON
	Item Setup (CH1):	Freq
- Input a 500.2 MHz, 300 mV_{P-P} sinewave from the calibrator to CH1.
- Confirm that the CH1 Freq becomes 200 \pm 25 kHz.
- Enter the setting below, then input a 200.1 MHz, 300 mV_{P-P} sinewave.

TIME/DIV:	5 μ s/div
-----------	---------------
- Confirm that the CH1 Freq becomes 100 \pm 10 kHz.

Items to Be Checked

That the product specification is met.

Specification: \pm 0.005%

2.2.10 Input Signal Bandwidth

Specification: DC–500 MHz (–3dB) DC 50 Ω (excluding the 2 mV/div and 5 mV/div)
 DC–400 MHz (–3dB) DC 50 Ω (2 mV/div and 5 mV/div)
 DC–400 MHz (–3dB) 1 M Ω (probe terminal)

Testing Procedure

- Execute calibration (see section 4.6, “Performing Calibration” in the DL1720E/DL1740E/DL1740EL user’s manual (IM 701730-01E)).
- Enter the following settings on the DL1720E/DL1740E/DL1740EL.

CH (all channels)	Display:	ON
	Coupling:	DC 50 Ω
DISPLAY	Format:	Single
ACQ	Record Length:	1 k
	Mode:	Average
	Weight:	4
TIME/DIV	2 ns/div	
SIMPLE (Trigger)	Source:	Input channel
MEASURE	Mode:	ON
	Item Setup (all channels):	Sdev
	T-Range1:	–5.00 div
	T-Range2:	5.00 div
- Input a sinewave from the calibrator to the channel under test.
- Using the table below, measure Sdev on the input waveform, and confirm that it lies within the judgment criteria.

V/div	Input Amplitude (p-p)	Input Frequency	Judgement Criteria
1 V/div	5 V	500 MHz	1.26 to 1.98 V
200 mV/div	1.2 V	500 MHz	301 to 476 mV
50 mV/div	0.3 V	500 MHz	75.1 to 119 mV
10 mV/div	60 mV	500 MHz	15.1 to 23.8 mV
5 mV/div	30 mV	400 MHz	7.51 to 11.9 mV
2 mV/div	12 mV	400 MHz	3.01 to 4.76 mV

2.2 Tests for the DL1720E/DL1740E/DL1740EL

2.2.11 Trigger Sensitivity Test

Specification: Sensitivity 1 div (display screen) at 500 MHz

Testing Procedure

Turn the display of each channel ON one at a time (with all other channels OFF), then confirm the following:

- Enter the following settings on the DL1720E/DL1740E/DL1740EL.

CH (all channels)	V/div:	0.5 V/div,
	Probe:	1:1
	Coupling:	DC 50 Ω
TIME/DIV	1 ns/div	
DISPLAY	Format:	Single
ACQ	Record Length:	1 k
	Mode:	Average
	Weight:	4
SIMPLE (Trigger)	Source:	Input channel
- Input a 500 MHz sinewave from the calibrator to the channel under test so that the amplitude on the display screen is 500 mV_{P-P}.

Items to Be Checked

Confirm that the triggers activate normally on all channels.

Trigger Sensitivity Test Waveform

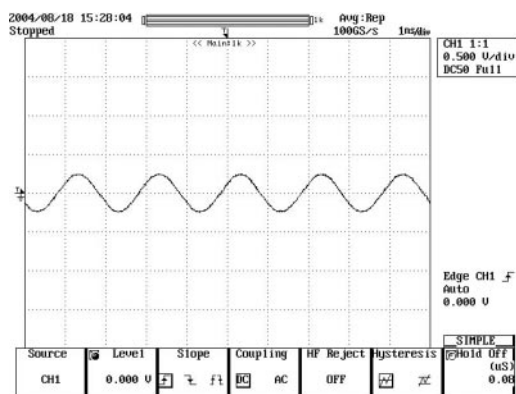

2.2.12 Offset Accuracy

Specification: 2 mV/div–50 mV/div: \pm (1% of the setting + 0.2 mV)
 100 mV/div–500 mV/div: \pm (1% of the setting + 2 mV)
 1 V/div–10 V/div: \pm (1% of the setting + 20 mV)

Testing Procedure

- Execute calibration (see section 4.6, “Performing Calibration” in the DL1720E/DL1740E/DL1740EL user’s manual (IM 701730-01E)).
- Enter the following settings on the DL1720E/DL1740E/DL1740EL.

CH (all channels)	V/div:	5 mV/div
	Probe:	1:1
ACQ	Mode:	Box Average
TIME/DIV	5 ms/div	
DISPLAY	Format:	Single
MEASURE	Mode:	ON
	Item Setup:	Avg
	(channel under test)	

3. Input a \pm DC voltage from the calibrator to the channel under test.
4. Apply a \pm 1 V offset to the channel under test, then confirm that the values obtained from automated measurement of waveform parameters (see section 10.6, "Automated Measurement of Waveform Parameters" in the DL1720E/DL1740E/DL1740EL user's manual (IM 701730-01E)) lie within the judgment criteria on all channels.

Input Voltage	Offset	Judgment Criteria
1 V	1 V	0.9898 to 1.0102 V
-1 V	-1 V	-1.0102 to -0.9898 V

2.2.13 DC Accuracy

Specification: $\pm(1.5\%$ of 8 div + offset accuracy)

Testing Procedure

1. Execute calibration (see section 4.6, "Performing Calibration" in the user's manual (IM 701730-01E)).
2. Enter the following settings on the DL1720E/DL1740E/DL1740EL.

CH (all channels)	Coupling:	DC 1 M Ω
DISPLAY	Format:	Single
ACQ	Mode:	Box Average
TIME/DIV	1 ms/div	
MEASURE	Mode:	ON
	Item Setup:	Avg
	(channel under test)	
3. Input DC voltage from the DC voltage generator to the channel under test.
4. Using the table below, confirm that the measured values lie within the judgment criteria on all channels.

Range	Input Voltage	Measured Value	Input Voltage	Measured Value	Input Voltage	Measured Value
10 V	40 V	38.78 to 41.22 V	0 V	-1.22 to 1.22 V	-40 V	-41.22 to -38.78 V
5 V	20 V	19.38 to 20.62 V	0 V	-0.62 to 0.62 V	-20 V	-20.62 to -19.38 V
2 V	8.0 V	7.74 to 8.26 V	0 V	-0.26 to 0.26 V	-8.0 V	-8.26 to -7.74 V
1 V	4.0 V	3.86 to 4.14 V	0 V	-0.14 to 0.14 V	-4.0 V	-4.14 to -3.86 V
0.5 V	2.0 V	1.938 to 2.062 V	0 V	-62 to 62 mV	-2.0 V	-2.062 to -1.938 V
0.2 V	800 mV	774 to 826 mV	0 V	-26 to 26 mV	-800 mV	-826 to -774 mV
0.1 V	400 mV	386 to 414 mV	0 V	-14 to 14 mV	-400 mV	-414 to -386 mV
50 mV	200 mV	193.8 to 206.2 mV	0 V	-6.2 to 6.2 mV	-200 mV	-206.2 to -193.8 mV
20 mV	80 mV	77.4 to 82.6 mV	0 V	-2.6 to 2.6 mV	-80 mV	-82.6 to -77.4 mV
10 mV	40 mV	38.6 to 41.4 mV	0 V	-1.4 to 1.4 mV	-40 mV	-41.4 to -38.6 mV
5 mV	20 mV	19.2 to 20.8 mV	0 V	-0.8 to 0.8 mV	-20 mV	-20.8 to -19.2 mV
2 mV	8.0 mV	7.56 to 8.44 mV	0 V	-0.44 to 0.44 mV	-8.0 mV	-8.44 to -7.56 mV

2.2.14 EXT Trigger Level Accuracy Test

Specification: ± (10% of setting + 50 mV)

Testing Procedure

1. Enter the following settings on the DL1720E/DL1740E/DL1740EL.

CH1	Display:	ON
	V/div:	0.2 V/div
	Probe:	1:1
Other than CH1	Display:	OFF
DISPLAY	Format:	Single
ACQ	Record Length:	10 k
	Mode:	Box Average
TIME/DIV		200 μs/div
SIMPLE (Trigger)	Source:	Ext
	Range:	±1 V (for the DL1720E)
	Probe:	1:1
CURSOR	Type:	Marker
	Cursor1:	0.00 div
2. Input a sinewave of 1.6 V_{P-P}, 0 V offset, and 1 kHz from the calibrator to CH1 and the EXT trigger input terminal on the rear panel. Pass the input to the EXT trigger input terminal on the rear panel through a 50 Ω terminator.
3. Confirm that the value V_h read by the cursor when the polarity is ↑, and the value V_l when it is ↓ lie within the judgment criteria below.

Trigger Level	Judgment Criteria
700 mV	$580 \text{ mV} \leq (V_h + V_l) / 2 \leq 820 \text{ mV}$
0 mV	$-50 \text{ mV} \leq (V_h + V_l) / 2 \leq 50 \text{ mV}$
-700 mV	$-820 \text{ mV} \leq (V_h + V_l) / 2 \leq -580 \text{ mV}$

4. Since you must cancel the trigger level offset for the trigger sensitivity test, use the V_h and V_l values measured when the trigger level was set to 0 mV under this item, set

$$V_c = -(V_h + V_l) / 2,$$
 then use this trigger level for the next EXT trigger sensitivity and trigger out test.

2.2.15 EXT Trigger Sensitivity and Trigger Out Test

Specification: Sensitivity 100 mV at 100 MHz

Testing Procedure

- Enter the following settings on the DL1720E/DL1740E/DL1740EL.

CH1	Display: V/div: Probe: Coupling:	ON 20 mV/div 1:1 DC 50 Ω
CH2	Display: V/div: Probe: Coupling:	ON 2 V/div 1:1 DC 1 MΩ
Other than CH1 or CH2	Display: Format: Record Length: Mode:	OFF Dual 10 k Normal
TIME/DIV	10 ns/div	
SIMPLE (Trigger)	Source: Range: Probe: Level: Position:	Ext ±1 V (for the DL1720E) 1:1 V _c (see prev item) 10%
- Input a 100 MHz, 100 mV_{P-P} sinewave from the calibrator to CH1 and the EXT trigger input terminal. Pass the input to the EXT trigger input terminal through the 50 Ω terminator.
- Connect the rear panel trigger output to CH2 through a BNC cable.

Items to Be Checked

Confirm that the trigger activates normally, and that a stable waveform is displayed.

Observation Example

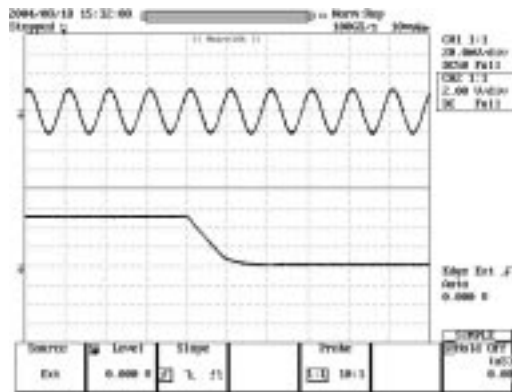

2.2.16 EXT Clock Input Test

1. Enter the following settings two channels at a time.
 Display: ON (other channels OFF)
2. Enter the following settings on all channels, then perform steps 3, 4, and 5.

CH (all channels)	V/div:	50 mV/div
	Probe:	1:1
	Coupling:	DC 1 M Ω
DISPLAY	Format:	Dual
ACQ	Record Length:	10 k
	Mode:	Normal
	Time Base:	Ext
ENHANCED (Trigger)	Type:	OR
	Set Pattern (all channels):	\uparrow
	Level (all channels):	0 mV
3. Input a 20 MHz sinewave to the EXT clock input terminal on the rear panel through a 50 Ω terminator.
4. Input a 300 mV_{P-P}, 4 kHz sinewave from the function generator to the channels under test.
5. Confirm that no noticeable degradation occurs from bit loss and that the waveform in the figure below is displayed correctly.

Waveform Observation Example

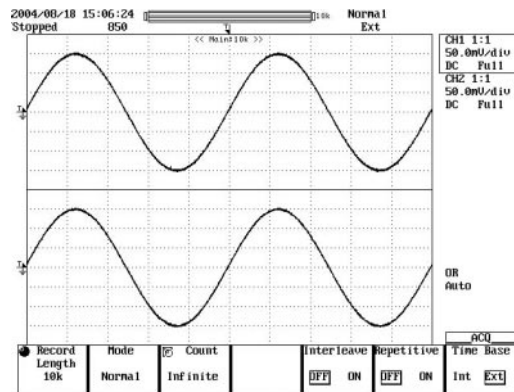

3.1 Introduction

The top cover, printer cover, printer case, front bezel, and shield cover must be removed before adjusting the DL1720E/DL1740E/DL1740EL. Read the warning and cautions below before doing so.

WARNING

Circuit patterns of the printed circuit board are exposed. Be careful when handling so that hands or fingers are not injured by the protruding pins.

CAUTION

- Circuit patterns of the printed circuit board are exposed. If these patterns touch other metallic materials, electrical shorting will occur, causing the circuit to be damaged or burnt.
- It is sometimes necessary to turn the DL1720E/DL1740E/DL1740EL upside down for adjustment. Do not drop the instrument, or allow it to fall over.
- When feeding power with the DL1720E/DL1740E/DL1740EL cover open, apply a flow of air to the AD4 board (or the AD2 board for the DL1720E) and Power Supply (B8052YA*).

* Power Supply of the DL1720E/DL1740E/DL1740EL shipped before May 2005 is B9989YA, and Power Supply of the DL1720E/DL1740E/DL1740EL shipped since May 2005 is B8052YA.

3.2 Test Environment

Operating Conditions

- Ambient temperature: 23 \pm 2°C
- Humidity: 55 \pm 10% RH
- Voltage of power supply: Specified voltage \pm 1%
- Frequency of power supply: Specified frequency \pm 1%

Warm Up Time

- More than thirty minutes after tuning ON the instrument.
- Confirm that self calibration is correctly executed after the thirty-minute warm up.
(Be sure to pay attention to the warm up time of all equipment that will be used in the test.)

3.3 Equipment Required

Table 3.1 Equipment Required

Equipment	Critical Specification	Recommended
Calibrator	DC	FLUKE (WAVETEK) 9500
Programmable Head	Output Level: 1 V Accuracy: < 0.02% Square Wave Frequency: 10 kHz Output Level: > 60 V _{P-P}	FLUKE (WAVETEK) 9520

Note

The values shown in the specification column are those indicated by this service manual only. These values do not indicate the actual performances of the recommended equipment and tools. Therefore, non-designated equipment and tools which satisfy the specifications are permitted.

3.4 DC Offset Adjustment on the AD Board

Procedure

1. Remove the top cover and shield cover.
2. Allow the unit to warm up for ten minutes or more.
3. Connect each instrument as shown in figure 3.1, "Connection Method."

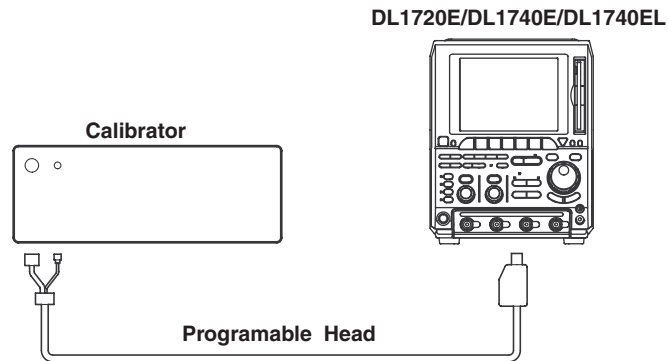

Figure 3.1 Connection Method

4. Press the **SETUP** key and select the **Initialize** soft key to execute initialization.
5. Press the **MISC** key and select the **Calibration** soft key.
6. Press the **Cal Exec** soft key to perform calibration.
7. Enter the settings on the DL1720E/DL1740E/DL1740EL and calibrator as follows.

DL1720E/DL1740E/DL1740EL

VERTICAL (for all channels)

V/div:	2 mV/div
Probe:	1:1
Offset:	+1.000 V
Bandwidth:	20 MHz

HORIZONTAL

T/div: 1 ms/div

ACQ

Mode: Box Average

DISPLAY

Format: Single

MEASURE

Mode: ON

Item Set Up: ▼ (Set to channel to be measured) Select Avg.

Time Range 1: -5 div

Time Range 2: +5 div

Calibrator

DC Output Level: +1.0000 V

8. Adjust the variable resistor (refer to table 3.2, "Adjustment Point" and figure 3.2, "Adjustment Point Location Diagram") corresponding to each channel so that the DC waveform fits within $1\text{ V} \pm 1\text{ mV}$ as shown in figure 3.3, "Observed Waveform."
9. Perform the adjustment in step 7) for all channels.

Table 3.2 Adjustment Point

Channel	Adjustment Point
CH1	R707
CH2	R714
CH3*	R721
CH4*	R728

* The DL1720E is not equipped with CH3 and CH4

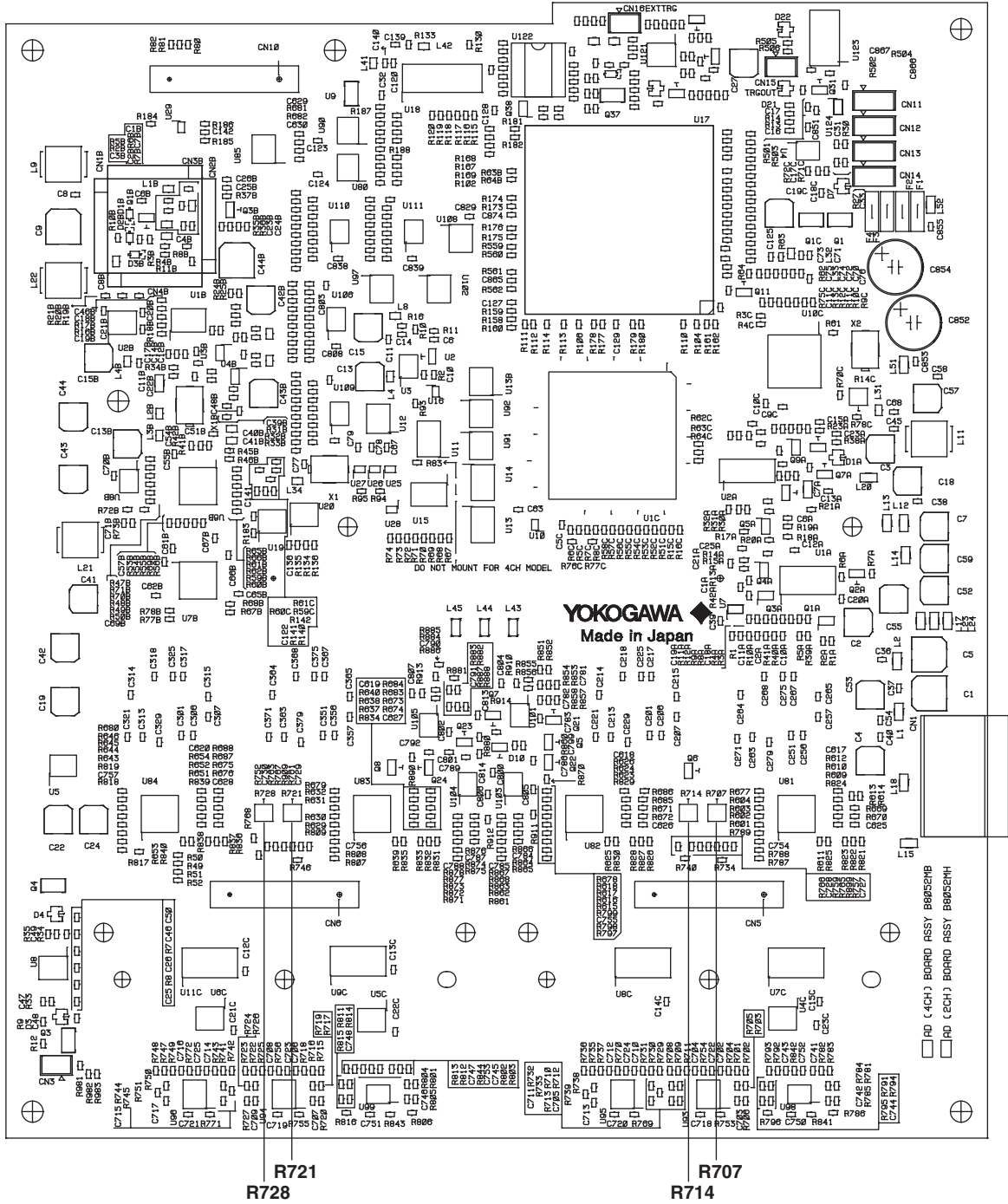

Figure 3.2 Adjustment Point Location Diagram

3.4 DC Offset Adjustment on the AD Board

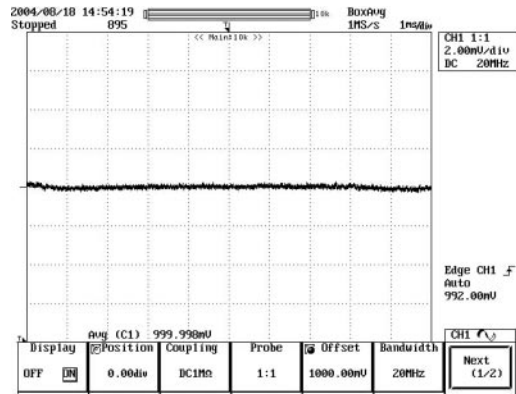

Figure 3.3 Observed Waveform

3.5 Flatness Adjustment on the Analog Board

Note

Before performing this flatness adjustment, the DC gain adjustment on the AD board must have been completed.

Procedure

1. Remove the top cover, printer cover, printer case, front bezel, and shield cover.
2. Turn on the power and allow the unit to warm up for ten minutes or more.
3. Connect each instrument as shown in figure 3.4, "Connection Method."

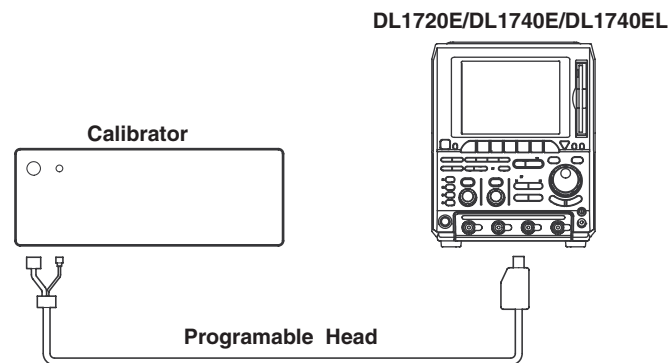

Figure 3.4 Connection Method

4. Press the **SETUP** key and select the **Initialize** soft key to execute initialization.
5. Press the **MISC** key and select the **Calibration** soft key.
6. Select the **Cal Exec** soft key to perform calibration.
7. For adjustment of the /10 range, enter the settings on the DL1720E/DL1740E/DL1740EL oscilloscope and calibrator as follows.

DL1720E/DL1740E/DL1740EL

VERTICAL (for all channels)

V/div: 100 mV/div

Probe: 1:1

HORIZONTAL

T/div: 10 μ s/div

TRIGGER

Source: Input channel

ACQ

Mode: Box Average

DISPLAY

Format: Single

Calibrator

Waveform: Square wave

Frequency: 10 kHz

Amplitude: 600 mV_{P-P}

8. Adjust the variable capacitors CV101 and CV201, (refer to figure 3.5, "Adjustment Point Location Diagram") so that the top of the waveform becomes flat as shown in figure 3.6, "Observed Waveform." The waveform must fit within ± 0.1 div.

3.5 Flatness Adjustment on the Analog Board

9. For adjustment of the /100 range, enter the settings on the DL1720E/DL1740E/DL1740EL oscilloscope and calibrator as follows.

DL1720E/DL1740E/DL1740EL

VERTICAL (for all channels)

	V/div:	1 V/div
	Position:	0 div
	Probe:	1:1
HORIZONTAL	T/div:	10 μ s/div
TRIGGER	Source:	Input channel
ACQ	Mode:	Box Average
DISPLAY	Format:	Single

Calibrator

Waveform:	Square wave
Frequency:	10 kHz
Amplitude:	6 V _{P-P}

10. Adjust the variable capacitors CV102 and CV202 (refer to figure 3.5, "Adjustment Point Location Diagram") so that the top of the waveform becomes flat as shown in figure 3.6, "Observed Waveform." The waveform must fit within ± 0.1 div.
11. For adjustment of the /200 range, enter the settings on the DL1720E/DL1740E/DL1740EL oscilloscope and calibrator as follows.

DL1720E/DL1740E/DL1740EL

VERTICAL (for all channels)

	V/div:	10 V/div
	Position:	0 div
	Probe:	1:1
HORIZONTAL	T/div:	10 μ s/div
TRIGGER	Source:	Input channel
ACQ	Mode:	Box Average
DISPLAY	Format:	Single

Calibrator

Waveform:	Square wave
Frequency:	10 kHz
Amplitude:	60 V _{P-P}

12. Adjust the variable capacitors CV103 and CV203 (refer to figure 3.5, "Adjustment Point Location Diagram") so that the top of the waveform becomes flat as shown in figure 3.6, "Observed Waveform." The waveform must fit within ± 0.1 div.

4.1 Introduction

This chapter describes possible solutions for rectifying errors. In such cases, assembly removal may be required. Please heed the following warning.

WARNING

Assembly replacement is to be performed only by qualified service technicians who have experience working with the hazards involved (such as fire and electrical shock).

Note

If an error message is displayed, the error may have been caused by incorrectly operating the unit. Refer to the user's manual (IM 701730-01E), and perform the correct operation.

4.2 Flow Chart

Figure 4.1, "Troubleshooting Flow Chart" shows an analytical method for handling malfunctions.

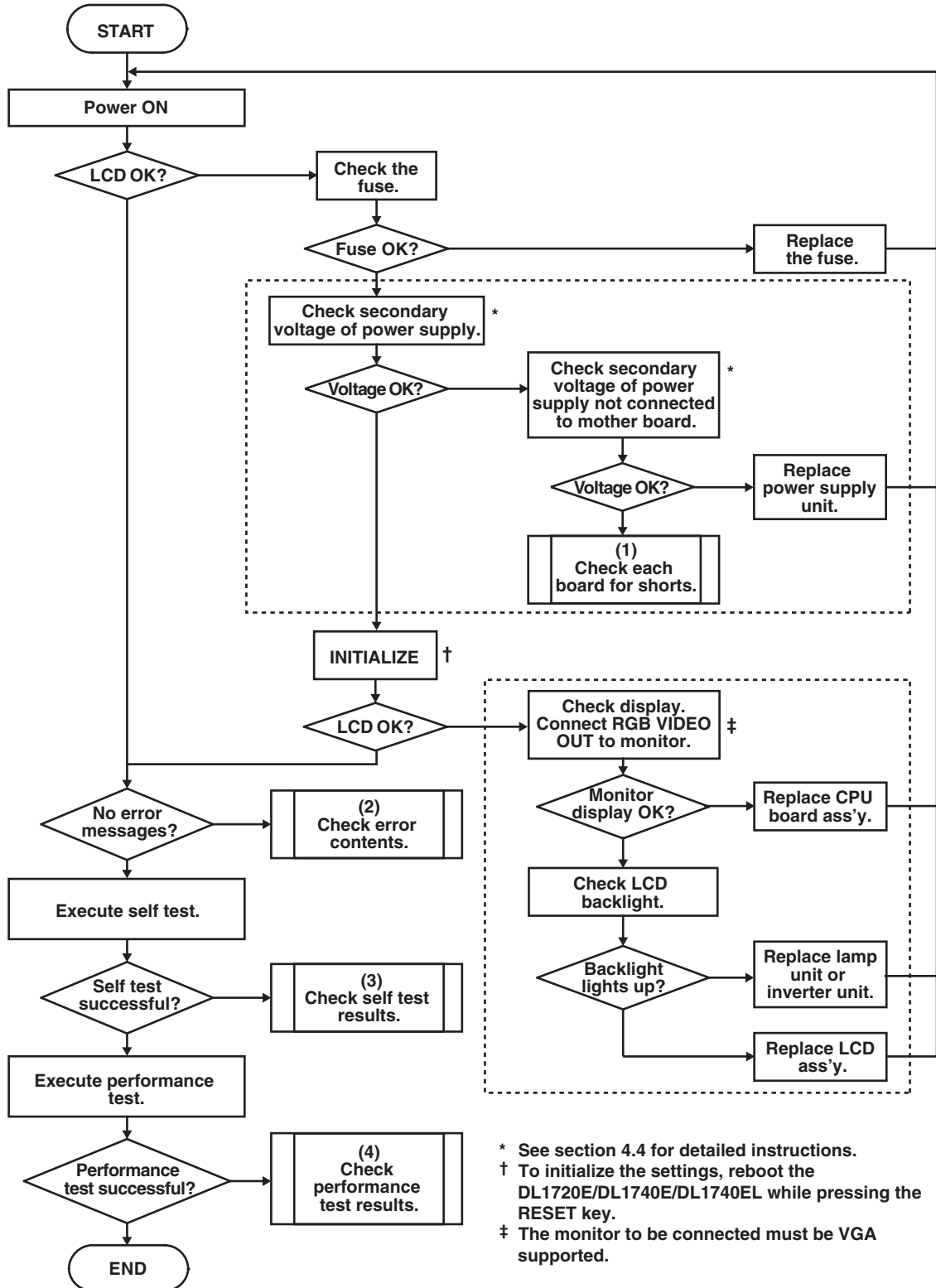

* See section 4.4 for detailed instructions.

† To initialize the settings, reboot the DL1720E/DL1740E/DL1740EL while pressing the RESET key.

‡ The monitor to be connected must be VGA supported.

Maintenance Service is Required
Contact your nearest YOKOGAWA representative as listed on the back cover of this manual.

Figure 4.1 Troubleshooting Flow Chart

4.3 Assemblies to Check When an Error Occurs

(1)

A short may occur in an assembly other than the power supply unit. To check in which voltage line a short has occurred, investigate each assembly to which voltage is supplied using a circuit tester. Table 4.1 "Correspondence of Assembly to Voltage" shows the relationship between assemblies and voltages supplied to them.

Table 4.1 Correspondence of Assembly to Voltage

Voltage Series	Assembly No.	Assembly
+24 V	B8052MP	Mother Board Assembly
	B9989GP	PRINTER Assembly (Option: /B5)
	B9989SA	FAN Assembly
+12 V	B9989MG	ET2 Board Assembly (MODEL: 701715)
	B8052MH	AD2 Board Assembly (MODEL: 701715)
	B8052MB	AD4 Board Assembly (MODEL: 701730/701740)
	B8052MP	Mother Board Assembly
	A1468UP	Inverter Unit
+5 V	B9989MG	ET2 Board Assembly (MODEL: 701715)
	B9989ML	ANALOG Board Assembly (MODEL: 701715/701730/701740)
	B8052MH	AD2 Board Assembly (MODEL: 701715)
	B8052MB	AD4 Board Assembly (MODEL: 701730/701740)
	B8052MC	CPU Board Assembly
	B8052MF	ACQ2S Board Assembly (MODEL: 701715)
	B8052MD	ACQ4S Board Assembly (MODEL: 701730)
	B8052ME	ACQ4L Board Assembly (MODEL: 701740)
	B8052MP	Mother Board Assembly
	B9989MK	KEY Board Assembly
	B8051MG	OPT TRIG Board Assembly (Option: /F5)
	A1092UN	FDD Unit (Model: -J1)
	B8050MK	PCMCIA Board Assembly (Model: -J3)
+3.3 V	B8052MH	AD2 Board Assembly (MODEL: 701715)
	B8052MB	AD4 Board Assembly (MODEL: 701730/701740)
	B8052MC	CPU Board Assembly
	B8052MF	ACQ2S Board Assembly (MODEL: 701715)
	B8052MD	ACQ4S Board Assembly (MODEL: 701730)
	B8052ME	ACQ4L Board Assembly (MODEL: 701740)
	B8052MP	Mother Board Assembly
	B8052MS	ETHER Board Assembly (Option: /C10)
B8051MG	OPT TRIG Board Assembly (Option: /F5)	
-2 V	B9989ML	ANALOG Board Assembly (MODEL: 701715/701730/701740)
	B8052MH	AD2 Board Assembly (MODEL: 701715)
	B8052MB	AD4 Board Assembly (MODEL: 701730/701740)
	B8052MF	ACQ2S Board Assembly (MODEL: 701715)
	B8052MD	ACQ4S Board Assembly (MODEL: 701730)
	B8052ME	ACQ4L Board Assembly (MODEL: 701740)
	B8052MP	Mother Board Assembly
-5.2 V	B9989MG	ET2 Board Assembly (MODEL: 701715)
	B9989ML	ANALOG Board Assembly (MODEL: 701715/701730/701740)
	B8052MH	AD2 Board Assembly (MODEL: 701715)
	B8052MP	Mother Board Assembly
-12 V	B9989MG	ET2 Board Assembly (MODEL: 701715)
	B8052MH	AD2 Board Assembly (MODEL: 701715)
	B8052MB	AD4 Board Assembly (MODEL: 701730/701740)
	B8052MP	Mother Board Assembly

4.3 Assemblies to Check When an Error Occurs

(2)

When trouble occurs, refer to the user's manual to determine whether the trouble was caused by erroneous operation or by a hardware defect. Table 4.2, "Correspondence of Messages to Defective Assemblies," shows which kind of trouble may be due to a hardware failure.

Table 4.2 Correspondence of Messages to Defective Assemblies

Code	Message	Assembly No.	Assembly
713	Calibration failure....	B9989MG	ET2 Board Assembly (MODEL: 701715)
		B9989ML	ANALOG Board Assembly (MODEL: 701715/701730/701740)
		B8052MH	AD2 Board Assembly (MODEL: 701715)
		B8052MB	AD4 Board Assembly (MODEL: 701730/701740)
		B8052MC	CPU Board Assembly
		B8052MF	ACQ2S Board Assembly (MODEL: 701715)
		B8052MD	ACQ4S Board Assembly (MODEL: 701730)
		B8052ME	ACQ4L Board Assembly (MODEL: 701740)
		B8052MP	Mother Board Assembly
901	Failed to backup setup data....	B8052MC	CPU Board Assembly
906	Fan stopped....	B9989SA	FAN Assembly
		B8052YA*	Power Supply
		B8052MP	Mother Board Assembly
		B8052MC	CPU Board Assembly
907	Backup battery is flat.	B8052MC	CPU Board Assembly

* Power Supply of the DL1720E/DL1740E/DL1740EL shipped before May 2005 is B9989YA, and Power Supply of the DL1720E/DL1740E/DL1740EL shipped since May 2005 is B8052YA.

(3)

When trouble occurs, check the test item displaying FAIL and select the relevant defective item from table 4.3, "Correspondence of Test Items to Defective Assemblies." If necessary, replace the relevant assembly.

Table 4.3 Correspondence of Test Item to Defective Assemblies

Test Item	Assembly No.	Assembly
Key Board	B8052MC	CPU Board Assembly
	B8052MP	Mother Board Assembly
	B9989MK	KEY Board Assembly
Memory	B8052MC	CPU Board Assembly
FDD	B8052MC	CPU Board Assembly
	A1092UN	FDD Unit (Model: -J1)
PC Card	B8052MC	CPU Board Board Assembly
	B8050MK	PCMCIA Board Assembly (Model: -J3)
Printer	B8052MC	CPU Board Assembly
	B8052MP	Mother Board Assembly
	B9989GP	Printer Assembly (Option: /B5)
Accuracy	B9989MG	ET2 Board Assembly (MODEL: 701715)
	B9989ML	ANALOG Board Assembly (MODEL: 701715/701730/701740)
	B8052MH	AD2 Board Assembly (MODEL: 701715)
	B8052MB	AD4 Board Assembly (MODEL: 701730/701740)
	B8052MC	CPU Board Assembly
	B8052MF	ACQ2S Board Assembly (MODEL: 701715)
	B8052MD	ACQ4S Board Assembly (MODEL: 701730)
	B8052ME	ACQ4L Board Assembly (MODEL: 701740)
	B8052MP	Mother Board Assembly

(4)

When trouble occurs, check the non-conforming test and select the relevant defective assembly from table 4.4, "Correspondence of Test Items to Defective Assemblies." If necessary, replace the relevant assembly.

Table 4.4 Correspondence of Test Item to Defective Assemblies

Test Item	Assembly No.	Assembly
2.5 Vertical Axis DC Voltage Accuracy Test	B9989ML	ANALOG Board Assembly (MODEL: 701715/701730/701740)
	B8052MH	AD2 Board Assembly (MODEL: 701715)
	B8052MB	AD4 Board Assembly (MODEL: 701730/701740)
2.6 Frequency Response Test	B9989ML	ANALOG Board Assembly (MODEL: 701715/701730/701740)
	B8052MH	AD2 Board Assembly (MODEL: 701715)
	B8052MB	AD4 Board Assembly (MODEL: 701730/701740)
2.7 Time-base Accuracy Test	B9989ML	ANALOG Board Assembly (MODEL: 701715/701730/701740)
	B8052MH	AD2 Board Assembly (MODEL: 701715)
	B8052MB	AD4 Board Assembly (MODEL: 701730/701740)
2.8 Trigger Sensitivity Test	B9989ML	ANALOG Board Assembly (MODEL: 701715/701730/701740)
	B8052MH	AD2 Board Assembly (MODEL: 701715)
	B8052MB	AD4 Board Assembly (MODEL: 701730/701740)
2.9 Trigger Accuracy Test	B9989ML	ANALOG Board Assembly (MODEL: 701715/701730/701740)
	B8052MH	AD2 Board Assembly (MODEL: 701715)
	B8052MB	AD4 Board Assembly (MODEL: 701730/701740)

4.4 Power Supply Secondary Voltage

Check whether the power supply secondary voltage fits the values listed on figure 4.2, “Power Supply Secondary Terminals” and Table 4.5, “Power Supply Secondary Terminal’s Name.”

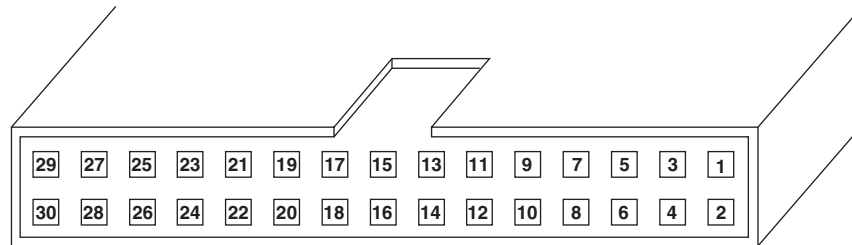

Figure 4.2 Power Supply Secondary Terminals

Table 4.5 Power Supply Secondary Terminal’s Name

Pin No.	Name
1	Sense
2, 4	+24 V
5	Remote
6	AC 5 V
8	-12 V
10	-5.2 V
13, 14	-2 V
17, 18	+5 V
25-30	+3.3 V
3, 7, 9, 11, 12, 15, 16, 19—24	GND

When checking the secondary voltage of the power supply unit apart from the main unit, short the remote pin to ground and turn ON the main switch of the power supply unit located on the rear panel.

6.1 Customer Maintenance Parts List

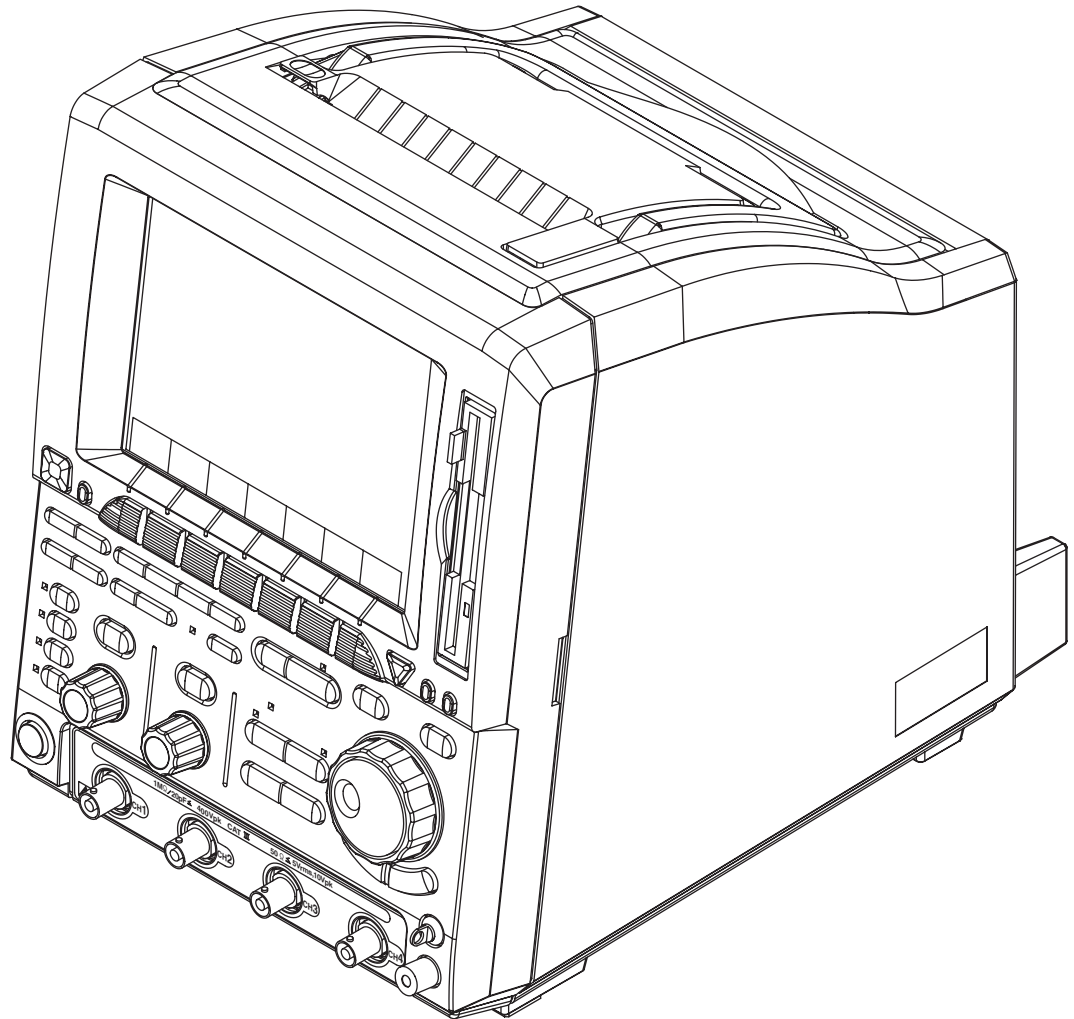

Note: Parts marked with a \odot symbol are Customer Maintenance Parts (CMP).

6.1 Customer Maintenance Parts List

Complete Set

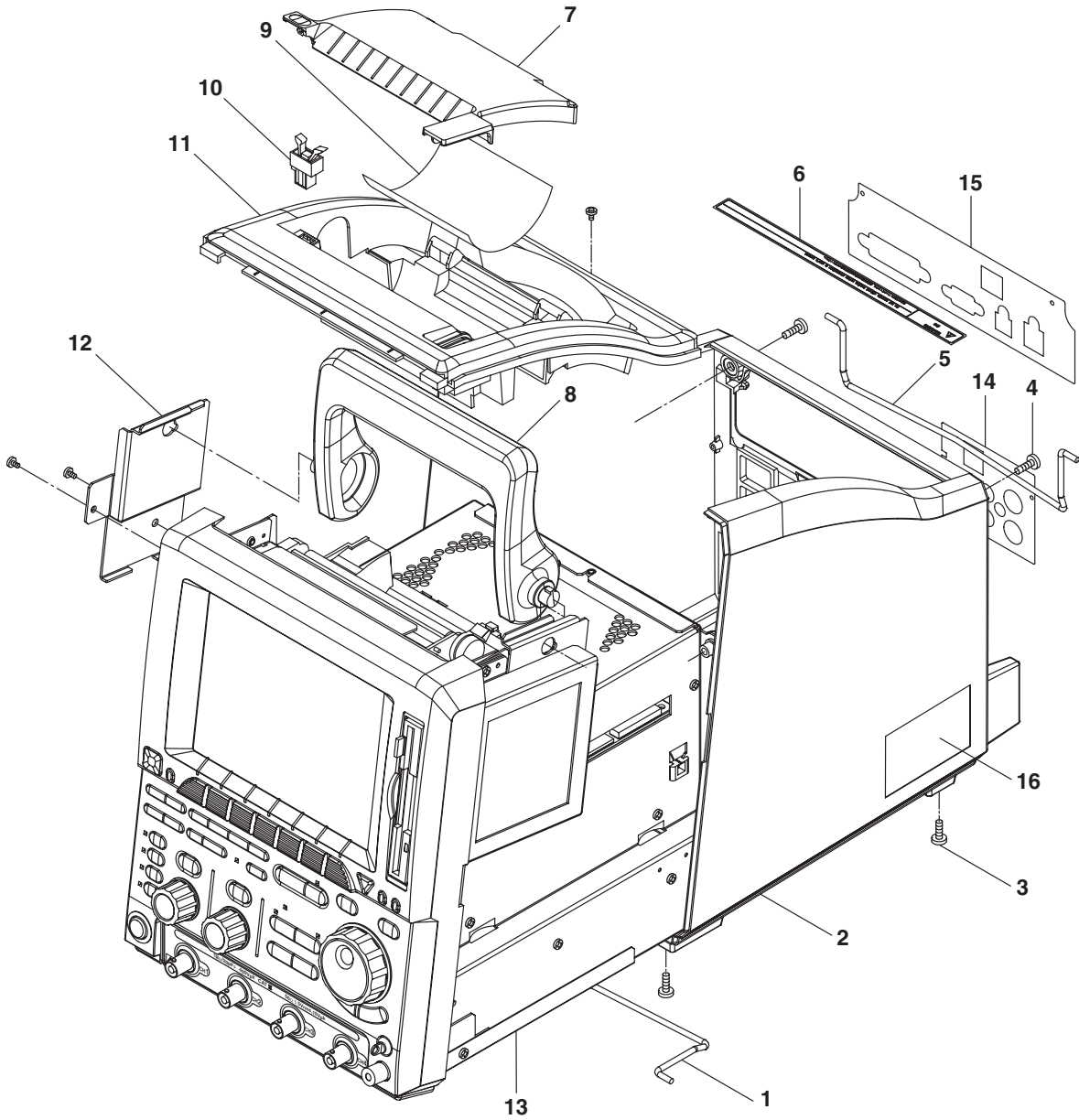

Item	Part No.	Qty	Description	Item	Part No.	Qty	Description
⊙ 1	B9989EC	1	Support	11	B9989DR	1	Printer Case
2	B9989DA	1	Top Cover	12	B9989CJ	1	Frame
3	Y9408LB	4	B.H. Screw, M4x8	13	-	1	Main Assembly
4	Y9408LB	2	B.H. Screw, M4x8	⊙ 14	B8052DN	1	Sheet (/P2) (select)
⊙ 5	B9989EC	1	Support		B8052DP	1	Sheet (/P4) (select)
⊙ 6	B9989EU	1	Sheet	⊙ 15	B8052DH	1	Sheet (/C10) (select)
⊙ 7	B9989DT	1	Printer Cover		B8052DJ	1	Sheet (not /C10) (select)
8	B9989DU	1	Handle	16	A9657ZJ	1	Name Plate
9	B9946BQ	1	Sheet (/B5)				
10	B9858GB	1	Clamp				

Note: ⊙ CMPL parts

Main Assembly

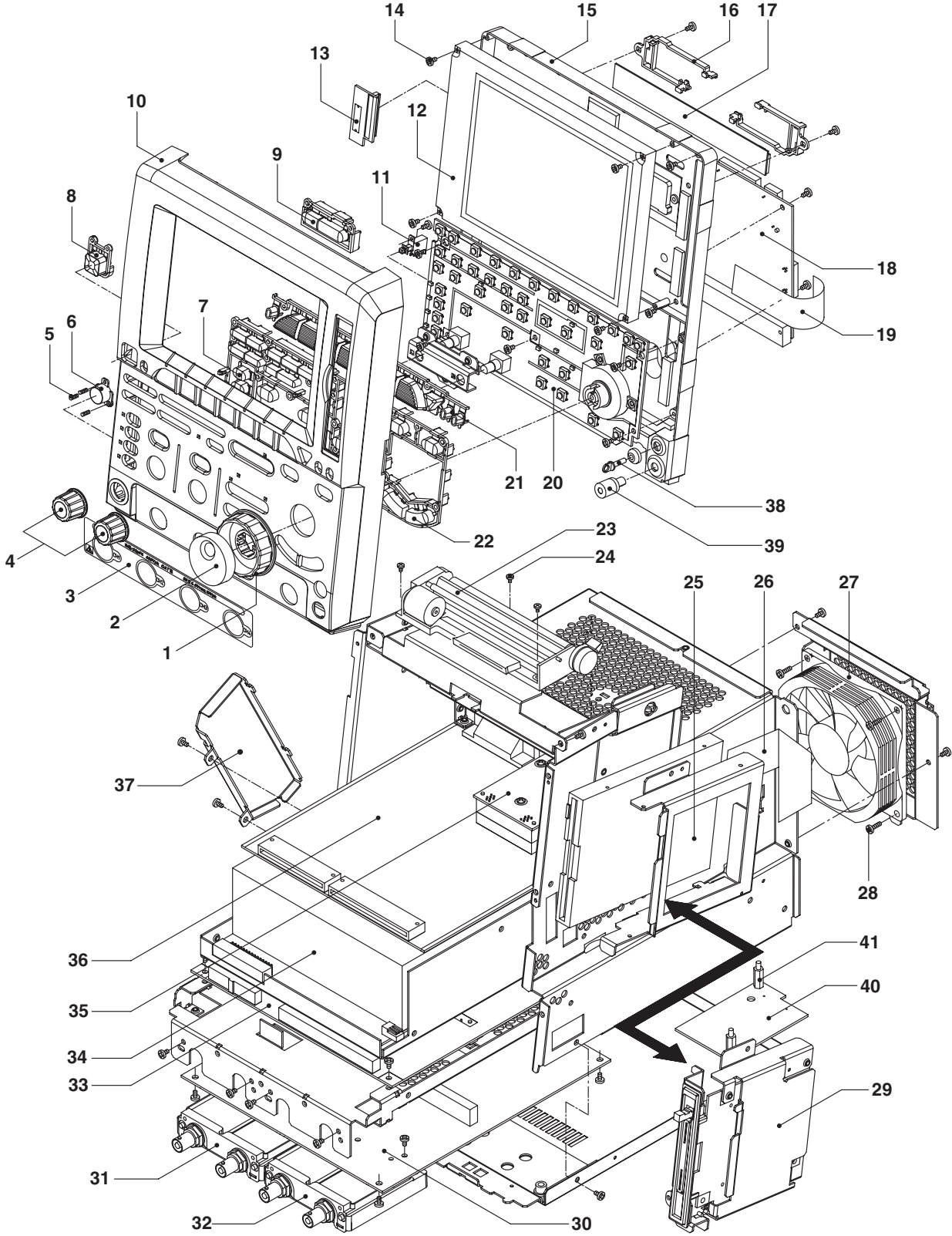

6.1 Customer Maintenance Parts List

Item	Part No.	Qty	Description
⊙ 1	B9989DY	1	Knob
⊙ 2	B9989DX	1	Knob
3	B8052DE	1	Sheet (701715)
	B8052DF	1	Sheet (701730, 701740) } (select)
⊙ 4	B9989DK	2	Knob
5	B9989EL	3	Spring
6	B9989DL	1	Knob
7	B9969DK	9	Lens
8	B9989DM	1	Knob
9	B9969DE	1	Knob
10	B8052DA	1	Front Bezel (701715) }
	B8052DB	1	Front Bezel (701730) } (select)
	B8052DC	1	Front Bezel (701740) }
11	B9989SD	1	Cable Assembly (AD-Switch)
12	A1056VA	1	LCD
13	B9958LD	1	LCD-CN Board Assembly
14	Y9205LB	4	Screw
15	B9989CA	1	Front Frame
16	A9135ZM	2	Spacer
17	A1468UP	1	Power Supply
18	B8052MP	1	Mother Board Assembly
19	B9989YE	1	SUMI-Card,BUS-KBD
20	B9989MK	1	Key Board Assembly
21	B9989DQ	1	Knob
22	B9989DG	1	Knob (701715) }
	B9989DH	1	Knob (701730, 701740) } (select)
23	A1207UD	1	I/O Device (/B5)
24	Y9205LB	3	Screw (/B5)
25	A1161UN	1	Memory System (-J1)
26	B8050WD	1	SUMI Card (-J1) (CPU-Floppy)
27	B9989SA	1	Fan Assembly
28	Y9308LB	4	B.H. Screw,M3x8
29	B8050MK	1	PCMCIA Assembly (-J3)
30	B8052MB	1	AD4 Board Assembly (701730, 701740) }
	B8052MH	1	AD2 Board Assembly (701715) } (select)
31	B9989QA	1	Analog Assembly
32	B9989QA	1	Analog Assembly (701730, 701740) }
	B9989QG	1	ET2 Assembly (701715) } (select)
33	B8052MD	1	ACQ4S Board Assembly (701730) }
	B8052ME	1	ACQ4L Board Assembly (701740) } (select)
	B8052MF	1	ACQ2S Board Assembly (701715) }
34	B8052YA	1	Power Supply
35	B8052BX	1	Ethernet Assembly (/C10)
36	B8052MC	1	CPU Board Assembly
37	B8052CU	1	Bracket
	B8052SA	1	Cable Assembly
38	B9850EG	1	TIP
39	B9850EF	1	Rod
40	B8051MG	1	OPT Trig Board Assembly (/F5)
41	B8051EN	2	Stud (/F5)

Note : ⊙ CMLP parts

6.2 Standard Accessories

Standard Accessories

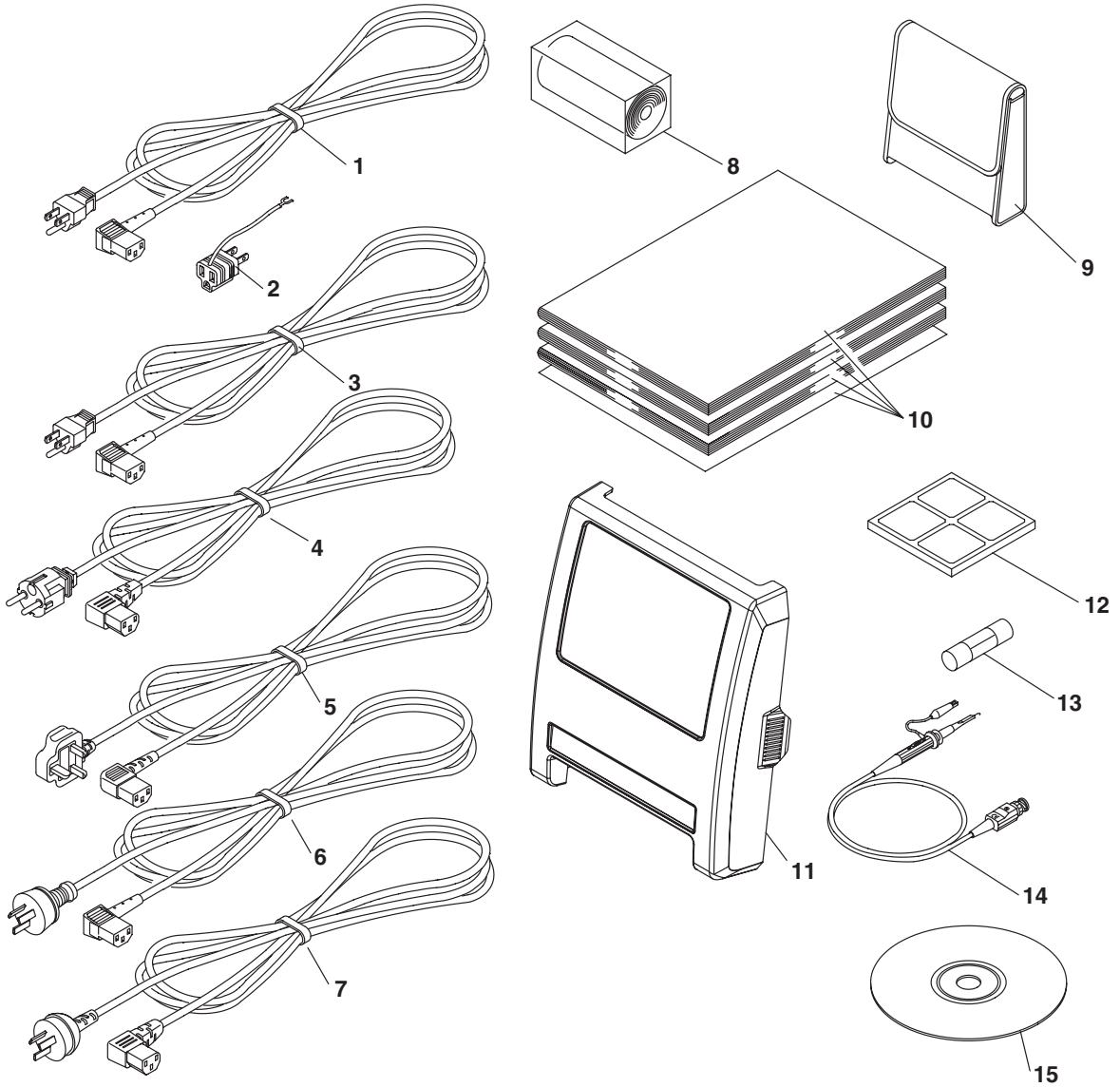

Item	Part No.	Qty	Description
Ⓞ 1	A1006WD	1	Power Supply Code (Suffix code-D, UL.CSA standard)
Ⓞ 2	A1253JZ	1	3P-2P Adapter
Ⓞ 3	A1006WD	1	Power Supply Code (Suffix code-D, UL.CSA standard)
Ⓞ 4	A1009WD	1	Power Supply Code (Suffix code-F, VDE standard)
Ⓞ 5	A1054WD	1	Power Supply Code (Suffix code-Q, BS standard)
Ⓞ 6	A1024WD	1	Power Supply Code (Suffix code-R, AS standard)
Ⓞ 7	A1064WD	1	Power Supply Code (Suffix code-H, GB standard)
Ⓞ 8	B9850NX	1	Roll Chart (/B5)
Ⓞ 9	B9918EZ	1	Soft Case
10	-	1	Manuals
Ⓞ 11	B9989FA	1	Front Cover
Ⓞ 12	B9989EX	1	Stopper
Ⓞ 13	A1352EF	1	Fuse (250V / 4A)
14	700988	2	Probe (701715)
	700988	4	Probe (701730, 701740)
Ⓞ 15	-	1	CD for Manual for DL1740E

Note : * For use in Japan only,
Suffix code-M
Ⓞ CMPL parts

7.1 Flow Chart of Disassembly

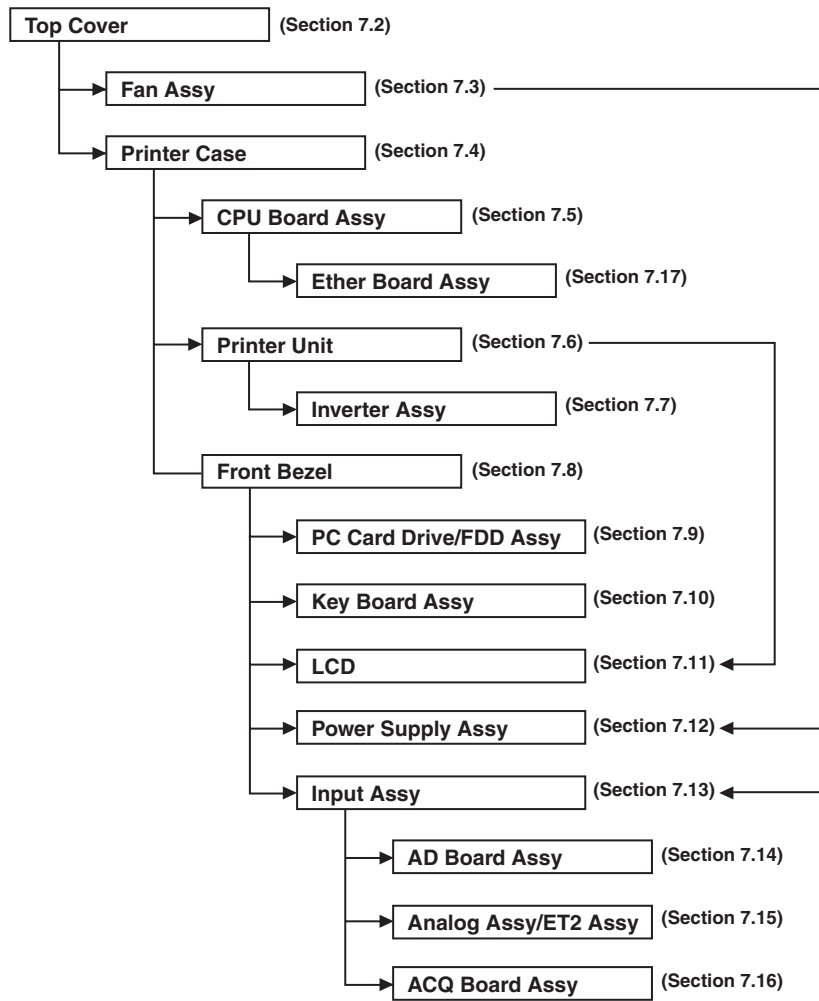

7.2 Removing the Top Cover

1. Remove the two screws from the rear panel as shown.



2. Remove the four screws from the bottom of the instrument as shown.



3. The top cover fits into the back of the front bezel. Remove the top cover by slowly pulling it away from the front bezel in the direction of the arrow as shown in the figure below.



DL with the Top Cover Removed



7.3 Removing the Fan Assy

1. Remove the top cover. See section 7.2, "Removing the Top Cover."
2. Remove the cables on the right side panel as you face the instrument as shown in the figure below.

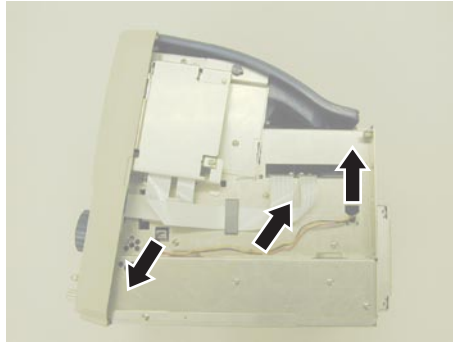

3. Remove the three screws from the rear panel as shown in the figure.

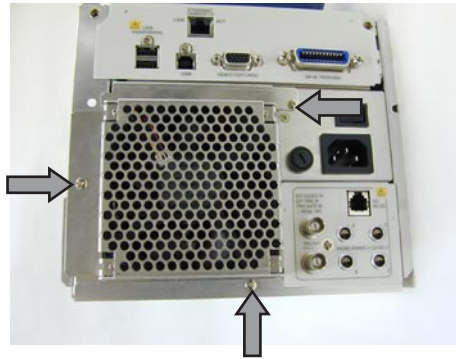

DL with the Fan Assy Removed



7.4 Removing the Printer Case

1. Remove the top cover. See section 7.2, "Removing the Top Cover."
2. Remove the printer cover by raising it in the direction of the arrow as shown below, then forcing it back until it pops out.

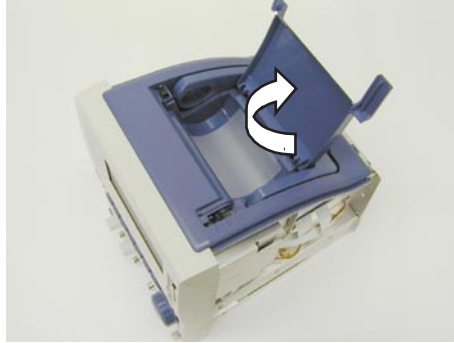

3. Remove the screw from the printer case located toward the rear of the instrument.

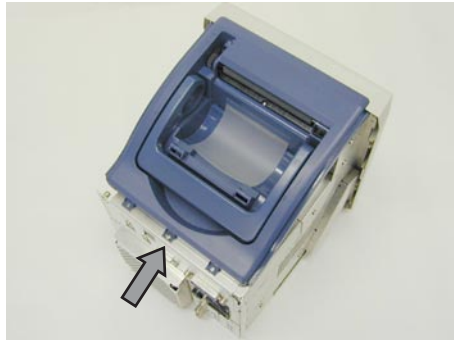

4. Lift the printer case to remove it, allowing the handle to slide through the opening in the case.

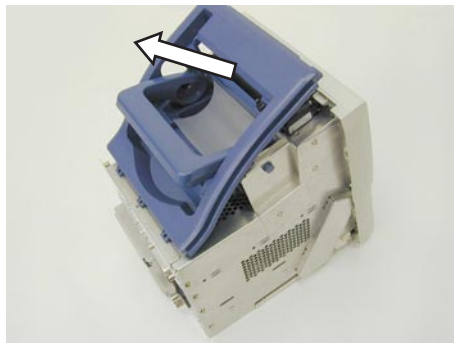

DL with the Printer Case Removed



7.5 Removing the CPU Board Assy

1. Remove the printer case. See section 7.4, "Removing the Printer Case."
2. Remove the screw from the left side panel as shown in the figure.

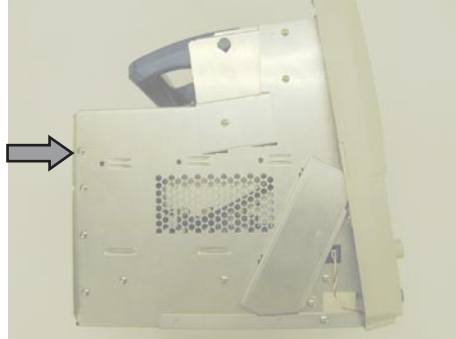

3. Remove the screw from the right side panel as shown, then remove the multiconductor(s) (there are two multiconductors with a PC card, and one with a floppy disk drive).

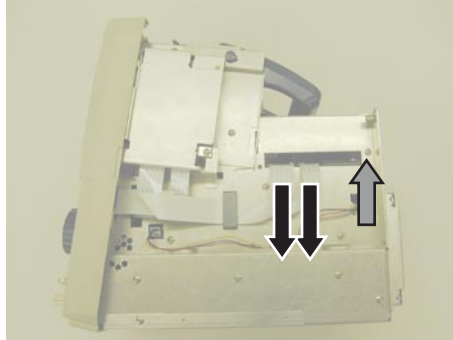

4. Pull out the CPU Board Assy in the direction of the arrow as shown in the figure below, then remove the assy.

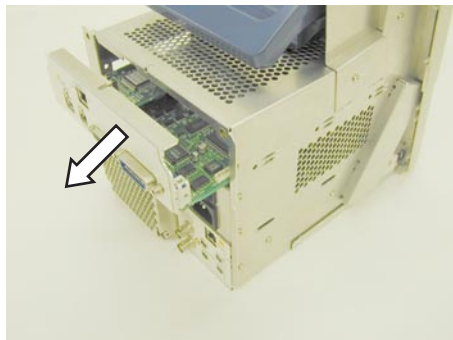

DL with the CPU Board Assy Removed



7.6 Removing the Printer Unit

1. Remove the printer case. See section 7.4, "Removing the Printer Case."
2. Remove the two screws from the left side panel as shown in the figure below. Next, remove the handle and bracket in the direction of the arrow.

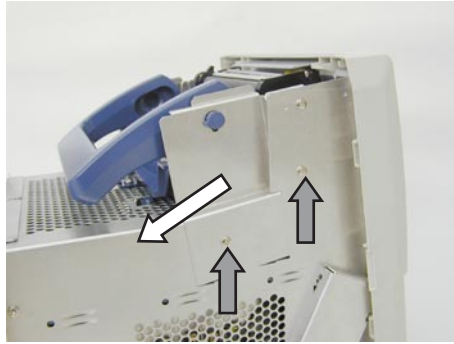

DL with the Handle and Bracket Removed

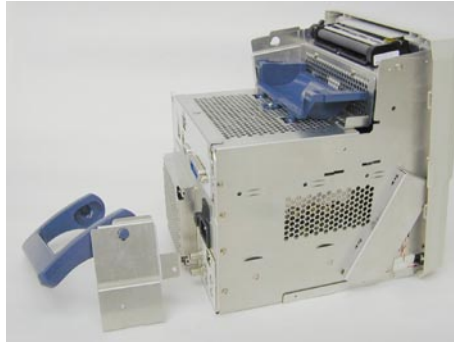

3. Remove the screw as shown in the figure below, then remove the roll paper holder in the direction of the arrow.

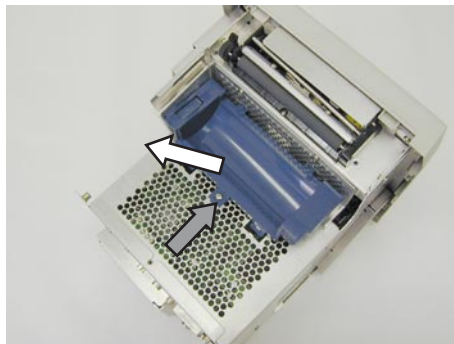

4. Remove the two screws as shown in the figure below, then remove the cover in the direction of the arrow.

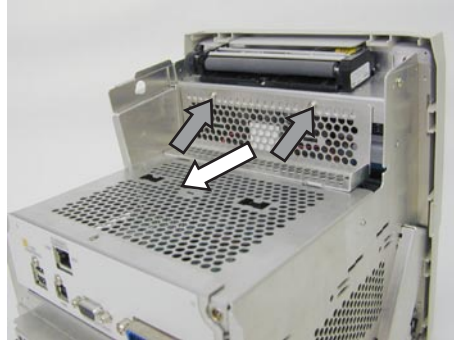

5. Remove the cable in the direction of the arrow shown in the figure below.

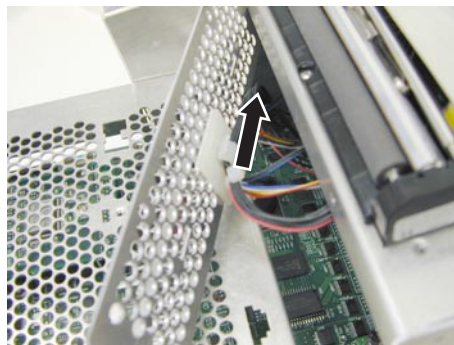

6. Remove the screws from the left side panel as shown in the figure below.



7. Remove the screw from the right side panel as shown in the figure below.



7.6 Removing the Printer Unit

8. Remove the two screws as shown in the figure below, then lift up the I/O device in the direction of the white arrow.

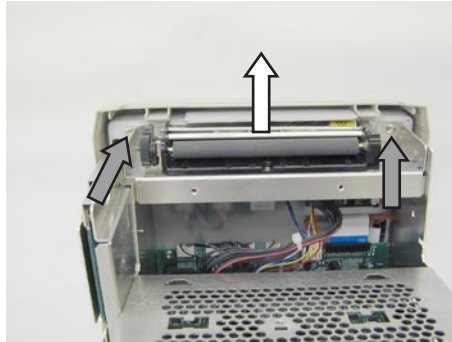

DL with the I/O Device Removed



9. Disconnect the three cable connectors as shown in the figure below, then remove the cables.

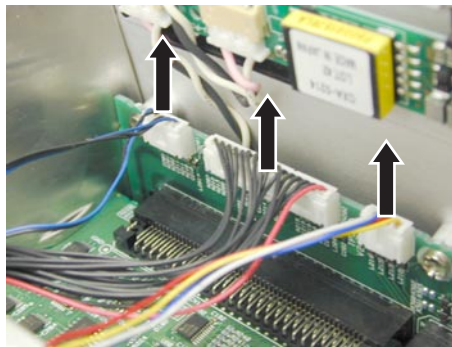

DL with the Printer Unit Removed

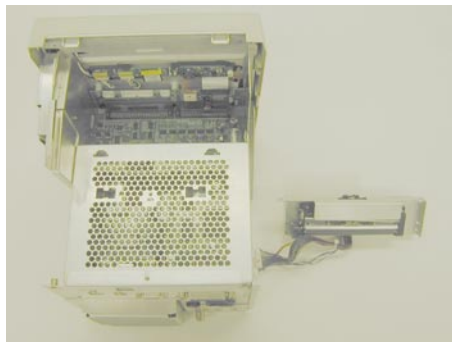

7.7 Removing the Inverter Assy

1. Remove the printer unit. See section 7.6, "Removing the Printer Unit."
2. Remove the two screws as shown, disconnect the three cables, then remove the assy.

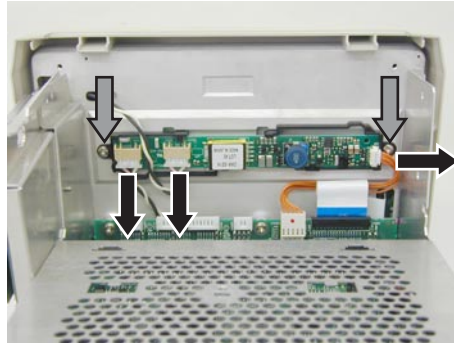

DL with the Inverter Assy Removed



7.8 Removing the Front Bezel

1. Remove the printer case. See section 7.4, “Removing the Printer Case.”
2. Pull out the three knobs in the direction of the arrow shown in the figure below and remove them.

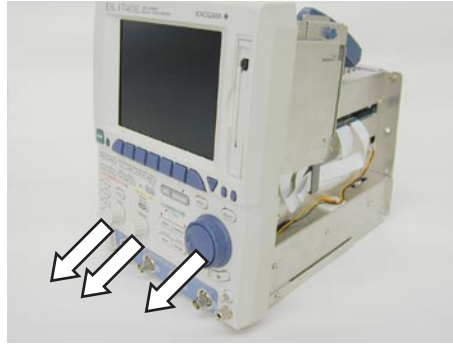

Note

When the TIME/DIV and V/DIV knobs are removed, the “rib” holding the knob to its shaft becomes worn down causing the knob to become loose. Therefore, you should replace the removed knobs with new ones.

3. As shown in the figure below, lift up the eight tabs that surround the Front Bezel, then remove the Front Bezel.

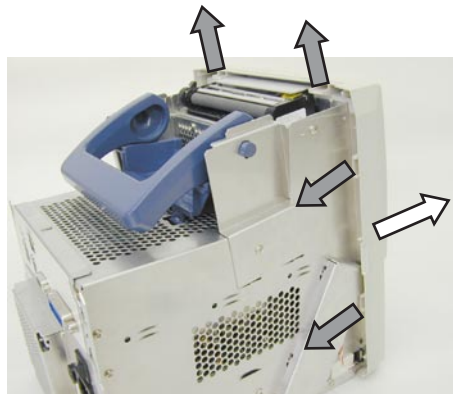
**DL with the Front Bezel Removed**

7.9 Removing the PC Card Drive/FDD Assy

1. Remove the front bezel. See section 7.8, "Removing the Front Bezel."
2. Remove the multiconductor(s) (there are two multiconductors with a PC card drive, and one with a floppy disk drive), then remove the two screws as shown in the figure below.

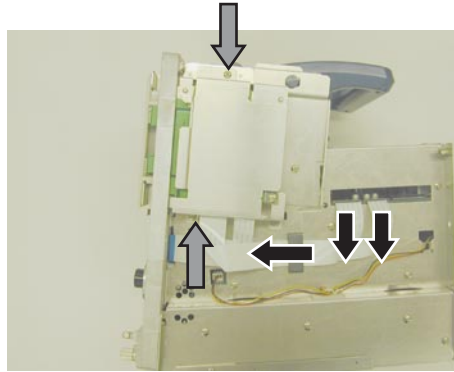

DL with the PC Card Drive/FDD Assy Removed

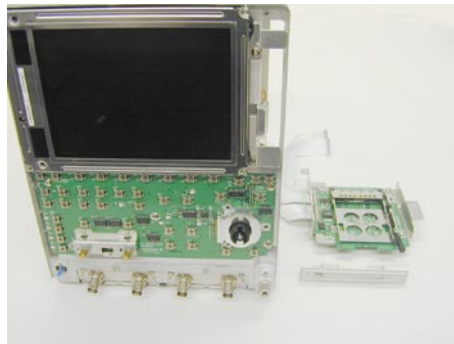

7.10 Removing the Key Board Assy

1. Remove the front bezel. See section 7.8, "Removing the Front Bezel."
2. Remove the five screws as shown in the figure below.

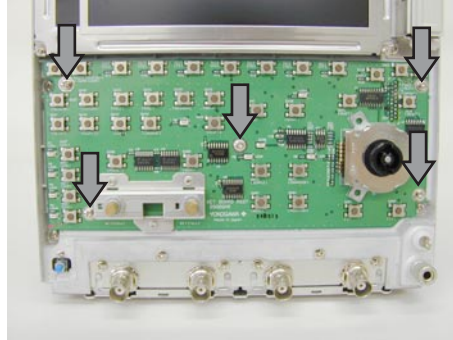

3. Remove the multiconductor as shown in the figure.

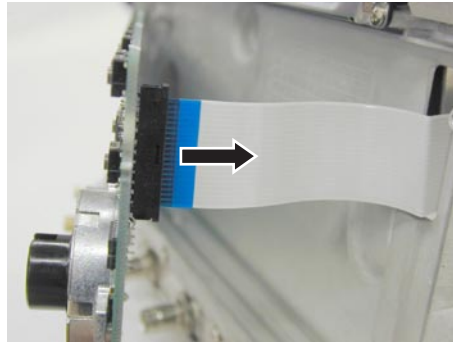

DL with the Key Board Assy Removed

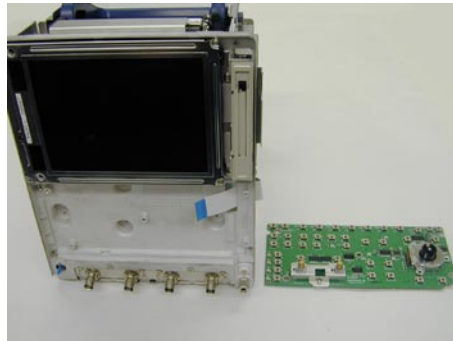

7.11 Removing the LCD

1. Remove the printer unit and the front bezel. See section 7.6, "Removing the Printer Unit" and section 7.8, "Removing the Front Bezel."
2. Remove the two cables, then remove the multiconductor as shown in the figure below.

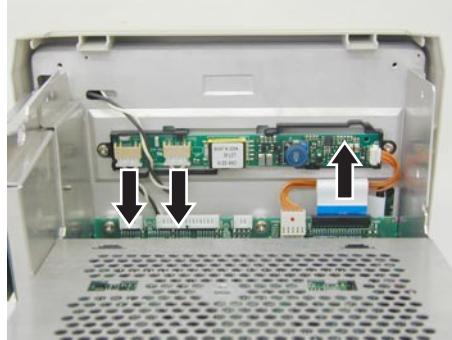

3. Remove the four screws as shown in the figure below.

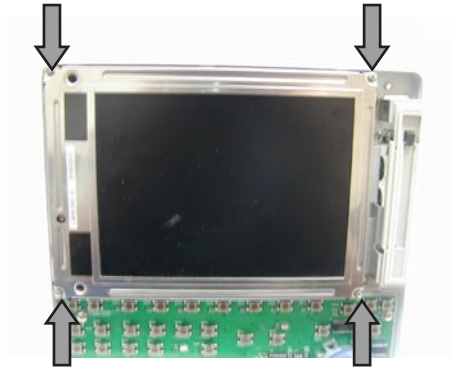

4. Remove the LCD and board as shown in the figure below.

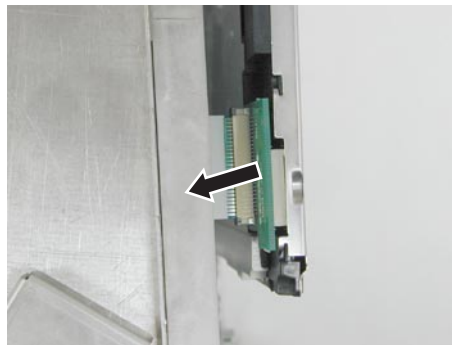

DL with the LCD Removed



7.12 Removing the Power Supply Assy

1. Remove the fan assy and the front bezel. See section 7.3, "Removing the Fan Assy" and section 7.8, "Removing the Front Bezel."
2. Remove the two screws, then remove the bracket as shown in the figure below.

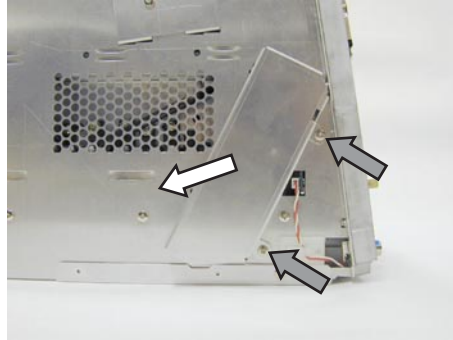

3. Remove the three screws as shown in the figure below.



4. Remove the three screws as shown in the figure below.

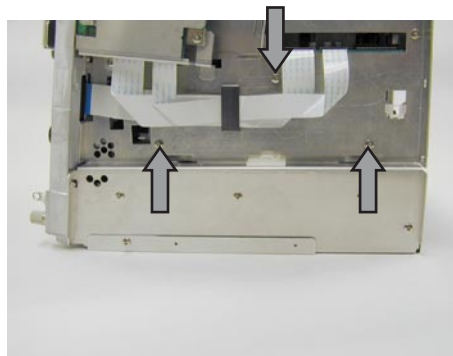

5. Pull out the Power Supply Assy as shown in the figure below and remove it.

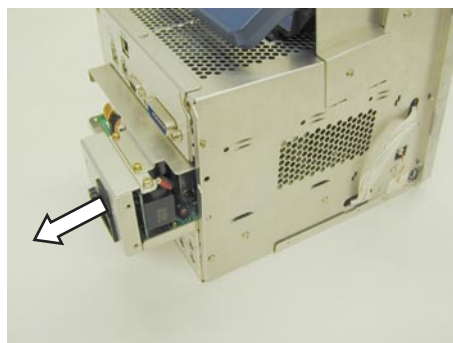

DL with the Power Supply Assy Removed

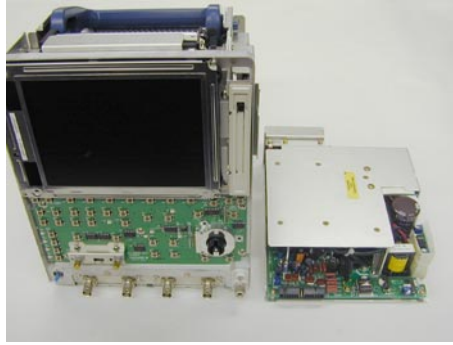

7.13 Removing the Input Assy

1. Remove the fan assy and the front bezel. See section 7.3, "Removing the Fan Assy" and section 7.8, "Removing the Front Bezel."
2. Remove the two screws as shown in the figure below.



3. Remove the five screws as shown in the figure below.

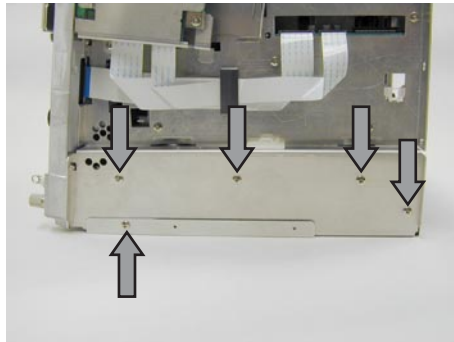

4. Remove the two screws, then remove the bracket as shown in the figure below.

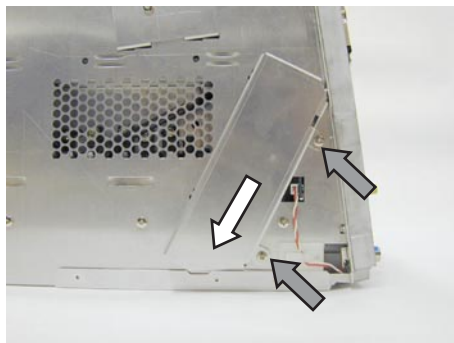

5. Remove the five screws, then remove the cable as shown in the figure below.

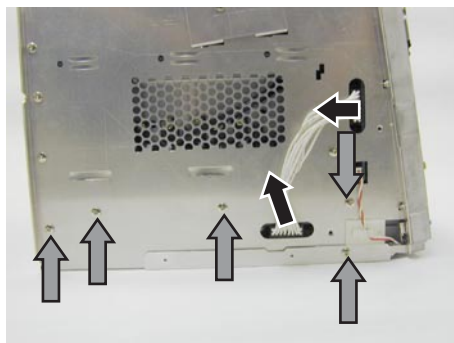

6. Remove the left shield plate as shown in the figure below.



7. Remove the right shield plate as shown in the figure below.

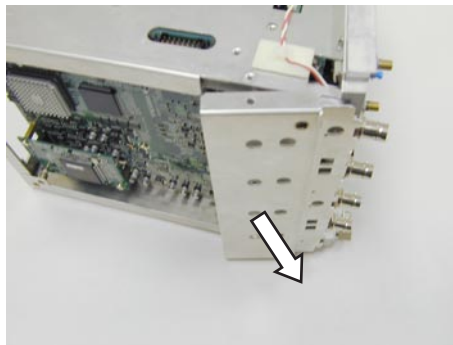

8. Remove the cable as shown in the figure below.

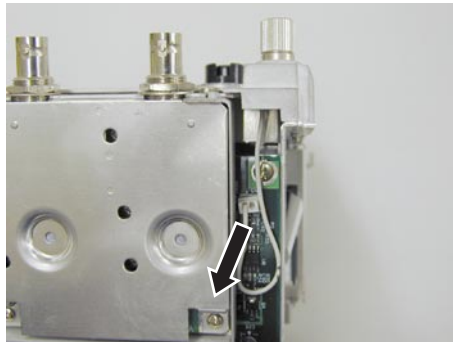

9. Lift up the front end of the board assy as shown in figure below (left), then pull it out in the direction of the rear panel as shown in figure below (right).

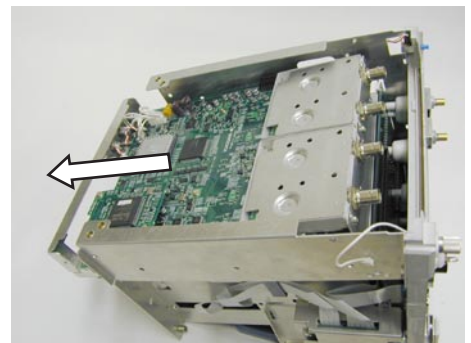
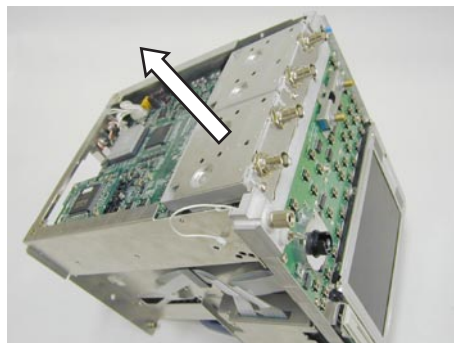

7.13 Removing the Input Assy

DL with the Input Assy Removed



7.14 Removing the AD Board Assy

1. Remove the input assy. See section 7.13, "Removing the Input Assy."

Note

The AD Board Assy is easier to remove if you first remove the ACQ Board Assy. See section 7.16, "Removing the ACQ Board Assy."

2. Remove the four screws as shown in the figure below, then remove the nuts as shown in the figure below.

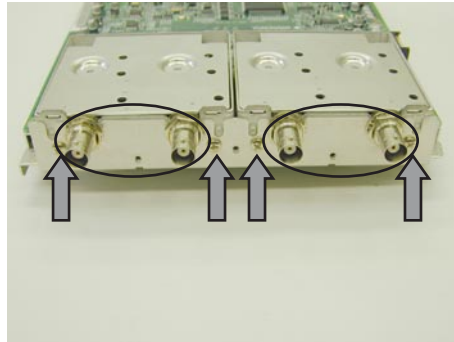

3. As shown in the figure below, remove the eight screws, then remove the six cables.
4. Remove the panel as shown in the figure below.

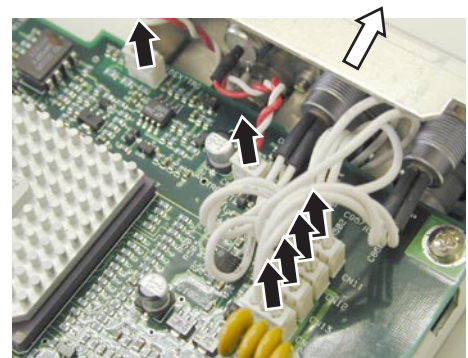
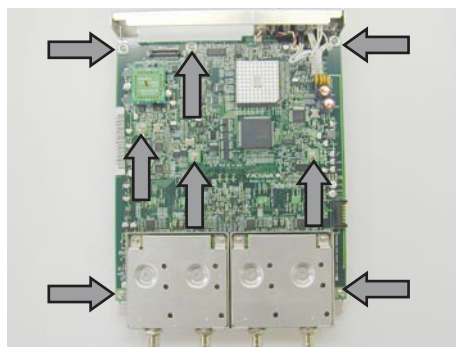

If an option is installed, remove the two screws securing the option and the option itself, then remove the studs.

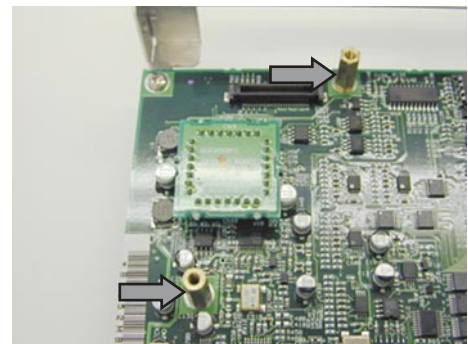
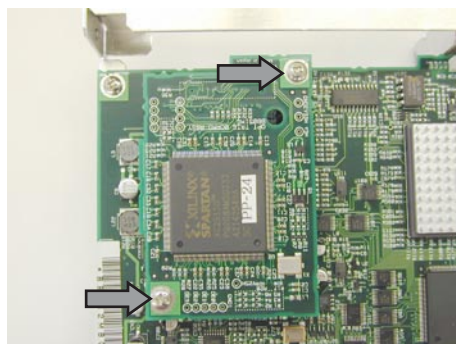

7.14 Removing the AD Board Assy

DL with the AD Board Assy Removed

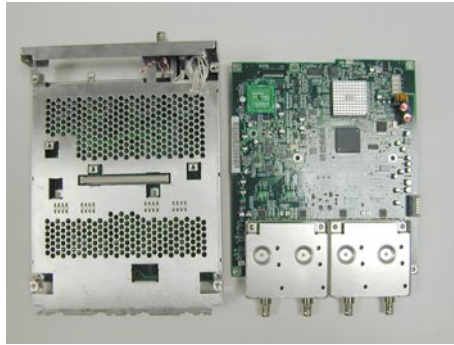

7.15 Removing the Analog Assy/ET2 Assy

1. Remove the input assy. See section 7.13, "Removing the Input Assy."
2. Remove the two screws, then remove the cover as shown in the figure below.

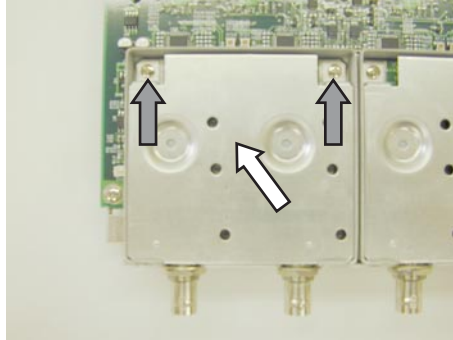

3. Remove the screw as shown in the figure below.

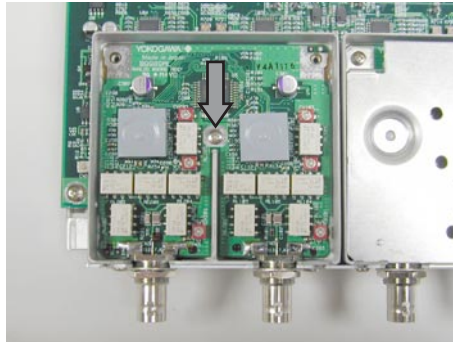

4. Remove the nuts as shown in the figure below.

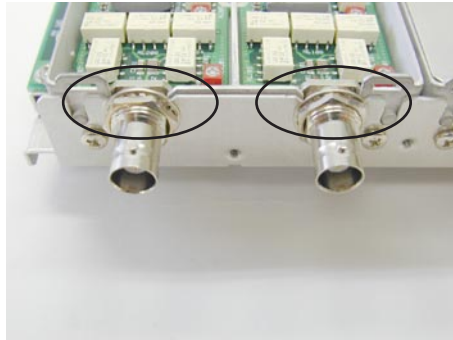

DL with the Analog Assy/ET2 Assy Removed



7.16 Removing the ACQ Board Assy

1. Remove the input assy. See section 7.13, "Removing the Input Assy."
2. Remove the screw as shown in the figure below.

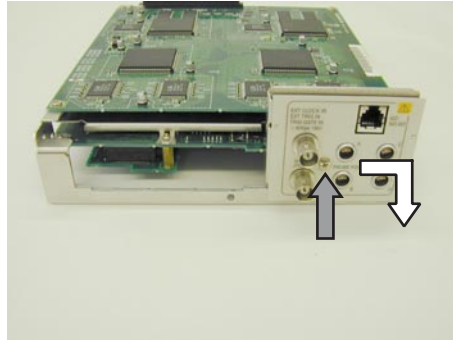

3. Remove the six screws as shown in the figure below.

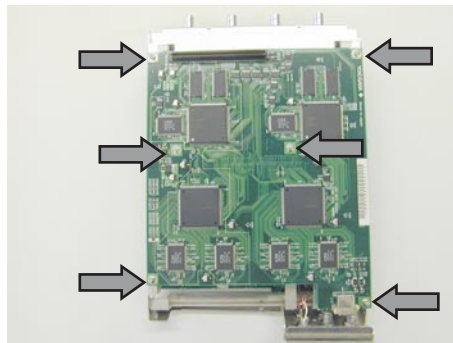

DL with the ACQ Board Assy Removed

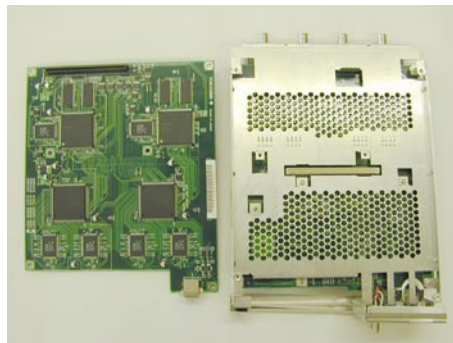

7.17 Removing the Ether Board Assy

1. Remove the CPU board Assy. See section 7.5, "Removing the CPU board Assy."
2. Remove the three screws as shown in the figure below.

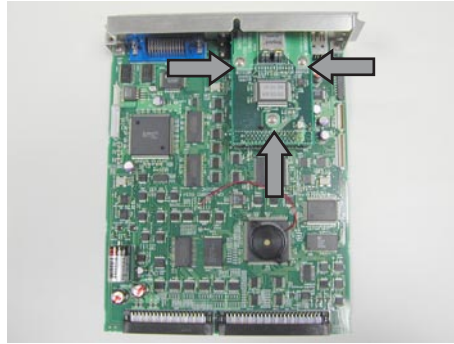

DL with the Ether Board Assy Removed

