



AO3419, AO3419L (Green Product)
P-Channel Enhancement Mode Field Effect Transistor

General Description

The AO3419 uses advanced trench technology to provide excellent $R_{DS(ON)}$, low gate charge and operation with gate voltages as low as 2.5V. This device is suitable for use as a load switch or in PWM applications. It is ESD protected. AO3419L (Green Product) is offered in a lead-free package.

Features

$V_{DS} (V) = -20V$
 $I_D = -3.5 A$
 $R_{DS(ON)} < 75m\Omega (V_{GS} = -10V)$
 $R_{DS(ON)} < 95m\Omega (V_{GS} = -4.5V)$
 $R_{DS(ON)} < 145m\Omega (V_{GS} = -2.5V)$
 ESD Rating: 2000V HBM

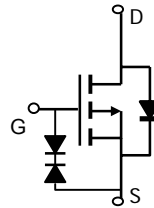
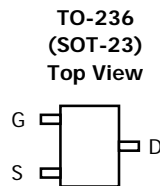

Absolute Maximum Ratings $T_A=25^\circ C$ unless otherwise noted

Parameter	Symbol	Maximum	Units
Drain-Source Voltage	V_{DS}	-20	V
Gate-Source Voltage	V_{GS}	± 12	V
Continuous Drain Current ^A	$T_A=25^\circ C$	-3.5	A
	$T_A=70^\circ C$	-2.8	
Pulsed Drain Current ^B	I_{DM}	-15	
Power Dissipation ^A	$T_A=25^\circ C$	1.4	W
	$T_A=70^\circ C$	0.9	
Junction and Storage Temperature Range	T_J, T_{STG}	-55 to 150	$^\circ C$

Thermal Characteristics

Parameter	Symbol	Typ	Max	Units
Maximum Junction-to-Ambient ^A	$R_{\theta JA}$	65	90	$^\circ C/W$
Maximum Junction-to-Ambient ^A		Steady-State	85	
Maximum Junction-to-Lead ^C	$R_{\theta JL}$	43	60	$^\circ C/W$

Electrical Characteristics ($T_J=25^\circ\text{C}$ unless otherwise noted)

Symbol	Parameter	Conditions	Min	Typ	Max	Units
STATIC PARAMETERS						
BV_{DSS}	Drain-Source Breakdown Voltage	$I_D=-250\mu\text{A}$, $V_{GS}=0\text{V}$	-20			V
I_{DSS}	Zero Gate Voltage Drain Current	$V_{DS}=-16\text{V}$, $V_{GS}=0\text{V}$ $T_J=55^\circ\text{C}$			-0.5 -2.5	μA
I_{GSS}	Gate-Body leakage current	$V_{DS}=0\text{V}$, $V_{GS}=\pm 10\text{V}$ $V_{DS}=0\text{V}$, $V_{GS}=\pm 12\text{V}$			± 1 ± 10	μA
$V_{GS(th)}$	Gate Threshold Voltage	$V_{DS}=V_{GS}$, $I_D=-250\mu\text{A}$	-0.7	-0.9	-1.4	V
$I_{D(ON)}$	On state drain current	$V_{GS}=-4.5\text{V}$, $V_{DS}=-5\text{V}$	-15			A
$R_{DS(ON)}$	Static Drain-Source On-Resistance	$V_{GS}=-10\text{V}$, $I_D=-3.5\text{A}$ $T_J=125^\circ\text{C}$ $V_{GS}=-4.5\text{V}$, $I_D=-3\text{A}$ $V_{GS}=-2.5\text{V}$, $I_D=-1\text{A}$		59 83 76 111	75 105 95 145	$\text{m}\Omega$
g_{FS}	Forward Transconductance	$V_{DS}=-5\text{V}$, $I_D=-3.5\text{A}$		6.8		S
V_{SD}	Diode Forward Voltage	$I_S=-1\text{A}$, $V_{GS}=0\text{V}$	-0.65	-0.81	-0.95	V
I_S	Maximum Body-Diode Continuous Current				-2	A
DYNAMIC PARAMETERS						
C_{iss}	Input Capacitance	$V_{GS}=0\text{V}$, $V_{DS}=-10\text{V}$, $f=1\text{MHz}$		512	620	pF
C_{oss}	Output Capacitance			77		pF
C_{rss}	Reverse Transfer Capacitance			62		pF
R_g	Gate resistance	$V_{GS}=0\text{V}$, $V_{DS}=0\text{V}$, $f=1\text{MHz}$		9.2	13	Ω
SWITCHING PARAMETERS						
Q_g	Total Gate Charge	$V_{GS}=-4.5\text{V}$, $V_{DS}=-10\text{V}$, $I_D=-3.5\text{A}$		5.5	6.6	nC
Q_{gs}	Gate Source Charge			0.8		nC
Q_{gd}	Gate Drain Charge			1.9		nC
$t_{D(on)}$	Turn-On Delay Time	$V_{GS}=-10\text{V}$, $V_{DS}=-10\text{V}$, $R_L=2.8\Omega$, $R_{GEN}=3\Omega$		5		ns
t_r	Turn-On Rise Time			6.7		ns
$t_{D(off)}$	Turn-Off Delay Time			28		ns
t_f	Turn-Off Fall Time			13.5		ns
t_{rr}	Body Diode Reverse Recovery Time	$I_F=-3.5\text{A}$, $dI/dt=100\text{A}/\mu\text{s}$		9.8	12	ns
Q_{rr}	Body Diode Reverse Recovery Charge	$I_F=-3.5\text{A}$, $dI/dt=100\text{A}/\mu\text{s}$		2.7		nC

A: The value of $R_{\theta JA}$ is measured with the device mounted on 1 in² FR-4 board with 2oz. Copper, in a still air environment with $T_A=25^\circ\text{C}$. The value in any a given application depends on the user's specific board design. The current rating is based on the $t \leq 10\text{s}$ thermal resistance rating.

B: Repetitive rating, pulse width limited by junction temperature.

C: The $R_{\theta JA}$ is the sum of the thermal impedance from junction to lead $R_{\theta JL}$ and lead to ambient.

D: The static characteristics in Figures 1 to 6,12,14 are obtained using 80 μs pulses, duty cycle 0.5% max.

E: These tests are performed with the device mounted on 1 in² FR-4 board with 2oz. Copper, in a still air environment with $T_A=25^\circ\text{C}$. The SOA curve provides a single pulse rating.

THIS PRODUCT HAS BEEN DESIGNED AND QUALIFIED FOR THE CONSUMER MARKET. APPLICATIONS OR USES AS CRITICAL COMPONENTS IN LIFE SUPPORT DEVICES OR SYSTEMS ARE NOT AUTHORIZED. AOS DOES NOT ASSUME ANY LIABILITY ARISING OUT OF SUCH APPLICATIONS OR USES OF ITS PRODUCTS. AOS RESERVES THE RIGHT TO IMPROVE PRODUCT DESIGN, FUNCTIONS AND RELIABILITY WITHOUT NOTICE.

TYPICAL ELECTRICAL AND THERMAL CHARACTERISTICS

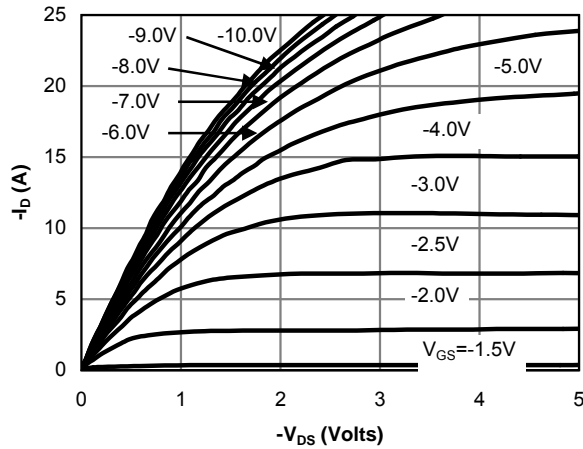

Fig 1: On-Region Characteristics

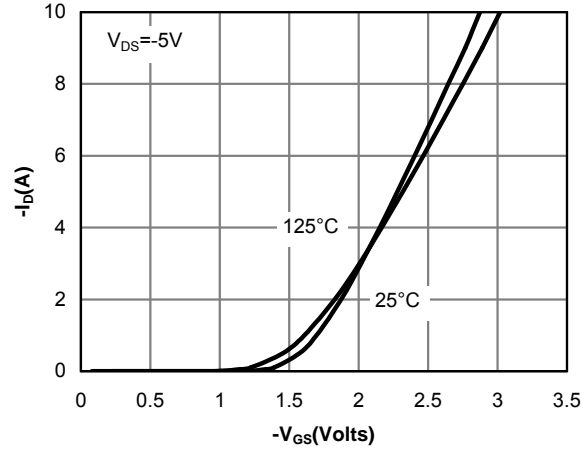

Figure 2: Transfer Characteristics

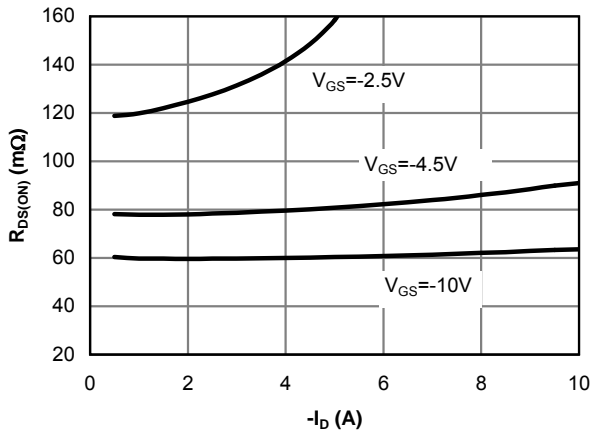

Figure 3: On-Resistance vs. Drain Current and Gate Voltage

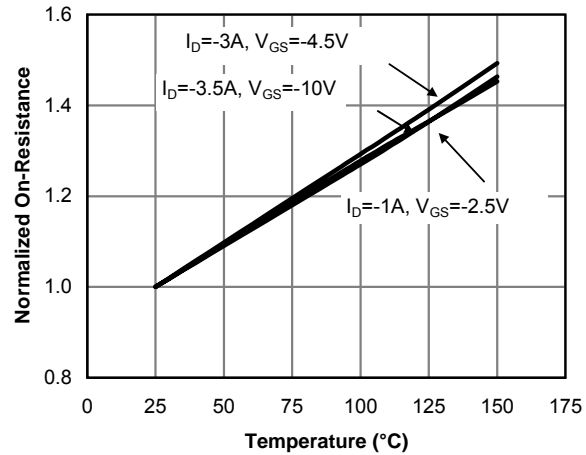

Figure 4: On-Resistance vs. Junction Temperature

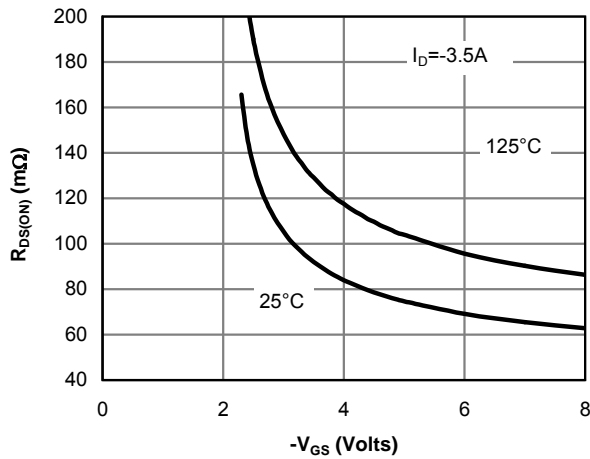

Figure 5: On-Resistance vs. Gate-Source Voltage

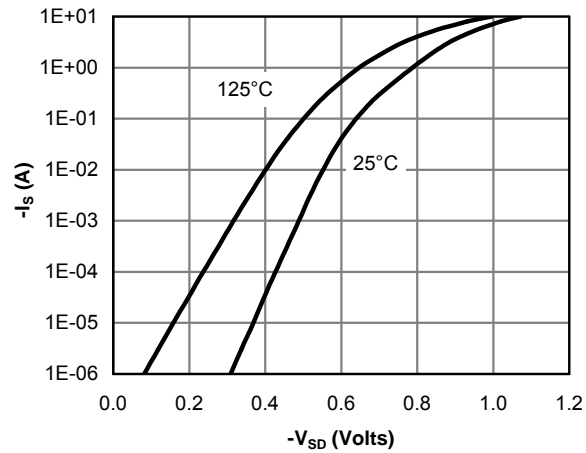

Figure 6: Body-Diode Characteristics

TYPICAL ELECTRICAL AND THERMAL CHARACTERISTICS

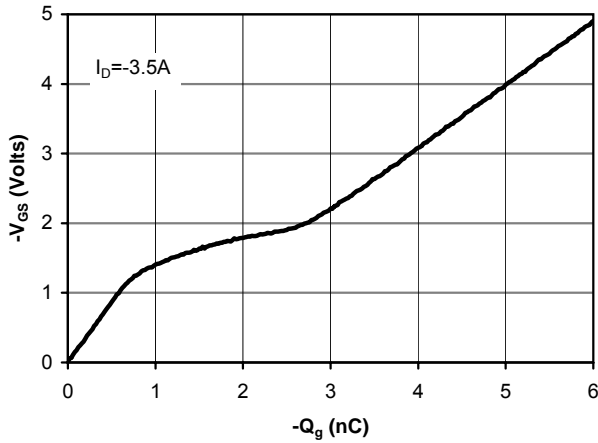

Figure 7: Gate-Charge Characteristics

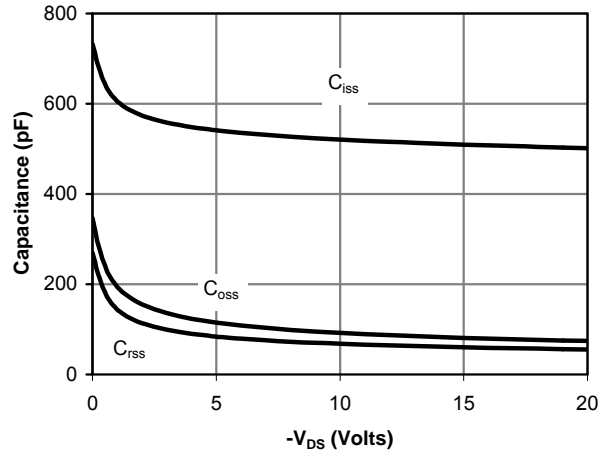

Figure 8: Capacitance Characteristics

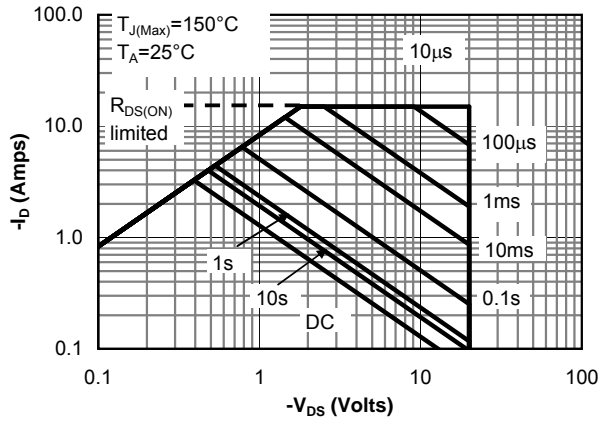

Figure 9: Maximum Forward Biased Safe Operating Area (Note E)

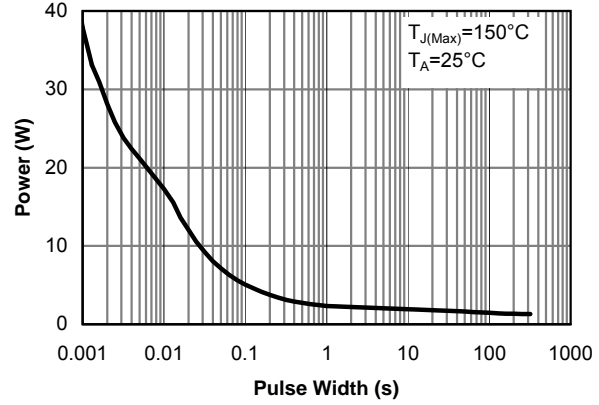

Figure 10: Single Pulse Power Rating Junction-to-Ambient (Note E)

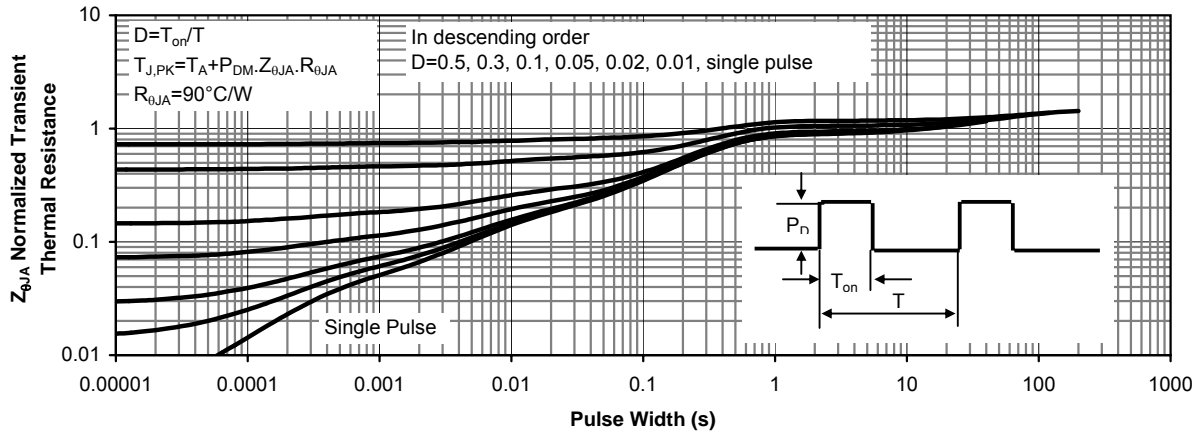

Figure 11: Normalized Maximum Transient Thermal Impedance



ALPHA & OMEGA

SEMICONDUCTOR, LTD.

Document No.	PD-00236
Version	rev C
Title	AO3419 Marking Description

PACKAGE MARKING DESCRIPTION

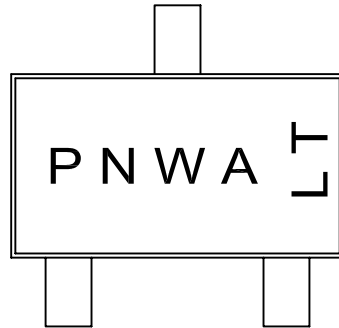

Standard product

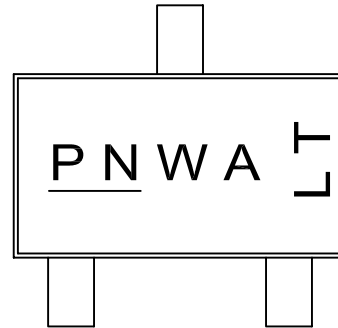

Green product

NOTE:

P - Package and product type.
N - Last digital of product number.
W - Week code
A - Foundry location code
LT - Assembly lot code.

PART NO.	DESCRIPTION	CODE (PN)
AO3419	Standard product	AL
AO3419L	Green product	<u>AL</u>



SOT-23 PACKAGE OUTLINE

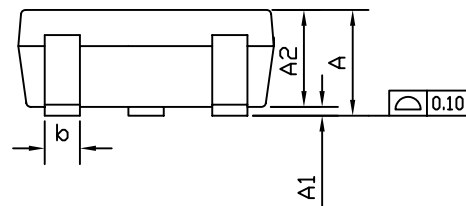
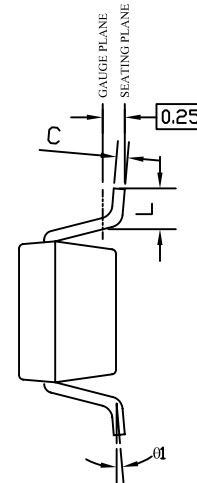
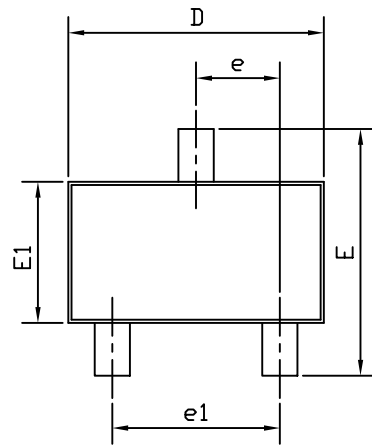

RECOMMENDED LAND PATTERN

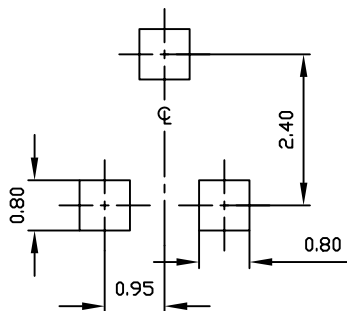

SYMBOLS	DIMENSIONS IN MILLIMETERS			DIMENSIONS IN INCHES		
	MIN	NOM	MAX	MIN	NOM	MAX
A	0.90	—	1.25	0.035	—	0.049
A1	0.00	—	0.10	0.000	—	0.004
A2	0.70	1.00	1.15	0.028	0.039	0.045
b	0.30	0.40	0.50	0.012	0.016	0.020
C	0.08	0.13	0.20	0.003	0.005	0.008
D	2.80	2.90	3.04	0.110	0.114	0.120
E	2.60	2.80	2.95	0.102	0.110	0.116
E1	1.40	1.60	1.80	0.055	0.063	0.071
e	0.95 BSC			0.037 BSC		
e1	1.90 BSC			0.075 BSC		
L	0.40	—	0.60	0.016	—	0.024
01	0°	5°	8°	0°	5°	8°

UNIT: mm

NOTE

1. PACKAGE BODY SIZES EXCLUDE MOLD FLASH OR GATE BURRS.
MOLD FLASH AT THE NON-LEAD SIDES SHOULD BE LESS THAN 5 MILS.
2. TOLERANCE ± 0.100 mm (4 mil) UNLESS OTHERWISE SPECIFIED.
3. DIMENSION L IS MEASURED IN GAGE PLANE.
4. CONTROLLING DIMENSION IS MILLIMETER. CONVERTED INCH DIMENSIONS ARE NOT NECESSARILY EXACT.
5. ALL DIMENSIONS ARE IN MILLIMETERS.



SOT-23 Carrier Tape

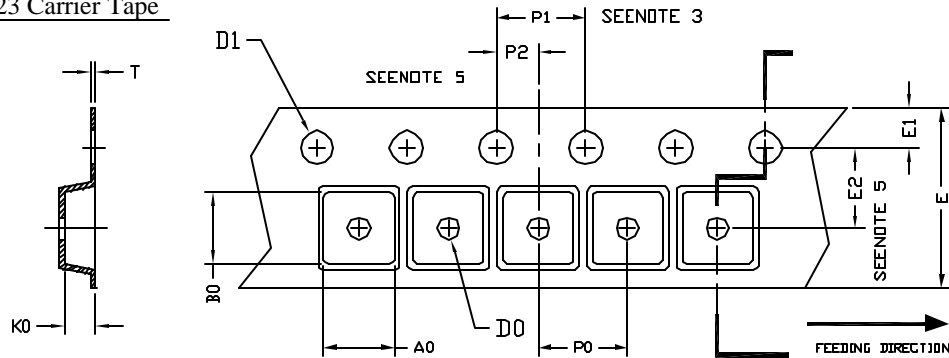

UNIT: MM

PACKAGE	A0	B0	K0	D0	D1	E	E1	E2	P0	P1	P2	T
SOT-23 (8 mm)	3.15 ±0.10	3.20 ±0.10	1.40 ±0.10	1.00 MIN	1.30 +0.10	8.00 ±0.30	1.75 ±0.10	3.50 ±0.05	4.00 ±0.10	4.00 ±0.10	2.00 ±0.05	0.25 ±0.05

SOT-23 Reel

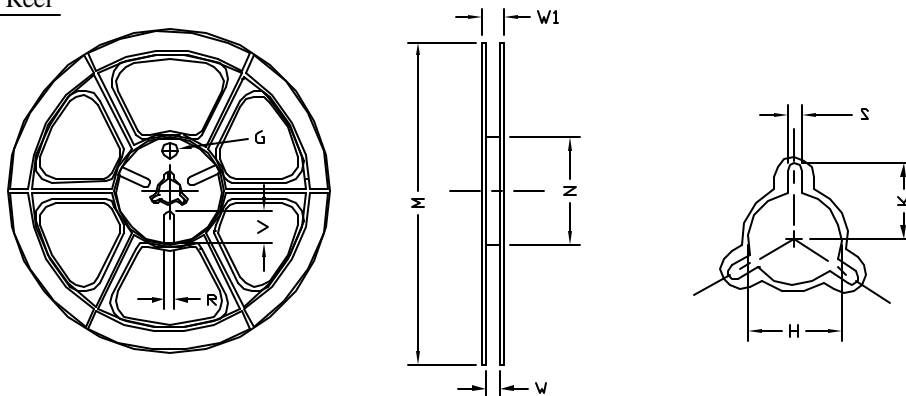

UNIT: MM

TAPE SIZE	REEL SIZE	M	N	W	W1	H	K	S	G	R	V
8 mm	φ180	φ180.00 ±0.50	φ60.50	9.00 ±0.30	11.40 ±1.00	φ13.00 +0.50 -0.20	10.60	2.00 ±0.50	φ9.00	5.00	18.00

SOT-23 Tape

Leader / Trailer
& Orientation

