

Think in a powerful way!



Power Switch

DC/DC Converter

MOSFET

IGBT

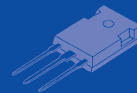
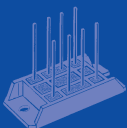
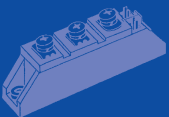
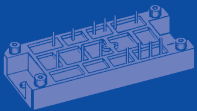
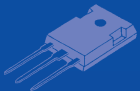
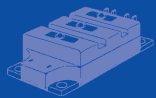
Driver IC

TRIAC / Thyristors

Diodes / Rectifiers

Power Modules

Photocoupler



aimtec

ATMEL

C³
cynergy³ components

Diotec
Semiconductor

EIC

ISOCOM
COMPONENTS

IXYS

NEC

POWER
INTEGRATIONS

RENESAS

SANYO





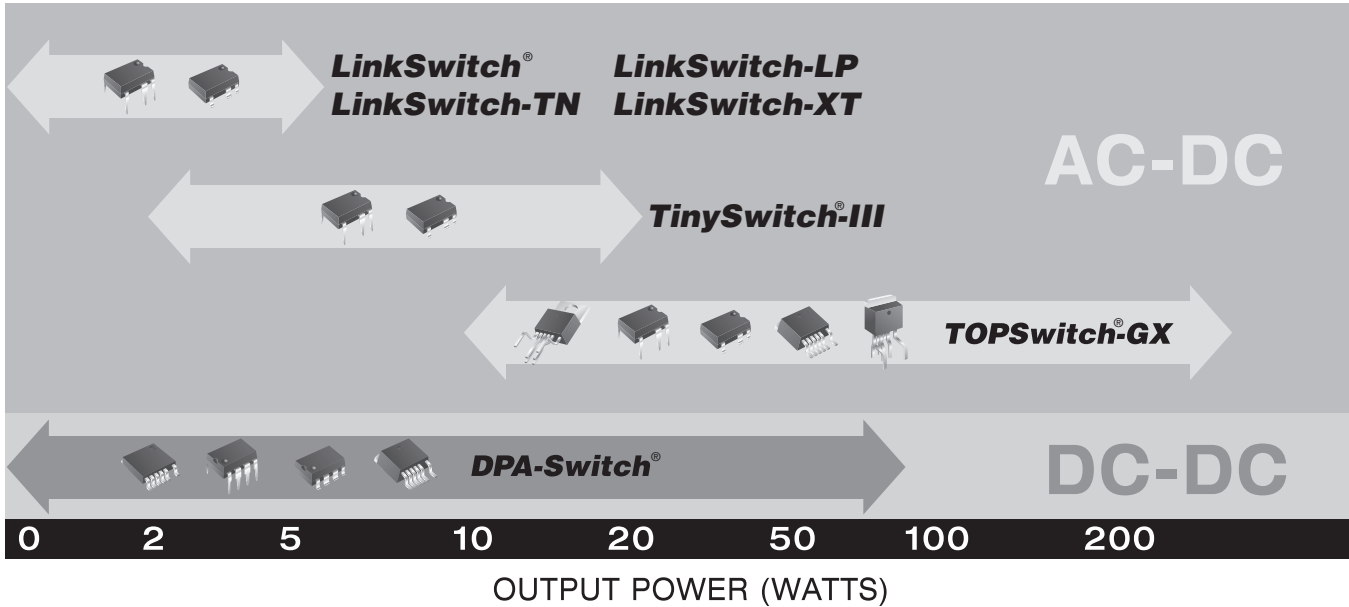
Contents

Page

Power Switch
DC/DC Converter
MOSFET
IGBT
Driver IC
TRIAC/ Thyristors
Diodes / Rectifiers
Power Modules
Photocoupler

- **Power Switch**
 - Product Selector Guide - Power Integrations 1-5
- **DC/DC Converter**
 - 5 Watt, 10 Watt von aimtec 6-9
- **MOSFET**
 - MOSFET N-Channel
 - SOT223, SOT23, SOT89, HWS06, WS06, SO6, SSO8 10
 - SO8, HWSON-8, HSO8, SO16 11
 - TO251 12
 - TO252 13
 - TO262 14
 - TO263, TO263 iso 15-16
 - TO220 17-18
 - TO220 iso 19-20
 - TO247, TO3P, TO247 isoplus 21-24
 - TO3PF, TO247 isoplus 25
 - TO264, TO264 isoplus, TO3PL 26-27
 - TO268 28
 - SOT227B, SOT227iso 29-30
 - SOT23, SOT223, SOT89, SO6, WSO6 31
 - SS08, S08, HSOP8 32
 - TO251, TO252 33
 - TO262, TO263 34
 - TO220 35
 - TO220F (isolated) 36
 - TO3P, TO247, TO3PF (isolated), TO268 37
 - Different versions 38-39
 - DE-Series 40-41
 - MOSFET P-Channel
 - SOT227B, SOT227iso 29-30
 - SOT23, SOT223, SOT89, SO6, WSO6 31
 - SS08, S08, HSOP8 32
 - TO251, TO252 33
 - TO262, TO263 34
 - TO220 35
 - TO220F (isolated) 36
 - TO3P, TO247, TO3PF (isolated), TO268 37
 - Different versions 38-39
 - DE-Series 40-41
 - MOSFET Modules
 - RF Power Mosfet
- **IGBT**
 - Discrete NPT 42
 - BiMosfet, High Voltage, RIGBT 43
 - G-Series 44
 - Power Discretes / G-Series for High Speed, Very High Voltage 45-46
 - S series with SCSOA capability 47
 - IGBT Modules 48-56
- **Driver IC**
 - Motor Driver 57-60
 - Gate Driver 61
 - Half Bridge Driver 62
- **TRIAC / Thyristors**
 - TRIAC (crydom) 63-65
 - DIAC / Thyristor (EIC) 66
 - Thyristors (IXYS) 67
- **Diodes / Rectifier**
 - Schottky 68-73
 - Gallium Arsenide / Silicon Carbide Diodes 74-75
 - Standard 76-78
 - High Speed 79
 - Fast 80-85
 - Super Fast 86-90
 - Sonic 89
 - High Efficient, High Voltage 91-92
 - Automotive 93
 - Single Phase Bridges 94-99
 - Transient Voltage Suppressor (TVS) 100-102
 - TVS Automotive 103
 - Zener Diodes 103-107
 - Breakover Diodes 108
- **Power Modules**
 - MOS / IGBT AC switch, Braking Rectifiers Assemblies 109
 - Modules (Diodes/Diodes, Thyristor/Diodes, Thyristor/Thyristor) 110-116
 - 1~/3~ Phase Rectifier Modules (also for PFC) 117-129
 - AC-Controller-Modules 130-131
- **Power Modules**
 - 132-137
- **Photocoupler**
 - 132-137

Product Selector Guide



Power Switch

I. VERY LOW POWER AC-DC, NON-ISOLATED LINEAR/PASSIVE SUPPLY REPLACEMENT (≤ 360 mA)

Product ^{1,5}	Output Current ⁹		Output Current ⁹		HV-FET Rating	Switching Frequency (kHz)	Control Method	Self-Powered ⁴	Soft-Start (Y=Yes; N.R.=Not Required)	Adjustable Current Limit	Auto Restart	Thermal Shutdown	Frequency Jitter	Power Limiting	Line UV Detection	Line OV Detection	Remote ON/OFF	EcoSmart® Low Standby/No-load Power Consumption	Max. Duty Cycle % (DC _{MAX})	Simultaneous Line Sensing and Current Limit
	MDCM ⁷	CCM ⁸	MDCM ⁷	CCM ⁸																
LinkSwitch-TN	230 VAC \pm 15%		85-265 VAC																	
LNK302 P or G	63 mA	80 mA	63 mA	80 mA	700 V	66	ON/OFF	Y	N.R.			Hys.	Y	Y			Y	Y	69	
LNK304 P or G	120 mA	170 mA	120 mA	170 mA	700 V	66	ON/OFF	Y	N.R.		Y	Hys.	Y	Y			Y	Y	69	
LNK305 P or G	175 mA	280 mA	175 mA	280 mA	700 V	66	ON/OFF	Y	N.R.		Y	Hys.	Y	Y			Y	Y	69	
LNK306 P or G	225 mA	360 mA	225 mA	360 mA	700 V	66	ON/OFF	Y	N.R.		Y	Hys.	Y	Y			Y	Y	69	

II. VERY LOW POWER AC-DC POWER CONVERSION (UP TO 6 W)

Product ^{1,5}	Continuous Output Power		Continuous Output Power		HV-FET Rating	Switching Frequency (kHz)	Control Method	Self-Powered ⁴	Soft-Start (Y=Yes; N.R.=Not Required)	Adjustable Current Limit	Auto Restart	Thermal Shutdown	Frequency Jitter	Power Limiting	Line UV Detection	Line OV Detection	Remote ON/OFF	EcoSmart® Low Standby/No-load Power Consumption	Max. Duty Cycle % (DC _{MAX})	Simultaneous Line Sensing and Current Limit
	Adapter ²	Open Frame ³	Adapter ²	Open Frame ³																
LinkSwitch-LP	230 VAC \pm 15%		85-265 VAC																	
LNK562 P or G	1.9 W	1.9 W	1.9 W	1.9 W	700 V	66	ON/OFF	Y	N.R.		Y	Hys.	Y	Y			Y	Y	66	
LNK563 P or G	2.5 W	2.5 W	2.5 W	2.5 W	700 V	83	ON/OFF	Y	N.R.		Y	Hys.	Y	Y			Y	Y	66	
LNK564 P or G	3 W	3 W	3 W	3 W	700 V	100	ON/OFF	Y	N.R.		Y	Hys.	Y	Y			Y	Y	66	
LinkSwitch	230 VAC \pm 15%		85-265 VAC																	
LNK500 P or G ⁶	4 W		3 W		700 V	42	PWM		Y		Y	Hys.		Y				Y	77	
LNK501 P or G ⁶	4 W		3 W		700 V	42	PWM		Y		Y	Hys.		Y				Y	77	
LNK520 P or G ⁶	4 W		3 W		700 V	42	PWM		Y		Y	Hys.		Y				Y	77	
LinkSwitch-XT	230 VAC \pm 15%		85-265 VAC																	
LNK362 P or G	2.8 W	2.8 W	2.6 W	2.6 W	700 V	132	ON/OFF	Y	N.R.		Y	Hys.	Y	Y			Y	Y	60	
LNK363 P or G	5 W	7.5 W	3.7 W	4.7 W	700 V	132	ON/OFF	Y	N.R.		Y	Hys.	Y	Y			Y	Y	60	
LNK364 P or G	5.5 W	9 W	4 W	6 W	700 V	132	ON/OFF	Y	N.R.		Y	Hys.	Y	Y			Y	Y	60	



Product Selector Guide

III. LOW POWER AC-DC POWER CONVERSION (UP TO 36 W)

Product ^{1,5}	Continuous Output Power		Continuous Output Power		HV-FET Rating	Switching Frequency (kHz)	Control Method	Self-Powered ⁴	Soft-Start (Y=Yes, N.R.=Not Required)	Adjustable Current Limit	Auto Restart	Thermal Shutdown	Frequency Jitter	Power Limiting	Line UV Detection	Line OV Detection	Remote ON/OFF	EcoSmart [®] Low Standby / No-load Power Consumption	Max. Duty Cycle % (DC _{MAX})	Simultaneous Line Sensing and Current Limit
	Adapter ²	Open Frame ³	Adapter ²	Open Frame ³																
TinySwitch-III	230 VAC ± 15%		85-265 VAC																	
TNY274 P or G	5.5 W	9 W	4 W	7.5 W	700 V	132	ON/OFF	Y	N.R.		Y	Hys.	Y	Y	Y		Y	Y	65	
TNY275 P or G	8.5 W	14.5 W	5.5 W	11.5 W	700 V	132	ON/OFF	Y	N.R.		Y	Hys.	Y	Y	Y		Y	Y	65	
TNY276 P or G	10 W	19 W	6 W	15 W	700 V	132	ON/OFF	Y	N.R.		Y	Hys.	Y	Y	Y		Y	Y	65	
TNY277 P or G	13 W	23 W	8 W	18 W	700 V	132	ON/OFF	Y	N.R.		Y	Hys.	Y	Y	Y		Y	Y	65	
TNY278 P or G	16 W	27.5 W	10 W	21.5 W	700 V	132	ON/OFF	Y	N.R.		Y	Hys.	Y	Y	Y		Y	Y	65	
TNY279 P or G	18 W	31.5 W	12 W	25 W	700 V	132	ON/OFF	Y	N.R.		Y	Hys.	Y	Y	Y		Y	Y	65	
TNY280 P or G	20 W	36 W	14 W	28 W	700 V	132	ON/OFF	Y	N.R.		Y	Hys.	Y	Y	Y		Y	Y	65	

IV. HIGH POWER AC-DC POWER CONVERSION (UP TO 290 W)

Product ^{1,5}	Continuous Output Power		Continuous Output Power		HV-FET Rating	Switching Frequency (kHz)	Control Method	Self-Powered ⁴	Soft-Start (Y=Yes, N.R.=Not Required)	Adjustable Current Limit	Auto Restart	Thermal Shutdown	Frequency Jitter	Power Limiting	Line UV Detection	Line OV Detection	Remote ON/OFF	EcoSmart [®] Low Standby / No-load Power Consumption	Max. Duty Cycle % (DC _{MAX})	Simultaneous Line Sensing and Current Limit
	Adapter ²	Open Frame ³	Adapter ²	Open Frame ³																
TOPSwitch-GX	230 VAC ± 15%		85-265 VAC																	
TOP242 P or G	9 W	15 W	6.5 W	10 W	700 V	132	PWM		Y	Y	Y	Hys.	Y	Y	Y	Y	Y	Y	78	
TOP242 R	21 W	22 W	11 W	14 W	700 V	132/66	PWM		Y	Y	Y	Hys.	Y	Y	Y	Y	Y	Y	78	Y
TOP242 Y or F	10 W	22 W	7 W	14 W	700 V	132/66	PWM		Y	Y	Y	Hys.	Y	Y	Y	Y	Y	Y	78	Y
TOP243 P or G	13 W	25 W	9 W	15 W	700 V	132	PWM		Y	Y	Y	Hys.	Y	Y	Y	Y	Y	Y	78	
TOP243 R	29 W	45 W	17 W	23 W	700 V	132/66	PWM		Y	Y	Y	Hys.	Y	Y	Y	Y	Y	Y	78	Y
TOP243 Y or F	20 W	45 W	15 W	30 W	700 V	132/66	PWM		Y	Y	Y	Hys.	Y	Y	Y	Y	Y	Y	78	Y
TOP244 P or G	16 W	28 W	11 W	20 W	700 V	132	PWM		Y	Y	Y	Hys.	Y	Y	Y	Y	Y	Y	78	
TOP244 R	34 W	50 W	20 W	28 W	700 V	132/66	PWM		Y	Y	Y	Hys.	Y	Y	Y	Y	Y	Y	78	Y
TOP244 Y or F	30 W	65 W	20 W	45 W	700 V	132/66	PWM		Y	Y	Y	Hys.	Y	Y	Y	Y	Y	Y	78	Y
TOP245 P or G	19 W	30 W	13 W	22 W	700 V	132	PWM		Y	Y	Y	Hys.	Y	Y	Y	Y	Y	Y	78	
TOP245 R	37 W	57 W	23 W	33 W	700 V	132/66	PWM		Y	Y	Y	Hys.	Y	Y	Y	Y	Y	Y	78	Y
TOP245 Y or F	40 W	85 W	26 W	60 W	700 V	132/66	PWM		Y	Y	Y	Hys.	Y	Y	Y	Y	Y	Y	78	Y
TOP246 P or G	21 W	34 W	15 W	26 W	700 V	132	PWM		Y	Y	Y	Hys.	Y	Y	Y	Y	Y	Y	78	
TOP246 R	40 W	64 W	26 W	38 W	700 V	132/66	PWM		Y	Y	Y	Hys.	Y	Y	Y	Y	Y	Y	78	Y
TOP246 Y or F	60 W	125 W	40 W	90 W	700 V	132/66	PWM		Y	Y	Y	Hys.	Y	Y	Y	Y	Y	Y	78	Y
TOP247 R	42 W	70 W	28 W	43 W	700 V	132/66	PWM		Y	Y	Y	Hys.	Y	Y	Y	Y	Y	Y	78	Y
TOP247 Y or F	85 W	165 W	55 W	125 W	700 V	132/66	PWM		Y	Y	Y	Hys.	Y	Y	Y	Y	Y	Y	78	Y
TOP248 R	43 W	75 W	30 W	48 W	700 V	132/66	PWM		Y	Y	Y	Hys.	Y	Y	Y	Y	Y	Y	78	Y
TOP248 Y or F	105 W	205 W	70 W	155 W	700 V	132/66	PWM		Y	Y	Y	Hys.	Y	Y	Y	Y	Y	Y	78	Y
TOP249 R	44 W	79 W	31 W	53 W	700 V	132/66	PWM		Y	Y	Y	Hys.	Y	Y	Y	Y	Y	Y	78	Y
TOP249 Y or F	120 W	250 W	80 W	180 W	700 V	132/66	PWM		Y	Y	Y	Hys.	Y	Y	Y	Y	Y	Y	78	Y
TOP250 R	45 W	82 W	32 W	55 W	700 V	132/66	PWM		Y	Y	Y	Hys.	Y	Y	Y	Y	Y	Y	78	Y
TOP250 Y or F	135 W	290 W	90 W	210 W	700 V	132/66	PWM		Y	Y	Y	Hys.	Y	Y	Y	Y	Y	Y	78	Y

Notes:

1. Packages: P-Plastic DIP, G-Surface Mount DIP, Y-TO-220, R-TO-263, F-TO-262. Lead-free package options are available for P, G, Y, & F packages. Consult data sheet for product ordering information. 2. Minimum continuous power in a typical non-ventilated encased adapter with minimal heat sinking, measured at a device ambient of 50 °C. 3. Minimum continuous power in an open frame with adequate heat sinking. 4. No bias winding needed for LNK500, LNK501 and LNK362-364. 5. Shipping quantities per package: Tubes: F and Y- 50 pc., P and G - 50 pc. Tape and reel: G-TL- 1000 pc., R-TL- 750 pc. R-package is available in tape and reel only. 6. Typical power ratings shown for CV/CC charger applications. LNK501 provides tighter output CC tolerances. LNK520 is optimized for EMI reduction. See data sheets for full specifications. 7. Mostly discontinuous conduction mode. 8. Continuous conduction mode. 9. Typical output current in a non-isolated buck converter.

Product Selector Guide

V. 24 V / 48 V DC-DC Power Conversion (Up to 100 W)

Product ^{1,2}	Device Total Power Dissipation ³					Max Output Power	HV-FET Rating	Switching Frequency (kHz)	Synchronizable to Lower External Clock Frequency	Control Method	Soft-Start (Y=Yes; N/R=Not Required)	Fully Integrated Current Sensing	Adjustable Current Limit	Auto Restart	Thermal Shutdown	Power Limiting	Line UV Detection	Line OV Detection	Remote ON/OFF	EcoSmart [®] Low Standby/No-load Power Consumption	Max. Duty Cycle % (DC _{max})	Simultaneous Line Sensing and Current Limit
	0.5 Watts	1 Watt	2.5 Watts	4 Watts	6 Watts																	
DPA-Switch	36-75 VDC INPUT^{4,5}																					
DPA423 P or G	12 W	16 W	-	-	-	18 W	220 V	400/300	Y	PWM	Y	Y	Y	Y	Hys.	Y	Y	Y	Y	Y	75	Y
DPA423 R or S	12 W	16 W	-	-	-	18 W	220 V	400/300	Y	PWM	Y	Y	Y	Y	Hys.	Y	Y	Y	Y	Y	75	Y
DPA424 P or G	16 W	23 W	-	-	-	35 W	220 V	400/300	Y	PWM	Y	Y	Y	Y	Hys.	Y	Y	Y	Y	Y	75	Y
DPA424 R or S	16 W	23 W	35 W	-	-	35 W	220 V	400/300	Y	PWM	Y	Y	Y	Y	Hys.	Y	Y	Y	Y	Y	75	Y
DPA425 P or G	23 W	32 W	-	-	-	70 W	220 V	400/300	Y	PWM	Y	Y	Y	Y	Hys.	Y	Y	Y	Y	Y	75	Y
DPA425 R or S	23 W	32 W	50 W	62 W	-	70 W	220 V	400/300	Y	PWM	Y	Y	Y	Y	Hys.	Y	Y	Y	Y	Y	75	Y
DPA426 R or S	25 W	35 W	55 W	70 W	83 W	100 W	220 V	400/300	Y	PWM	Y	Y	Y	Y	Hys.	Y	Y	Y	Y	Y	75	Y

Notes:
1. Packages: P-Plastic DIP, G-Surface Mount DIP, R-TO-263, S-MO-169. Lead-free package options are available for P, G, & S packages. Consult data sheet for product ordering information. **2.** Shipping quantities per package: Tubes: P and G - 50 pc. Tape and reel: G-TL- 1000 pc., R-TL- 750 pc., S-TL- 1000 pc. R-package and S-package are available in tape and reel only. **3.** For example, in a 55 W output design, the DPA426R will dissipate a worst case total of 2.5 W. **4.** See data sheet for power capability at 16 VDC and 24 VDC input. **5.** Power based on forward converter configuration with diode rectification assuming worst case $R_{DS(ON)}$ @ $T_J=100$ °C. Up to 5% higher output power possible using synchronous rectification.

Design Tools

PI FACTS™ (Fast Application Customer Technical Support)

Within seconds, this new design collateral search tool displays the most relevant product information and reference designs to meet your application requirements.

■ To try it out, go to www.powerint.com/facts.



- 1 Enter your application specs
- 2 Run the PI FACTS search
- 3 Get the information you need!

PI Expert™ Suite Including PI Transformer Designer

PI Expert is a powerful software program that takes a designer's switching power supply requirements and determines the critical components needed to generate a working switch mode power supply. Auto design or manual control options. Design can be optimized for efficiency or cost.

■ To download or request a CD, go to www.powerint.com/designsoftware.htm.



Ask a PI Engineer

Submit your technical questions using our online technical support request form at www.powerint.com/techsupport.htm. Tell us about your power supply application and problem. A PI applications engineer will respond with answers.



Total Product Support

- Application Notes
- Design Ideas
- Engineering Prototype Reports
- EcoSmart Enabled Energy Efficiency Solutions Brochure
- Data Book & Design Guide
- Data Sheets
- Design Example Reports



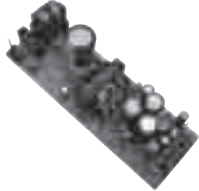
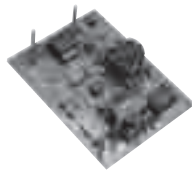




Reference Designs

Reference Designs (DAK) provide all of the essential materials to get you started on your next switch mode power supply design. The kits include a fully assembled and tested prototype power supply board, comprehensive engineering report, product samples, unpopulated circuit board, data sheet and other related documentation. DAKs are available through your local sales representative, distributor or from the Power Integrations website.



■ For additional reference designs and design examples, visit www.powerint.com/designsupport.htm.

3 W, 9 V AC-DC Power Supply		DAK-14A	\$19.95
	Board Specifications	Samples	
	V_{IN} 85-265 VAC	TNY263P, 264P, 265P, 266P, 267P, 268P	
	V_{OUT} 9 V @ 0.33 A	& Unpopulated PCB	
	P_{OUT} 3 W		
2.75 W, 5.5 V AC-DC Power Supply		DAK-16A	\$19.95
	Board Specifications	Samples	
	V_{IN} 85-265 VAC	LNK501P, LNK500P & Unpopulated PCB	
	V_{OUT} 5.5 V @ 0.5 A		
	P_{OUT} 2.75 W		
10 W, Multi-Output AC-DC Power Supply		DAK-18	\$24.95
	Board Specifications	Samples	
	V_{IN} 85-265 VAC	TOP243P & Unpopulated PCB	
	V_{OUT} 3.3 V @ 1.5 A, 5 V @ 0.9 A		
	30 V @ 0.03A		
	P_{OUT} 3 W		
30 W, 5 V DC-DC Power Supply		DAK-21A	\$49.95
	Board Specifications	Samples	
	V_{IN} 36-72 VDC	DPA423-426R & Unpopulated PCB	
	V_{OUT} 5 V @ 6 A		
	P_{OUT} 30 W		
20 W Multi-Output AC-DC Power Supply		DAK-32	\$45.95
	Board Specifications	Samples	
	V_{IN} 85-265 VAC	TOP245P & Unpopulated PCB	
	V_{OUT} 3.3 V @ 0.6 A, 5 V @ 1.2 A,		
	12 V @ 0.2 A, -24 V @ 50 mA		
	P_{OUT} 20 W (cont.), 25 W (peak)		
45 W, 12 V AC-DC LCD Monitor External Power Supply		DAK-33	\$45.95
	Board Specifications (EP-14)	Samples	
	V_{IN} 90-265 VAC	TOP247Y & Unpopulated PCB	
	V_{OUT} 12 V @ 3.75 W		
	P_{OUT} 45 W		

Power Switch

30 W, 12 V AC-DC Power Supply **DAK-34** **\$31.95**



Board Specifications

V_{IN} 85-265 VAC
 V_{OUT} 12 V @ 2.5 A
 P_{OUT} 30 W

Samples

TOP245Y & Unpopulated PCB

1.44 W, 12 V Non-Isolated Appliance Power Supply **DAK-48A** **\$19.95**



Board Specifications

V_{IN} 85-265 VAC
 V_{OUT} 12 V @ 120 mA
 P_{OUT} 1.44 W

Samples

LNK302P/G, 304P/G, 305P/G, 306P/G & Unpopulated PCB

2.75 W, 5.5 V Low Cost Charger / Adapter **DAK-54** **\$19.95**



Board Specifications

V_{IN} 85-265 VAC
 V_{OUT} 5.5 V @ 500 mA
 P_{OUT} 2.75 W

Samples

LNK520P & Unpopulated PCB

6.6 W, 3.3 V DC-DC Supply For DPA With PoE Front End **DAK-68A** **\$29.95**



Board Specifications

V_{IN} 36-72 VDC
 V_{OUT} 3.3 V @ 2 A
 P_{OUT} 6.6 W

Samples

DPA423G & Unpopulated PCB

6.6 W, 3.3 V DC-DC Standby Supply For Distributed Power (or DPA) **DAK-71A** **\$29.95**



Board Specifications

V_{IN} 36-72 VDC
 V_{OUT} 3.3 V @ 2 A
 P_{OUT} 6.6 W

Samples

DPA423G & Unpopulated PCB

2.28 W, 5.7 V Low Cost CV/CC Charger/Adapter **DAK-73** **\$19.95**



Board Specifications

V_{IN} 85-265 VAC
 V_{OUT} 5.7 V @ 400 mA
 P_{OUT} 2.28 W

Samples

LNK354P & Unpopulated PCB

2 W, 6 V CV/CC Charger: Unregulated Linear Replacement **DAK-85** **\$19.95**



Board Specifications

V_{IN} 90-265 VAC
 V_{OUT} 6 V @ 330 mA
 P_{OUT} 2 W

Samples

LNK562P/G, 563P/G, 564P/G & Unpopulated PCB

2 W, 6.2 V AC-DC CV Adapter **DAK-89** **\$19.95**



Board Specifications

V_{IN} 85-265 VAC
 V_{OUT} 6.2 V @ 322 mA
 P_{OUT} 2 W

Samples

LNK362P/G, 363P/G, 364P/G & Unpopulated PCB



AC / DC Converter

SERIES	POWER watts	OUTPUT				INPUT VOLTAGE V DC		DIMENSIONS
		Single	Dual	Dual sep.	Triple	AC	DC	
AME05	5	•	•			•	•	2.00x1.00x0.60inch
AMEL05	5	•				•	•	2.00x1.77x0.81inch ←
AME10	10	•	•			•	•	.52x1.77x0.81inch
AMEL10	10	•				•	•	2.05x1.06x0.91inch ←
AME15	15	•	•		•	•	•	2.91x2.13x0.87inch
AME30	30	•	•		•	•	•	3.50x2.50x0.98inch

DC / DC Converter

SERIES	POWER watts	ISOLATION kV DC						OUTPUT	INPUT VOLTAGE V DC				PACKAGE TYPE
		1	1.5	3	3.5	4	5.2		6	5	12	24	
AM1S	1	•	•					•/•/•/•	•	•	•		SIP4
AM1S-N	1	•						•/•/•/•	•	•	•		SIP4
AM1P	1	•	•					•/•/•/•	•	•	•		DIP8
AM1P-N	1	•						•/•/•/•	•	•	•		DIP8
AM1D	1	•	•	•	•			•/•/•/•	•	•	•		SIP7
AM1D-N	1	•	•					•/•/•/•	•	•	•		SIP7
AM1DR	1	•	•					•/•/•/•	•	•	•		SIP7
AM1DR-N	1	•						•/•/•/•	•	•	•		SIP7
AM1L-N	1	•						•/•/•/•	•	•			SMD
AM1N-N	1					•		•/•/•/•	•	•			DIP24
AM2S	2	•	•					•/•/•/•	•	•	•		SIP4
AM2D	2	•	•	•	•			•/•/•/•	•	•	•		SIP7
AM2D-N	2	•						•/•/•/•	•	•	•		SIP7
AM2F	2	•	•		•			•/•/•/•	•	•	•		SIP12
AM2N-N	2	•				•		•/•/•/•	•	•	•		DIP24
AM3F	3	•	•		•			•/•/•/•	•	•	•		SIP12
AM3N	3	•	•		•			•/•/•/•	•	•	•		DIP24
AM3T	3	•	•					•/•/•/•	2:1	2:1	2:1		DIP24
AM3TW	3	•	•					•/•/•/•		4:1	4:1		DIP24
AM4T	4	•	•					•/•/•/•	2:1	2:1	2:1		DIP24
AM4TW	4	•	•					•/•/•/•		4:1	4:1		DIP24
AM5T	5	•	•					•/•/•/•	2:1	2:1	2:1		DIP24
AM5TW	5	•	•					•/•/•/•		4:1	4:1		DIP24
AM6T	6	•	•					•/•/•/•	2:1	2:1	2:1		DIP24
AM6TW	6	•	•					•/•/•/•		4:1	4:1		DIP24
AM8T-C	8	•						•/•/•/•	2:1	2:1	2:1		DIP24
AM10E-C	10	•						•/•/•/•	2:1	2:1	2:1	2.0x1.0x0.41inch	
AM15E-C	15	•						•/•/•/•	2:1	2:1	2:1	2.0x1.0x0.41inch	
AM20E-C	20	•						•/•/•/•	2:1	2:1	2:1	2.0x1.0x0.41inch	
AM20U-C	20	•						•/•/•/•	2:1	2:1	2:1	2.0x2.0x0.42inch	
AM30K-C	30	•						•/•/•/•		2:1	2.0x1.6x0.42inch		
AM40K-C	40	•						•/•/•/•		2:1	2.0x2.0x0.42inch		
AM40U-C	40	•						•/•/•/•		2:1	2.0x2.0x0.42inch		

DC/DC Converter

Model No.	AMEL05-3.3S	AMEL05-5S	AMEL05-12S	AMEL05-15S	AMEL05-24S	
Max output wattage (W)	4W	5W	5W	5W	5.5W	
Input	Voltage	90...260VAC or 120...370VDC				
	Frequency (Hz)	47...440Hz				
	Current (Full load)	110mA max. (115VAC) / 70mA max. (230VAC)				
	Inrush current (<2ms)	10A max. (115VAC) / 20A max. (230VAC)				
	Leakage Current	0.75mA max.				
	External fuse (recommend)	1.5A slow blow type				
	Output	Voltage (VDC)	3.3V	5V	12V	15V
Voltage accuracy		±2%				
Current (mA) max.		1250	1000	420	333	230
Line regulation (max.)		±0.3%				
Load regulation (5-100%) (max.)		±0.5%				
Minimum load		0%				
Maximum capacitive load		470...23,000µF depending on model				
Ripple & Noise		<0.5% Vout + 50mV max (Vp-p)				
Efficiency		65%	73%	75%	77%	78%
Hold-up time		15ms min.				
Switching frequency		125kHz				
Protection		Over current protection	Hiccup technique, auto-recovery			
	Over voltage protection	Zener diode clamp				
	Short circuit protection	Hiccup mode, indefinite (automatic recovery)				
Isolation	Input-Output (VAC)	3000V				
Environment	Operating temperature	-25°C...+71°C				
	Storage temperature	-40°C...+85°C				
	Temperature coefficient	0.02%/°C				
	Humidity	95% RH				
	MTBF	>340,000 h @ 25°C (MIL-HDBK-217F)				
Physical	Dimension (L x W x H)	2.0 x 1.0 x 0.597 Inches (50.8 x 25.4 x 15.16 mm)				
	Case Material	Plastic resin + Fiberglass (flammability to UL 94V-0)				
	Weight	30g				
	Cooling method	Free air convection				
Safety	Agency approvals	CE, cUL				
EMC	EMI (Conducted Emission)	EN 55022				
	EMS (Radiated Emission)	EN 55022				



AC / DC Converter - 10 Watt



Model No.	AMEL10-3.3S	AMEL10-5S	AMEL10-12S	AMEL10-15S	AMEL10-24S	
Max output wattage (W)	10W	10W	10W	10W	10W	
Input	Voltage	90...260VAC				
	Frequency (Hz)	47...440Hz				
	Current (Full load)	220mA max. (115VAC) / 150mA max. (230VAC)				
	Current (No load)	12mA max. 0.6W (115VAC) / 14mA max. 0.9W (230VAC)				
	Inrush current (<2ms)	10A max. (115VAC) / 20A max. (230VAC)				
	External fuse (recommend)	1.5A slow blow type				
Output	Voltage (VDC)	3.3V	5V	12V	15V	24V
	Voltage accuracy	±2%				
	Current (mA) max.	2500	2000	833	667	417
	Line regulation (typ.)	±0.3%				
	Load regulation (5-100%) (typ.)	±0.5%				
	Minimum load	0%				
	Maximum capacitive load	470...23,000µF depending on model				
	Ripple	0.2% Vout + 40mV (max.)				
	Noise	0.5% Vout + 50mV (max.)				
	Efficiency	70%	72%	79%	79%	79%
	Hold-up time	15ms min.				
	Switching frequency	125kHz				
	Protection	Over current protection	Foldback technique, auto-recovery			
Over voltage protection		Zener diode clamp				
Short circuit protection		Hiccup mode, indefinite (automatic recovery)				
Isolation	Input-Output (VAC)	3000V				
Environment	Operating temperature	-25°C...+71°C				
	Storage temperature	-40°C...+85°C				
	Temperature coefficient	0.02%/°C				
	Humidity	20...85% RH				
	MTBF	>310,000 h @ 25°C (MIL-HDBK-217F)				
Physical	Dimension (L x W x H)	2.05 x 1.06 x 0.91Inches (52 x 27 x 23mm)				
	Case Material	Plastic resin + Fiberglass (flammability to UL 94V-0)				
	Weight	54g				
	Cooling method	Free air convection				
General	Vibration	10...55Hz 0.5mm width / 1 minute cycle				
	Shock	20G (3 directions each 3 times)				
Safety	Agency approvals	CE, cUL				
EMC	EMI (Conducted & Radiated Emission)	EN 55022 class B				
	EMS (Noise Immunity)	EN 55024				

SERIES AMEL05. 5 Watt AC-DC CONVERTERS

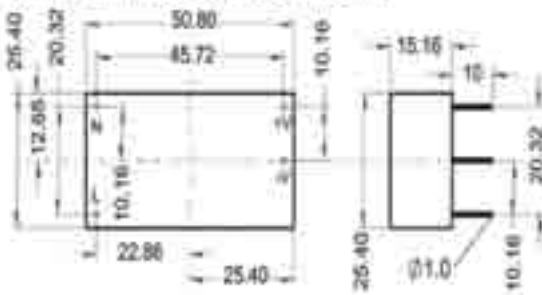


Features

- Switching Power Modules for PCB Mounting
- Low Standby Power
- Fully Encapsulated Plastic Case
- Universal Input Range 90...260VAC, 47...440Hz
- Regulated Output
- Low Ripple and Noise
- High Efficiency
- CE, cUL Approvals
- 2-Year Product Warranty



Outline Dimensions & PIN Connections



SERIES AMEL10. 10 Watt AC-DC CONVERTERS

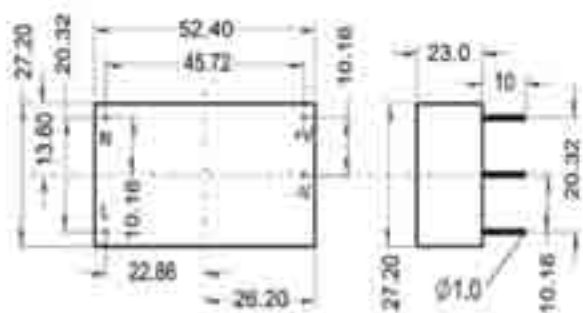


Features

- Switching Power Modules for PCB Mounting
- Fully Encapsulated Plastic Case
- Universal Input Range 90...260VAC, 47...440Hz
- Regulated Output
- Low Ripple and Noise
- High Efficiency
- CE, cUL Approvals
- 2-Year Product Warranty



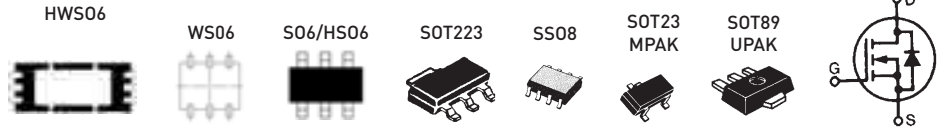
Outline Dimensions & PIN Connections



PIN#	SINGLE
N	AC IN
L	AC IN
+V	+DC OUT
-V	-DC OUT



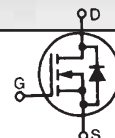
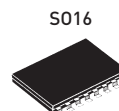
MOSFET N-Channel



Device	V _{DSS} V	I _D A	R _{DS(on)} Ω max V _{GS} =10V	C _{iss} pF/nc	Q _g nC	t _{rr} ns	Package	Manufacturer
2SK2053	16	5	0,120				SOT223	NEC
2SK2157	30	5	0,100				SOT223	NEC
2SK2054	60	3	0,200				SOT223	NEC
2SK2055	100	2	0,350				SOT223	NEC
3LN01C	30	0,15	3,700		1,58		SOT23	SANYO
3LN02C	30	0,3	1,200		2,34		SOT23	SANYO
2SK2980	30	1	0,280	155			SOT23	Renesas
2SK3000	40	1	0,300	14			SOT23	Renesas
5HN01C	50	0,1	7,500		1,4		SOT23	SANYO
5LN01C	50	0,1	7,800		1,57		SOT23	SANYO
2SK2569	50	0,2	0,500	14			SOT23	Renesas
5HN02C	50	0,2	2,300		1,86		SOT23	SANYO
5LN02C	50	0,2	2,400		2,18		SOT23	SANYO
2SK1587	16	2	0,500				SOT89	NEC
2SK1960	16	3	0,200				SOT89	NEC
2SK1586	30	1	0,600				SOT89	NEC
2SK1483	30	2	0,400				SOT89	NEC
2SK2109	60	0,5	0,800				SOT89	NEC
2SK2111	60	1	0,450				SOT89	NEC
2SK2788	60	2	0,160	180			SOT89	Renesas
2SK1273	60	2	0,650				SOT89	NEC
2SK2159	60	2	0,300				SOT89	NEC
2SK2857	60	4	0,150				SOT89	NEC
2SK2110	100	0,5	1,200				SOT89	NEC
2SK1593	100	0,5	5,000				SOT89	NEC
2SK2112	100	1	0,800				SOT89	NEC
μPA1970TE	20/20	2,2/2,2	2 x 0,069				SO6	NEC
μPA1901TE	30	6,5	0,039				SO6	NEC
μPA1902TE	30	7	22,000				SO6	NEC
UPA620TT	20	5	0,038				WSO6	NEC
UPA621TT	20	5	0,050				WSO6	NEC
UPA622TT	30	3	0,082				WSO6	NEC
μPA2450TL	20/20	8,6/8,6	2 x 0,0175				HWSO6	NEC
μPA2452TL	24/24	7,8/7,8	2 x 0,0215				HWSO6	NEC
μPA2451TL	30/30	8,2/8,2	2 x 0,020				HWSO6	NEC
μPA1873GR-9JG	20/20	6,0/6,0	2 x 0,023				SSO8	NEC
μPA1870GR-9JG	20/20	6,0/6,0	2 x 0,02				SSO8	NEC
μPA1872GR-9JG	20/20	10,0/10	2 x 0,013				SSO8	NEC
μPA1820GR-9JG	20/20	12/12,0	2 x 0,0086				SSO8	NEC
μPA1871GR-9JG	30/30	6,0/6,0	2 x 0,026				SSO8	NEC
μPA1874GR-9JG	30/30	8,0/8	2 x 0,014				SSO8	NEC
UPA1890G	30/-30	6/-5	0,038/0,059				SSO8	NEC
HAT3015T	200/-200	0,5/-0,25	2,2/6,2	120/140			SSO8	Renesas
FTS2011	20	8	0,017				SSO8	SANYO
HAT2052T	28	5	0,034	510			SSO8	Renesas
FTS2004	30	4	0,046				SSO8	SANYO
FTS2051	30	4,5	0,042				SSO8	SANYO
FTS2028	30	6	0,032				SSO8	SANYO
FTS2022	30	7	0,025				SSO8	SANYO
μPA1809GR-9JG	30	8	0,021				SSO8	NEC
μPA1803GR-9JG	30	8	0,012				SSO8	NEC
μPA1809GR-9JG	30	8	0,021				SSO8	NEC
μPA1804GR-9JG	30	8	0,023				SSO8	NEC
μPA1808GR-9JG	30	9,5	0,017				SSO8	NEC
μPA1807GR-9JG	30	12	0,010				SSO8	NEC
μPA1806GR-9JG	30	13	0,009				SSO8	NEC
FTS2052	60	2,5	0,145				SSO8	SANYO
UPA1857GR-9JG	60	3,8	0,067				SSO8	NEC
FTS2053	100	2	0,310				SSO8	SANYO
FTS2005	100	2	0,260				SSO8	SANYO
UPA1840GR-9JG	200	2,2	0,500				SSO8	NEC

All MOSFETs up to 100 V are available in logic level, partly down to 2,5 V

MOSFET N-Channel



Device	V _{DSS} V	I _D A	R _{DS(on)} Ω max V _{GS} =10V	C _{iss} pF/nc	Q _q nC	t _{rr} ns	Package	Manufacturer
μPA1725G	20	7	0,021				SO8	NEC
HAT2027R	20	7	0,053	720			SO8	Renesas
μPA1724G	20	10	0,011				SO8	NEC
HAT2026R	20	11	0,021	1760			SO8	Renesas
μPA1726G	20	12	0,0091				SO8	NEC
μPA1723G	20	13	0,007				SO8	NEC
HAT2029R	28	7,5	0,033	780			SO8	Renesas
HAT2024R	30	2,5	0,065	310			SO8	Renesas
HAT2016R	30	6,5	0,045				SO8	Renesas
FSS250	30	7					SO8	SANYO
μPA1720G	30	8	0,025				SO8	NEC
HAT2025R	30	8	0,026	660			SO8	Renesas
μPA2752G	30	8	0,032				SO8	NEC
FSS242	30	8					SO8	SANYO
FSS232	30	9					SO8	SANYO
μPA1721G	30	10	0,105				SO8	NEC
FSS244	30	10					SO8	SANYO
FSS262	30	10					SO8	SANYO
HAT2092R	30	11	0,016	1400			SO8	Renesas
μPA2706GR	30	11	0,15				SO8	NEC
FSS234	30	12					SO8	SANYO
μPA1706GR	30	13	0,0078				SO8	NEC
μPA2502TM	30	13	12				HWSON-8	NEC
μPA2701GR	30	14	0,0075				SO8	NEC
μPA2503TM	30	16	9,5				HWSON-8	NEC
HAF2015R *	60	2	0,1600				SO8	Renesas
HAT2038R	60	5	0,058	520			SO8	Renesas
μPA1728G	60	9	0,026				SO8	NEC
μPA1727G	60	10	0,019				SO8	NEC
μPA1743TP	250	8	0,45				HSO8	NEC
μPA2754G	30/30	11,0/11,0	2 x 0,0145				SO8	NEC
μPA2750G	30/30	9,0/9,0	2 x 0,0155				SO8	NEC
HAT3004R	30/-30	5/-3.5	0.065/0.16	310/550			SO8	Renesas
μPA1792G	30/-30	6,8/5,8	0,025/0,04				SO8	NEC
HAT3006R	30/-30	6.5/-4.5	0.045/0.09	550/650			SO8	Renesas
μPA1763G	60/60	4,5/4,5	2 x 0,048				SO8	NEC
μPA1759G	60/60	5,0/5,0	2 x 0,150				SO8	NEC
μPA1764G	60/60	7,0/7,0	2 x 0,035				SO8	NEC
HAT3008R	60/-60	5/-3.5	0.058/0.15	520/600			SO8	Renesas
HAT3010R	60/-60	5/-3.5	0.03/0.052	1050/1350			SO8	Renesas
HAT3018RJ	60/-60	6/-5	0.032/0,076	1050/1350			SO8	Renesas
HAT3019R	100/-100	3.5/-2.3	0.115/0.30				SO8	Renesas
IXTS01N100X2	1000	0,1	2 x 80	80			SO16	IXYS
IXTS01N100X3	1000	0,1	3 x 80	80			SO16	IXYS

MOSFET



MOSFET N-Channel

T0251
IPAK



MOSFET

Device	V _{DSS} V	I _D A	R _{DS(on)} Ω max V _{GS} =10V	C _{iss} pF/nc	Q _g nC	trr ns	Package	Manufacturer
2SK3918	25	48	0,0075				TO251	NEC
2SK3919	25	64	0,0056				TO251	NEC
2SK3507	30	22,0	0,0450				TO251	NEC
2SK3365	30	30,0	0,0140				TO251	NEC
NP34N03HLD	30	34,0	0,0125				TO251	NEC
NP22N055HLE/HHE	55	22,0	0,0470				TO251	NEC
NP32N055HLE/HHE	55	32,0	0,0240				TO251	NEC
NP34N055HLE/HHE	55	34,0	0,0200				TO251	NEC
NP36N055HLE/HHE	55	36,0	0,0130	2900			TO251	NEC
HAF2007L	60	5,0	0,0750				TO251	Renesas
2SK3377	60	20,0	0,0440				TO251	NEC
2SK3385	60	30,0	0,0280				TO251	NEC
H7N0603DL	60	30,0	0,0150	3200			TO251	Renesas
2SK3402	60	36,0	0,0150				TO251	NEC
HAF2011	60	40,0	0,0200				TO251	Renesas
2SK1284	100	3,0	0,3200				TO251	NEC
2SK3147	100	5,0	0,1300	420			TO251	Renesas
2SK3484	100	16,0	0,1250				TO251	NEC
2SK3483	100	28,0	0,0520				TO251	NEC
2SK3482	100	36,0	0,0330				TO251	NEC
2SK1254L	120	3,0	0,4000	420			TO251	Renesas
FQU5N20	200	3,8	1,2000		6		TO251	FAIRCHILD
FQU7N20	200	5,3	0,6900		9		TO251	FAIRCHILD
H5N2005DL	200	6,0	0,6500	300			TO251	Renesas
2SK3634	200	6,0	0,6000				TO251	NEC
FQU10N20	200	7,6	0,3600	13			TO251	FAIRCHILD
H5N2004DL	200	8,0	0,4800	450			TO251	Renesas
2SK3635	200	8,0	0,4300				TO251	NEC
FQU4N25	250	2,2	2,0000				TO251	FAIRCHILD
H5N2505DL	250	5,0	0,8900				TO251	Renesas
H5N2504DL	250	7,0	0,6300	540			TO251	Renesas
H5N2508DL	250	7,0	0,6300	450			TO251	Renesas
H5N2510DL	250	10,0	0,8900	390			TO251	Renesas
FQU1N50	500	1,1	9,0000	—			TO251	FAIRCHILD
2SK1152L	500	1,5	6,0000	260			TO251	Renesas
H5N2510DL	500	3,0	3,0000				TO251	Renesas
FQU5N50	500	3,5	1,3600	8,5			TO251	FAIRCHILD
2SK3113	600	2,0	4,4000	235			TO251	NEC
FQU2N60	600	2,0	4,7000	5			TO251	FAIRCHILD
FQU3N60	600	2,4	3,6000	5,6			TO251	FAIRCHILD
FQU2N80	800	1,8	6,3000				TO251	FAIRCHILD
FQU2N90	900	1,8	7,8000				TO251	FAIRCHILD
2SK1647L	900	2,0	7,0000	425			TO251	Renesas
2SK3257	900	5,0	2,8000	1100			TO251	SANYO
IXTU01N100	1000	0,1	80	60	8	1500	TO251	IXYS

HAF = 175 °C Temp. Fet

All MOSFETs up to 100 V are available in logic level, partly down to 2,5 V

MOSFET N-Channel

T0252
advanced



T0252
DPAK



T0252
4pin



Device	V _{DSS} V	I _D A	R _{DS(on)} Ω max V _{GS} =10V	C _{iss} pF/nc	Qg nC	t _{rr} ns	Package	Manufacturer
HAT2134H	20	60,0	0,0029	4750			TO252-4pin	Renesas
HAT2160H	20	60,0	0,0026	7750			TO252-4pin	Renesas
2SK3918-ZK	25	48	0,0075				TO252	NEC
2SK3919-ZK	25	64	0,0056				TO252	NEC
2SK3640-ZK	30	19	0,021				TO252	NEC
2SK3507-ZK	30	22	0,045				TO252	NEC
2SK3365-Z	30	30	0,014				TO252	NEC
HAT2116H	30	30,0	0,0082	1650			TO252-4pin	Renesas
HAT2168H	30	30,0	0,0060	1780			TO252-4pin	Renesas
2SK3367-Z	30	36,0	0,0090				TO252	NEC
HAT2096H	30	40,0	0,0053	2200			TO252-4pin	Renesas
HAT2143H	30	40,0	0,0061	2450			TO252-4pin	Renesas
HAT2167H	30	40,0	0,0055	2800			TO252-4pin	Renesas
HAT2166H	30	45,0	0,0038	4200			TO252-4pin	Renesas
HAT2099H	30	50,0	0,0037	4750			TO252-4pin	Renesas
HAT2165H	30	55,0	0,0033	5200			TO252-4pin	Renesas
HAT2164H	30	60,0	0,0031	7600			TO252-4pin	Renesas
2SK3643-ZK	30	64	0,006				TO252	NEC
HAT2139H	40	20,0	0,0129	2000			TO252-4pin	Renesas
HAT2129H	40	30,0	0,0075	3300			TO252-4pin	Renesas
HAT2172H	40	30,0	0,0075	1445			TO252-4pin	Renesas
HAT2171H	40	40,0	0,0048	2280			TO252-4pin	Renesas
HAT2137H	40	45,0	0,0048	6300			TO252-4pin	Renesas
HAT2170H	40	45,0	0,0042	3600			TO252-4pin	Renesas
HAT2169H	40	50,0	0,0035	4350			TO252-4pin	Renesas
2SK3813-Z	40	60	0,0053				TO252	NEC
NP22N055SHE/SLE	55	22,0	0,0370				TO252	NEC
NP32N055SDE/SHE	55	32,0	0,0240				TO252	NEC
NP34N055SHE/SLE	55	34	0,018				TO252	NEC
NP36N055SHE/SLE	55	36	0,013				TO252	NEC
NP52N055SUG	55	52	0,015				TO252	NEC
NP55N055SDG/SUG	55	55	0,0095				TO252	NEC
HAF2007S	60	5,0	0,0750				TO252	Renesas
2SK2926S	60	15,0	0,0550	500			TO252	Renesas
2SK2796*	60	20,0	0,0280	180			TO252	Renesas
2SK2869S	60	20,0	0,0450	740			TO252	Renesas
2SK3794-Z	60	20	0,044				TO252	NEC
2SK3225-Z	60	25,0	0,0200				TO252	NEC
H7N0603DS	60	30,0	0,0200				TO252	Renesas
2SK3385-Z	60	30,0	0,0280				TO252	NEC
2SK3402-Z	60	36	0,015				TO252	NEC
2SK3814-Z	60	60	0,0087				TO252	NEC
HAT2142H	100	10,0	0,0417	2100			TO252-4pin	Renesas
HAT2141H	100	15,0	0,0258	3400			TO252-4pin	Renesas
HAT2175H	100	15,0	0,042	1445			TO252-4pin	Renesas
HAT2174H	100	20,0	0,027	2280			TO252-4pin	Renesas
HAT2140H	100	25,0	0,138	6500			TO252-4pin	Renesas
HAT2173H	100	25,0	0,015	4350			TO252-4pin	Renesas
2SK3483-Z	100	28	0,052				TO252	NEC
2SK3482-Z	100	36	0,033				TO252	NEC
FQD16N15	150	11,8	0,1650				TO252	FAIRCHILD
2SK1954-Z	180	4	0,65				TO252	NEC
FQD4N20	200	3,0	1,4000	5			TO252	FAIRCHILD
H5N2005DS	200	6,0	0,6500				TO252	Renesas
2SK3634-Z	200	6	0,6				TO252	NEC
H5N2004DS	200	8,0	0,4800				TO252	Renesas
2SK3635-Z	200	8	0,43				TO252	NEC
FQD12N20 / L	200	9,0	0,2800				TO252	FAIRCHILD
HAT2119H	250	4,5	0,630	430			TO252-4pin	Renesas
H5N2505DS	250	5,0	0,8900				TO252	Renesas
H5N2508DS	250	7,0	0,6300	450			TO252	Renesas
2SK3712-Z	250	9	0,58				TO252	NEC
H5N2510DS	250	10,0	0,8900	390			TO252	Renesas
H5N5006DS	500	3,0	3,0000				TO252	Renesas
FQD5N50	500	3,5	1,8000	470			TO252	FAIRCHILD
2SK3491	600	1,0	11,0000	135			TO252	SANYO
2SK3113-Z	600	2,0	4,4000	235			TO252	NEC
FQD3N60	600	2,4	3,6000	350			TO252	FAIRCHILD
IXTY01N80	800	0,1	0,05	60	8	1500	TO252	IXYS
IXTY1N80	800	1	0,011	220	8,5	710	TO252	IXYS
IXTY01N100	1000	0,1	80	60	8	1500	TO252	IXYS

HAF = 175 °C Temp. Fet

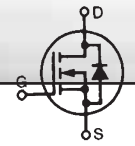
All MOSFETs up to 100 V are available in logic level, partly down to 2,5 V

MOSFET



MOSFET N-Channel

T0262
I2PAK



Device	V _{DSS} V	I _D A	R _{DS(on)} Ω max V _{GS} =10V	C _{iss} pF/nc	Qg nC	trr ns	Package	Manufacturer
2SK3405-S	20	48,0	0,0090				TO262	NEC
2SK3404-S	30	40,0	0,0140				TO262	NEC
2SK3424-S	30	48,0	0,0115				TO262	NEC
2SK3133L	30	50,0	0,0100				TO262	Renesas
2SK3134L	30	75,0	0,0050	6800			TO262	Renesas
NP80N03DLE	30	80,0	0,0070				TO262	NEC
NP80N04DHE	40	80,0	0,008				TO262	NEC
NP84N04DHE	40	84,0	0,0052				TO262	NEC
NP86N04DHE	40	86,0	0,0045				TO262	NEC
NP88N04DHE	40	88,0	0,0043				TO262	NEC
H7N0401LD	40	90,0	0,0035				TO262	Renesas
NP40N055DHE/DLE	55	40,0	0,023				TO262	NEC
NP48N055DHE/DLE	55	48,0	0,0170				TO262	NEC
NP80N055DHE/DLE	55	80,0	0,0110				TO262	NEC
NP82N055DHE/DLE	55	82,0	0,0084	6600			TO262	NEC
NP84N055DHE/DLE	55	84,0	0,0070				TO262	NEC
NP88N055DHE/DLE	55	88,0	0,0052				TO262	NEC
HAF2012S	60	20,0	0,0430				TO262	Renesas
HAF2011S	60	40,0	0,0200				TO262	Renesas
2SK3433-S	60	40,0	0,0260				TO262	NEC
2SK3434-S	60	48,0	0,02				TO262	NEC
HAF2021L	60	50,0	0,0120				TO262	Renesas
H7N0608LD	60	70,0	0,0051				TO262	Renesas
2SK3435-S	60	80,0	0,014				TO262	NEC
2SK3353-S	60	82,0	0,0095				TO262	NEC
2SK3355-S	60	83,0	0,0058				TO262	NEC
H7N0602LD	60	85,0	0,0051				TO262	Renesas
FQI85N06	60	85,0	0,0100	165			TO262	FAIRCHILD
2SK3510-S	75	83,0	0,0085				TO262	NEC
NP84N075DUE	75	84,0	0,0125				TO262	NEC
NP88N075DUE	75	88,0	0,0085				TO262	NEC
FQI13N10	100	12,8	0,1800				TO262	FAIRCHILD
NP24N10DLB	100	24,0	0,08				TO262	NEC
NP55N10DLD	100	55,0	0,0300				TO262	NEC
2SK3359-S	100	70,0	0,0200				TO262	NEC
NP82N10DLD	100	82,0	0,0200				TO262	NEC
2SK3210	150	50,0	0,0045				TO262	Renesas
FQI5N20	200	4,5	1,2000	6			TO262	FAIRCHILD
FQI7N20	200	6,6	0,6900	9			TO262	FAIRCHILD
FQI10N20	200	10,0	0,3600	13			TO262	FAIRCHILD
FQI12N20	200	11,6	0,2800	18			TO262	FAIRCHILD
2SK3161	200	15,0	0,1150	1550			TO262	Renesas
2SK3211	200	20,0	0,0850				TO262	Renesas
FQI34N20	200	31,0	0,0750	55			TO262	FAIRCHILD
FQI3N25	250	2,8	2,2000				TO262	FAIRCHILD
FQI6N25	250	5,5	1,0000				TO262	FAIRCHILD
FQI9N25	250	9,4	0,4200				TO262	FAIRCHILD
2SK3294-S	250	20,0	0,16				TO262	NEC
FQI27N25	250	25,0	0,1100				TO262	FAIRCHILD
FQI28N15	250	28,0	0,0850				TO262	FAIRCHILD
FQI2N50	500	2,1	5,3000	4			TO262	FAIRCHILD
FQI4N50	500	3,4	2,7000	6			TO262	FAIRCHILD
FQI6N50	500	5,5	1,3000	11			TO262	FAIRCHILD
FQI2N60	600	2,4	4,7000	5			TO262	FAIRCHILD
FQI3N60	600	3,0	3,6000	5,6			TO262	FAIRCHILD
FQI5N60	600	5,0	2,0000	9,2			TO262	FAIRCHILD
FQI3N80	800	2,9	5,0000				TO262	FAIRCHILD
FQI5N80	800	4,8	2,6000				TO262	FAIRCHILD
FQI2N90	900	2,2	7,8000				TO262	FAIRCHILD
FQI3N90	900	3,6	4,2000				TO262	FAIRCHILD
FQI5N90	900	5,4	2,3000				TO262	FAIRCHILD
FQI6N90	900	5,8	1,9000	17			TO262	FAIRCHILD

HAF = 175 °C Temp. Fet

All MOSFETs up to 100 V are available in logic level, partly down to 2,5 V

MOSFET N-Channel

T0263
advanced



T0263
D2PAK



Device	V _{DSS} V	I _D A	R _{DS(on)} Ω max V _{GS} =10V	C _{iss} pF/nc	Qg nC	trr ns	Package	Manufacturer
2SK3296-ZJ	20	35,0	0,012				TO263	NEC
2SK3295-ZJ	20	35,0	0,018				TO263	NEC
2SK3571-ZK	20	48,0	0,009				TO263	NEC
2SK3572-ZK	20	80,0	0,0057				TO263	NEC
2SK3573-ZK	20	83,0	0,004				TO263	NEC
2SK3404-ZK	30	40,0	0,014				TO263	NEC
2SK3424-ZK	30	48,0	0,015				TO263	NEC
2SK3574-ZK	30	48,0	0,0135				TO263	NEC
NP80N03KDE/KLE	30	80,0	0,0070				TO263	NEC
NP82N03PUG	30	82,0	0,0028				TO263	NEC
NP88N03KUG	30	88,0	0,0024				TO263	NEC
NP110N03PUG	30	110,0	0,0017				TO263	NEC
NP60N04KUG	40	60,0	0,0061				TO263	NEC
2SK3430-ZJ	40	80,0	0,0073				TO263	NEC
NP80N04KHE	40	80,0	0,008				TO263	NEC
NP82N04PUG	40	82,0	0,0035				TO263	NEC
2SK3432-ZJ	40	83,0	0,004				TO263	NEC
2SK3431-ZJ	40	83,0	0,0056				TO263	NEC
NP84N04KHE	40	84,0	0,0052				TO263	NEC
NP86N04KHE	40	86,0	0,0044				TO263	NEC
NP88N04KUG/KHE	40	88,0	0,0029				TO263	NEC
2SK3811-ZP	40	110,0	0,0018				TO263	NEC
NP110N04PUG	40	110,0	0,0018				TO263	NEC
NP40N055KHE/KLE	55	40,0	0,023				TO263	NEC
NP48N055KHE/KLE	55	48,0	0,017				TO263	NEC
NP60N055KUG	55	60,0	0,0094				TO263	NEC
NP80N055KHE/KLE	55	80,0	0,011				TO263	NEC
NP82N055KLE/KHE	55	82,0	0,0084				TO263	NEC
NP82N055PUG	55	82,0	0,0052				TO263	NEC
NP84N055KLE/KHE	55	84,0	0,007				TO263	NEC
NP88N055KUG	55	88,0	0,0042				TO263	NEC
NP88N055KHE/KLE	55	88,0	0,0053				TO263	NEC
NP110N055PUG	55	110,0	0,0028				TO263	NEC
HAF2012S	60	20,0	0,0430				TO263	Renesas
2SK3815	60	23,0					TO263	SANYO
2SK3816	60	40,0					TO263	SANYO
2SK3817	60	60,0					TO263	SANYO
2SK3818	60	74,0					TO263	SANYO
HAF2011S	60	40,0	0,0200				TO263	Renesas
2SK3433-ZJ	60	40,0	0,026				TO263	NEC
2SK3434-ZJ	60	48,0	0,02				TO263	NEC
HAF2021S	60	50,0	0,0120				TO263	Renesas
2SK3435-ZJ	60	80,0	0,014				TO263	NEC
2SK3353-ZJ	60	82,0	0,0095				TO263	NEC
2SK3355-ZJ	60	83,0	0,0058				TO263	NEC
2SK3354-ZJ	60	83,0	0,008				TO263	NEC
FQB85N06	60	85,0	0,0100	165			TO263	FAIRCHILD
H7N0602LM	60	85,0	0,0510				TO263	Renesas
2SK3812-ZP	60	110,0	0,0028				TO263	NEC
2SK3510-ZJ	75	83,0	0,0085				TO263	NEC
2SK3511-ZJ	75	83,0	0,0125				TO263	NEC
NP84N075KUE	75	84,0	0,0125				TO263	NEC
NP88N075KUE	75	88,0	0,0085				TO263	NEC
FQB13N10	100	12,8	0,1800				TO263	FAIRCHILD
NP24N10ELB	100	24,0	0,0800	1300			TO263	NEC
2SK3481-ZJ	100	30,0	0,05				TO263	NEC
2SK3480-ZJ	100	50,0	0,031				TO263	NEC

HAF = 175 °C Temp. Fet

All MOSFETs up to 100 V are available in logic level, partly down to 2,5 V

MOSFET

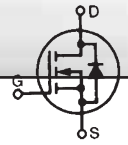


MOSFET N-Channel

T0263
advanced



T0263
D2PAK



MOSFET

Device	V _{DSS} V	I _D A	R _{DS(on)} Ω max V _{GS} =10V	C _{iss} pF/nc	Qg nC	t _{rr} ns	Package	Manufacturer
NP55N10ELD	100	55,0	0,0300				TO263	NEC
2SK3359-ZJ	100	70,0	0,0200				TO263	NEC
NP82N10ELD	100	82,0	0,0200				TO263	NEC
2SK3479-ZJ	100	83,0	0,011				TO263	NEC
FQB5N20	200	4,5	1,5000		6		TO263	FAIRCHILD
FQB7N20	200	6,6	0,6900		9		TO263	FAIRCHILD
2SK3109-ZJ	200	10,0	0,4000	400			TO263	NEC
FQB12N20	200	11,6	0,2700		18		TO263	FAIRCHILD
2SK3111-ZJ	200	20,0	0,1800	880			TO263	NEC
2SK3112-ZJ	200	25,0	0,11				TO263	NEC
FQB34N20	200	31,0	0,0750				TO263	FAIRCHILD
FQB3N25	250	2,8	2,2000				TO263	FAIRCHILD
FQB4N25	250	3,6	1,7500				TO263	FAIRCHILD
FQB6N25	250	5,5	10,0000				TO263	FAIRCHILD
FQB8N25	250	8,0	0,5500				TO263	FAIRCHILD
2SK2133-ZJ	250	16,0	0,2600	1090			TO263	NEC
2SK2133-ZJ	250	16,0	0,26				TO263	NEC
2SK3294-ZJ	250	20,0	0,16				TO263	NEC
2SK3740-ZK	250	20,0	0,16				TO263	NEC
FQB28N15	250	28,0	0,0850				TO263	FAIRCHILD
FQB2N50	500	2,1	5,3000	4			TO263	FAIRCHILD
IRFW830A	500	4,5	1,5000	690			TO263	FAIRCHILD
2SK3238	500	5,0	1,5000	570			TO263	Sanyo
2SK2619	500	6,0	1,3000				TO263	SANYO
IRFW840A	500	8,0	0,8500	1190			TO263	FAIRCHILD
2SK3251	500	10,0	1,0000	880			TO263	Sanyo
FQB2N60	600	2,4	4,7000	5			TO263	FAIRCHILD
FQB3N60	600	3,0	3,6000	5,6			TO263	FAIRCHILD
FS4VS-12A	600	4,0	2,3000				TO263	Renesas
2SK3242	600	4,0	2,2000	510			TO263	SANYO
2SK3322-ZJ	600	5,5	2,2000				TO263	NEC
FK7VS-12	600	7,0	1,6300				TO263	Renesas
FS7VS-12A	600	7,0	1,3000				TO263	Renesas
2SK3116-ZJ	600	7,5	1,2000	920			TO263	NEC
2SK3246	600	8,0	1,2000	1050			TO263	SANYO
FS10VS-12A	600	10,0	0,9400				TO263	Renesas
IXTA1N80	800	1,0	11	220	8,5	710	TO263	IXYS
IXTA2N80	800	2,0	6,2	440	22	510	TO263	IXYS
FQB3N80	800	3,0	5,0000				TO263	FAIRCHILD
IXFA3N80	800	3,6	3,6	685	24	250	TO263	IXYS
2SK2479-ZJ	900	3,0	7,5000				TO263	NEC
2SK2481-ZJ	900	4,0	4,0000				TO263	NEC
2SK3256	900	5,0	2,8000	1100			TO263	SANYO
IXTA05N100	1000	0,8	15	220	8,5	710	TO263	IXYS
IXTA1N100	1000	1,5	11	480	23	710	TO263	IXYS
IXTA2N100	1000	2,0	7,0000	825			TO263	IXYS
IXFA4N100Q	1000	4,0	3	1050	39	250	TO263	IXYS
IXFA3N120	1200	3,0	4,5	1050	39	250	TO263	IXYS
2SK3744	1500	2,0	13,0000	550			TO263	Sanyo
IXUV 170N075S	75	175 *	0,00563	250	120	310	TO263iso	IXYS

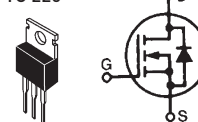
HAF = 175 °C Temp. Fet

All MOSFETs up to 100 V are available in logic level, partly down to 2,5 V

MOSFET N-Channel



TO 220

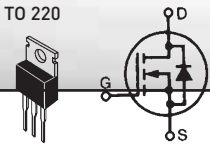


Device	V _{DSS} V	I _n A	R _{DS(on)} Ω max V _{GS} =10V	C _{iss} pF/nc	Qg nC	trr ns	Package	Manufacturer
2SK3296	20	35	0,012				TO220	NEC
2SK3571	20	48	0,009				TO220	NEC
2SK3572	20	80	0,0057				TO220	NEC
2SK3573	20	83	0,004				TO220	NEC
2SK3404	30	40	0,014				TO220	NEC
2SK3574	30	48	0,0135				TO220	NEC
2SK3141	30	75,0	0,0050	6800			TO220	Renesas
NP80N03CLE	30	80,0	0,0070				TO220	NEC
2SK3575	30	83	0,0045				TO220	NEC
2SK3136	40	75,0	0,0058	6800			TO220	Renesas
NP80N04CHE	40	80,0	0,0080				TO220	NEC
NP84N04CHE	40	84	0,0052				TO220	NEC
NP86N04CHE	40	86,0	0,0044				TO220	NEC
NP88N04CHE	40	88	0,0043				TO220	NEC
NP40N055CHE/CLE	55	40,0	0,0250				TO220	NEC
NP48N055CHE/CLE	55	48,0	0,0170				TO220	NEC
NP80N055CHE/CLE	55	80,0	0,0110				TO220	NEC
NP82N055CHE/CLE	55	82,0	0,0084	6600			TO220	NEC
NP84N055CHE/CLE+	55	84,0	0,0070	—			TO220	NEC
NP88N055CHE/CLE	55	88,0	0,0052	—			TO220	NEC
HAF2001 *	60	20,00	0,0650				TO220	Renesas
NP32N60CLD	60	32,0	0,0340	—			TO220	NEC
NP40N06CLC	60	40,0	0,0270	1000			TO220	NEC
HAF2001 *	60	40,00	0,0200				TO220	Renesas
NP45N06CLC	60	45,0	0,0200	—			TO220	NEC
2SK3434	60	48	20				TO220	NEC
NP55N06CLD	60	55,0	0,0170	1500			TO220	NEC
H7N0608AB	60	70,0	0,0080	6200			TO220	Renesas
2SK3435	60	80	14				TO220	NEC
NP82N06CLD	60	82,0	0,0085	3000			TO220	NEC
2SK3355	60	83	5,8				TO220	NEC
NP84N06CLD	60	84,0	0,0065	—			TO220	NEC
H7N0602AB	60	85,0	0,0052	9000			TO220	Renesas
FQP85N06	60	85,0	0,0100				TO220	FAIRCHILD
2SK3510	75	83	8,5				TO220	NEC
2SK3511	75	83	12,5				TO220	NEC
NP84N075CUE	75	84	12,5				TO220	NEC
NP88N075CUE	75	88	8,5				TO220	NEC
IXUV170N075	75	175	0,00563	250	120	310	TO220plus	IXYS
2SK3212	100	10,0	0,1300	420			TO220	Renesas
IRF530B	100	14,0	0,1100	610			TO220	FAIRCHILD
FQP19N10	100	19,0	0,1000				TO220	FAIRCHILD
H7N1004AB	100	20,0	0,0380				TO220	Renesas
NP24N10CLB	100	24	80				TO220	NEC
2SK3481	100	30	50				TO220	NEC
2SK3480	100	50	31				TO220	NEC
NP55N10CLD	100	55,0	0,0300	—			TO220	NEC
2SK3359	100	70,0	0,0200	—			TO220	NEC
2SK3479	100	83	11				TO220	NEC
2SK3152	120	10,0	0,1300	580			TO220	Renesas
25K3153	120	15,0	0,0850	830			TO220	Renesas
2SK3154	150	15,0	0,1300	850			TO220	Renesas
2SK3207	150	18,0	0,0900	1100			TO220	Renesas
2SK3156	150	20,0	0,0700	1750			TO220	Renesas
2SK3209	150	25,0	0,0450	—			TO220	Renesas
2SK3158	150	30,0	0,0450	—			TO220	Renesas
FQP4N20	200	3,6	1,4000		5		TO220	FAIRCHILD
FQP5N20	200	4,5	1,2000	6	6		TO220	FAIRCHILD
FQP7N20	200	6,6	0,6900		9		TO220	FAIRCHILD
2SK3215	200	9,0	0,1700				TO220	Renesas
2SK3109	200	10,0	0,4000	400			TO220	NEC
FQP12N20	200	11,6	0,2800	18			TO220	FAIRCHILD
IRF640B	200	18,0	0,1800	1160			TO220	FAIRCHILD
2SK3214	200	18,0	0,1700				TO220	Renesas
2SK3162	200	20,0	0,0850	2420			TO220	Renesas
2SK3112	200	25,0	0,1100	1500			TO220	NEC

HAF = 175 °C Temp. Fet

All MOSFETs up to 100 V are available in logic level, partly down to 2,5 V

MOSFET



Device	V _{DSS} V	I _D A	R _{DS(on)} Ω max V _{GS} =10V	C _{iss} pF/nc	Q _g nC	t _{rr} ns	Package	Manufacturer
2SK3294	250	20	160				TO220	NEC
FQP28N15	250	28,0	0,0850				TO220	FAIRCHILD
FQP34N20L	250	31,0	0,0750				TO220	FAIRCHILD
FQP2N50	500	2,1	5,3000	4			TO220	FAIRCHILD
IRF820B	500	2,5	3,0000	390			TO220	FAIRCHILD
FS3UM-10A	500	3,0	4,4000	280			TO220	Renesas
IRF830B	500	4,5	1,5000	—			TO220	FAIRCHILD
2SK3305	500	5,0	1,5000	—			TO220	NEC
FS5UM-10A	500	5,0	1,5000	700			TO220	Renesas
IRF840B	500	8,0	0,8500	1190			TO220	FAIRCHILD
2SK3325	500	10,0	0,8500	—			TO220	NEC
FK10UM-10	500	10,0	1,1300	1100			TO220	Renesas
FS10UM-10A	500	10,0	0,9000	1100			TO220	Renesas
2SK3456	500	12,0					TO220	NEC
FK14UM-10	500	14,0	0,8000	1500			TO220	Renesas
FS14UM-10A	500	14,0	0,6400	1500			TO220	Renesas
FS18UM-10A	500	18,0	0,4100	2350			TO220	Renesas
IXTP02N50D	500	0.20	0,03	120			TO220	IXYS
FS2UM-12A	600	2,0	6,4000	280			TO220	Renesas
FQP2N60	600	2,4	4,7000	5			TO220	FAIRCHILD
FQP3N60	600	3,0	3,6000	5,6			TO220	FAIRCHILD
2SK3244	600	4,0	2,2000	510			TO220	FAIRCHILD
FS4UM-12A	600	4,0	2,3000	630			TO220	Renesas
FQP5N60	600	5,0	2,0000	9,2			TO220	FAIRCHILD
2SK3322	600	5,5					TO220	NEC
FK7UM-12	600	7,0	1,6300	100			TO220	Renesas
FS7UM-12A	600	7,0	1,3000	1100			TO220	Renesas
FQP7N60	600	7,4	1,0000	15			TO220	FAIRCHILD
2SK3116	600	7,5	1,2000	920			TO220	NEC
2SK3299	600	10,0	0,7500	—			TO220	NEC
FK10UM-12	600	10,0	1,1800	1500			TO220	Renesas
FS10UM-12A	600	10,0	0,9400	1500			TO220	Renesas
FS14UM-12A	600	14,0	0,6200	2350			TO220	Renesas
IXTP1N80	800	1	11	220	8,5	710	TO220	IXYS
IXTP2N80	800	2	6.2	440	22	510	TO220	IXYS
FQP2N80	800	2,4	6,3000				TO220	FAIRCHILD
FQP3N80	800	3,0	5,0000				TO220	FAIRCHILD
IXFP3N80	800	3,6	3,6	685	24	250	TO220	IXYS
FQP5N80	800	4,8	2,6000				TO220	FAIRCHILD
2SK3458	800	6,0					TO220	NEC
2SK2479	900	3,0	7,5000	485			TO220	NEC
2SK2481	900	4,0	4,0000	900			TO220	NEC
2SK2484	900	5,0	2,8000	1200			TO220	NEC
FQP6N90	900	5,8	1,9000	17			TO220	FAIRCHILD
IXTP01N100D	1000	0.10	0,110	120			TO220	IXYS
IXTP05N100	1000	0,75	15	220	8,5	710	TO220	IXYS
IXTP1N100	1000	1,5	11	480	23	710	TO220	IXYS
IXTP2N100	1000	2,0	7,0000	825			TO220	IXYS
IXFP4N100Q	1000	4	3	1050	39	250	TO220	IXYS
IXFP3N120	1200	3	4,5	1050	39	250	TO220	IXYS

HAF = 175 °C Temp. Fet

All MOSFETs up to 100 V are available in logic level, partly down to 2,5 V

MOSFET N-Channel



Device	V _{DSS} V	I _D A	R _{DS(on)} Ω max V _{GS} =10V	C _{iss} pF	Qg nC	trr ns	Package	Manufacturer
2SK3142	30	60,0	0,0050	6800			TO220iso	Renesas
2SK3755	40	45	0,012				TO220iso	NEC
IXUC100N055	55	100	0,0061	100	80	150	TO220iso	IXYS
IXUC200N055	55	200 *	0,004	200	80	250	TO220iso	IXYS
FQPF20N06	60	15,0	0,0600		25		TO220iso	FAIRCHILD
HAF2008 *	60	20,0	0,0430				TO220iso	Renesas
FQPF55N06	60	33,0	0,0200	2100	75		TO220iso	FAIRCHILD
HAF2005 *	60	40,0	0,0200				TO220iso	Renesas
2SK3714	60	50	0,013				TO220iso	NEC
FQPF85N06	60	53,0	0,0100	165			TO220iso	FAIRCHILD
2SK3715	60	75	0,006				TO220iso	NEC
IXUC160N075	75	160	0,0053	250	120	250	TO220iso	IXYS
IXFC80N085	85	80	0,011	4800	180	200	TO220iso	IXYS
FQPF7N10	100	5,5	0,3500				TO220iso	FAIRCHILD
FQPF13N10	100	8,7	0,1800				TO220iso	FAIRCHILD
2SK1852	100	10,0	0,1500	1400			TO220iso	NEC
H7N1005FM	100	12,0	0,1200				TO220iso	Renesas
2SK3793	100	12	0,125				TO220iso	NEC
FQPF19N10	100	13,6	0,1000				TO220iso	FAIRCHILD
H7N1004FM	100	20,0	0,0380				TO220iso	Renesas
FQPF70N10	100	35,0	0,0250				TO220iso	FAIRCHILD
IXUC60N10	100	60	0,0128	110	80	150	TO220iso	IXYS
H7N1002CF	100	75,0	0,0100				TO220iso	Renesas
IXTC75N10	100	75	0,02	4500	180	300	TO220iso	IXYS
IXFC80N10	100	80,0	0,1000				TO220iso	IXYS
IXUC120N10	100	120	0,0073	220	80	300	TO220iso	IXYS
2SK3155	150	15,0	0,1300	850			TO220iso	Renesas
2SK3157	150	20,0	0,0700	1750			TO220iso	Renesas
FQPF46N15	150	25,6	0,0420	100	85		TO220iso	FAIRCHILD
FQPF5N20	200	3,5	0,1200	6	6		TO220iso	FAIRCHILD
FQPF7N20	200	4,8	0,6900	9			TO220iso	FAIRCHILD
SK3319	200	6,0	0,4000				TO220iso	Renesas
FQPF10N20	200	6,8	0,3600	13			TO220iso	FAIRCHILD
H5N2004CF	200	7,0	0,4800				TO220iso	Renesas
2SK3108	200	8	0,4				TO220iso	NEC
FQPF12N20	200	8,2	0,2800	18			TO220iso	FAIRCHILD
IRFS640A	200	9,8	0,1800	1160			TO220iso	FAIRCHILD
2SK3110	200	14	0,18				TO220iso	NEC
FQPF34N20	200	17,5	0,0750	55			TO220iso	FAIRCHILD
IXFC60N20	200	60	0,033	5200	155	250	TO220iso	IXYS
FQPF4N25	250	2,8	0,1750				TO220iso	FAIRCHILD
FQPF6N25	250	4,0	1,0000				TO220iso	FAIRCHILD
FQPF8N25	250	5,5	0,5500				TO220iso	FAIRCHILD
H5N2504CF	250	6,0	0,6300				TO220iso	Renesas
FQPF9N25	250	6,7	0,4200				TO220iso	FAIRCHILD
2SK3454	250	7	0,63				TO220iso	NEC
FQPF16N25	250	9,5	0,2300				TO220iso	FAIRCHILD
2SK2341	250	11,0	0,2600	1100			TO220iso	NEC
FQPF28N15	250	16,7	0,0850				TO220iso	FAIRCHILD
FQPF11N40	400	6,6	0,4800	20			TO220iso	FAIRCHILD
FQPF17N40	400	9,3	0,2700	30			TO220iso	FAIRCHILD
FQPF2N50	500	1,3	5,3000		4		TO220iso	FAIRCHILD
IRFS820B	500	2,1	3,0000	390			TO220iso	FAIRCHILD
FQPF4N50	500	2,3	2,7000	355	10		TO220iso	FAIRCHILD

HAF = 175 °C Temp. Fet

All MOSFETs up to 100 V are available in logic level, partly down to 2,5 V



MOSFET N-Channel

TO 220 isoplus

TO 220F



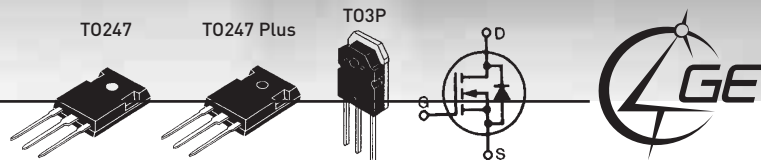
MOSFET

Device	V _{DSS} V	I _D A	R _{DS(on)} Ω max V _{GS} =10V	C _{iss} pF	Qg nC	t _{rr} ns	Package	Manufacturer
H5N5006FM	500	3,0	3,0000				TO220iso	Renesas
FS3KM-10A	500	3,0	4,4000	280			TO220iso	Renesas
IRFS830B	500	3,1	1,5000	690			TO220iso	FAIRCHILD
FQPF6N50	500	3,6	1,3000		11		TO220iso	FAIRCHILD
IRFS840B	500	4,6	0,8500	1190			TO220iso	FAIRCHILD
H5N5001FM	500	5,0	1,5000				TO220iso	Renesas
2SK3306	500	5,0	1,5000				TO220iso	NEC
FS5KM-10A	500	5,0	1,5000	700			TO220iso	Renesas
FQPF9N50	500	5,3	0,7300	20			TO220iso	FAIRCHILD
2SK3326	500	10,0	0,8500				TO220iso	NEC
FS10KM-10A	500	10,0	0,9000	1100			TO220iso	Renesas
FK10KM-10	500	10,0	1,1300	1100			TO220iso	Renesas
2SK3455	500	12,0	0,5800				TO220iso	NEC
FS14KM-10A	500	14,0	0,6400	1500			TO220iso	Renesas
FK14KM-10	500	14,0	0,8000	1500			TO220iso	Renesas
FS18KM-10A	500	18,0	0,4100	2350			TO220iso	Renesas
IXFC26N50Q	500	24,0	0,0700				TO220iso	IXYS
FQPF2N60	600	1,6	4,7000		5		TO220iso	FAIRCHILD
2SK3221	600	2,0	4,4000	235			TO220iso	NEC
FS2KM-12A	600	2,0	6,4000	280			TO220iso	Renesas
FQPF4N60	600	2,6	2,2000		8		TO220iso	FAIRCHILD
FQPF6N60	600	3,6	1,5000		10		TO220iso	FAIRCHILD
2SK3114	600	4,0	2,2000	510			TO220iso	NEC
FS4KM-12A	600	4,0	2,3000	630			TO220iso	Renesas
FQPF7N60	600	4,3	1,0000		15		TO220iso	FAIRCHILD
2SK1404	600	5,0	1,5000	1000			TO220iso	Renesas
2SK3297	600	5,0	1,6000				TO220iso	NEC
2SK3115	600	6,0	1,2000	980			TO220iso	NEC
FS7KM-12A	600	7,0	1,3000	1100			TO220iso	Renesas
FK7KM-12	600	7,0	1,6300	1100			TO220iso	Renesas
2SK3298	600	7,5	0,7500				TO220iso	NEC
2SK3245LS	600	8,0	1,2000	1050			TO220iso	SANYO
FS10KM-12A	600	10,0	0,9400	1500			TO220iso	Renesas
IXKC13N80C	600	13,0	0,1500		85		TO220iso	IXYS
IXKC20N60C	600	14	0,190		80		TO220iso	IXYS
IXKC25N80C	600	25,0	0,0750		170		TO220iso	IXYS
IXKC40N60C	600	28	0,100		160		TO220iso	IXYS
FQPF3N80	800	1,8	5,0000				TO220iso	FAIRCHILD
FQPF4N80	800	2,2	3,6000				TO220iso	FAIRCHILD
FQPF5N80	800	2,8	2,6000				TO220iso	FAIRCHILD
2SK2476	800	3,0	5,0000	590			TO220iso	NEC
FQPF6N80	800	3,3	1,9500				TO220iso	FAIRCHILD
FQPF7N80	800	3,8	1,5000	19			TO220iso	FAIRCHILD
2SK3457	800	5,0	2,2000				TO220iso	NEC
IXKC13N80C	800	13	0,290		85		TO220iso	IXYS
IXKC25N80C	800	25	0,150		170		TO220iso	IXYS
FQPF3N90	900	2,1	4,2500				TO220iso	FAIRCHILD
FQPF4N90	900	2,4	3,3000				TO220iso	FAIRCHILD
FQPF5N90	900	3,0	2,3000				TO220iso	FAIRCHILD
2SK2480	900	3,0	4,0000	900			TO220iso	NEC
FQPF6N90	900	3,4	1,9000	17			TO220iso	FAIRCHILD
2SK2483	900	3,5	2,8000	1200			TO220iso	NEC
2SK3255LS	900	5,0	2,8000	1100			TO220iso	Sanyo
2SK3745	1500	2,0	13,0000	400			TO220iso	Sanyo

HAF = 175 °C Temp. Fet

All MOSFETs up to 100 V are available in logic level, partly down to 2,5 V

MOSFET N-Channel



Device	V _{DSS} V	I _D A	R _{DS(on)} Ω max V _{GS} =10V	C _{iss} pF/nc	Q _g nC	trr ns	Package	Manufacturer
2SK3307	60	70	9,5				TO3P	NEC
2SK3357	60	75	5,8				TO3P	NEC
2SK3356	60	75	8				TO3P	NEC
IXFH76N07-11	70	76	0,011	4400	240	150	TO247	IXYS
IXFH76N07-12	70	76,0	0,0120	4400			TO247	IXYS
IXFX180N07	70	180*	0,006	9400	420	250	TO247plus	IXYS
IXFH80N085	85	80	0,009	4800	180	200	TO247	IXYS
IXFX180N085	85	180*	0,007	9100	320	250	TO247plus	IXYS
2SK1303	100	30,0	0,0600	1750			TO3P	Renesas
2SK1304	100	40,0	0,0300	3500			TO3P	Renesas
2SK3151	100	50,0	0,0150	4000			TO3P	Renesas
IXTH60N10	100	60	0.2	3200	110	150	TO247	IXYS
FQA55N10	100	61,0	0,0260				TO3P	FAIRCHILD
IXFH67N10	100	67,0	0,0250	4500			TO247	IXYS
FQA70N10	100	70,0	0,0250				TO3P	FAIRCHILD
IXFH75N10	100	75	0,02	4500	180	200	TO247	IXYS
IXFH75N10Q	100	75	0,02	3700	140	200	TO247	IXYS
IXFH80N10Q	100	80*	0,015	4500	180	200	TO247	IXYS
H7N1001P	100	90,0	0,0040				TO3P	Renesas
IXTQ 110N10P	100	100*	13	3500	110	120	TO3P	IXYS
IXTQ 140N10P	100	140*	9.5	4900	160	120	TO3P	IXYS
IXFX180N10	100	180*	0,008	9100	360	250	TO247plus	IXYS
2SK1056	120	7,0	1,0000	600			TO3P	Renesas
2SK1057	140	7,0	1,0000	600			TO3P	Renesas
FQA46N15	150	50,0	0,0420				TO3P	FAIRCHILD
IXTH60N15	150	60	0.033	3000	110	150	TO247	IXYS
IXFH70N15	150	70,0	0,0280	—			TO247	IXYS
IXFH80N15Q	150	80,0	0,0280	—			TO247	IXYS
IXTH88N15*	150	88	0.022	4000	170	150	TO247	IXYS
IXFX110N15Q	150	110,0	0,0160	—			TO247Plus	IXYS
IXFX150N15	150	150	0,0125	9100	360	250	TO247plus	IXYS
IXTQ 96N15P	150	96*	23	3500	105	150	TO3P	IXYS
2SK2221	200	8,0	1,0000	700			TO3P	Renesas
FQA48N20	200	48,0	0,0500	75			TO3P	FAIRCHILD
IXTH48N20	200	48	0.05	3000	110	250	TO247	IXYS
IXFH50N20	200	50,0	0,0450	4400			TO247	IXYS
IXFH58N20Q	200	58	0,04	3600	98	200	TO247	IXYS
IXFH60N20	200	60	0,033	5200	155	250	TO247	IXYS
FQA65N20	200	65,0	0,0320				TO3P	FAIRCHILD
IXFH66N20Q	200	66	0,04	3700	105	200	TO247	IXYS
IXTH72N20	200	72	0.032	4400	170	200	TO247	IXYS
IXTQ 74N20P	200	74	34	3300	107	160	TO3P	IXYS
IXFH80N20Q	200	80,0	0,0280	5600			TO247	IXYS
IXFX88N20Q	200	88	0,028	4150	146	200	TO247plus	IXYS
IXFH88N20Q	200	88	0,03	4150	146	200	TO247	IXYS
IXFX90N20Q	200	90	0,022	6800	190	200	TO247plus	IXYS
IXFX120N20	200	120	0,017	9100	300	250	TO247plus	IXYS
IXTQ 96N20P	200	96*	24	4800	145	160	TO3P	IXYS
2SK1669 °	250	30,0	0,0950	3100			TO3P	Renesas

* = Avalanche Guarantee
Q = Low Gate Charge

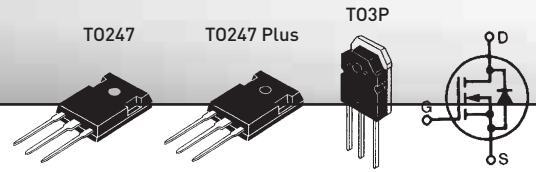
** = BI-Mosfet
° = Fast Diode

IXFH/IXFK = trr 100-250ns
F = RF FET

IXF... = Avalanche Diode
P = Polar Fet



MOSFET N-Channel



MOSFET

Device	V _{DSS} V	I _n A	R _{DS(on)} Ω max V _{GS} =10V	C _{iss} pF/nc	Q _g nC	trr ns	Package	Manufacturer
FQA40N25	250	40,0	0,0700				TO3P	FAIRCHILD
IXTH41N25	250	41	0.072	3200	110	300	TO247	IXYS
FQA55N25	250	55,0	0,0400				TO3P	FAIRCHILD
IXFH60N25Q	250	60,0	0,0470	—			TO247	IXYS
IXTH60N25	250	60	0.046	4400	164	300	TO247	IXYS
IXTQ 64N25P	250	64	48	3500	105	160	TO3P	IXYS
IXTQ 82N25P	250	82*	33	4800	142	200	TO3P	IXYS
IXTQ 100N25P	250	100*	27	6300	185	200	TO3P	IXYS
IXFX100N25	250	100	0,0270	—			TO247Plus	IXYS
IXFH120N25	250	120	0,022	9400	400	250	TO247	IXYS
IXFX120N25	250	120	0,022	9400	400	250	TO247plus	IXYS
IXFH35N30	300	35,0	0,1000	4800			TO247	IXYS
IXFH40N30Q	300	40	0,08	3100	95	250	TO247	IXYS
IXFH40N30	300	40	0,085	4800	177	250	TO247	IXYS
IXTH50N30	300	50	0.06	4400	165	360	TO247	IXYS
IXFH52N30Q	300	52,0	0,0600	5600			TO247	IXYS
IXTQ 52N30P	300	52	66	3490	110	250	TO3P	IXYS
IXTQ 69N30P	300	69	46	4960	156	250	TO3P	IXYS
IXFX73N30Q	300	73	0,042	6400	190	250	TO247plus	IXYS
IXFX90N30	300	90	0,033	10000	360	250	TO247plus	IXYS
IXTH88N30P	300	88*	40	6300	180	250	TO247	IXYS
IXFH30N40Q	400	30	0,16	3300	95	250	TO247	IXYS
2SK1165	450	12,0	0,5500	1450			TO3P	Renesas
FK18SM-9	450	18,0	0,4100	2200,00			TO3P	Renesas
FK20SM-9	450	20,0	0,3000	2800,00			TO3P	Renesas
FS25SM-9A	450	25,0	0,1600	4600,00			TO3P	Renesas
2SK1516 °	500	10,0	0,9000	1050			TO3P	Renesas
2SK3253	500	10,0	1,0000	880			TO3P	SANYO
IXFH12N50F	500	12,0	0,4000	1870			TO247	IXYS
2SK1166	500	12,0	0,6000	1450			TO3P	Renesas
IXFH13N50	500	13,0	0,4000	2800			TO247	IXYS
IRFP450	500	14,0	0,4000	2500			TO3P	IXYS
2SK3235	500	15,0	0.4000	—			TO3P	Renesas
FK18SM-10	500	18,0	0,5000	2200,00			TO3P	Renesas
2SK1518 °	500	20,0	0,2700	2800			TO3P	Renesas
2SK2729*	500	20,0	0,2900	3300			TO3P	Renesas
FK20SM-10	500	20,0	0,3600	2800,00			TO3P	Renesas
IXFH21N50F	500	21,0	0,2500	2390			TO247	IXYS
IXFH21N50	500	21,0	0,2500	4200			TO247	IXYS
IXFH21N50Q	500	21	0,25	3350	90	250	TO247	IXYS
IXFH24N50	500	24,0	0,2300	4200			TO247	IXYS
IXFH24N50F	500	24,0	0,2300	2600			TO247	IXYS
IXTH24N50Q	500	24	0.24	3000	82	500	TO247	IXYS
FS25SM-10A	500	25,0	0,2000	4600,00			TO3P	Renesas
IXTH28N50Q	500	25	0.2	3300	94	500	TO247	IXYS
IXFH26N50Q	500	26	0,2	3900	95	250	TO247	IXYS
IXFH28N50F	500	28,0	0,1900	3000			TO247	IXYS
IXFH28N50Q	500	28	0,2	3300	94	250	TO247	IXYS
IXFH32N50Q	500	32,0	0,1500	5400			TO247	IXYS
IXFX32N50Q	500	32,0	0,1500	—			TO247Plus	IXYS
IXFH36N55Q2	500	36,0	0.16	4200			TO247	IXYS

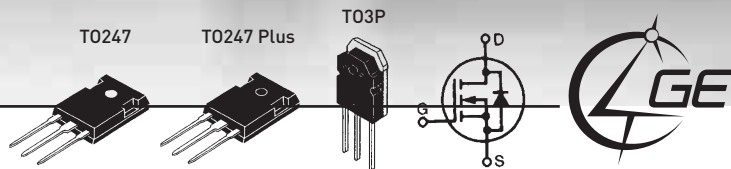
* = Avalanche Guarantee
Q = Low Gate Charge

** = BI-Mosfet
° = Fast Diode

IXFH/IXFK = trr 100-250nS
F = RF FET

IXF... = Avalanche Diode
P = Polar Fet

MOSFET N-Channel



Device	V _{DSS} V	I _D A	R _{DS(on)} Ω max V _{GS} =10V	C _{iss} pF/nc	Q _g nC	t _{rr} ns	Package	Manufacturer
IXFH40N50Q	500	40	0,14	4500	130	250	TO247	IXYS
IXFH40N50Q2	500	40	0.135	4550	110	250	TO247	IXYS
IXTQ40N50Q	500	40	0.14	4550	130	600	TO3P	IXYS
IXFX48N50Q	500	48	0,1	8000	190	250	TO247plus	IXYS
IXFX55N50	500	55	0,08	9400	330	250	TO247plus	IXYS
IXFX55N50F	500	55,0	0,0850	6700			TO247Plus	IXYS
IXFX66N50Q2	500	66	0.074	6800	199	250	TO247	IXYS
IXTQ24N55Q	550	24	0.27	3000	80	500	TO3P	IXYS
IXFH26N55Q	550	26	0,23	3300	92	250	TO247	IXYS
IXFH36N55Q	550	36	0,16	4500	128	250	TO247	IXYS
IXFH36N55Q2	550	36	0.16	4200	105	250	TO247	IXYS
IXFX44N55Q	550	44	0,12	6400	190	250	TO247plus	IXYS
IXFX60N55Q2	550	60	0.088	6900	200	250	TO247plus	IXYS
2SK3248	600	8,0	1,2000	1050			TO3P	SANYO
FK14SM-12	600	14,0	0,7500	2100,00			TO3P	Renesas
IXFH15N60	600	15,0	0,5000	4500			TO247	IXYS
FK18SM-12	600	18,0	0,5400	2800,00			TO3P	Renesas
IXFH20N60F	600	20,0	0,0380	2390			TO247	IXYS
IXFH20N60Q	600	20	0,35	3700	95	250	TO247	IXYS
FS22SM-12A	600	22,0	0,3000	4600,00			TO3P	Renesas
IXFH23N60Q	600	23	0,32	3300	90	250	TO247	IXYS
IXFQ23N60Q	600	23	0,32	3300	90	250	TO3P	IXYS
IXTQ23N60Q	600	23	0.32	3300	90	500	TO3P	IXYS
FQA24N60	600	23,5	0,2500				TO3P	FAIRCHILD
IXFH26N60Q	600	28	0,25	5100	150	250	TO247	IXYS
IXFX26N60Q	600	28	0,25	5100	150	250	TO247plus	IXYS
IXFH30N60Q	600	30	0,23	4700	124	250	TO247	IXYS
IXFX44N60	600	44	0,13	8900	330	250	TO247plus	IXYS
IXKH 47N60C	600	47	0.070		250		TO247	IXYS
IXFX52N60Q2	600	52	0.115	6800	198	250	TO247plus	IXYS
FQA8N80	800	8,0	1,2000				TO3P	FAIRCHILD
IXFH9N80	800	9	0,9	2600	85	250	TO247	IXYS
IXFH9N80Q	800	9	1,1	2200	56	250	TO247	IXYS
FQA10N80	800	9,8	1,0500				TO3P	FAIRCHILD
2SK2477	800	10,0	1,0000	2950			TO3P	NEC
IXFH13N80	800	13,0	0,8000	4200			TO247	IXYS
IXTH14N80	800	14	0.7	4500	145	800	TO247	IXYS
IXFH15N80Q	800	15,0	0,6000	4300			TO247	IXYS
IXFH17N80Q	800	17	0,6	4300	88	250	TO247	IXYS
IXFH20N80Q	800	20,0	0,4200	5760			TO247	IXYS
IXFH23N80Q	800	23	0,4	5100	120	250	TO247	IXYS
IXFX27N80Q	800	27	0,32	7600	170	250	TO247plus	IXYS
IXFX34N80	800	34	0,24	7500	270	250	TO247plus	IXYS
2SK1339	900	3,0	7,0000	410			TO3P	Renesas
2SK3258	900	5,0	2,8000	1100			TO3P	SANYO
2SK3324	900	6,0	2,8000	—			TO3P	NEC
IXTH6N90A	900	6	1.4	2600	88	900	TO247	IXYS
IXFH7N90Q	900	7	1,5	2200	56	250	TO247	IXYS
2SK3304	900	7,0	2,0000	—			TO3P	NEC
2SK2488	900	10,0	1,2000	2900			TO3P	NEC

* = Avalanche Guarantee
Q = Low Gate Charge

** = BI-Mosfet
° = Fast Diode

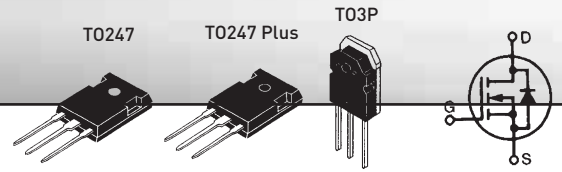
IXFH/IXFK = t_{rr} 100-250ns
F = RF FET

IXF... = Avalanche Diode
P = Polar Fet

MOSFET



MOSFET N-Channel



Device	V _{DSS} V	I _n A	R _{DS(on)} Ω max V _{GS} =10V	C _{iss} pF/nc	Q _g nC	trr ns	Package	Manufacturer
2SK3260	900	10,0	1,4000	2200			TO3P	SANYO
IXFH12N90Q	900	12	0,9	2900	90	200	TO247	IXYS
IXFX12N90Q	900	12	0,9	2900	90	200	TO247plus	IXYS
IXFH13N90 Q	900	13,0	0,9000	2700			TO247	IXYS
IXFH16N90Q	900	16	0,65	4000	133	250	TO247	IXYS
IXFX24N90Q	900	24	0,45	5900	170	250	TO247plus	IXYS
IXFX25N90	900	25,0	0,3300				TO247Plus	IXYS
IXFX26N90	900	26	0,3	8.7 nF	240	250	TO247plus	IXYS
IXTH1N100	1000	0,1	11	480	23	710	TO247	IXYS
IXFH4N100Q	1000	4	3	1050	39	250	TO247	IXYS
2SK1773	1000	5,0	2,0000	1700			TO3P	Renesas
IXFH6N100F	1000	6,0	1,0000	1870			TO247	IXYS
IXFH6N100	1000	6,0	2,0000	2600			TO247	IXYS
2SK1934	1000	8,0	1,6000	2690			TO3P	Renesas
IXFH10N100Q	1000	9,0	1,2000	—			TO247	IXYS
IXFH10N100	1000	10,0	1,2000	4000			TO247	IXYS
IXFH12N100 Q	1000	12,0	1,0000	3000			TO247	IXYS
IXFH12N100F	1000	12,0	1,0500	2700			TO247	IXYS
IXFH13N100	1000	13,0	0,9000	3000			TO247	IXYS
IXFH14N100	1000	14,0	0,7500	4500			TO247	IXYS
IXFX14N100	1000	14,0	0,7500	4500			TO247Plus	IXYS
IXFH14N100Q2	1000	14	0.9	2800	83	250	TO247	IXYS
IXFH15N100	1000	15,0	0,7000	4500			TO247	IXYS
IXFH15N100Q	1000	15	0,7	4500	130	250	TO247	IXYS
IXFX15N100	1000	15,0	0,7000	4500			TO247Plus	IXYS
IXFX21N100F	1000	21,0	0,5000	5500			TO247Plus	IXYS
IXFX21N100Q	1000	21	0,5	5900	170	250	TO247plus	IXYS
IXFX24N100	1000	24	0,39	7000	250	250	TO247plus	IXYS
IXFX24N100F	1000	24,0	0,9000	6600			TO247Plus	IXYS
IXTH3N120	1200	3	4.5	1100	42	700	TO247	IXYS
IXTH6N120	1200	6	2.4	1950	56	850	TO247	IXYS
IXTH12N120	1200	12	1.3	2660	90	850	TO247	IXYS
IXFX20N120	1200	20	0,75	7400	160	300	TO247plus	IXYS
IXFX24N120Q2	1200	24	0.52	7200	170	735	TO247plus	IXYS
2SK1271	1400	5,0	4,0000	1800			TO3P	NEC
IXBH5N140**	1400	5,0		350			TO247	IXYS
IXBH9N140 **	1400	9,0	—	550			TO247	IXYS
IXBH15N140 **	1400	15,0	—	1200			TO247	IXYS
IXBH20N140 **	1400	20,0	—	2100			TO247	IXYS
IXBH40N140 **	1400	40,0	—	3300			TO247	IXYS
2SK3746	1500	2,0	13,0000	400			TO3P	Sanyo
2SK1317	1500	2,5	12,000	990			TO3P	Renesas
2SK1835	1500	4,0	7,0000	1700			TO3P	Renesas
IXBH5N160**	1600	5,0		350			TO247	IXYS
IXBH9N160 **	1600	9,0	—	550			TO247	IXYS
IXBH15N160 **	1600	15,0	—	1200			TO247	IXYS
IXBH20N160 **	1600	20,0	—	2100			TO247	IXYS
IXBH40N160 **	1600	40,0	—	3300			TO247	IXYS
IXBH16N170A **	1700	16,0	—	1400			TO247	IXYS
IXBH16N170 **	1700	25,0	—	1700			TO247	IXYS

* = Avalanche Guarantee
Q = Low Gate Charge

** = BI-Mosfet
° = Fast Diode

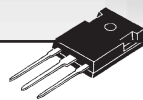
IXFH/IXFK = trr 100-250nS
F = RF FET

IXF... = Avalanche Diode
P = Polar Fet

MOSFET N-Channel

T0247iso

T03PF



Device	V _{DSS} V	I _D A	R _{DS(on)} Ω max V _{GS} =10V	C _{iss} pF/nc	Qg nC	t _{rr} ns	Package	Manufacturer
IXFR180N07	70	180*	0,006	9400	420	250	TO247isoplus	IXYS
IXFR180N085	85	180*	0,007	9100	320	250	TO247isoplus	IXYS
FQAF33N10	100	25,0	0,0520	62			TO3PF	FAIRCHILD
FQAF55N10	100	41,9	0,0260				TO3PF	FAIRCHILD
IXFR75N10Q	100	75,0	0,0200	3700			TO247isoplus	IXYS
IXFR80N10Q	100	80,0	0,0150	4500			TO247isoplus	IXYS
IXFR180N10	100	165*	0,008	9400	400	250	TO247isoplus	IXYS
IXFR150N15	150	105*	0,0125	9100	360	250	TO247isoplus	IXYS
FQAF34N20	200	23,0	0,0750	55			TO3PF	FAIRCHILD
IXFR58N20Q	200	50	0,04	3600	98	200	TO247isoplus	IXYS
IXFR80N20Q	200	80,0	0,0280	4600			TO247isoplus	IXYS
IXFR90N20Q	200	90,0	0,0220	—			TO247isoplus	IXYS
IXFR120N20	200	105	0,017	9100	360	250	TO247isoplus	IXYS
FQAF28N15	250	21,5	0,0850				TO3PF	FAIRCHILD
FQAF40N25	250	24,0	0,0700	63			TO3PF	FAIRCHILD
IXFR100N25	250	100,0	0,0270	—			TO247isoplus	IXYS
IXFR52N30Q	300	52,0	0,0600	—			TO247isoplus	IXYS
IXFR90N30	300	75	0,033	10000	360	250	TO247isoplus	IXYS
2SK1328	450	12,0	0,5500	1450			TO3PF	Renesas
2SK3254	500	10,0	1,0000	880			TO3PF	SANYO
2SK1329	500	12,0	0,6600	1450			TO3PF	Renesas
IXFR26N50Q	500	24	0,2	3900	95	250	TO247isoplus	IXYS
IXFR40N50Q2	500	29	0,14	4550	110	250	TO247isoplus	IXYS
IXFR32N50Q	500	32,0	0,1500	—			TO247isoplus	IXYS
IXFR48N50Q	500	40	0,1	6400	190	250	TO247isoplus	IXYS
IXFR40N50Q2	500	40,0	0,14	4550			TO247isoplus	IXYS
IXFR50N50	500	43	0,1	9400	330	250	TO247isoplus	IXYS
IXFR55N50	500	48	0,08	9400	330	250	TO247isoplus	IXYS
IXFR48N50Q	500	48,0	0,1000	—			TO247isoplus	IXYS
IXFR55N50F	500	50,0	0,0850	6700			TO247isoplus	IXYS
IXFR66N50Q2	500	50,0	0,074	6800	199	250	TO247isoplus	IXYS
IXFK66N50Q2	500	66	0,074	6800	199	250	TO247isoplus	IXYS
IXFB80N50Q2	500	80	0,06	11400	290	250	TO247isoplus	IXYS
2SK3249	600	8,0	1,2000	1050			TO3PF	SANYO
FQAF19N60	600	11,2	0,3800	30			TO3PF	FAIRCHILD
IXFR26N60Q	600	23	0,25	5100	150	250	TO247isoplus	IXYS
IXKR 40N60C	600	38	0,070	8900	250		TO247isoplus	IXYS
FQAF8N80	800	5,5	1,2000				TO3PF	FAIRCHILD
IXFR9N80Q	800	9,0	1,1000	—			TO247isoplus	IXYS
FQAF10N80	800	9,8	1,0500				TO3PF	FAIRCHILD
FQAF13N80	800	10,0	0,7200				TO3PF	FAIRCHILD
IXFR13N80Q	800	13,0	0,6000	—			TO247isoplus	IXYS
IXKR 25N80C	800	25	0,150		170		TO247isoplus	IXYS
IXFR27N80Q	800	27,0	0,3100	—			TO247isoplus	IXYS
IXFR34N80	800	28	0,24	7500	270	250	TO247isoplus	IXYS
IXFR34N80	800	34,0	0,2400	—			TO247isoplus	IXYS
2SK3259	900	5,0	2,8000	1100			TO3PF	SANYO
2SK1859	900	6,0	3,0000	980			TO3PF	Renesas
2SK1775	900	8,0	1,6000	1730			TO3PF	Renesas
2SK3261	900	10,0	1,4000	2200			TO3PF	SANYO
IXFR24N90Q	900	24,0	0,4000	—			TO247isoplus	IXYS
IXFR25N90	900	25,0	0,3300	—			TO247isoplus	IXYS
IXFR4N100Q	1000	3,5	3	1050	39	200	TO247isoplus	IXYS
IXFR10N100F	1000	9,0	1,2000	—			TO247isoplus	IXYS
IXFR10N100	1000	9,0	1,2000	—			TO247isoplus	IXYS
IXFR21N100Q	1000	18	0,5	5900	170	250	TO247isoplus	IXYS
IXFR24N100	1000	22	0,39	7000	250	250	TO247isoplus	IXYS
2SK2225	1500	2,0	12,0000	990			TO3PF	Renesas
2SK1413	1500	2,0	13,0000	550			TO3PF	Sanyo
2SK3747	1500	2,0	13,0000	400			TO3PF	Sanyo
2SK3748	1500	4,0	7,5000	800			TO3PF	Sanyo

* = Avalanche Guarantee
Q = Low Gate Charge

** = BI-Mosfet
o = Fast Diode

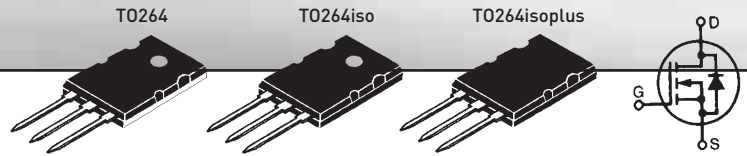
IXFH/IXFK = t_{rr} 100-250ns
F = RF FET

IXF... = Avalanche Diode
P = Polar Fet

MOSFET



MOSFET N-Channel



Device	V _{DSS} V	I _D A	R _{DS(on)} Ω max V _{GS} =10V	C _{iss} pF/nc	Qg nC	t _{rr} ns	Package	Manufacturer
IXFK110N07	70	110,0	0,0060	9000			TO264	IXYS
IXFK180N07	70	180*	0,006	9400	420	250	TO264	IXYS
IXFK180N085	85	180*	0,007	9100	320	250	TO264	IXYS
IXFK80N10 Q	100	80,0	0,0150	5600			TO264	IXYS
IXFK170N10	100	170,0	0,0100	10300			TO264	IXYS
IXTK250N10*	100	250	0.005	7800	390	150	TO264	IXYS
IXFK180N10	100	180*	0,008	9100	360	250	TO264	IXYS
IXTK128N15*	150	128	0.015	6000	240	250	TO264	IXYS
IXFK150N15	150	150	0,0125	9100	360	250	TO264	IXYS
IXTK180N15*	150	180*	0.09	9200	400	270	TO264	IXYS
IXFK80N20	200	80,0	0,0300	—			TO264	IXYS
IXFK80N20 Q	200	80,0	0,0280	5000			TO264	IXYS
IXFK88N20Q	200	88	0,028	5250	149	200	TO264	IXYS
IXFK90N20	200	90,0	0,0220	—			TO264	IXYS
IXFK90N20Q	200	90	0,022	6800	190	200	TO264	IXYS
IXFK100N10	200	100,0	0,0120	9000			TO264	IXYS
IXFK120N20	200	120	0,017	9100	300	250	TO264	IXYS
IXTK160N20*	200	160*	0.014	7800	390	250	TO264	IXYS
IXFK60N25Q	250	60,0	0,0470	—			TO264	IXYS
IXTK80N25*	250	80	0.035	6000	240	300	TO264	IXYS
IXFK100N25	250	100,0	0,0270	—			TO264	IXYS
IXTK100N25P	250	100*	27	6300	185	200	TO264	IXYS
IXFK120N25	250	120	0,022	9400	400	250	TO264	IXYS
IXTK120N25*	250	120*	0.018	9400	400	350	TO264	IXYS
IXTK 82N25P	250	82*	33	3500	105	200	TO264	IXYS
IXFK52N30 Q	300	52,0	0,0600	5600			TO264	IXYS
IXFK73N30	300	73,0	0,0450	—			TO264	IXYS
IXFK73N30Q	300	73	0,042	3400	190	250	TO264	IXYS
IXTK75N30	300	75	0.045	6000	240	360	TO264	IXYS
IXFK90N30	300	90	0,033	10000	360	250	TO264	IXYS
IXTK110N30*	300	110	0.025	7800	390	350	TO264	IXYS
IXTK 102N30P	300	102*	33	7500	224	250	TO264	IXYS
2SK1520 °	500	30,0	0,1600	5800			TO264	Renesas
IXFK32N50Q	500	32,0	0,1500	—			TO264	IXYS
IXFK33N50	500	33,0	0,1600	5680			TO264	IXYS
2SK1527 *	500	40,0	0,1600	5800			TO264	Renesas
IXFK44N50	500	44,0	0,1200	8400			TO264	IXYS
IXFK44N50F	500	44,0	0,1200	8400			TO264	IXYS
IXFK48N50	500	48,0	0,1000	8400			TO264	IXYS
IXFK48N50Q	500	48	0,1	8000	190	250	TO264	IXYS
IXFL55N50	500	48,0	0,0800	330			TO264iso	IXYS
IXFG550N50	500	48,0	0,0850	330			TO264iso	IXYS
IXFK50N50	500	50,0	0,1000	9400			TO264	IXYS
2SK1522°	500	50,0	0,1100	8700			TO3PL	Renesas
H5N5004PL°	500	50,0	0,1100	—			TO3PL	Renesas
H5N5011PL°	500	50,0	0,1150	—			TO3PL	Renesas
IXFK55N50F	500	55,0	0,0800	9400			TO264	IXYS
IXFK55N50	500	55	0,08	9400	330	250	TO264	IXYS
IXFK60N55Q2	500	60,0	0,0880	6900			TO264	IXYS
H5N5005PL°	500	60,0	0,0750	—			TO3PL	Renesas

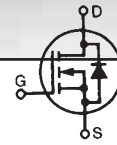
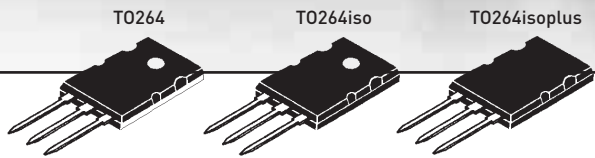
* = Avalanche Guarantee
Q = Low Gate Charge

** = BI-Mosfet
° = Fast Diode

IXFH/IXFK = t_{rr} 100-250nS
F = RF FET

IXF... = Avalanche Diode
P = Polar Fet

MOSFET N-Channel



Device	V _{DSS} V	I _D A	R _{DS(on)} Ω max V _{GS} =10V	C _{iss} pF/nc	Qg nC	t _{rr} ns	Package	Manufacturer
IXFK66N50Q2	500	66,0	0,0740	6800			TO264	IXYS
IXFL75N50	500	70,0	0,0550	380			TO264iso	IXYS
IXFB72N55Q2	500	72,0	0,0720	7200			TO264plus	IXYS
IXFB80N50Q2	500	80,0	0,0600	11400			TO264plus	IXYS
IXFK44N55Q	550	44	0,12	6400	190	250	TO264	IXYS
IXFK60N55Q2	550	60	0,088	6900	200	250	TO264	IXYS
IXFB72N55Q2	550	72	0,072	10500	258	250	TO264plus	IXYS
IXFK26N60Q	600	28	0,25	5100	150	250	TO264	IXYS
IXFK32N60	600	32,0	0,2500	9000			TO264	IXYS
H5N6004PL°	600	40,0		—			TO3PL	Renesas
IXFK44N60	600	44	0,13	8900	330	250	TO264	IXYS
IXFL44N60	600	44	0,13	8900	330	250	TO264isoplus	IXYS
IXFK52N60Q2	600	52	0,115	6800	198	250	TO264	IXYS
IXFL60N60	600	55,0	0,0800	380			TO264isoplus	IXYS
IXFL60N60	600	60	0,08	15000	380	250	TO264isoplus	IXYS
IXFB70N60Q2	600	70	0,08	7200	265	250	TO264plus	IXYS
IXKK85N60C	600	85	0,036		500		TO264	IXYS
IXFK20N80Q	800	20,0	0,4200	—			TO264	IXYS
IXFK27N80Q	800	27	0,32	7600	170	250	TO264	IXYS
IXFK34N80	800	34	0,24	7500	270	250	TO264	IXYS
IXFL44N80	800	44	0,165	10000	380	250	TO264isoplus	IXYS
IXFB50N80Q2	800	50,0	0,1500	7200			TO264plus	IXYS
IXFB50N80Q2	800	50	0,15	7200	260	300	TO264plus	IXYS
IXFK16N90Q	900	16	0,65	4000	133	250	TO264	IXYS
IXFK24N90Q	900	24	0,45	5900	170	250	TO264	IXYS
IXFK25N90	900	25,0	0,3300	—			TO264	IXYS
IXFK26N90	900	26	0,3	8,7 nF	240	250	TO264	IXYS
IXFL39N90	900	35,0	0,2500	390			TO264isoplus	IXYS
IXFL39N90	900	39	0,22	9200	390	250	TO264isoplus	IXYS
IXFK15N100Q	1000	15	0,7	4500	130	250	TO264	IXYS
IXFK21N100F	1000	21,0	0,5000	5500			TO264	IXYS
IXFK21N100Q	1000	21	0,5	5900	170	250	TO264	IXYS
IXFK24N100F	1000	24,0	0,3900	6600			TO264	IXYS
IXFK24N100	1000	24	0,39	7000	250	250	TO264	IXYS
IXFL32N100F	1000	30,0	0,2600				TO264isoplus	IXYS
IXFL32N100	1000	30,0	0,2800	380			TO264isoplus	IXYS
IXFL34N100	1000	34	0,28	9200	380	180	TO264isoplus	IXYS
IXFB38N100Q2	1000	38	0,25	12600	230	300	TO264plus	IXYS
IXFK20N120	1200	20	0,75	7400	160	300	TO264	IXYS
IXFK24N120Q2	1200	24	0,52	7200	170	735	TO264	IXYS
IXFB30N120Q2	1200	30	0,38	12600	230	890	TO264plus	IXYS
2SK2393	1500	8,0	2,8000	4370			TO264	Renesas
2SK2349	1500	10,0	3,5000	2900			TO264	Sanyo

MOSFET

* = Avalanche Guarantee
Q = Low Gate Charge

** = BI-Mosfet
° = Fast Diode

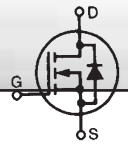
IXFH/IXFK = t_{rr} 100-250ns
F = RF FET

IXF... = Avalanche Diode
P = Polar Fet



MOSFET N-Channel

T0268



Device	V _{DSS} V	I _D A	R _{DS(on)} Ω max V _{GS} =10V	C _{iss} pF/nc	Q _g nC	trr ns	Package	Manufacturer
IXFT80N085	85	80	0,009	4800	180	200	TO268	IXYS
IXTT60N10	100	60	0.2	3200	110	150	TO268	IXYS
IXTT75N10	100	75	0.2	4500	180	300	TO268	IXYS
IXFT80N10Q	100	80,0	0,0150	4500	180	200	TO268	IXYS
IXTT 110N10P	100	100*	13	3500	110	120	TO268	IXYS
IXTT 140N10P	100	140*	9.5	4900	160	120	TO268	IXYS
IXFT70N15	150	70,0	0,0280	—			TO268	IXYS
IXTT88N15*	150	88	0.022	4000	170	150	TO268	IXYS
IXTT 96N15P	150	96*	23	3500	105	150	TO268	IXYS
IXFT58N20Q	200	58	0,04	3600	98	200	TO268	IXYS
IXFT60N20	200	60	0,033	5200	155	250	TO268	IXYS
IXFT66N20Q	200	66	0,04	3700	105	200	TO268	IXYS
IXTT 74N20P	200	74	34	3300	107	160	TO268	IXYS
IXTT 96N20P	200	96*	24	4800	145	160	TO268	IXYS
IXTT 64N25P	250	64	48	3500	105	160	TO268	IXYS
IXTT 82N25P	250	82*	33	4800	142	200	TO268	IXYS
IXTT 100N25P	250	100*	27	6300	185	200	TO268	IXYS
IXFT40N30Q	300	40	0,08	3100	95	250	TO268	IXYS
IXFJ40N30	300	40	0,085	4800	177	200	TO268	IXYS
IXFT52N30Q	300	52,0	0,0600	—			TO268	IXYS
IXTT 52N30P	300	52	66	3490	110	250	TO268	IXYS
IXTT 69N30P	300	69	46	4960	156	250	TO268	IXYS
IXTT 88N30P	300	88*	40	6300	180	250	TO268	IXYS
IXFT30N40Q	400	30	0,16	3300	95	250	TO268	IXYS
IXFT21N50Q	500	21	0,25	3350	90	250	TO268	IXYS
IXTT24N50Q	500	24	0.24	3000	82	500	TO268	IXYS
IXTT28N50Q	500	25	0.2	3300	94	500	TO268	IXYS
IXFT26N50Q	500	26	0,2	3900	95	250	TO268	IXYS
IXFT28N50F	500	28,0	0,1900	3000			TO268	IXYS
IXFT28N50Q	500	28	0,2	3300	94	250	TO268	IXYS
IXFT32N50	500	32,0	0,1500	—			TO268	IXYS
IXFT40N50Q	500	40	0,14	4500	130	250	TO268	IXYS
IXFT20N60Q	600	20	0,35	3700	95	250	TO268	IXYS
IXFT23N60Q	600	23	0,32	3300	90	250	TO268	IXYS
IXFT26N60Q	600	28	0,25	5100	150	250	TO268	IXYS
IXFT30N60Q	600	30	0,23	4700	124	250	TO268	IXYS
IXFT9N80Q	800	9	1,1	2200	56	250	TO268	IXYS
IXFT13N80Q	800	13	0,7	3250	90	250	TO268	IXYS
IXFT15N80Q	800	15,0	0,6000	—			TO268	IXYS
IXFT17N80Q	800	17	0,6	4300	88	250	TO268	IXYS
IXFT20N80Q	800	20,0	0,4200	—			TO268	IXYS
IXFT23N80Q	800	23	0,4	5100	120	250	TO268	IXYS
IXFT7N90Q	900	7	1,5	2200	56	250	TO268	IXYS
IXFT12N90Q	900	12	0,9	2900	90	200	TO268	IXYS
IXFT16N90Q	900	16	0,65	4000	133	250	TO268	IXYS
IXTT1N100	1000	0,1	11	480	23	710	TO268	IXYS
IXFT4N100Q	1000	4,0	3,0000	—			TO268	IXYS
IXFT4N100Q	1000	4	3	1050	39	250	TO268	IXYS
IXFT6N100F	1000	6,0	1,9000	1870			TO268	IXYS
IXFT6N100Q	1000	6	2	2200	48	250	TO268	IXYS
IXFT10N100	1000	10,0	1,2000	—			TO268	IXYS
IXFT12N100	1000	12,0	1,0500	2700			TO268	IXYS
IXFT12N100Q	1000	12,0	1,0000	2700			TO268	IXYS
IXFT12N100F	1000	12,0	1,0000	2700			TO268	IXYS
IXFT13N100	1000	13,0	0,9000	—			TO268	IXYS
IXFT14N100	1000	14,0	0,7500	—			TO268	IXYS
IXFT15N100Q	1000	15	0,7	4500	130	250	TO268	IXYS
IXTT6N120	1200	6	2.4	1950	56	850	TO268	IXYS
IXBT16N170A **	1700	16,0	—	1400			TO268	IXYS
IXBT16N170 **	1700	25,0	—	1700			TO268	IXYS

* = Avalanche Guarantee
Q = Low Gate Charge

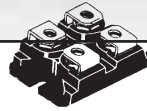
** = BI-Mosfet
o = Fast Diode

IXFH/IXFK = trr 100-250nS
F = RF FET

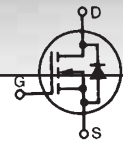
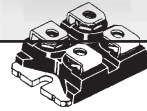
IXF... = Avalanche Diode
P = Polar Fet

MOSFET N-Channel

SOT227
miniBLOC isoliert



SOT227
miniBLOC



Device	Channel	V_{GS} V	I_b A	$R_{DS(on)}$ $V_{GS}=10V$ Ω_{max}	P_D W	C_{gs} pF,tc	Package	Manufacturer
IXFN200N07	70	200,0	0,0060	9000			SOT227B	IXYS
IXFN280N07	70	280*	0,005	9400	420	200	SOT227B	IXYS
IXFN340N07	70	340*	0,004	12200	490	200	SOT227B	IXYS
IXFN280N085	85	280*	0,0044	16000	600	250	SOT227B	IXYS
IXFN100N10	100	100,0	0,0150	9000			SOT227B	IXYS
IXFN150N10	100	150,0	0,0120	9000			SOT227B	IXYS
IXFN170N10	100	170,0	0,0100	9000			SOT227B	IXYS
IXFN180N10	100	180*	0,008	9100	360	250	SOT227B	IXYS
IXFN230N10	100	230*	0,0065	21000	690	250	SOT227B	IXYS
IXFN150N15	150	150	0,0125	9100	360	250	SOT227B	IXYS
IXFN100N20	200	100,0	0,0230	9000			SOT227B	IXYS
IXFN106N20	200	106,0	0,0200	9000			SOT227B	IXYS
IXFN110N20	200	110,0	0,0200	9500			SOT227B	IXYS
IXFN120N20	200	120	0,017	9100	360	250	SOT227B	IXYS
IXFN180N20	200	180	0,01	22000	660	250	SOT227B	IXYS
IXFN100N25	250	100,0	0,0270	—			SOT227B	IXYS
IXFN73N30	300	73,0	0,0450	9000			SOT227B	IXYS
IXFN73N30Q	300	73	0,042	6400	190	250	SOT227B	IXYS
IXFN90N30	300	90	0,033	10000	360	250	SOT227B	IXYS
IXFN130N30	300	130	0,018	15500	555	180	SOT227B	IXYS
IXFN44N50	500	44,0	0,1200	8400			SOT227B	IXYS
IXFN44N50U2	500	44,0	0,1200	8400			SOT227B	IXYS
IXFN44N50U3	500	44,0	0,1200	8400			SOT227B	IXYS
IXFN48N50	500	48,0	0,1000	8400			SOT227B	IXYS
IXFN48N50U2	500	48,0	0,1000	8400			SOT227B	IXYS
IXFN48N50U3	500	48,0	0,1000	8400			SOT227B	IXYS
IXFN48N50Q	500	48	0,1	6400	190	250	SOT227B	IXYS
IXFN50N50	500	50,0	0,1000	9400			SOT227B	IXYS
IXFN55N50F	500	55,0	0,0850	6700			SOT227B	IXYS
IXFN55N50	500	55	0,08	9400	330	250	SOT227B	IXYS
IXFN58N50	500	58,0	0,0800	11000			SOT227B	IXYS
IXFN61N50	500	61,0	0,0750	11000			SOT227B	IXYS
IXFN66N50Q2	500	66	0,074	6800	199	250	SOT227B	IXYS
IXFN80N50	500	80	0,05	9890	380	250	SOT227B	IXYS
IXFN80N50Q2	500	80	0,06	11400	290	250	SOT227B	IXYS
IXFN72N55Q2	550	72	0,072	10500	258	250	SOT227B	IXYS
IXFN32N60	600	32,0	0,2500	9000			SOT227B	IXYS
IXFN36N60	600	36,0	0,1800	9000			SOT227B	IXYS
IXKN40N60C	600	40	0,070		250		SOT227B	IXYS
IXFN60N60	600	60	0,08	15000	380	250	SOT227B	IXYS
IXFN70N60Q2	600	70	0,08	7200	265	250	SOT227B	IXYS
IXKN75N60C	600	75	0,036		500		SOT227B	IXYS
IXFN27N80	800	27,0	0,3200	8400			SOT227B	IXYS
IXFN27N80Q	800	27	0,32	7600	170	250	SOT227B	IXYS
IXFN34N80	800	34	0,24	7500	270	250	SOT227B	IXYS
IXFN44N80	800	44	0,165	10000	380	250	SOT227B	IXYS
IXKN45N80C	800	45	0,075		335		SOT227B	IXYS
IXFN50N80Q2	800	50	0,15	7200	265	250	SOT227B	IXYS
IXFN24N90Q	900	24,0	0,4000	—			SOT227B	IXYS
IXFN25N90	900	25,0	0,3300	—			SOT227B	IXYS

Q/Q2 = low gate charge

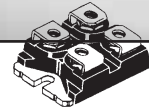
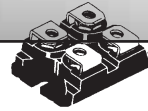
MOSFET



MOSFET N-Channel

SOT227
miniBLOC isoliert

SOT227
miniBLOC

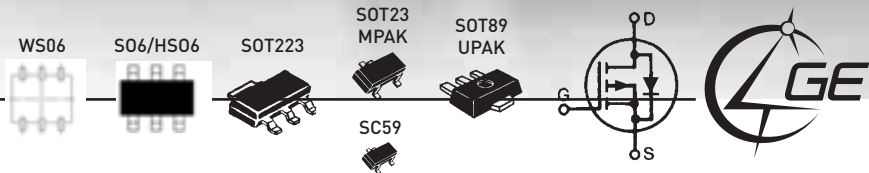


MOSFET

Device	V _{DSS} V	I _D A	R _{DS(on)} Ω max V _{GS} =10V	C _{iss} pF/nc	Q _g nC	t _{rr} ns	Package	Manufacturer
IXFN26N90	900	26	0,3	8.7 nF	240	250	SOT227B	IXYS
IXFN39N90	900	39	0,22	9200	390	250	SOT227B	IXYS
IXFN21N100Q	1000	21	0,5	5900	170	250	SOT227B	IXYS
IXFN24N100F	1000	24,0	0,3900	6600			SOT227B	IXYS
IXFN24N100	1000	24	0,39	7000	250	250	SOT227B	IXYS
IXFN34N100	1000	34	0,28	9200	380	180	SOT227B	IXYS
IXFN36N100	1000	36	0,24	9200	380	180	SOT227B	IXYS
IXFN38N100Q2	1000	38	0.25	12600	230	300	SOT227B	IXYS
IXFN20N120	1200	20	0,75	7400	160	300	SOT227B	IXYS
IXFN30N120Q2	1200	30	0.38	12600	230	890	SOT227B	IXYS
IXFN32N120	1200	32	0,35	15900	400	180	SOT227B	IXYS
IXFE180N10	100	176	0,008	9100	360	250	SOT227iso	IXYS
IXFE180N20	200	158*	0,012	14400	360	250	SOT227iso	IXYS
IXFE73N30Q	300	66	0,046	6400	190	250	SOT227iso	IXYS
IXFE44N50Q	500	39,0	0,1200		190		SOT227iso	IXYS
IXFE44N50QD2	500	39,0	0,1200		190		SOT227iso	IXYS
IXFE44N50QD3	500	39,0	0,1200		190		SOT227iso	IXYS
IXFE48N50QD2	500	41,0	0,1100		190		SOT227iso	IXYS
IXFE48N50QD3	500	41,0	0,1100		190		SOT227iso	IXYS
IXFE48N50Q	500	41	0,11	6400	190	250	SOT227iso	IXYS
IXFE48N50QD2	500	41	0,11	8000	190	35	SOT227iso	IXYS
IXFE48N50QD3	500	41	0,11	6400	190	250	SOT227iso	IXYS
IXFE50N50	500	47	0,1	9400	330	180	SOT227iso	IXYS
IXFE55N50	500	52	0,09	9400	330	180	SOT227iso	IXYS
IXFE80N50	500	72	0,055	9890	380	250	SOT227iso	IXYS
IXFE44N60	600	41	0,13	8900	330	250	SOT227iso	IXYS
IXFE39N90	900	34	0,22	9200	375	250	SOT227iso	IXYS
IXFE23N100	1000	21	0,43	7000	250	250	SOT227iso	IXYS
IXFE24N100	1000	22	0,39	7000	250	250	SOT227iso	IXYS
IXFE34N100	1000	30	0,28	15000	455	180	SOT227iso	IXYS
IXFE36N100	1000	33	0,24	9200	380	180	SOT227iso	IXYS

Q/Q2 = low gate charge
 QD2 = boost configuration
 QD3 = buck configuration
 F = RF Fet

MOSFET P-Channel



Device	V _{DSS} V	I _D A	R _{DS(on)} V _{GS} =10V Ω max	P _D W	C _{ISS} pF/nc	Package	Manufacturer
2SJ621	-12	-3,5	0,044			SOT23	NEC
2SJ625	-20	-3,3	0,113			SOT23	NEC
2SJ624	-20	-4,5	0,044			SOT23	NEC
3LP01C	-30	-0,1	10,400			SOT23	SANYO
3LP02C	-30	-0,2	3,100			SOT23	SANYO
2SJ486	-30	-0,3	1,200		45	SOT23	Renesas
2SJ557	-30	-2,5	0,155			SOT23	NEC
5HP01C	-50	-0,07	22,000			SOT23	SANYO
5LP01C	-50	-0,07	23,000			SOT23	SANYO
5HP02C	-50	-0,14	6,100			SOT23	SANYO
5LP02C	-50	-0,14	6,600			SOT23	SANYO
2SJ452	-50	-0,2	12,000		1,1	SOT23	Renesas
2SJ626	-60	-1,5	0,388			SOT23	NEC
2SJ462	-12	-2,5	4V / 0,19			SOT223	NEC
2SJ357	-30	-3	0,200			SOT223	NEC
2SJ358	-60	-3	0,300			SOT223	NEC
2SJ205	-16	-0,5	5,000			SOT89	NEC
2SJ207	-16	-1	4,000			SOT89	NEC
2SJ208	-16	-2	3,000			SOT89	NEC
2SJ451	-20	-0,2	4V / 3,5			SOT89	Renesas
2SJ399	-30	-0,2	7,000			SOT89	Renesas
2SJ486	-30	-0,3	1,200			SOT89	Renesas
2SJ206	-30	-0,5	4,000	2		SOT89	NEC
2SJ179	-30	-0,5	1,500			SOT89	NEC
2SJ484	-30	-2	0,230		200	SOT89	Renesas
2SJ355	-30	-2	0,600			SOT89	NEC
2SJ557	-30	-2,5	0,2000			SOT89	NEC
2SJ452	-50	-0,2	4V / 7,0			SOT89	Renesas
2SJ212	-60	-0,5	4,000			SOT89	NEC
2SJ278	-60	-1	0,830		180	SOT89	Renesas
2SJ450	-60	-1	1,900		150	SOT89	Renesas
2SJ197	-60	-1	1,500			SOT89	NEC
2SJ518	-60	-2	0,460		460	SOT89	Renesas
2SJ356	-60	-2	0,950	2	—	SOT89	NEC
2SJ213	-100	-0,5	5,000	2	—	SOT89	NEC
2SJ199	-100	-1	2,000	2	—	SOT89	NEC
2SJ213	-100	-5	5,000	2	—	SOT89	NEC
μPA1952TE	-12 / -12	-2	0,135/0,135			SO6	NEC
μPA1951TE	-12 / -12	-2,5	0,088/0,088			SO6	NEC
μPA1950TE	-12 / -12	-4,5	0,130/0,130			SO6	NEC
μPA1916TE	-12	-4,5	0,039			SO6	NEC
μPA1911ATE	-20	-2,5	0,115			SO6	NEC
μPA1915TE	-20	-4,5	0,055			SO6	NEC
μPA1917TE	-20	-6	0,053			SO6	NEC
μPA1914TE	-30	-4,5	0,057			SO6	NEC
μPA1918TE	-60	-3,5	0,179			SO6	NEC
uPA650TT	-12	-5	0,050			WSO6	NEC
UPA652TT	-20	-2	0,294			WSO6	NEC
UPA651TT	-20	-5	0,069			WSO6	NEC
UPA653TT	-30	-2,5	0,165			WSO6	NEC

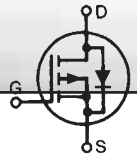
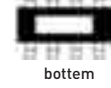


MOSFET P-Channel

S08

HSOP8

SS08



Device	V _{DSS} V	I _D A	R _{DS(on)} V _{GS} =10V Ω max	P _D W	C _{iss} pF/nc	Package	Manufacturer
UPA1816GR-9JG	-12	-9	0,015			SS08	NEC
UPA1851GR-9JG	-20 / -20	-2,5 / -2,5	0,011/0,1011	2		SS08	NEC
HAT1031T	-20 / -20	-2,5 / -2,5	0,200			SS08	Renesas
HAT1033T	-20	-3,5	0,130			SS08	Renesas
UPA1811GR-9JG	-20	-4	0,080	2	1160	SS08	NEC
UPA1856GR-9JG	-20 / -20	-4,5 / -4,5	0,065	2		SS08	NEC
UPA1858GR-9JG	-20 / -20	-5 / -5	0,025/0,025			SS08	NEC
FTS1011	-20 / -20	-6 / -6	4V / 0,025			SS08	SANYO
UPA1815GR-9JG	-20	-7	0,030	2		SS08	NEC
UPA1818GR-9JG	-20	-10	0,015			SS08	NEC
UPA1817GR-9JG	-20	-12	0,012			SS08	NEC
UPA1853GR-9JG	-30 / -30	-2,5 / -2,5	0,085/0,085	2	550	SS08	NEC
UPA1812GR-9JG	-30	-5	0,040	2	1400	SS08	NEC
UPA1814GR-9JG	-30	-7	0,019	2		SS08	NEC
UPA1830GR-9JG	-30	-9	0,017			SS08	NEC
UPA1819GR-9JG	-30	-12	0,012			SS08	NEC
HAT3008RJ	60/60	5/-3.5	0.07/0.16			S08	Renesas
HAT3010R	60/60	5/-3.5	0.03/0.052			S08	Renesas
UPA1790G	60/60	1,0/-1,0	0,26/0,26			S08	NEC
HAT3018RJ	60/60	6 / -5	0,035/076			S08	Renesas
UPA1792G	30/30	6,8/-6,8	0,026/0,026			S08	NEC
HAT3017R	30/30	3,8/-2,6	0.18/0.115			S08	Renesas
HAT3019R	100/-100	3.5/-2.3	0.115/0.30			S08	Renesas
HAT1031T	-20	-2,5	0,160			S08	Renesas
HAT1033T	-20	-3,5	0,063			S08	Renesas
UPA1750G	-20 / -20	-3,5 / -3,5	0,09/0,09			S08	NEC
HAT2025R	-20 / -20	-4,5 / -4,5	0,095			S08	Renesas
UPA1770G	-20 / -20	-6 / -6	0,037/0,037			S08	NEC
HAT1024R	-30 / -30	-2,5 / -2,5	0,16/0,16		350	S08	Renesas
FSS172	-30	-4,5	0,048			S08	SANYO
μPA1710A	-30	-5	0,070	2	840	S08	NEC
μPA1717	-30	-6	0,036	2		S08	NEC
HAT1026R	-30	-7	0,037		1700	S08	Renesas
μPA1714	-30	-7	0,040	2	1090	S08	NEC
UPA1772G	-30 / -30	-8 / -8	0,02/0,02			S08	NEC
μPA1716	-30	-8	0,016	2		S08	NEC
μPA1712	-30	-8	0,020	2	2700	S08	NEC
UPA1731G	-30	-10	0,013			S08	NEC
UPA2712GR	-30	-10	0,013			S08	NEC
μPA1715	-30	-11	0,012	2		S08	NEC
UPA1730G	-30	-13	0,010			S08	NEC
FSS163	-30	-20	0,013			S08	SANYO
UPA1774G	-60 / -60	-2,8 / -2,8	0,25/0,25			S08	NEC
HAT1038R	-60	-3,5	0,150		600	S08	Renesas
UPA2730TP	-30	-42	0,007			HSOP-8	NEC
UPA1730TP	-30	-28	0,010			HSOP-8	NEC

MOSFET

MOSFET P-Channel

T0251
IPAK



T0252
DPAK



T0252
4pin



Device	V_{DSS}	I_D	$R_{DS(on)}$		P_D	C_{iss}	Package	Manufacturer
	V		A	$V_{GS}=10V$				
2SJ324	-30	-2,00	0,250	20		330	TO251	NEC
2SJ325	-30	-4,00	0,110	20		800	TO251	NEC
2SJ506L	-30	-10,00	0,085	—		660	TO251	Renesas
2SJ326	-60	-2,00	0,370	20		320	TO251	NEC
2SJ327	-60	-4,00	0,170	20		750	TO251	NEC
HAF1004L *	-60	-5,00	0,190				TO251	Renesas
2SJ527L	-60	-5,00	0,400	—		220	TO251	Renesas
2SJ529L	-60	-10,00	0,160	—		580	TO251	Renesas
2SJ598	-60	-12,00					TO251	NEC
2SJ530L	-60	-15,00	0,100	—		—	TO251	Renesas
2SJ599	-60	-20,00					TO251	NEC
2SJ600	-60	-25,00					TO251	NEC
2SJ601	-60	-36,00					TO251	NEC
2SJ128	-100	-2,0					TO251	NEC
FQU12P10	-100	-9,70	0,290				TO251	FAIRCHILD
FQU3P20	-200	-2,40	2,700	37		7,5	TO251	FAIRCHILD
FQU5P20	-200	-3,70	1,400				TO251	FAIRCHILD
FQU7P20	-200	-5,70	0,690	55		25	TO251	FAIRCHILD
FQU2P25	-250	-2,00	4,000	37		6,5	TO251	FAIRCHILD
FQU4P25	-250	-3,00	2,100				TO251	FAIRCHILD
FQU6P25	-250	-4,70	1,100	55		20	TO251	FAIRCHILD
2SJ130L	-300	-1,00	8,500	20		235	TO251	Renesas
FQU2P40	-400	-1,56	6,500				TO251	FAIRCHILD
FQU4P40	-400	-2,70	3,100				TO251	FAIRCHILD
FQU1P50	-500	-1,20	10,500				TO251	FAIRCHILD
FQU3P50	-500	-2,10	4,900				TO251	FAIRCHILD
2SJ181L	-600	-0,50	0,250	—		220	TO251	Renesas
2SJ318S	-20	-5,00	0,130	—		580	TO252	Renesas
2SJ324-Z	-30	-2,00	0,250	20		330	TO252	NEC
2SJ325-Z	-30	-4,00	0,110	20		800	TO252	NEC
2SJ506S	-30	-10,00	0,085	—		660	TO252	Renesas
HAT1072H	-30	-40,00	0,045	30		9100	adv.TO252	Renesas
2SJ326-Z	-60	-2,00	0,370	20		320	TO252	NEC
2SJ327-Z	-60	-4,00	0,170	20		750	TO252	NEC
2SJ279S	-60	-5,00	0,200	—		670	TO252	Renesas
HAT 1004S	-60	-5,00	0,075				TO252	Renesas
SFR9024	-60	-7,80	0,280	32		465	TO252	FAIRCHILD
FQD11P06	-60	-9,40	0,185				TO252	FAIRCHILD
2SJ529S	-60	-10,00	0,160	—		580	TO252	Renesas
2SJ598-Z	-60	-12,00					TO252	NEC
SFR9034	-60	-14,00	0,140	49		890	TO252	FAIRCHILD
2SJ530S	-60	-15,00	0,100	—		—	TO252	Renesas
2SJ599-Z	-60	-20,00					TO252	NEC
2SJ600-Z	-60	-25,00					TO252	NEC
2SJ601-Z	-60	-36,00					TO252	NEC
2SJ128-Z-E1/E2	-100	-2,0					TO252	NEC
FQD5P10	-100	-3,60	1,050				TO252	FAIRCHILD
FQD8P10	-100	-6,70	0,530				TO252	FAIRCHILD
FQD12P10	-100	-9,70	0,290				TO252	FAIRCHILD
FQD3P20	-200	-2,40	2,700	37		7,5	TO252	FAIRCHILD
FQD5P20	-200	-3,70	1,400				TO252	FAIRCHILD
FQD7P20	-200	-5,70	0,690	55		25	TO252	FAIRCHILD
FQD2P25	-250	-2,70	4,000				TO252	FAIRCHILD
FQD4P25	-250	-3,00	2,100				TO252	FAIRCHILD
FQD6P25	-250	-4,70	1,100				TO252	FAIRCHILD
FQD2P40	-400	-1,50	6,500				TO252	FAIRCHILD
FQD4P40	-400	-2,70	3,100				TO252	FAIRCHILD
FQD3P50	-500	-2,10	4,900				TO252	FAIRCHILD
FQD1P50	-500	-12,00	10,500				TO252	FAIRCHILD

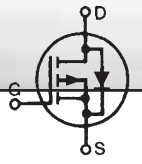
MOSFET



MOSFET P-Channel

T0262
I2PAK

T0263
D2PAK



Device	V _{DSS}	I _D	R _{DS(on)}	P _D	C _{iss}	Package	Manufacturer
	V	A	V _{GS} =10V Ω max	W	pF/nc		
HAF1003L *	-60	-5,00	0,090			TO262	Renesas
FQI7P06	-60	-7,00	0,410			TO262	FAIRCHILD
FDD5202P	-60	-8,00	0,300	39	560	TO262	FAIRCHILD
2SJ302-S	-60	-14,0				TO262	NEC
HAF1002L *	-60	-15,00	0,090	—	—	TO262	Renesas
2SJ302-S	-60	-16,00	0,100	60	1200	TO262	NEC
2SJ552L	-60	-20,00	0,055	—	1750	TO262	Renesas
2SJ492-S	-60	-20,00	0,100	70	1210	TO262	NEC
2SJ328-S	-60	-20,00	0,600	75	2150	TO262	NEC
2SJ602-S	-60	-20,00				TO262	NEC
2SJ603-S	-60	-25,00				TO262	NEC
2SJ553L	-60	-30,00	0,037	—	2500	TO262	Renesas
HAF 1009L *	-60	-40,00	0,027			TO262	Renesas
2SJ604-S	-60	-45,00				TO262	NEC
2SJ505L	-60	-50,00	0,026	—	4700	TO262	Renesas
2SJ605-S	-60	-63,00				TO262	NEC
2SJ606-S	-60	-83,00				TO262	NEC
2SJ607-S	-60	-83,00				TO262	NEC
FQI5P10	-100	-4,50	1,050			TO262	FAIRCHILD
FQI8P10	-100	-8,00	0,530			TO262	FAIRCHILD
FQI12P10	-100	-11,50	0,290			TO262	FAIRCHILD
FQI17P10	-100	-16,50	0,190			TO262	FAIRCHILD
FQI22P10	-100	-22,00	0,125			TO262	FAIRCHILD
FQI3P20	-200	-2,80	2,700	52	7,5	TO262	FAIRCHILD
FQI5P20	-200	-4,80	1,400			TO262	FAIRCHILD
FQI7P20	-200	-7,30	0,690	90	25	TO262	FAIRCHILD
FQI12P20	-200	-11,50	0,470			TO262	FAIRCHILD
FQI2P25	-250	-2,30	4,000	52	6,5	TO262	FAIRCHILD
FQI4P25	-250	-4,00	2,100			TO262	FAIRCHILD
FQI6P25	-250	-6,00	1,100	90	20	TO262	FAIRCHILD
FQI9P25	-250	-9,40	0,620			TO262	FAIRCHILD
FQI2P40	-400	-2,00	6,500			TO262	FAIRCHILD
FQI4P40	-400	-3,50	3,100			TO262	FAIRCHILD
FQI1P50	-500	-1,50	10,500			TO262	FAIRCHILD
FQI3P50	-500	-2,70	4,900			TO262	FAIRCHILD
HAF1003S *	-60	-5,00	0,090			TO263	Renesas
FQB7P06	-60	-7,00	0,410			TO263	FAIRCHILD
FQB11P06	-60	-11,40	0,175			TO263	FAIRCHILD
HAF 1002S *	-60	-15,00	0,090	—	—	TO263	Renesas
2SJ302-ZJ	-60	-16,00	0,100	60	1200	TO263	NEC
2SJ328-ZJ	-60	-20,00	0,060	75	2150	TO263	NEC
2SJ492-ZJ	-60	-20,00	0,100	70	1210	TO263	NEC
2SJ602-Z	-60	-20,00				TO263	NEC
2SJ603-Z	-60	-25,00				TO263	NEC
2SJ553S	-60	-30,00	0,037	—	2500	TO263	Renesas
HAF 1009S *	-60	-40,00	0,027			TO263	Renesas
2SJ604-Z	-60	-45,00				TO263	NEC
2SJ505S	-60	-50,00	0,026	—	4700	TO263	Renesas
2SJ605-Z	-60	-63,00				TO263	NEC
2SJ606-Z	-60	-83,00				TO263	NEC
2SJ607-Z	-60	-83,00				TO263	NEC
FQB5P10	-100	-4,50	1,050			TO263	FAIRCHILD
FQB8P10	-100	-8,00	0,530			TO263	FAIRCHILD
FQB12P10	-100	-11,50	0,290			TO263	FAIRCHILD
FQB17P10	-100	-16,50	0,190			TO263	FAIRCHILD
FQB22P10	-100	-22,00	0,125			TO263	FAIRCHILD
FQB3P20	-200	-2,80	2,700	52	7,5	TO263	FAIRCHILD
FQB5P20	-200	-4,80	1,400			TO263	FAIRCHILD
SFW9630	-200	-6,50	0,800	70	740	TO263	FAIRCHILD
FQB7P20	-200	-7,30	0,690	90	25	TO263	FAIRCHILD
FQB12P20	-200	-11,50	0,470			TO263	FAIRCHILD
FQB2P25	-250	-2,30	4,000	52	6,5	TO263	FAIRCHILD
FQB4P25	-250	-4,00	2,100			TO263	FAIRCHILD
FQB6P25	-250	-6,00	1,100	90	20	TO263	FAIRCHILD
FQB9P25	-250	-9,40	0,620			TO263	FAIRCHILD
FQB2P40	-400	-2,00	6,500			TO263	FAIRCHILD
FQB4P40	-400	-3,50	3,100			TO263	FAIRCHILD
FQB1P50	-500	-1,50	10,500			TO263	FAIRCHILD
FQB3P50	-500	-2,70	4,900			TO263	FAIRCHILD

All MOSFETs up to 100 V are available in logic level, partly down to 2,5 V

MOSFET P-Channel

TO 220



Device	V _{DSS} V	I _D A	R _{DS(on)} V _{GS} =10V Ω max	P _D W	C _{iss} pF/nc	Package	Manufacturer
FQP7P06	-60	-7,00	0,410			TO220	FAIRCHILD
2SJ581-T	-60	-12,00	0,100			TO220	NEC
2SJ302	-60	-14,0				TO220	NEC
FQP17P06	-60	-17,00	0,120			TO220	FAIRCHILD
HAF1001	-60	-20,00	0,065		—	TO220	Renesas
2SJ543	-60	-20,00	0,550	—	1750	TO220	Renesas
2SJ602	-60	-20,00				TO220	NEC
2SJ603	-60	-25,00				TO220	NEC
FQP27P06	-60	-27,00	0,070			TO220	FAIRCHILD
HAF1005	-60	-30,00	0,045	50		TO220	Renesas
2SJ604	-60	-45,00				TO220	NEC
2SJ605	-60	-63,00				TO220	NEC
2SJ606	-60	-83,00				TO220	NEC
2SJ607	-60	-83,00				TO220	NEC
FQP5P10	-100	-4,50	1,050			TO220	FAIRCHILD
FQP8P10	-100	-8,00	0,530			TO220	FAIRCHILD
FQP12P10	-100	-11,50	0,290			TO220	FAIRCHILD
FQP17P10	-100	-16,50	0,190			TO220	FAIRCHILD
2SJ221	-100	-20,00	0,160	—	1800	TO220	Renesas
FQP3P20	-200	-2,80	2,700	52	7,5	TO220	FAIRCHILD
FQP5P20	-200	-4,80	1,400			TO220	FAIRCHILD
FQP7P20	-200	-7,30	0,690	90	25	TO220	FAIRCHILD
FQP12P20	-200	-11,50	0,470			TO220	FAIRCHILD
FQP2P25	-250	-2,30	4,000	52	6,5	TO220	FAIRCHILD
FQP6P25	-250	-6,00	1,100	90	20	TO220	FAIRCHILD
FQP9P25	-250	-9,40	0,620			TO220	FAIRCHILD
FQP2P40	-400	-2,00	6,500			TO220	FAIRCHILD
FQP4P40	-400	-3,50	3,100			TO220	FAIRCHILD
FQP1P50	-500	-1,50	10,500			TO220	FAIRCHILD
FQP3P50	-500	-2,70	4,900			TO220	FAIRCHILD

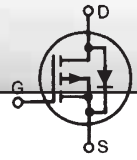
MOSFET



MOSFET P-Channel

TO 220F

TO 220CFM



Device	V _{DSS} V	I _D A	R _{DS(on)} V _{GS} =10V Ω max	P _D W	C _{ISS} pF/nc	Package	Manufacturer
FQPF7P06	-60	-5,30	0,410			TO220F	FAIRCHILD
FQPF11P06	-60	-8,60	0,175			TO220F	FAIRCHILD
SFS9Z34	-60	-12,00	0,140	36	890	TO220F	FAIRCHILD
2SJ303	-60	-14,00	0,100	35	1200	TO220F	NEC
2SJ329	-60	-15,00	0,060	35	2080	TO220F	NEC
2SJ546*	-60	-15,00	0,095	—	860	TO220F	Renesas
2SJ493	-60	-16,00	0,100	30	1210	TO220F	NEC
2SJ494	-60	-20,00	0,050	35	2360	TO220F	NEC
2SJ532*	-60	-20,00	0,055	—	1750	TO220F	Renesas
2SJ495	-60	-30,00	0,030	35	4120	TO220F	NEC
2SJ533*	-60	-30,00	0,037		2500	TO220F	Renesas
FQPF5P10	-100	-3,56	1,050			TO220F	FAIRCHILD
FQPF8P10	-100	-5,40	0,530			TO220F	FAIRCHILD
FQPF12P10	-100	-8,50	0,290			TO220F	FAIRCHILD
FQPF17P10	-100	-10,50	0,190			TO220F	FAIRCHILD
FQPF22P10	-100	-13,20	0,125			TO220F	FAIRCHILD
FQPF3P20	-200	-2,20	2,700	32	7,5	TO220F	FAIRCHILD
FQPF5P20	-200	-3,40	1,400			TO220F	FAIRCHILD
FQPF7P20	-200	-5,20	0,690	45	25	TO220F	FAIRCHILD
2SJ410	-200	-6,00	0,850		920	TO220F	Renesas
FQPF12P20	-200	-7,30	0,470			TO220F	FAIRCHILD
2SJ448	-250	-4,00	2,000	30	420	TO220F	NEC
2SJ449	-250	-6,00	0,800	35	1050	TO220F	NEC
FQPF2P40	-400	-1,34	6,500			TO220F	FAIRCHILD
FQPF4P40	-400	-2,40	3,100			TO220F	FAIRCHILD
FQPF1P50	-500	-1,03	10,500			TO220F	FAIRCHILD
FQPF3P50	-500	-1,90	4,900			TO220F	FAIRCHILD

All MOSFETs up to 100 V are available in logic level, partly down to 2,5 V
HAF/NP= 175°C thermal shut down * Avalanche Guarantee

MOSFET P-Channel

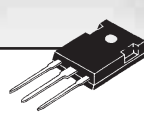
T03P



T03PF



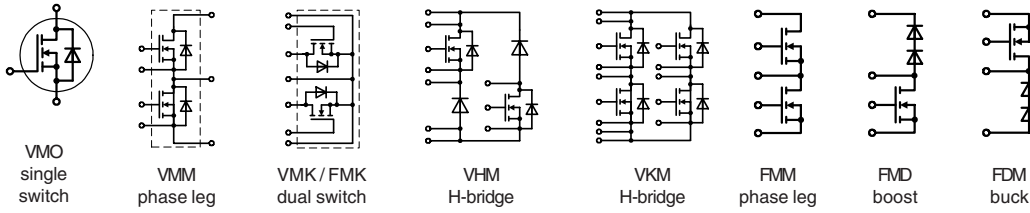
T0247



Device	V _{DSS} V	I _D A	R _{DS(on)} V _{GS} =10V Ω max	P _D W	C _{iss} pF/nc	Package	Manufacturer
IXTH36P10	-100	-36,00	0,075		2800	TO247	IXYS
IXTH36P1050P10	-100	-50,00	0,055		4200	TO247	IXYS
IXTH16P20	-200	-16,00	0,220		2800	TO247	IXYS
IXTH24P20	-200	-24,00	0,150		4500	TO247	IXYS
IXTH7P50	-500	-7,00	1,500		3400	TO247	IXYS
IXTH8P50	-500	-8,00	1,200		3400	TO247	IXYS
IXTH10P50	-500	-10,00	0,900		4700	TO247	IXYS
IXTH11P50	-500	-11,00	0,750		4700	TO247	IXYS
IXTH10P60	-600	-10,00	1,000		4700	TO247	IXYS
2SJ331	-60	-30,0				TO3P	NEC
FQAF47P06	-60	-38,00	0,026			TO3PF	FAIRCHILD
2SJ554	-60	-45,00	0,037		2500	TO3P	Renesas
2SJ556*	-60	-45,00	0,028	60	2500	TO3PF	Renesas
FQA47P06	-60	-55,00	0,026			TO3P	FAIRCHILD
2SJ555	-60	-60,00	0,022		4100	TO3P	Renesas
FQAF17P10	-100	-12,20	0,190			TO3PF	FAIRCHILD
FQAF22P10	-100	-16,60	0,125			TO3PF	FAIRCHILD
FQA17P10	-100	-18,00	0,190			TO3P	FAIRCHILD
FQA22P10	-100	-24,00	0,125			TO3P	FAIRCHILD
2SJ160	-120	-7,00	1,000		900	TO3P	Renesas
2SJ161	-140	-7,00	1,000		900	TO3P	Renesas
2SJ162	-160	-7,00	1,000		900	TO3P	Renesas
2SJ352	-200	-8,00	1,700			TO3P	Renesas
FQAF12P20	-200	-11,50	0,470			TO3PF	FAIRCHILD
FQAF9P25	-250	-7,10	0,620			TO3PF	FAIRCHILD
FQA9P25	-250	-10,50	0,620			TO3P	FAIRCHILD
IXTT10P50	-500	-10,00	0,900		4700	TO268	IXYS
IXTT11P50	-500	-11,00	0,750		4700	TO268	IXYS

MOSFET

All MOSFETs up to 100 V are available in logic level, partly down to 2,5 V
 * Avalanche Guarantee



N Channel Enhancement Types

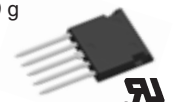
suffix "F" = HiPerFET™ technology with fast intrinsic diode

Type	V _{DSS} V	I _{D25} A T _c = 25°C	I _{D80} A T _c = 80°C	R _{DSon} mΩ T _j = 25°C	t _f ns	t _r ns	R _{thJC} K/W	Ther- mistor	Fig. No.	Package style
□ New										Outline drawings on pages O-5...O-17
single switch modules										
VMO 150-01P1	100	150	110	8	65	90	0.25		25	Fig. 25 ECO-PAC 2 Weight = 24 g See data sheet for pin arrangement
VMO 550-01F	100	590	440	2.1	200	300	0.057		33	
VMO 650-01F	100	690	520	1.8	200	300	0.048		33	
VMO 580-02F	200	580	440	3.2	350	500	0.048		82	
VMO 40-05P1	500	41	31	100	45	60	0.3		25	
VMO 60-05F	500	60	44	65	30	250	0.21		26	
VMO 80-05P1	500	82	62	50	45	60	0.16		25	
dual switch modules - common source configuration										
VMK 165-007T	70	165	112	6	110	280	0.32		26	Fig. 26 TO-240AA Weight = 90 g
FMK 75-01F	100	75	50 / 90°C	21	60	60	0.50		84	
VMK 90-02T2	200	84	63	25	100	80	0.33		26	
MOSFET modules - phase leg configuration										
FMM 75-01F	100	75	50 / 90°C	21	60	60	0.50		84	Fig. 28 Weight = 130 g
VMM 650-01F	100	680	500 / 90°C	1.8	200	250	0.08	□	80	
VMM 45-02F	200	45	34	39	25	200	0.63		26	
VMM 85-02F	200	84	63	20	100	200	0.33		28	
VMM 300-03F	300	290	220	7.4	150	300	0.08	□	33	
VMM 90-09F	900	85	65	76	140	180	0.08		80	
MOSFET modules - H bridge configuration										
□ VHM 40-06P1	600	38	25 / 90°C	70	10	95	0.45	□	25	Fig. 80 Weight = 250 g
VKM 60-01P1	100	63	47	25	60	60	0.45			
VKM 40-06P1*	600	38	25	70	10	95	0.45			
MOSFET modules - boost configuration										
FMD 21-05QC	500	21	15 / 90°C	180	16	30	1.50		84	Fig. 82 Weight = 250 g
□ FMD 40-06KC	600	38	25 / 90°C	60	10	30	0.45			
MOSFET modules - buck configuration										
FDM 21-05QC	500	21	15 / 90°C	180	16	30	0.50		84	

* **COOLMOS**

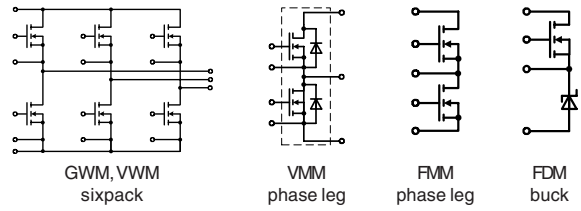
CoolMOS™ is a trademark of Infineon Technologies

Fig. 84 **ISOPLUS i4-PAC™**
Weight = 9 g



Trench MOSFET Technology

- very low R_{DSon}
- fast body diode



Type	V_{DSS} V	I_{D25} A $T_C = 25^\circ C$	I_{D80} A $T_C = 80^\circ C$	R_{DSon} m Ω $T_J = 25^\circ C$	t_f ns	t_r ns	R_{thJC} K/W	MOSFET Type	Fig. No.	Package style
<input type="checkbox"/> New										Outline drawings on pages O-5...O-17
Phase leg configuration										
<input type="checkbox"/> FMM 140-004PL	40	140	100 / 90°C	4.0	130	120	1.30	std	84	Fig. 74 Weight = 80 g
<input type="checkbox"/> FMM 200-004PL	40	200	150 / 90°C	2.8	190	270	1.00	logic level	84	
<input type="checkbox"/> FMM 300-0055P	55	300	220 / 90°C	2.7	40	50	0.50	std	84	Fig. 80 Weight = 250 g
<input type="checkbox"/> FMM 150-0075P	75	150	120 / 90°C	4.7	60	60	0.60	std	84	
<input type="checkbox"/> FMM 200-0075P	75	200	160 / 90°C	3.5	1170	1020	0.55	std	84	Fig. 84 ISOPLUS i4-PAC™ Weight = 9 g
<input type="checkbox"/> VMM 1500-0075P	75	1500	1200	0.55	200	170	0.06	std	80	
<input type="checkbox"/> VMM 1000-01P	100	1000	800	0.75	100	100	0.06	std	84	
<input type="checkbox"/> FMM 65-015P	150	65	50 / 90°C	13	100	80	0.60	std	84	
Sixpack configuration										
<input type="checkbox"/> VWM 350-0075P	75	340	250	2.3	200	170	0.26	std	74	Fig. 94 ISOPLUS-DIL™ Weight = 25 g
<input type="checkbox"/> VWM 200-01P	100	210	170	3.6	100	100	0.26	std	84	
<input type="checkbox"/> GWM 220-004P3L	40	220	160 / 90°C	2.8	190	270	0.85	logic level	94	
<input type="checkbox"/> GWM 160-0055P3	55	160	120 / 90°C	3	50	40	0.85	std	94	
<input type="checkbox"/> GWM 120-0075P3	75	125	100 / 90°C	4.8	50	60	0.85	std	94	
Buck configuration										
<input type="checkbox"/> FDM 100-0045SP	45	100	80 / 90°C	5.7	155	115	1.0	std	84	

MOSFET



DE Series

The patented DE-SERIES Fast Power™ MOSFETs are a new class of unique high power transistors designed as a circuit element from the ground up for high speed, high frequency, high power applications at frequencies up to 100 MHz. DEI's Fast Power™ technology features low insertion inductance (≤ 1.5 nH), and a low profile package, with $R_{\theta JHS}$ as low as 0.17°C/W , which provides exceptional switching speeds and power handling capabilities. The DE-SERIES MOSFETs offer 10 times the speed and 3 times the thermal dissipation, with $1/2$ the volume, $1/3$ the weight and greatly reduced die stress, of comparable conventional power MOSFET devices.

FEATURES

- Isolated Substrate
 - high isolation voltage (> 2500 V)
 - excellent thermal transfer
 - increased temperature and power cycling capability
- IXYS advanced low Q_g process
- Low gate charge and capacitances
 - easier to drive
 - faster switching
- Low $R_{DS(on)}$
- Very low insertion inductance (≤ 1.5 nH)

ADVANTAGES

- Optimized for RF and high speed switching at frequencies to 100MHz
- Higher voltages - lower DC current requirements, higher load impedances, reduced system size and weight, simplifies paralleling of devices
- Easy to mount - no insulators needed
- High power density

APPLICATIONS

- RF Power Amplifiers
- High Frequency SMPS
- Laser Diode Drivers
- RF Power Generators
- Induction Heating
- High Speed Pulse Generators

Part Number	Voltage V	I_b A	I_{DM} A	G_{fs} S	$R_{DS(on)}$ Ω	$TR_{(on)}$ ns	$R_{\theta JHS}$ $^\circ\text{C/W}$	Fig. No.	Package style Outline drawings on page 100
► New									
► DE 150-101N09A DE 275-101N30	100	9 30	54 240	8 20	0.16 0.05	4 5	1.5 0.45	D1 D2	Fig. D1 Weight = 2 g DE 150
► DE 150-201N09A DE 275-201N25	200	9 25	54 200	5 18	0.40 0.08	4 5	1.5 0.45	D1 D2	Fig. D2 Weight = 2 g DE 275
► DE 375-301N35	300	35	280	29	0.10	6	0.35	D4	Fig. D3 Weight = 4 g DE 275x2
► DE 150-501N04A	500	4.5	27	4	1.50	4	1.5	D1	Fig. D4 Weight = 3 g DE 375
► DE 275-501N16A		16	98	6	0.50	2	0.33	D2	Fig. D5 Weight = 3 g DE 475
► DE 275X2-501N16A		16	98	6	0.50	2	0.17	D3	
► DE 375-501N21A		21	126	17	0.27	3	0.23	D4	
► DE 475-501N44A		44	264	32	0.14	5	0.20	D5	
► DE 150-102N02A	1000	1.5	9	1.5	11	4	1.5	D1	
► DE 275-102N06A		6	48	6	2.0	2	0.33	D2	
► DE 275X2-102N06A		6	48	6	2.0	2	0.17	D3	
► DE 375-102N12A		12	72	12	1.07	3	0.23	D4	
► DE 475-102N21A		21	124	22	0.52	5	0.20	D5	



MOSFET

RF MOSFET Gate Drive IC

The DEIC 420 ultra-fast high current driver is optimized to drive DEI DE-Series MOSFETs for high efficiency performance in RF generators, laser diode drivers, pulse generators, and high frequency power conversion applications. It is designed to switch power MOSFETs with minimum switching times at frequencies to 45 MHz. The innovative DEIC 420 is manufactured in DEI's patented low-inductance RF package, offering superior thermal performance and high continuous operating frequencies.

FEATURES

- Wide operating voltage range from 8 V to 30 V
- Very low output impedance
- **No internal cross conduction which allows operating frequencies to 45 MHz**
- Latch-up protected to rated reverse current
- Output Current - up to 20 A peak
- Very low thermal impedance
- Matched rise and fall times
- Evaluation Board available (see page 83)

APPLICATIONS

- Class D and E RF Generators
- Laser Diode Drivers
- High Frequency Power Factor Correction
- Acoustic Transducer Drivers
- High Frequency SMPS
- Pulse Generators

Device	Function	Type	Config uration	I_{Peak}	Supply Voltage	Output Impedance typ. Ω	$t_{on/off}$	Package Outline drawings page 100	Power Dissipation $T_c \leq 25^\circ C$ W	Fig. No.
► New				A	V		ns			
► IXDD 415SI	Low-Side Driver	Dual	Non- Inverting/ Enable	15	8 to 30	0.8	3 / 3	28-pin SOP	12	93
► DEIC 420	Low-Side Driver	Single	Non- Inverting	20	8 to 30	0.4	3 / 4	DE-275	100	D2

Fig. 93
28-pin SOP



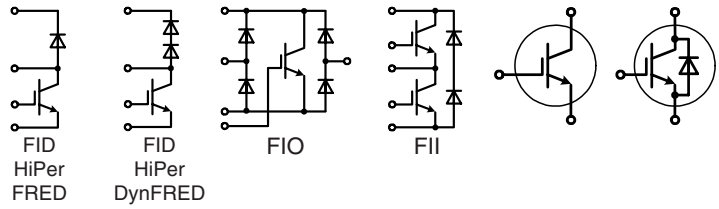
Fig. D2
DE 275



Discrete NPT IGBT

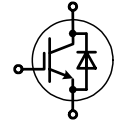
NPT IGBT

NPT IGBT = non-punch through insulated gate bipolar transistor, square RBSOA, short circuit rated

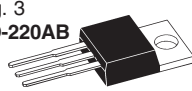


Type	V_{CES} V	I_{C25} A $T_c = 25^\circ C$ IGBT	I_{C90} A $T_c = 90^\circ C$ IGBT	V_{CEsat} V $T_j = 25^\circ C$ IGBT	E_{off} mJ $T_j = 125^\circ C$ IGBT	R_{thJC} K/W max. IGBT	Diode	I_{F90} A $T_c = 90^\circ C$ diode	Fig. No.	Package style
<input type="checkbox"/> New										Outline drawings on pages O-5...O-17
IXDP 20N60B	600	32	20	2.2	0.4	0.9			3	Fig. 3 TO-220AB Weight = 4 g
IXDP 20N60BD1		32	20	2.2	0.4	0.9	<input type="checkbox"/>	14	3	
IXDP 35N60B		60	35	2.1	0.8	0.5			3	
IXDH 35N60B		60	35	2.1	0.8	0.5			6	
IXDH 35N60BD1		60	35	2.1	0.8	0.5	<input type="checkbox"/>	21	6	
IXDR 35N60BD1		60	24	2.1	0.8	1.0	<input type="checkbox"/>	18	7	
IXDA 20N120AS	1200	34	25	2.8	2.4	0.63			5a	Fig. 5a TO-263AA Weight = 2 g
IXDH 20N120		38	25	2.4	2.4	0.63	<input type="checkbox"/>	20	6	
IXDH 20N120D1		38	25	2.4	2.4	0.63	<input type="checkbox"/>		6	
IXDH 30N120		60	38	2.4	3.4	0.42	<input type="checkbox"/>		6	
IXDH 30N120D1		60	38	2.4	3.4	0.42	<input type="checkbox"/>	35	6	
IXDR 30N120		50	30	2.4	3.4	0.60			7	
IXDR 30N120D1		50	30	2.4	3.4	0.60	<input type="checkbox"/>	27	7	
IXDN 55N120D1		100	62	2.3	6.2	0.28	<input type="checkbox"/>	60	12	Fig. 6 TO-247 AD Weight = 6 g
IXDN 75N120		150	95	2.2	10.5	0.19	<input type="checkbox"/>		12	
3rd generation NPT³ IGBT										
<input type="checkbox"/> IXEH 25N120	1200	36	24	2.6	2.5	0.63			6	Fig. 7 ISOPLUS247™ Weight = 5 g
<input type="checkbox"/> IXEH 25N120D1		36	24	2.6	2.5	0.63	<input type="checkbox"/>	20	6	
IXER 35N120D1		50	32	2.2	2.6	0.60	<input type="checkbox"/>	25	7	
IXEH 40N120		60	40	2.4	3.0	0.42			6	
IXEH 40N120D1		60	40	2.4	3.0	0.42	<input type="checkbox"/>	35	6	
IXER 60N120		95	60	2.1	4.8	0.33			7	
IXEN 60N120		100	65	2.1	4.8	0.28			12	
<input type="checkbox"/> IXEN 60N120D1		100	65	2.1	4.8	0.28	<input type="checkbox"/>	60	12	
Special configurations with NPT IGBT										
Type	Configuration	V_{CES} V	I_{C25} A $T_c = 25^\circ C$ IGBT	I_{C90} A $T_c = 90^\circ C$ IGBT	V_{CEsat} V $T_j = 25^\circ C$ IGBT	E_{off} mJ $T_j = 125^\circ C$ IGBT	R_{thJC} K/W max. IGBT		Fig. No.	
<input type="checkbox"/> New										
FID 35-06C	boost, HiPerDynFRED	600	38	24	1.9	0.6	1.0	84	Fig. 84 ISOPLUS i4-PAC™ Weight = 9 g	
<input type="checkbox"/> FID 36-06D	boost, HiPerFRED	600	38	24	1.9	0.6	1.0			
<input type="checkbox"/> FID 60-06D	boost, HiPerFRED	600	65	40	1.6	1.4	0.6			
<input type="checkbox"/> FII 30-06D	phaseleg	600	30	18	1.9	0.68	1.25			
<input type="checkbox"/> FII 40-06D	phaseleg	600	40	25	1.8	0.8	1.0			
Special configurations with NPT³ IGBT										
<input type="checkbox"/> FII 30-12E	phaseleg	1200	32	20	2.4	2.0	0.8	84	 Fig. 84	
<input type="checkbox"/> FII 50-12E	phaseleg	1200	50	32	2.0	2.2	0.6			
<input type="checkbox"/> FIO 50-12BD	1~ bridge & IGBT	1200	50	32	2.0	2.2	0.6			

BiMOSFET™

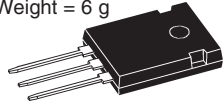



High Speed Types in 1400 und 1600 V

Type	V _{CES} V	I _{C25} A T _C = 25°C	I _{C90} A T _C = 90°C	V _{CE(sat) typ} V T _J = 25°C	Gate drive V	t _{f typ} ns T _J = 125°C	R _{thJC} K/W	Fig. No.	Package style
□ New									Outline drawings on pages O-5...O-17
* IXBF 9N140G				replacement: IXBF9N160G				85	 Fig. 3 TO-220AB Weight = 4 g
* IXBH 9N140G				replacement: IXBH9N160G				6	
□ IXBP 5N160G	1600	5.7	3.5	4.9	10	70	1.75	3	
□ IXBH 5N160G		5.7	3.5	4.9	10	70	1.75	6	
IXBF 9N160G		7	5	4.9	10	70	1.75	85	
IXBH 9N160G		9	5	4.9	10	70	1.25	6	
IXBF 40N160		28	16	6.2	15	40	0.50	85	
IXBH 40N160		33	20	6.2	15	40	0.35	6	

* not for new design

1700 V Types

High speed									
IXBH 16N170A	1700	16	10	4.7	15	50	0.83	6	 Fig. 6 TO-247 AD Weight = 6 g
IXBT 16N170A		16	10	4.7	15	50	0.83	10	
IXBT 42N170A		42	25	5.0	15	50	0.35	10	
Low V _{CE(sat)}									
IXBH 6N170	1700	10	6	2.3	15	1200	1.8	6	 Fig. 10 TO-268 Weight = 4 g
IXBT 6N170		10	6	2.3	15	1200	1.8	10	
IXBH 10N170		16	10	2.3	15	1200	1.25	6	
IXBT 10N170		16	10	2.3	15	1200	1.25	10	
IXBH 16N170		25	16	2.3	15	1200	0.83	6	
IXBT 16N170		25	16	2.3	15	1200	0.83	10	
IXBH 42N170		70	42	2.3	15	1200	0.35	6	
IXBT 42N170		70	42	2.3	15	1200	0.35	10	

BiMOSFET™ includes a body diode, which can carry rated current
High voltage, high speed, pulse current applications

High Voltage IGBT

2500 V Types

Type	V _{CES} V	I _{C25} A T _C = 25°C	I _{C90} A T _C = 90°C	V _{CE(sat) typ} V T _J = 25°C	t _{f typ} ns T _J = 125°C	E _{off typ} mJ T _J = 125°C	R _{thJC} K/W	Fig. No.
□ New								
IXLF 19N250A	2500	32	19	3.2	100	3.6	0.5	85
IXLV 19N250A	2500	tbd	tbd	3.2	100	3.6	tbd	98b

preliminary data, typical values

RIGBT

IGBT with Reverse Blocking Capability

- Applications: lighting control, AC motor control, matrix converters
- No extra on state losses for reverse blocking feature

Type	Configuration	V _{CES} V T _J = 25°C	I _{C25} A T _C = 25°C	I _{C90} A T _C = 90°C	V _{CE(sat) typ} V T _J = 25°C	t _{rr typ} μs T _J = 125°C	t _{f typ} ns T _J = 125°C	Fig. No.
□ New								
IXRH 40N120	single RIGBT	1200	55	35	2.2	1.6	70	6
IXRR 40N120	single RIGBT	1200	45	28	2.2	1.6	70	7

preliminary data, typical values

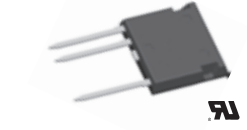


Fig. 98b **TO-273 PLUS220 SMD**
Weight = 2 g

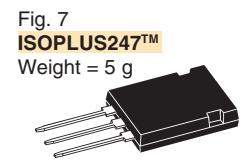
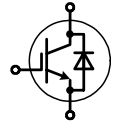


Fig. 7 **ISOPLUS247™**
Weight = 5 g

IGBT

G-Series IGBT / Diode Selection Table



Mid-Frequency Range (15 kHz - 40 kHz) Types

Part Type	V _{CES} min	I _c 25°C	I _c 110°C	V _{CE(sat)} max. 25°C	t _{fi} typ.	E _{off} typ. 125°C	R _{(th)JC} K/W	I _F 110°C	R _{(th)JC} K/W	Fig. No.	Package style
► New	V	A	A	V	ns	mJ	IGBT	A	Diode		Outline drawings on pages O-5...O-17
IXGA7N60BD1	600	14	5	2.1	120	0.33	1.65	10	2.5	5a	Fig. 3 TO-220AB Weight = 4 g
IXGA7N60CD1		14	5	2.5	45	0.22	1.65	10	2.5	5a	
IXGP7N60BD1		14	5	2.1	120	0.33	1.65	10	2.5	3	
IXGP7N60CD1		14	5	2.5	45	0.22	1.65	10	2.5	3	
► IXGA16N60B2D1		24	16	2.3	70	0.25	0.75	12	tbd	5a	
► IXGP16N60B2D1		24	16	2.3	70	0.25	0.75	16	tbd	3	
► IXGH30N60B2D1		70	30	1.8	82	0.32	0.65	25	0.9	6	
► IXGT30N60B2D1		70	30	1.8	82	0.32	0.65	25	0.9	10	
► IXGR50N60B2D1		68	34	2.0	65	1.55	0.6	24	1.4	7	
► IXGH40N60B2D1		75	40	1.7	82	1.1	0.42	25	0.9	6	
► IXGT40N60B2D1		75	40	1.7	82	1.1	0.42	25	0.9	10	
► IXGK50N60B2D1		75	40	2.0	65	1.55	0.31	38	0.65	11	
► IXGX50N60B2D1		75	40	2.0	65	1.55	0.31	38	0.65	7	
► IXGR60N60B2D1		75*	47	1.8	100	2.8	0.25	35	0.65	7	
► IXGK60N60B2D1	75*	60	1.8	100	2.8	0.25	42	0.65	11		
► IXGX60N60B2D1	75*	60	1.8	100	2.8	0.25	42	0.65	7		
IXGB75N60BD1	120*	61	2.3	150	3.3	0.35	42	0.65	106	Fig. 5a TO-263AB Weight = 2 g	
► IXGH20N120BD1	1200	40	20	3.4	160	3.5	0.65	10	2.5	6	Fig. 5a TO-263AB Weight = 2 g
► IXGQ20N120B2D1		40	20	3.4	160	3.5	0.65	10	2.5	104	
► IXGT20N120BD1		40	20	3.4	160	3.5	0.65	10	2.5	10	
► IXGH28N120BD1		50	28	3.5	160	5	0.5	10	2.5	6	
► IXGQ28N120B2D1		50	28	3.5	160	5	0.5	10	2.5	104	
► IXGT28N120BD1		50	28	3.5	160	5	0.5	10	2.5	10	
IXGH15N120BD1		30	10	3.2	160	3.5	0.65	19	1.6	6	
IXGH15N120CD1		30	10	3.8	185	2.1	0.65	19	1.6	6	
IXGT15N120BD1		30	10	3.2	160	3.5	0.65	19	1.6	10	
IXGT15N120CD1		30	10	3.8	115	2.1	0.65	19	1.6	10	
IXGK35N120BD1		70	30	3.5	160	8	0.42	29	0.65	11	
IXGK35N120CD1		70	30	4	115	6.2	0.42	29	0.65	11	
IXGX35N120BD1		70	30	3.5	160	8	0.42	29	0.65	7	
IXGX35N120CD1		70	30	4	115	6.2	0.42	29	0.65	7	

High Frequency Range (> 40 kHz) Types

Part Type	V _{CES} min	I _c (25°C)	I _c (110°C)	V _{CE(sat)} max. 25°C	t _{fi} typ.	E _{off} typ. 125°C	R _{(th)JC} K/W	I _F 110°C	R _{(th)JC} K/W	Fig. No.	Package style
	V	A	A	V	ns	mJ	IGBT	A	Diode		
IXGC16N60C2D1	600	24	8	3.0	35	0.15	2.0	10	2.5	83	Fig. 10 TO-268 Weight = 4 g
IXGA16N60C2D1		40	16	3.0	35	0.15	0.83	11	2.5	5a	
IXGP16N60C2D1		40	16	3.0	35	0.15	0.83	11	2.5	3	
IXGR40N60C2D1		70	35	2.7	32	0.50	0.74	26	1.0	7	
IXGR50N60C2D1		75	40	2.7	35	0.75	0.75	42	tbd	7	
IXGT40N60C2D1		75	40	2.7	37	0.50	0.42	40	0.9	10	
IXGH40N60C2D1		75	40	2.7	32	0.50	0.42	40	0.9	6	
IXGJ40N60C2D1		75	40	2.7	32	0.50	0.42	40	0.9	9	
IXGR60N60C2D1		75	43	2.7	35	1.2	0.5	25	1.4	7	
IXGK50N60C2D1		75	50	2.5	48	0.74	0.31	50	0.85	11	
IXGX50N60C2D1		75	50	2.5	48	0.71	0.31	50	0.85	7	
IXGK60N60C2D1		75	60	2.5	35	1.2	0.26	60	0.85	11	
IXGX60N60C2D1		75	60	2.5	35	1.2	0.26	60	0.85	7	

Fig. 106, **PLUS264**,
Weight = 10 g

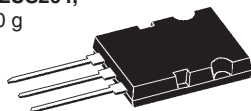


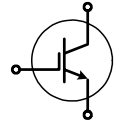
Fig. 104 **TO-3P**
Weight = 5 g



Fig. 83
ISOPLUS220™
Weight = 2 g



Power Discretes/IGBTs/G-series for High Speed



Low Saturation Voltage Types

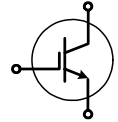
Part Type	V _{CES} min V	I _c 25°C A	I _c 90°C A	V _{CE(sat)} max 25°C V	t _{fi} typ. ns	E _{off} typ 125°C mJ	R _{(th)JC} K/W	Fig. No.	Package style
► New									Outline drawings on pages O-5...O-17
IXGH60N60	600	75	60	1.7	360	17	0.42	6	Fig. 3 TO-220AB Weight = 4 g
IXGK60N60		75	60	1.7	360	17	0.42	11	
IXGT60N60		75	60	1.7	360	17	0.42	10	
IXGN60N60		100	60	1.7	360	17	0.5	12	
► IXGN200N60A2		200*	100*	1.35	250	12	0.17	12	
IXGA8N100	1000	16	8	2.7	390	3.7	2.3	5a	Fig. 5a TO-263AB Weight = 2 g
IXGP8N100		16	8	2.7	390	3.7	2.3	3	
IXGA20N100		40	20	3	280	3.5	0.83	5a	
IXGH20N100		40	20	3	280	3.5	0.83	6	
IXGP20N100		40	20	3	280	3.5	0.83	3	
IXGT20N100	40	20	3	280	3.5	0.83	10		
IXGA20N120	1200	40	20	3	280	6.5	0.83	5a	Fig. 6 TO-247 AD Weight = 6 g
IXGH20N120		40	20	3	280	6.5	0.83	6	
IXGP20N120		40	20	3	280	6.5	0.83	3	
IXGT20N120		40	20	3	280	6.5	0.83	10	
IXGH45N120		75	45	2.5	390	25	0.42	6	
IXGT45N120	75	45	2.5	390	25	0.42	10		

Mid-Frequency Range (15 kHz - 40 kHz) Types

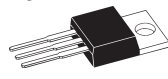

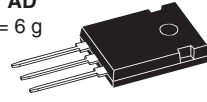
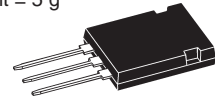
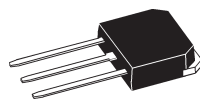

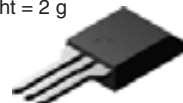

Part Type	V _{CES} min V	I _c 25°C A	I _c 110°C A	V _{CE(sat)} max 25°C V	t _{fi} typ. ns	E _{off} typ 125°C mJ	R _{(th)JC} K/W	Fig. No.	Package style	
► New										
IXGA7N60B	600	14	5	2.1	120	0.33	2.5	5a	Fig. 7 ISOPLUS247™ DCB isol. package PLUS247 Weight = 5 g	
IXGA7N60C		14	5	2.5	45	0.22	2.5	5a		
IXGP7N60B		14	5	2.1	120	0.33	2.5	3		
IXGP7N60C		14	5	2.5	45	0.22	2.5	3		
► IXGA16N60B2		24	16	2.3	80	0.35	0.43	5A		
► IXGP16N60B2		24	16	2.3	80	0.35	0.43	3		
► IXGH30N60B2		70	30	1.8	82	0.9	0.65	6		
► IXGT30N60B2		70	30	1.8	82	0.9	0.65	10		
► IXGH40N60B2		75	40	1.7	82	1.1	0.42	6		
► IXGT40N60B2		75	40	1.7	82	1.1	0.42	10		
► IXGK50N60B2		75	40	2.0	65	1.55	0.31	11		
► IXGX50N60B2		75	40	2.0	65	1.55	0.31	7		
► IXGR60N60B2		75*	55	1.8	100	2.8	0.5	7		
► IXGH60N60B2		75*	60	1.8	100	2.8	0.25	6		
► IXGT60N60B2		75*	60	1.8	100	2.8	0.25	10		
IXGR120N60B	76*	102	2.1	160	8.7	0.3	7	Fig. 11 TO-264 Weight = 10 g		
IXGE200N60B	175*	102	2.1	160	8.7	0.25	87			
IXGK120N60B	200*	106	2.1	160	8.7	0.21	11			
IXGX120N60B	76*	106	2.1	160	8.7	0.3	7			
IXGN200N60B	200*	106	2.1	160	8.7	0.21	12			
► IXGH20N120B	1200	20	20	3.4	160	3.5	0.65		6	Fig. 12 SOT-227B miniBLOC Weight = 30 g
► IXGT20N120B		20	20	3.4	160	3.5	0.65		10	
► IXGQ20N120B		20	20	3.4	160	3.5	0.65		104	
► IXGQ28N120B		28	28	3.5	160	5	0.5		104	
► IXGH28N120B		28	28	3.5	160	5	0.5		6	
► IXGT28N120B		28	28	3.5	160	5	0.5		10	
IXGA15N120B		30	10	3.2	160	3.5	0.65		5a	
IXGA15N120C		30	10	3.8	115	2.1	0.65		5a	
IXGH15N120B		30	10	3.2	160	3.5	0.65		6	
IXGH15N120C		30	10	3.8	115	2.1	0.65		6	
IXGP15N120B		30	10	3.2	160	3.5	0.65	3		
IXGP15N120C		30	10	3.8	115	2.1	0.65	3		
IXGT15N120B		30	10	3.2	160	3.5	0.65	10		
IXGT15N120C		30	10	3.8	115	2.1	0.65	10		
IXGH35N120B		70	30	3.3	160	8	0.42	6		
IXGH35N120C	70	30	4	115	6.2	0.42	6			
IXGK35N120B	70	30	3.3	160	8	0.35	11			
► IXGK35N120C	70	30	4	115	6.2	0.35	11			
IXGR35N120B	70	28	3.3	160	8	0.5	7			
► IXGR35N120C	70	28	4	115	6.2	0.5	7			
IXGT35N120B	70	30	3.3	160	8	0.42	10			
IXGT35N120C	70	30	4	115	6.2	0.42	10			
IXGX35N120B	70	30	3.3	160	8	0.12	7			
IXGX35N120C	70	30	4	115	6.2	0.12	7			

Note: * - current may be limited by external lead current limit

Power Discretes/IGBTs/G-series for High Speed



High Frequency Range (> 40 kHz) Types

Part Type	V _{CES} min	I _c 25°C	I _c 110°C	V _{CE(sat)} max 25°C	t _{fi} typ.	E _{off} typ. 125°C	R _{(th)JC}	Fig. No.	Package style
► New	V	A	A	V	ns	mJ	K/W		Outline drawings on pages O-5...O-17
► IXGC16N60C2	600	24	8	3.0	35	0.15	2.0	83	 Fig. 3 TO-220AB Weight = 4 g  Fig. 5a TO-263AB Weight = 2 g  Fig. 6 TO-247 AD Weight = 6 g  Fig. 7 ISOPLUS247™ Weight = 5 g  Fig. 9 TO-268 I3PAK Weight = 5 g  Fig. 10 TO-268 Weight = 4 g  Fig. 83 ISOPLUS220™ Weight = 2 g  Fig. 85 ISOPLUS i4-PAC™ Weight = 9 g
► IXGA16N60C2		40	16	3.0	35	0.15	0.83	5a	
► IXGP16N60C2		40	16	3.0	35	0.15	0.83	3	
► IXGR40N60C2		70	35	2.7	32	0.50	0.74	7	
► IXGH40N60C2		75	40	2.7	32	0.50	0.42	6	
► IXGT40N60C2		75	40	2.7	32	0.50	0.42	10	
► IXGR50N60C2		75	40	2.7	35	0.75	0.75	7	
► IXGR60N60C2		75	43	2.7	35	1.20	0.5	7	
► IXGH50N60C2		75	50	2.5	48	0.74	0.31	6	
► IXGT50N60C2		75	43	2.5	48	0.74	0.31	10	
► IXGH60N60C2		75	60	2.5	35	1.20	0.26	6	
► IXGT60N60C2		75	60	2.5	35	1.20	0.26	10	

Very High Voltage IGBTs

Low saturation voltage Types

Part Type	V _{CES}	I _{C(25)}	I _{C(90)}	V _{CE(sat)}	E _{off}	R _{(th)JC}	Fig. No.
► New	V	T _C = 25 °C A	T _C = 90 °C A	T _J = 25 °C V	T _J = 125 °C mJ	max. K/W	
► IXGT6N170	1700	12	6	4	2	1.65	9
► IXGH6N170		12	6	4	2	1.65	6
► IXGT10N170		20	10	4	4.7	1.1	6
► IXGH10N170		20	10	4	4.7	1.1	6
► IXGT16N170		32	16	3.5	8	1.65	9
► IXGH16N170		32	16	3.5	8	1.65	6
► IXGT24N170		50	24	3.3	12	0.5	9
► IXGH24N170		50	24	3.3	12	0.5	6
► IXGT32N170		72	35	3.3	14	0.35	9
► IXGH32N170		72	35	3.3	14	0.35	6
► IXGX32N170H1*		72	35	3.3	14	0.35	7

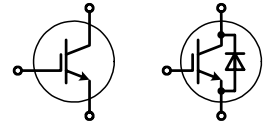
High speed Types

Part Type	V _{CES}	I _{C(25)}	I _{C(90)}	V _{CE(sat)}	E _{off}	R _{(th)JC}	Fig. No.
► New	V	T _C = 25 °C A	T _C = 90 °C A	T _J = 25 °C V	T _J = 125 °C mJ	max. K/W	
► IXGT6N170A	1700	6	3	7	0.26	1.65	9
► IXGH6N170A		6	3	7	0.26	1.65	6
► IXGT10N170A		10	5	6	0.6	1.1	9
► IXGH10N170A		10	5	6	0.6	1.1	6
► IXGT16N170A		16	8	5	1.1	0.65	9
► IXGH16N170A		16	8	5	1.1	0.65	6
► IXGT24N170A		24	16	5	1.7	0.5	9
► IXGH24N170A		24	16	5	1.7	0.5	6
► IXGT32N170A		32	21	5	3.0	0.35	9
► IXGH32N170A		32	21	5	3.0	0.36	6
► IXGX32N170AH1*		32	21	5	3.0	0.35	7
► IXL19N250A	2500	32	19	3.9	3.6	0.5	85

* - includes anti-parallel SONIC diode.

S series with SCSOA capability

Medium Speed (1 kHz to 20 kHz)



Single IGBT

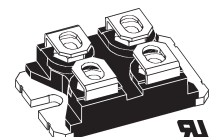
Part Type	V _{CES} min V	I _c (25°C) A	I _c (90°C) A	V _{CE(sat)} max V	t _{fi} typ. ns	E _{off} mJ	R _{(th)JC} K/W	Fig. No.	Package style
IXSP24N60B	600	40	24	2.5	170	1.3	0.83	3	Outline drawings on pages O-5...O-17 Fig. 3 TO-220AB Weight = 4 g Fig. 5a TO-263AB Weight = 2 g
IXSH24N60B		48	24	2.5	170	1.3	0.83	6	
IXST24N60B		48	24	2.5	170	1.3	0.83	10	
IXSH30N60B		55	30	2	140	2.5	0.62	6	
IXST30N60B		55	30	2	140	2.5	0.62	10	
IXSH30N60C		55	30	2.5	70	1.2	0.62	6	
IXST30N60C		55	30	2.5	70	1.2	0.62	10	
IXSH40N60B		75	40	2.2	120	1.8	0.45	6	
IXST40N60B		75	40	2.2	120	1.8	0.45	10	
IXSH50N60B		75	40	2.5	150	3.3	0.5	6	
IXSK80N60B	1200	80*	80	2.5	180	4.2	0.26	11	Fig. 6 TO-247 AD Weight = 6 g
IXSX80N60B		80	80	2.5	180	4.2	0.26	7	
IXSA15N120B		30	15	3.4	298	1.75	0.83	5a	
IXSP15N120B	1200	30	15	3.4	298	1.75	0.83	3	Fig. 7 ISOPLUS247™ Weight = 5 g
IXSH15N120B		30	15	3.4	600	1.5	0.83	6	
IXST15N120B		30	15	3.4	600	1.5	0.83	10	
IXSH35N120B		70	35	3.6	180	5	0.42	6	
IXST35N120B		70	35	3.6	180	5	0.42	10	
IXSH35N140A	1400	70	35	4	400	12	0.42	6	

IGBT / Diode

Part Type	V _{CES} min V	I _c (25°C) A	I _c (90°C) A	V _{CE(sat)} V	t _{fi} typ. ns	E _{off} mJ	R _{(th)JC} K/W	I _r 90°C A	R _{(th)JC} K/W	Fig. No.
IXSH24N60BD1	600	48	24	2.5	170	1.3	0.83	24	0.9	6
IXST24N60BD1		48	24	2.5	170	1.3	0.83	24	0.9	10
IXSH30N60BD1		55	30	2	140	1.5	0.62	30	0.9	6
IXSK30N60BD1		55	30	2	140	1.5	0.62	30	0.9	11
IXST30N60BD1		55	30	2	140	1.5	0.62	30	0.9	10
IXSH30N60CD1		55	30	2.5	70	0.7	0.62	30	0.9	6
IXSK30N60CD1		55	30	2.5	70	0.7	0.62	30	0.9	11
IXST30N60CD1		55	30	2.5	70	0.7	0.62	30	0.9	10
IXSR40N60CD1		62	40	2.5	70	1	0.6	40	1.15	7
IXSK40N60CD1		75	40	2.5	70	1	0.48	40	0.75	11
IXSX40N60CD1		75	40	2.5	70	1	0.48	40	0.75	7
IXSR40N60BD1		70	40	2.2	120	1.8	0.73	40	1.15	7
IXSK40N60BD1		75	40	2.2	120	1.8	0.48	40	0.75	11
IXSX40N60BD1		75	40	2.2	120	1.8	0.48	40	0.75	7
IXSK50N60BD1		75	50	2.5	150	3.3	0.42	50	0.75	11
IXSX50N60BD1		75	50	2.5	150	3.3	0.42	50	0.75	7
IXSN50N60BD2		75	50	2.5	150	3.3	0.5	50	0.75	12
IXSN50N60BD3	75	50	2.5	150	3.3	0.5	50	0.75	12	
IXSN80N60BD1	100*	80	2.5	180	10	0.3	80	0.85	12	
IXSH15N120BD1	1200	30	15	3.4	150	1.5	0.83	25	0.9	6
IXST15N120BD1		30	15	3.4	150	1.5	0.83	25	0.9	10
IXSR35N120BD1		70	30	3.6	180	5	0.5	29	0.83	7
IXSK35N120BD1		70	35	3.6	180	5	0.42	34	0.65	11
IXSX35N120BD1		70	35	3.6	180	5	0.42	34	0.65	7

Notes: * - current may be limited by external lead current limit

Fig. 12
SOT-227B miniBLOC
Weight = 30 g



Package style

Outline drawings on page O-5...O-17

6-pack

IGBT Modules

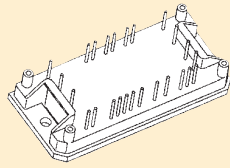
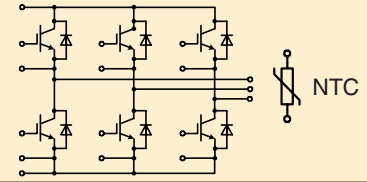


Fig. 49a

Package style

Outline drawings on pages O-1...O-3

See data sheet for pin arrangements



Type	V _{CES} V	I _{C25} A T _C = 25°C IGBT	I _{C80} A T _C = 80°C IGBT	V _{CE(sat) typ} V T _J = 25°C IGBT	E _{off} mJ T _J = 125°C IGBT	R _{thJC} K/W IGBT	I _{F25} A T _C = 25°C diode	I _{F80} A T _C = 80°C diode	NTC
▶ New									
600 V PT IGBT									
▶ MWI 60-06G6K	600	60	41	2.3	0.5	0.7	48	33	●
1200 V NPT IGBT									
▶ MWI 15-12A6K	1200	19	13	3.0	1.1	1.37	24	16	●
1200 V NPT³ IGBT									
▶ MWI 30-12E6K	1200	29	21	2.5	1.8	0.95	24	16	●
▶ MWI 50-12E6K		51	36	2.4	2.6	0.6	49	32	●
1200 V Trench IGBT									
▶ MWI 45-12T6K	1200	43	31	1.9	3.4	0.8	49	32	●
▶ MWI 60-12T6K		58	41	1.9	4.8	0.62	49	32	●
▶ MWI 80-12T6K		80	56	2.0	6.5	0.46	80	51	●

6-pack

IGBT - Modules

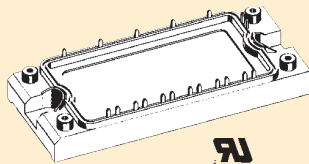
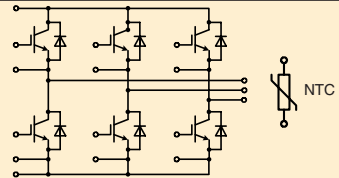


Fig. 81

Package style

Outline drawings on pages O-1...O-3



Type	V _{CES} V	I _{C25} A 25°C IGBT	I _{C80} A 80°C IGBT	V _{CE(sat) typ} V 25°C IGBT	E _{off} mJ 125°C IGBT	R _{thJC} K/W IGBT	I _{F25} A 25°C diode	I _{F80} A 80°C diode	NTC optinal
▶ New									
600 V NPT IGBT									
MWI 30-06A7	600	45	30	1.9	1.0	0.88	36	24	●
MWI 50-06A7		75	50	1.9	1.7	0.55	72	45	●
MWI 75-06A7		90	60	2.1	2.5	0.44	140	85	●
1200 V NPT IGBT									
MWI 15-12A7	1200	30	20	1.0	1.8	0.88	25	17	●
MWI 25-12A7		50	35	2.2	2.8	0.55	50	33	●
MWI 35-12A7		62	44	2.2	4.2	0.44	50	33	●
MWI 50-12A7		85	60	2.2	5.6	0.35	110	70	●
1200 V NPT³ IGBT									
▶ MWI 25-12E7	1200	52	36	1.9	2.5	0.55	50	33	●
▶ MWI 50-12E7		90	62	2.1	4.0	0.35	110	70	●
1200 V Trench IGBT									
▶ MWI 50-12T7	1200	75	50	1.7	6.5	0.49	110	70	●
▶ MWI 75-12T7		105	75	1.7	9.5	0.35	150	100	●

6-pack

IGBT - Modules

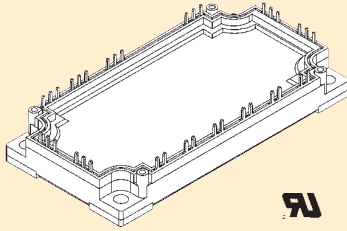
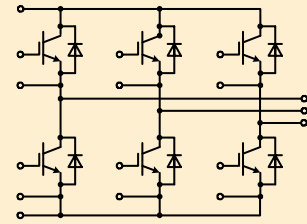


Fig. 77

Package style

Outline drawings on pages O-1...O-3



► New

Type	V_{CES} V	I_{C25} A $T_c = 25^\circ\text{C}$ IGBT	I_{C80} A $T_c = 80^\circ\text{C}$ IGBT	$V_{CE(sat)}$ typ V $T_J = 25^\circ\text{C}$ IGBT	E_{off} mJ $T_J = 125^\circ\text{C}$ IGBT	R_{thJC} K/W IGBT	I_{F25} A $T_c = 25^\circ\text{C}$ diode	I_{F80} A $T_c = 80^\circ\text{C}$ diode
600 V NPT IGBT								
MWI 100-06A8	600	130	88	2.0	2.9	0.3	140	88
MWI 150-06A8		170	115	2.0	4.6	0.24	210	130
MWI 200-06A8		215	155	2.0	6.3	0.18	260	165
1200 V NPT IGBT								
MWI 75-12A8	1200	125	85	2.2	10.5	0.25	150	100
MWI 100-12A8		160	110	2.2	14.6	0.19	200	130
1200 V NPT³ IGBT								
MWI 75-12E8	1200	130	90	2.0	7.5	0.25	150	100
MWI 100-12E8		165	115	2.0	10.0	0.19	200	130
1200 V Trench IGBT								
► MWI 75-12T8	1200	100	75	1.7	9.5	0.35	150	100
► MWI 100-12T8		140	100	1.7	12	0.26	200	130
► MWI 150-12T8		200	150	1.7	17	0.18	tbd	tbd

NPT³ IGBT Modules in E+ package

NPT IGBT = non-punch through insulated gate bipolar transistor; square RBSOA, short circuit rated

6-pack

IGBT - Modules

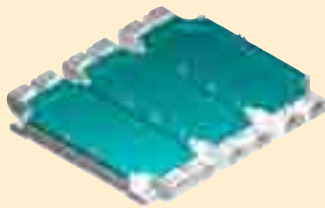
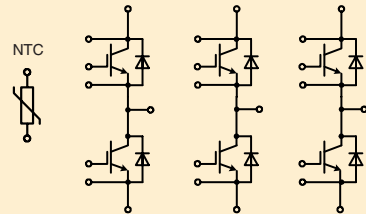


Fig. 95

Package style

Outline drawings on pages O-1...O-3



Type	V_{CES} V	I_{C25} A $T_c = 25^\circ\text{C}$ IGBT	I_{C80} A $T_c = 80^\circ\text{C}$ IGBT	$V_{CE(sat)}$ typ V $T_J = 25^\circ\text{C}$ IGBT	E_{off} mJ $T_J = 125^\circ\text{C}$ IGBT	R_{thJC} K/W IGBT	I_{F25} A $T_c = 25^\circ\text{C}$ diode	I_{F80} A $T_c = 80^\circ\text{C}$ diode	ther- mistor
1200 V NPT³ IGBT									
► MWI 225-12E9	1200	355	250	2.1	20	0.09		205	●
► MWI 300-12E9		530	375	2.0	30	0.06		300	●
► MWI 450-12E9		640	440	2.2	45	0.057		450	●
1700 V NPT³ IGBT									
► MWI 225-17E9	1700	335	235	2.5	54	0.085		200	●
► MWI 300-17E9		500	350	2.3	80	0.057		290	●
► MWI 450-17E9		580	405	2.25	90	0.057		450	●

CBI Modules

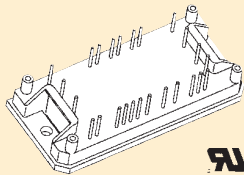
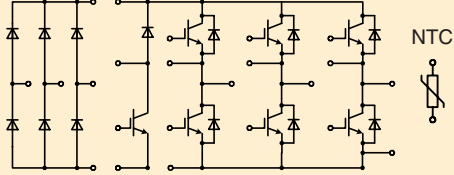
CBI = Converter Brake Inverter

three phase rectifier, IGBT brake chopper, three phase IGBT inverter, temperature sensor

CBI 1
IGBT Modules

Fig. 49a

Package style
Outline drawings on pages O-1...O-3

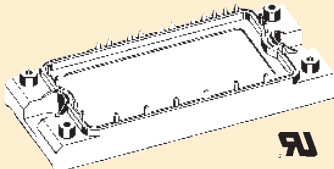
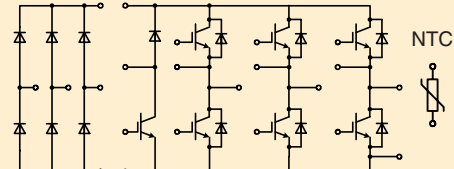



Type	Rectifier 3~			Inverter 3~					Brake chopper		
	V_{RRM}	I_{DAVM} $T_H = 80^\circ\text{C}$	R_{thJC} typ.	V_{CES}	I_C $T_C = 25^\circ\text{C}$	I_C $T_C = 80^\circ\text{C}$	$V_{CE(sat)}$ typ.	R_{thJC} typ.	V_{CES}	I_C $T_C = 80^\circ\text{C}$	R_{thJC} typ.
► New	V	A	K/W	V	A	A	V	K/W	V	A	K/W
600 V NPT IGBT											
MUBW 10-06A6K	1600	61	2.1	600	12	8	2.5	2.8	600	8	2.8
MUBW 15-06A6K		65	1.9		19	14	2.4	1.7		8	2.8
MUBW 20-06A6K		65	1.9		25	17	2.0	1.5		8	2.8
MUBW 25-06A6K		65	1.9		31	21	2.1	1.25		14	1.7
MUBW 35-06A6K		89	1.4		42	29	2.3	0.95		17	1.5
1200 V NPT IGBT											
MUBW 15-12A6K	1600	89	1.4	1200	19	13	3.0	1.35	1200	13	1.35
MUBW 30-12A6K		89	1.4		30	21	3.0	0.95		13	1.35
1200 V NPT³ IGBT											
► MUBW 30-12E6K	1600	89	1.4	1200	30	21	3.1	0.95	1200	13	1.35
1200 V Trench IGBT											
► MUBW 45-12T6K	1600			1200					1200		

CBI 2
IGBT - Modules

Fig. 81

Package style
Outline drawings on pages O-1...O-3

Type	Rectifier 3~			Inverter 3~					Brake chopper		
	V_{RRM}	I_{DAVM} $T_C = 80^\circ\text{C}$ $d = 1/3$	R_{thJC} max.	V_{CES}	I_C $T_C = 25^\circ\text{C}$	I_C $T_C = 80^\circ\text{C}$	$V_{CE(sat)}$ typ.	R_{thJC} max.	V_{CES}	I_C $T_C = 80^\circ\text{C}$	R_{thJC} max.
► New	V	A	K/W	V	A	A	V	K/W	V	A	K/W
600 V NPT IGBT											
MUBW 10-06A7	1600	18	1.5	600	20	15	1.9	1.5	600	15	1.5
MUBW 15-06A7		18	1.5		25	18	1.9	1.3		15	1.5
MUBW 20-06A7		24	1.3		35	25	1.9	1.0		18	1.4
MUBW 30-06A7		24	1.3		50	35	1.9	0.7		18	1.3
MUBW 50-06A7		29	1.1		75	50	1.9	0.5		25	1.0
1200 V NPT IGBT											
MUBW 10-12A7	1600	18	1.5	1200	20	15	2.3	1.2	1200	15	1.2
MUBW 15-12A7		24	1.3		35	25	2.0	0.7		15	1.2
MUBW 25-12A7		24	1.3		50	35	2.2	0.55		15	1.2
MUBW 35-12A7		29	1.1		50	35	2.5	0.55		25	0.7
1200 V NPT³ IGBT											
MUBW 35-12E7	1600	29	1.1	1200	52	36	2.2	0.55	1200	25	0.7
1200 V Trench IGBT											
► MUBW15-12T7	1600	24	1.3	1200	25	15	1.7	1.2	1200	15	1.2
► MUBW 25-12T7		24	1.3		40	25	1.7	0.8		15	1.2

CBI Modules

CBI = Converter Brake Inverter

three phase rectifier, IGBT brake chopper, three phase IGBT inverter, temperature sensor

CBI 3
IGBT - Modules

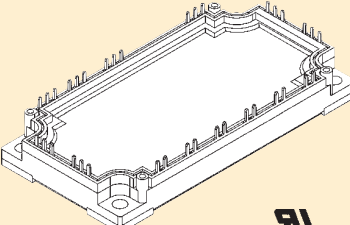
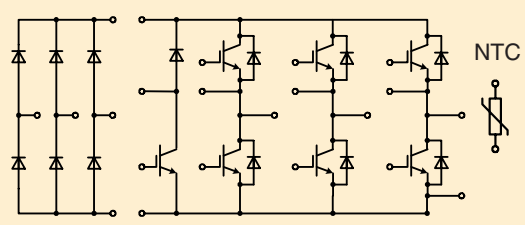


Fig. 77

Package style
Outline drawings on pages O-5...O-17



Type	Rectifier 3~			Inverter 3~					Brake chopper			
	V_{RRM} V	I_{DAVM} $T_C = 80^\circ\text{C}$ $d = 1/3$ A	R_{thJC} max. K/W	V_{CES} V	I_C $T_C = 25^\circ\text{C}$ A	I_C $T_C = 80^\circ\text{C}$ A	$V_{CE(sat)}$ typ. V	R_{thJC} max. K/W	V_{CES} V	I_C $T_C = 80^\circ\text{C}$ A	R_{thJC} max. K/W	
600 V NPT IGBT												
► New	MUBW 50-06A8	1600	40	1.1	600	75	50	1.9	0.5	600	25	1.0
	MUBW 75-06A8		46	0.94		100	65	2.0	0.39		35	0.75
	MUBW 100-06A8		60	0.73		125	85	1.9	0.3		50	0.55
1200 V NPT IGBT												
	MUBW 35-12A8	1600	27	1.3	1200	50	35	2.5	0.55	1200	25	0.7
	MUBW 50-12A8		46	0.94		85	60	2.2	0.35		35	0.55
1200 V NPT³ IGBT												
	MUBW 50-12E8	1600	50	0.94	1200	90	62	1.9	0.35	1200	35	0.55
1200 V Trench IGBT												
►	MUBW 50-12T8	1600	50	0.94	1200	75	50	1.7	0.45	1200	35	0.55
►	MUBW 75-12T8		50	0.94		105	75	1.7	0.35		35	0.55

Gate Driver Board GDBD 4410

drives 7 Gates of a Converter – Break – Inverter IGBT Power Module for Industrial Applications

GDBD 4410 simplifies driving CBI2 and CBI3 module types. Pin locations of the driver board match that of the CBI modules. Thus it can be mounted very close to the gate control pins of the module, providing the shortest possible traces from driver to the gate and an easy routing on the main inverter board. GDBD4410 is a fast and easy to use solution and ideal for small and medium inverter series.



Main features are:

- Drives CBI modules up to 100A/600V and 50A/1200V
- Driver for brake IGBT included
- Design is based on IXBD4410/11 chipset
- High output gate current up to ± 2A peak per gate
- Integrated charge pump for negative gate drive to speed up IGBT turn off and the suppress spurious gate noise triggering
- Noise immune pulse transformer for high dV/dt applications (>50kV/μs)
- $V_{CE(sat)}$ sensing for short circuit protection
- Failure status signal
- Ground referenced and TTL/CMOS compatible interface for control signals
- +15V unipolar power supply required
- Operating frequency up to 25 kHz

IGBT Modules - Full Bridge configuration

Full Bridge

IGBT - Modules

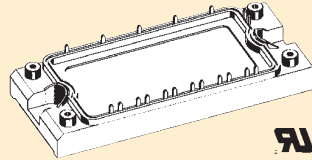
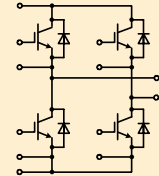


Fig. 81

Package style

Outline drawings on pages O-1...O-3



► New

Type	V _{CES} V	I _{C25} A 25°C IGBT	I _{C80} A 80°C IGBT	V _{CE(sat) typ} V 25°C IGBT	E _{off} mJ 125°C IGBT	R _{thJC} K/W IGBT	I _{F25} A 25°C diode	I _{F80} A 80°C diode
600 V NPT IGBT								
MKI 50-06A7	600	72	50	1.9	1.7	0.55	72	45
MKI 75-06A7		90	60	2.1	2.5	0.44	140	85
1200 V Fast NPT IGBT								
► MKI 50-12F7	1200	65	45	3.2	2.5	0.35	110	70
1200 V NPT³ IGBT								
► MKI 50-12E7	1200	90	62	1.9	4.0	0.35	110	70

Full Bridge

IGBT - Modules

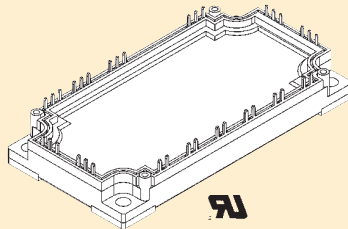
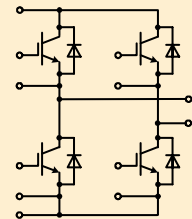


Fig. 77

Package style

Outline drawings on pages O-1...O-3



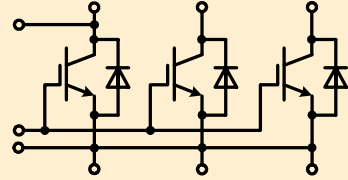
► New

Type	V _{CES} V	I _{C25} A T _C = 25°C IGBT	I _{C80} A T _C = 80°C IGBT	V _{CE(sat) typ} V T _J = 25°C IGBT	E _{off} mJ T _J = 125°C IGBT	R _{thJC} K/W IGBT	I _{F25} A T _C = 25°C diode	I _{F80} A T _C = 80°C diode
1200 V Fast NPT IGBT								
► MKI 100-12F8	1200	125	85	3.3	5.0	0.19	200	130
1200 V NPT³ IGBT								
MKI 75-12E8	1200	130	90	2.0	7.5	0.25	150	100
MKI 100-12E8		165	115	2.0	10.0	0.19	200	130

NPT³ IGBT Modules

- low loss and smooth switching
- AISiC base plate for high power cycling capacity
- AlN substrate for low thermal resistance

High Power Single Switch



Type	V_{CES} V	I_{C25} A $T_c = 25^\circ C$ IGBT	I_{C80} A $T_c = 80^\circ C$ IGBT	$V_{CE(sat)}$ typ V $T_J = 25^\circ C$ IGBT	E_{off} mJ $T_J = 125^\circ C$ IGBT	R_{thJC} K/W IGBT	I_{F25} A $T_c = 25^\circ C$ diode	I_{F80} A $T_c = 80^\circ C$ diode	Fig.
► New									
MIO 1800-17E10	1700	2500	1800	2.3	670	0,009	tbd	tbd	96
MIO 2400-17E10	1700	3300	2400	2.3	980	0,007			
► MIO 1200-25E10	2500	1650	1200	2.5	1250	0,009			
► MIO 1500-25E10	2500	2100	1500	2.7	1450	0,008			
MIO 1200-33E10	3300	1650	1200	3.1	1950	0,0085			

High Voltage Package with enlarged strike and creepage distance

► MIO 1200-33E11	3300	1650	1200	3.1	2000	0,0085	tbd	tbd	97
► MIO 600-65E11	6500	840	600	4.2	3500	0,011			

Package style

Outline drawings on pages O-1...O-3

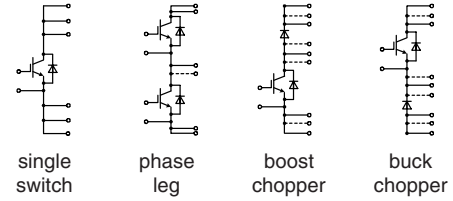
Fig. 96
Weight = 1500 g




Fig. 97
Weight = 1500 g



IGBT Modules

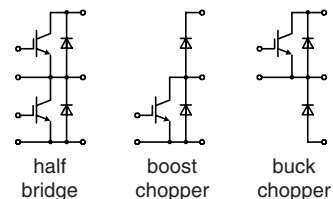


Type	V _{CEs}	I _{C25} T _C = 25 °C	I _{Ca0} T _C = 80 °C	V _{CE(sat)} typical T _J = 25 °C	t _{d(on)} t _{d(off)} delay time Switching Character- istics	R _{thJC}	I _{F25}	I _{F80}	R _{thJC}	Package style	
□ New	V	IGBT A	IGBT A	IGBT V	ns	per IGBT K/W	T _J = 25°C diode A	T _J = 80°C diode A	per diode K/W	Fig. No.	
Single switch modules											
VIO 25-06P1	600	25	18	1.9	30 270	1.3	35	24	2.1	25 Fig. 25 ECO-PAC 2 Weight = 24 g  See data sheet for pin arrangement	
VIO 25-12P1	1200	32	22	2.1	100 500	0.7	28	18	2.1		
VIO 50-06P1	600	45	30	1.9	50 270	0.88	36	24	2.11		
VIO 50-12P1	1200	50	35	2.5	100 500	0.55	50	35	1.19		
VIO 75-06P1	600	72	50	1.9	50 300	0.55	72	45	1.19		
VIO 75-12P1	1200	85	60	2.2	100 500	0.35	100	70	0.61		
VIO 100-06P1	600	100	65	2.0	150 450	0.39	50	35	0.39		
VIO 125-12P1	1200	125	85	2.2	100 650	0.2	150	100	0.41		
VIO 130-06P1	600	130	88	2.0	25 150	0.3	140	88	0.61		
VIO 160-12P1	1200	160	110	2.2	110 600	0.19	200	130	0.3		
Phase leg modules											
VII 25-06P1	600	25	18	1.9	30 270	1.3	35	24	2.1		
VII 25-12P1	1200	32	22	2.1	100 500	0.7	28	18	2.1		
VII 50-06P1	600	45	30	1.9	50 270	0.88	36	24	2.11		
VII 50-12P1	1200	50	35	2.5	100 500	0.55	50	35	1.19		
VII 75-06P1	600	72	50	1.9	50 300	0.55	72	45	1.19		
VII 75-12P1	1200	85	60	2.2	100 500	0.35	100	70	0.61		
VII 100-06P1	600	100	65	2.0	150 450	0.39	50	35	0.39		
VII 130-06P1	600	130	88	2.0	25 150	0.3	140	88	0.61		
Boost chopper modules											
VID 25-06P1	600	25	18	1.9	30 270	1.3	35	24	2.1		
VID 25-12P1	1200	32	22	2.1	100 500	0.7	28	18	2.1		
VID 50-06P1	600	45	30	1.9	50 270	0.88	36	24	2.11		
VID 50-12P1	1200	50	35	2.5	100 500	0.55	50	35	1.19		
VID 75-06P1	600	72	50	1.9	50 300	0.55	72	45	1.19		
VID 75-12P1	1200	85	60	2.2	100 500	0.35	100	70	0.61		
VID 100-06P1	600	100	65	2.0	150 450	0.39	50	35	0.39		
VID 125-12P1	1200	125	85	2.2	100 650	0.2	150	100	0.41		
VID 130-06P1	600	130	88	2.0	25 150	0.3	140	88	0.61		
VID 160-12P1	1200	160	110	2.2	100 600	0.19	200	130	0.3		
Buck chopper modules											
VDI 25-06P1	600	25	18	1.9	30 270	1.3	35	24	2.1		
VDI 25-12P1	1200	32	22	2.1	100 500	0.7	28	18	2.1		
VDI 50-06P1	600	45	30	1.9	50 270	0.88	36	24	2.11		
VDI 50-12P1	1200	50	35	2.5	100 500	0.55	50	35	1.19		
VDI 75-06P1	600	72	50	1.9	50 300	0.55	72	45	1.19		
VDI 75-12P1	1200	85	60	2.2	100 500	0.35	100	70	0.61		
VDI 100-06P1	600	100	65	2.0	150 450	0.39	50	35	0.39		
VDI 125-12P1	1200	125	85	2.2	100 650	0.2	150	100	0.41		
VDI 130-06P1	600	130	88	2.0	25 150	0.3	140	88	0.61		
VDI 160-12P1	1200	160	110	2.2	110 600	0.19	200	130	0.3		

IGBT Modules

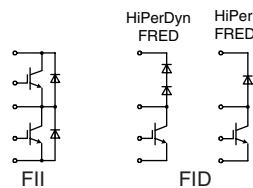
NPT IGBT Modules

NPT IGBT = non-punch through insulated gate bipolar transistor, square RBSOA, short circuit rated



Type	V _{CES} V	I _{C25} A T _C = 25°C IGBT	I _{C80} A T _C = 80°C IGBT	V _{CE(sat)} typ V T _J = 25°C IGBT	E _{off} mJ T _J = 125°C IGBT	R _{thJC} K/W IGBT	I _{F25} A T _C = 25°C diode	I _{F80} A T _C = 80°C diode	ther- mistor	Fig. No.	Package style
1200 V Half Bridge											
□ New											Outline drawings on pages O-5...O-17
1200 V Half Bridge											
MII 75-12A3	1200	90	60	2.2	5.6	0.33	100	60		28	Fig. 28 Weight = 130 g
MII 100-12A3	1200	135	90	2.2	10.5	0.22	150	100		28	
MII 145-12A3	1200	160	110	2.2	15.0	0.18	150	100		28	
MII 150-12A4	1200	180	120	2.2	11.5	0.17	200	130		33	
MII 200-12A4	1200	270	180	2.2	21.0	0.11	300	200		33	
MII 300-12A4	1200	330	220	2.2	29.0	0.09	450	270		33	
1200 V Boost chopper											
MID 75-12A3	1200	90	60	2.2	5.6	0.33	100	60		28	Fig. 33 Weight = 250 g
MID 100-12A3	1200	135	90	2.2	10.5	0.22	150	100		28	
MID 145-12A3	1200	160	110	2.2	15.0	0.18	150	100		28	
MID 150-12A4	1200	180	120	2.2	11.5	0.17	200	130		33	
MID 200-12A4	1200	270	180	2.2	21.0	0.11	300	200		33	
MID 300-12A4	1200	330	220	2.2	29.0	0.09	450	270		33	
1200 V Buck chopper											
MDI 75-12A3	1200	90	60	2.2	5.6	0.33	100	60		28	Fig. 80 Weight = 250 g
MDI 100-12A3	1200	135	90	2.2	10.5	0.22	150	100		28	
MDI 145-12A3	1200	160	110	2.2	15.0	0.18	150	100		28	
MDI 150-12A4	1200	180	120	2.2	11.5	0.17	200	130		33	
MDI 200-12A4	1200	270	180	2.2	21.0	0.11	300	200		33	
MDI 300-12A4	1200	330	220	2.2	29.0	0.09	450	270		33	
1200 V Half Bridge with 3rd generation NPT³											
MII 400-12E4	1200	420	300	2.2	30.0	0.08	450	290		80	
1200 V Boost chopper with 3rd generation NPT³											
□ MID 400-12E4 □	1200	420	300	2.2	30.0	0.08	450	290		80	
1200 V Buck chopper with 3rd generation NPT³											
□ MDI 400-12E4 □	1200	420	300	2.2	30.0	0.08	450	290		80	

□ I_{F80} of IGBT free wheeling diode: 95 A



NPT IGBT Modules in i4-PAC

Type	Configu- ration	Technology	V _{CES} V	I _{C25} @ 25°C A	I _{C80} @ 90°C A	V _{CE(sat)} typ. T _C = 25°C	Fig. No.
□ New							
□ FII 30-06D	<i>phaseleg</i>	NPT IGBT	600	30	18	1.9	Fig. 84 ISOPLUS i4-PAC™ Weight = 9 g
□ FII 40-06D	<i>phaseleg</i>	NPT IGBT	600	40	25	1.8	
□ FII 30-12E	<i>phaseleg</i>	NPT ³ IGBT	1200	32	20	2.4	
□ FII 50-12E	<i>phaseleg</i>	NPT ³ IGBT	1200	50	32	2.0	
□ FID 35-06C	<i>boost</i>	NPT IGBT & HiPerDynFRED	600	38	24	1.9	
□ FID 36-06D	<i>boost</i>	NPT IGBT & HiPerFRED	600	38	24	1.9	
□ FID 60-06D	<i>boost</i>	NPT IGBT & HiPerFRED	600	65	40	1.6	

IGBT

IGBT Modules - H-bridge configuration

Type	V_{CES} V	I_{C25} A $T_c = 25^\circ\text{C}$ IGBT	I_{C80} A $T_c = 80^\circ\text{C}$ IGBT	$V_{CE(sat)}$ typ V $T_J = 25^\circ\text{C}$ IGBT	E_{off} mJ $T_J = 125^\circ\text{C}$ IGBT	R_{thJC} K/W IGBT	I_{F25} A $T_c = 25^\circ\text{C}$ diode	I_{F80} A $T_c = 80^\circ\text{C}$ diode	Circuit diagram	Fig. No.
□ New										
VKI 50-06P1	600	45	30	1.9	1.0	0.88	36	24	A	25
VKI 75-06P1	600	72	50	1.9	1.7	0.55	72	45		
VKI 50-12P1	1200	50	35	2.5	2.8	0.55	50	35		
□ MKI 50-06A7	600	75	50	1.9	1.7	0.55	72	45	A	81
□ MKI 50-12E7	1200	90	62	2.1	5.0	0.35	110	70		
□ MKI 75-06A7	600	90	60	2.1	2.5	0.44	140	85	A	81
□ MKI 75-12E8	1200	130	90	2.0	7.5	0.25	150	100		77
MKI 100-12E8	1200	165	115	2.1	10.0	0.19	200	130	A	77

Sixpac in ECO-PAC

Type	V_{CES} V	I_{C25} A $T_c = 25^\circ\text{C}$ IGBT	I_{C80} A $T_c = 80^\circ\text{C}$ IGBT	$V_{CE(sat)}$ typ V $T_J = 25^\circ\text{C}$ IGBT	E_{off} mJ $T_J = 125^\circ\text{C}$ IGBT	R_{thJC} K/W IGBT	I_{F25} A $T_c = 25^\circ\text{C}$ diode	I_{F80} A $T_c = 80^\circ\text{C}$ diode	Circuit diagram	Fig. No.
□ New										
VWI 20-06P1	600	19	14	1.9	0.3	1.7	21	14	B	25
VWI 35-06P1	600	35	25	1.9	0.68	1.0	35	24		
VWI 15-12P1	1200	18	14	2.3	1.1	1.2	12	8		
VWI 6-12P1	1200	6	4.1	3.9	0.2	3.1	12	8		
□ VWI 3x20-06P1*	600	20	15	1.9	0.3	1.5	20	15	C	24

* NTC optional

Package style

Outline drawings on page O-5...O-17

See data sheet for pin arrangements

Fig. 24 ECO-PAC 1



Fig. 25 ECO-PAC 2



Fig. 81

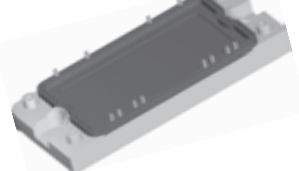
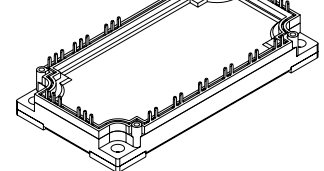
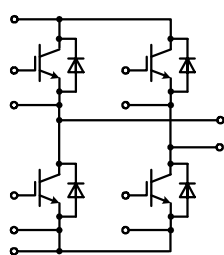


Fig. 77

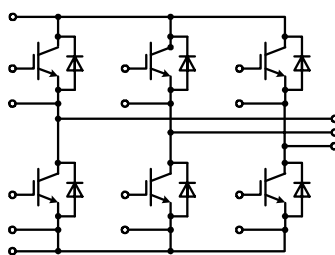


Circuit diagrams

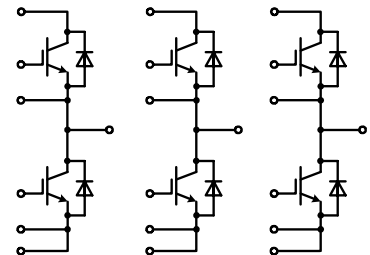
A



B



C



SANYO provides an extensive variety of motor driver ICs classified by functionality and by device structure to quickly respond to customer needs.

Brush Motor Driver ICs

Single-direction drive

Category	Type No.	Supply voltage (V)	Output Current (A)
Electric governors	LA558B	1.8	1.4
	LA5586	16	1.4
	LA5528M	10	1.0
	LA5528NM	6	0.4
	LA5527	10	1.0
	LA5527M	6	0.7
Driver arrays	LB12XX Series	-	-

Power operational amplifier

Category	Type No.	Supply voltage (V)	Output Current (A)
3-ch power operational amplifier	LA6539M	14	1
	LA6529M	14	1
4-ch power operational amplifier	⊕ LA6579H	14	1
	⊕ LA6564H	14	1
	LA6563	14	1
	LA6551	14	1
	LA6548	14	0.7
	LA6548D	14	0.7
	LA6547	14	1
	LA6546H	14	0.7
	LA6545H	14	1
	LA6545M	14	1
	LA6544H	14	1
	LA6544M	14	1
	LA6543	14	1
	LA6543M	14	1
	LA6542M	14	1
	LA6541	14	0.7
	LA6541D	14	0.7
	LA6540M	36	0.7
5-ch power operational amplifier	LA6537	14	0.7
	LA6537M	14	0.7
	⊖ LA6507	18	1
	⊖ LA6575H	14	0.7
	⊕ LA6574H	14	0.7
	⊕ LA6572	14	1
	LA6571	14	1
	LA6570	14	1
	⊕ LA6560	14	1
	LA6559	14	1
LA6557H	14	0.7	
⊖ LA6506	15	1.5	
⊖ LA6505	14	1	
8-ch power operational amplifier	LA6578	14	0.7
	⊕ LA6568	14	0.7

Forward/Reverse Drive

Category	Type No.	Supply voltage (V)	Output Current (A)
Forward/reverse governors	LA5550		
	LA5550M		
Forward/reverse 1-ch motor drivers	LB1943	18	1.8
	LB1943V	10.5	0.5
	LB1648	25	1.6
	LB1645M	18	1.6
	LB1643	18	1.6
	LB1642B	18	0.7
	LB1642	18	0.7
	LB1641	18	1.6
Low-saturation forward/reverse 1-ch motor drivers	LB1640N	20	1.6
	⊕ LV8011V	7.5	3
	⊕ LB1938T	10	0.8
	LB1930M	10.8	1
	LB1843V	10.8	0.8
	LB1841V	10.8	0.8
	LB1830M	10.8	0.5
	LB1638	10.8	1
	LB1638M	10.8	1
	LB1634M	8	2
LB1630	7	2	
Low-saturation forward/reverse 1.5-ch motor drivers	LB8632V	7.5	3
	⊕ LB1934T	7	2
	LB1932V	8	2
	LB1834M	8	2
	LB1832V	8	2
Forward/reverse 2-ch motor drivers	LB1657M	5.5	0.5
	LB1656	5.5	0.5
	LB1656M	5.5	0.5
	LB1651	36	2
	LB1650	36	2
	LB1649	25	1
	LB1648	18	0.8
LB1644	25	1.6	
Low-saturation forward/reverse 2-ch motor drivers	⊖ LV8012T	7	1.4
	LB8620M	7	1.5
	LB1837M	10.5	0.5
	LB1838M	10.5	1
Forward/reverse 4-ch motor drivers	LB1835M	8	2
	⊕ LV8018W	3.6	0.5/ch
	⊖ LB8120V	9	0.4/ch
	LB8118	9	0.4/ch
	LB8109M	10	0.4/ch
	LB8108M	8	0.4/ch
PWM + forward/reverse 2-ch + 3-phase stepper driver	LB8106M	7.0	0.4/ch
	⊕ LV8206T	5	1.0/ch
PWM + forward/reverse 4-ch driver	⊖ LV8200W	8	1.0/ch

⊕: New product, ⊖: Under development

Brushless Motor Driver ICs

Single-Phase Drive

Category	Type No.	Supply voltage (V)	Output Current (A)
Fan motor drivers	LB1964M	9	0.5
	LB1964T	9	0.3
	LB1962M	16.8	0.5
	LB1862M	17	0.5
	LB1862	17	0.8

Two-Phase Drive

Category	Type No.	Supply voltage (V)	Output Current (A)
Variable-speed fan motor drivers	◆ LB1965M	18	1.5
	◆ LB1961M	18	1.2
	LB1861/M	18	1.5
	LB1860/M	28	1.5
Standard fan motor drivers	◆ LB11668M	28	0.8
	LB1967M	18	1.2
	LB1968M	18	1.2
	LB1960M	18	1
	LB1868M	28	1.0
	LB1867M	28	1.0
	LB1863M	28	1.5
	LB1669	18	1.5
	LB1668/M	28	1.5
	LB1667	28	1.5
	LB1667M	28	1.5
	LB1663	28	1.5
	LB1663M	28	1.5
	LB1660N	30	1.5

Three-Phase Drive

Category	Type No.	Supply voltage (V)	Output Current (A)
Linear drivers	LB11999/H	14.5	1.3
	LB11996/H	14.5	1.3
	LB11995/H	14.5	1.3
	LB11988	14.5	1
	LB11985H	15	1.5
	LB11980H	24	1.3
	◆ LB11868H	24	1.2
	LB11889M	24	1.3
	◆ LB11699H	14.5	2.0
	LB11698H	14.5	1.3
	LB1999M	24	1.3
	LB1998	14.5	1.3
	LB1991V	11	1
	LB1989	13.8	1
	LB1987/H/D	24	1.3
	LB1980/H	24	1.3
	LB1955	14.5	1
	LB1894M	20	1.5
	LB1882V	12	1.0
	LB1857M	16	1.5
	LB1855NM	20	1.2
LB1854M	20	1.5	
LB1851M	18	1.5	
Switching	LB1696	60	2.5
	LB1695	45	2
	LB1695D	45	2
	LB1695M	45	2
	LB1694N	45	2.5
	LB1692	60	2.5
	LB1690	45	2.5
	LB1686M	22	1.5
	LB1684	22	1.5
	LB1620	28	1.5
PWM drive	◆ LB11920	35	3.5
	LB11975	12	2.5
	◆ LB11824M	20	40m
	◆ LB11823M	20	40m
	◆ LB11820M	20	40m
	◆ LB11886N/NH	30	1.2
	LB1976	60	2.5
	LB1975	46	2.5
	LB1693	45	2.5
	◆ LV8280T	6.0	1.0

◆: New product, ◆: Under development.

Brushless Motor Driver ICs

Three-Phase Drive

Category	Type No.	Supply voltage (V)	Output Current (A)
Linear with speed controls	* LB11872H	30	1.2
	LB11817	7	1
	LB1913	7	1
	LB1910N	7	1
	LB1890M	7	1
	LB1872	30	2
	LB1871/M	30	1
	LB1870	30	1
	LB1870M	30	1
	LB1817M/W	7	1
	LB1816	16	1.5
	LB1814M	14.5	1
	LB1813M	7	1
	LB1810M	14.5	1
Switching with speed controls	LB1825	30	2
PWM driver with speed controls	* LB11923V	7	30m
	* LB11870	30	1.5
	* LB11827	30	3.5
	* LB11826	30	2.5
	* LB11822	30	3.0
	* LB1929	30	2
	LB1928	30	1
	LB1927	30	2.5
	LB1924	30	3.1
	LB1923M	9	30m
	LB1922	20	3.1
	LB1921	30	3.5
	LB1920	30	3.1
	LB1876	30	2.5
	LB1875	14.5	30m
	LB1824	30	2.5
	LB1823/M	9	30m
LB1821M	9	30m	
LB1820	2.5	—	

Single-Phase Drive

Category	Type No.	Supply voltage (V)	Output Current (A)
Fan motor drivers	* LB6581M	18	0.4
	* LB6581T	18	0.3
	* LB6582T	10.5	0.3
	* LB6538T	10.5	0.3
Miniature fan rotor drivers	* LB11964T	15	0.5
	* LB11963T	15	0.5
PWM drive fan motor driver	* LB11965M	18	1.0

Forward/Reverse Drive

Category	Type No.	Supply voltage (V)	Output Current (A)
Low-saturation forward/reverse 1-ch motor drivers	* LB1941T	10.5	0.3

Single-Direction Drive

Category	Type No.	Supply voltage (V)	Output Current (A)
Low-saturation constant current driver	* LB1931T	10.5	0.6

Clock Generator

Category	Type No.	Supply voltage (V)	Output Current (A)
Clock generator	* LB11825M	9	3m

System Driver IC

System Drive

Category	Type No.	Supply voltage (V)	Output Current (A)
Sensorless spindle + actuator	* LV8200W	6	1.0
	* LV8206T	5	1.0

*: New product, =: Under development

Driver IC

Sensorless Motor Driver ICs

Three-Phase Unipolar

Category	Type No.	Supply voltage (V)	Output Current (A)
With speed controls	◆ LB11676V	5.0	0.6
	◆ LB11675V	5.0	0.6
	LB1877M	5	0.5
	◆ LB1877V	5	0.5
	LB1674V	5.0	0.6
	LB1673M	5.0	1

Three-Phase Bipolar

Category	Type No.	Supply voltage (V)	Output Current (A)
Linear drivers	LB11990W	8.5	1
	LB11983	14.5	1.0
	LB11952W	8.5	1
	◆ LB11881	14.5	1/1.2
	LB11880	14.5	1/1.2
	LB1989	13.5	1
	LB1981V	3.5	3.5
	LB1971V	7	0.7
	LB1950V	12	0.7
PWM	◆ LV8280T	6	1.0
	◆ LB11977	20	1.0
PWM system drivers	◆ LV8200W	6	1.0
	◆ LV8206T	5	1.0

Switching Power Supply + Actuator Driver

PWM Driver

Category	Type No.	Supply voltage (V)	Output Current (A)
Forward/reverse 4-channel motor drivers	◆ LV8250	9	0.4/ch

Sensor Amplifier + Motor Driver

Amplifier + Forward/Reverse Drivers

Category	Type No.	Supply voltage (V)	Output Current (A)
Sensor amplifier + forward/reverse driver	LB8112V	11	0.6

Stepping Motor Driver ICs

1/1-2-Phase Excitation

Category	Type No.	Supply voltage (V)	Output Current (A)
Standard	LB1651	36	2
	LB1651D	36	2
	LB1650	36	2
Low-saturation motor drivers	◆ LB1939T	7.5	0.4
	LB1846M	8	0.8
	LB1837M	10.5	0.5
	LB1836M	10.5	1
Low-saturation forward/reverse 2-ch motor drivers	◆ LB1936V	10.5	0.8
Low-saturation forward/reverse 2-ch constant current motor drivers	◆ LB1940T	10.5	0.4
Low-saturation forward/reverse 4-ch motor drivers	◆ LB1937T	10.5	0.8

Two-Phase Excitation

Category	Type No.	Supply voltage (V)	Output Current (A)
Standard	LB1657M	5.5	0.5
	LB1656	5.5	0.5
	LB1656M	5.5	0.5
Low-saturation motor drivers	LB1848M	8	0.8
	LB1840M	10.5	0.5
	LB1839M	10.5	0.5
	LB1838M	10.5	1

Micro-step

Category	Type No.	Supply voltage (V)	Output Current (A)
Separately-excitation	◆ LB1945D	30	0.8
	LB1945H	30	0.8
Self-excitation	◆ LB11948	50	1.0
	◆ LB11945H	30	0.5
	LB11847	50	1.5
	LB1947	50	2.0
	◆ LB1946	50	1.5
	LB1847	50	1.5
LB1845	45	1.5	

◆: New product, * : Under development

Part Number	Type	BVdss / V	Id / A	Configuration	Micrel Cross Type	Package
IXDF402PI	Dual	4,5 -35	2	Non-Inv. & Inverting	MIC428BN, MIC428CN, MIC1428CN, MIC4428BN, MIC4428CN	8-Pin DIP
IXDF402SI	Dual	4,5 -35	2	Non-Inv. & Inverting	MIC428BM, MIC428CM, MIC1428CM, MIC4428BM, MIC4428CM	8-Pin SOIC-CT
IXDI402PI	Dual	4,5 -35	2	Inverting	MIC426BN, MIC426CN, MIC1426CN, MIC4426BN, MIC4426CN	8-Pin DIP
IXDI402SI	Dual	4,5 -35	2	Inverting	MIC426BM, MIC426CM, MIC1426CM, MIC4426BM, MIC4426CM	8 Pin SOIC
IXDN402PI	Dual	4,5 -35	2	Non-Inverting	MIC427BN, MIC427CN, MIC1427CN, MIC4427BN, MIC4427CN	8-Pin DIP
IXDN402SI	Dual	4,5 -35	2	Non-Inverting	MIC427BM, MIC427CM, MIC1427CM, MIC4427BM, MIC4427CM	8-Pin SOIC-CT
IXDF402SIA	Dual	4,5 -35	2	Non Non Inverting With Enable		8-Pin SOIC
IXDI404PI	Dual	4,5 -35	4	Inverting	MIC4423BN, MIC4423CN	8-Pin DIP
IXDF404PI	Dual	4,5 -35	4	Non-Inv. & Inverting	MIC4425BN, MIC4425CN	8-Pin DIP
IXDF404SI	Dual	4,5 -35	4	Non Non Inverting With Enable		8-Pin SOIC-CT
IXDF404SI-16	Dual	4,5 -35	4	Non-Inv. & Inverting	MIC4425BWM, MIC4425CWM	16-Pin SOIC-CT
IXDD404PI	Dual	4,5 -35	4	Non Non Inverting With Enable		8-Pin PDIP
IXDD404SI	Dual	4,5 -35	4	Non Non Inverting With Enable		8-Pin SOIC GMB
IXDD404SI-16	Dual	4,5 -35	4	Non Non Inverting With Enable		16-Pin SOIC GMB
IXDD404SIA	Dual	4,5 -35	4	Non Non Inverting With Enable		8-Pin SOIC
IXDD404SIA-16	Dual	4,5 -35	4	Non Non Inverting With Enable		16-Pin SOIC
IXDI409PI	Single	4,5 -35	9	Non-Inverting	MIC4421BN, MIC4421CN	8-Pin DIP
IXDI409SI	Single	4,5 -35	9	Inverting	MIC4421BM, MIC4421CM	8-Pin SOIC
IXDD409CI	Single	4,5 -35	9	Non-Inverting		5-Lead TO-220
IXDD409PI	Single	4,5 -35	9	Non-Inverting		8-Pin DIP
IXDD409SI	Single	4,5 -35	9	Non-Inverting		8-Pin SOIC-CT
IXDD409YI	Single	4,5 -35	9	Non-Inverting		5-Lead TO-263
IXDD414CI	Single	4,5 -35	14	Non-Inverting		5-Lead TO-220
IXDD414PI	Single	4,5 -35	14	Non-Inverting		8-Pin DIP
IXDD414SI	Single	4,5 -35	14	Non-Inverting		14-Pin SOIC-CT
IXDD414YI	Single	4,5 -35	14	Non-Inverting		5-Lead TO-263
IXDD430CI	Single	4,5 -35	30	Non-Inverting		TO-220
IXDD430MCI	Single	4,5 -35	30	Non-Inverting		TO-220
IXDD430MYI	Single	4,5 -35	30	Non-Inverting		TO-263
IXDD430YI	Single	4,5 -35	30	Non-Inverting		TO-263

GMB = Grounded Metal Back

Driver IC

650V Monolithic 3-Phase Bridge Drivers

Monolithic 650V Half-Bridge Drivers
Output Currents: 0.6A

TYPE	Closest IR Cross	Ipk@ 25°C A	Shutdown	Single or Dual	Protection Features	Deadtime	Package Type
IXA531L4	IR21363J	0.6	No	Six/Out of Phase	Cross-Conduct, OCP [Prog. Reset]	No	44-Pin PLCC
IXA531S10	IR21363J	0.6	No	Six/Out of Phase	Cross-Conduct, OCP [Prog. Reset]	No	48-Pin SSLGA



Monolithische Halb-Brücken Treiber IC high Performance

- High-Side = 650 Volt, (2, 4, oder 6A)
- Low-Side = 35 Volt, (2, 4, oder 6A)
- Hervorragende Spannungsfestigkeit des „floating“ High-Side Treiber
- Spannungs-Transienten bis zu minus 200V
- Gate-Spannung von 10 bis 35 Volt
- Latch-Up Geschützt (über den gesamten Arbeitsbereich)

TYPE	Closest IR Cross	Ipk@ 25°C A	Shutdown	Single or Dual	Protection Features	Deadtime	Package Type
IX2A11P1 / S1	IR2184 / S	2	Yes (Low)	Single/High Side	Cross-Conduct	Fixed - 500ns Typ	8-Pin PDIP / 8-Pin SOIC
IX2B11P7 / P7	IR21844 / S				Cross-Conduct	Programmable	14-Pin PDIP / 14-Pin SOIC
IX2C11P1 / S1	IR2181 / S	2	No	Dual/In Phase	No	No	8-Pin PDIP / 8-Pin SOIC
IX2D11P7 / S7	IR21814 / S						14-Pin PDIP / 14-Pin SOIC
IX2R11M6	IR2113S						16-Pin MLP
IX2R11P7	IR2113	2	Yes (High)	Dual/In Phase	No	No	14-Pin PDIP
IX2R11S3	IR2113S						16-Pin SOIC
IX4R11M6	IR2113S	4	Yes (High)	Dual/In Phase	No	No	16-Pin MLP
IX4R11P7 / S3	IR2113 / S						14-Pin PDIP / 16-Pin SOIC
IX6R11M6	IR2113S						16-Pin MLP
IX6R11P7	IR2113	6	Yes (High)	Dual/In Phase	No	No	14-Pin PDIP
IX6R11S3	IR2113S						16-Pin SOIC
IX6R11S6	IR2113S						18-Pin SOIC-CT
IX6S11S6	None	6	No	Dual/In Phase	No	No	18-Pin SOIC-CT
IXA611M6	IR2112S	0.6	Yes (High)	Dual/In Phase	No	No	16-Pin MLP
IXA611P7 / S3	IR2112 / S						14-Pin PDIP / 16-Pin SOIC
IXB611P1 / S1	IR2103 / S	0.6	No	Dual/High-In Phase/LI	Cross-Conduct	Fixed - 520ns Typ	8-Pin PDIP / 8-Pin SOIC
IXC611P1 / S1	IR2111	0.6	No	Single/High Side	Cross-Conduct	Fixed - 650ns Typ	8-Pin PDIP / 8-Pin SOIC
IXD611P1 / P7	IR2106						8-Pin PDIP / 14-Pin PDIP
IXD611S1	IR2106S	0.6	No	Dual/In Phase	No	No	8-Pin SOIC
IXD611S7	IR2106S						14-Pin SOIC
IXE611P1 / S1	IR2301	0.6	No	Dual/In Phase	No	No	8-Pin PDIP / 8-Pin SOIC
IXF611P1 / S1	IR2302 / S	0.6	Yes (Low)	Single/High Side	Cross-Conduct	Fixed - 540ns Typ	8-Pin PDIP / 8-Pin SOIC
IXG611P1 / S1	IR2304 / S	0.6	No	Dual/In Phase	Cross-Conduct	Fixed - 100ns Typ	8-Pin PDIP / 8-Pin SOIC
IXH611P1 / S1	IR2308 / S	0.6	No	Dual/In Phase	Cross-Conduct	Fixed - 540ns Typ	8-Pin PDIP / 8-Pin SOIC
IXJ611P1 / S1	IR2101	0.6	No	Dual/In Phase	No	No	8-Pin PDIP / 8-Pin SOIC
IXK611P1 / S1	IR2102	0.6	No	Dual/Out of Phase	No	No	8-Pin PDIP / 8-Pin SOIC

ISOSMART® Halb-Brücken Treiber Chipsatz: IXBD 4410,4411 und TX02-4400 Isolationstransformator

- >1200V Isolation zwischen Low - und High Side
- dv/dt Stabilität >50V/ns
- 5V HCMOS Logik Kompatibilität mit Hysterese am Eingang
- 20ns Schaltzeit bei 1nF Last; 100ns Schaltzeit bei 10nF Last
- 2 A peak Ausgangsstrom
- Selbstabschaltung bei Überstrom oder Kurzschluß am Ausgang
- Unterspannungsschutz
- Schutz vor Cross Conduction
- Schaltfrequenz >20KHz möglich

TYPE	Description	Temperature Range	Package Type
IXBD4410PI	Full-Feature Low Side Driver	-40 to -85°C	16-Pin P-DIP
IXBD4411PI	Full-Feature High Side Driver	-40 to -85°C	16-Pin P-DIP
IXBD4410SI	Full-Feature Low Side Driver	-40 to -85°C	16-Pin SOP
IXBD4411SI	Full-Feature High Side Driver	-40 to -85°C	16-Pin SOP
TX02-4400 JI	Isolation transformer	-55 to -125°C	8-Pin DIP-SM
TX02-4400 PI	Isolation transformer		8-Pin P-DIP
EVD 4400	EVAL Board		

Competitor's Device Information				Crydom Cross	Crydom Package
Device Type	Isolated	It (rms)	Vrrm		
Rectifier	Yes	9.5 (AV)	1000	CRNA15-1000	TO-220AB
Rectifier	Yes	9.5 (AV)	200	CRNA15-400	TO-220AB
Rectifier	Yes	9.5 (AV)	800	CRNA15-800	TO-220AB
Rectifier	Yes	12.7 (AV)	1000	CRNA20-1000	TO-220AB
Rectifier	Yes	12.7 (AV)	200	CRNA20-400	TO-220AB
Rectifier	Yes	12.7 (AV)	600	CRNA20-600	TO-220AB
Rectifier	Yes	12.7 (AV)	800	CRNA20-800	TO-220AB
Rectifier	Yes	15.9 (AV)	1000	CRNA25-1000	TO-220AB
Rectifier	Yes	15.9 (AV)	200	CRNA25-400	TO-220AB
Rectifier	Yes	15.9 (AV)	600	CRNA25-600	TO-220AB
Rectifier	Yes	15.9 (AV)	800	CRNA25-800	TO-220AB
Rectifier	No	10 (AV)	800	CRNB15-800	TO-220AB
SCR	Yes	8	1000	CYNA16-1000	TO-220AB
SCR	Yes	15	400	CYNA16-400	TO-220AB
SCR	Yes	15	800	CYNA16-800	TO-220AB
SCR	Yes	20	1000	CYNA25-1000	TO-220AB
SCR	Yes	25	400	CYNA25-400	TO-220AB
SCR	Yes	20	650	CYNA25-600	TO-220AB
SCR	Yes	25	800	CYNA25-800	TO-220AB
SCR	No	8	1000	CYNB16-1000	TO-220AB
SCR	No	12	50	CYNB16-400	TO-220AB
SCR	No	16	600	CYNB16-600	TO-220AB
SCR	No	16	800	CYNB16-800	TO-220AB
SCR	No	25	1000	CYNB25-1000	TO-220AB
SCR	No	25	200	CYNB25-400	TO-220AB
SCR	No	25	800	CYNB25-800	TO-220AB
Triac	Yes	12	600	CHTA12-600	TO-220AB
Triac	Yes	16	700	CHTA12-800	TO-220AB
Triac	No	12	600	CHTB12-600	TO-220AB
Triac	No	25	700	CHTB24-600	TO-220AB
Triac	Yes	6	1000	CTA06-1000B	TO-220AB
Triac	Yes	4	1000	CTA06-1000C	TO-220AB
Triac	Yes	6	1000	CTA06-1000CW	TO-220AB
Triac	Yes	6	400	CTA06-400B	TO-220AB
Triac	Yes	6	400	CTA06-400C	TO-220AB
Triac	Yes	6	200	CTA06-400CW	TO-220AB
Triac	Yes	4	400	CTA06-400SW	TO-220AB
Triac	Yes	4	400	CTA06-400TW	TO-220AB
Triac	Yes	5	600	CTA06-500C	TO-220AB
Triac	Yes	6	600	CTA06-600B	TO-220AB
Triac	Yes	4	600	CTA06-600BW	TO-220AB
Triac	Yes	4	600	CTA06-600C	TO-220AB
Triac	Yes	6	600	CTA06-600CW	TO-220AB
Triac	Yes	4	600	CTA06-600SW	TO-220AB
Triac	Yes	4	600	CTA06-600TW	TO-220AB
Triac	Yes	6	700	CTA06-800B	TO-220AB
Triac	Yes	4	800	CTA06-800BW	TO-220AB
Triac	Yes	4	800	CTA06-800C	TO-220AB
Triac	Yes	6	800	CTA06-800CW	TO-220AB
Triac	Yes	4	800	CTA06-800SW	TO-220AB
Triac	Yes	4	800	CTA06-800TW	TO-220AB
Triac	Yes	8	1000	CTA08-1000B	TO-220AB
Triac	Yes	8	1000	CTA08-1000CW	TO-220AB
Triac	Yes	8	400	CTA08-400B	TO-220AB
Triac	Yes	8	400	CTA08-400C	TO-220AB
Triac	Yes	8	400	CTA08-400CW	TO-220AB
Triac	Yes	8	400	CTA08-400SW	TO-220AB
Triac	Yes	8	200	CTA08-400TW	TO-220AB
Triac	Yes	8	600	CTA08-600B	TO-220AB
Triac	Yes	8	600	CTA08-600BW	TO-220AB
Triac	Yes	8	600	CTA08-600C	TO-220AB
Triac	Yes	8	600	CTA08-600CW	TO-220AB
Triac	Yes	8	600	CTA08-600SW	TO-220AB
Triac	Yes	8	600	CTA08-600TW	TO-220AB
Triac	Yes	8	800	CTA08-800B	TO-220AB
Triac	Yes	8	800	CTA08-800BW	TO-220AB
Triac	Yes	8	800	CTA08-800C	TO-220AB
Triac	Yes	8	700	CTA08-800CW	TO-220AB
Triac	Yes	8	800	CTA08-800SW	TO-220AB
Triac	Yes	8	700	CTA08-800TW	TO-220AB



Competitor's Device Information				Crydom Cross	Crydom Package
Device Type	Isolated	It (rms)	Vrrm		
Triac	Yes	10	1000	CTA12-1000B	TO-220AB
Triac	Yes	10	1000	CTA12-1000BW	TO-220AB
Triac	Yes	10	1000	CTA12-1000C	TO-220AB
Triac	Yes	10	400	CTA12-400 B	TO-220AB
Triac	Yes	12	400	CTA12-400BW	TO-220AB
Triac	Yes	10	400	CTA12-400C	TO-220AB
Triac	Yes	12	400	CTA12-400CW	TO-220AB
Triac	Yes	10	600	CTA12-600 B	TO-220AB
Triac	Yes	12	600	CTA12-600BW	TO-220AB
Triac	Yes	10	600	CTA12-600C	TO-220AB
Triac	Yes	10	600	CTA12-600CW	TO-220AB
Triac	Yes	12	600	CTA12-600SW	TO-220AB
Triac	Yes	12	600	CTA12-600TW	TO-220AB
Triac	Yes	10	800	CTA12-800 B	TO-220AB
Triac	Yes	12	800	CTA12-800BW	TO-220AB
Triac	Yes	12	800	CTA12-800C	TO-220AB
Triac	Yes	10	800	CTA12-800CW	TO-220AB
Triac	Yes	12	800	CTA12-800SW	TO-220AB
Triac	Yes	12	800	CTA12-800TW	TO-220AB
Triac	Yes	15	1000	CTA16-1000B	TO-220AB
Triac	Yes	16	1000	CTA16-1000BW	TO-220AB
Triac	Yes	16	1000	CTA16-1000CW	TO-220AB
Triac	Yes	15	400	CTA16-400 B	TO-220AB
Triac	Yes	16	400	CTA16-400BW	TO-220AB
Triac	Yes	16	400	CTA16-400C	TO-220AB
Triac	Yes	16	200	CTA16-400CW	TO-220AB
Triac	Yes	15	600	CTA16-600 B	TO-220AB
Triac	Yes	16	600	CTA16-600BW	TO-220AB
Triac	Yes	16	600	CTA16-600C	TO-220AB
Triac	Yes	16	600	CTA16-600CW	TO-220AB
Triac	Yes	16	600	CTA16-600SW	TO-220AB
Triac	Yes	16	600	CTA16-600TW	TO-220AB
Triac	Yes	16	700	CTA16-800 B	TO-220AB
Triac	Yes	16	800	CTA16-800BW	TO-220AB
Triac	Yes	16	800	CTA16-800C	TO-220AB
Triac	Yes	16	800	CTA16-800CW	TO-220AB
Triac	Yes	16	800	CTA16-800SW	TO-220AB
Triac	Yes	25	1000	CTA24-1000BW	TO-220AB
Triac	Yes	25	400	CTA24-400B	TO-220AB
Triac	Yes	30	400	CTA24-400BW	TO-220AB
Triac	Yes	25	600	CTA24-600B	TO-220AB
Triac	Yes	30	600	CTA24-600BW	TO-220AB
Triac	Yes	20	600	CTA24-600CW	TO-220AB
Triac	Yes	25	800	CTA24-800B	TO-220AB
Triac	Yes	20	700	CTA24-800BW	TO-220AB
Triac	Yes	25	800	CTA24-800CW	TO-220AB
Triac	No	6	1000	CTB06-1000B	TO-220AB
Triac	No	6	1000	CTB06-1000CW	TO-220AB
Triac	No	6	400	CTB06-400B	TO-220AB
Triac	No	6	400	CTB06-400BW	TO-220AB
Triac	No	6	200	CTB06-400C	TO-220AB
Triac	No	4	400	CTB06-400CW	TO-220AB
Triac	No	4	400	CTB06-400SW	TO-220AB
Triac	No	4	400	CTB06-400TW	TO-220AB
Triac	No	6	600	CTB06-600B	TO-220AB
Triac	No	4	500	CTB06-600BW	TO-220AB
Triac	No	5	600	CTB06-600C	TO-220AB
Triac	No	4	500	CTB06-600CW	TO-220AB
Triac	No	4	600	CTB06-600SW	TO-220AB
Triac	No	4	600	CTB06-600TW	TO-220AB
Triac	No	6	800	CTB06-800B	TO-220AB
Triac	No	4	800	CTB06-800BW	TO-220AB
Triac	No	6	800	CTB06-800C	TO-220AB
Triac	No	4	800	CTB06-800CW	TO-220AB
Triac	No	4	800	CTB06-800SW	TO-220AB
Triac	No	4	800	CTB06-800TW	TO-220AB
Triac	No	8	1000	CTB08-1000B	TO-220AB
Triac	No	8	1000	CTB08-1000CW	TO-220AB
Triac	No	8	400	CTB08-400B	TO-220AB
Triac	No	8	400	CTB08-400BW	TO-220AB

Competitor's Device Information				Crydom Cross	Crydom Package
Device Type	Isolated	It (rms)	Vrrm		
Triac	No	8	400	CTB08-400C	TO-220AB
Triac	No	8	400	CTB08-400CW	TO-220AB
Triac	No	8	400	CTB08-400SW	TO-220AB
Triac	No	8	400	CTB08-400TW	TO-220AB
Triac	No	8	600	CTB08-600B	TO-220AB
Triac	No	8	600	CTB08-600BW	TO-220AB
Triac	No	8	600	CTB08-600C	TO-220AB
Triac	No	8	600	CTB08-600CW	TO-220AB
Triac	No	8	600	CTB08-600SW	TO-220AB
Triac	No	8	600	CTB08-600TW	TO-220AB
Triac	No	8	800	CTB08-800B	TO-220AB
Triac	No	8	800	CTB08-800BW	TO-220AB
Triac	No	8	800	CTB08-800C	TO-220AB
Triac	No	8	700	CTB08-800CW	TO-220AB
Triac	No	8	800	CTB08-800SW	TO-220AB
Triac	No	8	800	CTB08-800TW	TO-220AB
Triac	No	10	1000	CTB12-1000B	TO-220AB
Triac	No	10	1000	CTB12-1000BW	TO-220AB
Triac	No	10	1000	CTB12-1000C	TO-220AB
Triac	No	10	400	CTB12-400B	TO-220AB
Triac	No	12	400	CTB12-400BW	TO-220AB
Triac	No	10	200	CTB12-400C	TO-220AB
Triac	No	12	400	CTB12-400CW	TO-220AB
Triac	No	12	600	CTB12-600B	TO-220AB
Triac	No	12	600	CTB12-600B	TO-220AB
Triac	No	12	500	CTB12-600BW	TO-220AB
Triac	No	12	600	CTB12-600C	TO-220AB
Triac	No	10	600	CTB12-600CW	TO-220AB
Triac	No	12	600	CTB12-600SW	TO-220AB
Triac	No	12	600	CTB12-600TW	TO-220AB
Triac	No	12	800	CTB12-800B	TO-220AB
Triac	No	12	800	CTB12-800BW	TO-220AB
Triac	No	12	800	CTB12-800C	TO-220AB
Triac	No	12	800	CTB12-800CW	TO-220AB
Triac	No	12	800	CTB12-800SW	TO-220AB
Triac	No	12	800	CTB12-800TW	TO-220AB
Triac	No	15	1000	CTB16-1000B	TO-220AB
Triac	No	16	1000	CTB16-1000BW	TO-220AB
Triac	No	16	1000	CTB16-1000CW	TO-220AB
Triac	No	16	400	CTB16-400B	TO-220AB
Triac	No	16	400	CTB16-400BW	TO-220AB
Triac	No	16	400	CTB16-400C	TO-220AB
Triac	No	16	200	CTB16-400CW	TO-220AB
Triac	No	15	400	CTB16-400TW	TO-220AB
Triac	No	15	600	CTB16-600B	TO-220AB
Triac	No	16	600	CTB16-600BW	TO-220AB
Triac	No	16	600	CTB16-600C	TO-220AB
Triac	No	16	600	CTB16-600CW	TO-220AB
Triac	No	16	600	CTB16-600SW	TO-220AB
Triac	No	15	600	CTB16-600TW	TO-220AB
Triac	No	16	800	CTB16-800B	TO-220AB
Triac	No	16	800	CTB16-800BW	TO-220AB
Triac	No	16	800	CTB16-800CW	TO-220AB
Triac	No	16	800	CTB16-800SW	TO-220AB
Triac	No	15	800	CTB16-800TW	TO-220AB
Triac	No	25	1000	CTB24-1000B	TO-220AB
Triac	No	25	1000	CTB24-1000BW	TO-220AB
Triac	No	25	400	CTB24-400B	TO-220AB
Triac	No	30	400	CTB24-400BW	TO-220AB
Triac	No	25	600	CTB24-600B	TO-220AB
Triac	No	30	600	CTB24-600BW	TO-220AB
Triac	No	20	600	CTB24-600C	TO-220AB
Triac	No	25	600	CTB24-600CW	TO-220AB
Triac	No	25	700	CTB24-800B	TO-220AB
Triac	No	25	800	CTB24-800BW	TO-220AB
Triac	No	25	800	CTB24-800C	TO-220AB
Triac	No	25	800	CTB24-800CW	TO-220AB

Bi - Directional trigger - DIACS.

The plastic material carries U/L recognition 94V-O.

Type No.	Breakdown Voltage			Breakover Voltage Symmetry	Dynamic Breakback Voltage	Breakover Current	Peak Pulse Current for 10 μ s 120 PPS Ta < 40 °C
	V (BR) ¹ and V (BR) ²			[V (BR) ¹] - [V (BR) ²]	Δ V ₋	I(BR) ¹ and I (BR) ²	ITRM
	V(Min.)	V(Typ.)	V(Max.)	V(Max)	V(Min.)	μ A(Max.)	A(Max.)

D32P Series. Case: DO-41

Type No.	27	32	37	3.0	5.0	100	2.0
D32P	27	32	37	3.0	5.0	100	2.0
D35P	30	35	40	3.0	5.0	100	2.0
D40P	35	40	45	3.0	5.0	100	2.0
D50P	42	50	58	4.0	8.0	100	1.6
D60P	56	60	70	4.0	10.0	100	1.6

Thyristor - SIDAC.

The plastic material carries U/L recognition 94V-O.

Type No.	Repetitive Peak Off-State Voltage	Breakover Voltage (60 Hz Sine Wave)		On-State RMS Current Conduction Angle of 360 °	Peak Surge (Non-Repetitive) On-State Current One-cycle@ 60 Hz	Repetitive Peak Off-State Current @ 60Hz, V=VDRM	Dynamic Holding Current R=0.1 K Ω ,60Hz	Breakover Current 60 Hz Sine Wave
	VDRM	VBO(Min.)	VBO(Max.)	IT(RMS)	ITSM	IDRM	IHO	IBO
	(V)	(V)	(V)	(A)	(A)	(μ A)	(mA)	(μ A)

G105 Series. Case: DO-41

Type No.	_ 90	95	113	1.0	20	10	100	200
G105	_ 90	95	113	1.0	20	10	100	200
G120	_ 90	110	125	1.0	20	10	100	200
G130	_ 90	120	135	1.0	20	10	100	200
G220	_ 180	205	230	1.0	20	10	100	200
G240	_ 180	220	250	1.0	20	10	100	200
G260	_ 180	240	270	1.0	20	10	100	200
G270	_ 180	250	280	1.0	20	10	100	200

(SCR = Silicon Controlled Rectifier)

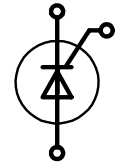
Phase Control Thyristors

Thyristors are very rugged devices. Compared to all other controlled semi-conductor components, they feature the highest current capacity per chip area, especially at high voltage. They are mainly used as control devices in 50 and 60 Hz AC mains equipment.

Principal applications are static converter circuits for speed control of DC-drives, or switching and control functions for temperature, lighting, soft-start, etc. in single-phase and three-phase AC switch configurations. Phase control thyristors are

designed for optimal forward conduction and reverse blocking characteristics, due to only moderate requirements for turn-on and turn-off parameters.

Phase Control Thyristors

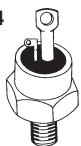


$I_{TAV} = 16 - 60 \text{ A}$

Type	V_{RRM} V_{DRM}	I_{TAV} $T_c = 85^\circ\text{C}$	I_{TRMS}	I_{TSM} 45°C 10 ms	$\frac{dv}{dt}_c$	V_{TO}	r_T	T_{VJM}	R_{thJC}	R_{thCH}	Fig. No.	Package style
□ New	V	A	A	A	V/μs	V	mΩ	°C	K/W	K/W		Outline drawings on pages O-5...O-17
CS 8-08 io2 CS 8-12 io2	800 1200	16	25	250	1000	1.0	18	125	1.5	1.0	21	Fig. 3 TO-220 AB Weight = 4 g
CS 19-08 ho1 CS 19-12 ho1	800 1200	19	29	160	500	0.85	27.0	125	1.0	0.25	3	Fig. 5a TO-263 AB Weight = 2 g
CS 19-08 ho1S CS 19-12 ho1S	800 1200	19	29	160	500	0.85	27.0	125	1.0	0.25	5a	
CS 19-08 ho1C CS 19-12 ho1C	800 1200	13	35	100	500	0.87	29	125	1.7	0.6	83	
CS 20-12 io1 CS 20-14 io1 CS 20-16 io1	1200 1400 1600	19	30	200	1000	1.1	40	125	0.62	0.2	6	Fig. 6 TO-247 AD Weight = 6 g
CS 20-22 moF1	2200	18		200	2500			125	0.92	0.15	85	
□ CS 22-08 io1M □ CS 22-12 io1M	800 1200	22	tbd	300	1000	0.9	18	125	tbd	tbd	102	
CS 23-08 io2 CS 23-12 io2 CS 23-16 io2	800 1200 1600	25	50	450	1000	1.0	10	125	1.0	0.6	22	Fig. 83 ISOPLUS220™ Weight = 2 g
CS 29-08 io1C CS 29-12 io1C	800 1200	23	35	200	500	0.82	16.5	150	1.2	0.6	83	Fig. 84 ISOPLUS i4-PAC™ Weight = 9 g
CS 30-12 io1 CS 30-14 io1 CS 30-16 io1	1200 1400 1600	31	49	300	1000	0.9	15	125	0.62	0.2	6	
CS 35-08 io4 CS 35-12 io4 CS 35-14 io4	800 1200 1400	63	120	1200	1000	0.85	3.5	125	0.4	0.2	23	Fig. 85 ISOPLUS i4-PAC™ Weight = 9 g
CS 45-08 io1 CS 45-12 io1 CS 45-16 io1	800 1200 1600	48 $T_c = 75^\circ\text{C}$	75	520	1000	0.85	11	125	0.62	0.2	6	
CS 45-16 io1R □	1600	48	75	520	1000	0.85	11	125	0.62	0.2	7	
□ CS 60-12 io1 □ CS 60-14 io1 □ CS 60-16 io1	1200 1400 1600	48 $T_c = 105^\circ\text{C}$	75	1500	1000	0.85	3.7	140	0.32	-	7	Fig. 7 ISOPLUS247™ DCB isol. package PLUS247 Weight = 5 g
FCC 21-12 io	1200	21/ $T_c = 90^\circ\text{C}$	-	300	1000	-	-	140	1.00	0.32	84	

□ isolated 2500 V_{RMS}

Fig. 21 TO-64
Weight = 6 g



M 5

Fig. 22 TO-208 AA
(TO-48)
Weight = 12 g



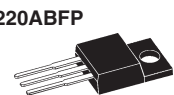
M 6

Fig. 23 TO-208 AC
(TO-65)
Weight = 20 g



1/4"-28 UNF-2A

Fig. 102 TO-220ABFP
Weight = 4 g



Schottky Barrier Rectifiers.

The plastic material carries U/L recognition 94V-O.

Type No.		Max. Average Forward Rectified Current		Max. Repetitive Peak Reverse Voltage	Max. Repetitive Peak Forward Current	Max. Forward Surge Current	Max. Forward Voltage Drop at Ta=25 °C		Max. Reverse Current at Ta=25 °C
		IF(AV) @ T L	(A)				(°C)	V F @ I F	
Axial Lead	S.M.D.	(A)	(°C)	(V)	(A)	(A)	(V)	(A)	(mA)

1N5817/SKN7 Series. 1 Amp. Case: DO-41/SMA



1N5817	SKN7	1.0	90	20	5.0	25	0.45	1.0	1.0
1N5818	SKN8	1.0	90	30	5.0	25	0.55	1.0	1.0
1N5819	SKN9	1.0	90	40	5.0	25	0.60	1.0	1.0

SB120/SK12 Series. 1 Amp. Case: DO-41/SMA.



SB120	SK12	1.0	75	20	5.0	40	0.50	1.0	0.5
SB130	SK13	1.0	75	30	5.0	40	0.50	1.0	0.5
SB140	SK14	1.0	75	40	5.0	40	0.50	1.0	0.5
SB150	SK15	1.0	100	50	5.0	40	0.70	1.0	0.5
SB160	SK16	1.0	100	60	5.0	40	0.70	1.0	0.5
SB170	SK17	1.0	100	70	5.0	40	0.70	1.0	0.5
SB180	SK18	1.0	100	80	5.0	40	0.79	1.0	0.5
SB190	SK19	1.0	100	90	5.0	40	0.79	1.0	0.5
SB180	SK1B	1.0	100	100	5.0	40	0.79	1.0	0.5

SB220/SK22 Series. 2.0 Amps. Case: D2/SMB



SB220	SK22	2.0	75	20	10	60	0.50	2.0	0.5
SB230	SK23	2.0	75	30	10	60	0.50	2.0	0.5
SB240	SK24	2.0	75	40	10	60	0.50	2.0	0.5
SB250	SK25	2.0	100	50	10	60	0.74	2.0	0.5
SB260	SK26	2.0	100	60	10	60	0.74	2.0	0.5
SB270	SK27	2.0	100	70	10	60	0.74	2.0	0.5
SB280	SK28	2.0	100	80	10	60	0.79	2.0	0.5
SB290	SK29	2.0	100	90	10	60	0.79	2.0	0.5
SB280	SK2B	2.0	100	100	10	60	0.79	2.0	0.5

S Suffix. Case : DO-41 for axial lead, Case : SMA for S.M.D.

1N5820/SKN0 Series. 3 Amps. Case: DO-201AD/SMC



1N5820	SKN0	3.0	95	20	15	80	0.475	3.0	2.0
1N5821	SKN1	3.0	95	30	15	80	0.500	3.0	2.0
1N5822	SKN2	3.0	95	40	15	80	0.525	3.0	2.0

S Suffix. Case : D2A for axial lead, Case : SMB for S.M.D.

ERC Series. 2.6 - 3.0 Amps. Case: DO-201AD



ERC81-004		2.6	25	40	-	120	0.55	3.0	5.0
ERC81-006		3.0	104	60	-	80	0.58	3.0	5.0
ERC84-009		3.0	85	90	-	120	0.80	3.0	5.0

SB320/SK32 Series. 3 Amps. Case: DO-201AD/SMC



SB320	SK32	3.0	75	20	15	80	0.50	3.0	0.5
SB330	SK33	3.0	75	30	15	80	0.50	3.0	0.5
SB340	SK34	3.0	75	40	15	80	0.50	3.0	0.5
SB350	SK35	3.0	100	50	15	80	0.74	3.0	0.5
SB360	SK36	3.0	100	60	15	80	0.74	3.0	0.5
SB370	SK37	3.0	100	70	15	80	0.74	3.0	0.5
SB380	SK38	3.0	100	80	15	80	0.79	3.0	0.5
SB390	SK39	3.0	100	90	15	80	0.79	3.0	0.5
SB380	SK3B	3.0	100	100	15	80	0.79	3.0	0.5

S Suffix. Case : D2A for axial lead, Case : SMB for S.M.D.

SB520/SK52 Series. 5 Amps. Case: DO-201AD/SMC



SB520	SK52	5.0	60	20	25	150	0.55	5.0	0.5
SB530	SK53	5.0	60	30	25	150	0.55	5.0	0.5
SB540	SK54	5.0	60	40	25	150	0.55	5.0	0.5
SB550	SK55	5.0	80	50	25	150	0.67	5.0	0.5
SB560	SK56	5.0	80	60	25	150	0.67	5.0	0.5
SB570	SK57	5.0	80	70	25	150	0.67	5.0	0.5
SB580	SK58	5.0	80	80	25	150	0.79	5.0	0.5
SB590	SK59	5.0	80	90	25	150	0.79	5.0	0.5
SB580	SK5B	5.0	80	100	25	150	0.79	5.0	0.5

Schottky Barrier Rectifiers.

The plastic material carries U/L recognition 94V-0.

Type No.		Max. Average Forward Rectified Current		Max. Repetitive Peak Reverse Voltage	Max. Repetitive Peak Forward Current	Max. Forward Surge Current	Max. Forward Voltage Drop at Ta=25 °C		Max. Reverse Current at Ta=25 °C
		IF(AV) @ T L	(A)	(°C)	VRRM	IFRM	IFSM	VF @ I F	IR
Axial Lead	S.M.D.	(A)	(°C)	(V)	(A)	(A)	(V)	(A)	(mA)

MBR735 Series. 7.5 Amps. Case: TO-220AC



MBR735		7,5	105Tc	35	-	150	-	-	0,1
MBR745		7,5	105Tc	45	-	150	-	-	0,1
MBR750		7,5	105Tc	50	-	150	0,75	7,5	0,5
MBR760		7,5	105Tc	60	-	150	0,75	7,5	0,5

SBL1030 Series. 10 Amps. Case: TO-220AC



SBL1030		10	110Tc	30	-	250	0,6	10	1,0
SBL1040		10	110Tc	40	-	250	0,6	10	1,0

MBR1035 Series. 10 Amps. Case: TO-220AC



MBR1035		10	125Tc	35	-	150	0,84	10	0,10
MBR1045		10	125Tc	45	-	150	0,84	10	0,10
MBR1050		10	125Tc	50	-	150	0,80	10	0,15
MBR1060		10	125Tc	60	-	150	0,80	10	0,15

MBR1635 Series. 16 Amps. Case: TO-220AC



MBR1635		16	125Tc	35	-	150	0,63	16	0,20
MBR1645		16	125Tc	45	-	150	0,63	16	0,20
MBR1650		16	125Tc	50	-	150	0,75	16	1,00
MBR1660		16	125Tc	60	-	150	0,75	16	1,00

SBL1030CT Series. 10 - 16 Amps. Case: TO-220AB



SBL1030CT		10	95Tc	30	-	250	0,55	5	0,5
SBL1040CT		10	95Tc	40	-	250	0,55	5	0,5
SBL1630CT		16	95Tc	30	-	250	0,55	8	0,5
SBL1640CT		16	95Tc	40	-	250	0,55	8	0,5

MBR2035CT Series. 20 Amps. Case: TO-220AB



MBR2035CT		20	135Tc	35	-	150	0,57	10	0,10
SBL2045CT		20	135Tc	45	-	150	0,57	10	0,10
SBL2050CT		20	135Tc	50	-	150	0,8	10	0,15
SBL2060CT		20	135Tc	60	-	150	0,8	10	0,15

MBR2535CT Series. 30 Amps. Case: TO-220AB



MBR2535CT		30	130Tc	35	30	150	0,82	30	0,20
SBL2545CT		30	130Tc	45	30	150	0,82	30	0,20
SBL2550CT		30	125Tc	50	30	150	0,75	15	1,00
SBL2560CT		30	125Tc	60	30	150	0,75	15	1,00

SBL2030PT Series. 20 - 40 Amps. Case: TO-247AD



SBL2030PT		20	105Tc	30	-	250	0,55	10	1,0
SBL2040PT		20	105Tc	40	-	250	0,55	10	1,0
SBL3030PT		30	100Tc	30	-	250	0,55	15	1,0
SBL3040PT		30	100Tc	40	-	250	0,55	15	1,0
SBL4030PT		40	100Tc	30	-	250	0,58	20	10
SBL4040PT		40	100Tc	40	-	250	0,58	20	10

MBR3035PT Series. 30 Amps. Case: TO-247AD



MBR3035PT		30	105Tc	35	30	200	0,76	30	1,0
MBR3045PT		30	105Tc	45	30	200	0,76	30	1,0
MBR3050PT		30	125Tc	50	30	300	0,75	20	5,0
MBR3060PT		30	125Tc	60	30	300	0,75	20	5,0

MBR4035PT Series. 40 Amps. Case: TO-247AD



MBR4035PT		40	120Tc	35	40	400	0,7	20	10
MBR4045PT		40	120Tc	45	40	400	0,7	20	10
MBR4050PT		40	120Tc	50	40	400	0,8	20	10
MBR4060PT		40	120Tc	60	40	400	0,8	20	10

Schottky Barrier Rectifiers.

Type No.		Max. Average Forward Rectified Current		Max. Repetitive Peak Reverse Voltage	Max. Repetitive Peak Forward Current	Max. Forward Surge Current	Max. Forward Voltage Drop at Ta=25 °C		Max. Reverse Current at Ta=25 °C	Max. Power Dissipation
		IF(AV) @ Ta	(mA)				(°C)	VRRM		
Axial Lead	S.M.D.	(mA)	(°C)	(V)	(mA)	(A)	(V)	(mA)	(µA)	(mW)

1N5711 - 1N6263. Case: DO-35 / MiniMELF



1N5711	LL5711	-	-	70	-	2	0,41	1,0	0,2	400
1N6263	LL6263	-	-	60	-	2	0,41	1,0	0,2	400

BAT42 / LL42 Series. Case: DO-35 / MiniMELF



BAT42	LL42	200	25	30	500	4,0	0,40	10	0,5	200
BAT43	LL43	200	25	30	500	4,0	0,33	2,0	0,5	200
BAT48	LL48	350	25	40	1A	0,75	0,40	10	25	330

BAT81 Series. Case: DO-34 / MiniMELF



BAT81		30	25	40	150	0,5	0,41	1,0	0,2	200
BAT82		30	25	50	150	0,5	0,41	1,0	0,2	200
BAT83		30	25	60	150	0,5	0,41	1,0	0,2	200
BAT85	BAS85	200	25	30	-	0,6	0,40	10	2,0	200

SD101A/LL101A Series. Case: DO-35/MiniMELF



SD101A	LL101A	-	-	60	-	2,0	0,41	1,0	0,2	400
SD101B	LL101B	-	-	50	-	2,0	0,40	1,0	0,2	400
SD101C	LL101C	-	-	40	-	2,0	0,39	1,0	0,2	400

SD103A/LL103A Series. Case: DO-35/MiniMELF



SD103A	LL103A	-	-	40	-	15	0,37	20	5,0	400
SD103B	LL103B	-	-	50	-	15	0,37	20	5,0	400
SD103C	LL103C	-	-	60	-	15	0,37	20	5,0	400

BAT42WS Series. Case: SOD-323



BAT42WS		200	25	30	-	4,0	1,00	200	0,5	-
BAT43WS		200	25	30	-	4,0	1,00	200	0,5	-
BAT54WS		200	25	30	-	1,0	0,65	100	2,0	200

SD101AWS Series. Case: SOD-323



SD101AWS		-	-	60	-	2,0	1,00	15	0,2	150
SD101BWS		-	-	50	-	2,0	0,95	15	0,2	150
SD101CWS		-	-	40	-	2,0	0,90	15	0,2	150

SD103AWS Series. Case: SOD-323



SD103AWS		-	-	40	-	2,0	0,60	200	5,0	150
SD103BWS		-	-	30	-	2,0	0,60	200	5,0	150
SD103CWS		-	-	20	-	2,0	0,60	200	5,0	150

SD104AWS Series. Case: SOD-323



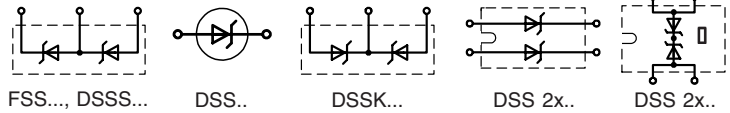
SD104AWS		30	25(Tc)	20	-	2,0	0,60	10	0,5	150
SD104BWS		30	25(Tc)	15	-	2,0	0,58	10	0,5	150
SD104CWS		30	25(Tc)	10	-	2,0	0,56	10	0,5	150

SD106WS Series. Case: SOD-323



SD106WS		200	25(Tc)	30	-	1,0	0,55	200	5,0	250
SD107WS		100	25(Tc)	30	-	0,75	0,55	50	1,0	250

Schottky Diodes



Type	V _{RRM}	I _{FAV} d = 0.5	T _C	V _F @ I _F max. T _{VJM} = 125°C	E _{AS}	I _{AR}	T _{VJM}	R _{thJC}	Fig. No.	Package style
□ New	V	A	°C	V	mJ	A	°C	K/W		Outline drawings on pages O-5...O-17
DSSK 80-0008D DSS 2x200-0008D □	8	2x40 2x200	135 100	0.23 40 0.15 100	80 80	4 4	150 150	0.8 0.4	6 12	Fig. 2 TO-252 AA Weight = 0.3 g
DSS 20-0015B DSSK 40-0015B DSSK 70-0015B	15	20 2x20 2x35	135 135 130	0.33 20 0.32 20 0.33 35	tbd tbd 61	tbd tbd 2.5	150 150 150	1.4 1.4 1.1	4 6 6	Fig. 3 TO-220 AB Weight = 4 g
□ DSS 6-0025BS DSS 25-0025B	25	6 25	140 125	0.30 6 0.44 25	tbd tbd	tbd tbd	150 150	3.0 1.4	2 4	Fig. 4 TO-220 AC Weight = 2 g
□ DSSK 18-0025B		2x10	140	0.37 10	tbd	tbd	150	1.7	3	
□ DSSK 18-0025BS		2x10	140	0.37 10	tbd	tbd	150	1.7	5a	
□ DSSK 38-0025B		2x20	130	0.40 20	tbd	tbd	150	1.4	3	
□ DSSK 38-0025BS		2x20	130	0.40 20	tbd	tbd	150	1.4	5a	
DSSK 48-0025B		2x25	130	0.35 20	tbd	tbd	150	1.2	3	
DSSK 50-0025B DSSK 80-0025B		2x25 2x40	125 130	0.42 25 0.39 40	tbd 10	tbd 6.0	150 150	1.4 0.8	6 6	
DSSK 48-003B DSSK 48-003BS	30	2x25	130 130	0.35 20 0.35 20	tbd tbd	tbd tbd	150 150	1.2 1.2	3 5a	Fig. 5a TO-263 AB Weight = 2 g
□ DSSK 70-003B DSSK 80-003B		2x35 2x40	125 130	0.39 35 0.39 40	tbd 10	tbd 6.0	150 150	1.1 0.8	6 6	
□ DSS 1-40BA □ DSS 2-40BB	40	1 2	125 125	0.34 1 0.33 2	tbd tbd	tbd tbd	150 150	R _{thJC} 30 R _{thJC} 15	99 100	Fig. 6 TO-247 AD Weight = 6 g
DSS 6-0045AS DSS 10-0045A DSS 10-0045B DSS 16-0045A DSS 16-0045AS DSS 16-0045B DSS 25-0045A DSS 60-0045B	45	6 10 10 16 16 16 25 60	165 160 135 160 160 130 155 100	0.50 6 0.58 10 0.46 10 0.57 15 0.57 15 0.42 15 0.59 25 0.57 60	24 24 24 32 32 32 46 57	1.3 1.3 1.3 1.5 1.5 1.5 1.8 2.0	175 175 150 175 175 150 175 150	3.0 1.7 1.7 1.4 1.4 1.4 1.1 0.8	2 4 4 4 5a 4 4 8	Fig. 7 ISOPLUS247™ DCB isol. package Weight = 5 g
□ DSSK 20-0045A □ DSSK 20-0045AM DSSK 20-0045B DSSK 28-0045A DSSK 28-0045B DSSK 28-0045BS DSSK 30-0045A DSSK 30-0045B DSSK 60-0045A DSSK 60-0045B DSSK 80-0045B DSS 2x61-0045A DSS 2x81-0045B DSS 2x121-0045B DSS 2x160-0045A □		2x10 2x10 2x10 2x14 2x15 2x15 2x15 2x15 2x30 2x30 2x40 2x60 2x80 2x120 2x160	160 145 135 160 135 135 160 135 150 120 125 105 75 100 100	0.58 10 0.56 10 0.45 10 0.57 15 0.43 15 0.43 15 0.57 15 0.41 15 0.60 30 0.44 30 0.45 40 0.66 60 0.64 80 0.59 120 0.73 160	24 11 24 32 32 32 32 32 46 46 57 57 57 112 112	1.3 1.5 1.3 1.5 1.5 1.5 1.5 1.5 1.8 1.8 2.0 2.0 2.0 2.8 2.8	175 175 150 175 150 150 175 150 175 150 150 150 150 150 150	1.7 4.3 1.7 1.4 1.4 1.4 1.4 1.4 1.1 1.1 0.8 0.8 0.8 0.4 0.3	3 102 3 3 5a 6 6 6 6 6 12 12 12	Fig. 8 TO-247 AD Weight = 6 g
□ FUS 45-0045B		45	90	0.5 typ. 15	tbd	tbd	150	3.1	84	Fig. 86 ISOPLUS i4-PAC™ Weight = 9 g
□ DSS 1-60BA □ DSS 2-60BB □ DSS 10-006A DSSK 28-006B DSSK 28-006BS DSSK 40-006B DSSK 80-006B	60	1 2 10 2x15 2x15 2x20 2x40	125 125 160 135 135 130 120	0.40 1 0.40 2 0.62 10 0.52 15 0.52 15 0.50 20 0.51 40	tbd tbd 0.05 tbd tbd tbd tbd	tbd tbd 0.1 tbd tbd tbd tbd	150 150 175 150 150 150 150	R _{thJC} 30 R _{thJC} 15 1.6 1.1 1.1 1.1 0.8	99 100 4 3 5a 6 6	Fig. 84 ISOPLUS i4-PAC™ Weight = 9 g
DSSK 40-008B □ DSSK 35-008AR DSSK 70-008A DSS 2x111-008A FSS 100-008A	80	2x20 35 2x35 2x110 85	130 150 150 105 90	0.57 20 0.66 35 0.66 35 0.72 100 0.80 75	tbd tbd tbd 19 tbd	tbd tbd tbd 1.4 tbd	150 175 175 150 175	1.1 0.8 0.8 0.4 1.4	6 7 6 12 86	Fig. 102 TO-220ABFP Weight = 4 g

Data per Diode unless otherwise specified
□ non isolated base plate

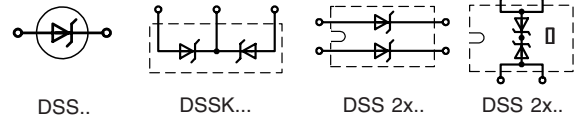
Fig. 99
SMA (DO-214AC)
Weight = 0.07 g



Fig. 100
SMB (DO-214AA)
Weight = 0.1 g



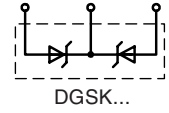
Schottky Diodes






Type	V_{RRM} V	I_{FAV} A	@ T_C °C	V_F max. V	@ I_F A	E_{AS} mJ	I_{AR} A	T_{VJM} °C	R_{thJC} K/W	Fig. No.	Package style Outline drawings on pages O-5...O-17	
□ DSS 1-100AA	100	1	125	0.60	1	tbd	tbd	150	$R_{thJC}30$	99	Fig. 2 TO-252 AA Weight = 0.3 g Fig. 3 TO-220 AB Weight = 4 g Fig. 4 TO-220 AC Weight = 2 g Fig. 5a TO-263 AB Weight = 2 g Fig. 6 TO-247 AD Weight = 6 g Fig. 7 ISOPLUS247™ DCB isol. package Weight = 5 g Fig. 12 SOT-227B miniBLOC Weight = 30 g Fig. 99 SMA (DO-214AC) Weight = 0.07 g Fig. 100 SMB (DO-214AA) Weight = 0.1 g Fig. 101 ISOPLUS220™ Weight = 2 g	
□ DSS 2-100AB		2	125	0.59	2	tbd	tbd	150	$R_{thJC}15$	100		
DSS 10-01A		10	160	0.65	10	7	0.8	175	1.7	4		
DSS 10-01AS		10	160	0.65	10	7	0.8	175	1.7	5a		
DSS 16-01A		16	155	0.64	15	10	1.0	175	1.4	4		
DSS 16-01AS		16	155	0.64	15	10	1.0	175	1.4	5a		
DSS 20-01AC		20	140	0.65	10	7	0.8	175	1.7	101		
DSSK 16-01A		2x8	165	0.65	10	7	0.8	175	1.7	3		
DSSK 16-01AS		2x8	165	0.65	10	7	0.8	175	1.7	5a		
DSSK 16-01C		not for new design										3
DSSK 28-01A		2x15	160	0.63	15	10	1.0	175	1.4	3		
DSSK 28-01AS		2x15	160	0.63	15	10	1.0	175	1.4	5a		
DSSK 30-01A		2x15	160	0.64	15	10	1.0	175	1.4	6		
DSSK 50-01A		2x25	155	0.65	25	13	1.1	175	1.1	6		
DSS 2x41-01A	2x40	110	0.70	40	13	1.1	150	1.1	12			
DSS 2x61-01A	2x60	105	0.73	60	16	1.2	150	0.8	12			
DSS 2x160-01A □	2x160	95	0.80	160	31	1.7	150	0.30	12			
□ DSS 6-015AS	150	6	160	0.62	6	tbd	tbd	175	3.0	2		
DSSK 20-015A		2x10	165	0.65	10	tbd	tbd	175	1.4	3		
DSSK 50-015A		2x25	150	0.68	25	tbd	tbd	175	1.1	6		
DSSK 60-015A		2x30	155	0.69	30	tbd	tbd	175	0.8	6		
DSSK 60-015AR		2x30	155	0.69	30	tbd	tbd	175	0.8	7		
DSS 2x101-015A	150	2x100	110	0.78	100	tbd	tbd	150	0.4	12		
DSSK 10-018A	180	2x5	165	0.62	5	tbd	tbd	175	1.7	3		
DSSK 30-018A		2x15	150	0.72	15	tbd	tbd	175	1.7	6		

Data per Diode unless otherwise specified
 □ non isolated base plate

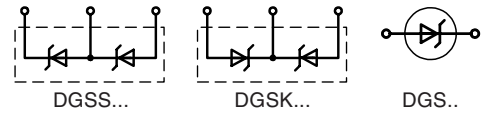
Gallium Arsenide Schottky Diodes



No reverse recovery

Type	V _{RRM}	I _{DC} @ T _C	V _F typ. @ T _{VJ} = 125 °C	I _F	C _J	R _{thJC}	Fig. No.	Package style
□ New	V	A °C	V	A	pF	K/W		Outline drawings on pages O-5...O-17
DGS 3-018AS	180	5 90	0.85	2	8.8	8.5	2	Fig. 2 TO-252AA Weight = 0.3 g 
DGS 10-018A	180	11 90	0.8	5	22	4.4	4	
DGS 10-018AS	180	11 90	0.8	5	22	4.4	5a	
DGS 20-018A	180	17 90	0.8	7.5	33	3.1	4	
DGS 20-018AS	180	17 90	0.8	7.5	33	3.1	5a	
DGS 3-025AS	250	3.9 90	1.3	2	6.4	8.5	2	
DGS 4-025A	250	9 90	1.3	2	6.4	8.5	4	
DGS 9-025AS	250	9 90	1.1	5	18	4.4	2	
DGS 10-025A	250	9 90	1.1	5	18	4.4	4	
DGS 10-025AS	250	9 90	1.1	5	18	4.4	5a	
DGS 19-025AS	250	13 90	1.3	7.5	26	3.1	2	
DGS 20-025A	250	13 90	1.3	7.5	26	3.1	4	
DGS 20-025AS	250	13 90	1.3	7.5	26	3.1	5a	
DGS 3-030AS	300	3.5 90	1.6	2	3.7	8.5	2	Fig. 4 TO-220 AC Weight = 2 g 
DGS 9-030AS	300	8 90	1.6	5	9	4.4	2	
DGS 10-030A	300	8 90	1.6	5	9	4.4	4	
DGSK 20-018A	180	11 90	0.8	5	22	4.4	3	Fig. 5a TO-263AB Weight = 2 g 
DGSK 40-018A	180	17 90	0.8	7.5	33	3.1	3	
DGSK 8-025A	250	3.9 90	1.3	2	6.4	8.5	3	
DGSK 20-025A	250	9 90	1.1	5	18	4.4	3	
DGSK 20-025AS	250	9 90	1.3	5	18	4.4	5a	
DGSK 40-025A	250	13 90	1.3	7.5	26	3.1	3	
DGSK 40-025AS	250	13 90	1.3	7.5	26	3.1	5a	

Gallium Arsenide Schottky Diodes



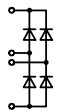
Low leakage current

Second generation

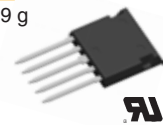
Type	V _{RRM}	I _{DC} @ T _C	V _F typ. @ T _{VJ} = 125 °C	I _F	C _J	R _{thJC}	Fig. No.	Package style
New	V	A °C	V	A	pF	K/W		Outline drawings on pages O-5...O-17
DGS 15-018CS	180	15 90	1.0	7.5	21	4.4	2	Fig. 2 TO-252 AA Weight = 0.3 g
DGS 13-025CS	250	14 90	1.2	7.5	15	4.4		
DGS 19-025CS		20 90	1.1	10	24	3.1		
DGS 17-030CS	300	17.5 90	1.1	7.5	10.7	4.4	5a	Fig. 5a TO-263AB Weight = 2 g
DGSK 32-018CS	180	15 90	1.0	7.5	21	4.4		
DGSK 28-025CS	250	14 90	1.2	7.5	15	4.4		
DGSK 40-025CS		20 90	1.1	10	24	3.1		
DGSK 36-030CS	300	17.5 90	1.1	7.5	10.7	4.4		
DGSS 10-060CC	2x 300	10 90	1.1	7.5	10,7	7.7	83	Fig. 83 ISOPLUS220™ Weight = 2 g

Silicon Carbide Schottky Diodes

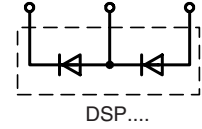
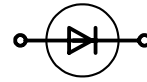
No reverse recovery



Type	V _{RRM}	I _{DC} @ T _C	V _F typ. @ T _{VJ} = 25...125 °C	I _F	C _J	R _{thJC}	Fig. No.	Package style
New	V	A °C	V	A	pF	K/W		Outline drawings on pages O-5...O-17
FBS 10-06SC	600	3 90	1.7	4	9	8	84	Fig. 84 ISOPLUS i4-PAC™ Weight = 9 g
FBS 16-06SC	600	5 90	1.5	6		5.6		
FBS 10-12SC	1200		under development					



Rectifier Diodes

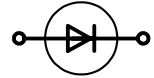
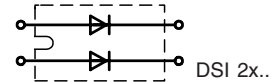
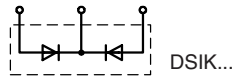


$I_{FAV} = 2-45 \text{ A}$, Standard Diodes (DS.), Avalanche Diodes (DSA..)

Type	V_{RRM}	I_{FAV} $T_C = 100^\circ\text{C}$ A	P_{RSM} kW	I_{FRMS} A	I_{FSM} 45°C 10 ms A	V_{TO} V	r_T mΩ	T_{VJM} °C	R_{thJC} K/W	R_{thCH} K/W	Fig. No.	Package style
□ New	V	A	kW	A	A	V	mΩ	°C	K/W	K/W		Outline drawings on pages O-5...O-17
DS 1-12 D	1200	2.3	-	7	110	0.8	67	150	$R_{thJA} = 80$		14	Fig. 3 TO-220AB Weight = 4 g
DSA 1-12 D	1200		1.6	7	110	0.8	67	150	$R_{thJA} = 80$			
DSA 1-16 D	1600											
DSA 1-18 D	1800											
DS 2-08 A	800	3.6	-	7	120	0.85	43	180	$R_{thJA} = 30$		15	Fig. 4 TO-220 AC Weight = 2 g
DS 2-12 A	1200											
DSA 2-12 A	1200		2.5	7	120	0.85	43	180	$R_{thJA} = 30$			
DSA 2-16 A	1600											
DSA 2-18 A	1800											
□ DSP 8-08 S	800	2x11	-	2x17	100	0.8	40	180	3.5	0.6	5a	Fig. 5a TO-263 AB Weight = 2 g
□ DSP 8-12 S	1200											
DSP 8-08 A	800	2x11	-	2x17	100	0.8	40	180	3.5	0.6	4	Fig. 5b TO-263 AA Weight = 2 g
DSP 8-12 A	1200											
DSP 8-08 AS	800	2x11	-	2x17	100	0.8	40	180	3.5	0.6	5b	Fig. 6 TO-247 AD Weight = 6 g
DSP 8-12 AS	1200											
DSP 8-12 AC□	1200	2x11	-	2x17	100	0.8	40	180	3.5	0.6	83	Fig. 7 ISOPLUS247™ DCB isol. package Weight = 5 g
DSP 25-12 A	1200	2x28	-	2x43	300	0.8	15	180	1.5	0.4	6	
DSP 25-16 A	1600											
DSP 25-16 AR□	1600	2x28	-	2x43	300	0.8	15	180	1.5	0.4	7	Fig. 10 TO-268 AA Weight = 6 g
DSP 25-12 AT	1200	2x28	-	2x43	300	0.8	15	180	1.5	0.4	10	
DSP 25-16 AT	1600											
DSP 45-12 A	1200	2x45	-	2x70	480	0.8	11	180	0.55	0.2	6	Fig. 14
DSP 45-16 A	1600											
□ DSP 45-16 AR	1600	2x43	-	2x70	480	0.8	11	150	0.7	0.2	7	Fig. 15 Weight = 1.5 g
DS 9-08 F	800	11	-	18	250	0.85	15	180	2	1	16	Fig. 16, Weight = 5 g, M5
DS 9-12 F	1200											
DSA 9-12 F	1200	11	4.5	18	250	0.85	15	180	2	1		Fig. 17, Weight = 6 g, 10-32UNF2A DO-203AA (DO-4)
DSA 9-16 F	1600											
DSA 9-18 F	1800											
DS 17-08 A	800	25	-	40	370	0.85	8	180	1.5	0.6	17	Fig. 83 ISOPLUS220™ Weight = 2 g
DS 17-12 A	1200	$T_C = 125^\circ\text{C}$										
DSA 17-12 A	1200	25	7	40	370	0.85	8	180	1.5	0.6		Fig. 101 ISOPLUS220™ Weight = 2 g
DSA 17-16 A	1600											
DSA 17-18 A	1800	$T_C = 125^\circ\text{C}$										
DSI 17-08 A	800	25	-	40	370	0.85	8	180	1.5	0.6		
DSI 17-12 A	1200											
DSAI 17-12 A	1200	25	7	40	370	0.85	8	180	1.5	0.6		
DSAI 17-16 A	1600											
DSAI 17-18 A	1800											
DSI 30-08 A	800	30	-	-	300	0.85	13	150	1	-	3	
DSI 30-12 A	1200											
DSI 30-16 A	1600											
DSI 30-08 AS	800	30	-	-	300	0.85	13	150	1	-	5a	
DSI 30-12 AS	1200											
DSI 30-16 AS	1600											
DSI 30-08 AC□	800	30	-	-	300	0.85	13	150	1	-	101	
DSI 30-12 AC□	800											

□ isolated 2500 V_{RMS}

Rectifier Diodes



$I_{FAV} = 45-160$ A, Standard Diodes (DS..), Avalanche Diodes (DSA..)

Type	V_{RRM}	I_{FAV} $T_C = 100^\circ\text{C}$	P_{RSM}	I_{FRMS}	I_{FSM} 45°C 10 ms	V_{TO}	r_T	T_{VJM}	R_{thJC}	R_{thCH}	Fig. No.	Package style
□ New	V	A	kW	A	A	V	mΩ	°C	K/W	K/W		Outline drawings on pages O-5...O-17
DS 35-08 A DS 35-12 A	800 1200	49	-	80	650	0.85	4.5	180	1.05	0.2	18	 Fig. 7 ISOPLUS247™ DCB isol. package Weight = 5 g
DSA 35-12 A DSA 35-16 A DSA 35-18 A	1200 1600 1800	49	11	80	650	0.85	4.5	180	1.05	0.2		
DSI 35-08 A DSI 35-12 A	800 1200	49	-	80	650	0.85	4.5	180	1.05	0.2	18	
DSAI 35-12 A DSAI 35-16 A DSAI 35-18 A	1200 1600 1800	49	11	80	650	0.85	4.5	180	1.05	0.2		Fig. 7a ISOPLUS247™ DCB isol. package Weight = 5 g
DSI 45-08 A DSI 45-12 A DSI 45-16 A	800 1200 1600	48	-	-	475	0.8	8.0	150	0.55	0.2	8	 Fig. 8 TO-247 AD Weight = 6 g
DSI 45-16 AR□	1600	48	-	-	475	0.8	8.0	150	0.55	0.2	7a	
□ DSIK 45-16 AR□	1600	45	-	-	475	0.8	8.0	150	0.65	0.2	7	
DS 75-08 B DS 75-12 B	800 1200	100	-	160	1400	0.75	2.0	180	0.5	0.3	19	 Fig. 18, Weight = 15 g DO-203AB (DO-5)
DSA 75-12 B DSA 75-16 B DSA 75-18 B	1200 1600 1800	100	20	160	1400	0.75	2.0	180	0.5	0.3		
DSI 75-08 B DSI 75-12 B	800 1200	100	-	160	1400	0.75	2.0	180	0.5	0.3		
DSAI 75-12 B DSAI 75-16 B DSAI 75-18 B	1200 1600 1800	100	20	160	1400	0.75	2.0	180	0.5	0.3		Fig. 19, Weight = 21 g DO-203AB (DO-5)
DSI 2x55-12A DSI 2x55-16A	1200 1600	2x56 $T_C = 80^\circ\text{C}$	-	120	650	0.8	8.0	150	0.65	0.1	12	Fig. 12 SOT-227B miniBLOC Weight = 30 g

□ isolated 2500 V_{RMS}



Silicon Rectifier Diodes



Silicon Rectifier Diodes.

The plastic material carries U/L recognition 94V-0.

Type No.		Max. Average Forward Rectified Current		Max. Repetitive Peak Reverse Voltage	Max. Repetitive Peak Forward Current	Max. Peak Forward Surge Current	Max. Forward Voltage Drop at Ta=25 °C		Max. Reverse Current at Ta=25 °C
Axial Lead	S.M.D.	IF(AV)	@ Ta (A) (°C)	VRRM (V)	IFRM (A)	IFSM (A)	VF @ IF (V)	(A)	IR (µA)

1N4001/SN1A Series. 1 Amp. Case: DO-41/SMA

1N4001	SN1A	1.0	75	50	10	30	1.0	1.0	5.0
1N4002	SN1B	1.0	75	100	10	30	1.0	1.0	5.0
1N4003	SN1D	1.0	75	200	10	30	1.0	1.0	5.0
1N4004	SN1G	1.0	75	400	10	30	1.0	1.0	5.0
1N4005	SN1J	1.0	75	600	10	30	1.0	1.0	5.0
1N4006	SN1K	1.0	75	800	10	30	1.0	1.0	5.0
1N4007	SN1M	1.0	75	1000	10	30	1.0	1.0	5.0
BY133	SN13	1.0	75	1300	10	30	1.0	1.0	5.0

1N4001G/GN1A Series. 1 Amp. Case: DO-41/SMA

1N4001G	GN1A	1.0	75	50	10	30	1.0	1.0	5.0
1N4002G	GN1B	1.0	75	100	10	30	1.0	1.0	5.0
1N4003G	GN1D	1.0	75	200	10	30	1.0	1.0	5.0
1N4004G	GN1G	1.0	75	400	10	30	1.0	1.0	5.0
1N4005G	GN1J	1.0	75	600	10	30	1.0	1.0	5.0
1N4006G	GN1K	1.0	75	800	10	30	1.0	1.0	5.0
1N4007G	GN1M	1.0	75	1000	10	30	1.0	1.0	5.0
BY133G	GN13	1.0	75	1300	10	30	1.0	1.0	5.0

BYW27/SNWA Series. 1 Amp. Case: DO-41/SMA

BYW27-50	SNWA	1.0	70	50	10	50	1.0	1.0	0.2
BYW27-100	SNWB	1.0	70	100	10	50	1.0	1.0	0.2
BYW27-200	SNWD	1.0	70	200	10	50	1.0	1.0	0.2
BYW27-400	SNWG	1.0	70	400	10	50	1.0	1.0	0.2
BYW27-600	SNWJ	1.0	70	600	10	50	1.0	1.0	0.2
BYW27-800	SNWK	1.0	70	800	10	50	1.0	1.0	0.2
BYW27-1000	SNWM	1.0	70	1000	10	50	1.0	1.0	0.2

1N5391/SNOA Series. 1.5 Amps. Case: DO-41/SMA

1N5391	SNOA	1.5	70	50	10	50	1.4	1.5	5.0
1N5392	SNOB	1.5	70	100	10	50	1.4	1.5	5.0
1N5393	SNOD	1.5	70	200	10	50	1.4	1.5	5.0
1N5394	SNOE	1.5	70	300	10	50	1.4	1.5	5.0
1N5395	SNOG	1.5	70	400	10	50	1.4	1.5	5.0
1N5396	SNOH	1.5	70	500	10	50	1.4	1.5	5.0
1N5397	SNOJ	1.5	70	600	10	50	1.4	1.5	5.0
1N5398	SNOK	1.5	70	800	10	50	1.4	1.5	5.0
1N5399	SNOM	1.5	70	1000	10	50	1.4	1.5	5.0

DR200/SN2A Series. 2 Amps. Case: D2/SMB

DR200	SN2A	2.0	50	50	15	75	1.0	2.0	5.0
DR201	SN2B	2.0	50	100	15	75	1.0	2.0	5.0
DR202	SN2D	2.0	50	200	15	75	1.0	2.0	5.0
DR204	SN2G	2.0	50	400	15	75	1.0	2.0	5.0
DR206	SN2J	2.0	50	600	15	75	1.0	2.0	5.0
DR208	SN2K	2.0	50	800	15	75	1.0	2.0	5.0
DR210	SN2M	2.0	50	1000	15	75	1.0	2.0	5.0

DR200G/GN2A Series. 2 Amps. Case: D2/SMB

DR200G	GN2A	2.0	50	50	15	75	1.0	2.0	5.0
DR201G	GN2B	2.0	50	100	15	75	1.0	2.0	5.0
DR202G	GN2D	2.0	50	200	15	75	1.0	2.0	5.0
DR204G	GN2G	2.0	50	400	15	75	1.0	2.0	5.0
DR206G	GN2J	2.0	50	600	15	75	1.0	2.0	5.0
DR208G	GN2K	2.0	50	800	15	75	1.0	2.0	5.0
DR210G	GN2M	2.0	50	1000	15	75	1.0	2.0	5.0

BY251/SN21 Series. 3 Amps. Case: DO-201AD/SMC

BY251	SN21	3.0	50	200	20	100	1.1	3.0	20
BY252	SN22	3.0	50	400	20	100	1.1	3.0	20
BY253	SN23	3.0	50	600	20	100	1.1	3.0	20
BY254	SN24	3.0	50	800	20	100	1.1	3.0	20
BY255	SN25	3.0	50	1300	20	100	1.1	3.0	20

1N5400/SN3A Series. 3 Amps. Case: DO-201AD/SMC

1N5400	SN3A	3.0	75	50	30	200	0.95	3.0	5.0
1N5401	SN3B	3.0	75	100	30	200	0.95	3.0	5.0
1N5402	SN3D	3.0	75	200	30	200	0.95	3.0	5.0
1N5404	SN3G	3.0	75	400	30	200	0.95	3.0	5.0
1N5406	SN3J	3.0	75	600	30	200	0.95	3.0	5.0
1N5407	SN3K	3.0	75	800	30	200	0.95	3.0	5.0
1N5408	SN3M	3.0	75	1000	30	200	0.95	3.0	5.0

1N5400G/GN3A Series. 3 Amps. Case: DO-201AD/SMC

1N5400G	GN3A	3.0	75	50	20	150	1.0	3.0	5.0
1N5401G	GN3B	3.0	75	100	20	150	1.0	3.0	5.0
1N5402G	GN3D	3.0	75	200	20	150	1.0	3.0	5.0
1N5404G	GN3G	3.0	75	400	20	150	1.0	3.0	5.0
1N5406G	GN3J	3.0	75	600	20	150	1.0	3.0	5.0
1N5407G	GN3K	3.0	75	800	20	150	1.1	3.0	5.0
1N5408G	GN3M	3.0	75	1000	20	150	1.1	3.0	5.0

BY550/SN5A Series. 5 Amps. Case: DO-201AD/SMC

BY550-50	SN5A	5.0	60	50	40	300	1.1	5.0	20
BY550-100	SN5B	5.0	60	100	40	300	1.1	5.0	20
BY550-200	SN5D	5.0	60	200	40	300	1.1	5.0	20
BY550-400	SN5G	5.0	60	400	40	300	1.1	5.0	20
BY550-600	SN5J	5.0	60	600	40	300	1.1	5.0	20
BY550-800	SN5K	5.0	60	800	40	300	1.1	5.0	20
BY550-1000	SN5M	5.0	60	1000	40	300	1.1	5.0	20

High Speed Switching Diodes.

Type No.	Max. Average Forward Rectified Current		Max. Reverse Voltage	Max. Repetitive Peak Forward Current	Max. Repetitive Surge Current	Max. Forward Voltage Drop at Ta=25 °C		Max. Reverse Current at Ta=25 °C	Max. Reverse Recovery Time	Max. Power Dissipation
	IF(AV) @ Ta					VRM	IFRM			
	(mA)	(°C)	(V)	(mA)	(A)	(V)	(mA)	IR (μA)	T _{rr} (ns)	P _D (mW)

1N4148 Series. Case: DO-35



1N4148	150	25	75	450	0.5	1.0	10	5.0	4	500
1N4150	200	25	50	600	0.5	1.0	200	0.1	4	500
1N4151	200	25	75	450	0.5	1.0	50	0.05	4	500
1N4152	150	25	30	450	-	0.88	20	0.05	2	500
1N4153	150	25	50	450	-	0.88	20	0.05	2	500
1N4154	150	25	25	450	-	1.0	30	0.1	4	500

1N4448 Series. Case: DO-35



1N4447	150	25	75	450	-	1.0	20	5.0	4	500
1N4448	150	25	75	450	-	1.0	10	5.0	4	500
1N4449	150	25	75	450	-	1.0	30	5.0	4	500
1N4450	200	25	30	600	-	1.0	200	0.05	4	500
1N4454	150	25	75	450	-	1.0	10	5.0	4	500

1SS130 Series. Case: DO-34



1SS130	130	25	75	400	-	1.0	10	0.5	4	300
1SS131	130	25	80	400	0.6	1.2	100	0.5	4	300
1SS132	120	25	50	350	0.5	1.2	100	0.5	4	300
1SS133	110	25	35	300	0.6	1.2	100	0.5	4	300

1SS176 Series. Case: DO-34



1SS176	100	25	30	300	1.0	1.2	100	0.5	4	300
1SS177	100	25	50	300	1.0	1.2	100	0.5	4	300
1SS178	100	25	80	300	1.0	1.2	100	0.5	4	300

BAV19 Series. Case: DO-35



BAV19	200	25	100	625	1.0	1.0	100	0.1	50	500
BAV20	200	25	150	625	1.0	1.0	100	0.1	50	500
BAV21	200	25	200	625	1.0	1.0	100	0.1	50	500

BAW62 Series. Case: DO-35



BAW62	250	25	75	450	0.5	1.0	100	5.0	4	350
BAW75	150	25	25	-	2.0	1.0	30	0.1	4	500
BAW76	150	25	50	-	2.0	1.0	100	0.1	4	500

BAV100 Series. Case: MiniMELF



BAV100	200	25	50	625	1.0	1.0	100	0.1	50	400
BAV101	200	25	100	625	1.0	1.0	100	0.1	50	400
BAV102	200	25	150	625	1.0	1.0	100	0.1	50	400
BAV103	200	25	200	625	1.0	1.0	100	0.1	50	400
BAV105	300	25	60	600	0.5	1.0	200	0.1	6	500

LL4148 Series. Case: MiniMELF



LL4148	200	25	75	450	0.5	1.0	10	5.0	4	500
LL4150	200	25	50	600	0.5	1.0	200	0.1	4	500
LL4151	200	25	50	450	0.5	1.0	50	0.05	4	500
LL4153	200	25	50	450	0.5	0.88	50	0.05	4	500
LL4448	200	25	75	450	0.5	1.0	100	5.0	4	500

1N4148WS & BAS16WS. Case: SOD-323



1N4148WS	150	25	75	-	0.35	1.0	10	5.0	4	200
BAS16WS	250	25	75	-	0.5	1.0	50	1.0	6	200

BAV19WS Series. Case: SOD-323



BAV19WS	200	25	100	625	1.0	1.0	100	0.1	50	200
BAV20WS	200	25	150	625	1.0	1.0	100	0.1	50	200
BAV21WS	200	25	200	625	1.0	1.0	100	0.1	50	200

Fast Recovery Rectifiers



FR101G/GR1A Series, 1 Amp, Case: DO-41/SMA

FR101G	GR1A	1.0	55	50	5.0	30	13	10	5.0	150
FR101G	GR1B	1.0	55	100	5.0	30	13	10	5.0	150
FR101G	GR1D	1.0	55	200	5.0	30	13	10	5.0	150
FR101G	GR1G	1.0	55	400	5.0	30	13	10	5.0	150
FR101G	GR1J	1.0	55	600	5.0	30	13	10	5.0	250
FR101G	GR1K	1.0	55	800	5.0	30	13	10	5.0	500
FR101G	GR1M	1.0	55	1000	5.0	30	13	10	5.0	500
FR101G-STR	-	1.0	55	1000	5.0	30	13	10	5.0	250

1N4933/GRN3 Series, 1 Amp, Case: DO-41/SMA

1N4933G	GRN3	1.0	50	50	5.0	30	12	10	5.0	150
1N4946G	GRN4	1.0	50	100	5.0	30	12	10	5.0	150
1N4956G	GRN5	1.0	50	200	5.0	30	12	10	5.0	150
1N4966G	GRN6	1.0	50	400	5.0	30	12	10	5.0	150
1N4976G	GRN7	1.0	50	600	5.0	30	12	10	5.0	150

FR201G/GR2A Series, 2 Amps, Case: DO-201AD/SMB

FR201G	GR2A	2.0	75	50	10	75	13	20	10	150
FR201G	GR2B	2.0	75	100	10	75	13	20	10	150
FR201G	GR2D	2.0	75	200	10	75	13	20	10	150
FR201G	GR2G	2.0	75	400	10	75	13	20	10	150
FR201G	GR2J	2.0	75	600	10	75	13	20	10	250
FR201G	GR2K	2.0	75	800	10	75	13	20	10	500
FR201G	GR2M	2.0	75	1000	10	75	13	20	10	500
FR201G-STR	-	2.0	75	1000	10	75	13	20	10	250

FR301G/GR3A Series, 3 Amps, Case: DO-201AD/SMB

FR301G	GR3A	3.0	55	50	15	100	13	30	5.0	150
FR301G	GR3B	3.0	55	100	15	100	13	30	5.0	150
FR301G	GR3D	3.0	55	200	15	100	13	30	5.0	150
FR301G	GR3G	3.0	55	400	15	100	13	30	5.0	150
FR301G	GR3J	3.0	55	600	15	100	13	30	5.0	250
FR301G	GR3K	3.0	55	800	15	100	13	30	5.0	500
FR301G	GR3M	3.0	55	1000	15	100	13	30	5.0	500
FR301G-STR	-	3.0	55	1000	15	100	13	30	5.0	250

Note: (1) Reverse recovery test conditions: $I_F = 0.5 A, I_R = 1.0 A, t_{rr} = 0.25 A$.

BV126A Series, 1.0 Amps, Case: DO-41

BV126A	1.0	55	200	300	1.3	1.0	5.0	30
BV126B	1.0	55	400	500	1.3	1.0	5.0	30
BV126C	1.0	55	600	700	1.3	1.0	5.0	30
BV126D	1.0	55	800	900	1.3	1.0	5.0	75
BV126E	1.0	55	1000	1100	1.3	1.0	5.0	75

BV127 Series, 2.0 Amps, Case: DZ

BV127-100	2.0	85	100	110	1.07	3.0	1.0	25
BV127-150	2.0	85	150	165	1.07	3.0	1.0	25
BV127-200	2.0	85	200	220	1.07	3.0	1.0	25

BV1033D Series, 1.3 Amps, Case: DO-41

BV1033D	1.3	55	200	300	1.3	1.0	1.0	250
BV1033G	1.3	55	400	500	1.3	1.0	1.0	250
BV1033J	1.3	55	600	700	1.3	1.0	1.0	250
BV1033K	1.3	55	800	900	1.3	1.0	1.0	300
BV1033M	1.3	55	1000	1100	1.3	1.0	1.0	300

BV136 Series, 1.5 - 1.6 Amps, Case: DZ

BV136A	1.6	60	200	300	1.35	1.0	5.0	100
BV136B	1.6	60	400	500	1.35	1.0	5.0	100
BV136C	1.6	60	600	700	1.35	1.0	5.0	100
BV136D	1.5	60	800	900	1.45	1.0	5.0	150
BV136E	1.5	60	1000	1100	1.45	1.0	5.0	150

BV195 Series, 1.5 Amps, Case: DZ

BV195A	1.5	55	200	300	1.6	3.0	5.0	250
BV195B	1.5	55	400	500	1.6	3.0	5.0	250
BV195C	1.5	55	600	700	1.6	3.0	5.0	250
BV195D	1.5	55	800	900	1.6	3.0	5.0	300
BV195E	1.5	55	1000	1100	1.6	3.0	5.0	300

BV195 Series, 3.0 Amps, Case: DO-201AD

BV195A	3.0	55	200	300	1.5	5.0	5.0	250
BV195B	3.0	55	400	500	1.5	5.0	5.0	250
BV195C	3.0	55	600	700	1.5	5.0	5.0	250
BV195D	3.0	55	800	900	1.5	5.0	5.0	300
BV195E	3.0	55	1000	1100	1.5	5.0	5.0	300

Note: (1) Reverse recovery test conditions: $I_F = 0.5 A, I_R = 1.0 A, t_{rr} = 0.25 A$.

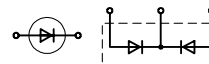
Part No.	Diodes / Number	Voltage V _{RM} (V)	Diodes / Number												Voltage V _{RM} (V)	Diodes / Number	
			5.4	5.4	5.4	5.4	5.4	5.4	5.4	5.4	5.4	5.4	5.4	5.4			5.4
500	EM618	500	EM618	EM618	EM618	EM618	EM618	EM618	EM618	EM618	EM618	EM618	EM618	EM618	EM618	500	EM618
1000	EM618	1000	EM618	EM618	EM618	EM618	EM618	EM618	EM618	EM618	EM618	EM618	EM618	EM618	EM618	1000	EM618
2000	EM618	2000	EM618	EM618	EM618	EM618	EM618	EM618	EM618	EM618	EM618	EM618	EM618	EM618	EM618	2000	EM618
3000	EM618	3000	EM618	EM618	EM618	EM618	EM618	EM618	EM618	EM618	EM618	EM618	EM618	EM618	EM618	3000	EM618
4000	EM618	4000	EM618	EM618	EM618	EM618	EM618	EM618	EM618	EM618	EM618	EM618	EM618	EM618	EM618	4000	EM618
5000	EM618	5000	EM618	EM618	EM618	EM618	EM618	EM618	EM618	EM618	EM618	EM618	EM618	EM618	EM618	5000	EM618
6000	EM618	6000	EM618	EM618	EM618	EM618	EM618	EM618	EM618	EM618	EM618	EM618	EM618	EM618	EM618	6000	EM618
7000	EM618	7000	EM618	EM618	EM618	EM618	EM618	EM618	EM618	EM618	EM618	EM618	EM618	EM618	EM618	7000	EM618
8000	EM618	8000	EM618	EM618	EM618	EM618	EM618	EM618	EM618	EM618	EM618	EM618	EM618	EM618	EM618	8000	EM618
9000	EM618	9000	EM618	EM618	EM618	EM618	EM618	EM618	EM618	EM618	EM618	EM618	EM618	EM618	EM618	9000	EM618
10000	EM618	10000	EM618	EM618	EM618	EM618	EM618	EM618	EM618	EM618	EM618	EM618	EM618	EM618	EM618	10000	EM618

Diodes / Rectifiers

FRED Diodes

Fast Recovery Epitaxial Diodes (FRED)

$I_{FAV} = 6 - 120 \text{ A}$



DSEI... DSEK...

Type	V_{RRM}	$I_{FAV} @ T_C$ d = 0.5		I_{FRMS}	I_{FSM} 10 ms 45°C	$V_F @ I_F$ max. $T_{VJ} = 150^\circ\text{C}$		t_{rr} typ. $T_{VJ} = 25^\circ\text{C}$	$I_{RM} @ -di/dt$ typ. $T_{VJ} = 100^\circ\text{C}$		R_{thJC}	Fig. No.	Package style
$T_{VM} = 150^\circ\text{C}$ New	V	A	°C	A	A	V	A	ns	A	A/ μs	K/W		Outline drawings on pages O-5...O-17
DSEI 6-06AS	600	6	125	16	65	1.3	8	35	2.5	64	3.0	2	Fig. 2 TO-252 AA Weight = 0.3 g
DSEI 8-06A	600	8	115	16	100	1.3	8	35	2.5	64	2.5	4	
DSEI 8-06AS	600	8	115	16	100	1.3	8	35	2.5	64	2.5	5a	
DSEI 12-06A	600	14	100	25	100	1.5	16	35	4	100	2.0	4	Fig. 4 TO-220 AC Weight = 2 g
DSEI 12-10A	1000	12	100	25	75	2.1	12	50	6.5	100	1.6		
DSEI 12-12A	1200	11	100	25	75	2.2	12	50	6.5	100	1.6		
DSEI 20-12A	1200	17	85	70	130	1.87	12	40	7	100	1.6		
DSEI 19-06AS	600	20	65	25	100	1.5	16	35	4	100	2.0	5a	Fig. 5a TO-263 AB Weight = 2 g
DSEI 36-06AS	600	37	85	70	300	1.4	37	35	10	240	1.0		
DSEI 30-06A	600	37	85	70	300	1.4	37	35	10	240	1.0	8	
DSEI 30-10A	1000	30	85	70	200	2.0	36	35	16	240	0.9		
DSEI 30-10AR	1000	30	85	70	200	2.0	36	35	16	240	0.9	7a	
DSEI 30-12A	1200	26	85	70	200	2.2	30	40	16	240	0.9	8	
DSEI 60-02A	200	69	85	98	600	0.88	60	35	8	200	0.75	8	Fig. 10 TO-268 AA Weight = 6 g
DSEI 60-06A	600	60	70	100	550	1.5	70	35	19	480	0.75		
DSEI 60-06AT	600	60	70	100	550	1.5	70	35	19	480	0.75	10	
DSEI 60-10A	1000	60	60	100	500	1.8	60	35	32	480	0.66		
DSEI 60-12A	1200	52	60	100	500	1.65	60	40	32	480	0.66		Fig. 6 TO-247 AD Weight = 6 g
DSEI 120-06A	600	126	70	100	600	1.12	70	35	17	200	0.35	8	
DSEI 120-12A	1200	109	60	100	600	1.16	70	40	16	200	0.35		
DSDI 60-14A	not for new design, Replacement part DH60-14A											8	
DSDI 60-16A	not for new design, Replacement part DH60-16A												
DSDI 60-18A	not for new design, Replacement part DH60-18A												
DSEK 60-02A	200	2x34	115	50	325	0.85	30	35	4	100	1.0	6	Fig. 7 ISOPLUS247™ DCB isol. package Weight = 5 g
DSEK 60-02AR	200	2x34	85	50	325	0.85	30	35	4	100	1.0	7	
DSEK 60-06A	600	2x30	85	50	300	1.4	37	35	10	240	1.0	6	
DSEK 60-12A	1200	2x26	85	50	200	2.2	30	40	16	240	1.9	6	

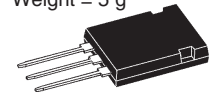


Fig. 7a
ISOPLUS247™
DCB isol. package
Weight = 5 g

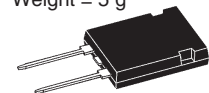
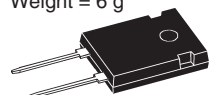
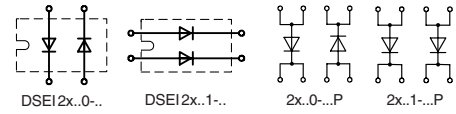


Fig. 8 TO-247AD
Weight = 6 g




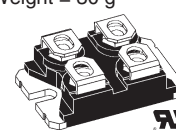
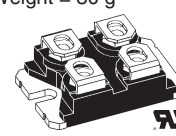
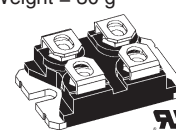


Diodes / Rectifiers

Fast Recovery Epitaxial Diodes (FRED)



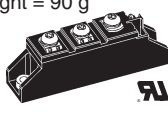
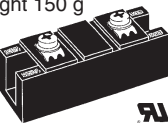
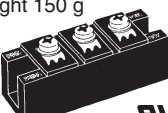
$$I_{FAV} = 2x30 - 2x160 \text{ A}$$

Type	V_{RRM}	$I_{FAV} @ T_C$ $d = 0.5$	I_{FRMS} 10 ms 45°C	I_{FSM} max.	$V_F @ I_F$ typ.	t_{rr} typ.	$I_{RM} @ -di/dt$	R_{thJC}	Fig. No.	Package style
$T_{VJM} = 150^\circ\text{C}$ New	V	A °C	A	A	$T_{VJ} = 150^\circ\text{C}$ V A	$T_{VJ} = 25^\circ\text{C}$ ns	$T_{VJ} = 100^\circ\text{C}$ A A/ μs	K/W		Outline drawings on pages O-5...O-17
DSEI 2x30-06P	600	2x30 85	70	300	1.4 30	35	10 240	1.25	24	Fig. 25 ECO-PAC 2 Weight = 24 g 
DSEI 2x30-10P	1000	2x30 50	70	200	2.0 30	35	16 240	1.25		
DSEI 2x30-12P	1200	2x28 50	70	200	2.2 30	40	16 240	1.25		
DSEI 2x30-04C	400	2x30 85	70	300	1.4 30	35	10 240	1.25	12	Fig. 24 ECO-PAC 1 Weight = 19 g 
DSEI 2x30-06C	600	2x30 85	70	300	1.4 30	35	10 240	1.25		
DSEI 2x30-10B	1000	2x30 50	70	200	2.0 36	35	16 240	1.25		
DSEI 2x30-12B	1200	2x28 50	70	200	2.2 30	40	16 240	1.25		
DSEI 2x31-06P	600	2x30 85	70	300	1.4 30	35	10 240	1.25	24	See data sheet for pin arrangement
DSEI 2x31-10P	1000	2x30 50	70	200	2.0 30	35	16 240	1.25		
DSEI 2x31-12P	1200	2x28 50	70	200	2.2 30	40	16 240	1.25		
DSEI 2x31-04C	400	2x30 85	70	300	1.4 30	35	10 240	1.25	12	Fig. 24 ECO-PAC 1 Weight = 19 g 
DSEI 2x31-06C	600	2x30 85	70	300	1.4 30	35	10 240	1.25		
DSEI 2x31-10B	1000	2x30 50	70	200	2.0 30	35	16 240	1.25		
DSEI 2x31-12B	1200	2x28 50	70	200	2.2 30	40	16 240	1.25		
DSEI 2x61-02P	200	2x71 85	100	950	0.88 60	35	8 200	0.8	24	See data sheet for pin arrangement
DSEI 2x61-06P	600	2x60 70	100	550	1.50 60	35	19 480	0.7		
DSEI 2x61-10P	1000	2x60 50	100	500	1.80 60	35	32 540	0.7		
DSEI 2x61-12P	1200	2x52 50	100	450	2.15 60	40	32 540	0.7		
DSEI 2x61-02A	200	2x71 85	100	950	0.88 60	35	8 200	0.8	12	Fig. 12 SOT-227B miniBLOC Weight = 30 g 
DSEI 2x61-04C	400	2x60 70	100	550	1.50 60	35	19 480	0.7		
DSEI 2x61-06C	600	2x60 70	100	550	1.50 60	35	19 480	0.7		
DSEI 2x61-10B	1000	2x60 50	100	500	1.80 60	35	32 480	0.7		
DSEI 2x61-12B	1200	2x52 50	100	450	2.15 60	40	32 480	0.7		
DSEI 2x121-02P	200	2x123 70	150	1200	0.89 120	35	12 200	0.7	25	Fig. 12 SOT-227B miniBLOC Weight = 30 g
DSEI 2x121-02A	200	2x123 70	150	1200	0.95 120	35	12 200	0.5	12	
DSEI 2x101-06P	600	2x96 70	150	1200	1.17 100	40	19 200	0.5	25	
DSEI 2x101-12P	1200	2x91 50	130	900	1.61 100	40	24 200	0.5		
DSEI 2x101-06A	600	2x96 70	150	1200	1.17 100	35	19 200	0.5	12	
DSEI 2x101-12A	1200	2x91 50	130	1200	1.61 100	40	24 200	0.5		
DSEI 2x161-02P	200	2x165 70	270	1200	1.20 200	35	20 200	0.29	25	
DSEI 2x161-06P	600	2x147 70	270	1200	1.45 200	35	45 200	0.29		
DSEI 2x161-12P	1200	2x128 70	270	1200	1.90 200	40	48 200	0.29		

Data according to IEC 60747 and refer to a single diode or thyristor unless otherwise stated.

FRED Modules

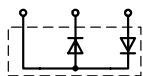
$I_{FAV} = 75 - 582 \text{ A}$

Type	V_{RRM}	$I_{FAV} @ T_C$ $d = 0.5$		I_{FRMS}	I_{FSM} 10 ms 45°C	$V_F @ I_F$ max. $T_{VJ} = 125^\circ\text{C}$		t_{rr} typ. $T_{VJ} = 25^\circ\text{C}$	$I_{RM} @ -di/dt$ typ. $T_{VJ} = 100^\circ\text{C}$		R_{thJC}	P_{tot} max. W	Fig. No.	Package style
$T_{VJM} = 150^\circ\text{C}$ □ New	V	A	°C	A	A	V	A	ns	A	A/ μs	K/W	W		Outline drawings on pages O-5...O-17
MEO 550-02DA MEO 500-06DA MEO 450-12DA	200 600 1200	582 514 453	75 75 75	822 726 640	4800	1.08 1.41 1.76	520 520 520	150 250 450	15 132 165	200 800 800	0.071	1750 1750 1750	29	Fig. 27 Weight = 90 g 
MEK 75-12DA MEA 75-12DA MEE 75-12DA	1200 1200 1200	75 75 75	75 75 75	107	1200	1.85	100	250	33	200	0.45	280*	27	Fig. 29 Weight 150 g 
MEK 95-06DA MEA 95-06DA MEE 95-06DA	600 600 600	95 95 95	75 75 75	142	1200	1.36	100	250	21	200	0.45	280*		
MEK 150-04DA	400	150	100	200	1200	1.4 □	300	300	11	100	0.35	360		
□ MEK 600-04DA	400	575	80	800	3000	1.1	400	220	80	900	0.22	1100	30	Fig. 30 Weight 150 g 
MEK 350-02DA MEK 300-06DA MEK 250-12DA	200 600 1200	356 304 260	75 75 75	503 430 367	2400	0.92 1.19 1.54	260 260 260	150 250 450	15 66 83	200 400 400	0.143	875*		
MEE 300-06DA MEE 250-12DA	600 1200	304 260	75 75	430 367	2400	1.19 1.54	260 260	250 450	66 83	400 400	0.143	875*		
MEA 300-06DA MEA 250-12DA	600 1200	304 260	75 75	430 367	2400	1.19 1.54	260 260	250 450	66 83	400 400	0.143	875*		

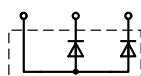
1 phase and 3 phase rectifiers with fast recovery epitaxial diodes (FRED)

* P_D □ $T_{VJM} = 150^\circ\text{C}$

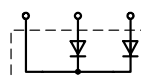
Diode connections for Fig. 27 (TO-240)



MEE

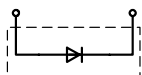


MEA

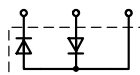


MEK

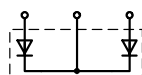
Diode connections for Fig. 29 and 30 (34 mm package)



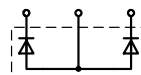
MEO



MEE



MEK



MEA

Super Fast Recovery Rectifiers



Super Fast Rectifier Diodes.

The plastic material carries U.L. recognition 94V-0.

Type No.	Max. Average Forward Rectified Current	Max. Repetitive Peak Reverse Voltage	Max. Repetitive Peak Forward Current	Max. Forward Surge Current	Max. Forward Voltage Drop at Ta=25 °C		Max. Reverse Current at Ta=25 °C	Max. Reverse Recovery Time
					V _F @ I _F	I _F		
Axial Lead	S.M.D.	I _{F(AV)} @ T _a (A) (°C)	V _{RRM} (V)	I _{FRM} (A)	I _{FSM} (A)	V _F @ I _F (V)	I _R (μA)	T _{rr} (ns)

AG01 Series. 0.5-1.0 Amp. Case: DO-41

AG01Y		1.0	25	70	-	25	1.2	1.0	100	100 ⁽²⁾
AG01Z		0.7	25	200	-	15	1.8	0.7	100	100 ⁽²⁾
AG01		0.7	25	400	-	15	1.8	0.7	100	100 ⁽²⁾
AG01A		0.5	25	600	-	15	1.8	0.5	100	100 ⁽²⁾

EG01 Series. 0.5 - 1.0 Amp. Case: DO-41

EG01Y		1.0	50	70	-	30	1.2	1	100	100 ⁽²⁾
EG01Z		0.7	50	200	-	15	1.9	0.7	50	100 ⁽²⁾
EG01		0.7	50	400	-	15	2.0	0.7	50	100 ⁽²⁾
EG01A		0.5	25	600	-	10	2.0	0.5	100	100 ⁽²⁾
EG01C		0.5	25	1000	-	10	3.3	0.5	500	100 ⁽²⁾

EG1 Series. 0.6 - 1.0 Amp. Case: DO-41

EG1Y		1.1	50	70	-	30	1.2	1.1	100	100 ⁽²⁾
EG1Z		0.8	50	200	-	15	1.7	0.8	50	100 ⁽²⁾
EG1		0.8	50	400	-	15	1.8	0.8	50	100 ⁽²⁾
EG1A		0.6	25	600	-	10	2.0	0.6	100	100 ⁽²⁾

ERA32-01 Series. 1 Amp. Case: DO-41

ERA32-01		1.0	40	100	-	40	0.92	1.0	10	100 ⁽²⁾
ERA32-02		1.0	40	200	-	40	0.92	1.0	10	100 ⁽²⁾

11DF1 Series. 1 Amp. Case: DO-41

11DF1		1.0	63	100	-	30	0.98	1.0	10	35 ⁽¹⁾
11DF2		1.0	63	200	-	30	0.98	1.0	10	35 ⁽¹⁾
11DF3		1.0	57	300	-	30	1.25	1.0	10	35 ⁽¹⁾
11DF4		1.0	57	400	-	30	1.25	1.0	10	35 ⁽¹⁾

MUR120 Series. 1 Amp. Case: DO-41

MUR120		1.0	25	200	-	35	0.875	1.0	2.0	25 ⁽¹⁾
MUR140		1.0	25	400	-	35	1.25	1.0	5.0	50 ⁽¹⁾
MUR160		1.0	25	600	-	35	1.25	1.0	5.0	50 ⁽¹⁾

RG10 Series. 1 - 1.5 Amps. Case: D2

RG10Y		1.5	55	70	5.0	50	1.1	1.5	5.0	35 ⁽¹⁾
RG10		1.2	55	400	5.0	50	1.8	1.5	5.0	35 ⁽¹⁾
RG10A		1.0	55	600	5.0	50	2.0	1.0	5.0	35 ⁽¹⁾

Notes: (1) Reverse recovery test conditions : I_F = 0.5 A, I_R = 1.0 A, I_{rr} = 0.25 A. (2) Reverse recovery test conditions : I_F = 100 mA, I_R = 100 mA

SF11/SS1A Series. 1 Amp. Case: DO-41/SMA

SF11	SS1A	1.0	55	50	5.0	30	0.95	1.0	5.0	35 ⁽¹⁾
SF12	SS1B	1.0	55	100	5.0	30	0.95	1.0	5.0	35 ⁽¹⁾
SF13	SS1C	1.0	55	150	5.0	30	0.95	1.0	5.0	35 ⁽¹⁾
SF14	SS1D	1.0	55	200	5.0	30	0.95	1.0	5.0	35 ⁽¹⁾
SF15	SS1E	1.0	55	300	5.0	30	1.70	1.0	5.0	35 ⁽¹⁾
SF16	SS1G	1.0	55	400	5.0	30	1.70	1.0	5.0	35 ⁽¹⁾
SF17	SS1J	1.0	55	600	5.0	30	1.70	1.0	5.0	35 ⁽¹⁾
SF18	SS1K	1.0	55	800	5.0	30	4.00	1.0	10	35 ⁽¹⁾
SF19	SS1M	1.0	55	1000	5.0	30	4.00	1.0	10	35 ⁽¹⁾

EL1 Series. 1.5 Amps. Case: DO-41

EL1Z		1.5	25	200	-	20	0.98	1.5	100	50 ⁽²⁾
EL1		1.5	25	350	-	20	1.30	1.5	10	50 ⁽²⁾

SF01/SSOA Series. 1.5 Amps. Case: DO-41/SMA

SF01	SSOA	1.5	55	50	5.0	60	0.95	1.5	5.0	35 ⁽¹⁾
SF02	SSOB	1.5	55	100	5.0	60	0.95	1.5	5.0	35 ⁽¹⁾
SF03	SSOC	1.5	55	150	5.0	60	0.95	1.5	5.0	35 ⁽¹⁾
SF04	SSOD	1.5	55	200	5.0	60	0.95	1.5	5.0	35 ⁽¹⁾
SF05	SSOE	1.5	55	300	5.0	60	1.70	1.5	5.0	35 ⁽¹⁾
SF06	SSOG	1.5	55	400	5.0	60	1.70	1.5	5.0	35 ⁽¹⁾
SF07	SSOJ	1.5	55	600	5.0	60	1.70	1.5	5.0	35 ⁽¹⁾
SF08	SSOK	1.5	55	800	5.0	60	4.00	1.5	20	35 ⁽¹⁾
SF09	SSOM	1.5	55	1000	5.0	60	4.00	1.5	20	35 ⁽¹⁾

SF21/SS2A Series. 2 Amps. Case: D2/SMB

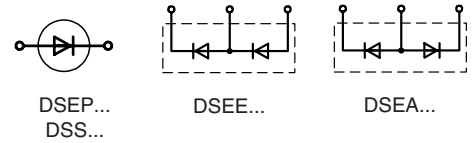
SF21	SS2A	2.0	55	50	10	75	0.95	2.0	5.0	35 ⁽¹⁾
SF22	SS2B	2.0	55	100	10	75	0.95	2.0	5.0	35 ⁽¹⁾
SF23	SS2C	2.0	55	150	10	75	0.95	2.0	5.0	35 ⁽¹⁾
SF24	SS2D	2.0	55	200	10	75	0.95	2.0	5.0	35 ⁽¹⁾
SF25	SS2E	2.0	55	300	10	75	1.70	2.0	5.0	35 ⁽¹⁾
SF26	SS2G	2.0	55	400	10	75	1.70	2.0	5.0	35 ⁽¹⁾
SF27	SS2J	2.0	55	600	10	75	1.70	2.0	5.0	35 ⁽¹⁾
SF28	SS2K	2.0	55	800	10	75	4.00	2.0	20	35 ⁽¹⁾
SF29	SS2M	2.0	55	1000	10	75	4.00	2.0	20	35 ⁽¹⁾

Notes: (1) Reverse recovery test conditions : I_F = 0.5 A, I_R = 1.0 A, I_{rr} = 0.25 A. (2) Reverse recovery test conditions : I_F = 100 mA, I_R = 100 mA

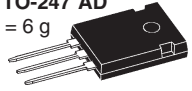
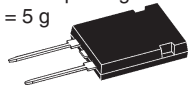
RG2 Series. 1 - 1.5 Amps. Case: D2

RG2Y		1.5	55	70	5.0	50	1.1	1.5	5.0	35 ⁽¹⁾
RG2Z		1.2	55	200	5.0	50	1.5	1.5	5.0	35 ⁽¹⁾
RG2		1.2	55	400	5.0	50	1.8	1.5	5.0	35 ⁽¹⁾
RG2A		1.0	50	600	5.0	50	2.0	1.0	5.0	35 ⁽¹⁾

HiPerDyn™ FRED

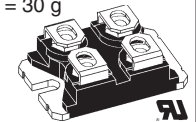


Series connected diodes for high switching frequencies;
packages isolated (2500 V_{RMS})

Type	V _{RRM} V	I _{FAV} @ T _C d = 0.5		V _F @ T _{VJ} max.		t _{tr} typ. T _{VJ} = 25°C ns	I _{RM} @ -di/dt typ. T _{VJ} = 100°C		T _{VJM} °C	R _{thJC} K/W	Fig. No.	Package style Outline drawings on pages O-5...O-17
		A	°C	V	°C		A	A/μs				
DSEP 9-06CR DSS 17-06CR * DSEP 30-06CR	600	9	140	2.9	150	15	3.5	100	175	1.0	7a	Fig. 6 TO-247 AD Weight = 6 g 
DSEP 15-12CR DSEP 30-12CR	1200	15	130	2.7	150	20	4.0	100	175	1.0		
DSEP 2x35-06 C	600	35	100	2.0	125	20	4.5	100	150	0.6	12	Fig. 7a ISOPLUS247™ DCB isolated package Weight = 5 g 
DSEP 2x25-12 C	1200	25	95	3.3	125	20	4.0	100	150	0.6		

* series connected Schottky Diodes

Fig. 12
SOT-227B miniBLOC
Weight = 30 g



Dual Ultrafast Diodes

Series connected diodes for high switching frequencies with middle
connection; packages isolated (2500 V_{RMS})

Type	V _{RRM} V	I _{FAV} @ T _C d = 0.5		V _{Fmax} @ T _{VJ}		t _{tr} typ. T _J = 25°C ns	I _{RM} typ @ -di/dt T _J = 100°C		T _{VJM} °C	R _{thJC} K/W	Fig. No.
		A	°C	V	°C		A	A/μs			
□ New											
DSEE 6-06CC DSEE 8-06CC DSEE 15-06CC DSEE 29-06CC	2x300	6	150	1.80	25	20	2	100	175	3.0	83
DSEE 15-12CC DSEE 29-12CC	2x600	15	85	2.05	25	35	4	100	175	1.6	
DSEE 30-12A □		30	90	2.50	25	30	4	100	175	0.9	6
□ DSEE 8-08CC	2x400	10	130	1.53	25	30	2	100	175	2.75	83
DSEE 55-24N1F	2x1200	53	90	2.50	25	220 / 125°C	79 / 125°C	750	150	0.63	86

□ Non isolated base plate

Fig. 83
ISOPLUS220™
Weight = 2 g



Fig. 86
ISOPLUS i4-PAC™
Weight = 9 g

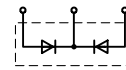


Common anode connected

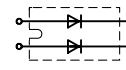
DSEA 16-06AC	600	2x10	85	1.42	125	35	3.5	100	175	3	83
DSEA 16-06BC		2x8	135	1.76	125	30	1.4	100	175	2.5	
DSEA 29-06AC		2x15	140	1.49	125	35	4	100	175	1.6	
DSEA 59-06BC		2x30	125	1.75	125	30	4	100	175	0.9	

Data according to IEC 60747 and refer to a single diode or thyristor unless otherwise stated.

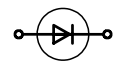
SONIC-FRD™ Diodes



DHC...



DH 2x...



DH...

- ultrasoft and fast recovery
- very low temperature dependence

Type	V _{RRM}	I _{FAV} @ T _C d = 0.5	V _F @ I _F max. T _{VJM} = 125°C	E _{AS}	I _{AR}	T _{VJM}	R _{thJC}	Fig. No.	Package style	
□ New	V	A	V	mJ	A	°C	K/W		Outline drawings on pages O-5...O-17	
□ DH 29-06B □ DHC 59-06B □ DH 60-06B □ DH 90-06B	600	87	80	1.65	60	5	1	150	0.4	4 3 8 8 Fig. 3 TO-220AB Weight = 4 g
□ DH 29-12A □ DH 30-12A □ DHC 59-12A □ DH 60-12A □ DH 90-12A	1200									4 8 3 8 8 8 Fig. 4 TO-220 AC Weight = 2 g
□ DH 15-18A □ DH 30-18A □ DH 60-18A	1800	64	60	2.70	70	tbd	tbd	150	0.4	4 8 8 Fig. 8 TO-247 AD Weight = 6 g
□ DH 2x61-06B □ DH 2x91-06B	600									12 12 Fig. 12 SOT-227B miniBLOC Weight = 30 g
□ DH 2x61-12A □ DH 2x91-12A	1200									12 12
□ DH 2x31-18A □ DH 2x61-18A	1800									12 12

HiPerFRED™ Diodes

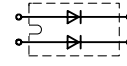
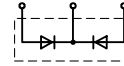


DSEP...

I_{FAV} = 8 - 2x120 A

Type	V _{RRM}	I _{FAV} @ T _C d = 0.5	I _{FSM} 10 ms 45°C	V _F @ I _F max. T _{VJM} = 150°C	t _{rr} typ. T _{VJ} = 25°C	I _{RM} @ -di/dt typ. T _{VJ} = 100°C	T _{VJM}	R _{thJC}	Fig. No.	Package style			
□ New	V	A	A	V	ns	A	°C	K/W		Outline drawings on pages 91-100			
DSEP 8-02A	200	8	150	80	0.94	8	25	4.1	100	175	2.5	4	Fig. 2 TO-252 AA Weight = 0.3 g
□ DSEP 8-03A □ DSEP 8-03AS □ DSEP 15-03A □ DSEP 29-03A □ DSEP 30-03A □ DSEP 60-03A	300	10	130	60	1.29	10	30	2.4	100	175	2.5	4	Fig. 4 TO-220 AC Weight = 2 g
DSEP 30-04A DSEP 60-04A	400	30	140	280	1.11	30	30	5.5	100	175	0.9	8	Fig. 5a TO-263AB Weight = 2 g
DSEP 6-06AS DSEP 8-06A DSEP 8-06B DSEP 15-06A DSEP 15-06B DSEP 29-06A DSEP 29-06AS DSEP 29-06B □ DSEP 29-06BS □ DSEP 30-06A □ DSEP 30-06B □ DSEP 30-06BR □ DSEP 60-06A □ DSEP 60-06AT	600	6	152	40	1.33	6	20	3.5	100	175	2.8	2	Fig. 7a ISOPLUS247™ Weight = 5 g
		10	135	50	1.42	10	35	3.5	100	175	2.5	4	Fig. 8 TO-247 AD Weight = 6 g
		10	125	50	1.66	10	30	2.4	100	175	2.5	4	
		15	140	110	1.35	15	35	4.0	100	175	1.6	4	
		15	130	110	1.55	15	25	2.5	100	175	1.6	4	
		30	135	250	1.26	30	35	6.0	100	175	0.9	4	
		30	135	250	1.26	30	35	6.0	100	175	0.9	5a	
		30	125	200	1.58	30	30	4.0	100	175	0.9	4	
		30	135	250	1.26	30	35	6.0	100	175	0.9	5a	
		30	135	250	1.25	30	35	6.0	100	175	0.9	8	
		30	125	250	1.56	30	30	4.0	100	175	0.9	8	
		30	115	250	1.56	30	30	4.0	100	175	0.9	7a	Fig. 10 TO-268 AA Weight = 6 g
		60	110	600	1.39	60	35	6.5	100	175	0.65	8	
		60	110	600	1.39	60	35	6.5	100	175	0.65	10	

HiPerFRED™ Diodes



$I_{FAV} = 8 - 2 \times 120 \text{ A}$

DSEP...

DSEC...

DSEP 2x...

DSEC

Type	V_{RRM}	$I_{FAV} @ T_C$ $d = 0.5$		I_{FSM} 10 ms 45°C	$V_F @ I_F$ max. $T_{VJM} = 150^\circ\text{C}$		t_{rr} typ. $T_{VJ} = 25^\circ\text{C}$	$I_{RM} @ -di/dt$ typ. $T_{VJ} = 100^\circ\text{C}$		T_{VJM}	R_{thJC}	Fig. No.	Package style
□ New	V	A	°C	A	V	A	ns	A	A/ μs	°C	K/W		Outline drawings on pages O-5...O-17
DSEP 8-12A	1200	10	115	40	1.96	10	40	4.0	100	175	2.5	4	Fig. 3 TO-220AB Weight = 4 g
DSEP 12-12A		15	125	90	1.79	15	40	4.5	100	175	1.6	4	
DSEP 29-12A		30	115	200	1.81	30	40	5.5	100	175	0.9	4	
DSEP 30-12A		30	115	200	1.78	30	40	5.5	100	175	0.9	8	
DSEP 30-12AR		30	105	200	1.78	30	40	5.5	100	175	1.1	7a	
DSEP 60-12A		60	90	500	1.74	60	40	7.0	100	175	0.65	8	
DSEP 60-12AR		60	90	500	1.74	60	40	7.0	100	175	0.65	7a	Fig. 4 TO-220 AC Weight = 2 g
DSEC 16-02A	200	2x8	150	80	0.94	8	25	3.5	100	175	2.5	3	
DSEC 29-02A		2x15	150	140	0.86	15	25	3.5	100	175	1.6	3	
DSEC 29-02AS		2x15	150	140	0.85	15	25	3.5	100	175	1.6	5a	
DSEC 30-02A		2x15	150	140	0.85	15	25	3.5	100	175	1.6	6	
DSEC 60-02A		2x30	145	325	0.95	30	25	4.0	100	175	0.9	6	
DSEC 60-02AQ		2x30	145	325	0.95	30	25	4.0	100	175	0.9	104	Fig. 5a TO-263AB Weight = 2 g
DSEC 30-03A	300	2x15	140	110	1.20	15	30	2.0	100	175	1.6	6	
DSEC 60-03A		2x30	145	300	0.91	30	30	4.5	100	175	0.9	6	
DSEC 60-03AR		2x30	145	300	0.91	30	30	4.5	100	175	1.1	7	
DSEC 60-03AQ		2x30	145	300	0.91	30	30	4.5	100	175	1.1	104	Fig. 6 TO-247 AD Weight = 6 g
DSEC 16-04AS	400	2x8	140	60	1.12	10	30	2	100	175	2.5	5a	
DSEC 30-04A		2x15	145	tbd	1.06	15	30	5.0	100	175	1.6	6	
DSEC 60-04A		2x30	140	tbd	1.09	30	30	5.5	100	175	1.6	6	
DSEC 16-06A	600	2x10	135	50	1.42	10	35	3.5	100	175	2.5	3	
DSEC 16-06AC		2x10	85	50	1.42	10	35	3.5	100	175	3.0	83	
DSEC 16-06BC		2x8	135	50	1.76/125°C	8	30	1.4	100	175	2.5	83	
DSEC 29-06AC		2x15	140	110	1.49	15	35	4.0	100	175	1.6	83	
DSEC 30-06A		2x15	140	110	1.34	15	35	4.0	100	175	1.6	6	
DSEC 30-06B		2x15	135	110	1.54	15	25	2.6	100	175	1.6	6	
DSEC 59-06BC		2x30	125	200	1.75	125	30	4.0	100	175	0.9	83	
DSEC 60-06A		2x30	135	250	1.25	30	35	6.0	100	175	0.9	6	
DSEC 60-06B		2x30	125	250	1.56	30	30	4.0	100	175	0.9	6	
DSEC 16-12A	1200	2x10	115	40	1.96	10	40	4.0	100	175	2.5	3	
DSEC 30-12A		2x15	125	90	1.78	15	40	4.5	100	175	1.6	6	
DSEC 60-12A		2x30	115	200	1.78	30	40	5.5	100	175	0.9	6	
DSEC 120-12AK		2x60	90	500	1.74	60	40	7	100	175	0.65	11	
DSEP 2x31-03A	300	2x30	110	300	0.96	30	30	4.5	100	150	1.15	12	Fig. 7a ISOPLUS247™ DCB isol. package Weight = 5 g
DSEP 2x61-03A		2x60	75	600	1.26	60	30	4.0	100	150	0.85		
DSEP 2x91-03A		2x90	65	1000	1.30	90	30	4.5	100	150	0.6		
DSEP 2x31-04A	400	2x30	105	280	1.15	30	30	5.5	100	150	1.15	Fig. 12 SOT-227B miniBLOC Weight = 30 g 	
DSEP 2x31-06A	600	2x30	95	250	1.30	30	35	6.0	100	150	1.15		
DSEP 2x31-06B		2x30	85	250	1.73	30	30	4.0	100	150	1.15		
DSEP 2x61-06A		2x60	65	600	1.48	60	35	6.5	100	150	0.85		
DSEP 2x91-06A		2x90	55	1000	1.52	90	35	6.0	100	150	0.6		
DSEP 2x31-12A	1200	2x30	70	200	1.96	30	40	5.5	100	150	1.15	Fig. 83 ISOPLUS220™ Weight = 2 g 	
DSEP 2x60-12A		2x60	80	800	1.70	60	40	8.0	100	150	0.6		
DSEP 2x61-12A		2x60	80	800	1.70	60	40	8.0	100	150	0.6		
DSEP 2x101-04A	400	2x101	100	1000	1.24	125	30	5.5	100	150	0.6	Fig. 11 TO-264 Weight = 10 g 	
DSEC 240-04A □	400	2x120	115	2000	1.07	120	30	5.5	100	150	0.2		
DSEC 240-06A □	600	2x120	105	2000	1.39	120	35	6.0	100	150	0.2	Fig. 104 TO-3P Weight = 5 g 	

□ Non isolated base plate

Fig. 11
TO-264
Weight = 10 g

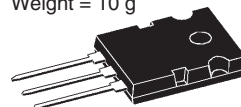
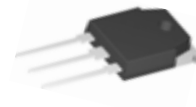


Fig. 104 TO-3P
Weight = 5 g



High Efficient Rectifier Diodes



High Efficient Rectifier Diodes.

The plastic material carries U/L recognition 94V-0.

Type No.	S.M.D.	Max. Average Forward Rectified Current		Max. Repetitive Peak Reverse Voltage	Max. Repetitive Peak Forward Current	Max. Forward Surge Current	Max. Forward Voltage Drop at Ta=25 °C		Max. Reverse Current at Ta=25 °C	Max. Reverse Recovery Time
		IF(AV) @ Ta	(°C)				VFRM	IFRM		

HER101/SE1A Series. 1 Amp. Case: DO-41/SMA

HER101	SE1A	1.0	55	50	5.0	30	1.1	1.0	5.0	50
HER102	SE1B	1.0	55	100	5.0	30	1.1	1.0	5.0	50
HER103	SE1D	1.0	55	200	5.0	30	1.1	1.0	5.0	50
HER104	SE1E	1.0	55	300	5.0	30	1.1	1.0	5.0	50
HER105	SE1G	1.0	55	400	5.0	30	1.1	1.0	5.0	50
HER106	SE1J	1.0	55	600	5.0	30	1.7	1.0	5.0	75
HER107	SE1K	1.0	55	800	5.0	30	1.7	1.0	5.0	75
HER108	SE1M	1.0	55	1000	5.0	30	1.7	1.0	5.0	75

HER151/SE0A Series. 1.5 Amps. Case: DO-41/SMA

HER151	SE0A	1.5	55	50	5.0	60	1.1	1.5	5.0	50
HER152	SE0B	1.5	55	100	5.0	60	1.1	1.5	5.0	50
HER153	SE0D	1.5	55	200	5.0	60	1.1	1.5	5.0	50
HER154	SE0E	1.5	55	300	5.0	60	1.1	1.5	5.0	50
HER155	SE0G	1.5	55	400	5.0	60	1.1	1.5	5.0	50
HER156	SE0J	1.5	55	600	5.0	60	1.7	1.5	5.0	75
HER157	SE0K	1.5	55	800	5.0	60	1.7	1.5	5.0	75
HER158	SE0M	1.5	55	1000	5.0	60	1.7	1.5	5.0	75

HER201/SE2A Series. 2 Amps. Case: D2/SMB

HER201	SE2A	2.0	55	50	10	75	1.1	2.0	10	50
HER202	SE2B	2.0	55	100	10	75	1.1	2.0	10	50
HER203	SE2D	2.0	55	200	10	75	1.1	2.0	10	50
HER204	SE2E	2.0	55	300	10	75	1.1	2.0	10	50
HER205	SE2G	2.0	55	400	10	75	1.1	2.0	10	50
HER206	SE2J	2.0	55	600	10	75	1.7	2.0	10	75
HER207	SE2K	2.0	55	800	10	75	1.7	2.0	10	75
HER208	SE2M	2.0	55	1000	10	75	1.7	2.0	10	75

HER251/SETA Series. 2.5 Amps. Case: D2A/SMB

HER251	SETA	2.5	55	50	10	100	1.1	2.5	10	50
HER252	SETB	2.5	55	100	10	100	1.1	2.5	10	50
HER253	SETD	2.5	55	200	10	100	1.1	2.5	10	50
HER254	SETE	2.5	55	300	10	100	1.1	2.5	10	50
HER255	SETG	2.5	55	400	10	100	1.1	2.5	10	50
HER256	SETJ	2.5	55	600	10	100	1.7	2.5	10	75
HER257	SETK	2.5	55	800	10	100	1.7	2.5	10	75
HER258	SETM	2.5	55	1000	10	100	1.7	2.5	10	75

Note : (1) Reverse recovery test conditions : IF = 0.5 A, IR = 1.0 A, Itr = 0.25 A.

HER301/SE3A Series. 3 Amps. Case: DO-201AD/SMC

HER301	SE3A	3.0	55	50	15	150	1.1	3.0	10	50
HER302	SE3B	3.0	55	100	15	150	1.1	3.0	10	50
HER303	SE3D	3.0	55	200	15	150	1.1	3.0	10	50
HER304	SE3E	3.0	55	300	15	150	1.1	3.0	10	50
HER305	SE3G	3.0	55	400	15	150	1.1	3.0	10	50
HER306	SE3J	3.0	55	600	15	150	1.7	3.0	10	75
HER307	SE3K	3.0	55	800	15	150	1.7	3.0	10	75
HER308	SE3M	3.0	55	1000	15	150	1.7	3.0	10	75

HER501/SE5A Series. 5 Amps. Case: DO-201AD/SMC

HER501	SE5A	5.0	55	50	25	200	1.1	5.0	10	50
HER502	SE5B	5.0	55	100	25	200	1.1	5.0	10	50
HER503	SE5D	5.0	55	200	25	200	1.1	5.0	10	50
HER504	SE5E	5.0	55	300	25	200	1.1	5.0	10	50
HER505	SE5G	5.0	55	400	25	200	1.1	5.0	10	50
HER506	SE5J	5.0	55	600	25	200	1.7	5.0	10	75
HER507	SE5K	5.0	55	800	25	200	1.7	5.0	10	75
HER508	SE5M	5.0	55	1000	25	200	1.7	5.0	10	75

HER601 Series. 6 Amps. Case: D6

HER601		6.0	55	50	25	200	1.1	6.0	10	50
HER602		6.0	55	100	25	200	1.1	6.0	10	50
HER603		6.0	55	200	25	200	1.1	6.0	10	50
HER604		6.0	55	300	25	200	1.1	6.0	10	50
HER605		6.0	55	400	25	200	1.1	6.0	10	50
HER606		6.0	55	600	25	200	1.7	6.0	10	75
HER607		6.0	55	800	25	200	1.7	6.0	10	75
HER608		6.0	55	1000	25	200	1.7	6.0	10	75

Note : (1) Reverse recovery test conditions : IF = 0.5 A, IR = 1.0 A, Itr = 0.25 A.

High Voltage Rectifier Diodes.

The plastic material carries U/L recognition 94V-0.

Type No.		Max. Average Forward Rectified Current		Max. Repetitive Peak Reverse Voltage VRRM (V)	Max. Repetitive Peak Forward Current IFRM (A)	Max. Peak Forward Surge Current IFSM (A)	Max. Forward Voltage Drop at Ta=25 °C		Max. Reverse Current at Ta=25 °C IR (μA)
		IF(AV) @ Ta (A)	(°C)				V F @ I F (V)	(A)	

HVR125 Series. 0.5 Amp. Case: DO-41

Type No.	S.M.D.	IF(AV) (A)	Ta (°C)	VRRM (V)	IFRM (A)	IFSM (A)	V F (V)	I F (A)	IR (μA)
HVR125		0.5	50	2500	5.0	30	3.3	1.0	5.0
HVR130		0.5	50	3000	5.0	30	3.3	1.0	5.0
HVR140		0.5	50	4000	5.0	30	5.0	1.0	5.0
HVR150		0.5	50	5000	5.0	30	5.0	1.0	5.0
HVR160		0.5	50	6000	5.0	30	8.0	1.0	5.0
HVR170		0.5	50	7000	5.0	30	8.0	1.0	5.0
HVR180		0.5	50	8000	5.0	30	8.0	1.0	5.0

HVR112/SN1N Series. 1 Amp. Case: DO-41/SMA

Type No.	S.M.D.	IF(AV) (A)	Ta (°C)	VRRM (V)	IFRM (A)	IFSM (A)	V F (V)	I F (A)	IR (μA)
HVR112	SN1N	1.0	75	1200	5.0	30	2.2	1.0	5.0
HVR114	SN1O	1.0	75	1400	5.0	30	2.2	1.0	5.0
HVR116	SN1P	1.0	75	1600	5.0	30	2.2	1.0	5.0
HVR118	SN1Q	1.0	75	1800	5.0	30	2.2	1.0	5.0
HVR120	SN1R	1.0	75	2000	5.0	30	2.2	1.0	5.0

HVR312/SN3N Series. 3 Amps. Case: DO-201AD/SMC

Type No.	S.M.D.	IF(AV) (A)	Ta (°C)	VRRM (V)	IFRM (A)	IFSM (A)	V F (V)	I F (A)	IR (μA)
HVR312	SN3N	3.0	50	1200	10	100	2.2	3.0	10
HVR314	SN3O	3.0	50	1400	10	100	2.2	3.0	10
HVR316	SN3P	3.0	50	1600	10	100	2.2	3.0	10
HVR318	SN3Q	3.0	50	1800	10	100	2.2	3.0	10
HVR320	SN3R	3.0	50	2000	10	100	2.2	3.0	10

HVR512/SN5N Series. 5 Amps. Case: DO-201AD/SMC

Type No.	S.M.D.	IF(AV) (A)	Ta (°C)	VRRM (V)	IFRM (A)	IFSM (A)	V F (V)	I F (A)	IR (μA)
HVR512	SN5N	5.0	50	1200	20	200	2.2	5.0	10
HVR514	SN5O	5.0	50	1400	20	200	2.2	5.0	10
HVR516	SN5P	5.0	50	1600	20	200	2.2	5.0	10
HVR518	SN5Q	5.0	50	1800	20	200	2.2	5.0	10
HVR520	SN5R	5.0	50	2000	20	200	2.2	5.0	10

Note: VRRM > 2000 Volts is Available on Special Order.

High Voltage Fast Recovery Rectifier Diodes.

The plastic material carries U/L recognition 94V-0.

Type No.		Max. Average Forward Rectified Current		Max. Repetitive Peak Reverse Voltage VRRM (V)	Max. Repetitive Peak Forward Current IFRM (A)	Max. Peak Forward Surge Current IFSM (A)	Max. Forward Voltage Drop at Ta=25 °C		Max. Reverse Current at Ta=25 °C IR (μA)	Max. Reverse Recovery Time Trr (ns)
		IF(AV) @ Ta (A)	(°C)				V F @ I F (V)	(A)		

RGPO2 Series. 0.5 Amp. Case: DO-41

Type No.	IF(AV) (A)	Ta (°C)	VRRM (V)	IFRM (A)	IFSM (A)	V F (V)	I F (A)	IR (μA)	Trr (ns)
RGPO2-12E	0.5	55	1200	5.0	20	2.5	0.5	5.0	300
RGPO2-14E	0.5	55	1400	5.0	20	2.5	0.5	5.0	300
RGPO2-16E	0.5	55	1600	5.0	20	2.5	0.5	5.0	300
RGPO2-18E	0.5	55	1800	5.0	20	2.5	0.5	5.0	300
RGPO2-20E	0.5	55	2000	5.0	20	2.5	0.5	5.0	300

Note: (1) Reverse recovery test conditions: IF = 0.5A, IR = 1.0 A, Irr = 0.25 A.

Automotive Rectifier Diodes.

The plastic material carries U/L recognition 94V-0.

Type No.	Max. Average Forward Rectified Current		Max. Repetitive Peak Reverse Voltage	Max. Repetitive Peak Forward Current	Max. Peak Forward Surge Current	Max. Forward Voltage Drop at Ta=25 °C		Max. Reverse Current
	IF(AV) @ Ta		VRRM	IFRM	IFSM	VF @ IF		IR
	(A)	(°C)	(V)	(A)	(A)	(V)	(A)	(µA)

AR2500/MR2500 Series. 25 Amps. Case: BUTTON/MR



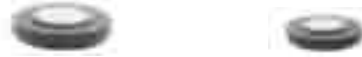
Type No.	MR	IF(AV) @ Ta	VRRM	IFRM	IFSM	VF @ IF	IR
AR2500	MR2500	25	150	50	75	400	1.0
AR2501	MR2501	25	150	100	75	400	1.0
AR2502	MR2502	25	150	200	75	400	1.0
AR2504	MR2504	25	150	400	75	400	1.0
AR2506	MR2506	25	150	600	75	400	1.0
AR2508	MR2508	25	150	800	75	400	1.0
AR2510	MR2510	25	150	1000	75	400	1.0
AR2512	MR2512	25	150	1200	75	400	1.0

AR3500/MR3500 Series. 35 Amps. Case: BUTTON/MR



Type No.	MR	IF(AV) @ Ta	VRRM	IFRM	IFSM	VF @ IF	IR
AR3500	MR3501	35	150	50	75	400	1.1
AR3501	MR3501	35	150	100	75	400	1.1
AR3502	MR3502	35	150	200	75	400	1.1
AR3504	MR3504	35	150	400	75	400	1.1
AR3506	MR3506	35	150	600	75	400	1.1
AR3508	MR3508	35	150	800	75	400	1.1
AR3510	MR3510	35	150	1000	75	400	1.1
AR3512	MR3512	35	150	1200	75	400	1.1

AR5000/MR5000 Series. 50 Amps. Case: BUTTON/MR



Type No.	MR	IF(AV) @ Ta	VRRM	IFRM	IFSM	VF @ IF	IR
AR5000	MR5000	50	150	50	75	500	1.1
AR5001	MR5001	50	150	100	75	500	1.1
AR5002	MR5002	50	150	200	75	500	1.1
AR5004	MR5004	50	150	400	75	500	1.1
AR5006	MR5006	50	150	600	75	500	1.1
AR5008	MR5008	50	150	800	75	500	1.1
AR5010	MR5010	50	150	1000	75	500	1.1
AR5012	MR5012	50	150	1200	75	500	1.1

* For wire leads use "L" suffix, Case : AR-L/MR-L



AR-L



MR-L

Single Phase Bridges		Standard packages	
Package	Voltage V_{RM} (V)	Current $I_{T(AV)}$ (A)	Part number
	50	1.0	50A01
	100	1.0	50A02
	200	1.0	50A03
	400	1.0	50A04
	600	1.0	50A05
	800	1.0	50A06
	1000	1.0	50A07
	1500	1.0	50A08
	2000	1.0	50A09
	3000	1.0	50A10
	50	1.0	50A11
	100	1.0	50A12
	200	1.0	50A13
	400	1.0	50A14
	600	1.0	50A15
	800	1.0	50A16
	1000	1.0	50A17
	1500	1.0	50A18
	2000	1.0	50A19
	3000	1.0	50A20
	50	1.0	50A21
	100	1.0	50A22
	200	1.0	50A23
	400	1.0	50A24
	600	1.0	50A25
	800	1.0	50A26
	1000	1.0	50A27
	1500	1.0	50A28
	2000	1.0	50A29
	3000	1.0	50A30
	50	1.0	50A31
	100	1.0	50A32
	200	1.0	50A33
	400	1.0	50A34
	600	1.0	50A35
	800	1.0	50A36
	1000	1.0	50A37
	1500	1.0	50A38
	2000	1.0	50A39
	3000	1.0	50A40

Three Phase Bridges

Three Phase Bridges		Standard packages	
Package	Voltage V_{RM} (V)	Current $I_{T(AV)}$ (A)	Part number
	50	1.0	50A41
	100	1.0	50A42
	200	1.0	50A43
	400	1.0	50A44
	600	1.0	50A45
	800	1.0	50A46
	1000	1.0	50A47
	1500	1.0	50A48
	2000	1.0	50A49
	3000	1.0	50A50
	50	1.0	50A51
	100	1.0	50A52
	200	1.0	50A53
	400	1.0	50A54
	600	1.0	50A55
	800	1.0	50A56
	1000	1.0	50A57
	1500	1.0	50A58
	2000	1.0	50A59
	3000	1.0	50A60
	50	1.0	50A61
	100	1.0	50A62
	200	1.0	50A63
	400	1.0	50A64
	600	1.0	50A65
	800	1.0	50A66
	1000	1.0	50A67
	1500	1.0	50A68
	2000	1.0	50A69
	3000	1.0	50A70

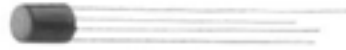
Silicon Bridge Rectifiers.

Glass passivated on request

The plastic material carries U/L recognition 94V-0.

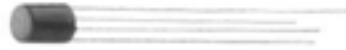
Type No.	Max. Average Forward Rectified Current		Input Voltage Recommended (V)	Max. Repetitive Peak Reverse Voltage (V)	Max. Peak Forward Surge Current (A)	Max. Forward Voltage Drop at Ta = 25 °C		Max. Reverse Current at Ta = 25 °C (μA)
	IF(AV) (A)	@ Tc (°C)				V F (V)	I F (A)	

B40-C1000 Series. 1 Amp. Case: WOB



B40-C1000	1.0	45	40	100	40	1.0	1.0	10
B80-C1000	1.0	45	80	200	40	1.0	1.0	10
B125-C1000	1.0	45	125	300	40	1.0	1.0	10
B250-C1000	1.0	45	250	600	40	1.0	1.0	10
B380-C1000	1.0	45	380	900	40	1.0	1.0	10

B40-C1500R Series. 1.5 Amps. Case: WOB



B40-C1500R	1.5	45	40	100	50	1.0	1.5	10
B80-C1500R	1.5	45	80	200	50	1.0	1.5	10
B125-C1500R	1.5	45	125	300	50	1.0	1.5	10
B250-C1500R	1.5	45	250	600	50	1.0	1.5	10
B380-C1500R	1.5	45	380	900	50	1.0	1.5	10

WL005 Series. 1 Amp. Case: WOB



WL005	1.0	50	20	50	30	1.2	1.0	10
WL01	1.0	50	40	100	30	1.2	1.0	10
WL02	1.0	50	80	200	30	1.2	1.0	10
WL04	1.0	50	125	400	30	1.2	1.0	10
WL06	1.0	50	250	600	30	1.2	1.0	10
WL08	1.0	50	380	800	30	1.2	1.0	10
WL10	1.0	50	440	1000	30	1.2	1.0	10

W005 Series. 1.5 Amps. Case: WOB



W005	1.5	25	20	50	50	1.0	1.0	10
W01	1.5	25	40	100	50	1.0	1.0	10
W02	1.5	25	80	200	50	1.0	1.0	10
W04	1.5	25	125	400	50	1.0	1.0	10
W06	1.5	25	250	600	50	1.0	1.0	10
W08	1.5	25	380	800	50	1.0	1.0	10
W10	1.5	25	440	1000	50	1.0	1.0	10

2W Series. 2 Amps. Case: WOB



2W005	2.0	25	20	50	50	1.0	1.0	10
2W01	2.0	25	40	100	50	1.0	1.0	10
2W02	2.0	25	80	200	50	1.0	1.0	10
2W04	2.0	25	125	400	50	1.0	1.0	10
2W06	2.0	25	250	600	50	1.0	1.0	10
2W08	2.0	25	380	800	50	1.0	1.0	10
2W10	2.0	25	440	1000	50	1.0	1.0	10

Silicon Bridge Rectifiers.

Glass passivated on request

The plastic material carries U/L recognition 94V-0.

Type No.	Max. Average Forward Rectified Current		Input Voltage Recommended	Max. Repetitive Peak Reverse Voltage	Max. Peak Forward Surge Current	Max. Forward Voltage Drop at Ta = 25 °C		Max. Reverse Current at Ta = 25 °C
	IF(AV) @ (A)	Tc (°C)				V F @ (V)	I F (A)	

RB150 Series. 1.5 Amps. Case: KBP



RB150	1,5	50	20	50	40	0,95	1,0	10
RB151	1,5	50	40	100	40	0,95	1,0	10
RB152	1,5	50	80	200	40	0,95	1,0	10
RB154	1,5	50	125	400	40	0,95	1,0	10
RB156	1,5	50	250	600	40	0,95	1,0	10
RB158	1,5	50	380	800	40	0,95	1,0	10

KBP200 Series. 2 Amps. Case: KBP



KBP200	2,0	50	20	50	60	1,0	1,0	10
KBP201	2,0	50	40	100	60	1,0	1,0	10
KBP202	2,0	50	80	200	60	1,0	1,0	10
KBP204	2,0	50	125	400	60	1,0	1,0	10
KBP206	2,0	50	250	600	60	1,0	1,0	10
KBP208	2,0	50	380	800	60	1,0	1,0	10
KBP210	2,0	50	440	1000	60	1,0	1,0	10

KBL400 Series. 4 Amps. Case: KBL



KBL400	4,0	50	20	50	200	1,1	4,0	10
KBL401	4,0	50	40	100	200	1,1	4,0	10
KBL402	4,0	50	80	200	200	1,1	4,0	10
KBL404	4,0	50	125	400	200	1,1	4,0	10
KBL406	4,0	50	250	600	200	1,1	4,0	10
KBL408	4,0	50	380	800	200	1,1	4,0	10
KBL410	4,0	50	440	1000	200	1,1	4,0	10

GBU4A Series. 4 Amps. Case: GBU



GBU4A	4,0	100	-	50	80	1,0	4,0	5,0
GBU4B	4,0	100	-	100	80	1,0	4,0	5,0
GBU4D	4,0	100	-	200	80	1,0	4,0	5,0
GBU4G	4,0	100	-	400	80	1,0	4,0	5,0
GBU4J	4,0	100	-	600	80	1,0	4,0	5,0
GBU4K	4,0	100	-	800	80	1,0	4,0	5,0
GBU4M	4,0	100	-	1000	80	1,0	4,0	5,0

GBU8A Series. 8 Amps. Case: GBU



GBU8A	8,0	100	-	50	200	1,0	8,0	5,0
GBU8B	8,0	100	-	100	200	1,0	8,0	5,0
GBU8D	8,0	100	-	200	200	1,0	8,0	5,0
GBU8G	8,0	100	-	400	200	1,0	8,0	5,0
GBU8J	8,0	100	-	600	200	1,0	8,0	5,0
GBU8K	8,0	100	-	800	200	1,0	8,0	5,0
GBU8M	8,0	100	-	1000	200	1,0	8,0	5,0

Single Phase Bridges



Silicon Bridge Rectifiers.

Glass passivated on request

The plastic material carries U/L recognition 94V-0.

Type No.		Max. Average Forward Rectified Current			Input Voltage Recommended (V)	Max. Repetitive Peak Reverse Voltage V _{RRM} (V)	Max. Peak Forward Surge Current I _{FSM} (A)	Max. Forward Voltage Drop at Ta = 25 °C		Max. Reverse Current at Ta = 25 °C I _R (μA)
D.I.P.	S.I.P.	I _{F(AV)} (A)	@ T _c (°C)	(°C)				V _F (V)	@ I _F (A)	

RBV400 Series. 4 Amps. Case: RBV4

	RBV401	4.0	50	-	100	80	1.05	2.0	10
	RBV402	4.0	50	-	200	80	1.05	2.0	10
	RBV404	4.0	50	-	400	80	1.10	2.0	10
	RBV406	4.0	50	-	600	80	1.10	2.0	10
	RBV408	4.0	50	-	800	80	1.10	2.0	10
	RBV410	4.0	50	-	1000	80	1.10	2.0	10

BR600/RBV600 Series. 6 Amps. Case: BR6/RBV25

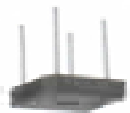
BR600	RBV600	6.0	50	20	50	200	1.0	3.0	10
BR601	RBV601	6.0	50	40	100	200	1.0	3.0	10
BR602	RBV602	6.0	50	80	200	200	1.0	3.0	10
BR604	RBV604	6.0	50	125	400	200	1.0	3.0	10
BR606	RBV606	6.0	50	250	600	200	1.0	3.0	10
BR608	RBV608	6.0	50	380	800	200	1.0	3.0	10
BR610	RBV610	6.0	50	440	1000	200	1.0	3.0	10

RBV600D Series. 6 Amps. Case: RBV25

	RBV600D	6.0	50	20	50	300	1.0	6.0	10
	RBV601D	6.0	50	40	100	300	1.0	6.0	10
	RBV602D	6.0	50	80	200	300	1.0	6.0	10
	RBV604D	6.0	50	125	400	300	1.0	6.0	10
	RBV606D	6.0	50	250	600	300	1.0	6.0	10
	RBV608D	6.0	50	380	800	300	1.0	6.0	10
	RBV610D	6.0	50	440	1000	300	1.0	6.0	10

BR800/RBV800 Series. 8 Amps. Case: BR10/RBV25

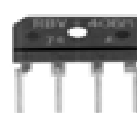
BR800	RBV800	8.0	50	20	50	300	1.0	4.0	10
BR801	RBV801	8.0	50	40	100	300	1.0	4.0	10
BR802	RBV802	8.0	50	80	200	300	1.0	4.0	10
BR804	RBV804	8.0	50	125	400	300	1.0	4.0	10
BR806	RBV806	8.0	50	250	600	300	1.0	4.0	10
BR808	RBV808	8.0	50	380	800	300	1.0	4.0	10
BR810	RBV810	8.0	50	440	1000	300	1.0	4.0	10



BR6



BR10



RBV4



RBV25

Silicon Bridge Rectifiers.

Glass passivated on request

The plastic material carries U/L recognition 94V-0.

Type No.		Max. Average Forward Rectified Current			Input Voltage Recommended (V)	Max. Recurrent Peak Reverse Voltage V _{RRM} (V)	Max. Peak Forward Surge Current I _{FSM} (A)	Max. Forward Voltage Drop at Ta = 25 °C		Max. Reverse Current at Ta = 25 °C I _R (μA)
D.I.P.	S.I.P.	I _{F(AV)} (A)	@ T _c (°C)	(°C)				V _F (V)	@ I _F (A)	

RBV800D Series. 8 Amps. Case: RBV25

	RBV800D	8.0	50	20	50	300	1.0	8.0	10
	RBV801D	8.0	50	40	100	300	1.0	8.0	10
	RBV802D	8.0	50	80	200	300	1.0	8.0	10
	RBV804D	8.0	50	125	400	300	1.0	8.0	10
	RBV806D	8.0	50	250	600	300	1.0	8.0	10
	RBV808D	8.0	50	380	800	300	1.0	8.0	10
	RBV810D	8.0	50	440	1000	300	1.0	8.0	10

BR1000/RBV1000 Series. 10 Amps. Case: BR10/RBV25

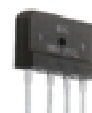
BR1000	RBV1000	10	55	20	50	300	1.0	5.0	10
BR1001	RBV1001	10	55	40	100	300	1.0	5.0	10
BR1002	RBV1002	10	55	80	200	300	1.0	5.0	10
BR1004	RBV1004	10	55	125	400	300	1.0	5.0	10
BR1006	RBV1006	10	55	250	600	300	1.0	5.0	10
BR1008	RBV1008	10	55	380	800	300	1.0	5.0	10
BR1010	RBV1010	10	55	440	1000	300	1.0	5.0	10

RBV1000D Series. 10 Amps. Case: RBV25

	RBV1000D	10	55	20	50	300	1.0	10	10
	RBV1001D	10	55	40	100	300	1.0	10	10
	RBV1002D	10	55	80	200	300	1.0	10	10
	RBV1004D	10	55	125	400	300	1.0	10	10
	RBV1006D	10	55	250	600	300	1.0	10	10
	RBV1008D	10	55	380	800	300	1.0	10	10
	RBV1010D	10	55	440	1000	300	1.0	10	10



BR10



RBV25

Silicon Bridge Rectifiers. Glass passivated on request

The plastic material carries U/L recognition 94V-0.

Type No.		Max. Average Forward Rectified Current		Input Voltage Recommended	Max. Recurrent Peak Reverse Voltage	Max. Peak Forward Surge Current	Max. Forward Voltage Drop at Ta = 25 °C		Max. Reverse Current at Ta = 25 °C
D.I.P.	S.I.P.	IF(AV) @ Tc (A)	(°C)	(V)	VRRM (V)	IFSM (A)	V _F @ I _F (V)	(A)	IR (μA)

BR1500/RBV1500 Series. 15 Amps. Case: BR50/RBV25

BR1500	RBV1500	15	55	20	50	300	1,1	7,5	10
BR1501	RBV1501	15	55	40	100	300	1,1	7,5	10
BR1502	RBV1502	15	55	80	200	300	1,1	7,5	10
BR1504	RBV1504	15	55	125	400	300	1,1	7,5	10
BR1506	RBV1506	15	55	250	600	300	1,1	7,5	10
BR1508	RBV1508	15	55	380	800	300	1,1	7,5	10
BR1510	RBV1510	15	55	440	1000	300	1,1	7,5	10

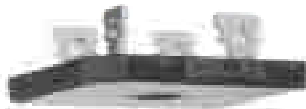
RBV1500D Series. 15 Amps. Case: RBV25

	RBV1500D	15	55	20	50	300	1,0	15	10
	RBV1501D	15	55	40	100	300	1,0	15	10
	RBV1502D	15	55	80	200	300	1,0	15	10
	RBV1504D	15	55	125	400	300	1,0	15	10
	RBV1506D	15	55	250	600	300	1,0	15	10
	RBV1508D	15	55	380	800	300	1,0	15	10
	RBV1510D	15	55	440	1000	300	1,0	15	10

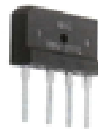
BR2500/RBV2500 Series. 25 Amps. Case: BR50/RBV25

BR2500	RBV2500	25	55	20	50	300	1,1	12,5	10
BR2501	RBV2501	25	55	40	100	300	1,1	12,5	10
BR2502	RBV2502	25	55	80	200	300	1,1	12,5	10
BR2504	RBV2504	25	55	125	400	300	1,1	12,5	10
BR2506	RBV2506	25	55	250	600	300	1,1	12,5	10
BR2508	RBV2508	25	55	380	800	300	1,1	12,5	10
BR2510	RBV2510	25	55	440	1000	300	1,1	12,5	10

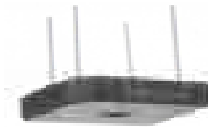
* For wire leads use "W" suffix. Case : BR50W.



BR50



RBV25



BR50W

Silicon Bridge Rectifiers. Glass passivated on request

The plastic material carries U/L recognition 94V-0.

Type No.		Max. Average Forward Rectified Current		Input Voltage Recommended	Max. Recurrent Peak Reverse Voltage	Max. Peak Forward Surge Current	Max. Forward Voltage Drop at Ta = 25 °C		Max. Reverse Current at Ta = 25 °C
D.I.P.	S.I.P.	IF(AV) @ Tc (A)	(°C)	(V)	VRRM (V)	IFSM (A)	V _F @ I _F (V)	(A)	IR (μA)

RBV2500 Series. 25 Amps. Case: RBV25

	RBV2500D	25	55	20	50	400	1,1	25	10
	RBV2501D	25	55	40	100	400	1,1	25	10
	RBV2502D	25	55	80	200	400	1,1	25	10
	RBV2504D	25	55	125	400	400	1,1	25	10
	RBV2506D	25	55	250	600	400	1,1	25	10
	RBV2508D	25	55	380	800	400	1,1	25	10
	RBV2510D	25	55	440	1000	400	1,1	25	10

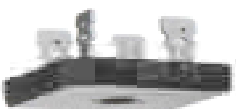
BR3500/RBV3500 Series. 35 Amps. Case: BR50/RBV25

BR3500	RBV3500	35	55	20	50	400	1,1	17,5	10
BR3501	RBV3501	35	55	40	100	400	1,1	17,5	10
BR3502	RBV3502	35	55	80	200	400	1,1	17,5	10
BR3504	RBV3504	35	55	125	400	400	1,1	17,5	10
BR3506	RBV3506	35	55	250	600	400	1,1	17,5	10
BR3508	RBV3508	35	55	380	800	400	1,1	17,5	10
BR3510	RBV3510	35	55	440	1000	400	1,1	17,5	10

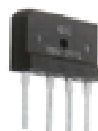
BR5000/RBV5000 Series. 50 Amps. Case: BR50/RBV25

BR5000	RBV5000	50	55	20	50	400	1,1	25	10
BR5001	RBV5001	50	55	40	100	400	1,1	25	10
BR5002	RBV5002	50	55	80	200	400	1,1	25	10
BR5004	RBV5004	50	55	125	400	400	1,1	25	10
BR5006	RBV5006	50	55	250	600	400	1,1	25	10
BR5008	RBV5008	50	55	380	800	400	1,1	25	10
BR5010	RBV5010	50	55	440	1000	400	1,1	25	10

* For wire leads use "W" suffix. Case : BR50W.



BR50



BR50W

Mini Bridge Rectifiers.

The plastic material carries U/L recognition 94V-0.

Type No.	Max. Average Forward Rectified Current		Input Voltage Recommended	Max. Repetitive Peak Reverse Voltage	Max. Peak Forward Surge Current	Max. Forward Voltage Drop at Ta = 25 °C		Max. Reverse Current at Ta = 25 °C
	IF(AV) @ (A)	Tc (C)				V F @ I F (V)	I F (A)	

MB1S Series. 0.5 Amp. Case: MBS



MB1S	0,5	30	-	100	35	1,0	0,4	5,0
MB2S	0,5	30	-	200	35	1,0	0,4	5,0
MB4S	0,5	30	-	400	35	1,0	0,4	5,0
MB6S	0,5	30	-	600	35	1,0	0,4	5,0

MB1M Series. 0.5 Amp. Case: MBM



MB1M	0,5	30	-	100	35	1,0	0,4	5,0
MB2M	0,5	30	-	200	35	1,0	0,4	5,0
MB4M	0,5	30	-	400	35	1,0	0,4	5,0
MB6M	0,5	30	-	600	35	1,0	0,4	5,0

DF005M Series. 1 Amp. Case: DFM



DF005M	1,0	40	-	50	30	1,1	1,0	5,0
DF01M	1,0	40	-	100	30	1,1	1,0	5,0
DF02M	1,0	40	-	200	30	1,1	1,0	5,0
DF04M	1,0	40	-	400	30	1,1	1,0	5,0
DF06M	1,0	40	-	600	30	1,1	1,0	5,0
DF08M	1,0	40	-	800	30	1,1	1,0	5,0
DF10M	1,0	40	-	1000	30	1,1	1,0	5,0

DF005S Series. 1 Amp. Case: DFS



DF005S	1,0	40	-	50	50	1,1	1,0	5,0
DF01S	1,0	40	-	100	50	1,1	1,0	5,0
DF02S	1,0	40	-	200	50	1,1	1,0	5,0
DF04S	1,0	40	-	400	50	1,1	1,0	5,0
DF06S	1,0	40	-	600	50	1,1	1,0	5,0
DF08S	1,0	40	-	800	50	1,1	1,0	5,0
DF10S	1,0	40	-	1000	50	1,1	1,0	5,0

DF15005S Series. 1.5 Amp. Case: DFS



DF15005S	1,5	40	-	50	50	1,1	1,5	5,0
DF1501S	1,5	40	-	100	50	1,1	1,5	5,0
DF1502S	1,5	40	-	200	50	1,1	1,5	5,0
DF1504S	1,5	40	-	400	50	1,1	1,5	5,0
DF1506S	1,5	40	-	600	50	1,1	1,5	5,0
DF1508S	1,5	40	-	800	50	1,1	1,5	5,0
DF1510S	1,5	40	-	1000	50	1,1	1,5	5,0

Ultra Fast Recovery Mini Bridge Rectifiers.

The plastic material carries U/L recognition 94V-0.

Type No.	Max. Average Forward Rectified Current		Input Voltage Recommended	Max. Repetitive Peak Reverse Voltage	Max. Peak Forward Surge Current	Max. Forward Voltage Drop at Ta = 25 °C		Max. Reverse Current at Ta = 25 °C	Max. Reverse Recovery Time
	IF(AV) @ (A)	Tc (C)				V F @ I F (V)	I F (A)		

EDF1AS Series. 1 Amp. Case: DFS



EDF1AS	1,0	40	-	50	50	1,05	1,0	5,0	50
EDF1BS	1,0	40	-	100	50	1,05	1,0	5,0	50
EDF1CS	1,0	40	-	150	50	1,05	1,0	5,0	50
EDF1DS	1,0	40	-	200	50	1,05	1,0	5,0	50

EDF1AM Series. 1 Amp. Case: DFM



EDF1AM	1,0	40	-	50	50	1,05	1,0	5,0	50
EDF1BM	1,0	40	-	100	50	1,05	1,0	5,0	50
EDF1CM	1,0	40	-	150	50	1,05	1,0	5,0	50
EDF1DM	1,0	40	-	200	50	1,05	1,0	5,0	50

Fast Recovery Mini Bridge Rectifiers.

RMB2S Series. 0.5 Amp. Case: MBS



RMB2S	0,5	30	-	200	30	1,0	0,4	5,0	150
RMB4S	0,5	30	-	400	30	1,0	0,4	5,0	150

Transient Voltage Suppressors

Type No.	Breakdown Voltage @ I_T (1)		Working Peak Reverse Voltage	Maximum Reverse Leakage @ V_{WM}	Maximum Peak Pulse Surge Current	Maximum Clamping Voltage @ I_{PPM}
	V_{BR} (V)					
	Min.	Max.	(mA)	(V)	(μ A)	(A)

SMCJ Series. 1500W. Case: SMC



Type No.	Breakdown Voltage @ I_T (Note 1)		Working Peak Reverse Voltage	Maximum Reverse Leakage @ V_{RWM}	Maximum Reverse Current	Maximum Clamping Voltage @ I_{RSM}	Maximum Temperature Co-efficient of V_{BR}
	V_{BR} (V)						
	Min.	Max.	(mA)	(V)	(μ A)	(A)	(V)

3KE Series. 3kW. Case: DO-201



5KP Series. 5000W. Case: D6



Type No. (Uni-directional)	Type No. (Bi-directional)	Reverse Stand Off Voltage	Breakdown Voltage @ I_T		Maximum Reverse Leakage @ V_R	Maximum Clamping Voltage @ I_{PP}	Maximum Peak Pulse Current	Max. Voltage Temperature Variation of V_{BR}
		V_S (V)	V_{BR} (V)	I_T	I_R	V_C	I_{PP}	
				Min.	(mA)	(μ A)	(V)	(A)

15KP Series. 15 kW. Case: D6



Low Capacitance Transient Voltage Suppressor Diodes.

The plastic material carries UL recognition 94V-0.

Type No.	Breakdown Voltage @ I_T		Reverse Stand-off Voltage	Max. Reverse Leakage @ V_{RWM}	Max. Clamping Voltage @ I_{RSM}	Max. Reverse Current	Max. Junction Capacitance @ 0 Volt	Working Inverse Blocking Voltage	Max. Inverse Blocking Current @ V_{WIB}	Peak Inverse Blocking Voltage
	V_{BR} (V)									
	Min.	Max.	(mA)	(V)	(μ A)	(V)	(A)	pF	(V)	(mA)

LCE Series. 1500 W. Case: DO-201

Ultra Low Capacitance Transient Voltage Suppressor Diodes.

The plastic material carries UL recognition 94V-0.

Type No.	Breakdown Voltage @ I_T		Reverse Stand-off Voltage	Max. Reverse Leakage @ V_{RWM}	Max. Clamping Voltage @ I_{RSM}	Max. Reverse Current	Max. Junction Capacitance @ 0 Volt	Working Inverse Blocking Voltage	Max. Inverse Blocking Current @ V_{WIB}	Peak Inverse Blocking Voltage
	V_{BR} (V)									
	Min.	Max.	(mA)	(V)	(μ A)	(V)	(A)	pF	(V)	(mA)

ULCE Series. 1500 W. Case: DO-201



For details please see EIC catalogue or www.eic.com

Transient Voltage Suppressor Diodes.

The plastic material carries U/L recognition 94V-0.

Type No.	Breakdown Voltage @ I_t (Note 1)		Working Peak Reverse Voltage	Maximum Reverse Leakage @ V_{RWM}	Maximum Reverse Current	Maximum Clamping Voltage @ I_{RSM}	Maximum Temperature Co-efficient of V_{BR}
Unidirectional	VBR (V)		I_t	V_{RWM}	IR	V_{RSM}	(% / °C)
Axial Lead	S.M.D.	Min. Max.	(mA)	(V)	(μ A)	(A)	

BZW04 / STUB Series. 400W. Case: DO-41/SMA



P4KE / STUP Series. 400W. Case: DO-41/SMA



Type No.	Breakdown Voltage @ I_t ⁽¹⁾		Working Peak Reverse Voltage	Maximum Reverse Leakage @ V_{RWM}	Maximum Peak Pulse Surge Current	Maximum Clamping Voltage @ I_{PPM}
	VBR (V)		I_t	IR ⁽²⁾	IPPM	VC
	Min.	Max.	(mA)	(V)	(A)	(V)

SMAJ Series. 400W. Case: SMA

Type No.	Breakdown Voltage @ I_t (Note 1)		Working Peak Reverse Voltage	Maximum Reverse Leakage @ V_{RWM}	Maximum Reverse Current	Maximum Clamping Voltage @ I_{RSM}	Maximum Voltage Variation of V_{BR}
Unidirectional	VBR (V)		I_t	IR	IRSM	V_{RSM}	(mV / °C)
Axial Lead	S.M.D.	Min. Max.	(mA)	(V)	(μ A)	(A)	

SA / STUS Series. 500W. Case: DO-41/SMA



Type No.	Breakdown Voltage @ I_t (Note 1)		Working Peak Reverse Voltage	Maximum Reverse Leakage @ V_{RWM}	Maximum Reverse Current	Maximum Clamping Voltage @ I_{RSM}	Maximum Temperature Co-efficient of V_{BR}
Unidirectional	VBR (V)		I_t	IR	IRSM	V_{RSM}	(% / °C)
Axial Lead	S.M.D.	Min. Max.	(mA)	(V)	(μ A)	(A)	

P6KE Series. 600W. Case: D2/SMB



Type No.	Breakdown Voltage @ I_T ⁽¹⁾		Reverse Stand-off Voltage	Maximum Reverse Leakage @ V_{WM}	Maximum Peak Pulse Surge Current	Maximum Clamping Voltage @ I_{PPM}
	VBR (V)		I_T	IR ⁽²⁾	IPPM ⁽²⁾	VC
	Min.	Max.	(mA)	(V)	(A)	(V)

SMBJ Series. 600W. Case: SMB



Type No.	Breakdown Voltage @ I_t (Note 1)		Working Peak Reverse Voltage	Maximum Reverse Leakage @ V_{RWM}	Maximum Reverse Current	Maximum Clamping Voltage @ I_{RSM}	Maximum Temperature Co-efficient of V_{BR}
Unidirectional	VBR (V)		I_t	IR	IRSM	V_{RSM}	(% / °C)
Axial Lead	S.M.D.	Min. Max.	(mA)	(V)	(μ A)	(A)	

1N6267/STUN Series. 1500W. Case: DO-201/SMC



1.5KE/STUK Series. 1500W. Case: DO-201/SMC



For details please see EIC catalogue or www.eic.com

Automotive Transient Suppressor Diodes.

The plastic material carries UL recognition 94V-0.

Type No.	Breakdown Voltage @ I _R (Note 1) at T _c = 25 °C		Working Peak Reverse Voltage	Maximum Average Forward Rectified Current		Maximum Reverse Current	Maximum Reverse Leakage @ V _{RWM}	Typical Temperature Co-efficient of V _{BR} (% / °C)
	V _{BR} (V)			I _{F(AV)} @ T _c	I _{FSM}			
	Min.	Max.	I _R (mA)			V _{RWM} (V)	I _{F(AV)} @ T _c (A)	

MR2535 Series. Case: MR



MR2535	24	32	100	20	35	150	110	200	0.096
MR2540	24	32	100	20	50	150	150	200	0.096

MR2535L Series. Case: MR-L



MR2535L	24	32	100	20	35	150	110	200	0.096
MR2540L	24	32	100	20	50	150	150	200	0.096
PZ628	22	32	1.0	20	5.0	150	65	0.5mA	0.020

Zener Diodes. 0.2 Watt.

Type No.	Zener Voltage $V_z @ I_{zT}$			Max. Dynamic Resistance at I_{zT}	Max. Reverse Leakage Current		Temp. coefficient of Zener Voltage at I_{zT} $\alpha_{zT} (10^{-4} \text{ } ^\circ\text{C})$ (% / K)
	Min. (V)	Max. (V)	I_{zT} (mA)	r_z (Ω)	I_R (μA)	(V)	

BZX384 Series. 0.2 Watt. Case : SOD-323



Zener Diodes. 0.4 Watt.

Type No.	Grade	Zener Voltage $V_z @ I_{zT}$									Test Current I_{zT} (mA)	Maximum Dynamic Resistance $r_d @ I_z$ (Ω)	Maximum Reverse Current $I_R @ V_R$ (μA)
		Suffix-1		Suffix-2		Suffix-3		Suffix D					
		min. (V)	max. (V)	min. (V)	max. (V)	min. (V)	max. (V)	Min. (V)	Nom. (V)	Max. (V)			

HZ6L Series. 0.4 Watt. Case : DO-35



Zener Diodes. 0.5 Watt.

Type No.	Nominal Zener Voltage ⁽¹⁾ $V_z @ I_{zT}$	Test Current I_{zT}	Maximum Zener Impedance ⁽¹⁾		Maximum Reverse Leakage Current $I_R @ V_R$ (μA)	Typical Temperature Coefficient $\alpha_{zT} (\% / ^\circ\text{C})$	Maximum Regulator Current ⁽²⁾ I_{ZM} (mA)
			$Z_{zT} @ I_{zT}$ (Ω)	$Z_{zK} @ I_{zK} = 0.25\text{mA}$ (Ω)			

1N5225/ZMM5225 Series. Case: DO-35 / MiniMELF



Type No.	Nominal Zener Voltage ⁽¹⁾ $V_z @ I_{zT}$	Test Current I_{zT}	Maximum Zener Impedance $Z_{zT} @ I_{zT}$ (Ω)	Maximum Reverse Leakage Current $I_R @ V_R = 1\text{V}$		Maximum DC Zener Current ⁽²⁾ I_{ZM} (mA)
				$T_a = 25^\circ\text{C}$	$T_a = 150^\circ\text{C}$	
				(μA)	(μA)	

1N746A Series. 0.5 Watt. Case : DO-35



Type No.	Zener Voltage $V_z @ I_{zT}$		Maximum Zener Impedance ⁽¹⁾			Maximum Reverse Leakage Current		Maximum DC Zener Current I_{ZM} (mA)
	Nominal (V)	I_{zT} (mA)	$Z_{zT} @ I_{zT}$ (Ω)	$Z_{zK} @ I_{zK}$ (Ω)	I_{zK} (mA)	I_R (μA)	at V_R (V)	

1N957B Series. 0.5 Watt. Case : DO-35



Type No.	Zener Voltage $V_z @ I_{zT}$			Maximum Zener Impedance			Maximum Reverse Leakage Current, I_R			Temp. coefficient of Zener Voltage at $I_z = 5\text{mA}$ $\alpha_{zT} (\% / ^\circ\text{C})$	Admissible Zener Current ⁽²⁾ I_{ZM} (mA)	
	Nom ⁽¹⁾ (V)	Min ⁽¹⁾ (V)	Max ⁽¹⁾ (V)	I_{zT} (mA)	$Z_{zT} @ I_{zT}$ (Ω)	$Z_{zK} @ I_{zK}$ (Ω)	I_{zK} (mA)	$T_a = 25^\circ\text{C}$ (μA)	$T_a = 150^\circ\text{C}$ (μA)			at V_R (V)

BZX55 Series. 0.5 Watt. Case : DO-35



Type No.	Zener Voltage $V_z @ I_{zT}$		Maximum Zener Impedance, $f = 1\text{kHz}$			Maximum Reverse Leakage Current		Temp. coefficient of Zener Voltage at I_{zT} $\alpha_{zT} (\% / ^\circ\text{C})$
	Nom ⁽¹⁾ (V)	I_{zT} (mA)	$Z_{zT} @ I_{zT}$ (Ω)	$Z_{zK} @ I_{zK}$ (Ω)	I_{zK} (mA)	I_R (μA)	at V_R (V)	

BZV55 Series. 0.5 Watt. Case : MiniMELF



Type No.	Zener Voltage $V_z @ I_{zT}$		Maximum Zener Impedance, $f = 1\text{kHz}$			Maximum Reverse Leakage Current		Temp. coefficient of Zener Voltage at I_{zT} $\alpha_{zT} (\% / ^\circ\text{C})$	Admissible Zener Current I_z (mA)	Maximum Capacitance $V_R = 0, f = 1\text{MHz}$ (pF)
	Nom ⁽¹⁾ (V)	I_{zT} (mA)	$Z_{zT} @ I_{zT}$ (Ω)	$Z_{zK} @ I_{zK}$ (Ω)	I_{zK} (mA)	I_R (μA)	at V_R (V)			

BZX79 Series. 0.5 Watt. Case : DO-35



Diodes / Rectifiers

Zener Diodes. 0.5 Watt.

Type No.	Rank	Zener Voltage		Test Current I_{ZT}	Maximum Zener Impedance, $f = 1\text{kHz}$			Maximum Reverse Current	
		V_Z (V) at I_{ZT}			$Z_{ZT} @ I_{ZT}$	$Z_{ZK} @ I_{ZK}$	I_{ZK}	I_R	at V_R
		min.	max.	(Ω)	(Ω)	(mA)	(μA)	(V)	

GLZ Series. 0.5 Watt. Case : MiniMELF

Type No.	Grade	Zener Voltage $V_Z @ I_{ZT}$										Test Current I_{ZT}	Maximum Dynamic Resistance $r_d @ I_Z$	Maximum Reverse Current $I_R @ V_R$
		Suffix-1		Suffix-2		Suffix-3		Suffix-4						
		min. (V)	max. (V)	min. (V)	max. (V)	min. (V)	max. (V)	Min. (V)	Nom. (V)	Max. (V)	Min. (V)	Nom. (V)	Max. (V)	(Ω)

HZ Series. 0.5 Watt. Case : DO-35

Type No.	Axial Lead	S.M.D.	Zener Voltage $V_Z @ I_{ZT}$											Test Current I_{ZT}	Maximum Zener Impedance			Maximum Reverse Current	
			Suffix A			Suffix B			Suffix C			Suffix D			$Z_{ZT} @ I_{ZT}$	$Z_{ZK} @ I_{ZK}$	I_{ZK}	$I_R @ V_R$	
			Min. (V)	Nom. (V)	Max. (V)	Min. (V)	Nom. (V)	Max. (V)	Min. (V)	Nom. (V)	Max. (V)	Min. (V)	Nom. (V)	Max. (V)	(mA)	(Ω)	(Ω)	(mA)	(μA)

MTJ / MNZ Series. Case : DO-34 / MiniMELF

Type No.	Zener Voltage $V_Z @ I_{ZT}$				Test Current I_{ZT}	Maximum Zener Impedance			Maximum Reverse Current at V_R	
	Min. (V)	Max. (V)	Nom. (V)	Max. (V)		$Z_{ZT} @ I_{ZT}$	$Z_{ZK} @ I_{ZK}$	I_{ZK}	I_R	V_R

RLZ Series. Case : MiniMELF

Type No.	Zener Voltage $V_Z @ I_{ZT}$		Dynamic Resistance at $I_Z = 5\text{mA}$ $f = 1\text{kHz}$ $r_{Zj} (\Omega)$		Dynamic Resistance at $I_Z = 1\text{mA}$ $f = 1\text{kHz}$ $r_{Zj} (\Omega)$		Maximum Reverse Leakage Current I_R at V_R		Temp. coefficient of Zener Voltage at I_{ZT} $\alpha_{VZ} (10^{-4} / ^\circ\text{C})$		Admissible Zener Current I_Z (mA)
	Nom ⁽¹⁾ (V)	I_{ZT} (mA)	(μA)	(V)	min.	max.					

ZMM Series. 0.5 Watt. Case : MiniMELF

Type No.	Zener Voltage $V_Z @ I_{ZT}$		Dynamic Resistance at $I_Z = 5\text{mA}$ $f = 1\text{kHz}$ $r_{Zj} (\Omega)$		Dynamic Resistance at $I_Z = 1\text{mA}$ $f = 1\text{kHz}$ $r_{Zj} (\Omega)$		Reverse Voltage at $I_R = 100\text{nA}$ V_R (V)	Temp. coefficient of Zener Voltage at I_{ZT} $\alpha_{VZ} (10^{-4} / ^\circ\text{C})$		Admissible Zener Current I_Z (mA)
	Nom ⁽¹⁾ (V)	I_{ZT} (mA)	min.	max.						

ZPD Series. 0.5 Watt. Case : DO-35

Zener Diodes. 1.0 Watt.

Type No.	Nominal Zener Voltage ⁽²⁾		Maximum Zener Impedance ⁽¹⁾			Maximum Reverse Leakage Current		Maximum Regulator Current	Maximum Surge Current
	$V_Z @ I_{ZT}$	I_{ZT}	$Z_{ZT} @ I_{ZT}$	$Z_{ZK} @ I_{ZK}$	I_{ZK}	$I_R @ V_R$			

1N4728AG/ZM4728A Series. Case : DO-41 / MELF

Type No.	Zener Voltage ⁽¹⁾ at I_{ZT} V_Z (V)		Dynamic Resistance at I_{ZT} , $f = 1\text{kHz}$ $r_{Zj} (\Omega)$	Temp. Coeff. Of Zener Voltage at I_{ZT} $\alpha_{VZ} (10^{-4} / ^\circ\text{C})$		Test Current I_{ZT} (mA)	Reverse Voltage at $I_R = 0.5\ \mu\text{A}$ V_R (V)	Asmissible Zener Current ⁽²⁾ I_Z (mA)
	min.	max.		min.	max.			

ZMY Series. 1 Watt. Case : MELF

Type No.	Zener Voltage ⁽¹⁾ $V_Z @ I_{ZT}$		Test Current I_{ZT}	Dynamic Resistance at I_{ZT} $f = 1\text{kHz}$ $r_{Zj} (\Omega)$	Reverse Voltage at $I_R = 0.5\ \mu\text{A}$ V_R (V)	Admissible Zener current ⁽²⁾ I_Z		Temp. Coeff. Of Zener Voltage at I_{ZT} $\alpha_{VZ} (10^{-4} / ^\circ\text{C})$	
	Min (V)	Max (V)				(mA)	Min.	Max.	

ZMU Series. 1 Watt. Case : MELF

Type No.	Nominal Zener Voltage		Maximum Zener Impedance			Maximum Reverse Leakage Current		Maximum DC. Zener Current I_{ZM}
	$V_Z @ I_{ZT}$	I_{ZT}	$Z_{ZT} @ I_{ZT}$	$Z_{ZK} @ I_{ZK}$	I_{ZK}	$I_R @ V_R$		

1N4728/SZ10 Series. 1 Watt. Case : DO-41/SMA

Zener Diodes. 1.3 Watts.

The plastic material carries U/L recognition 94V-0.

Type No.	Nominal Zener Voltage		Maximum Zener Impedance			Maximum Reverse Leakage Current		Maximum DC. Zener Current	
	VZ@IZT	IZT	ZZT@IZT	ZZK@IZK	IZK	IR @ VR	VR	IZM	
Axial Lead	S.M.D.	(V)	(mA)	(Ω)	(Ω)	(mA)	(μA)	(V)	(mA)

BZX85/SZ25 Series. 1.3 Watts. Case : DO-41/SMA

Zener Diodes. 1.5 Watts.

The plastic material carries U/L recognition 94V-0.

Type No.	Nominal Zener Voltage		Maximum Zener Impedance			Maximum Reverse Leakage Current		Maximum DC. Zener Current	
	VZ@IZT	IZT	ZZT@IZT	ZZK@IZK	IZK	IR @ VR	VR	IZM	
Axial Lead	S.M.D.	(V)	(mA)	(Ω)	(Ω)	(mA)	(μA)	(V)	(mA)

1N5913A/SZ30 Series. 1.5 Watts. Case : DO-41/SMA

Zener Diodes. 2 Watts.

The plastic material carries U/L recognition 94V-0.

Type No.	Nominal Zener Voltage		Maximum Zener Impedance			Maximum Reverse Leakage Current		Maximum DC. Zener Current	
	VZ@IZT	IZT	ZZT@IZT	ZZK@IZK	IZK	IR @ VR	VR	IZM	
Axial Lead	S.M.D.	(V)	(mA)	(Ω)	(Ω)	(mA)	(μA)	(V)	(mA)

2EZ / SZ45 Series. 2.0 Watts. Case : DO-41/SMA

Zener Diodes. 3 Watts.

The plastic material carries U/L recognition 94V-0.

Type No.	Nominal Zener Voltage		Maximum Zener Impedance			Maximum Reverse Leakage Current		Maximum DC. Zener Current	
	VZ@IZT	IZT	ZZT@IZT	ZZK@IZK	IZK	IR @ VR	VR	IZM	
Axial Lead	S.M.D.	(V)	(mA)	(Ω)	(Ω)	(mA)	(μA)	(V)	(mA)

3EZ / SZ55 Series. 3.0 Watts. Case : DO-41/SMA

Zener Diodes. 5 Watts.

The plastic material carries U/L recognition 94V-0.

Type No.	Nominal Zener Voltage		Maximum Zener Impedance			Maximum Reverse Leakage Current		Maximum DC. Zener Current	
	VZ@IZT	IZT	ZZT@IZT	ZZK@IZK	IZK	IR @ VR	VR	IZM	
Axial Lead	S.M.D.	(V)	(mA)	(Ω)	(Ω)	(mA)	(μA)	(V)	(mA)

1N5333A/SZ60 Series. 5 Watts. Case : D2A/SMB

Braking Rectifier Assemblies

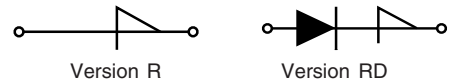
Type	Typical				Max.			Fig. No.	Outline drawings on pages O-5...O-17
	V_{VRMS} V	V_{dAV} V	I_{dAVM} A	I_{dAVM} A	V_{RRM} V	I_{FSM} A	I_t^2 A ² s		
VGB 0124 AY7A	380	340	1.0	1.0	1400	60	28	64	
VGF 0136 AB	1000	440	1.2	1.5	2800	80	40	66	
VGF 0136 AH	1000	440	0.6	1.1	1400	60	28	67	

VGF 0136 AH

VGF 0136 AB

VGB 0124 AY7

Breakover Diodes



Type	V_{Bo} V	I_{Bo} $T_{VJ} = 25\text{ °C}$ mA	I_D 125 °C μA	I_H $T_J = 25\text{ °C}$ mA	V_H $T_{VJ} = 25\text{ °C}$ V	I_{AVM} □ 50 °C A	I_{SM} 50 °C A	dv/dt V/ μs	R_{thJA} °C/W	Fig. No.	Package style	
												□ New
IXBOD 1-06	600 ±50	≤15	20	30	4-8	0.9	200	>1000	60	14	Fig. 14 Weight = 0.8 g 	
IXBOD 1-07	700		0.8 x V_{Bo}									
IXBOD 1-08	800											
IXBOD 1-09	900											
IXBOD 1-10	1000											
IXBOD 1-12 R(D)	1200 ±50	≤15	100	30	4-8	1.25	200	>1000	20	Fig. 68 Weight = 14 g 		
IXBOD 1-13 R(D)	1300		0.8 x V_{Bo}									
IXBOD 1-14 R(D)	1400											
IXBOD 1-15 R(D)	1500											
IXBOD 1-16 R(D)	1600 ±50	≤15	100	30	4-8	1.25	200	>1500	20			
IXBOD 1-17 R(D)	1700											
IXBOD 1-18 R(D)	1800											
IXBOD 1-19 R(D)	1900											
IXBOD 1-20 R(D)	2000 ±50	≤15	100	30	4-8	0.9	200	>1500	20			
IXBOD 1-21 R(D)	2100 ±50	≤15	100	30	4-8	0.9	200	>2000	20			
IXBOD 1-22 R(D)	2200											
IXBOD 1-23 R(D)	2300											
IXBOD 1-24 R(D)	2400											
IXBOD 1-25 R(D)	2500											
IXBOD 1-26 R(D)	2600 ±100	≤15	100	30	4-8	0.7	200	>2500	20			
IXBOD 1-28 R(D)	2800											
IXBOD 1-30 R(D)	3000											
IXBOD 1-32 R(D)	3200 ±100	≤15	100	30	4-8	0.7	200	>3000	20			
IXBOD 1-34 R	3400											
IXBOD 1-36 R	3600 ±100	≤15	100	30	4-8	0.7	200	>3500	20			
IXBOD 1-38 R	3800											
IXBOD 1-40 R	4000											
IXBOD 1-42 R	4200											

□ Leads soldered on PCB board, T_s and $T_{VJ} = -40 \dots +125\text{ °C}$, Weight IXBOD 1-06 ... IXBOD 1-16 = 0.8 g, IXBOD 1-14 ... IXBOD 1-42 = 15 g

Break-Over-Diodes Sets

We deliver also:

- Special selection of more than 2 pcs IXBOD1-... for every break down voltage of $V_{Bo} > 2000\text{ V}$

- Example

type designation IXBOD Set SA05/00

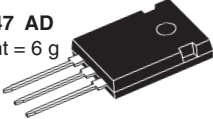
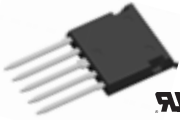
$V_{Bo} = 4700\text{ V} \pm 100\text{ V}$

(we deliver 5pcs single selected IXBOD1-... in one plastic bag)

Customer use these products on PCB connected in series with parallel resistor $R = 10\text{ M}\Omega$ across each IXBOD

MOS / IGBT AC switch

- Fast AC switch
- Easy to turn-off like a MOSFET or IGBT
- Applications
 - lighting control
 - AC motor control
 - matrix inverter

Type	Configuration	BV voltage	Rated current A $T_c = 25\text{ }^\circ\text{C}$	Circuit	Fig. No.	Package style
□ New						Outline drawings on pages O-5...O-17
VMK 165-007T	MOSFET in common source	± 70	165	A	26	Fig. 6 TO-247 AD Weight = 6 g 
FMK 75-01F	MOSFET in common source	± 100	75	B	84	
VMK 90-02T2	MOSFET in common source	± 200	83	A	26	Fig. 84 ISOPLUS i4-PAC™ Weight = 9 g 
□ IXRH 40N120	single RIGBT □	± 1200	55	D	6	
□ IXRR 40N120	single RIGBT □	± 1200	45	D	7	
FIO 50-12BD	IGBT and Diode Bridge	± 1200	50	C	84	

preliminary data, typical values

□ Single IGBT die with reverse blocking capability

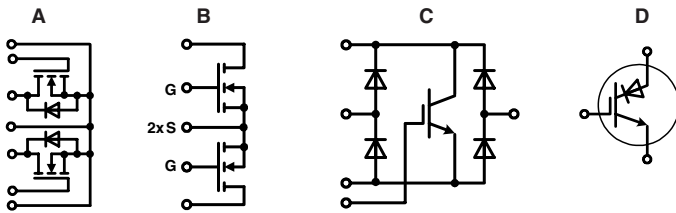


Fig. 26 **TO-240AA**
Weight = 90 g

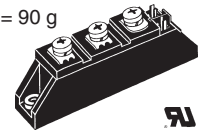
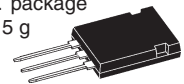
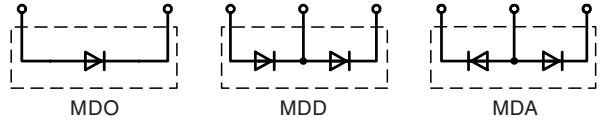


Fig. 7
ISOPLUS247™
DCB isol. package
Weight = 5 g



Diode Modules, Single and Dual

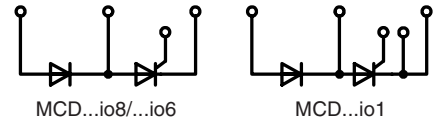


$I_{FAV} = 60-600 \text{ A}$

Type	V_{RRM}	$I_{FAV} @ T_C$		I_{FRMS}	I_{FSM} 45°C 10 ms	V_{TO}	r_T	T_{VJM}	R_{thJC} per Chip	R_{thCH} per Chip	Fig. No.	Package style
□ New	V	A	°C	A	A	V	mΩ	°C	K/W	K/W		Outline drawings on pages O-5...O-17
MDA72-08N1B MDA72-14N1B MDA72-16N1B	800 1400 1600	99	100	180	1700	0.8	2.3	150	0.35	0.2	26	Fig. 26 TO-240 AA Weight = 90 g Fig. 31 Weight = 120 g Fig. 35 Weight = 310 g Fig. 37 Weight = 750 g Fig. 39 Weight = 730 g Fig. 103 Weight = 1500 g
MDD26-08N1B MDD26-12N1B MDD26-14N1B MDD26-16N1B MDD26-18N1B	800 1200 1400 1600 1800	36	100	60	650	0.8	6.1	150	1.0	0.2		
MDD44-08N1B MDD44-12N1B MDD44-14N1B MDD44-16N1B MDD44-18N1B	800 1200 1400 1600 1800	59	100	100	1150	0.8	4.3	150	0.59	0.2		
MDD56-08N1B MDD56-12N1B MDD56-14N1B MDD56-16N1B MDD56-18N1B	800 1200 1400 1600 1800	71	100	150	1400	0.8	3.0	150	0.51	0.2		
MDD72-08N1B MDD72-12N1B MDD72-14N1B MDD72-16N1B MDD72-18N1B	800 1200 1400 1600 1800	99	100	180	1700	0.8	2.3	150	0.35	0.2		
MDD95-08N1B MDD95-12N1B MDD95-14N1B MDD95-16N1B MDD95-18N1B MDD95-20N1B MDD95-22N1B	800 1200 1400 1600 1800 2000 2200	120	105	180	2800	0.75	1.95	150	0.26	0.2		
MDD142-08N1 MDD142-12N1 MDD142-14N1 MDD142-16N1 MDD142-18N1	800 1200 1400 1600 1800	165	100	300	4700	0.8	1.3	150	0.21	0.1	31	
MDD172-08N1 MDD172-12N1 MDD172-14N1 MDD172-16N1 MDD172-18N1	800 1200 1400 1600 1800	190	100	300	6600	0.8	0.8	150	0.21	0.1		
MDD200-14N1 MDD200-16N1 MDD200-18N1	1400 1600 1800	216	100	340	9000	0.8	0.75	150	0.13	0.05	31	
MDD220-08N1 MDD220-12N1 MDD220-14N1 MDD220-16N1 MDD220-18N1	800 1200 1400 1600 1800	270	100	450	8500	0.75	0.9	150	0.129	0.04	35	
MDD250-08N1 MDD250-12N1 MDD250-14N1 MDD250-16N1	800 1200 1400 1600	290	100	450	11000	0.75	0.75	150	0.129	0.04		
MDD255-12N1 MDD255-14N1 MDD255-16N1 MDD255-18N1 MDD255-20N1 MDD255-22N1	1200 1400 1600 1800 2000 2200	270	100	450	9500	0.8	0.6	150	0.140	0.04	37	
MDD310-08N1 MDD310-12N1 MDD310-14N1 MDD310-16N1 MDD310-18N1 MDD310-20N1 MDD310-22N1	800 1200 1400 1600 1800 2000 2200	305	100	480	11500	0.75	0.63	150	0.129	0.04	35	
MDD312-12N1 MDD312-14N1 MDD312-16N1 MDD312-18N1 MDD312-20N1 MDD312-22N1	1200 1400 1600 1800 2000 2200	310	100	520	10500	0.8	0.6	150	0.120	0.04	37	
□ MDD600-12N1 □ MDD600-16N1 □ MDD600-18N1	1200 1600 1800	600	111	940	24000 150°C	0.75	0.2	150	0.062	0.02	103	
MDO500-12N1 MDO500-14N1 MDO500-16N1 MDO500-18N1 MDO500-20N1 MDO500-22N1	1200 1400 1600 1800 2000 2200	560	85	880	15000	0.8	0.38	140	0.072	0.024	39	

Power Modules

Thyristor / Diode Modules



$I_{TAV} = 27-165 \text{ A}$

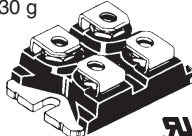
Type	V_{RRM} V_{DRM}	I_{TAV} @ T_C	I_{TRMS}	I_{TSM} 45°C 10ms	V_{TO}	r_T	T_{VJM}	R_{thJC} per Chip	R_{thCH} per Chip	Fig. No.	Package style
□ New	V	A °C	A	A	V	mΩ	°C	K/W	K/W		Outline drawings on pages O-5...O-17
MCD 26-08io1B MCD 26-12io1B MCD 26-14io1B MCD 26-16io1B	800 1200 1400 1600	27 85	50	520	0.85	11	125	0.88	0.2	26	 <p>Fig. 12 SOT-227B miniBLOC Weight = 30 g</p>
MCD 26-08io8B MCD 26-12io8B MCD 26-14io8B MCD 26-16io8B	800 1200 1400 1600	27 85	50	520	0.85	11	125	0.88	0.2	27	
MCD 40-12io6 MCD 40-16io6	1200 1600	38 85	60	500	0.85	9.5	125	0.6	0.5	12	
MCD 44-08io1B MCD 44-12io1B MCD 44-14io1B MCD 44-16io1B MCD 44-18io1B	800 1200 1400 1200 1600	49 85	80	1150	0.85	5.3	125	0.53	0.2	26	
MCD 44-08io8B MCD 44-12io8B MCD 44-14io8B MCD 44-16io8B MCD 44-18io8B	800 1200 1400 1600 1800	49 85	80	1150	0.85	5.3	125	0.53	0.2	27	
MCD 56-08io1B MCD 56-12io1B MCD 56-14io1B MCD 56-16io1B MCD 56-18io1B	800 1200 1400 1600 1800	60 85	100	1500	0.85	3.7	125	0.45	0.2	27	
MCD 56-08io8B MCD 56-12io8B MCD 56-14io8B MCD 56-16io8B MCD 56-18io8B	800 1200 1400 1600 1800	60 85	100	1500	0.85	3.7	125	0.45	0.2	27	
MCD 72-08io1B MCD 72-12io1B MCD 72-14io1B MCD 72-16io1B MCD 72-18io1B	800 1200 1400 1600 1800	85 85	180	1700	0.85	3.2	125	0.3	0.2	26	
MCD 72-08io8B MCD 72-12io8B MCD 72-14io8B MCD 72-16io8B MCD 72-18io8B	800 1200 1400 1600 1800	85 85	180	1700	0.85	3.2	125	0.3	0.2	27	
MCD 94-20io1B MCD 94-22io1B	2000 2200	104 85	180	1700	0.85	3.2	125	0.22	0.2	26	
MCD 95-08io1B MCD 95-12io1B MCD 95-14io1B MCD 95-16io1B MCD 95-18io1B	800 1200 1400 1600 1800	116 85	180	2250	0.8	2.4	125	0.22	0.2		
MCD 95-08io8B MCD 95-12io8B MCD 95-14io8B MCD 95-16io8B MCD 95-18io8B	800 1200 1400 1600 1800	116 85	180	2250	0.8	2.4	125	0.22	0.2	27	
MCD 132-08io1 MCD 132-12io1 MCD 132-14io1 MCD 132-16io1 MCD 132-18io1	800 1200 1400 1600 1800	130 85	300	5500	0.8	1.5	125	0.23	0.1	32	
MCD 161-20io1 MCD 161-22io1	2000 2200	165 85	300	6000	0.8	1.6	125	0.155	0.07		

Fig. 26/27 **TO-240 AA**
Weight = 90 g

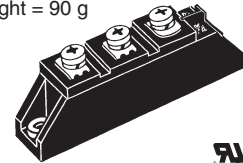
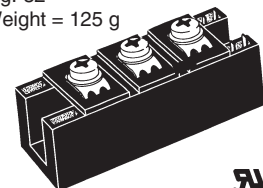
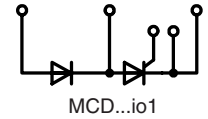


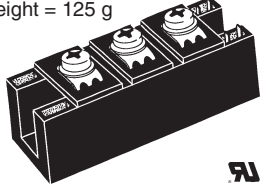
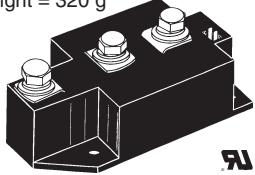
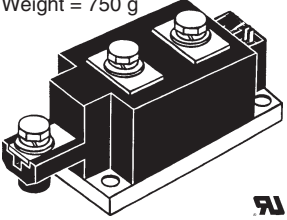
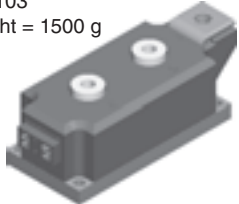
Fig. 32
Weight = 125 g



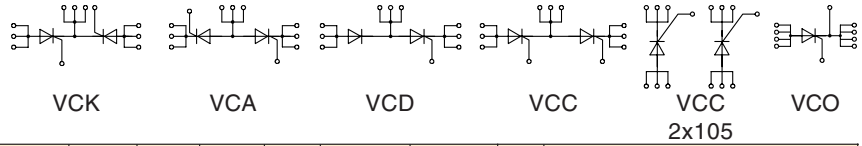
Thyristor / Diode Modules

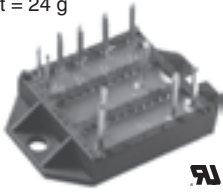


$I_{TAV} = 181 - 500 \text{ A}$

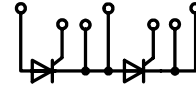
Type	V_{RRM} V_{DRM}	I_{TAV} @ T_c	I_{TRMS}	I_{TSM} 45°C 10 ms	V_{TO}	r_T	T_{VJM}	R_{thJC} per Chip	R_{thCH} per Chip	Fig. No.	Package style
□ New	V	A °C	A	A	V	mΩ	°C	K/W	K/W		Outline drawings on pages O-5...O-17
MCD 162-08io1 MCD 162-12io1 MCD 162-14io1 MCD 162-16io1 MCD 162-18io1	800 1200 1400 1600 1800	181 85	300	6000	0.88	1.15	125	0.155	0.07	32	Fig. 32 Weight = 125 g 
□ MCD 200-14io1 □ MCD 200-16io1 □ MCD 200-18io1	1400 1600 1800	216 85	340	8000	0.8	1.0	125	0.13	0.05		
MCD 224-20io1 MCD 224-22io1	2000 2200	240 85	400	8000	0.8	0.76	130	0.139	0.04	37	
MCD 220-08io1 MCD 220-12io1 MCD 220-14io1 MCD 220-16io1	800 1200 1400 1600	250 85	400	8500	0.9	1.0	140	0.139	0.04	36	Fig. 36 Weight = 320 g 
MCD 225-12io1 MCD 225-14io1 MCD 225-16io1 MCD 225-18io1	1200 1400 1600 1800	221 85	400	8000	0.8	0.76	130	0.157	0.04	37	
MCD 250-08io1 MCD 250-12io1 MCD 250-14io1 MCD 250-16io1 MCD 250-18io1	800 1200 1400 1600 1800	287 85	450	9000	0.85	0.82	140	0.129	0.04	36	
MCD 255-12io1 MCD 255-14io1 MCD 255-16io1 MCD 255-18io1	1200 1400 1600 1800	250 85	450	9000	0.8	0.68	130	0.14	0.04	37	Fig. 37 Weight = 750 g 
MCD 310-08io1 MCD 310-12io1 MCD 310-14io1 MCD 310-16io1 MCD 310-18io1	800 1200 1400 1600 1800	320 85	500	9200	0.8	0.82	140	0.112	0.04	36	
MCD 310-20io1 MCD 310-22io1	2000 2200	320 85	500	8000	0.8	0.82	140	0.112	0.04	36	
MCD 312-12io1 MCD 312-14io1 MCD 312-16io1 MCD 312-18io1	1200 1400 1600 1800	320 85	520	9200	0.8	0.68	140	0.12	0.04	37	
□ MCD 500-12io1 □ MCD 500-16io1 □ MCD 500-18io1	1200 1600 1800	500 89	785	18200 125°C	0.85	0.27	125	0.062	0.02	103	Fig. 103 Weight = 1500 g 

Thyristor Modules

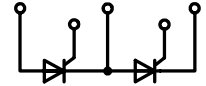


Type	V_{RRM} V_{DRM}	I_{TAV} @ T_C	I_{TRMS}	I_{TSM} 45°C 10 ms	V_{TO}	r_T	T_{VJM}	R_{thJC} per Chip	R_{thCH} per Chip	Fig. No.	Package style
□ New	V	A °C	A	A	V	mΩ	°C	K/W	K/W		Outline drawings on pages O-5...O-17
VCK 105-06io7 VCK 105-12io7 VCK 105-14io7 VCK 105-16io7 VCK 105-18io7	800 1200 1400 1600 1800	105 85	180	2250	0.8	2.4	125	0.26	0.46	25	Fig. 25 ECO-PAC 2 Weight = 24 g  See data sheet for pin arrangement
VCA 105-06io7 VCA 105-12io7 VCA 105-14io7 VCA 105-16io7 VCA 105-18io7	800 1200 1400 1600 1800	105 85	180	2250	0.8	2.4	125	0.26	0.46		
VCD 105-06io7 VCD 105-12io7 VCD 105-14io7 VCD 105-16io7 VCD 105-18io7	800 1200 1400 1600 1800	105 85	180	2250	0.8	2.4	125	0.26	0.46		
VCC 105-06io7 VCC 105-12io7 VCC 105-14io7 VCC 105-16io7 VCC 105-18io7	800 1200 1400 1600 1800	105 85	180	2250	0.8	2.4	125	0.26	0.46		
VCC 2x105-06io7 VCC 2x105-12io7 VCC 2x105-14io7 VCC 2x105-16io7 VCC 2x105-18io7	800 1200 1400 1600 1800	105 85	180	2250	0.8	2.4	125	0.26	0.46		
□ VCO 132-08io7 □ VCO 132-12io7 □ VCO 132-14io7 □ VCO 132-16io7 □ VCO 132-18io7	800 1200 1400 1600 1800	130 85	200	3600	0.8	1.65	150	0.25	0.35		
VCO 180-08io7 VCO 180-12io7 VCO 180-14io7 VCO 180-16io7 VCO 180-18io7	800 1200 1400 1600 1800	180 90	280	4500	0.75	1.23	150	0.17	0.23		

Thyristor Modules



MCC...io1B

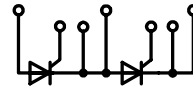


MCC...io8B

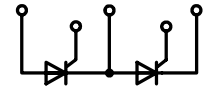
$I_{TAV} = 18-116 \text{ A}$

Type	V_{RRM} V_{DRM} V	I_{TAV} @ T_C A °C	I_{TRMS} A	I_{TSM} 45°C 10 ms A	V_{TO} V	r_T mΩ	T_{VJM} °C	R_{thJC} per Chip K/W	R_{thCH} per Chip K/W	Fig. No.	Package style Outline drawings on pages O-5...O-17
MCC 19-08io1B	800	18 85	40	400	0.85	18	125	1.3	0.2	26	<p>Fig. 26/27 TO-240 AA Weight = 90 g</p>
MCC 19-12io1B	1200										
MCC 19-14io1B	1400										
MCC 19-16io1B	1600										
MCC 19-08io8B	800	18 85	40	400	0.85	18	125	1.3	0.2	27	
MCC 19-12io8B	1200										
MCC 19-14io8B	1400										
MCC 19-16io8B	1600										
MCC 21-08io8B	800	21 85	33	320	0.85	15	125	1.1	0.2	27	
MCC 21-12io8B	1200										
MCC 21-14io8B	1400										
MCC 21-16io8B	1600										
MCC 26-08io1B	800	27 85	50	520	0.85	11	125	0.88	0.2	26	
MCC 26-12io1B	1200										
MCC 26-14io1B	1400										
MCC 26-16io1B	1600										
MCC 26-08io8B	800	27 85	50	520	0.85	11	125	0.88	0.2	27	
MCC 26-12io8B	1200										
MCC 26-14io8B	1400										
MCC 26-16io8B	1600										
MCC 44-08io1B	800	49 85	80	1150	0.85	5.3	125	0.53	0.2	26	
MCC 44-12io1B	1200										
MCC 44-14io1B	1400										
MCC 44-16io1B	1600										
MCC 44-18io1B	1800										
MCC 44-08io8B	800	49 85	80	1150	0.85	5.3	125	0.53	0.2	27	
MCC 44-12io8B	1200										
MCC 44-14io8B	1400										
MCC 44-16io8B	1600										
MCC 44-18io8B	1800										
MCC 56-08io1B	800	60 85	100	1500	0.85	3.7	125	0.45	0.2	26	
MCC 56-12io1B	1200										
MCC 56-14io1B	1400										
MCC 56-16io1B	1600										
MCC 56-18io1B	1800										
MCC 56-08io8B	800	60 85	100	1500	0.85	3.7	125	0.45	0.2	27	
MCC 56-12io8B	1200										
MCC 56-14io8B	1400										
MCC 56-16io8B	1600										
MCC 56-18io8B	1800										
MCC 60-16io1B	1600	not for new design, replacement MCC 56-16io1B									26
MCC 72-08io1B	800	85 85	180	1700	0.85	3.2	125	0.3	0.2	26	
MCC 72-12io1B	1200										
MCC 72-14io1B	1400										
MCC 72-16io1B	1600										
MCC 72-18io1B	1800										
MCC 72-08io8B	800	85 85	180	1700	0.85	3.2	125	0.3	0.2	27	
MCC 72-12io8B	1200										
MCC 72-14io8B	1400										
MCC 72-16io8B	1600										
MCC 72-18io8B	1800										
MCC 94-20io1B	2000	104 85	180	1700	0.85	3.2	125	0.22	0.2	26	
MCC 94-22io1B	2200										
MCC 95-08io1B	800	116 85	180	2250	0.8	2.4	125	0.22	0.2	26	
MCC 95-12io1B	1200										
MCC 95-14io1B	1400										
MCC 95-16io1B	1600										
MCC 95-18io1B	1800										

Thyristor Modules, Dual



MCC...io1B



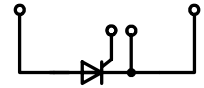
MCC...io8B

$I_{TAV} = 116-320 \text{ A}$

Type	V_{RRM} V_{DRM}	$I_{TAV} @ T_c$		I_{TRMS}	I_{TSM} 45°C 10 ms	V_{TO}	r_T	T_{VJM}	R_{thJC} per Chip	R_{thCH} per Chip	Fig. No.	Package style
□ New	V	A	°C	A	A	V	mΩ	°C	K/W	K/W		Outline drawings on pages O-5...O-17
MCC 95-08io8B MCC 95-12io8B MCC 95-14io8B MCC 95-16io8B MCC 95-18io8B	800 1200 1400 1600 1800	116	85	180	2250	0.8	2.4	125	0.22	0.2	27	Fig. 26/27 TO-240 AA Weight = 90 g
MCC 132-08io1 MCC 132-12io1 MCC 132-14io1 MCC 132-16io1 MCC 132-18io1	800 1200 1400 1600 1800	130	85	300	4750	0.8	1.5	125	0.23	0.1	32	Fig. 32 Weight = 125 g
MCC 161-20io1 MCC 161-22io1	2000 2200	165	85	300	6000	0.8	1.6	125	0.155	0.07		
MCC 162-08io1 MCC 162-12io1 MCC 162-14io1 MCC 162-16io1 MCC 162-18io1	800 1200 1400 1600 1800	181	85	300	6000	0.88	1.15	125	0.155	0.07		
MCC 170-12io1 MCC 170-14io1 MCC 170-16io1 MCC 170-18io1	1200 1400 1600 1800	203	85	350	5400	0.8	1.0	130	0.164	0.04	38	
□ MCC 200-14io1 □ MCC 200-16io1 □ MCC 200-18io1	1400 1600 1800	216	85	340	8000	0.8	1.0	125	0.13	0.05	32	
MCC 220-08io1 MCC 220-12io1 MCC 220-14io1 MCC 220-16io1 MCC 220-18io1	800 1200 1400 1600 1800	250	85	400	8500	0.9	1.0	140	0.139	0.04	36	Fig. 36 Weight = 320 g
MCC 224-20io1 MCC 224-22io1	2000 2200	240	85	400	8000	0.8	0.76	130	0.139	0.04	38	
MCC 225-12io1 MCC 225-14io1 MCC 225-16io1 MCC 225-18io1	1200 1400 1600 1800	221	85	400	8000	0.8	0.76	130	0.16	0.04		
MCC 250-08io1 MCC 250-12io1 MCC 250-14io1 MCC 250-16io1 MCC 250-18io1	800 1200 1400 1600 1800	287	85	450	9000	0.85	0.82	140	0.129	0.04	36	Fig. 38 Weight = 750 g
MCC 255-12io1 MCC 255-14io1 MCC 255-16io1 MCC 255-18io1	1200 1400 1600 1800	250	85	450	9000	0.8	0.68	130	0.14	0.04	38	
MCC 310-08io1 MCC 310-12io1 MCC 310-14io1 MCC 310-16io1 MCC 310-18io1	800 1200 1400 1600 1800	320	85	500	9200	0.8	0.82	140	0.112	0.04	36	
MCC 312-12io1 MCC 312-14io1 MCC 312-16io1 MCC 312-18io1	1200 1400 1600 1800	320	85	520	9200	0.8	0.68	140	0.12	0.04	38	Fig. 103 Weight = 1500 g
□ MCC 500-12io1 □ MCC 500-14io1 □ MCC 500-16io1 □ MCC 500-18io1	1200 1400 1600 1800	500	89	785	18200 125°C	0.85	0.27	125	0.062	0.02	103	

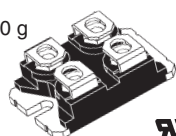
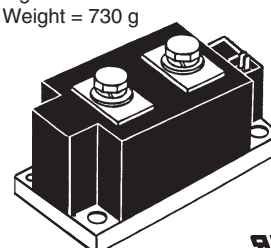
Power Modules

Thyristor Modules, Single



MCO

$I_{TAV} = 149-600 \text{ A}$

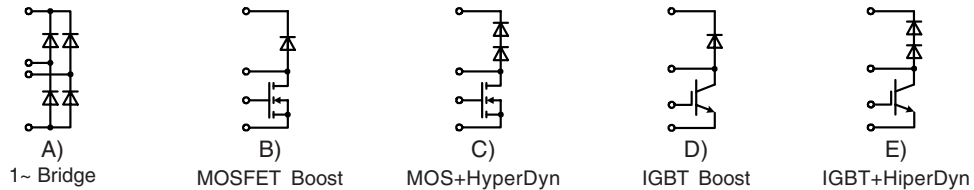
Type	V_{RRM} V_{DRM}	I_{TAV}	T_C	I_{TRMS}	I_{TSM} 45°C 10 ms	V_{TO}	r_T	T_{VJM}	R_{thJC} per Chip	R_{thCH} per Chip	Fig. No.	Package style
New	V	A	°C	A	A	V	mΩ	°C	K/W	K/W		Outline drawings on pages O-5...O-17
MCO 25-12io1 MCO 25-16io1	1200 1600										12	Fig. 12 Weight = 30 g 
MCO 50-12io1 MCO 50-16io1	1200 1600											
MCO 100-12io1 MCO 100-16io1	1200 1600											
MCO 150-12io1 MCO 150-16io1	1200 1600	149	80	234	2000	0.8	3.8	150	0.2	0.1		Fig. 40 Weight = 730 g 
MCO 450-20io1 MCO 450-22io1	2000 2200	464	85	750	15000	0.77	0.42	130	0.072	0.024	40	
MCO 500-12io1 MCO 500-14io1 MCO 500-16io1 MCO 500-18io1	1200 1400 1600 1800	560	85	880	17000	0.8	0.38	140	0.072	0.024		
MCO 600-16io1 MCO 600-18io1 MCO 600-20io1 MCO 600-22io1	1600 1800 2000 2200	600	85	928	15000	0.77	0.42	140	0.065	0.02		

under development

Rectifier Bridges for Power Factor Correction

Power Stage for Boost Converters (Power Factor Correction)

1-phase PFC



Type	Circuit	V_{DSSmax} V	I_D $T_C = 25^\circ C$ A	$R_{DS(on)}$ max. Ω	V_{RRM} Boost Diode V	V_{RRM} Rectifier Diodes V	Fig. No.	Package style Outline drawings on pages O-5...O-17
MOSFET	IXFN 44N50U2	B	500	44	0.12	600	-	12
	IXFE 48N50QD2	B	500	48	0.10	600	-	87
	IXFN 48N50U2	B	500	48	0.10	600	-	12
	FMD 21-05QC	C	500	21	0.22	600	-	84
	FMD 40-06KC	C, CoolMOS**	600	38	0.06	600	-	84
	VUM 24-05N	A + B	500	35	0.12	600	800	46
	VUM 33-05N	A + B	500	47	0.12	600	800	46
								Fig. 46 Weight = 28 g
Type	Circuit	V_{CESmax} V	I_C $T_C = 25^\circ C$ A	$V_{CE(sat)}$ @ I_C V A	V_{RRM} Boost Diode V	V_{RRM} Rectifier Diodes V	Fig. No.	Package style Outline drawings on pages O-5...O-17
IGBT	IXGN 50N60BD2	D	600	75	2.5 50	600	-	12
	FID 35-06C	E	600	38	1.9 25	600	-	84
	FID 36-06D	D	600	38	1.9 25	600	-	84
	FID 60-06D	D	600	65	1.6 30	600	-	84
	VUI 9-06N7	A + D	600	37	1.8 10	600	1200	24
								Fig. 12 SOT-227B miniBLOC Weight = 30 g
								Fig. 24 ECO-PAC 1 Weight = 19 g See data sheet for pin arrangement
								Fig. 84 ISOPLUS i4-PAC™ Weight = 9 g
Type	Circuit	V_{RRM} V	$I_{D(AV)}$ @ T_C					Fig. No.
Rect.	FBO 16-12N *	A	1200		22 A @ 90 °C			84
	FBO 40-12N *	A	1200		40 A @ 90 °C			84

* Recommended in combination with types FMD and FID

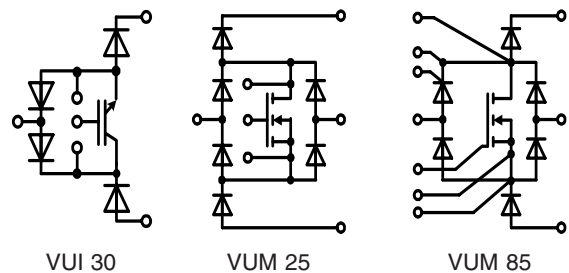
** COOLMOS

CoolMOS™ is a trademark of Infineon Technologies

3-phase PFC

“Vienna Rectifier” circuit

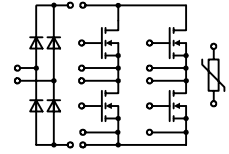
- wide input voltage range
- sinusoidal mains input currents in phase with mains
- boost converter operation:
 - input: three phase AC mains without neutral conductor
 - output: stabilized DC link with center point
- one module used per phase

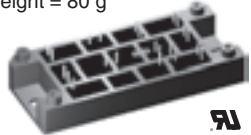


For further information on this circuit please visit IXYS web site <http://www.ixys.com>

Type	P_N / kW 3 ~ 400 V $T_C = 80^\circ C$	Configuration	Fig. No.	Package style Outline drawings on pages 91-100
VUM 25-05E	10	Vienna rectifier current	47	Fig. 47 Weight = 35 g
VUM 85-05A	30	Vienna rectifier current	48	Fig. 48 V2-Package Weight = 80 g
VUI 30-12N1	15	IGBT stage for buck @ boost PWM converter	47	

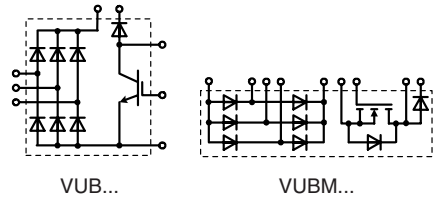
Module with HiPerFET™ H-Bridge and Single Phase Mains Rectifier Bridge


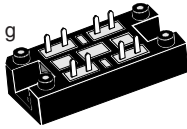
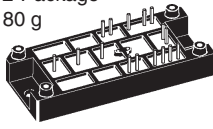



Type	V _{DSS} V	I _D A T _C = 25°C	I _D A T _C = 80°C	R _{DSon(max)} mΩ T _C = 25°C	V _{DRM} V rectifier diode	I _{DAVM} @ T _C A	Package style
□ New							Outline drawings on pages O-5...O-17
VBH 40-05B	500	40	30	120	1200	33 80	Weight = 80 g 

3~ Rectifier Bridges

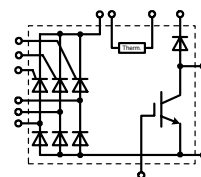
with IGBT and Diode for Brake Unit



Type	V _{RRM} V	Rectifier		IGBT		fast Diode			Fig. No.	Package style
		I _{dAV} @ T _H A	°C	V _{CES} V	I _{C 80} A	V _{RRM} V	I _{F(AV)} A	t _{tr} ns		
□ New										Outline drawings on pages O-5...O-17
VUB 33-06P1	600	22	90	600	33	600	24	30	25	
VUBM 33-05P1	500	48	T _C = 100	500	36/MOSFET	600	30	30	25	
□ VUB 50-12PO1	1200	56	T _C = 100	1200	10	1200	10	110	25	Fig. 25 ECO-PAC 2 Weight = 24 g See data sheet for pin arrangement
□ VUB 50-16PO1	1600									
□ VUB 72-12NO1	1200	110	80	1200	35	1200	40	130	47	
□ VUB 72-16NO1	1600									
□ VUB 116-16NO1	1600	116	100	1200	67	1200	27	40	81	Fig. 47 Weight = 35 g
□ VUB 120-12NO1	1200	not for new design, replacement VUB 120-12NO2							48	
□ VUB 120-16NO1	1600	not for new design, replacement VUB 120-16NO2							48	
□ VUB 120-12NO2	1200	130	75	1200	102/75°C	1200	32	40	48	Fig. 48 V2-Package Weight = 80 g 
□ VUB 120-16NO2	1600								81	
□ VUB 145-16NO1	1600	145	100	1200	100	1200	27	40	81	Fig. 81 Weight = 180 g 
□ VUB 160-12NO1	1200	not for new design, replacement VUB 160-12NO2							48	
□ VUB 160-16NO1	1600	not for new design, replacement VUB 160-16NO2							48	
□ VUB 160-12NO2	1200	170	75	1200	127/75°C	1200	32	40	48	
□ VUB 160-16NO2	1600								48	

3~ Half Controlled Rectifier Bridges

with IGBT and Diode for Brake Unit



VVZB 120-12io1	1200	120	T _C = 80	1200	52	1200	27	40	48
VVZB 120-16io1	1600								
□ VVZB 135-16NO1	1600	135	T _C = 85	1200	67	1200	27	40	81
□ VVZB 170-16NO1	1600	170	T _C = 85	1200	100	1200	27	40	81

Rectifier Bridges with Fast Diodes

Rectifier Bridges with Superfast Recovery Diodes

1-phase, B2U



Type	V _{RRM}	I _{DAV} @ T _C	I _{FSM} 45°C 10 ms	V _{T0}	r _T	T _{VJM}	R _{thJC} per Chip	R _{thJH typ} per Chip	Fig. No.	Package style
□ New	V	A °C	A	V	mΩ	°C	K/W	K/W		Outline drawings on pages O-5...O-17
VBE 17-06NO7	600	27 85	50	1.18	22.0	150	2.50	2.8	24	Fig. 46 Weight = 28 g
VBE 17-12NO7	1200	19 85	40	1.32	30.0	150	2.50	2.8		
VBE 20-20NO1	2000	20 85	75	3.30	92.4	150	1.25	-	46	Fig. 47 Weight = 35 g
VBE 26-06NO7	600	44 85	110	1.13	13.0	150	1.60	1.9		
VBE 26-12NO7	1200	32 85	90	1.32	30.0	150	1.60	1.9	24	
VBE 55-06NO7	600	68 100	250	0.98	8.0	150	0.90	1.2	24	Fig. 47 Weight = 35 g
VBE 55-12NO7	1200	59 85	200	1.31	15.0	150	0.90	1.2		
□ VBE 60-06A	600	60 90	250	0.98	6.8	150	1.15	0.1	12	Fig. 24 ECO-PAC 1 Weight = 19 g
FBE 22-06N1	600	20 90	40	-	-	150	3.5	3.65	84	
VBE 100-06NO7	600	100 85	600	1.09	4.3	150	0.85	1	25	See data sheet for pin arrangement
VBE 100-12NO7	1200	100 75	500	1.12	5.7	150	0.85	1		
FBS 10-06SC*	600	6.6 90	12	-	-	175	8	11.5	84	See data sheet for pin arrangement
FBS 16-06SC*	600	11 90	20	-	-	175	5.6	8.6		
FBS 10-12SC*	1200			under development						

* SiC-Diodes

3-phase, B6U



□ FUS 45-0045B	45	20 90	150	-	-	150	3.1	-	84	Fig. 25 ECO-PAC 2 Weight = 24 g
VUE 50-12NO1	1200	50 85	200	1.65	18.2	150	-	1.5	47	
VUE 30-20NO1	2000	30 85	75	3.30	92.4	150	1.25	-	24	See data sheet for pin arrangement
VUE 22-06NO7	600	34 85	50	1.18	22.0	150	2.50	2.8		
VUE 22-12NO7	1200	24 85	40	1.39	55.0	150	2.50	2.8	24	Fig. 42 Weight = 22 g
VUE 35-06NO7	600	56 85	110	1.13	13.0	150	1.60	1.9		
VUE 35-12NO7	1200	40 85	90	1.32	30.0	150	1.60	1.9	24	Fig. 42 Weight = 22 g
VUE 75-06NO7	600	86 100	250	0.98	8.0	150	0.90	1.2		
VUE 75-12NO7	1200	74 85	200	1.31	15.0	150	0.90	1.2	24	Fig. 12 SOT-227B miniBLOC Weight = 30 g
FUE 30-12N1	1200	30 90	80	-	-	150	2.3	2.45		
VUE 130-06NO7	600	130 85	600	1.09	4.3	150	0.85	1	25	See data sheet for pin arrangement
VUE 130-12NO7	1200	130 75	500	1.12	5.7	150	0.85	1		

Rectifier Bridges with Semifast Diodes

3-phase, B6U, t_{rr} = 1.5 μs



VUO 18-12DT8	1200	18 63	300	1.2	16	150	9.3	10.2	42	Fig. 84 ISOPLUS i4-PAC™ Weight = 9 g
VUO 18-14DT8	1400									
VUO 18-16DT8	1600							(120°sine)		

Rectifier Bridges incorporating Fast Diodes

Power switching semiconductors are used in inverter systems with DC-Link. Due to high switching frequencies, harmonics and line distortion may be generated. It is important that the new designs reduce these influences and fulfill the EMI filtering requirements according to EMI/EMC VDE 0871 and other.

The noise level can be reduced by up to **10dB** when the input rectifier is equipped with Semi-fast diodes and is therefore optimised for turn off; resulting in a lower peak recovery current compared to non-optimised and normal rectifier diodes.

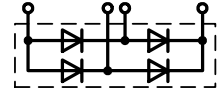
The noise level can be further reduced approximately by another **5dB** when using rectifier bridges equipped with Fast

Recovery Epitaxial Diodes (FRED) like module types VBE (single phase bridge) or VUE (three phase bridge). However these are more expensive but may be necessary in some applications to fulfill the VDE or other standards.



This behaviour has a direct influence on the design of the EMI filter networks with its capacitors and inductors of which the size and costs can be reduced.

More detailed information is available in the IXYS application note D98005E "Input Rectifiers with Semi-fast Diodes for DC Link" on www.ixys.com.

1~ Rectifier Bridges



1~ Rectifier Bridges with Avalanche Diodes, B2U

Type	V _{RRM}	V _{VRMS}	I _{dAV} @ T _C		I _{FSM} 45°C 10 ms	V _{TO}	r _T	T _{VJM}	R _{thJC} per Chip	R _{thJH} per Chip	P _{RSM}	Fig. No.	Package style Outline drawings on pages O-5...O-17	
□ New	V	V	A	°C	A	V	mΩ	°C	K/W	K/W	kW			
VBO 13-12AO2	1200	400	18	85	220	0.85	17	150	5.6	6.0	2.5	40	Fig. 40 Weight = 15 g 	
VBO 13-14AO2	1400	500												
VBO 13-16AO2	1600	500												
VBO 20-12AO2	1200	400	31	85	300	0.85	14	150	3.0	3.4	3.4			
VBO 20-14AO2	1400	440												
VBO 20-16AO2	1600	500												
VBO 25-12AO2	1200	400	38	85	370	0.85	8	150	2.8	3.2	3.4			Fig. 41 Weight = 22 g 
VBO 25-14AO2	1400	440												
VBO 25-16AO2	1600	500												

1~ Rectifier Bridges with Standard Diodes, B2U

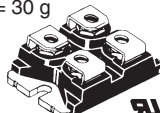
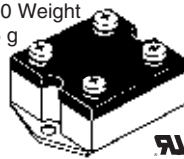
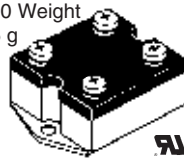







VBO 13-08NO2	800	250	18	85	220	0.85	17	150	5.6	6.0	-	40	Fig. 12 SOT-227B miniBLOC Weight = 30 g 				
VBO 13-12NO2	1200	400															
VBO 13-14NO2	1200	400															
VBO 13-16NO2	1600	500															
FBO 16-12N	1200	400	22	90	100	0.83	28	150	4.0	5.0	-			84			
VBO 19-06NO7	600	180	21	100	100	0.8	40	150	2.3	2.8	08			78			
VBO 19-08NO7	800	250															
VBO 19-12NO7	1200	400															
VBO 20-08NO2	800	250	31	85	300	0.85	14	150	3.0	3.4	-					40	Fig. 50 Weight = 135 g 
VBO 20-12NO2	1200	400															
VBO 20-14NO2	1400	440															
VBO 20-16NO2	1600	500															
VBO 21-06NO7	600	125	21	100	100	0.8	40	150	2.3	2.8	-	24					
VBO 21-08NO7	800	250															
VBO 21-12NO7	1200	400															
VBO 22-08NO8	800	250	17	85	380	0.85	12	150	8.2	9.4	-			41	Fig. 57 Weight = 100 g 		
VBO 22-12NO8	1200	400															
VBO 22-14NO8	1400	440															
VBO 22-16NO8	1600	500															
VBO 22-18NO8	1800	575															
VBO 25-08NO2	800	250	38	85	370	0.85	8	150	2.8	3.2	-					40	
VBO 25-12NO2	1200	400															
VBO 25-14NO2	1400	440															
VBO 25-16NO2	1600	500															
VBO 30-08NO7	800	250	35	85	400	0.85	12	150	2.8	3.4	-	50	Fig. 84 ISOPLUS i4-PAC™ Weight = 9 g 				
VBO 30-12NO7	1200	400															
VBO 30-14NO7	1400	440															
VBO 30-16NO7	1600	500															
VBO 30-18NO7	1800	575															
VBO 36-08NO8	800	250	23	85	550	0.8	5.8	150	6.2	7.4	-			41	Fig. 24 ECO-PAC 1 Weight = 19 g 		
VBO 36-12NO8	1200	400															
VBO 36-14NO8	1400	440															
VBO 36-16NO8	1600	500															
VBO 36-18NO8	1800	575															
FBO 40-12N	1200	400	40	90	250	0.83	10	150	2.3	2.9	-	84					
VBO 40-08NO6	800	250	40	100	300	0.8	13	150	1.7	2.0	-	12					
VBO 40-12NO6	1200	400															
VBO 40-16NO6	1600	500															
VBO 45-08NO7	800	250	45	100	550	0.8	8	150	1.45	1.9	-			57	See data sheet for pin arrangement 		
VBO 45-12NO7	1200	400															
VBO 45-14NO7	1400	440															
VBO 45-16NO7	1600	500															
VBO 45-18NO7	1800	575															

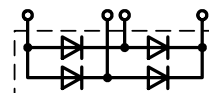
Fig. 78
Weight = 17 g



Fig. 25 ECO-PAC 2
Weight = 24 g
See data sheet for pin arrangement



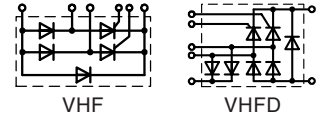
1~ Rectifier Bridges



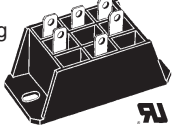
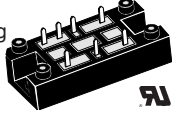
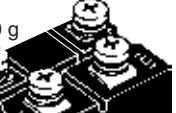
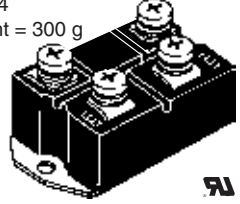
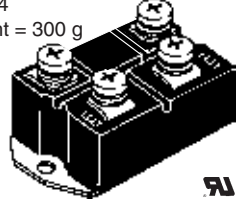
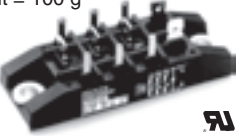
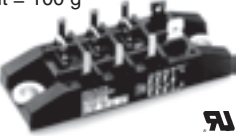
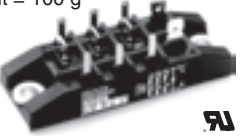


1~ Rectifier Bridges with Standard Diodes, B2U

Type	V _{RRM}	V _{VRMS}	I _{dAV} @ T _C		I _{FSM} 45°C 10 ms	V _{TO}	r _T	T _{VJM}	R _{thJC} per Chip	R _{thJH} per Chip	Fig. No.	Package style
□ New	V	V	A	°C	A	V	mΩ	°C	K/W	K/W		Outline drawings on pages O-5...O-17
VBO 50-08NO7 VBO 50-12NO7 VBO 50-14NO7 VBO 50-16NO7 VBO 50-18NO7	800 1200 1400 1600 1800	250 400 440 500 575	50	64	750	0.85	8	150	2.6	2.84	51	Fig. 51
VBO 52-08NO7 VBO 52-12NO7 VBO 52-14NO7 VBO 52-16NO7 VBO 52-18NO7	800 1200 1400 1600 1800	250 400 440 500 575	52	100	550	0.8	8	150	1.45	1.87	53	Weight = 260 g Fig. 52
VBO 54-08NO7 VBO 54-12NO7 VBO 54-14NO7 VBO 54-16NO7	800 1200 1400 1600	250 400 440 500	54	100	300	0.8	13	150	1.1	1.6	24	Weight = 225 g Fig. 52
VBO 55-08NO7 VBO 55-12NO7 VBO 55-14NO7 VBO 55-16NO7 VBO 55-18NO7	800 1200 1400 1600 1800	250 400 440 500 575	55	100	750	0.8	6	150	1.3	1.6	57	Fig. 53
VBO 65-08NO7 VBO 65-12NO7 VBO 65-14NO7 VBO 65-16NO7 VBO 65-18NO7	800 1200 1400 1600 1800	250 400 440 500 575	65	100	1000	0.8	5	150	1.12	1.5	57	Fig. 53 Weight = 160 g
VBO 68-08NO7 VBO 68-12NO7 VBO 68-14NO7 VBO 68-16NO7	800 1200 1400 1600	250 400 440 500	68	90	530	0.8	7.5	150	1.2	1.5	24	Fig. 54 Weight = 300 g
VBO 72-08NO7 VBO 72-12NO7 VBO 72-14NO7 VBO 72-16NO7 VBO 72-18NO7	800 1200 1400 1600 1800	250 400 440 500 575	72	100	750	0.8	5	150	1.1	1.52	53	
VBO 78-08NO7 VBO 78-12NO7 VBO 78-14NO7 VBO 78-16NO7 VBO 78-18NO7	800 1200 1400 1600 1800	250 400 440 500 575	76	90	750	0.8	8	150	1.0	1.4	25	Fig. 57 Weight = 100 g
VBO 88-08NO7 VBO 88-12NO7 VBO 88-14NO7 VBO 88-16NO7 VBO 88-18NO7	800 1200 1400 1600 1800	250 400 440 500 575	95	95	1400	0.8	4	150	0.85	1.25	25	
VBO 105-08NO7 VBO 105-12NO7 VBO 105-14NO7 VBO 105-16NO7 VBO 105-18NO7	800 1200 1400 1600 1800	250 400 440 500 575	107	85	1500	0.8	5	150	0.83	1.13	52	Fig. 24 ECO-PAC 1 Weight = 19 g
VBO 125-08NO7 VBO 125-12NO7 VBO 125-14NO7 VBO 125-16NO7 VBO 125-18NO7	800 1200 1400 1600 1800	250 400 440 500 575	124	85	1800	0.8	3	150	0.83	1.13	52	See data sheet for pin arrangement
VBO 130-08NO7 VBO 130-12NO7 VBO 130-14NO7 VBO 130-16NO7 VBO 130-18NO7	800 1200 1400 1600 1800	250 400 440 500 575	122	100	1800	0.8	3	150	0.65	0.83	54	Fig. 25 ECO-PAC 2 Weight = 24 g
VBO 160-08NO7 VBO 160-12NO7 VBO 160-14NO7 VBO 160-16NO7 VBO 160-18NO7	800 1200 1400 1600 1800	250 400 440 500 575	174	100	2800	0.8	2.2	150	0.45	0.6	54	See data sheet for pin arrangement

1~ Rectifier Bridges

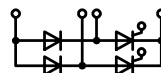


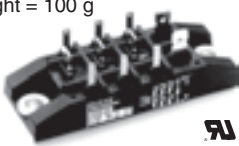
1~ Half Controlled Rectifier Bridges with free wheeling diode, B2HKF

Type	V_{RRM}	V_{VRMS}	$I_{dAV} @ T_H$		I_{FSM} 45°C 10 ms A	V_{TO} V	r_T mΩ	T_{VJM} °C	R_{thJC} per Chip K/W	R_{thJH} per Chip K/W	E.P. No.	Package style Outline drawings on pages O-5...O-17
	V	V	A	°C								
VHF 15-08io5	800	250	15	85	190	1.0	40	125	2.4	3.0	43	Fig. 43 Weight = 50 g 
VHF 15-12io5	1200	400										
VHF 15-14io5	1400	440										
VHF 15-16io5	1600	500										
VHF 25-06io7	600	125	32	85	200	0.85	27	1.3	1.8	24	$T_c = 85^\circ C$ 	
VHF 25-08io7	800	250										
VHF 25-12io7	1200	400										
VHF 28-08io5	800	250	28	85	300	0.9	15	125	1.4	2.0	43	Fig. 47 Weight = 35 g 
VHF 28-12io5	1200	400										
VHF 28-14io5	1400	440										
VHF 28-16io5	1600	500										
VHF 36-08io5	800	250	36	85	320	0.85	13	125	1.15	1.55	43	Fig. 54 Weight = 300 g 
VHF 36-12io5	1200	400										
VHF 36-14io5	1400	440										
VHF 36-16io5	1600	500										
VHF 55-08io7	800	250	53	85	550	0.85	11	125	0.9	1.1	57	
VHF 55-12io7	1200	400										
VHF 55-14io7	1400	440										
VHF 55-16io7	1600	500										
VHF 85-12io7	1200	400	82	85	1150	0.85	6	125	0.65	0.8	54	
VHF 85-14io7	1400	440										
VHF 125-12io7	1200	400	123	85	1500	0.85	3.5	125	0.46	0.55	54	Fig. 57 Weight = 100 g 
VHF 125-14io7	1400	440										
VHF 125-16io7	1600	500										
VHFD 16-08io1	800	250	16	85	150	1.0	40	125	2.4	3.0	47	
VHFD 16-12io1	1200	400										
VHFD 16-14io1	1400	440										
VHFD 16-16io1	1600	500										
VHFD 29-08io1	800	250	28	85	300	0.9	15	125	1.4	2.0	47	Fig. 24 ECO-PAC 1 Weight = 19 g 
VHFD 29-12io1	1200	400										
VHFD 29-14io1	1400	440										
VHFD 29-16io1	1600	500										
VHFD 37-08io1	800	250	36	85	320	0.85	13	125	1.2	1.55	47	See data sheet for pin arrangement 
VHFD 37-12io1	1200	400										
VHFD 37-14io1	1400	440										
VHFD 37-16io1	1600	500										

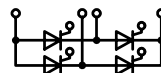
1~ Rectifier Bridges


1~Half Controlled Rectifier Bridge, B2HK



Type	V _{RRM} V	V _{vRMS} V	I _{dAV} @ T _C A °C		I _{FSM} 45°C 10 ms A	V _{T0} V	r _T mΩ	T _{VJM} °C	R _{thJC} per Chip K/W	R _{thJH} per Chip K/W	Fig. No.	Package style
VHO 55-08io7	800	250	53	85	550	0.85	11	125	0.9	1.1	57	Outline drawings on pages O-5...O-17 Fig. 57 Weight = 100 g 
VHO 55-12io7	1200	400										
VHO 55-14io7	1400	440										
VHO 55-16io7	1600	500										

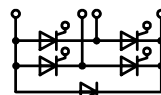
1~ Full Controlled Rectifier Bridge, B2C

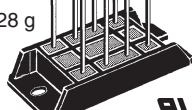


VKO 55-08io7	800	250	53	85	550	0.85	11	125	0.9	1.1	57	Fig. 24 ECO-PAC 1 Weight = 19 g 
VKO 55-12io7	1200	400										
VKO 55-14io7	1400	440										
VKO 55-16io7	1600	500										

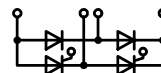
See data sheet for pin arrangement


1~ Full Controlled Rectifier Bridge, B2CF



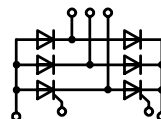
VKF 55-08io7	800	250	53	85	550	0.85	11	125	0.9	1.1	57	Fig. 45 Weight = 28 g 
VKF 55-12io7	1200	400										
VKF 55-14io7	1400	440										
VKF 55-16io7	1600	500										

1~ Half Controlled Rectifier Bridge, B2HZ



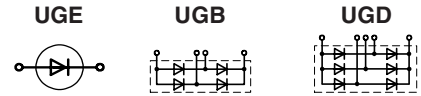
VGO 36-08io7	800	250	36	85	320	0.85	13	125	1.4	2.0	24	
VGO 36-12io7	1200	400										
VGO 36-14io7	1400	440										
VGO 36-16io7	1600	500										
VGO 55-08io7	800	250	53	85	550	0.85	11	125	0.9	1.1	57	
VGO 55-12io7	1200	400										
VGO 55-14io7	1400	440										
VGO 55-16io7	1600	500										


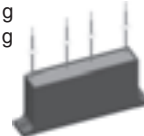
Thyristor Module



VVY 40-16io1	1600	500	43	85	320	0.85	15	125	1.0	1.6	45
--------------	------	-----	----	----	-----	------	----	-----	-----	-----	----

1~ / 3~ High Voltage Rectifier Modules

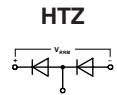









Type	V _{RRM} V	I _{dAV} □ / □ A	I _{FSM} 45°C 10 ms A	V _{TO} V	r _T mΩ	T _{VJM} °C	R _{thJA1} □ K/W	R _{thJA2} □ K/W	Package style
UGE 0421 AY4	3200	23/7.4	300	1.7	16	150	1.9	7.1	Outline drawings on pages O-5...O-17 Fig. 58 Weight = 130 g 
UGE 0221 AY4	4800	10/3.8	180	2.55	90	150	1.7	8.0	
UGE 1112 AY4	8000	4.2/2.0	120	4.25	215	150	4.2	10.0	
UGE 3126 AY4	24000	2.0/0.8	70	12	1800	150	2.7	8.7	
UGB 3132 AD	4800	1.3	60	-	-	150	-	-	Fig. 59a Weight = 150 g Fig. 59b Weight = 300 g Fig. 59b Fig. 59b 
UGB 6124 AG	10500	1.0	50	-	-	150	-	-	
UGD 6123 AG	7200	1.8	50	-	-	150	-	-	
UGD 8124 AG	10500	1.2	50	-	-	150	-	-	

Data according to IEC 60747-2/6 □ for oil-cooling with cooling plate, T_A = 35°C □ for natural air cooling without cooling plate, T_A = 45°C

High Voltage Rectifiers

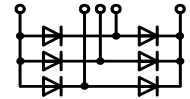
Diode Assembly Range



Type □ New	V _{RRM} V	I _{F(AV)} A @ T _A °C	I _{FSM} A	I _{RM} @ T _{VJM} mA	T _{VJ} °C	V _{FM} V @ I _{FM} A	Fig.	Package style
HTZ110A16K HTZ110A19K HTZ110A22K HTZ110A25K	16000 19000 22000 25000	3.5 35	200	0.5	150	18.3 12	56a	Outline drawings on pages O-5...O-17 Fig. 56a Weight = 1550/1660 g 
HTZ120A32K HTZ120A38K HTZ120A44K HTZ120A51K	32000 30000 44000 51000	2.0 35	200	0.5	150	36.8 12	56a	Fig. 56b Weight = 380 g 
HTZ130B24K HTZ130B28K HTZ130B33K HTZ130B38K	24000 28000 33000 38000	1.0 35	100	0.5	150	24.0 2.0	56b	
HTZ150C6K HTZ150C7K HTZ150C8K HTZ150C9K	6000 7200 8400 9600	3.0 35	100	0.5	150	6.0 2.0	56c	Fig. 56c Weight = 240/260/280 g 
HTZ160C12K HTZ160C14K HTZ160C17K HTZ160C19K	12000 14400 16800 19200	1.7 35	100	0.5	150	12.0 2.0	56c	
HTZ170C2K HTZ170C2.4K HTZ170C2.8K	2000 2400 2800	10.0 35	1000	0.5	150	1.9 40	56c	Fig. 56d Weight = 500 g 
HTZ180D22K HTZ180D26K HTZ180D30K HTZ180D35K	22000 26000 30000 35000	1.3 35	100	0.5	150	22.0 2.0	56d	
HTZ240F10K HTZ240F12K HTZ240F14K HTZ240F16K	10000 12000 14000 16000	1.7 35	100	0.5	150	10.0 2.0	56e	Fig. 56e Weight = 200 g 
HTZ250G28K HTZ250G33K HTZ250G39K HTZ250G44K	28000 33600 39200 44800	2.7 35	200	0.5	150	32.0 12	56f	
HTZ260G14K HTZ260G16K HTZ260G19K HTZ260G22K	14000 16000 19000 22000	4.7 35	200	0.5	150	16.0 12	56f	Fig. 56f Weight = 2000/1700 g 
HTZ270H40K HTZ270H48K HTZ270H56K HTZ270H64K	40000 48000 56000 64000	3.4 35	200	0.5	150	46.0 12	56g	
HTZ280H20K HTZ280H24K HTZ280H28K □ HTZ280H32K	20000 24000 28000 32000	4.7 35	200	0.5	150	23.0 12	56g	Fig. 56g Weight = 2200/2000 g 

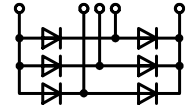
Data according to IEC 60747 and refer to a single diode or thyristor unless otherwise stated.

3~ Rectifier Bridges, B6U



Type	V _{RRM}	V _{VRMS}	I _{dAV}	T _C	I _{FSM} 45°C 10 ms	V _{TO}	r _T	T _{VJM}	R _{thJC} per Chip	R _{thJH} per Chip	Fig. No.	Package style
□ New	V	V	A	°C	A	V	mΩ	°C	K/W	K/W		Outline drawings on pages O-5...O-17
VUO 16-08NO1 VUO 16-12NO1 VUO 16-14NO1 VUO 16-16NO1 VUO 16-18NO1	800 1200 1400 1600 1800	250 400	15	90	100	0.8	50	130	-	4.5	47	Fig. 42 Weight = 22 g
FUO 22-12N FUO 22-16N	1200 1600	400 500	27	90	100	0.83	28	150	4	5	84	
VUO 22-08NO1 VUO 22-12NO1 VUO 22-14NO1 VUO 22-16NO1 VUO 22-18NO1	800 1200 1400 1600 1800	250 400	22	90	100	0.8	40	130	-	3.1	47	Fig. 44 Weight = 50 g
VUO 25-06NO8 VUO 25-12NO8 VUO 25-14NO8 VUO 25-16NO8 VUO 25-18NO8	600 1200 1400 1600 1800	125 400	25	63	380	0.85	12	150	9.3	10.2	42	Fig. 47 Weight = 35 g
VUO 27-06NO7 VUO 27-08NO7 VUO 27-12NO7	600 800 1200	180 250 400	28	100	100	0.8	40	150	2.3	2.8	78	
VUO 28-06NO7 VUO 28-08NO7 VUO 28-12NO7	600 800 1200	125 250 400	28	100	100	0.8	40	150	2.3	2.8	24	
VUO 36-06NO8 VUO 36-12NO8 VUO 36-14NO8 VUO 36-16NO8 VUO 36-18NO8	600 1200 1400 1600 1800	125 400	35	62	550	0.8	7.4	150	7.5	8.4	42	Fig. 50 Weight = 135 g
VUO 34-08NO1 VUO 34-12NO1 VUO 34-14NO1 VUO 34-16NO1 VUO 34-18NO1	800 1200 1400 1600 1800	250 400	36		300	0.8	15	130	-	2.5	47	
VUO 30-08NO3 VUO 30-12NO3 VUO 30-14NO3 VUO 30-16NO3 VUO 30-18NO3	800 1200 1400 1600 1800	250 400	37	85	300	0.9	11	125	2.4	3.0	44	Fig. 51 Weight = 260 g
VUO 35-06NO7 VUO 35-12NO7 VUO 35-14NO7 VUO 35-16NO7 VUO 35-18NO7	600 1200 1400 1600 1800	125 400	38	85	400	0.85	12	150	4.2	4.8	50	
FUO 50-16N	1600	500	50	90	200 ^{25°C}	tbd	tbd	150	2.1	3.2	84	
VUO 52-08NO1 VUO 52-12NO1 VUO 52-14NO1 VUO 52-16NO1 VUO 52-18NO1 VUO 52-20NO1	800 1200 1400 1600 1800	250 400	54	90	350	0.8	12.5	130	-	1.5	47	See data sheet for pin arrangement Fig. 78 Weight = 17 g
VUO 50-08NO3 VUO 50-12NO3 VUO 50-14NO3 VUO 50-16NO3 VUO 50-18NO3	800 1200 1400 1600 1800	250 400	58	85	500	0.9	6	125	1.62	2.22	44	
VUO 55-12NO7 VUO 55-14NO7 VUO 55-16NO7 VUO 55-18NO7	1200 1400 1600 1800	400 440	58	85	750	0.85	8	150	2.7	3.06	51	Fig. 84 ISOPLUS i4-PAC™ Weight = 9 g
VUO 60-12NO3 VUO 60-14NO3 VUO 60-16NO3 VUO 60-18NO3	800 1400 1600 1800	250 440	72	85	600	0.8	6.5	125	1.2	1.6	44	

3~ Rectifier Bridges, B6U



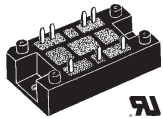
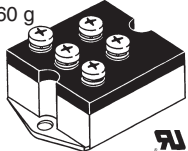
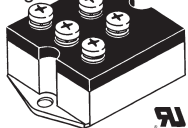
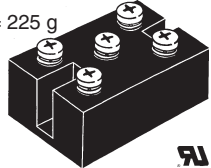
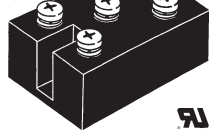
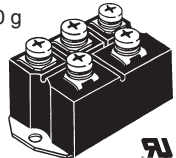
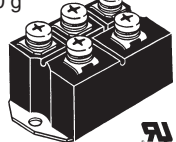
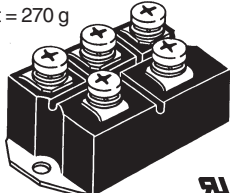
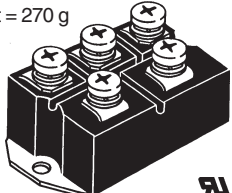
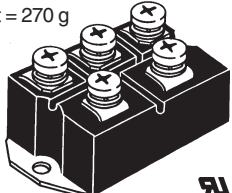

Type	V _{RRM}	V _{VRMS}	I _{dAVM}	T _C	I _{FSM} 45°C 10 ms	V _{TO}	r _T	T _{VJM}	R _{thJC} per Chip	R _{thJH} per Chip	Fig. No.	Package style
□ New	V	V	A	°C	A	V	mΩ	°C	K/W	K/W		Outline drawings on pages O-5...O-17
VUO 62-06NO7	600	125	63	110	550	0.8	8	150	1.45	1.87	53	Fig. 47 Weight = 35 g 
VUO 62-08NO7	800	250										
VUO 62-12NO7	1200	400										
VUO 62-14NO7	1400	440										
VUO 62-16NO7	1600	500										
VUO 62-18NO7	1800	575										
VUO 68-08NO7	800	250	68	100	300	0.8	13	150	1.1	1.6	24	Fig. 51 Weight = 260 g 
VUO 68-12NO7	1200	400										
VUO 68-14NO7	1400	440										
VUO 68-16NO7	1600	500										
VUO 70-08NO7	800	250	70	100	550	0.8	8	150	1.45	1.9	57	
VUO 70-12NO7	1200	400										
VUO 70-14NO7	1400	440										
VUO 70-16NO7	1600	500										
VUO 80-08NO1	800	250	82	T _H = 90°C	600	0.8	7.5	150	-	1.63	47	Fig. 52 Weight = 225 g 
VUO 80-12NO1	1200	400										
VUO 80-14NO1	1400	440										
VUO 80-16NO1	1600	500										
VUO 80-18NO1	1800	575										
VUO 82-06NO7	600	125	88	110	750	0.8	5	150	1.1	1.52	53	
VUO 82-08NO7	800	250										
VUO 82-12NO7	1200	400										
VUO 82-14NO7	1400	440										
VUO 82-16NO7	1600	500										
VUO 82-18NO7	1800	575										
VUO 85-08NO7	800	250	85	100	750	0.8	6	150	1.3	1.6	57	Fig. 53 Weight = 160 g 
VUO 85-12NO7	1200	400										
VUO 85-14NO7	1400	440										
VUO 85-16NO7	1600	500										
VUO 86-08NO7	600	125	86	90	530	0.8	7.5	150	1.2	1.5	24	
VUO 86-12NO7	1200	400										
VUO 86-14NO7	1400	440										
VUO 86-16NO7	1600	500										
VUO 98-08NO7	800	250	95	85	750	0.8	8	150	1.0	1.4	25	Fig. 54 Weight = 270 g 
VUO 98-12NO7	1200	400										
VUO 98-14NO7	1400	440										
VUO 98-16NO7	1600	500										
VUO 100-08NO7	800	250	100	100	1000	0.8	5	150	1.12	1.5	57	
VUO 100-12NO7	1200	400										
VUO 100-14NO7	1400	440										
VUO 100-16NO7	1600	500										
VUO 105-12NO7	1200	400	160	85	1500	0.8	5	150	0.83	1.13	52	
VUO 105-14NO7	1400	440										
VUO 105-16NO7	1600	500										
VUO 105-18NO7	1800	575										
VUO 110-08NO7	800	250	127	110	1200	0.8	4	150	0.90	1.08	54	Fig. 57 Weight = 100 g 
VUO 110-12NO7	1200	400										
VUO 110-14NO7	1400	440										
VUO 110-16NO7	1600	500										
VUO 110-18NO7	1800	575										

Fig. 24 ECO-PAC 1
Weight = 19 g



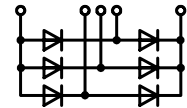
See data sheet for pin arrangement

Fig. 25 ECO-PAC 2
Weight = 24 g



See data sheet for pin arrangement

3~ Rectifier Bridges, B6U



Type	V_{RRM}	V_{VRMS}	I_{dAVM}	T_C	I_{FSM} 45°C 10 ms	V_{T0}	r_T	T_{VJM}	R_{thJC} per Chip	R_{thJH} per Chip	Package style
□ New	V	V	A	°C	A	V	mΩ	°C	K/W	K/W	Fig. No. Outline drawings on pages O-5...O-17
VUO 120-12NO1 VUO 120-16NO1	1200 1600	1200 1600	121	75	650	0.8	6.1	150	1.0	1.3	48 Fig. 48 V2-Package Weight = 80 g
□ VUO 121-16NO1	1600	575	118	100	650	0.8	5	150	1.1	0.1	81
VUO 122-08NO7 VUO 122-12NO7 VUO 122-14NO7 VUO 122-16NO7 VUO 122-18NO7	800 1200 1400 1600 1800	250 400 440 500 575	125	95	900	0.8	4	150	0.8	1.25	25
VUO 155-12NO1 VUO 155-16NO1	1200 1600	1200 1600	157	75	850	0.75	4.6	150	0.8	1.1	48
VUO 160-08NO7 VUO 160-12NO7 VUO 160-14NO7 VUO 160-16NO7 VUO 160-18NO7	800 1200 1400 1600 1800	250 400 440 500 575	175	110	1800	0.8	3	150	0.65	0.83	54
VUO 125-12NO7 VUO 125-14NO7 VUO 125-16NO7 VUO 125-18NO7	1200 1400 1600 1800	400 440 500 575	166	85	1800	0.8	3	150	0.83	1.13	52
VUO 190-08NO7 VUO 190-12NO7 VUO 190-14NO7 VUO 190-16NO7 VUO 190-18NO7	800 1200 1400 1600 1800	250 400 440 500 575	248	110	2800	0.8	2.2	150	0.45	0.6	54

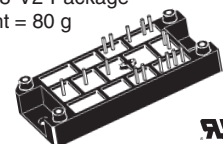


Fig. 52
Weight = 225 g

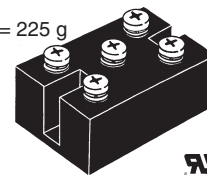


Fig. 54
Weight = 270 g

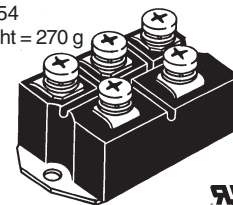


Fig. 81
Weight = 180 g

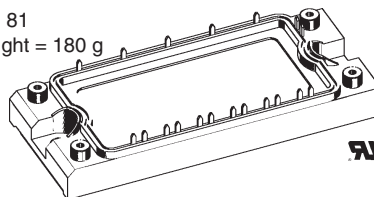


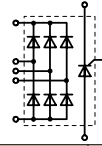
Fig. 25 ECO-PAC 2
Weight = 24 g



See data sheet for pin arrangement

3~ Rectifier Bridges

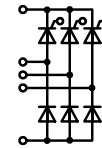
3~ Rectifier Bridges with Fast Diodes ($t_{rr} = 1.5 \mu s$) and Integrated Softstart Thyristor



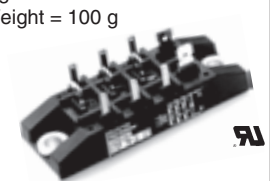
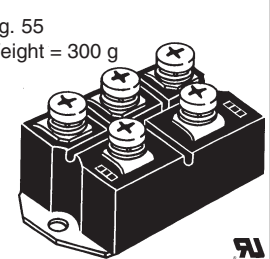
Type	V_{RRM} V	V_{VRMS} V	I_{dAVM} A	T_H °C	I_{FSM} 45°C 10 ms A	V_{TO} V	r_T mΩ	T_{VJM} °C	R_{thJC} per Chip K/W	R_{thJH} per Chip K/W	Fig. No.	Package style Outline drawings on pages O-5...O-17
VUC 25-12go2	1200	400	25	85	300	1.2	18	125	2.3	2.9	45	Fig. 45 Weight = 28 g
VUC 25-14go2	1400	440		Diode								
VUC 25-16go2	1600	500		Thyristor								
VUC 36-12go2	1200	400	34	85	300	1.2	16	125	1.4	2.0		
VUC 36-14go2	1400	440		Diode	400	0.85	10	125	0.9	1.1		
VUC 36-16go2	1600	500		Thyristor								



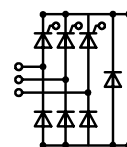
3~ Half Controlled Rectifier Bridges, B6HK



Type	V_{RRM} V	V_{VRMS} V	I_{dAV} $T_H = 100^\circ C$ A	I_{FSM} 45°C 10 ms A	V_{TO} V	r_T mΩ	T_{VJM} °C	R_{thJC} per Chip K/W	R_{thJH} per Chip K/W	Fig. No.	Package style
□ New	V	V	A	A	V	mΩ	°C	K/W	K/W	Fig. No.	Package style
VVZ 12-12io1	1200	400	15	110	1.1	30	125	2.5	3.1	45	See data sheet for pin arrangement
VVZ 12-14io1	1400	440									
VVZ 12-16io1	1600	500									
VVZ 24-12io1	1200	400	21	300	1.0	16	125	2.1	2.7	45	Fig. 55 Weight = 300 g
VVZ 24-14io1	1400	440									
VVZ 24-16io1	1600	500									
□ VVZ 39-08ho7	800	250	$T_C = 85^\circ C$	200	0.85	27	125	1.3	1.8	24	Fig. 57 Weight = 100 g
□ VVZ 39-12ho7	1200	400									
VVZ 40-12io1	1200	400	34	320	0.85	15	125	1.0	1.6	45	Fig. 55 Weight = 300 g
VVZ 40-14io1	1400	440									
VVZ 40-16io1	1600	500									
VVZ 70-08io7	800	250	$T_C = 85^\circ C$	550	0.85	11	125	0.9	1.1	57	Fig. 57 Weight = 100 g
VVZ 70-12io7	1200	400									
VVZ 70-14io7	1400	440									
VVZ 70-16io7	1600	500									
VVZ 110-12io7	1200	400	$T_C = 85^\circ C$	110	0.85	6	125	0.65	0.80	55	Fig. 57 Weight = 100 g
VVZ 110-14io7	1400	440									
VVZ 175-12io7	1200	400	$T_C = 85^\circ C$	1500	0.85	3.5	125	0.46	0.55	57	Fig. 57 Weight = 100 g
VVZ 175-14io7	1400	440									
VVZ 175-16io7	1600	500									



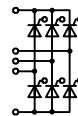
3~ Half Controlled Rectifier Bridges with free wheeling diode, B6HKF



Type	V_{RRM} V	V_{VRMS} V	I_{dAV} $T_C = 85^\circ C$ A	I_{FSM} 45°C 10 ms A	V_{TO} V	r_T mΩ	T_{VJM} °C	R_{thJC} per Chip K/W	R_{thJH} per Chip K/W	Fig. No.
VVZF 70-08io7	800	250	70	550	0.85	11	125	0.9	1.1	57
VVZF 70-12io7	1200	400								
VVZF 70-14io7	1400	440								
VVZF 70-16io7	1600	500								

Data according to IEC 60747 and refer to a single diode or thyristor unless otherwise stated.

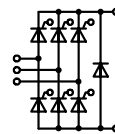
3~ Rectifier Bridges



3~ Full Controlled Rectifier Bridges, B6C

Type	V_{RRM}	V_{VRMS}	I_{dAV} $T_C=100^\circ\text{C}$	I_{TSM} 45°C 10 ms	V_{T0}	r_T	T_{VJM}	R_{thJC} per Chip	R_{thJH} per Chip	Fig. No.	Package style
□ New	V	V	A	A	V	mΩ	°C	K/W	K/W		Outline drawings on pages O-5...O-17
VTO 39-06ho7	600	125	39	200	0.85	27	125	1.3	1.8	24	<p>Fig. 55 Weight = 300 g</p>
VTO 39-08ho7	800	250	$T_C = 85^\circ\text{C}$								
VTO 39-12ho7	1200	400									
VTO 70-08io7	800	250	$T_C = 85^\circ\text{C}$	550	0.85	11	125	0.9	1.1	57	
VTO 70-12io7	1200	400									
VTO 70-14io7	1400	440									
VTO 70-16io7	1600	500									
VTO 110-12io7	1200	400	110	1150	0.85	6	125	0.65	0.80	55	
VTO 110-14io7	1400	440									
VTO 175-12io7	1200	400	167	1500	0.85	3.5	125	0.46	0.55		
VTO 175-14io7	1400	440									
VTO 175-16io7	1600	500									

3~ Full Controlled Rectifier Bridge with free wheeling diode, B6CF

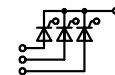


VTOF 70-08io7	800	250	$T_C = 85^\circ\text{C}$	550	0.85	11	125	0.9	1.1	57
VTOF 70-12io7	1200	400								
VTOF 70-14io7	1400	440								
VTOF 70-16io7	1600	500								

Fig. 57
Weight = 100 g



Three Thyristor Module M3CK



VYK 70-08io7	800	250	$I_{FAVM} = 28\text{ A}$ $T_C = 85^\circ\text{C}$	550	0.85	11	125	0.9	1.1	57
VYK 70-12io7	1200	400								
VYK 70-14io7	1400	440								
VYK 70-16io7	1600	500								

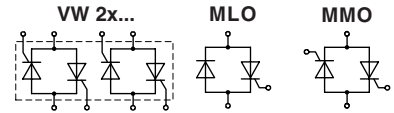
Fig. 24 ECO-PAC 1
Weight = 19 g





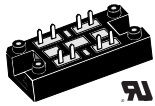
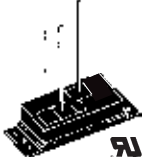
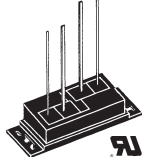
See data sheet for pin arrangement

also available with common anode connection

AC Controller 1~ / 2~ / 3~



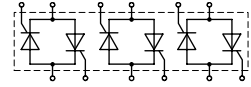
$I_{RMS} = 30 - 230 \text{ A}$

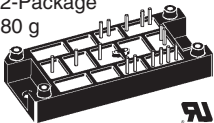


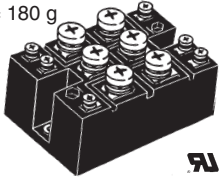
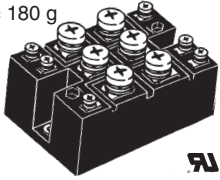
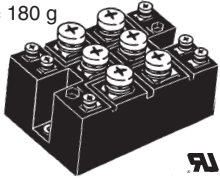
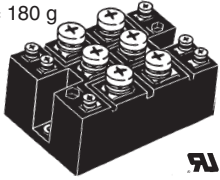
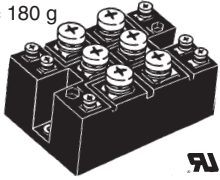
Type	V_{RRM}	V_{VRMS}	I_{RMS} $T_c = 85^\circ\text{C}$	I_{TSM} 45°C 10 ms	V_{TO}	r_T	T_{VJM}	R_{thJC} per Chip	R_{thJH} per Chip	Fig. No.	Package style		
□ New	V	V	A	A	V	mΩ	°C	K/W	K/W		Outline drawings on pages O-5...O-17		
1~	MLO 36-12io1 MLO 36-16io1	1200 1600	400 500	1x42	360	0.85	15	125	1.3	1.5	60	Fig. 25 ECO-PAC 2 Weight = 24 g 	
	MLO 75-12io1 MLO 75-16io1	1200 1600	400 500	1x100	1150	0.85	5	125	0.55	0.75			
	MLO 110-08io7 MLO 110-12io7 MLO 110-14io7	800 1200 1400	250 400 440	112	1000	0.85	5.6	150	0.8	0.92	24		See data sheet for pin arrangement
	MLO 140-08io7 MLO 140-12io7 MLO 140-16io7	800 1200 1600	250 400 500	130	1150	0.85	5.2	150	0.7	0.82		Fig. 12 SOT-227B miniBLOC Weight = 30 g 	
	MLO 175-08io7 MLO 175-12io7 MLO 175-16io7	800 1200 1600	250 400 500	175	1500	0.85	3.7	150	0.5	0.62			
	MLO 230-08io7 MLO 230-12io7 MLO 230-14io7 MLO 230-16io7 MLO 230-18io7	800 1200 1400 1600 1800	250 400 440 500 575	230	2250	0.8	2.4	125	0.26	0.46	25		
	2~	MMO 36-12io1 MMO 36-16io1	1200 1600	400 500	1x42	360	0.85	15	125	1.3	1.5	61	Fig. 47 Weight = 35 g 
		MMO 75-12io1 MMO 75-16io1	1200 1600	400 500	1x103	1150	0.85	5	125	0.55	0.75		
		MMO 62-12io6 MMO 62-16io6	1200 1600	400 500	1x58	400	0.85	12	125	0.91	0.98	12	Fig. 60 Weight = 15 g 
		MMO 74-12io6 MMO 74-16io6	1200 1600	400 500	1x82	600	0.85	8.4	125	0.71	0.85		
		MMO 90-12io6 MMO 90-14io6 MMO 90-16io6	1200 1400 1600	400 440 500	90 $T_c = 110^\circ\text{C}$	800	0.85	8	150	0.6	0.7		
		MMO 110-08io7 MMO 110-12io7 MMO 110-14io7	800 1200 1400	250 400 440	112	1000	0.85	5.6	150	0.8	0.92	24	Fig. 61 Weight = 15 g 
		MMO 140-08io7 MMO 140-12io7 MMO 140-16io7	800 1200 1600	250 400 500	130	1150	0.85	5.2	150	0.7	0.82		
		MMO 175-08io7 MMO 175-12io7 MMO 175-16io7	800 1200 1600	250 400 500	175	1500	0.85	3.7	150	0.5	0.62		
		MMO 230-08io7 MMO 230-12io7 MMO 230-14io7 MMO 230-16io7 MMO 230-18io7	800 1200 1400 1600 1800	250 400 440 500 575	230	2250	0.8	2.4	125	0.26	0.46	25	
		2~	VW 2x30-08io1 VW 2x30-12io1 VW 2x30-14io1 VW 2x30-16io1	800 1200 1400 1600	250 400 440 500	2x30	200	0.8	25	125	1.7	2.0	47
	VW 2x45-08io1 VW 2x45-12io1 VW 2x45-14io1 VW 2x45-16io1		800 1200 1400 1600	250 400 440 500	2x45	300	0.85	15	125	1.25	1.55		
	VW 2x60-08io1 VW 2x60-12io1 VW 2x60-14io1 VW 2x60-16io1		800 1200 1400 1600	250 400 440 500	2x60	520	0.85	11	125	0.92	1.22		

AC Controller 1~ / 2~ / 3~

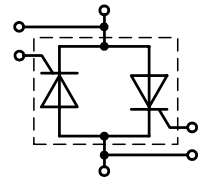
$I_{RMS} = 39 - 143 \text{ A}$

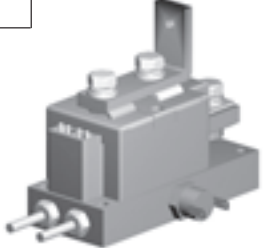
vwo



Type	V_{RRM}	V_{VRMS}	I_{RMS} $T_C = 85^\circ\text{C}$	I_{TSM} 45°C 10 ms	V_{TO}	r_T	T_{VJM}	R_{thJC} per Chip	R_{thJH} per Chip	Fig. No.	Package style	
□ New	V	V	A	A	V	mΩ	°C	K/W	K/W		Outline drawings on pages O-5...O-17	
3	VWO 35-06ho7	600	125	3x35	200	0.85	27	125	1.3	1.8	24	Fig. 48 V2-Package Weight = 80 g 
	VWO 35-08ho7	800	250									
	VWO 35-12ho7	1200	400									
	VWO 36-08io7	800	250	3x39	320	0.85	13	125	1.3	1.5	62	Fig. 62 Weight = 100 g 
	VWO 36-12io7	1200	400									
	VWO 36-14io7	1400	440	$T_H = 85^\circ\text{C}$								
	VWO 36-16io7	1600	500									
	VWO 40-08io7	800	250	3x40	400	0.85	15	125	1.43	1.53	63	Fig. 24 ECO-PAC 1 Weight = 19 g 
	VWO 40-12io7	1200	400									
	VWO 40-14io7	1400	440									
	VWO 40-16io7	1600	500									
	VWO 50-08io7	800	250	3x50	520	0.85	11	125	1.2	1.31	63	See data sheet for pin arrangement Fig. 63 Weight = 180 g 
VWO 50-12io7	1200	400										
VWO 50-14io7	1400	440										
VWO 50-16io7	1600	500										
VWO 60-08io7	800	250	3x60	550	0.85	11	125	0.9	1.1	62	Fig. 63 Weight = 180 g 	
VWO 60-12io7	1200	400										
VWO 60-14io7	1400	440										
VWO 60-16io7	1600	500										
VWO 85-08io1	800	250	3x83	520	0.85	11	150	0.92	1.22	48	See data sheet for pin arrangement Fig. 63 Weight = 180 g 	
VWO 85-12io1	1200	400										
VWO 85-14io1	1400	440										
VWO 85-16io1	1600	500										
VWO 80-08io7	800	250	3x82	1000	0.85	5.2	125	0.81	1.0	63	See data sheet for pin arrangement Fig. 63 Weight = 180 g 	
VWO 80-12io7	1200	400										
VWO 80-14io7	1400	440										
VWO 95-08io7	800	250	3x96	1150	0.85	4.8	125	0.66	0.93	63		
VWO 95-12io7	1200	400									See data sheet for pin arrangement Fig. 63 Weight = 180 g 	
VWO 95-14io7	1400	440										
VWO 140-08io1	800	250	3x143	1150	0.85	5.2	150	0.6	0.7	48		
VWO 140-12io1	1200	400										
VWO 140-14io1	1400	440										
VWO 140-16io1	1600	500										

1~ AC Controller with isolated Water Cooling



Type	V_{RRM}	V_{VRMS}	I_{RMS} $T_{water} = 17^\circ\text{C}$ 4l/min	I_{TSM} 45°C 10 ms	V_{TO}	r_T	T_{VJM}	R_{thJW} per Chip 4l/min K/W	Fig. No.	Package style	
	V	V	A	A	V	mΩ	°C	K/W		Outline drawings on pages O-5...O-17	
1	HVL 900-12io1	1200	400	900	9200	0.8	0.68	140	0.203	69	Fig. 69 Weight = 1300 g 
	HVL 900-14io1	1400	440								
	HVL 900-16io1	1600	500								
	HVL 900-18io1	1800	590								

Number	Pin Connections	Features	Application	PKG	Absolute Maximum Ratings				Electrical Characteristics	
					BV (Vr.m.s)	If (mA)	V _{CEO} (V)	I _c (mA)	CTR (%)	t _r , t _f (us) TYP.

Singel Transistor output																							
PS2501		VDE, UL	Power supply, Telephone, FAX, OA equipment, Programmable Logik Controller	4 pin DIP	5K	80	80	50	80-600 K, L, M, D, H, W, Q	3,5 @RL=100ohm													
PS2501L		leadform																					
PS2501A		VDE; UL; Semko Demko; BSI		4 pin DIP							30	70	30	50-400 H, W, Q, L	5,7 @RL=100ohm								
PS2501AL				leadform																			
PS2561		VDE; UL; Semko Demko; BSI		4 pin DIP							80	80	50	80-400 L, M, D, H, W	3,5 @RL=100ohm								
PS2561L				leadform																			
PS2561A		VDE; UL; Semko, Demko; BSI		4 pin DIP							30	70	30	50-300 H, Q, W	5,7 @RL=100ohm								
PS2561AL				leadform																			
PS2581		long creepage 8mm / leadform 12 mm VDE; UL; Semko Demko; BSI		4 pin DIP							80	80	50	80-400 L, M, D, H, W	3,5 @RL=100ohm								
PS2581L2				leadform																			
PS2701		VDE, UL		VDE, UL, higher VCE							Power supply, Telephone, FAX, OA equipment, Programmable Logik Controller / DC converter	4-SOP pitch 2,54mm	3,75K	50	40	80	50-300 P, L, M	5,7 @RL=100ohm					
PS2701A																			30	30			
PS2703																					50	120	30
PS2711																			low input current, high CTR; VDE, UL,	40			
PS2801	VDE option		50		80	50	80-600 K, P, L	3,5 @RL=100ohm															
PS2801A									Low input current, high CTR, VDE, UL	30									70	30	50-400 P, L	5,7 @RL=100ohm	
PS2811	Low input current, high CTR, VDE, UL		50		40	40	100-400 K, L, M	4,5 @RL=100 ohm															
PS2911									Low input current high CTR	ultra flat									50	40	40	100-400 K, L, M	5,10 @RL=100ohm
PS2501-4	VDE; UL		Power supply, Telephone, FAX, OA equipment		16pin DIP	5K	80	80															
PS2501L-4									leadform														
PS2801-4		Single Tr.(Standard), Pin pitch :1.27 mm; UL, VDE	PLC, Hybrid IC, Power supply, OA, Measuring instrument, Communication devices	16 SSOP pitch 1,27mm	2,5k	50	80	50	80-600	3,5 @RL=100ohm													
PS2801A-4											low input current, high CTR, VDE; UL	2,5K	30	70	30	40-400	5,7 @RL=100ohm						
PS2811-4																		low input current, high CTR, VDE; UL	2,5	50	40	40	100-400
PS2841-A		Single Tr.(Standard), High CTR Cathode, collector common; UL	PLC, Hybrid IC, Power supply, OA, Measuring instrument, Modem, Communication devices	12 SSOP pitch 0,8mm	1,5	20	70	20	100-400 (IF=1mA)	ton, toff(us) TYP. 20, 110 (RL=5kohm)													
PS2841-B												Single Tr.(Standard), High CTR Anode, collector common; UL	12 SSOP small pitch 0,8	1,5	20	70	20	100-400 (IF=1mA)	ton, toff(us) TYP. 20, 110 (RL=5kohm)				

CTR: PS25XX Singel Serie K=300-600; L=200-400; M=80-240; D=100-300; H=80-160; W=130-260; Q=100-200;
 CTR: PS2701Serie; PS2703 P=150-300; L=100-300; M=50-150; K=200-400
 CTR: PS2711Serie CTR: K=200-400; L=150-300; M=100-400
 PS2801Serie K=300-600; P=150-300; L=100-300
 CTR: PS2811Serie; PS2911 K=200-400; L=150-300; M=100-200
 PSxxxx A / for new Design
 110 Grad on request

Darlington Transistor output														
PS2502		Darlington Tr (Standard)	Power supply, Telephone, FAX, equipment Measuring instrument, Modem,	4 pin DIP	5k	80	40	200	200-2000	100,100 @RL=100				
PS2502L				leadform										
PS2702				VDE option,							4-SOP	3,75K	50	200
PS2802				VDE option,							4-SSOP	2K	50	90
PS2502-4		Darlington Tr (Standard)	Power supply, Telephone, FAX, equipment Measuring instrument, Modem,	16 pin DIP	5K	80	40	160	up to 200	100,100 @RL=100				
PS2502L-4				leadform										
PS2802-4				Pin pitch: 1.27 mm							16 SSOP	2,5k	50	100

Number	Pin Connections	Features and Cross opportunities	Application	PKG	Absolute Maximum Ratings				Electrical Characteristics	
					BV (Vr.m.s)	IF (mA)	V _{CEO} (V)	IC (mA)	CTR (%)	t _r ,t _f (us) TYP.

AC - Input Singel Transitor output											
PS2505-1		Single Tr.(AC Input), High isolation voltage, High VCEO , UL	Power supply, Hybrid IC, Information, Measuring instrument, Communication device, Modem	4 pin Dip	5k	±80	80	50	80-600	3,5 @RL=100ohm	
PS2505L-1				leadform							
PS2705		Single Tr.(AC Input) UL, VDE(option), BSI		4-SOP pitch 2,54mm	3,75k	±50	40	80	50-300	3,5 @RL=100ohm	
PS2705A						±30	70	30	50-300	5,7 @RL=100ohm	
PS2707						(Low Input Current), High VCEO(120V) UL, VDE(option),	±50	120	30	50-400	10,10 @RL = 1Kohm
PS2715		Single Tr.(AC Input), Pin pitch :1.27 mm UL, VDE(option), BSI,		Low input current, High CTR UL,VDE(option)	4-SSOP pitch 1,27 mm	2,5K	±50	80	50	80-600	3,5 @RL=100ohm
PS2805							±30	70	30	50-400	5,7 @RL=100ohm
PS2805A							±50	40	40	100-400	4,5 @RL=100ohm
PS2815							Low input current, High CTR UL,VDE(option)	±50	40	40	100-400
PS2915	Low input current, High CTR	ultra flat	±50	40	40	100-401	5,10 @RL=1Kohm				
PS2505-4		Singel Tr ; AC Input; UL ; VDE	Power supply, Telephone, FAX, OA equipment	16 pin DIP	5K	80	80	50	80 - 600	3.5 @RL = 100 ohm	
PS2505L-4		Pin pitch:1.27 mm	Measuring instrument, Modem Communication	leadform							
PS2805-4		Pin pitch: 1.27 mm		16 SSOP	2,5k	50	80	50	80 - 600	200,200@RL=100	
PS2815-4	2,5K		50		40	40	100 - 400	4,5 @RL = 100 ohm			
PS2845-4A		Single Tr.(AC Input), High CTR, Anode, Cathode, Collector common, Pin pitch :0.8mm	PLC, Hybrid IC, Power supply, OA, Measuring instrument, Modem, Communication devices	12 SSOP Small pitch 0,8	1,5	20	70	20	100-400 (IF=1mA) VCE 0,4V	ton,toff(us)TYP. 20, 110 (RL=5kohm)	

AC - Input Darlington Transitor output										
PS2506		Darlington Tr.(AC Input), High isolation voltage, High CTR , UL	Power supply, Hybrid IC, Information, Measuring instrument, Modem, Communication devices	4 pin Dip	5k	±80	40	200	up to 200	100,100 @RL=100
PS2506L				leadform						
PS2706		Darlington Tr.(AC Input)		4-SOP	3,75K	±50	200	200,200 @RL=200		
PS2806		Darlington Tr.(AC Input)		4-SSOP	2,5K	±50	90			
PS2506-4		Darlington Trans. AC-Input (Standard) UL ; VDE ; High CTR	Power supply, Telephone, FAX, OA equipment	16 pin DIP	5K	80	40	160	up to 200	100,100 @RL=100
PS2506L-4		Pin pitch: 1.27 mm	leadform							
PS2806-4		Pin pitch: 1.27 mm	Measuring instrument, Modem	16 SSOP	2,5k	50	40	100	up to 200	200,200 @RL=100

High VCE										
PS2532		Darlington Tr. High isolation voltage, High VCEO(300V) UL; VDE	DC-DC converter, Power supply, PLC, Modem, Communication devices	4 pin Dip	5k	80	300	150	1500-6500	100,100 @RL=100
PS2532L				leadform						
PS2732		Darlington Tr. High VCEO(300V)		4-SOP	2,5K	50	300	150	up to 1500	100,100 @RL=100
PS2832		Darlington Tr. High VCEO(300V) cross: PC4H520		4-SSOP	2,5K	50	300	60	400-4500	20,5 @RL=100
PS2932		Darlington Tr. VCEO(300V)		ultra flat	2,5K	50	300	60	400-4501	20,5 @RL=100
PS2532-4		Darlington Trans. High collector emitter UL ; VDE ; High CTR	Power supply, Telephone, FAX, OA equipment	16 pin DIP	5K	80	300	150	1500-6500 IF = 1mA	100,100 @RL=100
PS2532L-4		Pin pitch: 1.27 mm	leadform							
PS2832-4		Pin pitch: 1.27 mm	Measuring instrument, Modem	16 SSOP	2,5k	50	300	60	400 - 4500	20,5 @RL=100



Photocoupler

IC OUTPUT TYPE • HIGH-SPEED (200 kbps, ANALOG OUTPUT)

Part Number	Pin Connections	Features	Absolute Maximum Ratings			Electrical Characteristics	
			BV (kVr.m.s.)	V _{CC} (V)	I _O (mA)	CTR (%)	t _{PLH} , t _{PLL} (μs) MAX.
PS8103		UL, VDE (Option) approved 5-pin SOP	2.5	15	8	10 to 30 (I _F = 16 mA, V _{CC} = 4.5 V, V _O = 0.4 V)	5 (R _L = 4.1 kΩ) 15 (R _L = 20 kΩ)














IC OUTPUT TYPE • HIGH-SPEED (1 Mbps, ANALOG OUTPUT)

Part Number	Pin Connections	Features	Absolute Maximum Ratings			Electrical Characteristics	
			BV (kVr.m.s.)	V _{CC} (V)	I _O (mA)	CTR (%)	t _{PLH} , t _{PLL} (μs) MAX.
PS8601 PS8601L		8-pin DIP Base connection UL, VDE (Option), BSI approved	5	35	8	15 or above (I _F = 16 mA, V _{CC} = 4.5 V, V _O = 0.4 V)	0.8 (R _L = 1.9 kΩ)
PS8602 PS8602L		8-pin DIP Base nonconnection High CMR (2 kV/μs) UL, VDE (Option), BSI approved					
PS8101		5-pin SOP High CMR (10 kV/μs) UL, VDE (Option) approved	2.5			15 to 35 (I _F = 16 mA, V _{CC} = 4.5 V, V _O = 0.4 V)	0.8/1.2 (R _L = 2.2 kΩ)
PS8802-1		SO-8 High CMR (10 kV/μs)				15 to 45 (I _F = 16 mA, V _{CC} = 4.5 V, V _O = 0.4 V)	
PS8802-2		UL, VDE (Option) approved					

IC OUTPUT TYPE • HIGH-SPEED (1 Mbps, DIGITAL OUTPUT)

Part Number	Pin Connections	Features	Absolute Maximum Ratings			Electrical Characteristics			
			BV (kVr.m.s.)	V _{CC} (V)	I _O (mA)	I _{PHL} , I _{PLH} (mA) MAX.	CM _L , CM _H (kV/μs) MIN.	t _{PHL} , t _{PLH} (μs) MAX.	t _{PHL} -t _{PLH} (μs) MAX.
PS9613 PS9613L		8-pin DIP IPM driver UL, VDE (Option) approved	5	35	15	5.0	15	0.5/0.75 (R _L = 20 kΩ)	0.65 (R _L = 20 kΩ)
PS9113		5-pin SOP IPM driver UL, VDE (Option) approved							
PS9213		5-pin SOP IPM driver Air distance: 5.5 mm UL, VDE (Option) approved							

IC OUTPUT TYPE · HIGH-SPEED (10 Mbps, OPEN COLLECTOR OUTPUT)

Part Number	Pin Connections	Features	Absolute Maximum Ratings			Electrical Characteristics			
			BV (kVr.m.s.)	V _{cc} (V)	I _{in} (mA)	I _{OH} , (mA) MAX.	C _{MH} , C _{ML} (kV/μs) MIN.	t _{FHL} , t _{PLH} (ns) MAX.	(t _{FHL} -t _{PLH}) (ns) MAX.
PS9614 PS9614L		8-pin DIP Open collector output	5	7	25	5.0	10	75 (R _L = 350 Ω)	50 (R _L = 350 Ω)
PS9617 PS9617L		UL, VDE (Option) approved							35 (R _L = 350 Ω)
PS9114		5-pin SOP Open collector output UL, VDE (Option) approved							50 (R _L = 350 Ω)
PS9117		5-pin SOP Open collector output UL, VDE (Option) approved							35 (R _L = 350 Ω)
PS9121		5-pin SOP Open collector output V _{cc} 3.3 V drive UL, VDE (Option) approved							
PS9814-1		SO-8 Open collector output					10		50 (R _L = 350 Ω)
PS9814-2		UL, VDE (Option) approved							
PS9817-1							15		35 (R _L = 350 Ω)
PS9817-2									
PS9821-1		SO-8 Open collector output V _{cc} 3.3 V drive							
PS9821-2		UL, VDE (Option) approved							
PS9687L1 PS9687L2		8-pin DIP Creepage distance : 8 mm Open collector output UL, VDE (Option) approved	5				10		50 (R _L = 350 Ω)
PS9214		5-pin SOP Air distance: 5.5 mm Open collector output UL, VDE (Option) approved	2.5						

IC OUTPUT TYPE • HIGH-SPEED (10 Mbps, TOTEM POLE OUTPUT)

Part Number	Pin Connections	Features	Absolute Maximum Ratings			Electrical Characteristics			
			BV (kVr.m.s.)	V _{CC} (V)	I _O (mA)	I _{FH} (mA) MAX.	CM _H , CM _L (kV/μs) MIN.	t _{PHL} , t _{PLH} (ns) MAX.	[t _{PHL} -t _{PLH}] (ns) MAX.
PS9115		5-pin SOP Totem pole output UL, VDE (Option) approved	2.5	7	13	5.0	10	65	50

IC OUTPUT TYPE • HIGH-SPEED (15 Mbps, CMOS OUTPUT)

Part Number	Pin Connections	Features	Absolute Maximum Ratings			Electrical Characteristics			
			BV (kVr.m.s.)	V _{CC} (V)	I _O (mA)	I _{FH} (mA) MAX.	CM _H , CM _L (kV/μs) MIN.	t _{PHL} , t _{PLH} (ns) MAX.	[t _{PHL} -t _{PLH}] (ns) MAX.
PS9851-1		8-pin SOP CMOS output T _A = -40 to +100°C UL, VDE (Option) approved	2.5	0 to 5.5	2	6	10	60	30
PS9851-2									

DIODE OUTPUT TYPE • HIGH LINEARITY

Part Number	Pin Connections	Features	Absolute Maximum Ratings			Electrical Characteristics	
			BV (kVr.m.s.)	V _F (Diode) (V)	V _F (Photo Diode) (V)	K ₁ , K ₂ (%)	K ₃
PS9741		16-pin SSOP High Linearity UL, BS1 (Supplementary insulation) approved	1.5	3	20	0.3 to 1.0 to 1.8	0.75 to 1.0 to 1.25

Short Main Crosslist Optocoupler

NEC



Case	Photocoupler	ISOCOM	NEC	Sharp	Toshiba	Infineon	Fairchild	Agilent
4 pin Dip	Transistor output		PS2501 /-2561	PC817 / -123	TLP521 /TLP620	SFH615 / 618	H11A817	
			PS2501-4	PC847	TL521-4	ILQ615-1		
	Transistor output leadforming (SMD)		PS2501L/- 2561L	PC817I / -123	TLP521S	SFH6156	H11A817S	
	AC input		PS2505	PC814		SFH620 / 628	H11A814	
			PS2505-4	PC844		ILQ620		
	AC input leadforming (SMD)		PS2505L	PC814I		SFH6286	H11A814S	
	Transistor output high voltage		PS2532	PS852 / -853	TLP532 /TLP627			
	Transistor output high voltage leadf. (SMD)		PS2532L	PS852I / -853I	TLP532S			

SOP	AC Input	IS2705	PS2705-1	PC354NT	TLP180			
	Single Transistor output VCE 40V	IS357	PS2701-1	PC357NT	TLP124			
	Single Transistor output VCE > 70V	IS181	PS2703-1	PC358NT	TLP121/181			
	Single Transistor output high voltage	IS127	PS2732-1	PC452	TLP127			
		IS126	PS2707-1		TLP120 / TLP126			
SOP5	high speed digital		PS9117	PC400 / PC410	TLP113 / TLP115		HCPL263A	HCPL-M600/601/611
SOP5	high speed analog		PS8101	PC417	TLP112A /- 114A		HCPL-M452	HCPL-M452 /453

SSOP 1 fach	AC Input		PS2805-1	PC3H3/ H4	TLP280-1	SFH691		
	Single Transistor output		PS2801-1	PC3H2 / H7	TLP281-1	SFH690		

SSOP 4 fach	AC Input		PS2805-4	PC3Q63Q/- Q64	TLP280-4			
			PS2811-4	PS3Q66Q				
	Single Transistor output		PS2801-4	PS3Q67Q	TLP281-4	SFH6916		

SO8 , 1	high Speed analog (1 Channel)		PS8802-1				HCPL-0452
SO8 , 1			PS8802-1			HCPL-0453	
SO8 , 1			PS8802-1			HCPL-0500	
SO8 , 1			PS8802-1			HCPL-0501	
SO8 , 2	high Speed digital (1 Channel)		PS9817-1				HCPL-0600
SO8 , 2			PS9817-1				HCPL-0601
SO8 , 2			PS9817-1				HCPL-0611
SO8 , 2 , 3	high speed analog (2 Channel)		PS8802-2				HCPL-061A
SO8 , 1			PS8802-2				HCPL-0530
SO8 , 1			PS8802-2				HCPL-0531
SO8 , 1 , 3	high Speed digital (2 Channel)		PS8802-2				HCPL-0534
SO8			PS9814-2				HCPL-0630
SO8			PS9817-2				HCPL-0631
SO8 , 3	Note: 1. Minimum CTR = 15%		PS9817-2				HCPL-063A
SO8 , 3			PS9817-2				HCPL-063N
SO8			PS9817-2				HCPL-0661
SO8	Note: 2. No enable Pin provided		PS9821-1				HCPL-060L
SO8	Note: 3. CMR = 10KV/us min ; 20KV/us typ		PS9821-2				HCPL-063L

Case	OCMOS Solid State Relay	NEC	Matsushita	Toshiba	Infineon	CP-Clare	OKI	
SOP / DIP	MOSFET output		PS7 xxxx	AQW xxxx	TLP59x /TLP79x	LH1 xxxx	LCA xxx / LCB xxx	OCM xxx
			PS7 xxxx	AQY xxxx	TLP197 xx		LAA xxx / IAA xxx	OCMS xxx
			PS7113-1A		TLP595			OCM110
			PS7142-1A		TLP595 G /795 G			
			PS7241-1A		TLP597 A /197 G			
			PS7341C-1A			LH1540	LCA110L	

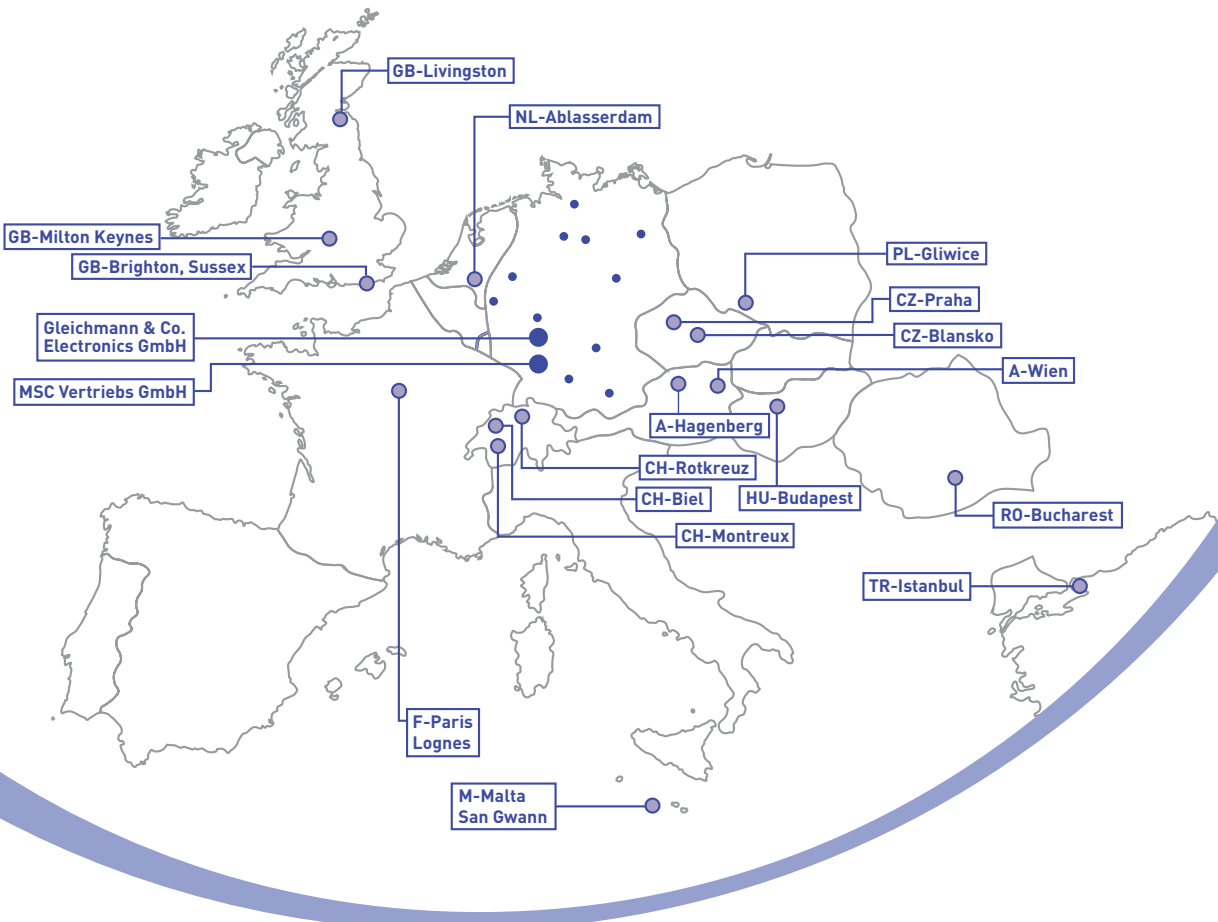
for more information pls ask technical Marketing Gleichmann



ISOCOM make identical equivalents to these and many more competitive parts. PLUS special screens, Lead forms and tape and reel. All ISOCOM products are guaranteed to meet customer-specified electrical characteristics. guaranteed to meet customer-specified electrical characteristics. Parts has the same partnumber as competition and Brand of ISOCOM.

All Manufacturer	VISHAY (INFINEON) (SIEMENS)	FAIRCHILD (MOTOROLA) (QT)	Toshiba	Sharp
ISOCOM 4N25	IL1 SFH615A-1	MOC3009 MOC8050	H11L1	PC844 (IS844)
ISOCOM 4N26	IL2 SFH615A-2	MOC3010 MOC8080	H11L2	PC824 (IS824)
ISOCOM 4N27	IL3 SFH615A-3	MOC3011 MOC8100	H11L3	PC829 (IS829)
ISOCOM 4N28	IL74 SFH615A-4	MOC3012 MOC8101	H11L4	PC849 (IS849)
ISOCOM 4N35	ILD1 SFH617A-1	MOC3020 MOC8102	H11AA1	PC827 (IS827)
ISOCOM 4N36	ILD2 SFH617A-2	MOC3021 MOC8103	H11AA2	PC847 (IS847)
ISOCOM 4N37	ILD5 SFH617A-3	MOC3022 MOC8104	H11AA3	
ISOCOM 4N38	ILD74 SFH617A-4	MOC3023 MOC8106	H11AA4	
ISOCOM 4N39	ILQ1 SFH618A-2	MOC3030 MOC8107	MCT2	
ISOCOM CNX62A	ILQ2 SFH618A-3	MOC3031 MOC8108	MCT2E	
ISOCOM CNX72A	ILQ5 SFH620-1	MOC3032 MOC8112	MCT6	
ISOCOM CNX82A	ILQ74 SFH620-2	MOC3033 CNX72A	MCT61	
ISOCOM CNX83AG	MCA230 SFH620-3	MOC3040 CNX82A	MCT62	
ISOCOM CNY17-1	MCA255 SFH628A-3	MOC3042 H11AV1	MCT210	Special Parts
ISOCOM CNY17-2	SFH600-1 SFH628A-4	MOC3043 H11AV2	MCT270	CNY75A
ISOCOM CNY17-3		MOC3051 H11AV3	MCT271	CNY75B
ISOCOM CNY17-4		MOC3052 H11D1	MCT272	CNY75C
ISOCOM CNY17F-1		MOC3060 H11D2	MCT273	H11J1
ISOCOM CNY17F-2		MOC3061 H11D3	MCT274	H11J2
ISOCOM CNY17F-3		MOC3062 H11D4	MCT275	H11J3
ISOCOM CNY17F-4		MOC3063 H11F1	MCT276	H11J4
ISOCOM H11A1		MOC5007 H11F2	MCT277	H11J5
ISOCOM H11A2		MOC5008 H11F3	MCT2200	
ISOCOM H11A3		MOC5009 H11G1	MCT2201	
ISOCOM H11A4		MOC8021 H11G2		
ISOCOM H11A5		MOC8030 H11G3		
			Suffix	
			GB - 100%CTR	
			BL - 200% CTR	

Note: all parts UL listed , most parts with VDE ; also leadforming (SMD) & wide spread (10,16mm) ; and CTR Selection possible All products to Pb-free versions & are RoHS conform



Please copy and fax to +49 7249 910-126

Name/Surname		Phone	
Company		Fax	
Department		E-Mail	
Address		Branch	
ZIP/City		Company Size	

Head Office

MSC Vertriebs GmbH
 Industriestraße 16
 76297 Stutensee
 Phone +49 7249 910 - 0
 Fax +49 7249 79 93
 Stutensee@msc-ge.com

Gleichmann & Co. Electronics GmbH
 Schraderstraße 44
 67227 Frankenthal
 Phone +49 6233 347-0
 Fax +49 6233 347-210
 Frankenthal@msc-ge.com

Sales Offices Germany

Berlin
 Phone +49 30 720089 - 0
 Fax +49 30 720089 - 20
 Berlin@msc-ge.com

Hamburg
 Phone +49 4106 7764 - 0
 Fax +49 4106 7764 - 88
 Hamburg@msc-ge.com

Hannover
 Phone +49 511 616847 - 0
 Fax +49 511 616847 - 70
 Hannover@msc-ge.com

Braunschweig
 Phone +49 5341 2999 - 0
 Fax +49 5341 292043
 Braunschweig@msc-ge.com

Duesseldorf
 Phone +49 211 92593 - 0
 Fax +49 211 92593 - 88
 Duesseldorf@msc-ge.com

Wiesbaden
 Phone +49 611 97320 - 0
 Fax +49 611 97320 - 88
 Wiesbaden@msc-ge.com

Frankenthal
 Phone +49 6233 344-0
 Fax +49 6233 344-210
 Frankenthal@msc-ge.com

Stuttgart
 Phone +49 711 78336 - 0
 Fax +49 711 78336 - 210
 Stuttgart@msc-ge.com

Munich
 Phone +49 89 945532 - 0
 Fax +49 89 945532 - 90
 MSC.Muenchen@msc-ge.com

Nuremberg
 Phone +49 911 43970 - 0
 Fax +49 911 43970 - 30
 Nuernberg@msc-ge.com

Jena
 Phone +49 3641 6825 - 0
 Fax +49 3641 6825 - 66
 Jena@msc-ge.com

Sales Offices Europe

MSC Vertriebs GmbH Wiener Neudorf Office
 Phone +43 2236 205066-0
 Fax +43 2236 205066-11
 Wien@msc-ge.com

MSC Schweiz AG Montreux Office
 Phone +41 21 965 3500
 Fax +41 21 965 3501
 Montreux@msc-ge.com

MSC Schweiz AG Biel/Bienne Office
 Phone +41 32 366 8565
 Fax +41 32 366 8566
 Biel@msc-ge.com

MSC Schweiz AG Rotkreuz Office
 Phone +41 41 785 8200
 Fax +41 41 785 8209
 Rotkreuz@msc-ge.com

MSC-Vertriebs-CZ s.r.o. Blansko Office
 Phone +420 516 411494-24
 Fax +420 516 411494
 Blansko@msc-ge.com

MSC-Vertriebs-CZ s.r.o. Prague Office
 Phone +420 296 580260
 Fax +420 296 580262
 Praha@msc-ge.com

MSC (France) S.A.R.L.
 Phone +33 16480 5555
 Fax +33 16017 0063
 Paris@msc-ge.com

MSC (UK) LTD.
 Phone +44 1273 622446
 Fax +44 1273 622533
 Brighton@msc-ge.com

MSC (Scotland) LTD.
 Phone +44 1506 460555
 Fax +44 1506 461444
 Livingston@msc-ge.com

MSC Budapest Kft.
 Phone +36 1250 90-40
 Fax +36 1250 90-41
 Budapest@msc-ge.com

MSC Nederland BV
 Phone +31 78 6920-150
 Fax +31 78 6920-151
 Netherlands@msc-ge.com

MSC Polska Sp. z o.o.
 Phone +48 323 3054-50
 Fax +48 323 3054-52
 Gliwice@msc-ge.com

MSC-Mibatron s.r.l.
 Phone +40 31 102 34 66
 +40 21 230 25 30
 Fax +40 21 230 25 21
 Bucuresti@msc-ge.com

MSC Vertriebs GmbH Istanbul Office
 Phone +90 216 411-2333
 Fax +90 216 411-3935
 Turkey@msc-ge.com

MSC Representative Norway
 Phone +47 69 889899
 Fax +47 69 889799
 Johnny@linkel.no



© MSC. All rights reserved. Although great care has been taken in preparing this printed matter, MSC cannot be held responsible for any errors or omissions. All information in here is subject to change without notice. All other products and brand names are registered trademarks of their respective companies.

MICROCOMPUTERS · SYSTEMS · COMPONENTS · VERTRIEBS GMBH

Hotline: +49 7249 910 - 129 · E-mail: power-devices@msc-ge.com

www.msc-ge.com