

CALIBRATION-

Philosophy in Practice



FLUKE

CALIBRATION — Philosophy in Practice

FLUKE

CALIBRATION— Philosophy in Practice

By **STEVE SPANG**
Training Department
John Fluke Mfg. Co., Inc.

with the assistance of

CAROLYN "SIS" MUTCHLER
Graphic Design and Concept

H.W. "RED" CARLSON
Technical Director

in association with

JOHN FLUKE MFG. CO., INC.

and

FLUKE INTERNATIONAL CORP.

P.O. Box 43210

Mountlake Terrace, Washington 98043

The originators of this publication wish to express that the sole intent and purpose of the material contained within is for educational and training applications only and by no means claim rights for any or all of the material used for purposes of personal, economic, or capital gains.

—CALIBRATION—
Philosophy in Practice



John M. Fluke

This Book is Dedicated to . . .

John M. Fluke, Chairman of the Board of Directors and founder of the John Fluke Mfg. Co., Inc., in tribute to his continuing contributions to the advancement of electronic test and measurement technology.

Corporate Headquarters, Mountlake Terrace, Washington



Contents

1	Introduction: Philosophy of Calibration	1
2	Establishing a Standards Laboratory	3
3	Building a Standards Laboratory	10
4	Resistors and Measurement	13
5	Methods of Comparison of Resistors	16
6	Special Apparatus for Precision Measurements	21
7	Standard Cells	27
8	Intercomparison of Standard Cells	32
9	Control Chart for Saturated Standard Cells	34
10	Josephson Junction Based Voltage Standard	37
11	The Rise of the Calculable Capacitor	40
12	Precision Instrumentation	44
13	7105 DC Voltage and Ratio Calibration Systems	52
14	Advanced DC Calibration Techniques	64
15	Thermal Transfer Standards	73
16	AC Voltage Calibration	77
17	Time and Frequency Standards	79
18	Errors in Measurement	84
19	Precision and Accuracy	86
20	Accuracy and Specmanship	90
21	Guarding of Digital Voltmeters, Digital Thermometers and Calibrators	92
22	Bibliography	97

Contents



1
2
3
4
5
6
7
8
9
10
11
12
13
14
15
16
17
18
19
20
21
22
23
24
25
26
27
28
29
30
31
32

1
2
3
4
5
6
7
8
9
10
11
12
13
14
15
16
17
18
19
20
21
22
23
24
25
26
27
28
29
30
31
32

Introduction: Philosophy of Calibration

The evolution of electrical measurement, and the measuring instruments to meet the requirements of electrical measurement, have changed rapidly over the past 40 years. From the early beginnings of the VOM (Volt-Ohm-Meter) whose accuracy was somewhere between 3% and 10%, the world of measurement has grown to the present-day instruments such as the Digital Voltmeter which can attain DC accuracies of 0.001%, or 10 ppm.

This factor of 10,000 to 1 in accuracy improvement has changed the approach and the attitude to calibration throughout the world.

Possibly the greatest force in causing this rapid growth in accuracy has been the demands placed upon industry by the military over the years, and the aerospace programs of more recent years. The technology demand by these two factors alone has caused industry to develop more varied and more sophisticated instruments with which to carry out these programs. At the same time, it should not be overlooked that many of the advances in the area of measurement have been diligently carried forward by agencies such as National Bureau of Standards located throughout the world. In many instances, however, the breakthrough in the state-of-the-art came from engineering in industry, either through the development of a new component (such as the transistor), or from the application of that component in a new and unique way.

In the world of calibration instrumentation there are active and passive instruments. A passive instrument is one that either (a) does not require or rely on operating power from an external source, or (b) does not contain elements within its circuitry that are responsible for amplification of the applied signal. An active instrument, on the other hand, does rely on powered circuitry which processes the applied signal in some manner. An example of a passive instrument is a resistive decade divider. An example of an active device is a Digital Voltmeter.

This categorization between passive and active devices generally forms the dividing line between the levels of

calibration. Passive instruments are at the higher levels of accuracy and calibration. Active instruments are at lower levels of accuracy and calibration. This separation of accuracy levels helps to define also the dividing line between a primary standards laboratory and a secondary (or lower) laboratory.

Instrumentation falls into categories as a direct function of its accuracy capability, and we find that there are three major levels of accuracy which can be described. These are designated as Primary, Secondary, and Tertiary. The Primary level incorporates the passive elements such as the saturated standard cell and other standards such as the Thomas 1 ohm resistor, the 10k resistance standard, standard inductors and capacitors, and possibly a frequency standard. The Secondary level utilizes a much broader base of instruments, most of which are active (but still have a high accuracy) whose responsibility is to calibrate other higher level instruments used in research and development, or which are used to calibrate instrumentation used at a lower level of accuracy. The Tertiary level is considered to be the "working level" of instrumentation, and this is where the greatest quantity of instruments is located. But because this area of instrumentation is relied upon so greatly for day to day operations of manufacturing, testing and servicing, it is the area of instrumentation which should have the greatest attention when it comes to maintenance and calibration.

In order to better determine where different types of instruments should be used relative to their basic accuracies, the following table is given which displays the accuracies required for the Primary, Secondary, and Tertiary levels.

LEVELS OF ACCURACY

Primary

Resistance: 1-7 ppm to 100k; 10 ppm to 1M
 Voltage (DC): 0-1200V, 5-10 ppm
 Voltage (AC): 0-1200V, 10 Hz to 1.2 MHz; 0.01%
 Current (DC): 0-10A, 0.02%
 Current (AC): 2.5 mA-20A, 5 Hz-100 kHz; 0.03%
 Frequency: 10 Hz-1,000 MHz; 1×10^{11}

Secondary

Resistance: 10Ω - $12\text{ M}\Omega$; 0.02%

Voltage (DC): 0-1200V; 10-20 ppm

Voltage (AC): 1 mV-1200V, 10 Hz-1.2 MHz; 0.02-0.05%

Current (DC): 0-10A; 0.1%

Current (AC): 0-10A, 5 Hz-20 kHz; 0.05%

Frequency: 10 Hz-1,000 MHz; 2×10^{-9}

Tertiary

Resistance: 100Ω - $12\text{ M}\Omega$; 0.1%

Voltage (DC): 0-1200V; 0.02%

Voltage (AC): 1 mV-1200V, 10 Hz-100 kHz; 0.2%

Current (DC): 0-2A; 0.3%

Current (AC): 0-2A, 5 Hz-20 kHz; 0.5%

Frequency: 10 Hz-1,000 MHz; 5×10^{-7}

As instrumentation becomes more advanced at any, or all, of the three levels depicted, these accuracies will undoubtedly improve in all respects. As a corollary this means that the demands of industry have risen, or that better instrumentation is available to industry or research at the same, or less, cost.

These events point out the continuing and growing requirement of people at all levels of the instrumentation business to become more aware of calibration requirements. Even though recently produced instruments are becoming more stable (along with their greater accuracy), they are still active devices which are subject to the normal deterioration due to time and environment. Because of that it is always important to keep in mind that, in order to operate these instruments in a world that is demanding more and more in accuracy, it is necessary to consider that periodic calibration of these instruments much more seriously. It can be stated unequivocally that the technological capability of a nation can be directly related to the accuracy and stability of its instrumentation. A like comment could be made regarding the level of its technical personnel, and that is the theme of the material presented in this book. It is our endeavor to display information related to maintaining basic standards on down to the calibration level of bench instrumentation in the hope that this material will be used to further the technology of the electronic equipment user.

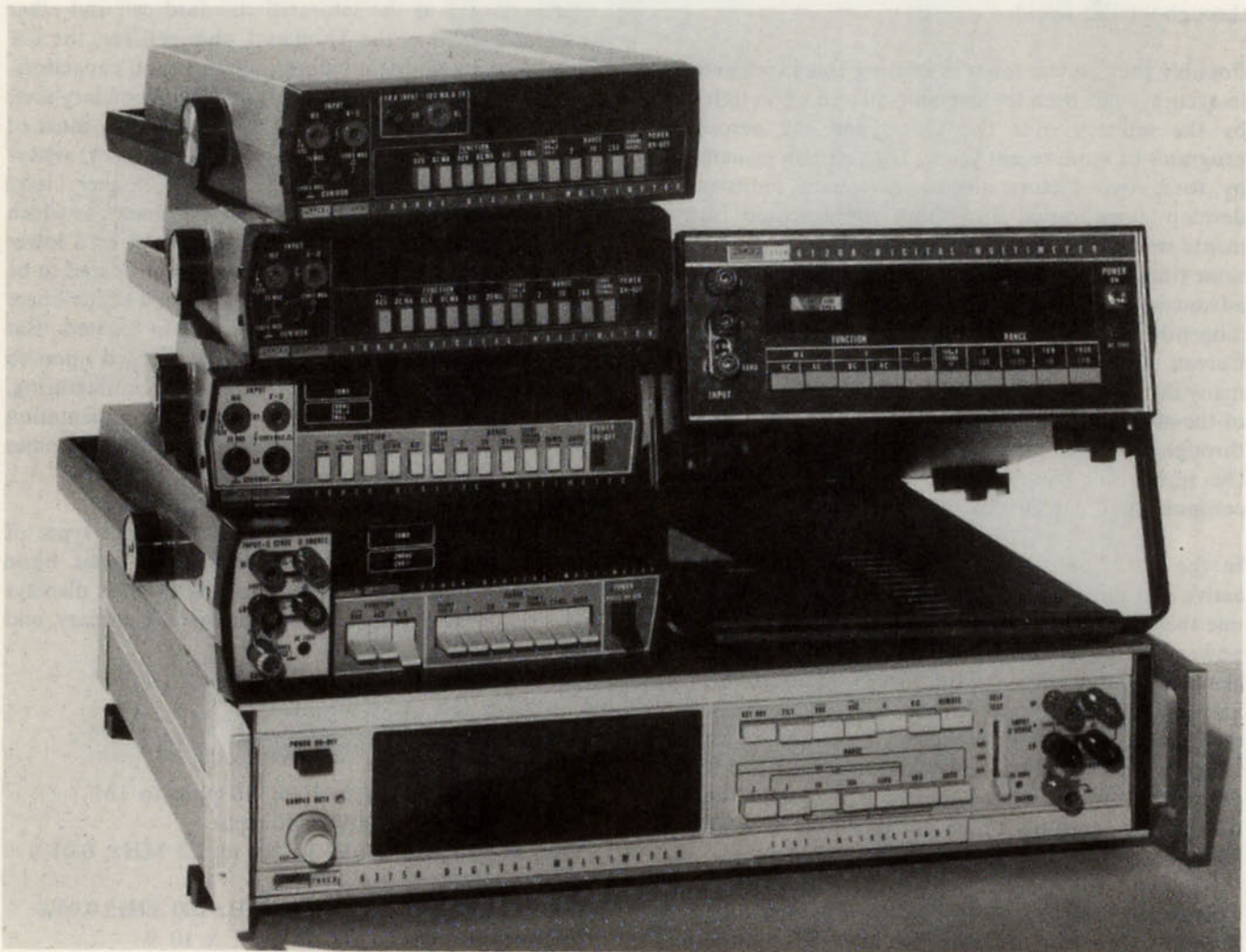

2

Establishing A Standards Laboratory

OBJECTIVE

The purpose of this section is to acquaint you with the requirements that should be taken into consideration when designing a standards laboratory facility.

INTRODUCTION

The process of measurement always involves a succession of steps in which the units, in terms of which the measurement of any quantity is expressed, are transmitted by using measuring apparatus that has been standardized, by comparison with standards of a higher level, to calibrate other measuring apparatus which is to serve as a standard at a lower level. Next, in any organization, may come a primary group of laboratory workers which maintains its basic reference standards and in turn calibrates the working standard apparatus used by the next lower, or secondary, group, which in turn calibrates the instruments used in making measurements in the plant or shop. In some cases these latter two operations are merged in a single group, while, at the other extreme, a single primary group may serve many secondary groups located in different cities.

It is the rest of the organization that uses the shop instruments standardized by the working-standards group, and carries on the day-to-day work in the power systems, manufacturing operations, research studies, or acceptance tests. This use insures proper billing, adequate quality, and valid criteria for the acceptance of manufactured articles. The term "standards laboratory" will be used to indicate the segregated part of the complete organization that is charged with the duty of supplying calibration services, at either the reference or the working-standard level, to the measuring apparatus used by the rest of the organization, which will here be designated as "plant" or "shop" even though it may actually be more correctly described as a research or testing laboratory.

The measuring instruments and apparatus used in an industrial organization will be referred to under the following categories:

1. Reference standards, which embody fixed electrical

quantities and serve to maintain their respective units during the intervals between checks with a laboratory at a higher echelon.

2. Working standards, calibrated in terms of the reference standards and reserved for use in the calibration of shop instruments and apparatus. Working standards should never be used directly for measurements in the plant or shop.
3. Comparison equipment such as bridges, potentiometers, etc., and consoles used in comparing shop instruments with working standards.
4. Interlaboratory standards, often similar in construction to reference standards, used for transport to NBS and return in the periodic checking of the local reference standards.
5. Shop instruments and measuring apparatus calibrated in the standardizing laboratory and used in the day-to-day operation of the plant.

GENERAL PRINCIPLES

The following general principles have been found by experience to be applicable to many of the problems involved in the maintenance of accuracy in laboratory work and any program of calibration service testing should conform to them as possible.

Competence of Personnel

The people in charge of any standardizing laboratory must be thoroughly familiar with the fundamentals of electricity and magnetism and with the principles of operation of all types of electrical measuring apparatus. To be competent to carry on within the laboratory the various sequences of calibration testing outlined below, he should have taken a college-level course in electrical measurements or have had equivalent experience. It is very desirable that he be a graduate in physics or electrical engineering from an accredited college. He must be mentally alert to detect discrepancies and inconsistencies in internal check tests and to recognize

and to recognize abnormal behavior of any part of the apparatus or circuits. Unless persons of this type are available in a standards laboratory, both its calibration service and the measurement work that depends upon it throughout the plant is certain to become unsatisfactory, regardless of how often particular pieces of apparatus may be tested by other persons in some higher echelon or at NBS.

Position in Organization

Experience through the years has shown that the most satisfactory results are obtained by maintaining a definite separation of the standards laboratory from the rest of the organization. Responsibilities for accuracy are thereby made definite, and team spirit can be developed in the staff of the standards laboratory that keeps them interested in their work, which might otherwise seem routine and unimportant. This separation protects them from pressures that demand improper haste and sloppy workmanship, and gives them authority directly delegated from a high level in management.

Closely related to the foregoing is the valuable principle that team spirit can be developed and maintained by recognizing that the quality of the reference standards of a laboratory are to a considerable extent a measure of the competence of its staff. In cases where a given large organization maintains a plurality of standards laboratories in its plants in different cities, it is very desirable that each reference and interlaboratory standard should be assigned permanently to an individual standards laboratory, and returned to it following periodic checks at any laboratory of a higher echelon. If this is not done, it becomes difficult to fix responsibility for errors that may be discovered and the laboratory workers lose the basis for much of their pride in workmanship.

Appropriate Scope and Accuracy

The nature and accuracy of the work done in a standards laboratory may vary considerably with the size of the plant it serves and the nature of the output of the plant. However, there are very few modern activities in which some phases do not require measurements of rather high accuracy. A standards laboratory must, of course, be equipped for calibration measurements of a higher accuracy than any used elsewhere in the plant, because the accuracy of measurement can never rise above that of its source.

Care of Standards

In many categories, a good standard piece of apparatus improves with age but deteriorates with handling and shipping. The shipping of primary and working standards and of comparison equipment can be minimized and the transfer of the units be achieved best

by the use of interlaboratory standards of particular types that are as rugged as practicable.

The adjustment of a piece of measuring equipment to be close to its nominal value is very often desirable in the shop instruments used in the plant, because of the great saving in time and reduction in possible erroneous applications of corrections that result. On the other hand, the exact opposite is usually true of working and reference standards. In general, such standards should not be readjusted, even if their values have gradually drifted materially away from their nominal values. Any standards laboratory naturally maintains records of the values of its reference standards. These are preferably kept on an individual card or record sheet for each standard, so that its history is apparent at a glance. Each such record provides a valuable indication of the quality of the standard, and gives warning of deterioration and the need for replacement toward the end of its useful life. Frequent adjustments tend to interfere with such records and increase the probability of improper corrections. Even more important is the risk that the adjustment may initiate a progressive drift in value of the standard as a result of introducing mechanical strain, or local heating.

Timing of Calibrations

The most desirable sequence of steps and the frequency with which comparisons of measuring apparatus should be made depend, of course, upon a great number of circumstances, such as the volume of equipment to be tested, the delicacy of the apparatus, and particularly the type of personnel by which it is to be handled. In every laboratory a real possibility is always present that an abrupt change may occur in some standard as a result of an unrecognized accident or abuse. Fairly frequent checks are an indispensable supplement to any program of calibrations to a higher echelon.

In any laboratory, the accuracy needed in measurement may differ widely on different projects. The frequency with which the working instruments should be checked may vary considerably from project to project, even though instruments of the same accuracy class are used. When a new type comes into use, it must be appraised by being checked at frequent intervals during its first few years of service. After its good stability has been demonstrated, the interval between tests may be made longer.

A procedure that is often of value, particularly for the checking of consoles and complex equipment such as a-c bridges, is to use an interlaboratory standard that is measured in one laboratory and shipped to a laboratory of lower echelon for a repeat measurement. This procedure can detect significant defects in the wiring or insulation of the test console, improper procedure and

careless operations at the lower-level laboratory, as well as changes or deterioration in the reference or working standards of the lower laboratory.

When systematic local intercomparisons indicate changes or abnormal performance in primary or working standards, checks with a higher echelon are in order regardless of whether any formal scheduled time for such a check has been reached. If the local periodic checks uncover unsteadiness of operation, large sudden changes in value, or other indication of a constructional defect in the reference or working standard, this standard should be sent to its manufacturer for repair before it is submitted to NBS for calibration.

REFERENCE STANDARDS

The function of the reference standards of a laboratory is to maintain locally a continuity of value in the units of measurement that they embody. Successive comparisons with the higher-echelon standards of NBS by means of interlaboratory standards shipped back and forth will give an indication of any slow drift of the reference standard. The reference standards are used primarily to calibrate the working standards of a lower echelon. Also, on occasion they may be used as working standards themselves.

It is evident that both reference standards and working standards should be as permanent and reliable in construction as possible. Definiteness and repeatability are of major importance, whereas sensitivity, low losses, and freedom from extraneous influences are relatively much less important. Closeness of adjustment to nominal value is of decidedly minor importance. An undetected change in a reference standard may easily initiate a chain of error that will propagate throughout the plant and cause losses in time and material exceeding the original cost of the standard. Hence, these reference standards should be purchased only on very strict specifications, and from manufacturers of high reputation and of long experience in producing shop instruments and apparatus of demonstrated permanence.

Standard Cells

A large and important laboratory, which is expected to need a standard of voltage with an accuracy of 0.002 percent or better and to certify the emf of other standard cells used in its plant normally maintains as a reference standard at least one group of 4 to 6 standard cells of the saturated type. These cells are relatively permanent but have a temperature coefficient of about 0.005 percent per degree Celsius (centigrade) at room temperature. They must therefore be kept in a bath thermostated to better than 0.01°C. A highly refined, water-white, acid-free mineral oil, having a viscosity of about 0.25 poise at 25°C and a flash point of 170°C, has been found

suitable for baths for standard cells and for resistors. Such a group of saturated cells should be checked at NBS and its value reassigned annually, by using a second group of 2 or 3 saturated cells as an interlaboratory standard. The individual cells of the reference group can be intercompared monthly. The reference group is used to check the laboratory's working-standard cells of the unsaturated type and, on occasion, shop-standard cells also.

For laboratories requiring an accuracy of not over 0.01 percent in their standard of voltage, the reference standard often consists of a group of three cadmium standard cells of the unsaturated type. The individual cells are intercompared weekly by connecting them by pairs in series opposition and measuring the differential emf. These cells have a very small temperature coefficient and can be shipped safely by parcel post. However, they are less constant than saturated cells and their emf usually decreases at a rate ranging from 10 to 120 microvolts per year. Therefore, their values should be reappraised at least annually on the basis of a periodic check from a higher echelon. A second group of 2 or 3 unsaturated cells can be used as an interlaboratory standard for such checks. When the emf of an unsaturated standard cell has fallen below 1.0183 volts, it is approaching the end of its useful life and can no longer be used as a reference or an interlaboratory standard. Following a moderate change in temperature, many cells tend to show a very considerable change in emf, which may persist for several days. This thermal "hysteresis" must be guarded against by allowing cells to stand for some time after shipment before taking readings. Temperature troubles with unsaturated standard cells can be minimized by keeping them in a thermally lagged copper-lined box. This reduces temperature fluctuations and differences in temperature between the two electrodes. It is important that the leads be brought out through very high grade insulation to an external terminal board.

Resistors

If the laboratory possesses at least two standard resistors of each decimal value covering the range over which it expects to make accurate measurements, one of these can be submitted to NBS every 2 years as an interlaboratory standard, while the other resistor of each pair remains undisturbed as a reference standard in its laboratory.

Inductors

Many laboratories find it useful to possess two fixed standard inductors of each decimal value over the range it expects to cover with accurate measurements. In recent years the quality of standard inductors has been

greatly improved, but NBS does not yet have sufficient data on the stability of the newer types to make a definite estimate of their expected stability. It is suggested therefore that one inductance standard of each denomination be submitted annually to the NBS, until a sufficient history is obtained to predict its performance.

Capacitors

Reference standards of capacitance include small fixed air-dielectric units, precision-variable air capacitors, and solid-dielectric capacitors using mica or an equivalent dielectric. Fixed standards 1,000 picofarads (micro-microfarads) or less in value must be of three-terminal construction in order to avoid uncertainties due to stray capacitances.

Each laboratory should possess two capacitance standards of each decimal value and type needed to cover the range of concern. After its initial check at NBS, one standard of each value can be kept as a reference standard while the other is submitted to NBS at regular intervals as an interlaboratory standard. This interval should initially be 1 year for any one pair of standards. After the first 3 or 4 calibrations, an examination of the record will indicate the appropriate future frequency of calibration, taking into account the actual accuracy demands made on particular standards.

Volt Boxes

Each laboratory should have one volt box with a plurality of ratios, which can serve as a reference standard. This can be checked initially at NBS. Unless the laboratory is rather large, this same volt box may be rechecked at NBS at intervals of 2 years, and thus serve as an interlaboratory standard also.

Time Standards

Although time is not an electrical quantity, many electrical laboratories require reference standards of time or of frequency. A high-grade seconds pendulum clock with photoelectric pickup or a standard crystal-controlled oscillator may form the reference standard. Either can be calibrated by reference to the standard-frequency radio signals emitted by NBS stations WWV or WWVH. By the use of a multivibrator in combination with the reference-standard oscillator, the frequency of working-standard oscillators can be calibrated over a wide range. Such an oscillator can be used to control a standard frequency circuit to which, in turn, synchronous timers can be connected to serve as working standards for measuring time intervals. The use of the frequency of local electric-power circuits as a time standard may be subject to errors approaching 1 percent for short periods of time, even though the average frequency over a longer time as shown by a clock is very

high. These short-time fluctuations in frequency are materially less if the supply is tied in synchronism with a large power system.

WORKING STANDARDS

The working standards constitute the principal tools of the standards laboratory. They are calibrated at intervals by comparison with the reference standards, and used in the daily work of checking shop instruments. The number needed of any one kind and range will depend upon the volume of testing service demanded in that range. If the volume is very small, and also in special cases where extreme accuracy is needed, a reference standard can be used as a working standard also.

Standard Cells

Most laboratories will need a number of unsaturated cadmium standard cells to serve as working standards and relieve their reference cells of excessive use and of the hazard of accidental abuse. Such working-standard cells should be checked against a reference standard or as often as required for the accuracy needed.

Resistors

Depending upon the nature of the work in the laboratory, there will probably be required, in addition to sets of fixed standard resistors, a number of dial-type resistance boxes, perhaps including resistors in the megohm and multimegohm ranges, and also resistors or shunts capable of carrying larger currents than are appropriate to the reference standards. These working standards may initially be tested at NBS to determine the effects of current and temperature on their resistance. Thereafter these working standards need to be checked, using a moderate current, at intervals of about 6 months by comparison with the reference standards of resistance, using a direct reading ratio set, Wheatstone bridge, or double ratio set or the potentiometer method. If it is believed that a resistor has been overloaded, it should be checked against the appropriate reference standard without delay, and if a significant change in value has occurred since the last regular check, the overloaded resistor should be checked at frequent intervals until its resistance again becomes steady.

Capacitors and Inductors

Each laboratory should compare all of its working standards with its reference standards once a year, and also immediately after an interlaboratory group has been calibrated at NBS. Working standards that are used frequently may be compared with the laboratory reference standards whenever an important series of plant calibrations is undertaken.

Volt Boxes

A small laboratory may find it sufficient to use its reference volt box as a working standard also. This can be checked initially and at intervals of 2 years at NBS. It is well to measure and record the resistance of each section of each volt box initially, and monthly thereafter, as a means for detecting possible changes that might be caused by inadvertently overloading one of the lower-voltage ranges. More often other working-standard volt boxes will be used as auxiliaries to potentiometers for the calibration of both working-standard indicating instruments and shop instruments. These can be compared monthly with the reference-standard volt box by a null method.

Indicating Instruments

Direct-current and alternating-current ammeters, voltmeters, and wattmeters of either the 0.1-percent or the 0.25-percent class will be needed for the range of current, voltage, and power over which the shop instruments used in the plant are to be checked. The a-c instruments must be of the electrodynamic, electrostatic, or electrothermal (thermocouple) types, which can be used on direct as well as on alternating current. The usual a-c instrument of the moving-iron type is not suitable as a transfer standard. The working-standard indicating instruments can be submitted to NBS for an initial test, and the a-c instruments for the additional determination, on appropriate ranges, of the ac-dc difference by comparison with a transfer instrument. This ac-dc difference test should cover the full range of frequency over which the instrument is likely to be used. After this initial test, they can be retained in the laboratory and checked in terms of a standard cell and standard resistor, using a potentiometer. Preferably, the frequency of these checks ranges from 2 weeks to 2 months, depending upon the frequency of use of the working standards and their reliability as indicated by earlier check tests. Direct-current working-standard indicating instruments, when built into a console, usually have terminals so arranged that the instrument and its range-extending resistors can be checked by using a potentiometer and a bridge. Alternating-current instruments may have to be checked by comparison with interlaboratory standard instruments of a multirange type.

COMPARISON APPARATUS

The term "comparison apparatus" includes equipment which the calibration of a shop instrument or standard is checked by comparing it with an appropriate working standard of the laboratory. In many cases the working standard is substituted for the device under test in the same circuit of the comparison equipment, and the change in its indication is taken as the measure of their difference. Such substitution methods are in general

capable of very high accuracy, and should be used wherever practicable.

In other cases a working standard is in effect built in as part of the comparison equipment. Examples of the latter are (1) the working standard indicating instrument built into an instrument testing console and (2) the rheostat arm of a Wheatstone bridge when used directly (as contrasted with its use by substitution).

Consoles

These devices, containing appropriate sources, adjusting transformers and rheostats, and panel instruments for approximate adjustment, will provide the circuits for the comparison of shop indicating and recording instruments with working-standard instruments. In some types of console the working-standard instruments, and their auxiliary range-extending apparatus are also permanently built into the equipment. If suitable special terminals are available, these working standards can be calibrated like portable standards. If not, some secondary procedure must be set up by which the console in effect tests other working standards that have previously been checked over the full range. The console can be shipped direct from the manufacturer to the laboratory. The person in charge of calibration work at the laboratory can then satisfy himself, by appropriate measurements of insulation resistance and of circuit resistance, that the connections are correct and that the leakage and lead resistance are not such as to introduce errors. In general, these particular hazards are less if the leads can be run directly in the open between the working standard and the instrument under test.

Care must also be taken to insure that no ferromagnetic material is located near the instrument under test or the standard instrument to affect its calibration. Even nonmagnetic metal supports can cause trouble by providing eddy-current circuits which can affect unshielded a-c instruments. Stray magnetic fields from supply transformers and rheostats (particularly those wound on enameled steel tubes) must be eliminated. The familiarity that the supervisor will obtain by carrying on this acceptance test forms an essential part of his training for the job. His success in it can be verified adequately by the use of a group of indicating instruments as interlaboratory standards in annual tests. The local checks of insulation and of lead resistance should be repeated every 6 months.

Direct-Current Bridges, Direct-Reading Ratio Sets, Universal Ratio Sets, Direct-Current Potentiometers

These can be tested initially at NBS and in most cases need only to be resubmitted at intervals of 3 years. During the interim, local checks can be made at

intervals of 6 months by using the bridge or ratio set to measure or compare interlaboratory-standard resistors. A potentiometer can be given a rough check at least annually at one point by using it to measure a standard cell of known emf or, alternatively, by using a single cell first as the standard by which to adjust the potentiometer current and then as the unknown to be measured.

Lindeck Potentiometer

Any laboratory will find very useful a combination of a standard resistor and milliammeter (of the 0.25% class) to use as a low-range Lindeck potentiometer for the purpose of intercomparing the various standard cells in the laboratory by measuring the differences between them in pairs. The resistor and milliammeter can then be checked on the same schedule as the working-standard resistors and the working-standard instruments. Care must be taken to minimize thermal emf in such a circuit.

INTERLABORATORY STANDARDS

Interlaboratory standards in general are similar in nature to reference standards and working standards. The smaller laboratories may well use some of their reference standards to serve as interlaboratory standards also. These should be of rugged construction to minimize damage and change of value in shipment. On this account they usually are standards of fixed value rather than continuously adjustable devices.

The function of an interlaboratory standard is to transmit some of the electrical units of measurement from a laboratory of higher echelon, such as the NBS, to the local laboratory. It is sent systematically to NBS for a calibration and is compared before and after this operation with the appropriate reference standard of the local laboratory. In those cases in which a large organization maintains a plurality of separate standards laboratories under its authority, a single set of interlaboratory standards may profitably be circulated to give a "round-robin test" by being sent to 3 or 4 of the company's laboratories in succession between trips to NBS. Such a program provides a check both on the comparison apparatus and on the operating competence of the personnel at the various laboratories. It also performs the function of maintaining the assigned values of the reference standards of each laboratory in concordance with NBS standards.

SHIPMENT

Electrical measuring instruments such as ammeters, voltmeters, wattmeters, and the watt-hour meters contain extremely delicate jewels and pivots, upon the operation of each instrument depends. These delicate parts must be carefully protected from mechanical

shocks and jars during shipment. Sensitive instruments will not arrive in satisfactory operating condition unless great care is taken in packing. Every effort is made to handle and to repack these instruments carefully at NBS and whenever possible the return shipment is made in the original container.

Before each instrument is packed, all binding posts should be tightened, and any externally operated clamping device for the moving system should be switched to the "clamp" or "transit" position. Plugs and other small accessories should be enclosed in a small separate container tied to the instrument. Glass windows of instruments lacking protective cases should be protected by pieces of thin wood or heavy cardboard before wrapping. Each instrument should then be wrapped in heavy manila paper or similar covering and sealed with gummed tape to exclude dust and excelsior.

Boxes in which instruments are packed should be strong, preferably of wood, with screwed-on tops to avoid damage to pivots or jewels, which may be caused by a hammer or nail puller.

Clean, fresh excelsior or its equivalent in special packaging material should be used as the shock-absorbing material. A layer of excelsior at least 3 to 4 inches deep, pressed down firmly, should surround each wrapped instrument. Instruments having pivoted components should be packed upside down.

High-grade pivoted instruments of the laboratory-standard type, which have comparatively heavy moving systems without clamping devices, should be packed with special care and should always be individually shipped in wooden boxes with 4 to 6 inches of excelsior around the wrapped instrument. Portable standard watt-hour meters (rotating standards) should also be individually packed.

Certain heavy accessories used with instruments, such as ammeter shunts, current transformers, and voltage (potential) transformers should be packed in separate boxes to avoid possible damage to the instruments. Heavy pieces should always be shipped in wooden boxes and held in place, if necessary, by checks or cleats. Large transformers, especially those having oil-filled iron cases, should be crated singly, and arranged whenever possible so that the terminals can be made accessible for tests without removing the entire crate.

The tops of the boxes and crates must be marked "This Side UP." Boxes containing delicate instruments should be marked "Fragile, Handle With Care." Those containing any glass parts should be marked "Glass." Failure to use such markings precludes recourse in the event of loss or damage in shipping.

Standard Cells

A laboratory having reference-standard cells of the saturated type would logically provide itself with a group of about four saturated standard cells which can be sent to the NBS annually, while the reference cells are new, but biennially thereafter. Cells of this type must be kept upright at all times and protected as far as possible from shock and temperature changes. This necessitates hand carrying and arrangements at each end for installing them in a thermostated bath. Smaller laboratories having unsaturated reference standards may use 2 or 3 unsaturated standard cells as interlaboratory standards. These can be shipped by parcel post. Shipments in extremely cold or hot weather should be avoided. If each interlaboratory cell is compared with the cells of the laboratory reference group before and after their transport to NBS, a very desirable check is obtained on any changes that may have occurred during transport. If any one cell shows the same value relative to the local group, before and after its travels, it is highly probable that its emf did not change and recover by an equal amount. If all cells are unchanged, the probability of the comparison being valid is greatly increased.

valid is greatly increased.

Resistors, Capacitors, and Inductors

Fixed standard resistors, capacitors, and inductors, whether of the fixed-unit type or groups of these combined in dial-type boxes, are satisfactory as interlaboratory standards and can be used at intervals of 1 to 2 years for comparison with NBS, depending on the stability of the reference standards that they serve. Intercomparison between the laboratories of a single organization at intervals of 1 year may prove useful in cases where the volume of testing at the individual laboratories is large and the working standards at these laboratories are therefore unusually liable to deterioration or accidental damage. The values of the interlaboratory standards of this group should be such as to cover the range of measurements with which the laboratory is concerned.

Indicating Instruments

The use of indicating instruments as interlaboratory standards is often of great value as an over-all check on

the comparison equipment and on personnel and procedures. On the other hand, in general, the actual transport of the units of measurement from a higher to a lower echelon is done more accurately by standard cells and resistors. The transfer of the electrical units from d-c to a-c standards is based on the initial tests at NBS of suitable 0.1-percent or 0.25-percent wattmeters, ammeters, and voltmeters. It may be found desirable, as a guard against accidental changes, to verify the performance of the transfer standards by comparing them with similar interlaboratory standards at 5-year intervals. A group of multirange a-c instruments may be used as interlaboratory standards to check the over-all accuracy of the a-c working standards built permanently into some type of consoles.

SUMMARY

In the foregoing sections, some of the basic principles on which the operations of an electrical standards laboratory should be based have been listed; the types of standard equipment needed have been classified; and the intervals at which these pieces of equipment should be intercompared locally and checked by comparison with a laboratory of higher echelon have been suggested.

The most important considerations in such an enterprise are:

1. The standards lab engineer must have a high degree of technical knowledge and competence in the specialized field of electrical measurements;
2. The measuring apparatus must be adequate and chosen specifically to fit the kinds of measurement and level of accuracy demanded;
3. The checking procedures must be definite and followed carefully, but should be flexible enough to meet emergencies;
4. The laboratory must accept responsibility for the internal consistency of its measurements, and should look to a higher echelon (such as NBS) only for its initial calibration and for periodic checks to detect drifts in the values of its reference standards.

3

Building A Standards Laboratory

We will now look at considerations when constructing a standards laboratory, e.g. construction, ventilation, temperature control, humidity, dust control, and power requirements.

CONSTRUCTION

Due to circumstances we will assume that the building in question, as a possible location for a laboratory facility, has already been constructed. So now we will examine the criterion that should be taken into consideration before the final decision has been made.

The building in question should be of sound and solid construction utilizing, if possible, masonry walls, metal studs, steel joists, steel columns, and steel beams. Second floors and mezzanines of buildings are to be avoided because of possible structural movement and the difficult-to-achieve vibration isolation. Good workmanship must prevail in each joint and seam of the wall exterior construction to minimize air infiltration and exfiltration (See Figure 1).

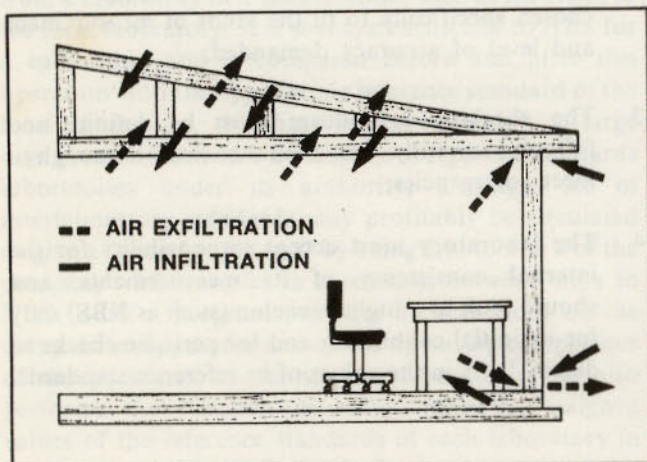

Figure 1.

To limit the flow of water into the building and to assist in maintaining the laboratory at a maximum of 55% relative humidity, vapor barriers should be provided in the exterior perimeter walls of the facility. Interior partitions must be extended to a suitable height above the vapor

barrier ceiling and care must be taken to prevent penetration of the vapor barrier during installation of electrical wall switches, receptacles, and associated conduit.

The ceiling should be, (1) a monolithic surface of drywall or plaster construction with finished joints and corners, (2) noncombustible acoustical units secured to concealed metal runners with concealed fastenings and hold-down clips. The acoustical units must be a type that will not shed particles, and installed with a joint system that will not leak due to the difference in air pressure above and below the ceiling, (3) or lay-in panels, supported in a suspended exposed metal grid system. The lay-in panels must be securely fastened with concealed tape or clips to prevent movement or loss of air pressure and to prevent infiltration of dust.

The number of doors in the laboratory area should be held to a minimum, but consistent with fire and safety regulations. Joints between the doors and frames must be furnished with gaskets which provide an effective seal. An air lock should be provided at the entrance to the laboratory area. Door opening of the air lock should provide a minimum width of 5 feet to permit passage of large equipment, a set of double doors is preferred to one wide door. The interior length of the air lock must be a minimum of 9 feet to accommodate items being moved so that both sets of doors are not open at the same time.

Finally, every consideration must be given to an installation that will keep floors, corners, aisles, and work areas clear and uncluttered to facilitate easy, frequent, and thorough cleaning. (See Figure 2).

VENTILATION

The environmental control system should be designed to provide a temperature of 22.4 to 23.6°C with no more than a 0.6°C change in any hour and a relative humidity of 35 to 55% within the laboratory area. (See Figures 3A-B and 4A-B).

Air distribution throughout the facility must be designed to provide circulation of air to all quarters and all levels

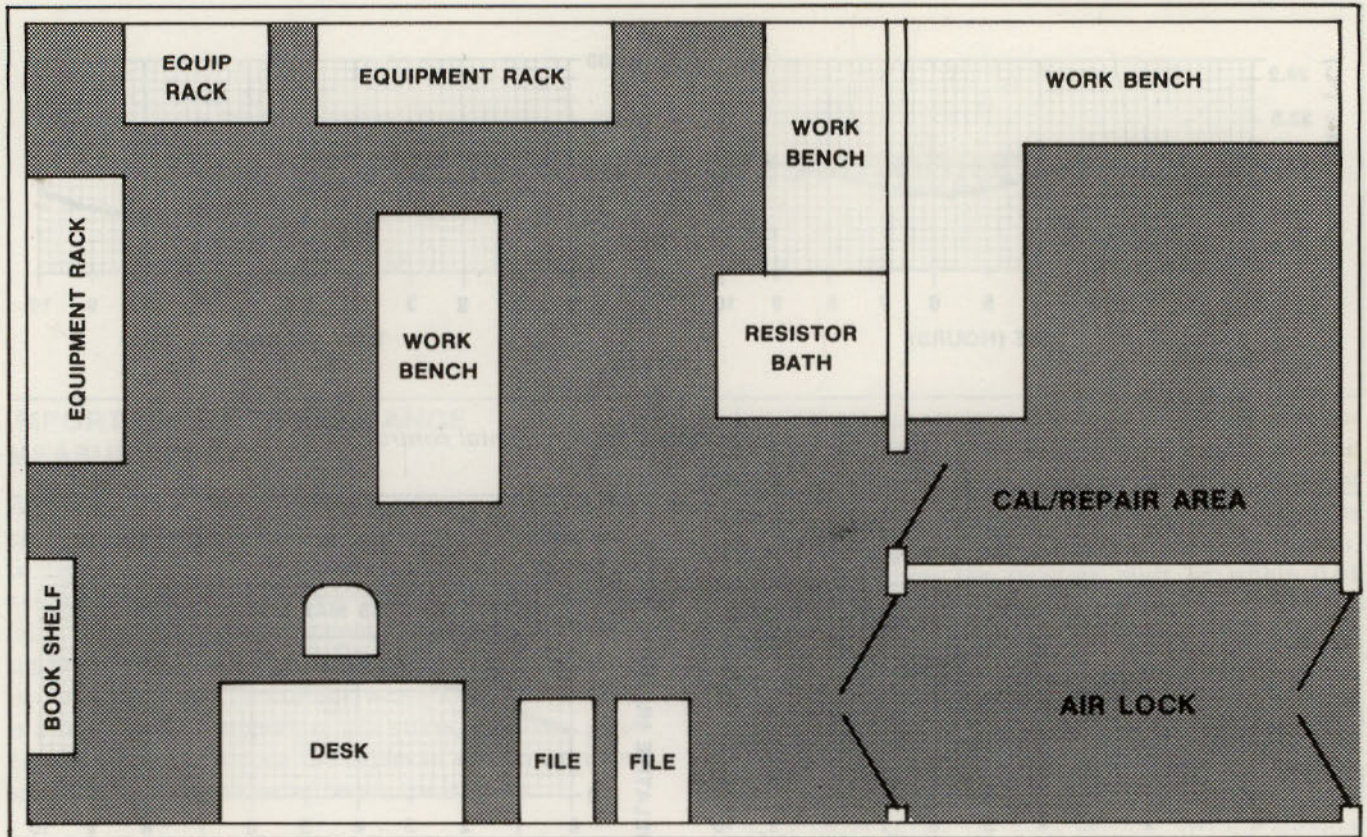

Figure 2.

of the facility to prevent stratification or layering, of air and to minimize temperature gradients from floor to ceiling. The required specifications will be met between the 3 and 5 foot elevations from the floor. Air velocity, or movement, in the working area (3 to 5 feet above the floor) should be 25 ± 10 feet per minute. With a minimum acceptance room air change rate of 10 CFM per person, or one air change per hour, whichever is greater.

Location of heat-generating equipment within the laboratory is very important in order to prevent concentrated heat buildup in specific areas. High heat-generating equipment must be hooded and isolated in order to maintain the 0.6°C maximum temperature change per hour.

A minimum positive static pressure of 0.05 inch of water is required to preclude the infiltration of dust laden air. A self-reading manahelic gauge should be installed to measure the pressure differential between the laboratory area and surrounding areas. To accomplish air filtration, air filters of medium efficiency should be installed, providing 35% minimum efficiency, when tested by the NBS dust spot test using atmospheric dust.

POWER REQUIREMENTS

The following is a list of typical power requirements for technical testing, but does not include lighting and

environmental control requirements. Outlets for technical testing should be provided with regulating equipment to maintain voltage within $\pm 2\%$ of the basic voltage, and the time constant (response time) of the voltage regulators should not exceed 0.3 second and total harmonic distortion shall be a maximum of 5%.

1. 115/230V ac, single phase, 60 Hz ± 1 Hz (50 Hz for overseas facility only as required).
2. 220/440V ac, 3 phase, 60 Hz ± 1 Hz (50 Hz for overseas facility only as required).
3. 115/230V ac, single and 3 phase, "Delta", 400 Hz ± 10 Hz.
4. 115/208V ac, 3 phase "wye", 400 Hz ± 10 Hz.
5. 28V dc (maximum ripple of 1% rms).

Lighting in the laboratory area should be of fluorescent type with recessed fixtures, if possible, so as to be devoid of ledges or protuberances that catch and hold dust particles. The fixtures should be radio frequency interference-free and equipped with rf filters in the power supply circuit. Lighting intensity should be of 100 foot candles (shadowless) at bench level throughout the laboratory area.

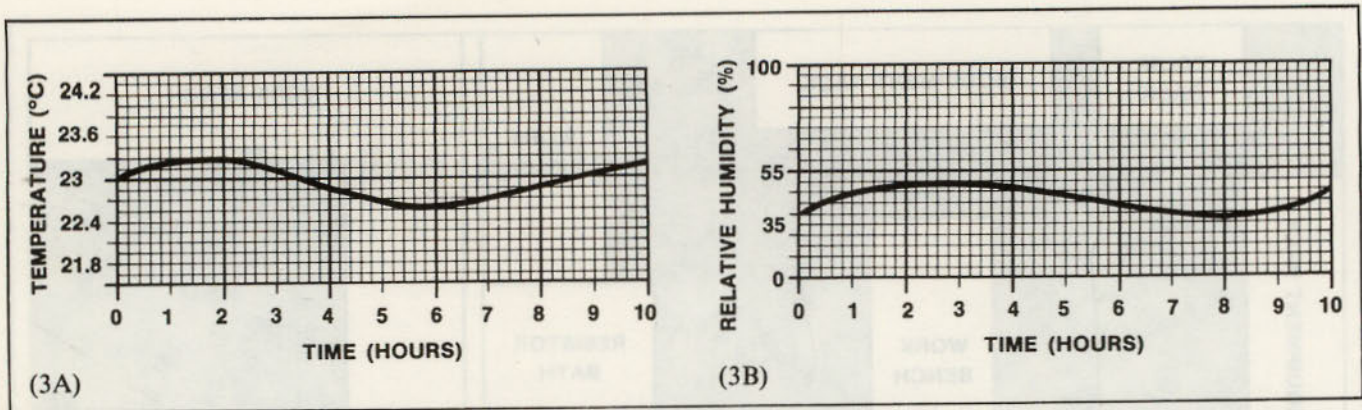

Figure 3. Example of adequate environmental control.

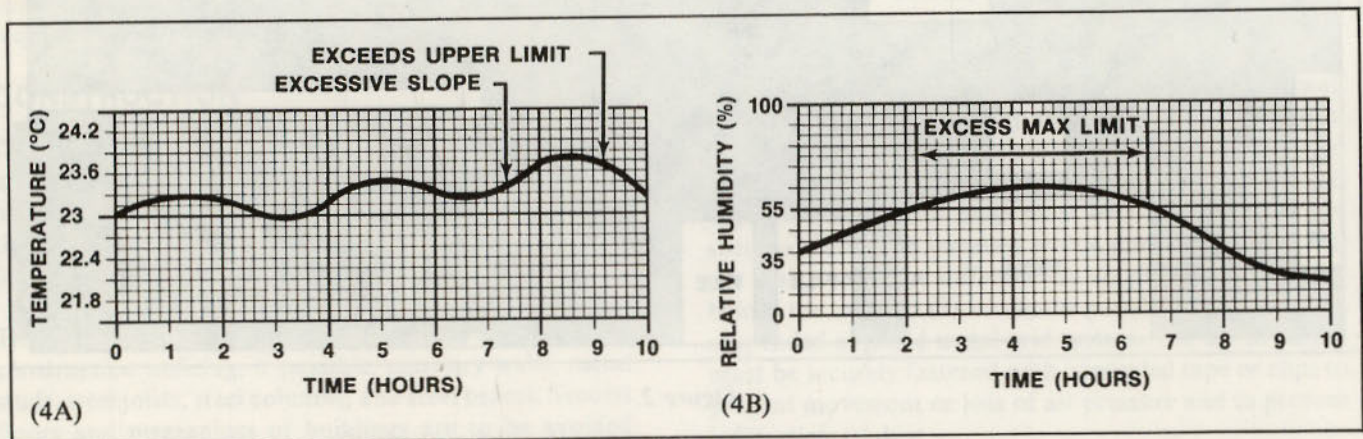

Figure 4. Example of inadequate environmental control.

Resistors and Measurement

IMPORTANCE OF RESISTANCE MEASUREMENT

Although Ohm found that the ratio of potential difference across a conductor to the current flowing in it is dependent on the material and dimensions of the conductor, more precise experiments shows it to depend upon temperature and even upon the presence of stress in the conductor. Instead of incorporating such quantities in our equation for the current, we say that the resistance is a function of temperature and stress, and for a given conductor we must state the values of temperature and stress for which a value of resistance is given.

The fact that resistance is a function of temperature is made use of in temperature measurements, the resistance of a wire being measured at known temperatures or fixed points and then at the unknown temperatures. Also, changes in resistance with dimensions are utilized for measuring small displacements, and change in resistance with stress is utilized for the measurement of liquid pressures. In addition a large number of physical and chemical phenomena are investigated by means of measurements of electromotive forces, and the measurement of electromotive force is customarily carried out by measurements of resistance ratios. Electric current is readily measured in terms of the potential difference across a known resistor. In fact, a large proportion of electrical quantities is measured by methods that involve the measurement of resistance.

In some cases the resistance of a conductor depends upon the magnitude of the current flowing through it. That is to say, Ohm's law is not applicable, and the resistance must be determined under the conditions of use. Also, the resistance of all conductors is to some extent a function of frequency, and the resistance must often be determined in such a way as to allow for the effect of frequency. However, the content of this section is limited largely to direct-current measurements of resistors which follow Ohm's law, with special emphasis on precision measurements, i.e., measurements to 0.01 percent or better.

TYPE OF RESISTORS

Resistors are used for many purposes with a large range of types and accuracies of adjustment. They are used as

electric heaters, as current-limiting devices such as motor starters, for component parts of radio, telephonic and similar equipment, and in electrical instruments of greater or less precision. For some applications adjustments must be made to perhaps 10 to 20 percent, whereas in others the resistors must be within 0.01 percent or less of their nominal values.

For use as heaters, resistors are usually made of special alloy wire that will withstand high temperatures for long periods of heating. The most used alloy for this purpose is of nickel and chromium, with or without the addition of a considerable amount of iron. These alloys can be kept at a "red heat" in air for long periods of time without damage from oxidation. High-resistance units for radio circuits are often made from a nonconducting binder, such as clay, with which is mixed sufficient powdered graphite to make the material slightly conducting; or from a nonconducting rod on the surface of which is deposited a conducting film. For resistors to be used in precision instruments the important quality desired is stability with time and temperature. Stability with time and temperature are also the important characteristics required for resistors that are to be used as reference standards for the calibration of other resistors.

Standard resistors are usually commercially available in decimal multiples or fractions of the unit, usually from 0.0001 ohm to 1 Megohm. These are of two general types of construction, either two-terminal or four-terminal types. For values of resistance where the resistance of the contacts, made in connecting to the resistor, is not negligible, it is customary to use four-terminal resistors. Whether or not the contact resistances are negligible depends upon the accuracy desired, but in general standard resistors of 1-ohm and less of the four-terminal type, higher valued resistors needing only two terminals. Special standard resistors are required if an accuracy of better than 0.01 percent is required. These are usually sealed to protect the resistors from the effects of oxygen and moisture in the atmosphere, whereas resistors for an accuracy of 0.1 percent do not require such protection. Although precision resistors are ordinarily adjusted to their nominal values to 0.01 percent or better, they gradually change in resistance with time.

For work to this accuracy it is desirable to have standards recalibrated occasionally, applying if necessary corrections corresponding to their departure from nominal values.

EFFECTS OF HUMIDITY

It has long been known that wire wound resistors undergo seasonal variations in resistance, being higher in resistance in summer and lower in winter. This effect is most noticeable in high resistance coils of small wire, and even in high-grade resistors may amount to several hundredths of a percent of the resistance. The effect is to a large extent, a result of changes in average humidity, and is greatest in climates where there is a large difference in humidity between winter and summer. This seasonal change was first observed in the case of manganin resistors made with silk-covered wire. The accepted explanation was that the resistance changes resulted from dimensional changes of the shellac with which the coils were impregnated, as the shellac absorbed or gave off water vapor.

The effect of moisture on resistors has been thoroughly investigated by Dike, who came to the conclusion that the effect of changes in humidity is to change the tension in the silk with which the wire is customarily insulated. This change in tension changes the pressure transmitted to the wire by the insulation and changes the resistance. He also found that the effect of humidity on cotton insulation is opposite to that on silk, and by using a mixture of cotton and silk fibres for insulating the wire he was able to eliminate most of the seasonal changes in resistance that result from changes in humidity.

For standard resistors the effect of humidity may be also eliminated by mounting the coils in sealed containers. This procedure was first advocated by Rosa who designed the resistor shown in Figure 5, known as the NBS type of standard resistor. In this figure, *R* represents the manganin coil mounted on a silk-insulated brass spool and baked. This coil is supported from the hard-rubber top, *T*, by means of the thermometer tube, *W*, which is so arranged that a thermometer can be inserted from the outside. The copper lead wires, which are silver-soldered to the ends of the resistance coil, are in turn soft-soldered to the copper binding posts, *B*. The hard-rubber top is screwed into the metal container, *C*, which is filled with a good quality light mineral oil. The binding posts, thermometer well, and the threads by which the hard-rubber top is connected to the container are all sealed with shellac, which is not soluble in oil.

The purpose of the oil is to give good thermal contact between the resistor and the case and to facilitate the dissipation of the heat developed in the resistor by the current through it. In addition, the oil increases the heat capacity of the resistor, increasing the current that it can

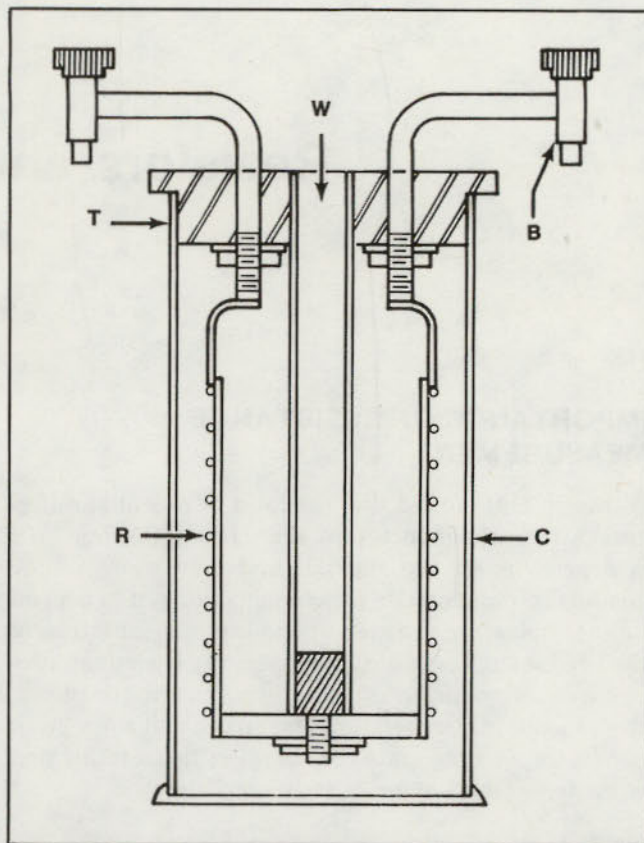

Figure 5. NBS type standard resistor.

carry temporarily without overheating. The objection to the oil is the fact that it may in time become somewhat acid, and the acid may corrode the resistance wire or injure the insulation.

The advantage of ready dissipation of heat combined with the advantage of hermetic sealing is found in the double-walled type of standard resistor developed at the Bureau. In this type the container is made of coaxial cylinders only slightly different in diameter with the space between the cylinders sealed. The resistance element is mounted in this sealed space in good thermal contact with the smaller cylinder, which serves as the inside wall of the container. One of these resistors is shown in Figure 6. The outside diameter of the container is 9 cm and its length 13 cm. The series of holes near the top are just above the double-walled part and are intended to increase the facilities for cooling, and the containers are left open at the bottom for the same purpose. These double-walled resistors readily give up heat to an oil bath yet are not affected by humidity changes. The sealed space in which the coil is mounted is filled with dry air, and no oil comes in contact with the resistance material.

The seasonal changes in resistance of standard resistors that arise from changes in humidity are eliminated, as has just been discussed, by sealing in metal containers. This arrangement is not satisfactory for large instruments and

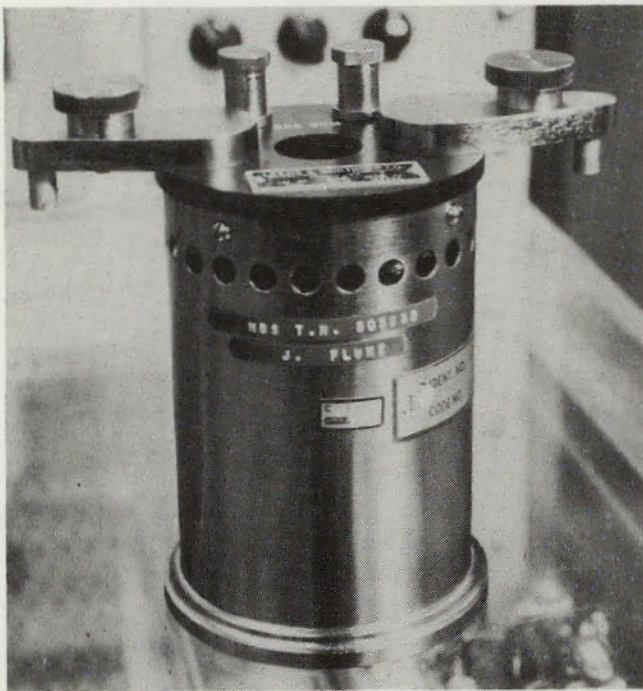

Figure 6. Double-walled standard resistor.

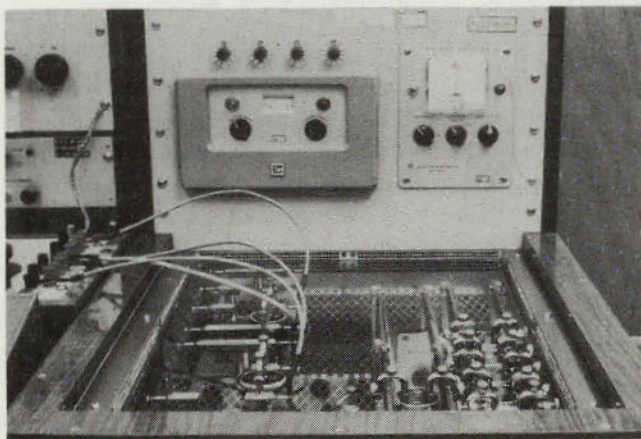

Figure 7. Resistor bath.

measuring apparatus, which are not sealed. If the case of such equipment are reasonably tight a drier, such as calcium chloride, may be kept inside the case. This procedure is somewhat hazardous, since if not replaced with a sufficient frequency the drier may become dissolved in absorbed water and be spilled on the coils. The use of silica gel avoids this danger. A more satisfactory method is to mount a heater in the apparatus and, by means of a thermostat, maintain the temperature of a metal box containing important resistors at a constant value, above that of the laboratory. In this way the relative humidity is kept always low and seasonal variations may be reduced. Additional advantages are that no temperature corrections need be applied when calibration is made under conditions of use, and that resistors will usually be more stable in resistance if kept at

a constant temperature instead of being allowed to follow variations in laboratory temperatures.

STABILITY OF RESISTORS WITH TIME

In applications where stability with time is of importance, as for instance for standard resistors or precision measuring apparatus, manganin is used almost exclusively. In such applications low temperature coefficients of resistance and small thermal emf's against copper are usually also required, and few alloys other than manganin are suitable.

Most national standards laboratories keep a selected group of manganin resistors, which are regularly intercompared and used for maintenance of the unit of resistance. The relative values of such standards are remarkably constant, the individual resistances not changing by more than one or two parts in a million per year with reference to one another and for some groups very much less. It is supposed that the average of a group remains constant to a high degree, but such stability can be only assumed. No method of measurement has been used that would detect with certainty changes of less than 10 or 20 parts in a million in the group as a whole. The international ohm was defined as the resistance of a mercury column of specified dimensions at the temperature of melting ice. However, such resistors have not been constructed with sufficient accuracy to demonstrate the performance of manganin resistors used to maintain the unit. Likewise, absolute ohm determinations have not been sufficiently reproducible to give such information. If the unit, as maintained by means of manganin resistors, were tested every ten years by comparing against mercury ohm or absolute ohm determination, the apparent change would probably not exceed 10 or 20 parts per million.

The average user of standard resistors is interested in the stability that may be expected from standards available commercially. In this connection, an analysis made since 1965 at NBS is relevant. Of nearly 600 standard resistors that had been submitted more than once to NBS for test, the average yearly change in resistance was found to be 8 ppm. Of the total only 2 percent averaged greater than 60 ppm per year, and for nearly 90 percent of all standards tested the annual change was 10 ppm or less. If signs were neglected there was no significant difference between the average yearly change of sealed and unsealed resistors. This would appear to mean that sealing merely reduces seasonal variations without improving the long-time stability. However, if regard is taken of sign, the performance of sealed and unsealed resistors was quite different. In this case the average yearly change was about -0.3 ppm for sealed and about $+5$ ppm for unsealed standards. That is to say, sealed standards about as often decrease as increase in resistance with time, whereas the change in unsealed standard resistors is predominantly upward.

5

Methods of Comparison of Resistors

AMMETER-VOLTMETER METHODS

Precise measurements of electrical resistance are made with comparative ease with bridge methods, an accuracy of a few parts in a million being readily obtained in the comparison of nominally equal resistances of say 10 or 100 ohms. Although the actual measurements are rather simple, special apparatus is required. For many types of resistors high accuracy is not desired and the measurements may be made with deflecting instruments, which are usually available in electrical laboratories. The most common method, where an accuracy of 1 or 2 percent is sufficient, is the ammeter-voltmeter method. In this method a measured current is passed through the resistor under test, and the potential difference across its terminals is also measured. The current is measured with an ammeter and the potential difference by means of a voltmeter, the resistance in ohms being the ratio of the voltmeter reading in volts to the ammeter reading in amperes, in accordance with Ohm's Law.

The accuracy that may be attained by the ammeter-voltmeter method depends upon the accuracy of the two instruments.

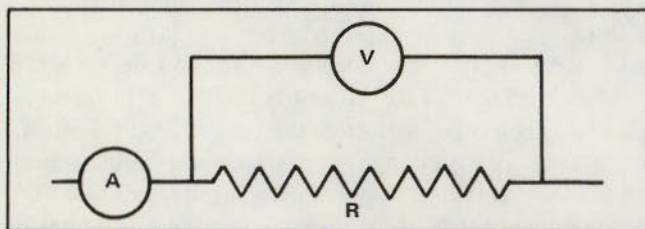

Figure 8. Connection for ammeter-voltmeter measurement of resistance.

OHMMETERS

Ohmmeters are instruments for indicating directly on a scale, with a minimum of manipulation or computation, the resistance of the circuit connected across their terminals. They are available in a wide range from milliohmmeters reading 0.001 ohm to megohmmeters reading to 50,000 megohms. Their accuracy is limited both by the calibration and reading of the indicating instrument and in the simple ohmmeter by their

dependence upon a fixed value of voltage. They are, in general, not suited for applications requiring high precision such as the determination of temperature rise or of the conductivity of line conductors. When used with circuits that are highly inductive or capacitive, the precautions appropriate for such resistance measurements should be observed.

Ohmmeters may be classified according to either their principles of operation, their source of energy, or their range.

The principles commonly used are: Simple ohmmeter, ratio ohmmeter, Wheatstone bridge.

In the simple ohmmeter a source, the voltage of which is assumed to be definite and to correspond to the calibration of the instrument, is applied to the unknown resistor and the resulting current causes an indicating instrument to deflect over a scale. This scale is so graduated that the pointer indicates directly the resistance in ohms (or megohms). In many cases provision is made by a magnetic or electric shunt to adjust the instrument at one point, usually at zero resistance, to fit the existing value of the voltage. In some of these instruments the final indication is by a vacuum-tube voltmeter, which measures the drop produced in a very high resistance by the current through the specimen.

In the ratio meter or "crossed-coil" type of ohmmeter, the current through the unknown resistor flows in one of the coils, while the other carries a current that is proportional to the voltage. The current is led to the coils by ligaments, which exert a negligible torque so that the moving system takes up a position that depends on the relative magnitude of the currents in the two coils. The scale can therefore be laid out to indicate resistance directly, and the indication will be independent of the voltage used, provided that the resistor under test obeys Ohm's Law.

The designation "ohmmeter" is also applied to certain forms of the Wheatstone bridge in which the dial that adjusts the balance is calibrated to read directly the value of the unknown resistance.

POTENTIOMETER METHOD

Potentiometers are also suitable for the measurement of potential difference when it is desired to avoid drawing a current from the source of potential difference. They are especially good in cases where an accuracy of 0.1 percent or better is required, as such accuracy is difficult to attain with deflecting instruments. Where a potentiometer is available, the ammeter-voltmeter method may be modified so as to use the potentiometer to measure the current through the unknown resistor as well as the potential difference across it. This requires the replacement of the ammeter with a standard resistor, and the measurement of the potential difference across the standard resistor yields the value of the current if this potential difference is divided by the value of the resistance of the standard.

Actually, if a suitable standard resistor is available, it is unnecessary to calculate the current through the unknown resistor. If the same current flows through the known and the unknown resistor, the ratio of the potential differences across the two is the same as the ratio of the resistances.

High accuracy in the measurement of resistance can be attained with the potentiometer method if a good potentiometer and good standard resistors are used. It has an advantage over the ordinary Wheatstone bridge in that the resistance, in terms of which the unknown is measured, may be that of an actual standard resistor instead of one of the coils of the bridge. Standard resistors are so mounted that they are ordinarily more constant in resistance and more accurately known than are unsealed coils usually used in bridges. The potentiometer method, however, is more difficult to use as the currents through the potentiometer and in the measuring circuit must both be kept constant, whereas the balance of a Wheatstone bridge is independent of the current flowing through it. In comparing resistors, the accuracy of a potentiometer is not dependent upon the accuracy of calibration of the standard cell used with the instrument.

A type of measurement for which the potentiometer method is especially well suited is for the measurement of four-terminal resistors.

DIFFERENTIAL-GALVANOMETER METHOD

The differential galvanometer was formerly used rather extensively for the comparison of equal resistances. Such a galvanometer has two separate windings made as nearly the same as possible, so that when equal emf's are applied to the terminals of the windings, equal and opposite torques are produced on the deflecting element. The windings are constructed with two wires side-by-side, wound at the same time and symmetrical with respect to the magnetic circuit.

For the moving-magnet galvanometer the field coils are wound in duplicate, and a small movable coil is usually connected in series with one winding. This moving coil is adjusted in position to compensate for any lack of equality of the fields produced by the two windings. Unfortunately this adjustment is different for different conditions of use. Moreover the differential galvanometer, of the moving-magnetic type, has the same handicaps as others of the moving-magnetic type. That is to say, the damping is difficult to control and precautions must be taken to avoid magnetic disturbances from external sources.

Many of the troubles of the moving-magnetic galvanometer are avoided in the D'Arsonval, or moving-coil galvanometer, and this coil may be made in duplicate for differential use. However, this requires two sets of leads from the moving element, which are difficult to arrange, and which also stiffen the suspensions and lower the sensitivity. With the need for greater and greater precision, the differential galvanometer has been gradually discarded, but it still is very satisfactory for some types of measurements.

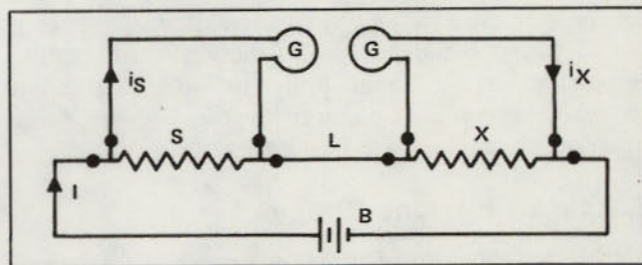

Figure 9. Connections of differential galvanometer.

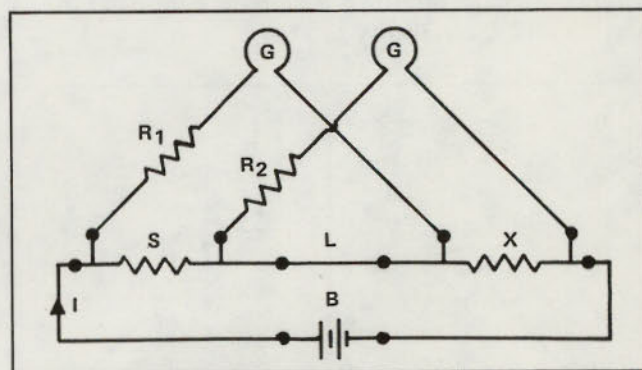

Figure 10. Kohlrausch's connection of differential galvanometer.

BRIDGE METHODS

By far the largest proportion of measurements of electrical resistance are made by means of bridge methods. For resistors above 1 ohm the simple Wheatstone bridge is used, whereas for 1-ohm resistors and below the Kelvin double-bridge is more suitable.

The choice between the simple and the double bridge is usually made on the basis of the required accuracy.

Where accuracy is required, low-valued resistors are usually of the four-terminal type. For these, two leads are soldered or brazed to each end of the resistance material, as shown in Figure 11. The resistance in

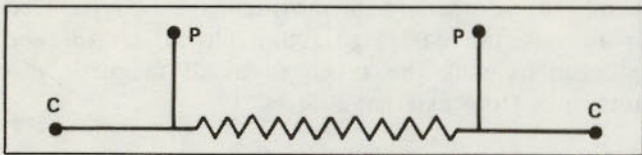

Figure 11. Four-terminal resistor.

question is that between the branch points at the two ends. That is to say, the resistance is the ratio of the potential difference between the terminals P, P to the current flowing in and out the current terminals, C, C . Methods of measurement are used that any effect from the lead resistances is avoided or reduced to a negligible amount. For such a purpose the potentiometer method is suitable, as no appreciable current is drawn through the potential leads, and the potential drop between branch points is independent of the lead resistances in the current circuit. Double-bridge methods balance out the lead resistances or connect them in high resistance branches where they are negligible.

Simple Wheatstone Bridge

The simple Wheatstone bridge is primarily a group of four resistors connected in series-parallel as shown in Figure 12. A current, I , is passed through the two parallel branches, and G is a detector connected to the junctions of the resistors as shown.

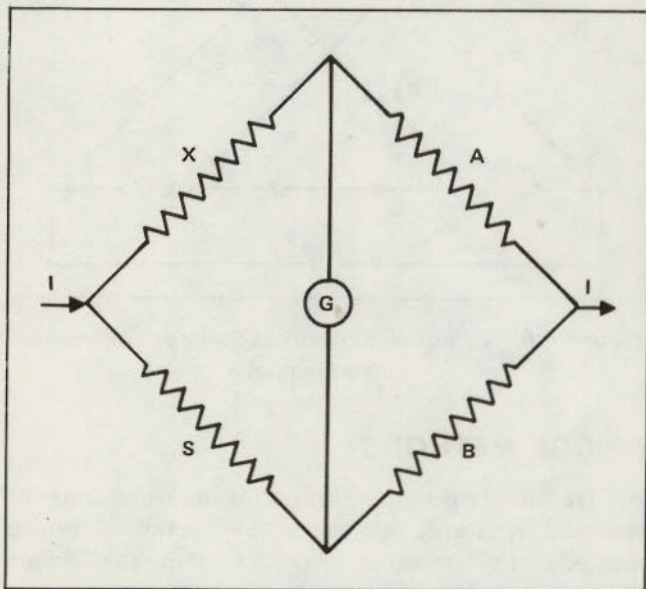

Figure 12. Wheatstone bridge.

The detector, G , is usually a galvanometer, and the lack of a potential difference across it is evidenced by a lack of motion of the galvanometer coil if a switch or key in series with G is opened or closed.

Wheatstone bridges for the measurement of resistance to 0.1 percent are available commercially at moderate prices. To this accuracy these can usually be relied upon without the application of corrections to the readings. However, for measurements to 0.01 percent, corrections to the readings of the ratio arms and of the rheostat arm must usually be applied, and the bridge must be maintained at the temperature of calibration within a few degrees. Primarily because of the effects of changes in humidity, calibrations of a Wheatstone bridge must be made rather frequently if an accuracy of 0.01 percent is to be attained. This is especially true where there is a marked change in ambient conditions. For example, between winter and summer the ratio coils and the rheostat arm may each change by 0.01 percent or more, and the errors may be additive rather than compensating. The use of air-conditioned laboratories improves the performance markedly, but even then it is advisable to make occasional spot checks by measuring standard resistors. Whenever possible, ratio arms below 10 ohms or above 1,000 ohms should be avoided, as should rheostat readings in excess of 1,000 ohms. This means that the Wheatstone bridge is best suited for the measurement of resistance in the range 10 to 10,000 ohms.

When an accuracy greater than 0.01 percent is required, special bridges are required or special techniques are used. One of the best of the special methods is that of substitution, in which the unknown resistor is replaced with a standard resistor or resistors having the same nominal resistance as that of the unknown. The bridge that is being used is relied upon to determine only the difference between the standard and the unknown, and this difference need not be accurately measured. Nearly any good bridge can be so used without calibration, provided contact resistances are sufficiently constant that readings can be repeated to the desired precision. It is evident that the calibration of the measuring bridge is of least importance when the standard and unknown resistances are nearest equal. Standard resistors are usually available only in decimal multiples or sub-multiples of an ohm and for many resistance measurements the lack of a suitable prevents the use of the substitution method.

Mueller Bridge

For the accurate measurement of odd-sized resistances, one of the best bridges is that designed by E.F. Mueller of the National Bureau of Standards for use in resistance thermometry. This is a special bridge intended for the accurate measurement of resistances up to about

110 ohms. The effects of humidity changes are greatly reduced by mounting the resistors in a compartment that is electrically heated and whose temperature is maintained at 35°C by means of a thermostat. As this is a temperature to which the laboratory temperature seldom rises, the relative humidity in the compartment housing the resistors is kept low and variations in the low humidities have little effect on the resistance of the coils.

For the Mueller bridge the ratio arms are equal, and the arms can be interchanged to test the equality. A small slide wire is connected between the ratio coils, and the sliding contact is used as the branch point for the bridge as shown in Figure 13. The operator can set the ratio

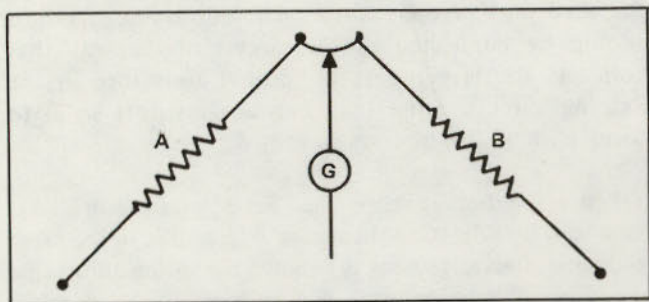

Figure 13. Ratio arms of Mueller bridge.

arms to equality by properly proportioning the resistance of the slide wire between the two ratio arms by changing the setting of the slide contact. This setting is correct if no change in the bridge results when the arms *A* and *B* are interchanged. The remaining two arms are the adjustable rheostat and the unknown resistor, which must be the four-terminal type.

The rheostat arm of the Mueller bridge is adjustable in steps as small as 0.0001 ohm. In order that such steps should not be masked by changes in contact resistance, special types of decades are used. The 0.0001-ohm-per-step decade is approximately as shown in Figure 14.

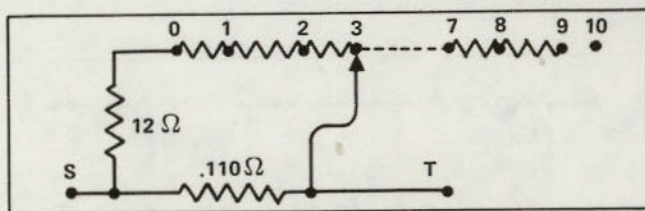

Figure 14. Shunt-type decade.

When the switch contact is moved to stud 1, the 12-ohm branch is increased sufficiently to increase the parallel resistance from 0.1090 to 0.1091 ohm, an increase of 0.0001 ohm. Thus the resistance between the terminals *S* and *T* may be increased in steps of 0.0001 ohm, although the value is not zero when the switch is set to read zero.

The 0.001- and 0.01-ohm-per-step decades are made in the same way as the 0.0001-ohm decade.

The purpose of the shunted type of decade that was described is to reduce the effect of variations in contact resistances and transient emf's in the switch.

The 1-ohm and 0.1-ohm steps of the rheostat arm are not made of the shunt type, as the resistance, with the dial set on zero, would be rather large. The contact resistances for the 1-ohm dial are thrown into the ratio arm *A*, as shown in Figure 15. The bridge current is introduced through the 10 1-ohm coils of this decade, and the switch merely changes the point of connection of the ratio arm, without opening the circuit of the 1-ohm decade.

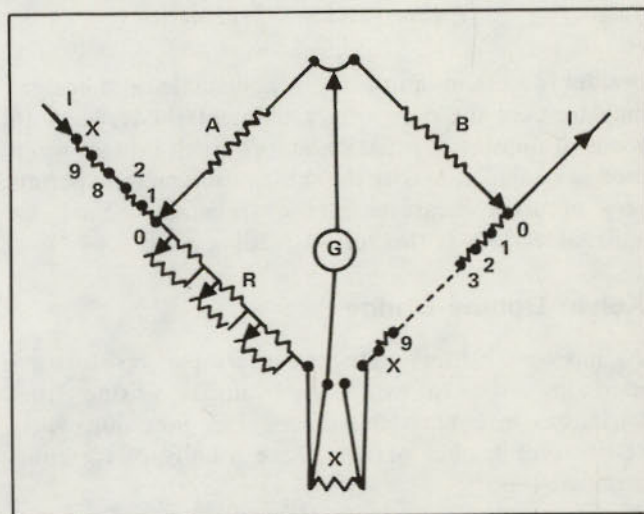

Figure 15. Switch connections for Mueller bridge.

The 10-ohm-per-step decade of the rheostat, not shown, is the only one that has contact resistances directly in series with the arm. A special type of dial that has amalgamated contacts is used for this purpose. For Mueller bridges available commercially, the galvanometer and battery are interchanged from the positions assumed in the above discussion. This in no way affects the validity of the conclusions.

Adjustable-Ratio Bridges

For comparing nominally equal resistances, bridges are sometimes constructed in which the ratio is adjustable.

An adjustable-ratio bridge is very convenient for use in sorting large numbers of resistors that must be equal within given tolerances. Such a bridge may be constructed as shown in Figure 16, where *A* and *B* are the two arms of a resistance ratio that is adjusted by changing *A*. A resistor is connected to the binding posts *S*, and the resistors that are to be compared with it are connected in turn to the *X* terminals.

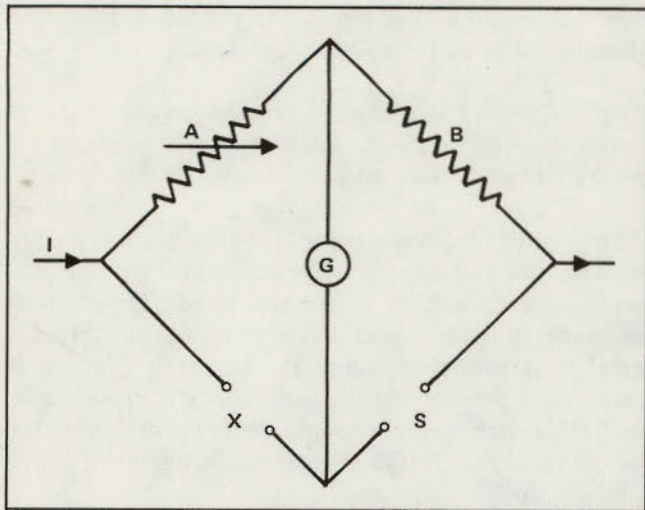

Figure 16. Limit bridge.

Besides this use in limit bridges, adjustable ratio bridges may be used for precise measurements of resistors in terms of nominally equal standards. Such bridges when used in conjunction with the substitution method permit very accurate measurements of resistance. Such an adjustable ratio is the "direct-reading ratio set."

Kelvin Double-Bridge

As has been already stated, four-terminal resistors are used in order to avoid uncertainties arising from variations in contact resistances. For precision work, resistors of 1 ohm or below are usually of the four-terminal type.

For measurement, a four-terminal resistor is usually connected in series with a four-terminal standard. The ratio of the potential differences across the two resistors is then determined when a current flows through the two. This ratio may be determined by means of a potentiometer or in terms of a resistance ratio by means of the Kelvin double-bridge.

The circuit of the Kelvin double-bridge is shown in Figure 17, where X and S denote the unknown and

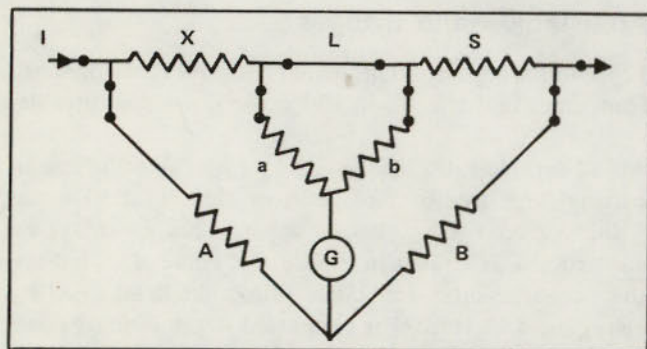

Figure 17. Kelvin double-bridge.

standard resistors, each with both current and potential terminals. The two are connected by means of a conductor L , preferably of low resistance as compared with X or S . The resistors A and B and also a and b provide resistance ratios that must be known, as must also be the value of S . This bridge is balanced if there is no change in the deflection of the galvanometer when the current circuit is opened or closed.

When a double-bridge is to be balanced by means of an adjustable standard, care should be taken in connecting up such a standard in order to keep the resistance small between it and the unknown. Adjustable standards are usually made so that the position of one or both of the potential terminals is adjustable. As a result, varying amounts of resistance are left at the ends in series with the used part of the resistor. The adjustable standard should be connected in the circuit in the way that connects the larger part of unused resistance in the external circuit rather than between resistors so as to form part of the link resistance, L .

When a fixed standard is used for S , and the bridge is balanced by adjusting the ratios A/B and a/b , the most convenient arrangement is to have the ratios adjustable together. This is accomplished by having the same dial handle operate two dials together so that both ratios are changed simultaneously. This arrangement requires special apparatus, but such double-ratio sets are commercially available.

In work of the highest accuracy, account must be taken of the resistance of the leads that are used to connect the ratio arms to the unknown and standard resistors. There is also lead resistance in these resistors, between the branch points and the terminal binding posts, which is not necessarily negligible. One way of taking these lead resistances into account is to use such high resistances in the ratio arms that the connecting leads have a negligible effect. Usually this reduces the sensitivity of balance of the bridge. A better arrangement is to make the lead resistances adjustable and select their ratio in such a way as to balance out their effects.

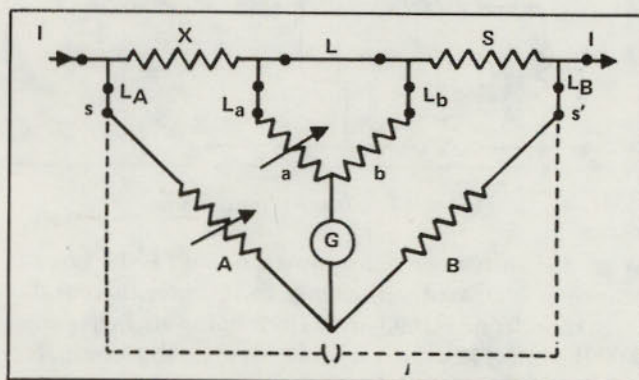

Figure 18. Kelvin double-bridge.

6

Special Apparatus for Precision Measurements

DIRECT-READING RATIO SET

The problem of calibrating precision resistance apparatus usually involves the comparison of resistors in the instrument with standard resistors of the same nominal value. This is most readily done by some substitution method, which is usually a method for determining differences between the resistances of the unknowns and of the standards. For well-adjusted instruments, the differences are small and need to be determined only approximately.

One of the most convenient instruments for the measurement of such differences in ratio is the "direct-reading ratio set." With this comparatively inexpensive instrument and a group of standard resistors, it is possible to calibrate accurately most types of resistance apparatus such as Wheatstone bridges, potentiometers, resistance boxes, etc.

The direct-reading ratio set is merely an adjustable resistance ratio with which bridges may be assembled, the remainder of the bridges being ordinary laboratory equipment. In its simplest form the ratio set is as shown in Figure 19. The resistor *B* is a 100-ohm coil, which constitutes the fixed arm of the ratio. The adjustable arm consists of a fixed resistor of 99.445 ohms and three dials, *D*₁, *D*₂, and *D*₃. The dial *D*₁ consists of ten steps of 0.1 ohm each, and *D*₂ and *D*₃ have ten steps each of 0.01 and 0.001 ohm respectively.

Although the ratio set described is correct in theory, variations in the resistances of the contacts of the dial switches would make the readings uncertain by several steps on the lowest dial when ordinary dial switches are used. The use of mercury switches will reduce the

variations to a few microhms, but such switches are somewhat difficult to operate and keep in condition.

To avoid difficulties from variations in switch-contact resistances the design is usually modified so as to reduce their effect. This is done by placing the switches in high-resistance shunt circuits that require comparatively large changes in resistance to obtain small changes in the parallel resistance, as was done in the rheostat of the Mueller bridge. The shunt circuits may be made sufficiently high that switch contact variations are negligible even when switches of moderate quality are used. An example of a shunted dial for obtaining steps of 0.1 ohm is shown in Figure 20.

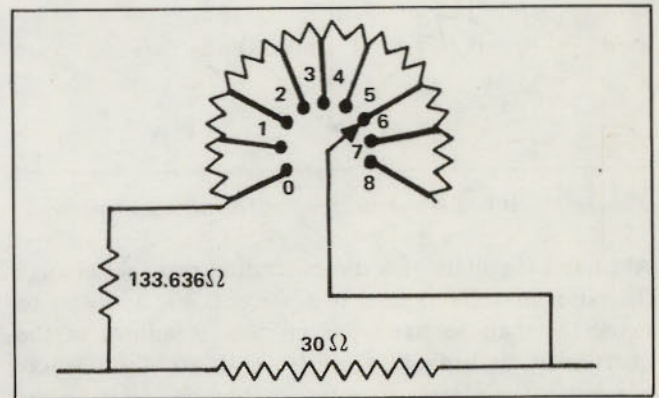

Figure 20. Shunt-type decade.

Comparison of Two-Terminal Resistance Standards, Substitution Methods

In nearly all measurements where the highest possible accuracy is desired, a substitution method is used. That is, the change required to restore balance after replacing

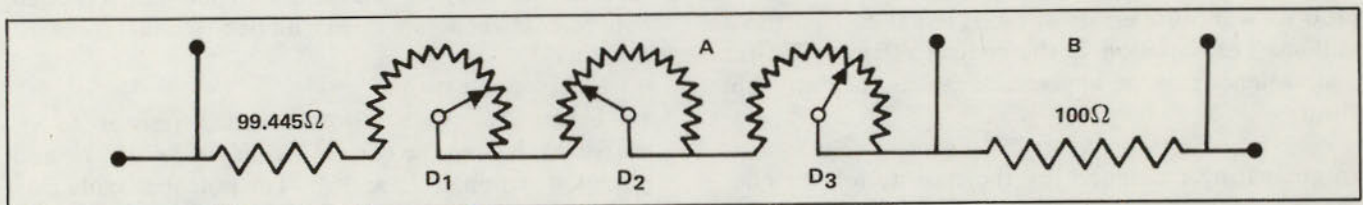

Figure 19. Direct-reading ratio set.

a standard with an unknown is measured. In comparing two-terminal standard resistors by substitution, the direct-reading ratio set is very rapid and convenient, and accurate results may be obtained. For this comparison a Wheatstone bridge is set up as shown in Figure 21. *A* and *B* are the two arms of the ratio set, and *Y* is an auxiliary resistance of the same nominal value as the standard resistors under comparison. The two resistors are in turn placed in the mercury cups *Q*, and the bridge balanced by varying the ratio *A/B*. The difference in the ratio for the two balances gives the percentage difference between the two standard resistors. Actually the difference is determined in percentage of the arm *Y*, but for small differences any departure of *Y* from its nominal value is of no consequence.

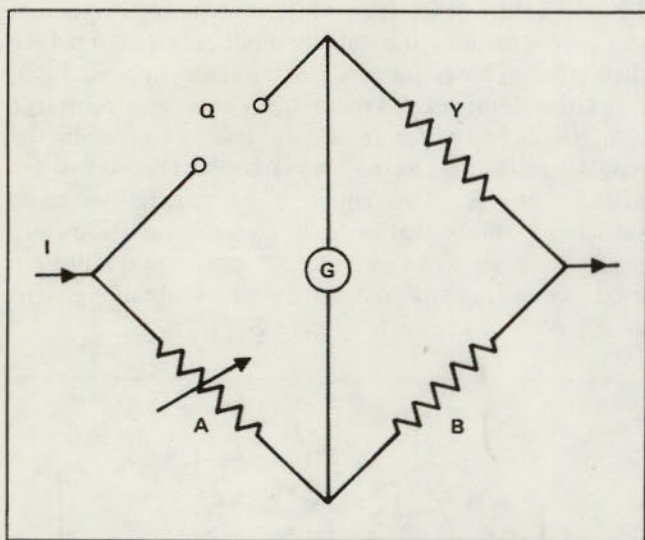

Figure 21. Wheatstone bridge for substitution method.

Although the dials of a direct-reading ratio set change the ratios in decimal parts of a percent, it is desirable to mark the dials in parts per million. Readings of the instrument and data taken from it are then whole numbers of moderate sizes rather than decimals. In the discussion that follows, it is assumed that the ratio set is marked in parts per million, and that corrections to resistors are also expressed in parts per million. Bridge readings and corrections to standards are then readily added and subtracted and calculations are greatly simplified.

In comparing nearly equal resistances by substitution, the lack of correct adjustment of the coils of a well-made ratio set will cause errors of much less than 1 part in a million. The variation in the contact resistance of the dial switches may be appreciable unless they are kept clean.

In comparing resistances by the substitution method, the two balances of the ratio set should be made quickly so that temperature changes will not cause variations in

the ratio set between readings. It is best to have all coils of the ratio set made from the same lot of resistance material. If this is done the manganin coils are used, a change in temperature of 1 °C should not change the ratio more than 2 or 3 parts in a million.

In spite of these sources of error, it is probably possible to compare standard resistors ranging from about 10 ohms to 1,000 ohms to within 1 or 2 parts in a million by the use of this ratio set. This, of course, requires that the set be well constructed, that a fairly sensitive galvanometer be used and that the resistances differ by not more than about a tenth of a percent. With resistances less than 10 ohms, the resistance of the mercury cup contacts may cause trouble. For this reason standard resistors smaller than 10 ohms are now almost always four-terminal resistors.

Another method for comparing nominally equal two-terminal standard resistors is what might be called a double substitution method. In this latter arrangement, the two resistors under comparison are used to form two arms of a Wheatstone bridge, the ratio set forming the other two arms. The resistors are both mounted in mercury cups so that they may be interchanged without affecting lead resistances in series with them. After a balance is obtained by adjusting the ratio set, the resistors are interchanged, and a new balance is obtained. The percentage difference between the two resistors is half the difference between the two readings of the ratio set. This method is used for the same range of resistances as those measured by the simple substitution method, and about the same accuracy may be attained.

Comparison of Four-Terminal Resistances With Two-Terminal Resistance

The direct-reading ratio set is convenient for the comparison of two-terminal with four-terminal resistances. Although the occasion seldom arises for the comparison of two-terminal with four-terminal standard resistors, it is often necessary to compare a standard resistor of one type with a resistance coil of the other type. In measuring the coils of many pieces of electrical apparatus it is impossible to make connection with the coils except through comparatively large connecting resistances. However, it is possible to make potential connections to the two ends of the coils and measure them as four-terminal conductors. In doing so, it is often convenient to compare them with two-terminal standard resistors.

In Figure 22, *X* is a four-terminal resistor to be measured, having the current terminals *T*₁ and *T*₂, and potential terminals *P*₁ and *P*₂. The potential leads may contain considerable resistance in addition to that of the leads. *A* and *B* are the two arms of the direct-reading

ratio set, and M_1 and M_2 are mercury cups into which either a two-terminal standard resistor or a short circuiting link may be placed.

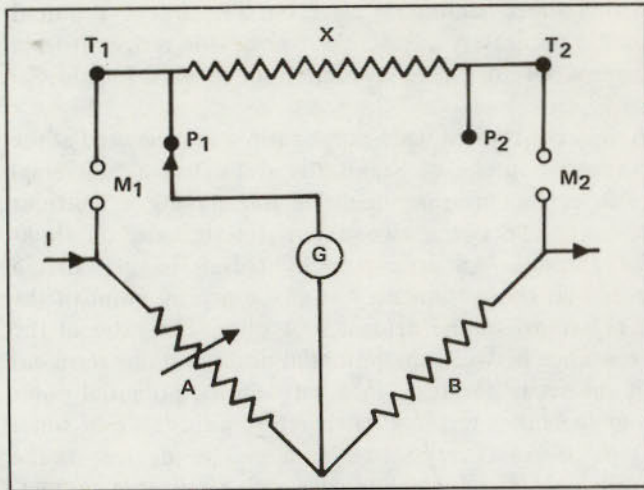

Figure 22. Measurement of 4-terminal resistor.

Suppose we start with the galvanometer connected at P_1 , a standard resistor nominally equal to X inserted in M_1 , and with M_2 shorted. We then have a simple Wheatstone bridge, which is balanced by varying the setting of the ratio set. After this balance is obtained, the galvanometer connection is shifted to P_2 , and the standard resistor is placed in M_2 , M_1 being shorted with the link. We again have a Wheatstone bridge but with the standard resistor and unknown interchanged. This interchange has been obtained without making any change in the resistance of the leads of the measuring circuit, except for possible variations in the resistances of the mercury cup contacts, which will be small if the mercury contacts are clean. The bridge is now again balanced by means of the ratio set. The percentage difference between the unknown and the standard resistor is half the difference in reading of the ratio set for the two balances. Unless the resistances under comparison are fairly large, it will be necessary to take into account the resistance of the short-circuiting link. This is done by subtracting the link resistance from the resistance of the standard resistor and considering that the resistor has this new value and is being interchanged with a link of zero resistance.

The resistance of the link can be measured as follows: Connect the link between two 1-ohm resistors to form two arms of a Wheatstone bridge, using the direct-reading ratio set for the other two arms, as shown in Figure 23. L is the link, and A and B are the arms of the ratio set. Two balance readings are taken, first with the galvanometer connected at one end of L and then at the other. Half the difference in the readings is the value of the link resistance in percentage of the 1-ohm arms. If the link resistance is large, it may be necessary to use large resistances in place of the 1-ohm coils. This

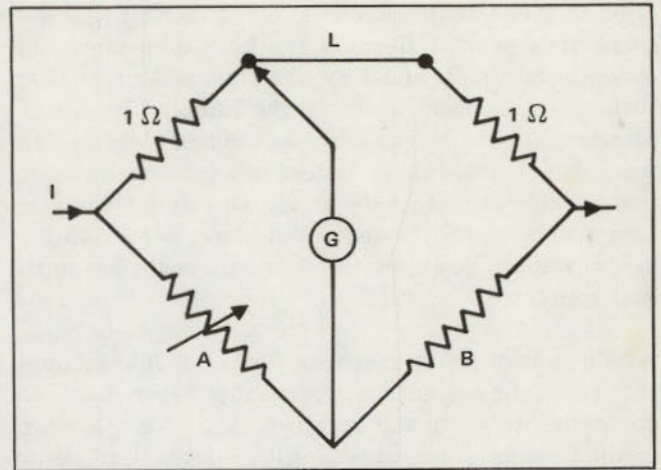

Figure 23. Measurement of lead resistance.

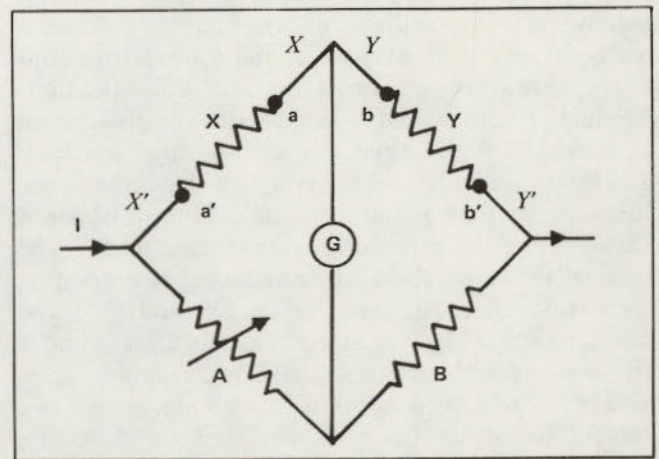

Figure 24. Lead resistance in Wheatstone bridge.

method is very convenient for the measurement of small resistances such as links, connecting wires, switch contact resistances, etc. It is not a precision method but usually is sufficiently accurate for the measurement of resistances such as those just mentioned, which are to be used in series with larger resistances.

Comparison of Four-Terminal Resistance Standards

Before taking up the question of the comparison of four-terminal standard resistors, let us consider briefly the effect of the lead wires of a simple Wheatstone bridge. In Figure 24, X and Y are nominally equal resistances, and A and B are the two arms of a direct-reading ratio set. The conductors x , y , x' , and y' are used to connect up the bridge, and we will also denote their resistances by x , y , x' and y' , respectively. The ratio of the resistances of the two arms containing X and Y is not the same as the ratio of X to Y because of the resistance of these connecting leads. If we could select leads so that the ratios x/y and x'/y' were the same as X/Y , the ratio of the two arms would be independent of the actual values of the lead resistances. The balance would be the

same as if the resistances of the leads were negligibly small. It is possible to make the leads adjustable and make the ratios x/y and x'/y' the same as X/Y . In fact, such an arrangement is used at the National Bureau of Standards to reduce the effect of the leads when using the Kelvin double-bridge. Instead of adjusting the leads, it is possible to balance the bridge with fixed leads, and then find what this balance would have been with the proper ratio of lead resistances, or with negligibly small lead resistances.

As a matter of fact, this scheme for taking into account the connecting leads is practically never used in comparing two-terminal resistors. As the substitution method requires no consideration of the lead resistances, except to see that they are reasonably small, it is generally used. However, in comparing four-terminal resistances with a simple Wheatstone bridge we follow exactly the steps outlined above. Figure 25 shows a bridge set up for this purpose. A and B are the two arms of the direct-reading ratio set. X and Y are the four-terminal resistors under comparison, with current terminals T_1 , T_2 , T_1' , and T_2' , and potential terminals P_1 , P_2 , P_1' , and P_2' . The bridge is balanced when connected as shown, and a second balance is obtained after shifting the galvanometer connector to P_2' . The third balance is obtained after now changing the current connections from T_1 and T_1' to P_1 and P_1' , and calculations are made as above. The two arms X and Y are now interchanged and the three readings again obtained. From these two sets of readings, we get two balance points on the ratio set. Half the difference between these two balance readings is the percentage difference between the two four-terminal resistors.

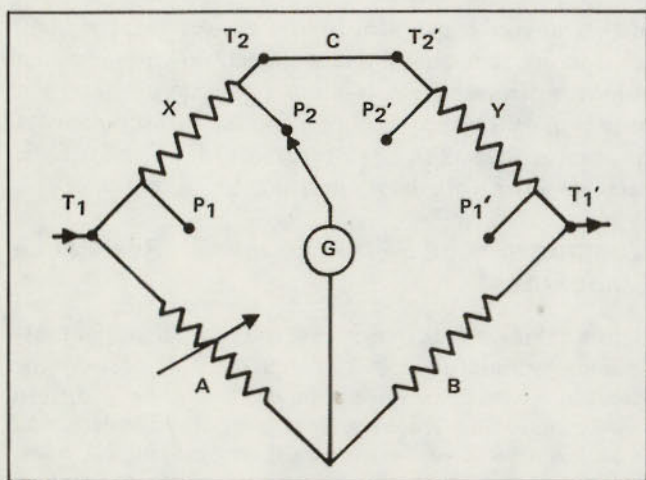

Figure 25. Comparison of 4-terminal resistors.

UNIVERSAL RATIO SET

Precision standard resistors are usually made only in integral multiples or submultiples of an ohm. Consequently odd-valued resistors usually cannot be

measured by a substitution method, except in a few cases where standard resistors can be combined to give a resistance nearly that of the unknown. The comparison of odd-valued resistors with standards is not possible with a direct-reading ratio set, but a ratio set is required that is accurately adjustable over a wide range, at least from a 1:1 to a 5:1, or preferably to a 10:1 ratio.

A very convenient wide-range ratio set is one used at the National Bureau of Standards and called a "universal ratio set". This instrument is one having a constant resistance, between two external terminals, of about 2,111 ohms. An arrangement of dials is such that a potential connection may be made at any point of the 2,111 ohms to the nearest 0.01 ohm. The ratio of the resistance between the potential point and one terminal of the set to the resistance between the potential point and the other terminal is therefore adjustable in small steps over a very large range. The device is the equivalent of a long slide wire with a movable contact, and its uses are similar.

Suppose it were desired to measure a resistance of say 6.8 ohms by comparing it with a 10-ohm standard resistor. The two resistors could be connected in series and the combination connected across a slide wire as shown in Figure 26, X being the unknown, S the

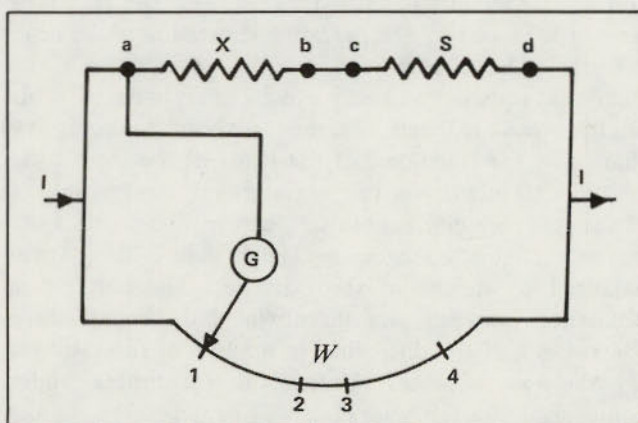

Figure 26. Comparison of resistors with slide wire.

standard, and X a slide wire. If a galvanometer, G , is connected to terminal a of the unknown and to the slide wire, a Wheatstone bridge is obtained that will balance with the slide wire at some point, 1, near the end. If now the galvanometer connection is changed successively to b , c , and d , successive balances will be obtained with the slide wire at 2, 3, and 4, respectively. The ratio X/S is then the same as $R_{1 \text{ and } 2} / R_{3 \text{ and } 4}$ where $R_{1 \text{ and } 2}$ and $R_{3 \text{ and } 4}$ are the resistances of the slide wire between the points 1 and 2, and 3 and 4, respectively.

It is very difficult to make a wire of sufficient length and uniformity that the ratio $R_{1 \text{ and } 2} / R_{3 \text{ and } 4}$ can be accurately

determined. Instead of a slide wire, the universal ratio set makes use of a group of wire wound resistors so that the resistances between the balance points 1, 2, 3, and 4 can be accurately known. The arrangement of its dials is as follows. The highest dial consists of twenty 100-ohm resistors in series, with the dial contact acting as the potential connection to the instrument, as shown in Figure 27. As the dial is rotated in a clockwise direction, the 100-ohm resistors are successively changed from the right to the left side of the contact. To change resistance from the right to left side in 10-ohm steps, two more dials are used, each having ten 10-ohm steps as seen in Figure 28. These two dials are operated by the same handle but with one dial increasing as the other decreases in resistance. The total resistance between *S* and *T* remains constant for any setting of the 10-ohm decades, and of course it is unaffected by the position of the 100-ohm dial switch that is merely a potential contact.

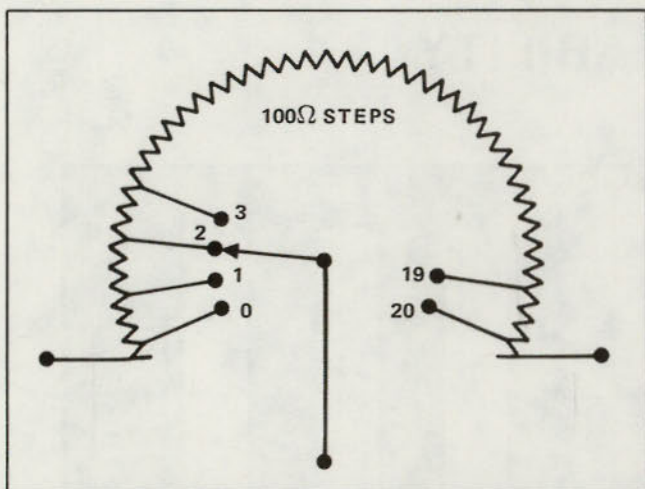

Figure 27. 100-ohm dial of universal ratio set.

Steps of 1, 0.1, and 0.01 ohm-per-step are obtained in the same way as the 10-ohm steps, with two decades of each denomination operating together, one on each side of the 100-ohm dial. This scheme for the change of the potential point along a fixed resistance is essentially the same as that of the Feussner type potentiometer. The large number of contacts in series limits its use for precision work to circuits having a rather high resistance.

The universal ratio set is used only for the determination of resistance ratios and hence may be calibrated in terms of any unit. It is most conveniently calibrated in terms of an average step on the highest or lowest dial. This is done by comparing each step of a decade with the ten steps of the preceding dial starting with the smallest dials. Only the steps on one side of the 100-ohm dial need be tested, as the function of the other group is to keep the total resistance constant. A check of the constancy of the over-all resistance needs to be made for all readings of the double dials.

The use of a universal ratio set is the same as that of a slide wire. It may be used in the measurement of four-terminal resistors and is especially convenient for the tests of potentiometers. The test of a potentiometer consists in the measurement of the ratio of the emf-dial resistance to the standard-cell resistance for all settings of the emf and standard-cell dials. These resistors are of the four-terminal type with potential connections brought out to emf and standard-cell binding posts. The method is satisfactory even when some resistance is common to both the standard-cell and main-dial resistance. The arrangement for such a test is shown in Figure 29. The ratio set, URS, which is shown as a slide wire, is connected in parallel with the potentiometer, the connection to the latter being made to the battery

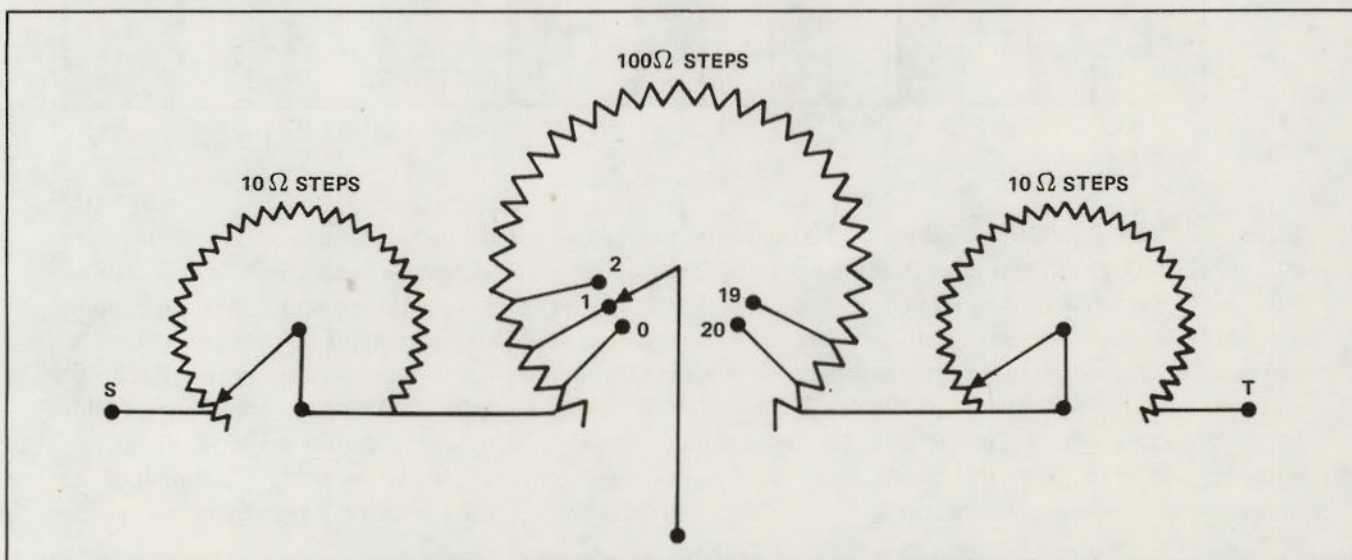

Figure 28. 100- and 10-ohm dials of universal ratio set.

binding posts, $BA+$ and $BA-$. Readings on URS are made with the galvanometer connected successively to the SC and EMF binding posts, for all settings of the EMF dials. It should be noted that changes in the EMF dials are merely changes in potential points and do not affect the readings obtained for the SC dial.

Potentiometers are provided with rheostats in the battery circuit for adjusting the potentiometer current. A change in this battery rheostat will change the differences in readings obtained on the universal ratio set but not the ratio of the differences. It is possible to make the ratio set direct-reading by adjusting the battery rheostat until the difference on the ratio set for the standard-cell posts is a decimal multiple, preferably 1.000, of the reading of the standard-cell dial.

Corrections for the EMF dials may then be read directly from differences across the EMF terminals.

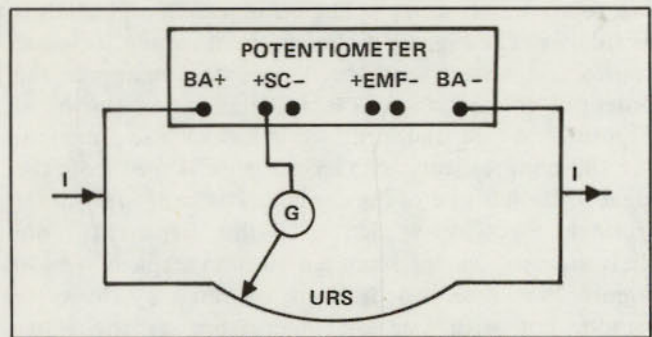

Figure 29. Check of potentiometer with universal ratio set.

NBS TRACEABILITY

CHRONOLOGY OF ACCURACY

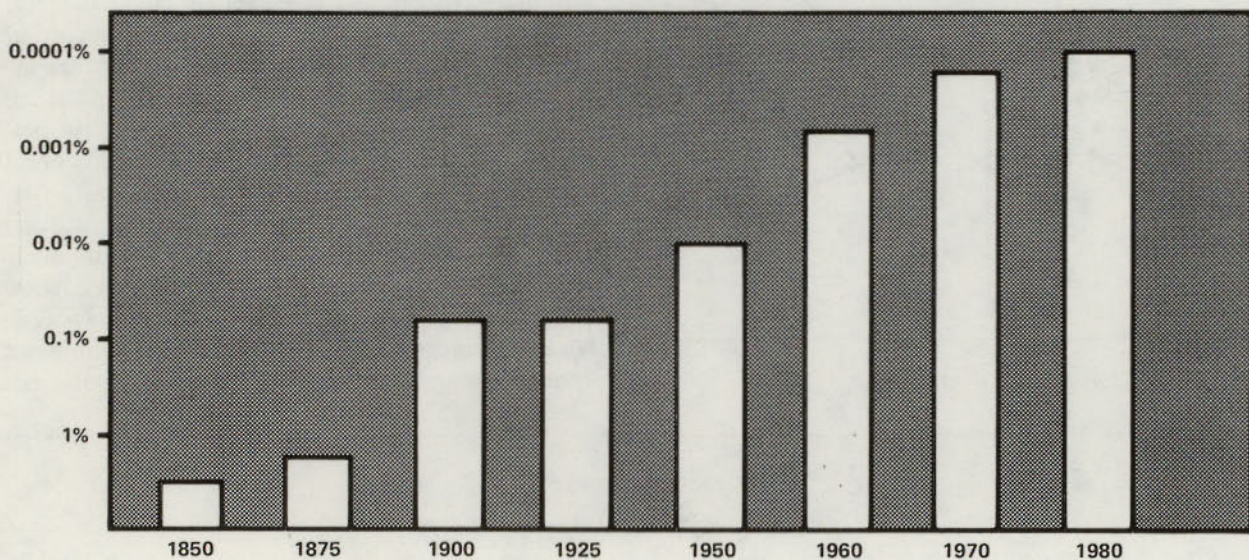

Figure 30.

Traceability to NBS (National Bureau of Standards) means the stated accuracy of an instrument has been established through calibration with equipment whose accuracies have been established directly or indirectly by NBS certified references. Any reference, as stated earlier, is a known and predictable quantity. We might point out that NBS must also periodically measure their reference devices. This is a complex process and will not be addressed in this manual except to briefly describe how the value of reference (standard) cell is measured. The volt is measured using Ohms law in which a current is forced through a precisely known resistor (0.06 ppm). This known voltage is now compared to the saturated cell utilizing an A.C. Josephson effect device, a precise and linear voltage to frequency converter. The United States legal volt is believed to be within ± 0.08 ppm of the International System of Units (the S.I. Volt). In practice, however, the laboratory typically considers the standard-cell voltage to be known to within ± 1 ppm.

7

Standard Cells

A group of standard cells constitutes a laboratory standard of electromotive force. When they are kept at a constant temperature, their short-term stability is very good indeed. Their long-term stability is not quite so good, and some of the cells are observed to drift slightly one way or the other. Unless they all drift the same way, it is reasonable to assume that the mean of the group is more stable than the constituent cells.

Every two or three years some of the cells should be recalibrated by a higher echelon laboratory so as to confirm or correct the assumed value of the mean. Thereafter, every month or so all the cells should be compared among themselves. This internal comparison serves three purposes.

First, it establishes the relative value of each cell with respect to the mean. This information is needed for practical calibrations involving the cell.

Second, it provides a history of each cell, which shows how much it has drifted. A small amount of drift can be tolerated, but a large and persistent drift is a warning that the cell may be a rogue which should be removed from the group before it affects the mean.

Finally, the internal comparison should yield evidence of its own precision.

INTRODUCTION

Standard cells are physical representations of the unit of electromotive force (emf), serve in the maintenance of the unit, and are used as standards with which the emf of other cells and systems and IR drops are compared. Together with standards of resistance (R) they are also used in the measurement of current, I . When measurements of electric power, P , are made in terms of standards for emf (E) and resistance, the expression for power, $P = E^2/R$, shows the necessity of knowing E accurately, since a small error in the standard for E would produce a percentage error twice as great in the value for the power, P .

Standard cells are electrochemical systems composed of two dissimilar electrodes immersed in an electrolytic

solution. They are not intended to supply electric current and, therefore, are of different design from those electrochemical systems which are intended for such purpose. Owing to their special use, standard cells are required to meet certain performance criteria and, for precise measurements, to have certain inherent characteristics. They must be reasonably reproducible, exhibit good permanency, possess low emf-temperature coefficients, have a low or moderately low internal resistance, be relatively insensitive to current drains of low magnitude, and, if possible, have an emf of convenient magnitude. Since a standard cell is a physical representation of a unit it is obvious why permanency is of prime importance in a standard cell. The precision with which the emf of standard cells is measured, according, exceeds that normally required for the other types of galvanic cells.

THE UNIT OF ELECTROMOTIVE FORCE

The practical unit of emf, the volt, is not an arbitrary one but like the other electrical units is derived from the basic mechanical units of length, mass, and time using the principles of electromagnetism with the value of the magnetic constant (the so-called permeability of free space) taken as $4\pi/10^7$ in the rationalized mksa (meter-kilogram-second-ampere) S.I. system of units. It has been customary, following the first use of the term by Gauss, to refer to electrical units based on the basic units of length, mass, and time as absolute electrical units. The transition from arbitrary to absolute units began with the work of Gauss in 1833 and of Weber in 1851, who showed that it was possible to measure electrical quantities in terms of mechanical units. Weber pointed out the desirability of making the electrical units consistent with those used in other branches of science and engineering.

The unit of emf, although a most important unit, is obtained from the ohm and the ampere. To date, no direct absolute measurement of emf in the em system of units has been found feasible. Instead its value is established experimentally in em units through Ohm's law and the measurement of the fall of potential produced in a resistance by a current, each of these being capable of determination in absolute measure.

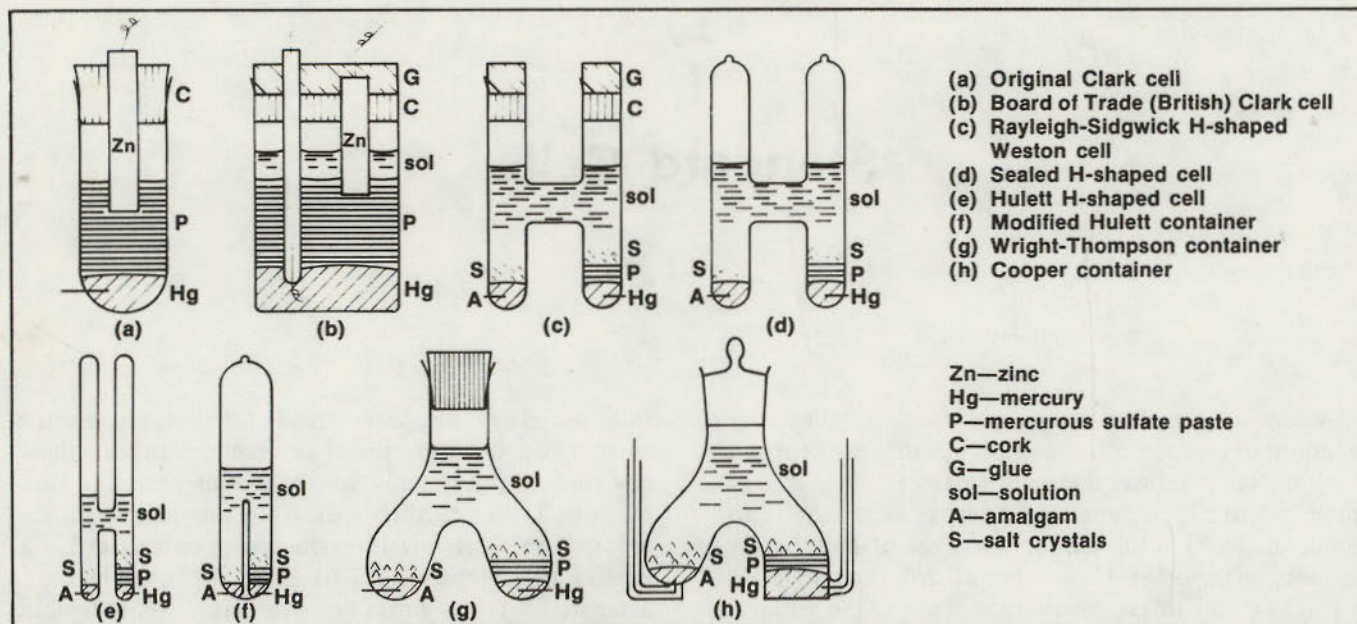

Figure 31. Various forms of standard cell containers.

WESTON (OR CADMIUM SULFATE) CELL

General

The Weston (or cadmium sulfate) cell is, for all intents and purposes, the only electrochemical system used today as a standard cell. Accordingly, the words "standard cell" when used today invariably mean cadmium sulfate cells. The cell is made in two general types, saturated and unsaturated where these terms refer to the state of the electrolyte. The saturated type is the precision cell used in the maintenance of the unit of emf. It may be made in a highly reproducible form and exhibits a constant emf for long periods of time. However, for high precision it must be maintained at a constant temperature owing to its relatively high emf-temperature coefficient. Most saturated cells must be hand carried, although some recent types have been made shippable by locking the electrodes in place with inert and porous septa. The unsaturated cell is less stable than the saturated type in that its emf decreases slowly with time and is regarded as a reference of d-c voltage known within ± 0.005 percent. It is usually made in a shippable form with a septum over each electrode. It has a low emf-temperature coefficient and accordingly is used widely in ambient temperatures as an emf reference where 0.005 percent (0.05 mV) accuracy suffices.

The saturated cell is also known as the Weston Normal Cell (or Element). It consists of a cadmium amalgam anode and a mercury-mercurous sulfate cathode in a saturated solution of cadmium sulfate with crystals of $\text{CdSO}_4 \cdot 8/3\text{H}_2\text{O}$ over the surface of both electrodes.

The unsaturated cell differs from the saturated type only in that an unsaturated solution of cadmium sulfate and

no crystals of $\text{CdSO}_4 \cdot 8/3\text{H}_2\text{O}$ are used. It is customary to use a solution that is saturated at 3 or 4°C, the temperature range at which the salt exhibits a minimum solubility; the solution is then unsaturated at higher temperatures. The emf of the unsaturated cell at ambient room temperatures is about 0.05 percent higher than that of the saturated type.

When the cell is not discharged, as is normal when the cell is used as an emf standard, the solution remains unsaturated and the amalgam in two phases.

Both saturated and unsaturated standard cells have been made as "neutral" or as "acid" cells; the saturated "neutral" type is also known as the Weston Normal Cell. These terms refer to the degree of acidity of the electrolyte with respect to sulfuric acid in the cell. If an aqueous solution of pure cadmium sulfate, to which no sulfuric acid is added, is used in the preparation of the cell, the cell is called a "neutral" type, even though the pH of a saturated aqueous solution of cadmium sulfate, owing to hydrolysis, is 4.00 at 25°C. If sulfuric acid is added in sufficient amount to make the acidity 0.03 N to 0.1N, the cell is called an "acid" type. The purpose of adding the acid to the electrolyte is to prevent hydrolysis of the mercurous sulfate used in the cell; more details are given later. Today, most, if not all, cells are made of the "acid" type.

Containers for Standard Cells

Saturated standard cells as made at the National Bureau of Standards are of the H-form. The container is made of Kimble Standard Flint glass, a chemically resistant soda-lime glass, having an average linear thermal

expansion coefficient of 92×10^{-7} per $^{\circ}\text{C}$. (The coefficient of linear thermal expansion is the increase in length per unit length, measured at 0°C , per degree Celsius.) Since this linear thermal expansion coefficient approximates that of platinum, 89×10^{-7} per $^{\circ}\text{C}$, vacuum-tight seals are obtained at the platinum leads. No lead-containing sealing-in glass is used in sealing in the platinum leads at the bottom of each limb as the solution may extract the lead leading to cell deterioration. On the average the height of the cell is about 92 mm, the diameter of the vertical limbs about 16 mm, the diameter of the cross-arm about 11 mm, and the distance between limbs about 22 mm. A constriction is made near the base of both limbs, as shown, to lock in part of the crystals of $\text{CdSO}_4 \cdot 8/3\text{H}_2\text{O}$. The constriction may be a complete circumferential indentation or may consist of several knobs directed inward. The constrictions are so placed that crystals of $\text{CdSO}_4 \cdot 8/3\text{H}_2\text{O}$ are both below and above them. These locked crystals prevent the displacement of the materials in the cell limbs, and those at the anode help prevent an opening of the circuit within the cell by any gas that might form on the amalgam. The platinum leads are secured by cotton thread to the side of each limb at the constrictions and cemented in place by collodion; platinum leads have a tendency to break mechanically at the glass seal if not securely held in place. For permanent records a number is etched on each cell on the outside wall of the container with hydrofluoric acid. Prior to filling with cell constituents the container is thoroughly cleaned with nitric acid, rinsed with distilled water, steamed, and then dried at 110°C .

At various times attempts have been made to use Pyrex for cell containers. However, since Pyrex has an average linear thermal expansion coefficient of 32×10^{-7} per $^{\circ}\text{C}$ tungsten which has a linear thermal expansion coefficient of 43×10^{-7} per $^{\circ}\text{C}$ must be used for external electrical connections to assure vacuum-tight seals. Tungsten, however, is more brittle than platinum and a

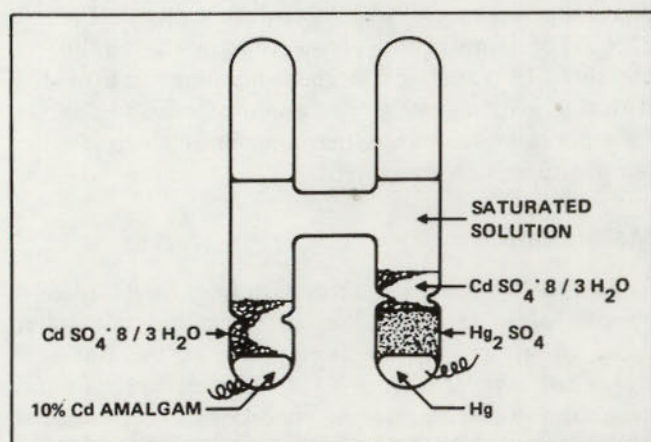

Figure 32. Sketch of a saturated cell of the cadmium sulfate type (NBS type).

number of cells have had to be discarded because of breaks at the tungsten-Pyrex seal.

Fused silica, owing to its extreme inertness, has frequently been suggested for standard-cell containers. Fused silica, however, has two major drawbacks. It has such a low linear thermal expansion coefficient (5×10^{-7} per $^{\circ}\text{C}$) that the electrical leads have to be brought into the cell in a special way. Also, a very high temperature must be employed to seal the cell; the chemicals within the cell may thereby be affected. These two drawbacks have been solved by the cell design shown in Figure 33.

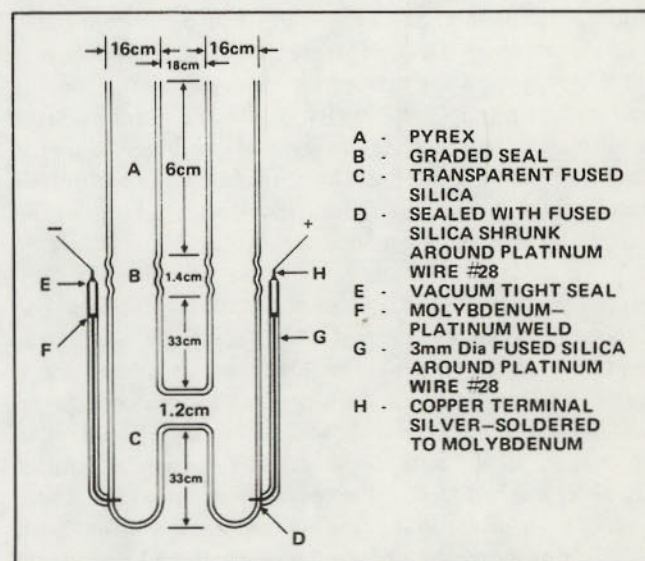

Figure 33. Cross-sectional sketch of standard-cell container made of fused silica.

The main features of this design are (1) the use of two seals at each arm and (2) a graded seal between the fused silica and Pyrex at the top of each limb of the container. The use of the graded seals makes possible the sealing of the cell at a low temperature after filling. Transparent silica is used to facilitate the filling of the cells. The two seals at each arm are spaced about 7 cm apart. The lower seal consists of platinum wire No. 28 sealed in silica, and although this seal is not vacuum-tight it is sufficiently tight to retain the cell constituents. The upper vacuum-tight seal is a Housekeeper type and consists of molybdenum ribbon sealed in silica (this type of seal cannot be used as the lower seal since molybdenum is chemically attached by the cell constituents). The molybdenum ribbon and platinum wire are welded at a point about 2 cm below the upper seal. Silica is shrunk around the weld, the molybdenum ribbon, and platinum wire. Copper terminals are used and are silver-soldered to the molybdenum ribbon. Errors that might arise from thermoelectric effects are prevented by completely immersing the cells in oil at a constant temperature. Dimensions of the cell are included with the figure.

Although it has been generally thought that interactions between the glass container and the cell electrolyte cause "aging" or drifts in the emf of standard cells, available data have not shown significant differences between cells made in soft glass, Pyrex, or fused silica on a long-term basis. Plastic containers have also been proposed. These must prevent vapor transport or a drying out of the cells may occur.

Assembly and Mounting of Standard Cells

Two long-stemmed funnels, one sliding through the other, are employed at the National Bureau of Standards for introducing materials into the container. The inner funnel carries the material and the outer one serves to prevent the material from coming into contact and "mussing up" the walls of the container. After introducing the material the stem of the inner funnel is drawn up into the stem of the outer funnel; both funnels may then be withdrawn from the cell without any of the material touching the container walls.

Mercury is first placed in the bottom of one limb and the amalgam in the bottom of the other limb, each to a depth of about 6 mm. The amalgam is added while warm and in a single liquid phase; on cooling the amalgam becomes two-phased, solid and liquid. The mercurous sulfate is then placed in a Gooch or similar crucible, washed free of the solution under which it was stored with dilute sulfuric acid and then washed with solution of the type to be used in the cell, and then while moist introduced over the mercury to a depth of about 13 mm. The mercurous sulfate should be mixed with a small amount of mercury (partially done during the electrolytic preparation of mercurous sulfate) and finely divided crystals (fineness of granulated sugar) of $\text{CdSO}_4 \cdot 8/3\text{H}_2\text{O}$ prior to introduction to the cell; this mixing may be done prior to the washing procedure. The mixing and washing of the mercurous sulfate paste hastens the attainment of chemical equilibrium within the cell after its assembly.

Crystals of $\text{CdSO}_4 \cdot 8/3\text{H}_2\text{O}$, of a size that will pass through a tube of 4-mm bore, are then added to both limbs of the cell to a depth of about 10 mm at the negative electrode and about 8 mm at the positive electrode. Finally, a saturated solution of $\text{CdSO}_4 \cdot 8/3\text{H}_2\text{O}$ is added to level slightly above the crossarm, and the cell is then hermetically sealed.

In some cells, especially of larger size, large crystals (about 10 to 15 mm in diameter) of $\text{CdSO}_4 \cdot 8/3\text{H}_2\text{O}$ are used. Larger crystals have an advantage over smaller crystals in that any gas that may form at the electrode surface (especially the negative one) will not become entrapped by the crystals whereby an open circuit might be produced. However, cells with large crystals tend to

come to equilibrium, after a temperature change, more slowly than those made with small crystals.

Unsaturated cells are made similarly except that no crystals of $\text{CdSO}_4 \cdot 8/3\text{H}_2\text{O}$ are used and they are made portable (shippable) by inserting cork or plastic rings, covered with linen, over the electrode surfaces. In some cells ceramic discs, either locked in place or supported by ceramic rod which protrudes through stoppers in each limb, are used. The unsaturated cell is the commercial type used widely in the United States for work requiring no greater accuracy than ± 0.005 percent; it is not made at the National Bureau of Standards. It is used for pyrometer work, in pH meters, recording instruments, etc., and is usually housed in nontransparent copper-shielded cases for general laboratory work. A copper-shielded case is employed to assure a uniform temperature at both limbs of the cell. Saturated cells are not mounted in cases since they are intended for immersion in temperature-controlled oil or air baths. Commercial saturated cells are usually mounted in groups of 3, 4, or 6 on special racks for convenience in use.

In practice, saturated standard cells are maintained at a constant temperature in thermostatically controlled oil baths or in portable thermostatically controlled air boxes. The latter are generally made after a design first proposed by Mueller and Stimson. The cells are housed in a thin-walled aluminum box which rests in a larger thick-walled aluminum box, the temperature of which is controlled by a mercury-in-glass thermoregulator. The aluminum boxes are thermally insulated and are enclosed in a wooden box which also contains an a-c relay, a transformer, and a pilot light. The box is operated on 110V 60-cycle a-c line. The leads from the individual cells are brought to binding posts on the outside of the box. These boxes are designed to operate at temperatures above room temperature; the choice of temperature depends on the location where the boxes will be used or on the size of the box. As a rule these boxes operate at some temperature between 28 and 37°C. The temperature of the cells in the air box is measured by a mercury-in-glass thermometer provided with the box. In some boxes, a well is added to provide for a platinum-resistance thermometer in which case the temperature is so measured.

Maintenance

Today, the National Reference Group of Standard cells consists of 44 saturated Weston (or cadmium sulfate) cells, all of which have been made at the National Bureau of Standards from highly purified materials and assembled under controlled conditions. The National Standard is based on the mean emf of these 44 cells. The emf of any one cell in the group is equal to the mean emf, less the average deviation in emf of all 44 cells from

the emf of a selected reference cell in the group, plus the deviation in emf of the individual cell from that of the selected reference cell, or

$$E_c \text{ (in volts)} = E_m - \frac{\Sigma\Delta}{44} + (E_c - E_r)$$

where E_c = the emf of an individual cell, E_m = the mean emf of the 44 cells, $\Sigma\Delta$ = the algebraic summation of the differences between the emf of a selected reference cell, E_r , and the emfs of all of the other cells in the group. This reference group consists of three parts, of 11 "neutral" cells made in 1906, 7 "acid" cells made in 1933, and 26 "acid" cells made in 1948. The last two groups of cells were added to the reference group in 1937 and 1955, respectively. The meaning of the terms "neutral" and "acid" appears later. This National Reference Group of cells is also supplemented by a group of cadmium sulfate cells made with 98 percent deuterium oxide (heavy water), the emf of which is about 380 μV lower than that of cadmium sulfate cells made with normal water.

Obviously, all of a group of "identical" cells may increase or decrease in emf with time without departures from the original assigned mean becoming evident. Therefore, an alternative type of standard cell of approximately the same emf as the Weston cell but of different composition would be most valuable, for if changes in emf with time in two different systems occurred, they would not be likely to follow the same pattern. Thus, studies of the ratio of emfs of two different systems over a period of years would give valuable insight into the stability of the standard. It is for this reason that the National Standard or Reference Group was eventually designed to include "neutral" and "acid" cells and to be supplemented by cadmium sulfate cells made with heavy water. The ratio of or the difference between the emfs of "neutral" and "acid" cells is followed in the course of maintaining the unit of emf.

A cell is removed from the reference group when its emf has drifted by more than 1.0 μV from its previously steady value. When a cell is removed, the mean emf of the group is "recaptured" by reverting in the records to the time the cell had been added to the reference group, calculating a new mean for the reduced group at that time, and finally carrying the new mean forward. In some cases it has entailed going back as much as 20 years. Since the cells have closely agreeing emfs the removal of one cell has only a minor effect on the mean emf of the group; this effect has generally been below 1 μV .

It is difficult to provide incontrovertible evidence regarding the long-term stability of the volt maintained with saturated standard cells. A considerable body of evidence indicates, however, that it is very unlikely that the unit of emf preserved with the National Reference

Group of Standard Cells has changed by any significant amount in the last 53 years.

The standard cells of the National Reference Group are housed in slowly stirred oil baths maintained at 28°C under diffuse light in an air-conditioned room maintained at 25°C $\pm 1^\circ\text{C}$; the relative humidity automatically remains below 50 percent. The temperature of the baths is maintained at 28°C within 0.01°C on a long-term basis and within 0.001°C during measurements using a Gouy controller. In a Gouy controller, a steel piano wire extending into the mercury of the mercury-toluene regulator is connected to a wheel which revolves at a slow rate whereby the wire is made to periodically make the break contact with the mercury. A special mineral oil is used as fluid in the constant-temperature baths. Tests made to determine the temperature of the oil at various locations within the baths indicated a uniform temperature within 0.001°C, i.e., no hot or cold spots prevail within the bath or in the vicinity of the standard cells. This design follows closely that described many years ago by Wolff and Waters. A bath for use with saturated standard cells has also been described recently by P.H. Lowrie, Jr.

The cells are supported about 2 in. below the surface of the oil on seasoned mahogany strips about 16 mm wide (slightly smaller than the distance between the limbs of NBS H-shaped cells) and about 10 mm thick and either 24 or 48 cm long, with grooves into which the cross-arms of the cells fit snugly. Some racks carry 18 cells equally spaced, except for a somewhat wider space at the middle of the rack where the rack is supported; others carry 9 cells. Hard rubber, bakelite, or lucite strips about 40 mm long, 10 mm wide, and 10 mm thick in the center and 13 mm at each end, are mounted between cells across the under edge of the mahogany strip. In the top of each strip, at each end, is inserted a short copper rod provided with a pair of holes, one 1 mm and the other 2 mm in diameter and both about 9 mm in depth; these holes serve as mercury cups, one for a cell terminal and the other for external connections. These two copper cups are spaced at the same distance apart on each strip, so that any cell can be put in the electric circuit by a stabber consisting of a pair of stiff copper wires mounted in a lucite block. This is a copper-copper connection through the mercury and under the oil. From this point on all contacts are copper-copper to avoid thermal emfs. The other end of the stabber connection goes to a post position. There are two post positions, one for the Reference Cell and one for the Unknown Cell. The leads of the cells go from the posts through conduits to another post at the emf-measuring instrument, where the two cells are placed in series opposition by joining the negatives and the difference is measured.

Other baths of intermediate size are also available for housing cells on test. The temperature of the baths is measured with a platinum-resistance thermometer and a Mueller bridge, having a sensitivity of 0.0001 ohm, corresponding to 0.001°C.

8

Intercomparison of Standard Cells

Equipment Required:

- Kelvin-Varley Divider
- Null Detector
- Battery; Mercury, Ni-cad, or Dry Cell
- 4-Cell Saturated Cell Enclosure
- 100k Potentiometer
- Differential Voltmeter
- Test Leads
- Reversing Switch

Following are two simple methods of intercomparing saturated standard cells for the purpose of plotting curves of their history, and also for the purpose of obtaining the value of an unknown standard cell (saturated, or unsaturated).

The first step is to configure the Battery, Potentiometer, and Reversing switch as shown in Figure 35. It would be desirable to have these components mounted in a small box, with short leads equipped with banana jacks for the + and - leads.

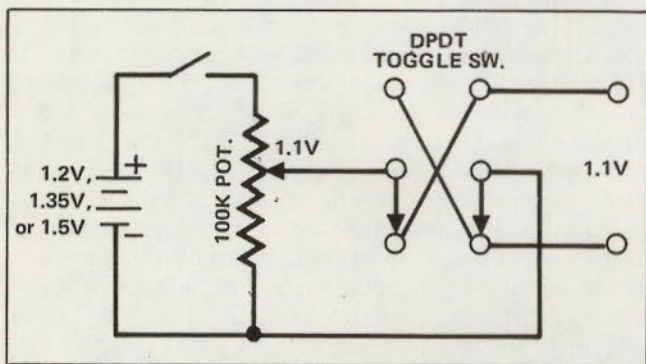

Figure 35.

After the battery and other components are prepared, note the numerical values of the 4 standard cells in the enclosure. List these on paper with the largest value listed first. Suppose, for example, that the four cells, A, B, C, and D had the following numerical values: A = 1.0182154V, B = 1.0182164, C = 1.0182180, D = 1.0182160. In descending numerical order they would then be, C, B, D, A. This placement is done initially for the purposes of insuring that when the cells are connected to the Kelvin-Varley Divider and the Battery circuit, the connections will be in the proper manner.

Connect the elements according to the Figure 36. The 1.1V input is the battery circuit adjusted as close as possible to the voltage of 1.1V by adjusting the potentiometer while monitoring the output of the battery with a Differential Voltmeter. This measurement and adjustment is done while the battery is connected to the Kelvin-Varley Divider. Now, connect Cells A and B to the opposite side of the Null Detector in series opposing such that the larger valued cells is placed closest to the input of the Null Detector. This will ensure the proper polarity for all of the elements.

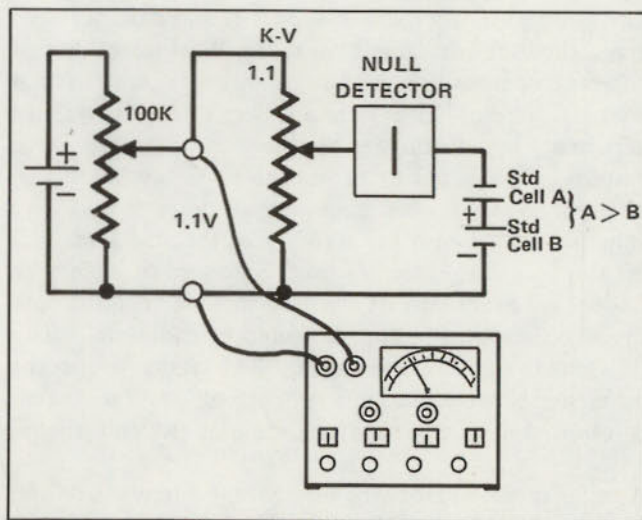

Figure 36.

Before the actual connections are made, the Kelvin-Varley Divider can be set to a value close to the expected difference between Cells A and B as previously calculated. Then, the connections should be made, and the Kelvin-Varley Divider adjusted for any off-null condition. The reading of the Kelvin-Varley Divider is recorded at this null condition.

In order to nullify the effects of thermals in the measurement, both the battery and the two cells being compared are reversed in polarity, and the Kelvin-Varley is again adjusted for a null. This reading is recorded, and the average of the two readings is taken as the proper reading for the difference of these two cells.

This same procedure is repeated for the combinations of Cell B — Cell C, Cell C — Cell D, Cell D — Cell A, and Cell A — Cell C. This last measurement is taken as a control measurement to cross-check against other cell combinations.

The above values are plotted on a graph as a deviation from the nominal value of each specific cell. This graph will show the history of any given cell over time.

The alternate diagram shown below provides a set-up for determining the value of an unknown saturated, or unsaturated cell. Instead of the 1.1V battery source as given in the above example, a 10V stable source is used.

A known standard cell is placed in the circuit as shown, with the Kelvin-Varley Divider dialed to its numerical value. The 10V source is adjusted for null on the Null

Detector, and then the unknown cell is switched into the circuit in place of the known standard. The Kelvin-Varley is again adjusted for a null which defines the value of the unknown cell.

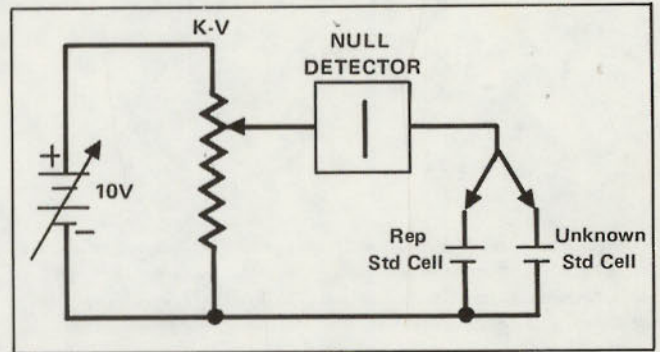
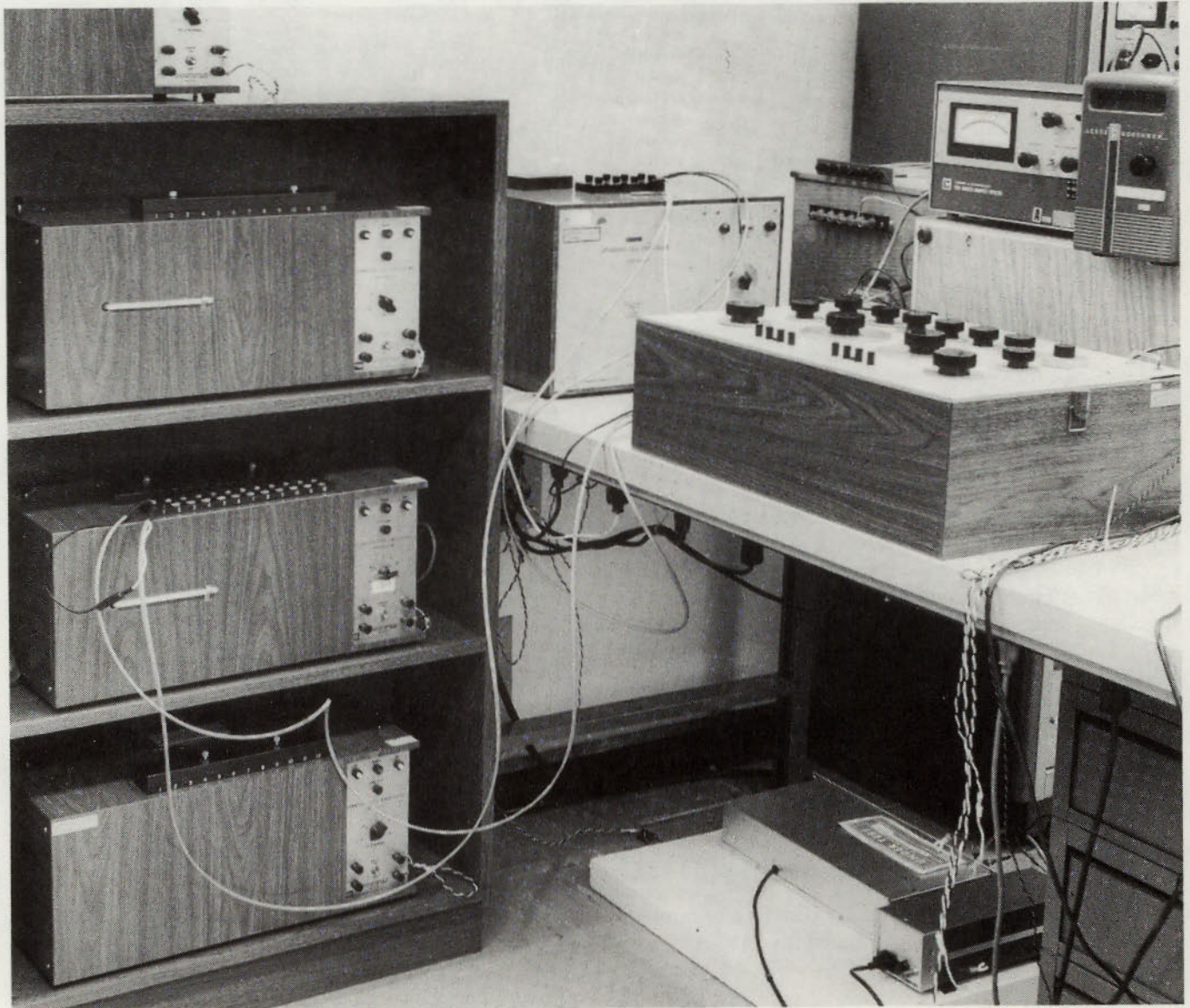

Figure 37.



Control Chart for Saturated Standard Cells

Abstract—A method is presented for measuring and plotting the EMFs of a bank of saturated standard cells relative to each other, without requiring calculations. A summation of the results serves as an indicator of the quality of the measurements. The method is applicable also for the maintenance and control of other standards.

GENERAL

The reference standard of voltage in many electrical standards laboratories consists of one or more banks of three, four, six, or more saturated standard cells contained in a constant temperature enclosure. They are periodically certified by a higher-echelon laboratory, usually by the National Bureau of Standards. When properly cared for, saturated standard cells are very stable, and no means are available to check the stability or eventual drift of one or more cells, except other saturated standard cells. Between certifications by a higher-echelon laboratory, an electrical standards laboratory must find means to compare the cells with each other.

The method most frequently used is to select arbitrarily one cell as a reference cell, measure the EMF differences between each of the remaining cells and the reference cell, and calculate the average difference. The result is then the difference between the reference cell and the average of all cells. The certified average is calculated from the certificate of the last calibration, and this average is assumed to remain constant between calibrations. The EMF of each individual cell can be determined from the theoretical average and the measured mean of all cells. Then, the values of all cells calculated in this manner are usually entered on a chart, in order to spot damaged or drifting cells. If one cell has been damaged or displays excessive drift, it must be eliminated from the average, a new average calculated, and the computation of the mean difference repeated. This method is very time consuming, since it involves many calculations.

PLOTTING DIFFERENCES

A different approach to chart relative EMFs of saturated standard cells has been used successfully. This method allows plotting of the measured values without calculation. See Figure 34.

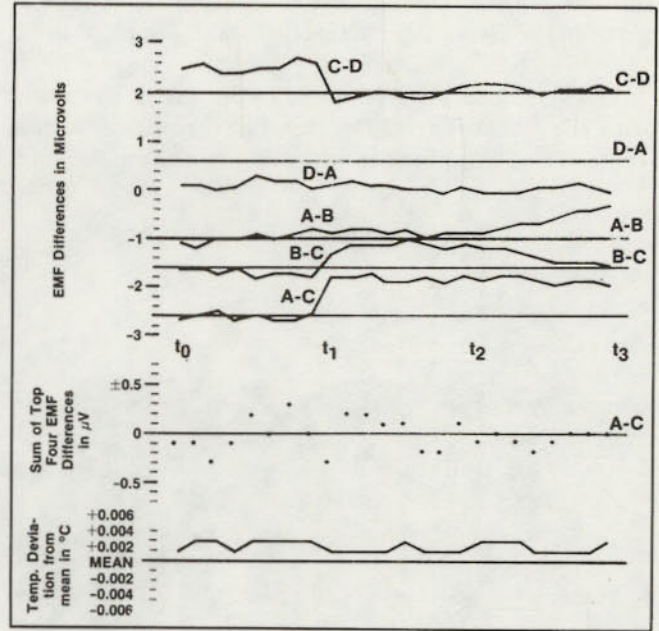

Figure 34.

In the illustrative example, four saturated standard cells are maintained in one common constant temperature enclosure. The cells are designated *A*, *B*, *C*, and *D*. A relatively thermal-free potentiometer, such as the Leeds & Northrup K-3, the Honeywell 2779, the Biddle-Gray 605002, or a Standard Cell Comparator is used to measure the EMF difference between adjacent cells. Thus, four EMF differences are measured:

$$\begin{aligned} A - B &= a \\ B - C &= b \\ C - D &= c \\ D - A &= d \end{aligned}$$

The differences *a*, *b*, *c*, and *d* are plotted as points on a graph like that shown in Figure 34.

It is also necessary to measure and plot an additional, arbitrarily selected pilot difference, for instance, *A - C*. Consecutive points of each difference are interconnected by straight lines. The resulting dog-tail curve describes the variation of each difference with time. Also plotted on the graph are the certified differences of these cells. They

appear as continuous straight lines. For convenience, the measured temperatures of differences from a theoretical operating temperature of the cell bath may also be plotted on the same graph. Of particular use, especially in detecting considerable systematic measurement errors, is the simultaneous plotting of the sum of all EMF differences $a + b + c + d$.

ANALYSIS OF THE GRAPH

The location of each point representing a measured EMF difference, relative to its corresponding straight line of the difference of certified EMF's, indicates the discrepancy between measured and certified differences. If the dog-tail curve of measured differences zigzags around the corresponding straight line of certified differences, the distance between each plotted point of measured difference and the straight line is indicative of the combined effects of random error of the measuring process, random fluctuations of the cells, and small systematic errors. If the curve of measured differences varies about an average straight line parallel to, but offset from, the straight line of certified differences, the amount of offset is equal to the combined effects of an appreciable, constant systematic error of the measurement process and the true difference between measured and certified EMF differentials.

As will be shown later, appreciable systematic errors can be recognized by plotting the sum of the differences and can, consequently, be eliminated. Thus, the offset on the plot can be attributed practically to the existence of a true difference between measured and certified EMF differentials only. Then, if the line of measured differentials between cells *C* and *D*, for instance, has risen above the line of the certified difference $C - D$, any one of the following three cases could have happened:

1. The EMF of cell *C* has risen and that of cell *D* has remained constant, or
2. The EMF of cell *C* has remained constant while that of cell *D* has fallen, or
3. The EMF of cell *C* has risen and that of cell *D* has fallen.

An examination of the remaining curves will reveal which of the three cases has occurred. If case 1 has occurred, then the curve $B - C$ must have fallen below the line of the certified difference $B - C$. If case 2 has occurred, the curve $D - A$ must have fallen below the line of certified difference $D - A$. If case 3 has occurred, both curves must have dropped. Thus, the graph shows at a glance which one cell has changed its value. If only one cell has changed its value, two of the initial four curves are dislocated from their respective lines of certified differences, both involving one common cell,

i.e., the one that has changed. If two cells have changed their values with respect to the remaining two cells, then only one of the initial four curves is not dislocated with respect to its line of certified difference, and that line is the one involving those two cells which have remained constant.

This analysis is based on the assumption that a curve of measured EMF differences, very close to its line of certified EMF differences, represents two standard cells which have maintained their certified EMF differences. It could happen, however, that the EMF's of both cells have increased or decreased by the same amount. In this case, an inspection of the curve would not reveal the change both cells have undergone, although an inspection of the two other curves would indicate the changes, provided that the other two cells have remained constant. If a third cell has also changed, all four initial curves would be affected and unable to indicate exactly what has happened. For this reason, one pilot curve must also be maintained. The redundant information contained in the pilot curve will furnish the answer in the event three out of four cells have changed. The illustrative example will show that it would be possible to spot a cell which has remained stable even if the remaining three cells have changed, because this method recruits the time element to furnish that additional piece of information which frequently gets lost in conventional intercomparison methods. But in such a case, the entire history of the standard cell bank must be studied. Only if data is taken frequently will it be possible to distinguish the beginning of a change of one cell from the beginning of a change of another cell.

Of course, this method, like any other intercomparison method, will not be useful for determining the absolute EMFs of the standard cells. If many cells change simultaneously and by the same amount, it will not be possible to identify the cells which have remained stable. If all cells change simultaneously and by the same amount, as in the case of loss of temperature control, this method may fail to indicate any change at all. In such cases, extraneous means, like a second standard cell bank, must be resorted to.

The method is applicable to any bank of more than two saturated standard cells and may also be applied in the maintenance of other standards. The number of curves required equals the number of standard cells under observation in one common environment plus one, the pilot curve.

THE SUM OF THE DIFFERENCES

One additional piece of information can be extracted from the measured differences. It should be noted that, theoretically, the sum of all differences should be zero.

$$\begin{array}{l}
 A - B \\
 B - C \\
 C - D \\
 D - A \\
 \hline
 \end{array}$$

$$(A + B + C + D) - (B + C + D + A) = 0$$

But the sum of the actually measured differences, $a + b + c + d$, is usually not exactly equal to zero, because of errors in the measuring process. If the errors are random in nature, they will tend to cancel each other, and the sum of the differences will be small. But a constant thermal EMF of 0.1 microvolt in the external measuring circuit, for example, would add a positive or negative 0.4 microvolt to the sum of the differences. Thus, the sum of the differences is related to the quality of the measuring process by which these differences were obtained, i.e., the higher the sum, the lower the quality. A plot of the sum of the differences, parallel with the plots of the individual differences, is a convenient means for judging the accuracy of the differences and for preventing appreciable errors.

ILLUSTRATIVE EXAMPLE

Figure 1 shows a control chart for four saturated standard cells. The cells have been certified by a higher-echelon laboratory to have the following values:

$$\begin{array}{l}
 \text{Cell A: } 1.0182154 \text{ volts} \\
 \text{Cell B: } 1.0182164 \text{ volts} \\
 \text{Cell C: } 1.0182180 \text{ volts} \\
 \text{Cell D: } 1.0812160 \text{ volts}
 \end{array}$$

The differences in EMF between each pair of adjacent cells are calculated and drawn as straight lines on the control chart:

$$\begin{array}{l}
 A - B = -1.0 \text{ microvolts} \\
 B - C = -1.6 \text{ microvolts} \\
 C - D = +2.0 \text{ microvolts} \\
 D - A = +0.6 \text{ microvolts}
 \end{array}$$

The EMF difference of cells *A* and *C* was arbitrarily selected to serve as the pilot difference, and the difference of their certified values, $A - C = -2.6$ microvolts, was also entered on the control chart as a straight line.

After the cells were received from the higher-echelon laboratory, they were allowed to stabilize before difference measurements were made and before the cells were used. An inspection of the first plotted group of points shows that point *C - D* is above the straight line *C - D*; point *D - A* is below the straight line *D - A*, and all other points are close to their respective lines. It must be concluded that the cell *D* is low (by 0.4 to 0.5 microvolts) with respect to the average of the group. At t_1 , the now established curve *C - D* drops suddenly towards the line *C - D*, while curve *B - C* mounts above

its line. Hence, the EMF of cell *C* must have dropped by 0.5 to 0.6 microvolts. Suppose the plot was started shortly after time t_1 . Then points on the curve *C - D* would not have given any reason to believe that the EMFs of cells *C* and *D* do not agree with the average of the group. Since curve *A - B* is where it should be and curves *B - C* and *A - C* are high, it could be concluded that *C* is low. Because curve *D - A* is also low, it confirms that *D* must be low, too, since the three curves involving *A* exclude the possibility of *A* being low with respect to *C* and *D*. If the history of the cells before time t_1 were not known, it could not be known whether the EMFs of cells *A* and *B* have increased. Thus, the history from time t_0 to time t_1 furnishes an important additional piece of information.

With a little experience, even somewhat involved situations like this one can be interpreted at a glance. Such interpretations are generally easy, since it is highly unlikely that two cells change simultaneously. Of course, the more frequently intercomparisons are made, the easier it will be to spot the beginning of a change of any one cell.

At time t_1 , cell *B* begins to drift down, as can be seen from curve *B - C* moving down and curve *A - B* moving up, while the other curves remain stable. Evaluating the entire history of the bank of standard cells described in Figure 1, it can be concluded that cell *D* was initially low with respect to the group by approximately 0.5 microvolts. At time t_1 , the EMF of cell *C* dropped abruptly by approximately 0.6 microvolts. At time t_2 , the EMF of cell *B* began falling slowly. One cell *A* has remained stable.

The plot of the unconnected points indicates the sum of the first four (independent) EMF differences, and the relative vicinity of each point to the zero line is a measure of the relative quality of the measurements by which this point was obtained. The points can be calculated either by adding all four measured differences or by adding their distances from their respective reference lines to certified differences. Thus, at time t_0 ,

$$\begin{array}{l}
 \text{point } C - D \text{ has a distance from line } C - D \text{ of } +0.5 \mu\text{V} \\
 \text{point } D - A \text{ has a distance from line } D - A \text{ of } -0.5 \mu\text{V} \\
 \text{point } A - B \text{ has a distance from line } A - B \text{ of } -0.1 \mu\text{V} \\
 \text{point } B - C \text{ has a distance from line } B - C \text{ of } 0.0 \mu\text{V}
 \end{array}$$

The sum of all respective distances is $-0.1 \mu\text{V}$.

The closer a point of this plot is to the zero line, the more meaningful are the individual measurements of the EMF differences plotted above it.

CONCLUSION

A method has been presented by which the relative stability or changes of such laboratory standards as saturated standard cells can be observed without requiring calculations. By a simple addition, a check on the quality of the measuring process can be obtained.

Josephson Junction Based Voltage Standard

INTRODUCTION

The ac Josephson effect in superconductors has made possible the realization of a voltage maintenance standard that is independent of the emf drifts and uncertainties associated with standard cells. The basis for this new standard is a Josephson junction, which may be regarded as a frequency-to-voltage converter. Josephson junctions can be used to produce voltages at many discrete voltage intervals given by the relation $V = nhf/2e$, where f is the microwave frequency, h is Planck's constant, e is the electron charge, and n is an integer. Experimental tests and theoretical investigations of the preciseness of the frequency-to-voltage ratio have been made which indicate that for Josephson junction of the type used here, the ratio is exact to at least a few parts in 10^8 . This relation is independent of junction material, geometry, temperature, etc.

The NBS Volt has been defined in terms of $2e/h$ since July 1972. It is maintained using the ac Josephson effect and the NBS assigned value for $2e/h$ of $483593.420 \text{ GHz}/V_{\text{NBS}}$. This means that if a Josephson junction were irradiated with a known frequency the voltage produced would be known directly in terms of the NBS volt without ever requiring calibration by NBS. This paper is a preliminary report on the development of a rugged, portable, and highly reliable Josephson-effect voltage standard that is presently under construction. This standard is expected to be able to maintain a unit of voltage with a precision of one ppm (or better) at the one volt level. The system consists of three major parts as shown in Figure 38; the Josephson junction and dewar system, the junction sources, and the potentiometer. Each of these parts will be discussed.

JOSEPHSON JUNCTION AND DEWAR SYSTEM

The Josephson junction devices to be used were designed and are fabricated at NBS Appendix. They consist of Pb films with a Pb oxide insulation barrier. The device is pictured in Figure 39 which shows the junction mounted in a small (3 cm x 3 cm) microstripline box. The junction will be irradiated by microwaves

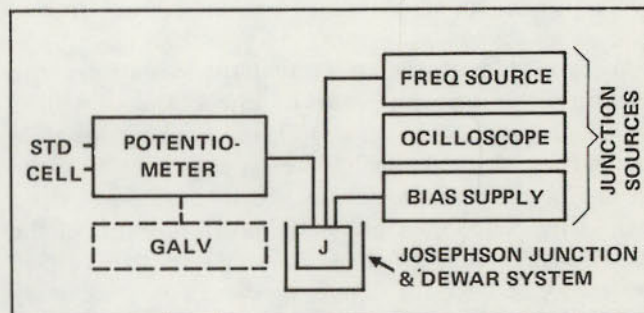

Figure 38. Block diagram of the overall voltage standard system, with a Josephson junction voltage reference for the potentiometer, which is used to calibrate standard cells.

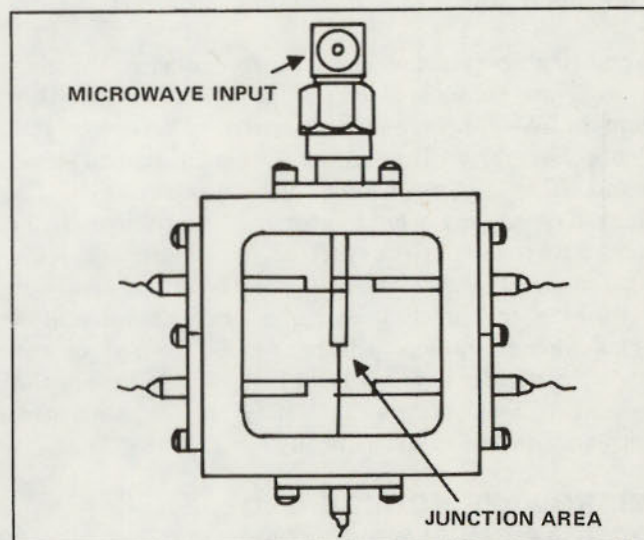

Figure 39. Josephson junction device mounted in a microstripline enclosure (with the cover removed from the box).

with a frequency of approximately 9 GHz, coupled in via a thin coaxial tube. A segment of a typical I-V characteristic of a junction when irradiated by microwaves is shown in Figure 40. The portion of the characteristic of interest, the induced voltage steps, are the vertical line segments which appear at discrete voltage intervals given by the relation $V_n = nhf/2e$. These steps have essentially infinite slope; that is the voltage difference between the

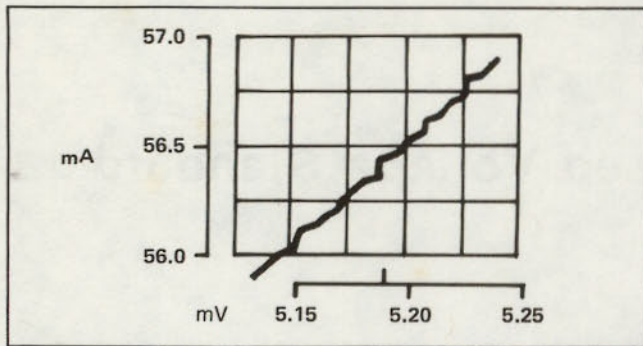

Figure 40. A portion of the I - V characteristics of a tunnel junction exhibiting constant voltage steps.

top and bottom of a step is less than the resolution of the measuring instrument used to check them ($\approx 10^{-10}$ volts). In practice the junction is used by adjusting the dc current through the device to approximately the center of the desired step (n), then the voltage drop across the junction is precisely known in terms of the microwave frequency and $2e/h$. Since the voltage difference between the steps is very small, it is necessary to have a large n so the voltage V_n will be large enough to balance with the potentiometer. With $f = 8.80441$ GHz, the voltage difference between two steps is 0.018206 mV, and using $n = 285$ we obtain $V = 5.188776$ mV. The desired step is determined by a circuit in the bias supply which will be described later.

The Josephson junction and a superconducting shorting switch are mounted on a probe in a low-loss superinsulated helium dewar system. The dewar and probe assembly will be about 37 cm in diameter and stand 1.2m high. A liquid helium loss rate of 1.5 liters/day yielding a holding time of approximately 20 days between refills is expected. The dewar includes a helium level indicator and can be filled without disturbing the junction assembly. For the present a small vacuum pump will be needed to reduce the pressure to below $1/2$ atmosphere, which lowers the helium temperature to 3k where the junction performance increases dramatically.

MICROWAVE SOURCE AND DC BIAS SUPPLY

The microwave source to be used is a commercially available source consisting of a phase-locked transistor oscillator operating in L band and a frequency multiplier. The output is approximately 9 GHz at up to 50 mW, which is required to irradiate the junction. Additionally, an adjustable attenuator, a dc block (to eliminate ground loops), and an isolator (to absorb reflected power) are placed in series in the output.

The high stability frequency reference for the source is a temperature controlled 100 MHz crystal oscillator. This

oscillator has an initial long term stability of 0.015 ppm/week. Due to the linear voltage-to-frequency relation of the junction, an error in the frequency is reflected as a proportional error in the measured standard cell voltages. Thus, the frequency reference must be checked against WWV, or a suitable frequency standard, and adjusted if necessary to stay within 1 ppm (or better if desired).

The dc bias supply for the junction performs two major functions; 1) it provides a stable dc bias current (up to 100 mA) to keep the junction operating on the correct step, and 2) it offsets the oscilloscope display of the step pattern to permit adjustment of the bias current. A rechargeable sealed lead-acid battery (B_1 in Figure 41) and resistive divider are used to provide the bias current. Problems with ac pickup being coupled into the junction are reduced by using a battery. The battery is automatically recharged during non-use periods.

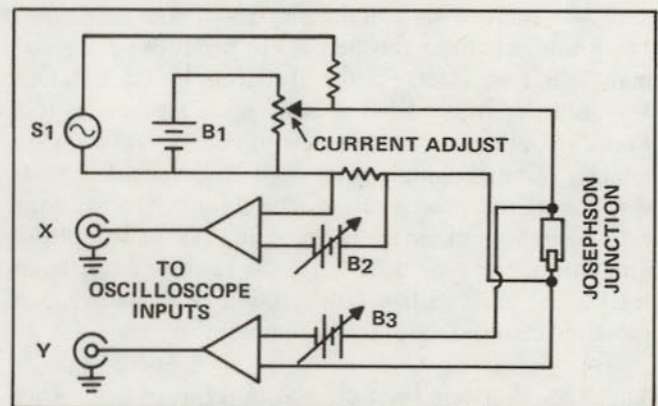

Figure 41. Simplified circuit diagram of the dc bias supply.

In order to view the step pattern (I - V characteristic) of the junction a small ac signal (from S_1) is added to the dc. Since the step size is small compared to V_n , only a small portion of the I - V characteristic (see Figure 40) is displayed so that adequate resolution of the steps can be obtained on the oscilloscope. Differential amplifiers with adjustable voltage sources (B_2 and B_3) in series with the inputs are used to cancel the dc components. If source B_3 is equal to the voltage of the desired voltage step of the junction, that step will appear in the center (horizontally) of the oscilloscope screen, as shown in Figure 40. This method of finding the desired step works because of the spacing of the steps. The source B_3 need only be set to an accuracy of 0.1% to unambiguously resolve the correct step.

The oscilloscope used with the system is an X-Y type with a sensitivity of 10 mV/cm in each channel. The scope is a commercial instrument selected for low noise output through the input channels. The frequency source, bias supply, and oscilloscope will each be a standard 22.86 cm (19") rackmount instrument about 15

cm high. These instruments can be contained in a small cabinet with two multiconductor cables and a coaxial line, the coax and one cable going to the dewar system, and the other cable to the potentiometer.

POTENTIOMETER

The potentiometer to be used with the system is of special design; the current in the instrument is standardized against the junction voltage, then the total voltage of a standard cell or many cells in succession can be measured without reference to the junction. A simplified circuit diagram is shown in Figure 42. The major components of the instrument are the Hamon (series-parallel) network, the Kelvin-Varley divider, and the constant current source.

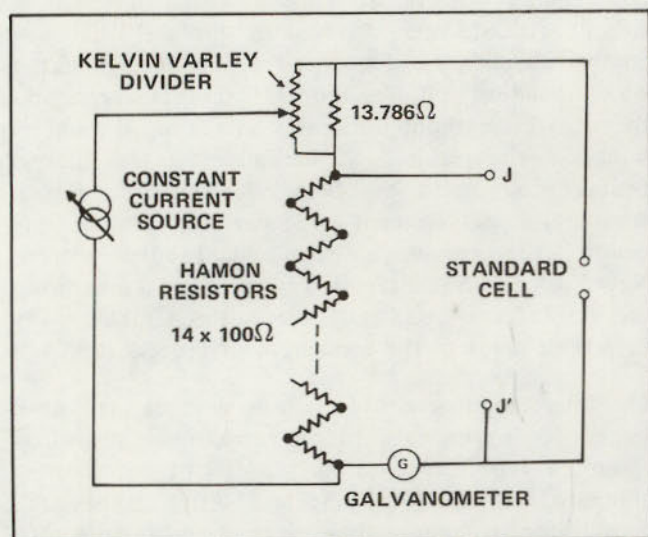

Figure 42. Simplified circuit diagram of the potentiometer showing the fourteen 1.00Ω Hamon resistors connected in the series (operate) mode.

The 14 Hamon resistors (matched resistances) provided the voltage step up from 5.1887755 mV to 1.017 volts. To do this, the instrument is operated in two modes, the standardize mode, and, as shown in the figure, the operate mode. In the standardize mode the junction is connected to the instrument at the points labeled J and J', the standard cell is disconnected, and the 14 Hamon resistors are connected in parallel; the total resistance is thus 100/14Ω. The current through the Hamon resistors (≈ 0.7 mA) is adjusted to produce a null on the galvanometer. (The galvanometer sensitivity and reversing switches are omitted from the diagram for clarity.) Switching to the operate mode disconnects the junction, restores the Hamon resistors to their series connection, and connects the standard cell. The total resistance of the Hamon resistors is now 1400Ω. The advantage of this method is that the resistance ratio of the series mode to the parallel mode is 196 to 1, and the resistance mismatch of individual resistors from the mean resistance contributes only a second order error to the ratio. If the current is maintained constant in both

modes, the voltage developed across the Hamon resistors in the series mode will be $0.005187755 \times 196 = 1.01700$ volts. The Kelvin-Varley divider is now adjusted to null the galvanometer and the last digits of the cell voltage are read directly off the divider dials. The divider provides for a range of cell voltages from 1.0170 to 1.0199 volts with a resolution of $0.1 \mu\text{V}$. With only a small portion of the voltage being provided by the divider (1.0170 volts being developed across the Hamon resistors), the ratio of the divider resistance to the Hamon resistors need only be accurate to 100 ppm.

The Hamon resistors are 14 card-type resistors with initial matching to better than 100 ppm and temperature coefficients of resistors of $2 \text{ ppm}^\circ\text{C}$ or less. The resistors are switched to the parallel mode using two commercial rotary switches and a scheme of compensating feeder resistors as described in reference. This provides an overall ratio accuracy of 0.01 ppm or better with no trimming or selection of resistors. A periodic (possibly yearly) check should be made by measuring the voltage drop across each resistor to see if they are still matched within tolerance. A digital voltmeter with 100 ppm resolution could be used for this check. Similarly, a check should be made of the Kelvin-Varley divider; however, as mentioned earlier this need only be checked to modest accuracy. The Kelvin-Varley divider to be used as a high quality divider and is expected to drift negligibly for the life of the instrument. If overall system accuracy of only 1 ppm is desired, the calibration of the divider can probably be dispensed with, leaving only a simple 10 minute calibration procedure to check the Hamon resistors.

The constant current source designed for the instrument uses all solid-state components and three mercury batteries as a reference. The entire potentiometer is temperature regulated to eliminate the effect of ambient temperature changes on the current source and the resistors. The current source has a rather long warm-up time (approximately 2 hours) so it will be operated continuously from ac power except when measurements are to be made, when it will be switched to batteries. The source exhibits drift on the order of 0.2 ppm/hr or better and noise in a $0.01 - 10 \text{ Hz}$ bandwidth of approximately 0.1 ppm peak-to-peak. The source is also unaffected by the large changes in load resistance ($3 \text{ k}\Omega$) due to different settings of the Kelvin-Varley divider. It is possible then to standardize the instrument and make measurements over a one or two hour period before restandardization is required.

CONCLUSIONS

A system has been described that is expected to be able to measure the emf of standard cells to a precision of better than 1 ppm. A standards laboratory can thus maintain a unit of voltage without time consuming standard cell calibration in-house and at NBS. The system uses a Josephson tunnel junction as a time-invariant voltage reference, and a special potentiometer to scale the output of the junction to a standard cell voltage. The system should be reliable and require minimal calibration.

The Rise of the Calculable Capacitor

It is No. 1 in accuracy among basic electric standard. It determines the size of the ohm (as well as the farad). It helps monitor the constancy of the ampere standard.

The electric capacitor has come a long way in the science of measurement. Twenty years ago discussions of basic electric standards scarcely mentioned it. Today the SI or metric unit of capacitance, the *farad*, is the most accurately realizable of the electric units.

More impressive still, capacitance standards can now be used to measure the resistance in ohms of standard resistors. And the National Bureau of Standards is setting up a regular program for monitoring the U.S. legal ohm standard by comparing it periodically with the capacitance standard.

The capacitor's march to metrological glory began back in 1956 when A.M. Thompson and D.G. Lampard of the Australian National Measurement Laboratory (NML), then the National Standards Laboratory of Australia, discovered a new theorem in electrostatics. They uncovered a whole new class of designs, the "cross capacitors," whose capacitances can be calculated with unusual accuracy — in electrostatic units — from a single linear dimension of the capacitor.

However, to calculate a capacitance in SI units (farads) — which is indispensable for most practical applications of capacitors — it is necessary to know the speed of light. (The capacitance formula contains the factor, ϵ_0 , the "permittivity of space," which in turn depends on c^2 , the square of the speed of light.) Hence any uncertainty in the speed of light will reappear (multiplied by 2, because the square of c is involved) in the uncertainty of the capacitance. This difficulty was soon eliminated by progress in measuring the speed of light at NBS Boulder Laboratories. The uncertainty is now below 0.01 part per million (ppm). (See DIMENSIONS/NBS, April 1974, pp. 90-91.)

An apparently more formidable obstacle in the path of the calculable capacitor was the extreme minuteness of a picofarad (pF). Its usefulness would therefore have been severely limited unless a way could be found to

accurately compare such small capacitors with the very much larger ones that are most frequently used.

This difficulty was overcome when scientists at the Australian NML and at NBS succeeded in designing circuits (transformer comparator bridges) that can compare capacitors of only a fraction of a picofarad with capacitors well over 100,000,000 times larger. And they do this without noticeably increasing the uncertainty of the result — a measurement feat that is believed unique to the field of electricity. (For a comparable achievement in measuring length, one would have to measure a distance equal to that between New York and San Francisco by means of a measuring rod only 2 cm long, and do it without making any detectable error in the measurement process itself.)

The intercomparisons are made in a series of 10-to-1 stages: for example, a 10 pF capacitor is measured against a 1 pF capacitor, then a 100 pF capacitor is compared with the 10 pF one, and so on up the scale. This same technique has since been adapted to comparing standards of the volt and the ohm.

BETTER FARADS, OHMS, AND AMPERES

Thanks to the calculable capacitor, the U.S. legal farad is believed to conform to the definition of the SI farad to within 0.02 ppm. (This, like other accuracy figures in this article, given in ppm, are estimated at the 95 percent confidence level.)

Capacitors are critical components in all sorts of electronic circuits — amplifiers, oscillators, filters, pulse generators, and a hundred others. Tuning a radio or TV set, for example, is usually done by adjusting a variable capacitor. Considerably greater demands on accuracy are made in such applications as aircraft fuel gages and operational amplifiers for analog computers and control devices. The higher accuracy of the new capacitance standards makes quality control a lot easier for those who make precision capacitors and the instrumentation for measuring them.

The calculable capacitor is leading to more accurate standards of electrical resistance (the ohm) where high

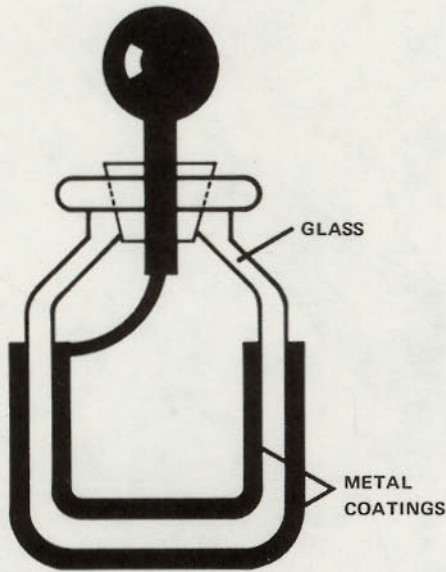

SOME BASICS ON CAPACITORS AND CAPACITANCE. . .

Any two conductors, with a nonconductor (the 'dielectric') between, can store electric charge.

A capacitor is a pair of conductors specially designed to store appreciable amounts of charge (like a millionth of a coulomb) — its two conductors come close to each other over a fairly large area. . . as can be seen in the first capacitors, the 'Leyden jars' of the 18th century, one type of which is shown here in cross section. Glass is the dielectric; tin foil or silver leaf formed the conducting layers.

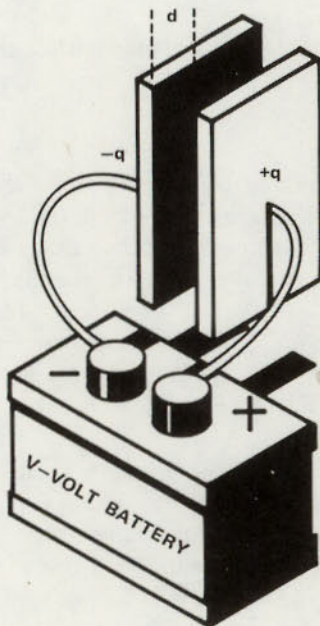

The capacitance C , in farads, is the number of coulombs stored on each conductor per volt of potential difference between them. In this parallel-plate capacitor, where the conductors are metal plates, $C = q/v$. This capacitance can also be calculated (approximately) by the formula: $C = \kappa \epsilon_0 A/d$.

A is the area (sq. meters) of each plate. d is the distance (meters between plates). κ is the dielectric constant (nearly 1 for air, exactly 1 for vacuum, 7 or more for flint glass).

ϵ_0 is the 'permittivity of vacuum', it is equal to $10^7/4\pi c^2$ where c is the speed of light.

The closer the plates are together and the larger their area, the more accurate the formula becomes.

Another way to describe a capacitor is by its behavior when an alternating voltage is applied across its terminals.

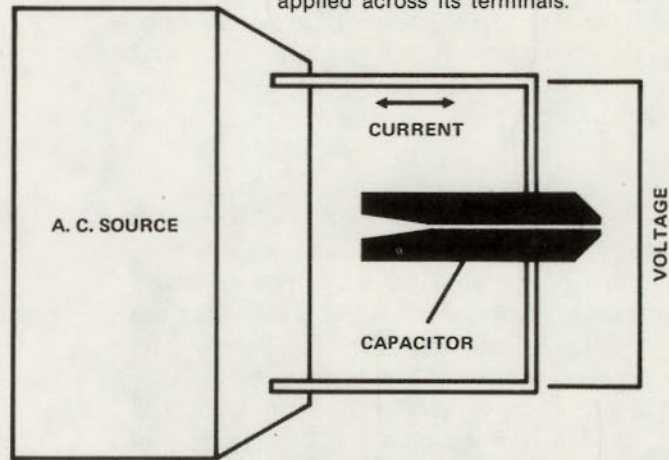

This behavior is summarized in the graphs below (which might be displayed on an oscilloscope screen), showing how the current through a capacitor (dotted graph) and the voltage across it (solid graph) vary with time.

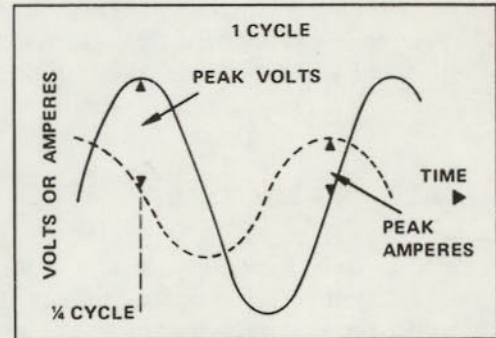

It is characteristic of a pure capacitor that the current wave is one-quarter cycle ahead of the voltage wave. The peak voltage divided by the peak current is the impedance of the capacitor. The impedance depends on the capacitance C (in farads) and on the frequency f (in hertz) of the alternating voltage: impedance of capacitor = $1/2\pi fC$ ohms.

Figure 43.

accuracy is in even greater demand. The ohm formerly was determined by comparison with a calculable inductor. One either calculated the inductance of a carefully designed coil from its dimensions and number of turns, or the mutual inductance of a pair of coils. Calculable capacitors have at least two advantages over calculable inductors: they are more easily shielded from external disturbances and their geometry is much simpler.

The calculable capacitor, jointly with the Josephson effect devices that are used in maintaining the U.S. legal volt, can also monitor the constancy of the effective ampere standard. Briefly: the calculable capacitor can reproduce the ohm with an uncertainty of 0.06 ppm (and prospects are good for doing even better); and the U.S. legal volt is reproducible with an uncertainty of 0.08 ppm. But standards of the ohm and volt, by way of Ohm's law, give us a corresponding ampere that can be reproduced with essentially the same relatively small uncertainty as the ohm. Our best procedure for the absolute determination of the ampere, which uses a current balance, has an uncertainty of about 15 ppm. Thus, although the ampere standard could conceivably vary, from one absolute determination to another, by as much as 15 ppm, scientists can nevertheless (through the ohm and volt standards) narrow the range of possible fluctuations in the U.S. legal ampere to less than 1/200 of that amount.

CALCULABLE CAPACITORS

There were calculable capacitors before 1956, but achieving the required accuracy was so difficult that it discouraged their use as standards. Almost any physics textbook tells how to calculate the capacitance of a "parallel plate" capacitor — two equal metal disks, parallel to one another and separated by air or some other nonconductor. Unfortunately, the calculation is exact only under certain ideal conditions, and the capacitance is extremely sensitive to even very slight deviations from those conditions.

The merit of the cross capacitor is that it does not suffer from this undesirable hypersensitivity. Basically, a cross capacitor is *two* capacitors; the calculated capacitance is the average of the two. And the two capacitors are so related that a misalignment or misplacement of any of the critical parts gives rise to two opposing effects: It increases one of the capacitances and simultaneously decreases the other by nearly the same amount.

THE THOMPSON-LAMPARD THEOREM

The kind of situation considered in the Thompson-Lampard theorem, on which the calculable capacitor is based, is not difficult to describe: a set of four metal rods

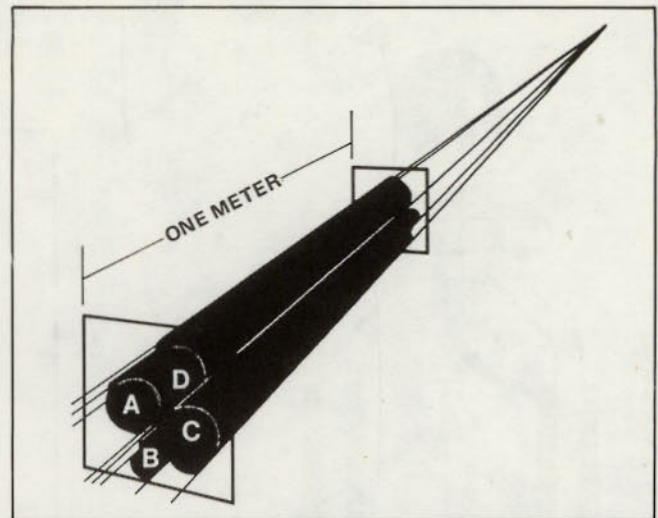

Figure 44. The Thompson-Lampard theorem, which led to the calculable capacitor, deals with four infinitely long, parallel conducting rods, each of uniform but arbitrary cross section. In this perspective schematic sketch, two cross sections (black areas) are indicated, and the rods are to be thought of continuing indefinitely to the front and rear.

— call them A, B, C and D — of indefinite length and placed parallel and close to one another, as suggested in the illustration. The cross section of any one rod is uniform along its length, but different rods can have different cross sections.

Now any two conductors, say portions of rods A and C, separated by a nonconductor (air, for example) constitute a capacitor. But because the rods are "indefinite" in length, we can only speak of their capacitors per unit length. Suppose, then, the A-C rod pair has a capacitance of C_1 farads per meter while the capacitance of rod pair B-D is C_2 farads per meter. Also, let \bar{C} be the average of C_1 and C_2 .

Then the Thompson-Lampard theorem leads to this remarkable result: If C_1 and C_2 are nearly equal, then we can not only calculate the value of \bar{C} , but the calculated value is — to a very high degree of accuracy — the same for all set of rods that satisfy this condition. This constant value of \bar{C} is about 2 picofarads per meter.

FROM FIXED TO VARIABLE

In practice, of course, rods of definite length must be used. But by placing a "guard section" near either end of each rod (insulated from, but kept at the same potential as, the rod) it can be made to behave much as if it were part of an infinitely long rod. Also, it is easiest to use four rods of the same circular cross section, with the centers at the corners of a square. A "grounded" metal cylinder, enclosing the entire cross capacitor, is

employed to shield it from electrostatic fields between itself and conductors in the vicinity.

The first operating calculable capacitor of this kind was built in 1960 by Robert D. Cutkosky at NBS. Its electrodes (rods) were precision gage blocks, and it was used to calibrate an ohm standard to 6 ppm. Cutkosky also extended the theory to allow for nonconducting films on the electrodes.

An important change came in 1964 when Thompson and Lampard, working with W.K. Clothier, made the cross capacitor variable. They did this by inserting a grounded rod down along the central axis of the device. This acts as a shield between opposite rods, reducing C_1 and C_2 effectively to zero over the distance the shield rod has been inserted. The A-C and B-D capacitances are again restored as the movable rod is withdrawn. Leaving out the complicated details, if the rod is pulled out

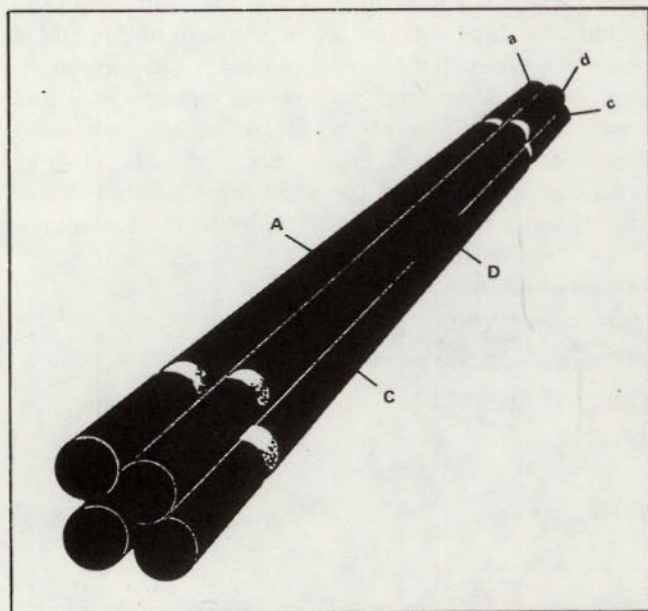

Figure 45. Basic structure of the first operating calculable capacitor, built at NBS in 1960. The calculated 'cross capacitance' is the average of the capacitance (per meter of length) of the capacitor formed by rods A and C and that formed by B and D. When the 'guard' sections a, are kept at the same voltage as A b, b at the same voltage as B, etc., then A, B, C and D are very nearly as if parts of infinitely long rods.

through a distance L , the cross capacitance increases by $L C$. Clothier built an instrument of this design in 1964. Its accuracy was limited to about 0.5 ppm by the then existing uncertainty in the speed of light.

The second cross capacitor at NBS was of this variable kind. It was built by Cutkosky in 1974 and is the one used by him to determine the farad to 0.02 ppm and the ohm to 0.06 ppm. Besides the advantages inherent in the variable cross capacitor, plus some refinements worked out at NBS, this cross capacitor has the major advantage arising from the use of a stabilized laser for the interferometric measurement of the displacement L .

Thus in less than twenty years the calculable capacitor has become one of the two pillars of the electrical measurement system (the other is the ac Josephson effect) that are primarily responsible for the accuracy and stability of that system.

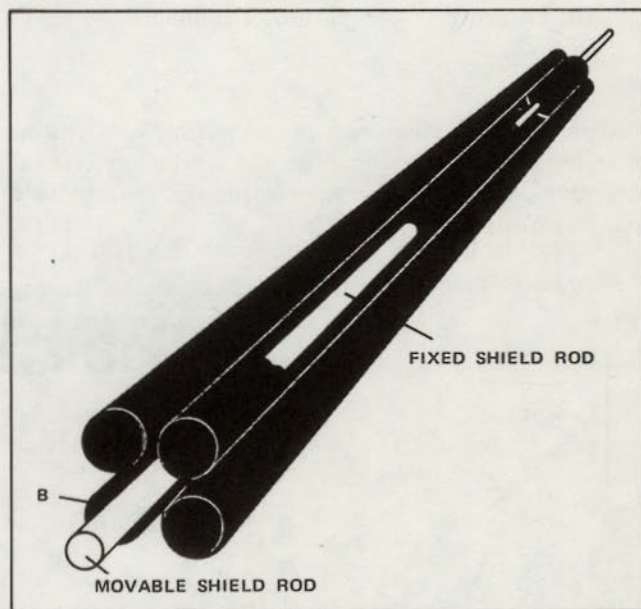

Figure 46. Basic structure of the variable cross capacitor used as standard of farad and ohm. The capacitance calculated is the change in cross capacitance when the movable shield rod is displaced through a measured distance along the axis. (Most of rod D has been removed so the shield rod can be better seen. Note that the variable cross capacitor does not need guard sections. Omitted from this and the preceding figure is the metal shield that encloses the entire device).

12

Precision Instrumentation

The purpose of this is to acquaint or reacquaint you with the technology of Precision Instrumentation, sometimes referred to as metrology. Precision Instrumentation, contrary to traditional beliefs, is none of the following:

1. Not a gray area of mysticism and uncertainty
2. Not an array of complicated equipment
3. Not expensive

Rather, precision measurements are a simple extension of techniques used routinely in the world of electrical measurements with a few buzz words and descriptively named instruments thrown in.

WHAT IS PRECISION?

The dictionary states simply, "an extremely accurate measurement". What is accuracy? Accuracy is the measure of an instrument's capability to approach a true or absolute value. *Accuracy includes the sum of random errors and systematic errors. Random errors can only be determined using a strict statistical approach and include random deficiencies in the repeatability of a measurement created by conditions such as interpolation of a reading, resolution, operator skill and residual instabilities of the measured and measuring instrument. Random errors are reduced only by repetitive readings and the application of statistics to establish the certainty of the value for these readings.*

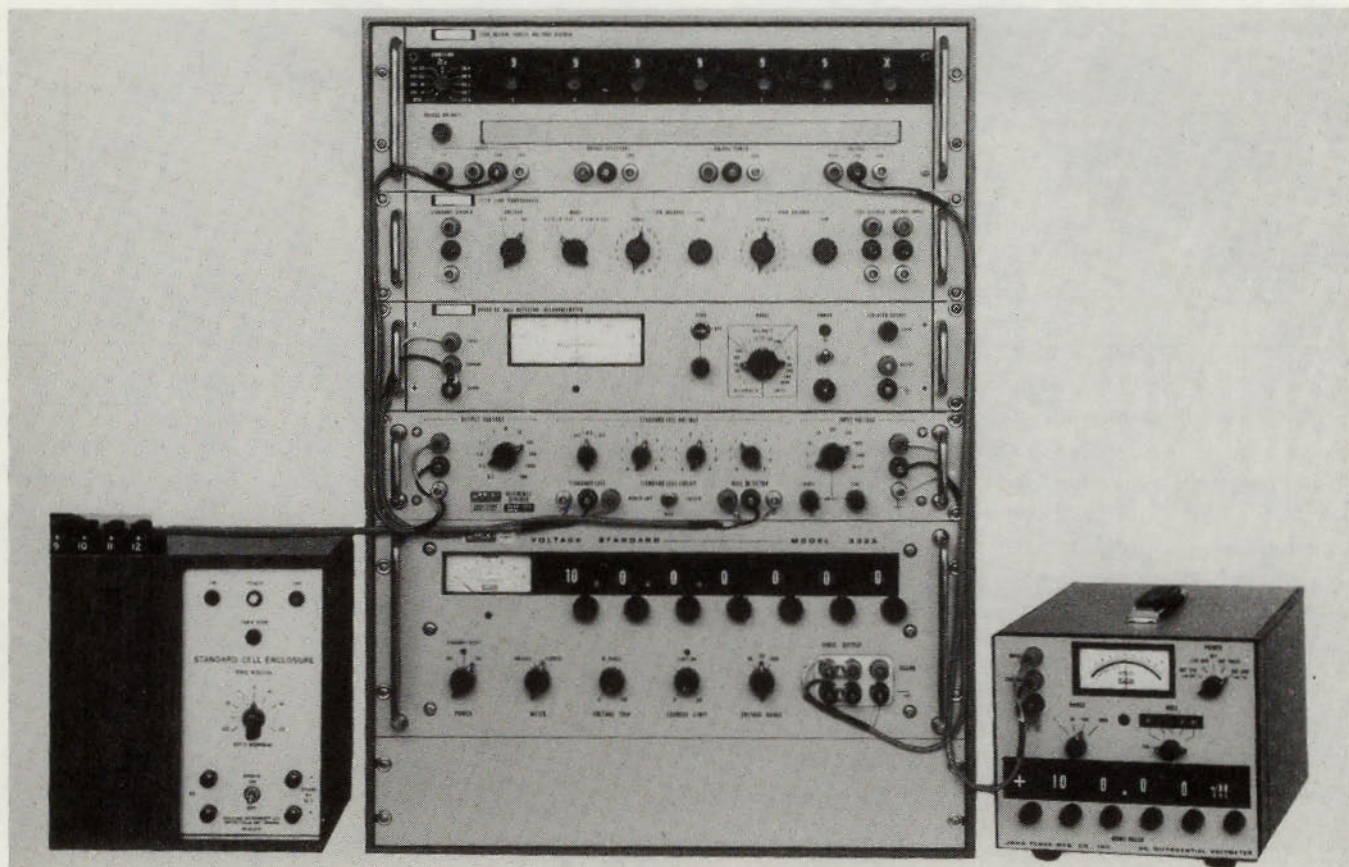

Figure 47. 7105 System

Systematic errors or bias result from inherent characteristics of the measured and measuring equipment. Systematic errors include an instrument's temperature coefficient, humidity effects, linearity, and resolution as examples, and in general includes parameters which may change, but are usually predictable. Systematic errors are reduced primarily by familiarity with the equipment, its characteristics, and the conditions in which it is operated.

But, what is precision? Precision has no unit of measure and only indicates a relative degree of repeatability. Repeatability is the result of resolution, and stability. When the precision of a measurement is improved so is the accuracy.

The perfect digital voltmeter has an infinite number of digits, does not drift regardless of time, temperature or humidity, provides an absolute measurement for all input levels.

What is a true or absolute value? The National Bureau of Standards maintains reference standards for every measurement; electrical, heat, light, color, distance, mass flatness, roundness, radiation, time, and texture name a few examples. Reference standards are *legally* accepted as the true or absolute value for all measurements.

	DC				AC	
	Meters	Potentiometric	Voltage	Resistors	Measurements	Frequency
1836			Clark Cell			
1837	Pouillet (Tangent)					
1840		Poggendorff				
1843		Wheatstone				
1851					Thermal Couple (Discovery)	
1882	D'Arsonval			Weston (Manganin)		Mechanical
1890		Wolff				
1894			Weston Cell			Electro- Mechanical
1901	NBS est.					
1910				Rosa	Hot Wire (Moving—vane)	
1917	Leeds & Northrup (Galvo)	Leeds & Northrup (K-Series)				Electronic Osc.
1927					T'couple (Application)	Piezoelectric
1930				Thomas 1Ω		
1939				Reichsanstalt		
1943					T'couple as Standard	
1955		Fluke (Differential Voltmeter)				Cesium 133
1957	Digital (A to D)					
1965		Opt. Amp. Digital				
1975					RMS Sensor	

1940 Primitive Standards Labs Begin
 1950-1969 Operational measurements
 1970 Refinements of Operational measurements

Figure 48. Chronology of standards.

NBS TRACEABILITY THROUGH FLUKE EQUIPMENT

The condensed chart below shows the relationships of Fluke standards to obtain traceability for ac and dc voltages. A more comprehensive chart is attached showing traceability of other parameters including frequency, current, and resistance. Additional copies of the chart are available upon request.

SETTING UP A CALIBRATION LAB

Notice the preceding chart establishes NBS traceability for two electrical operations: measure and generate.

Indeed, this is what a cal lab does. However, when plans and justifications are being established to equip the new

lab or refurbish an old one, a prerequisite question must be answered. Shall the lab be *self-calibrating* (autonomous) or *dependent*.

A *self-calibrating* lab is self supporting and relies on its own reference standards. A *dependent* lab operates with equipment which must be periodically recalibrated by an outside self-supporting lab.

In the following chart we have shown the recommended equipment to establish the two types of labs. Notice that while the self-calibrating lab costs \$6,000 more to establish, the annual recalibration costs for the dependent lab will have exceeded this amount in less than three years. Also, there is a severe inconvenience with down time and shipping requirements while the dependent lab's equipment is out being recalibrated.

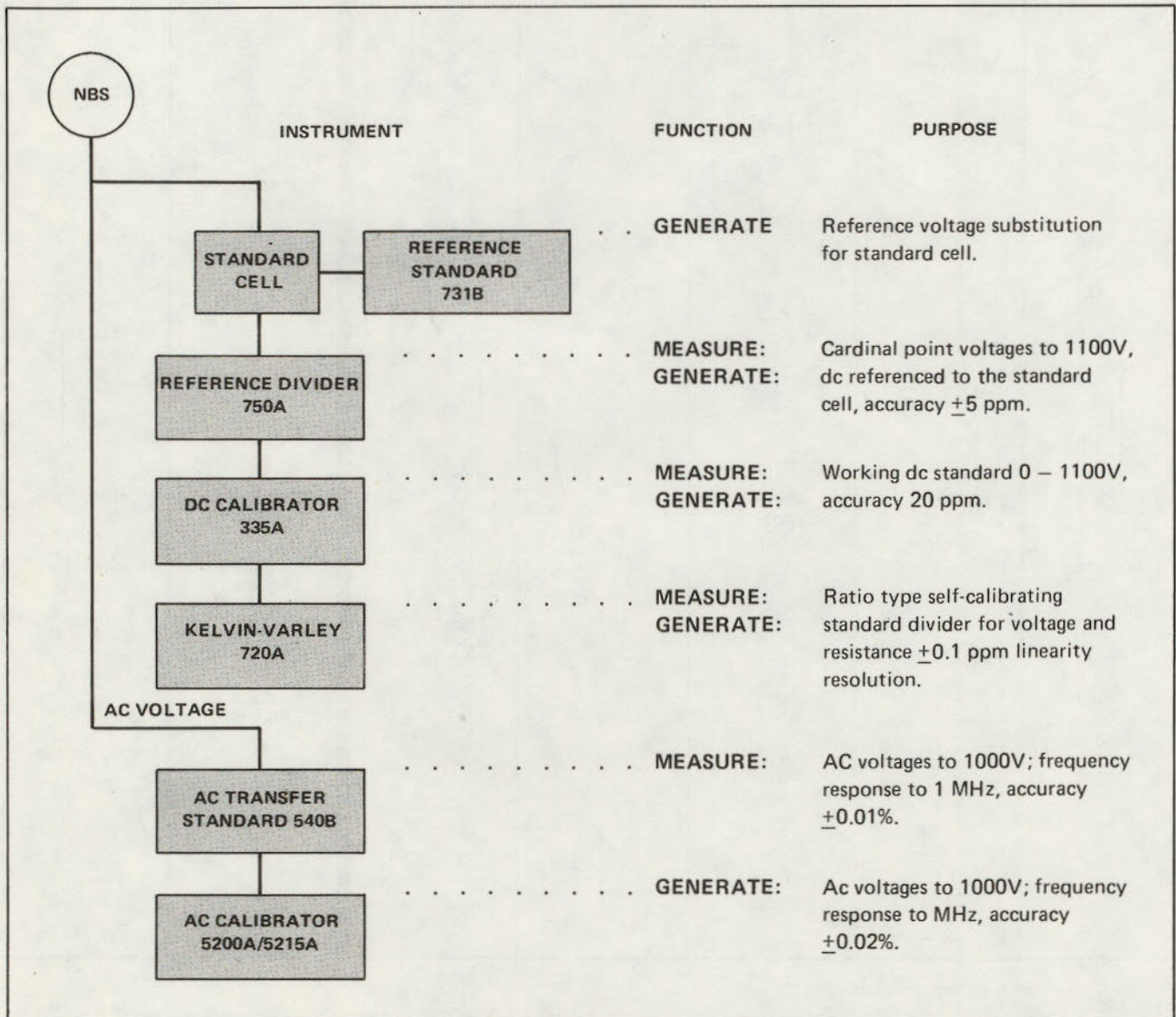

Figure 49. AC-DC voltage traceability.

Equipment	Purpose	Accuracy	Fluke Model	Self-Calib. Lab (Basic dc accy. 5 ppm)	Dependent Lab (Basic dc accy. 20 ppm)	Annual Calibration Costs for Dependent Lab
DC Calibrator/ Null Detector	Generate dc volts Working Standard	20 ppm	335A	YES	YES	\$1,200 ⁽¹⁾
Reference Divider	Generate/Measure dc volts	5 ppm	750A	YES	YES	\$ 180 ⁽²⁾
Kelvin-Varley Divider	Generate/Measure dc volts – ohms	0.1 ppm	720A	YES	NO	
Lead Compensator	Accessory for Ohms measurement	--	721A	YES	NO	
Null Detector	Accessory for dc volts – ohms	--	845AR	YES	NO	
AC Transfer Standard	Measure ac volts	0.01%	540B	YES	NO	
AC Voltage Cal System	Generate ac volts	0.05%	5200A/ 5215A	YES	YES	\$1,600 ⁽¹⁾
DC Reference Standard	Generate dc Reference Voltage	2 ppm	Standard Cell Bath 731B	YES	YES	
Cabinet	Custom cabinet to contain first 6 items above s a system designated Fluke Model 7105A		7105A-502	YES		
				<u>APPROX</u> \$21,000	<u>APPROX</u> \$15,000	<u>APPROX</u> \$3,000

(1) Based on three month recalibration cycle.

(2) Calibrate once each year.

Figure 50. Equipping a calibration lab self-calibrating versus dependent lab.

SELF CALIBRATION

Referring to the traceability chart, observe there are two primary reference devices which are certified by NBS; the saturated cell and the thermocouple. By having these two standards certified, every measurement and every voltage generated will be traceable to NBS through either the standard cell or ac-dc transfer standard (thermocouple).

The self-calibrating lab is equipped with a key ratiometric instrument, the Kelvin-Varley Divider. In its simplest schematic form, it may be drawn as a potentiometer, see Figure 51.

The Kelvin-Varley Divider has two important performance characteristics:

1. Readily conforms to a decade configuration with a high degree of linearity.
2. Provides an essentially constant load on the applied input voltage regardless of output loading.

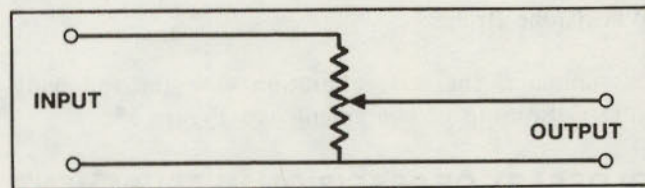

Figure 51.

The Fluke Model 720A Kelvin-Varley Divider is uniquely equipped with internal resistors and calibration pots so it can easily be recalibrated without

another standard. When in the calibrate mode, the Model 720A is configured as a Wheatstone Bridge, see Figure 52.

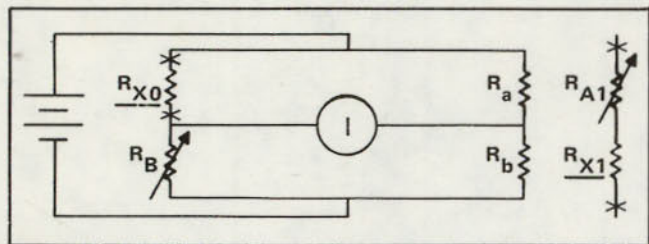

Figure 52.

R_{X0} is the first resistor of the eleven resistor series string in the A, (first) decade of the divider. R_B , R_a and R_b are also built into the 720A. R_a and R_b are fixed resistors and in the cal mode become one leg of the Wheatstone Bridge. R_B ($R_{Balance}$) is a rheostat on the front panel which may be adjusted to establish a bridge balance. When the second resistor R_{X1} , of the A decade is switched in its trimmed resistor, R_{A1} may be adjusted to repeat the balance established with R_{X0} and R_B . This process is repeated for all resistors in the string, each having its own trimmer resistor. The result is that each A deck resistor has been adjusted to an equal resistance value of within 0.1 ppm.

This calibration technique is called *ratimetric* which simply means that all values of a series string of resistors have been set to be equal (to within 0.1 ppm). Notice their absolute value is unimportant since this Kelvin-Varley Divider — this pot — will only be used as a linear voltage divider and never as an absolute value of resistance. Since the divider is linear, it follows that if we apply 10 volts to divider's input and set the dials to 0.1000000, the output will be $1V \pm 0.1$ ppm because the linearity of all settings of the divider is 0.1 ppm of the total input impedance.

Since the K-V divider can be self calibrated using the Wheatstone Bridge scheme, it also follows the Model 750A, another *ratimetric* resistive divider, can be linearized in the same manner. This is accomplished using the 720A K-V divider, as R_a and R_b resistors of the Wheatstone Bridge.

In summary, the self calibration with the following interrelationship of equipment: see Figure 53.

GLOSSARY OF PRECISION MEASUREMENT TERMS

Absolute

Refers to the degree of accuracy relative to a reference standard.

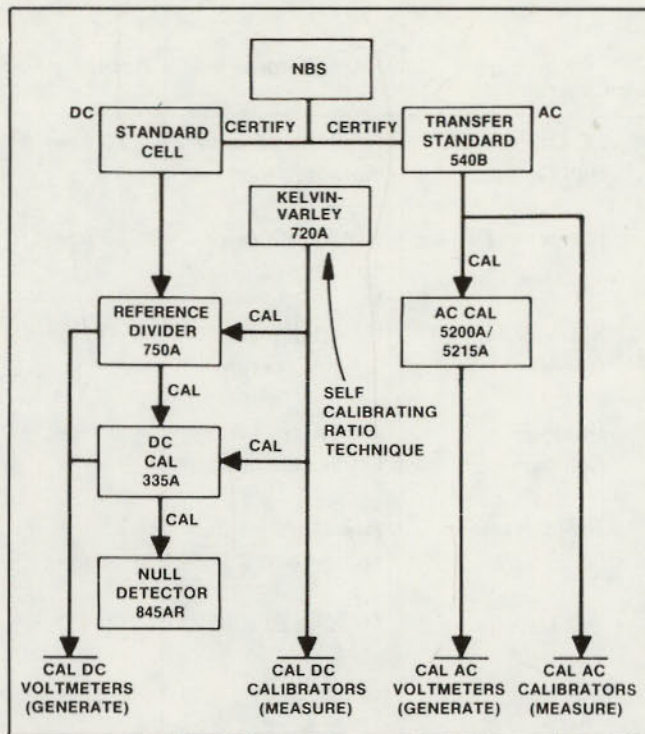

Figure 53. The self calibrating lab.

AC/DC Thermal Transfer Standard

The transfer standard is an instrument which precisely measures the rms value of an ac voltage (or current when equipped with shunt) by employing a thermocouple to compare the heating effect of a known dc voltage to the unknown ac voltage. When the output of the thermocouple is equal with both dc and ac voltages applied, it is established their rms values are equal. The ac/dc thermal transfer standard, e.g., Fluke Model 540B, is used as a primary reference.

Active Instrument

Any equipment whose design incorporates voltage powered circuits, amplifiers, electronic null detectors, etc. Active instruments are usually specified with a systems or overall accuracy statement and avoids any specification of discrete points such as an error correction chart.

Certainty

Describes the confidence in terms of a percentage when making an absolute measurement. Sometimes reported as "uncertainty". The certainty statement follows strict mathematical rules of prediction.

Certificate of Calibration

A Certificate of Calibration is issued by all viable instrument manufacturers and is a statement which attests to the integrity of calibration of each piece of

equipment shipped by that manufacturer to the extent the equipment has been calibrated with instruments which are traceable to NBS.

Differential Voltmeter

The differential voltmeter is sometimes referred to as a potentiometric measuring system, which literally is defined as equipment to measure emf incorporating resistive dividers. Obviously, this term covers many types of voltmeters. Fluke named their voltmeter the differential to more closely describe the measurement technique employed. The differential voltmeter compares its internal voltage, whose value is known to the unknown applied voltage through a Kelvin-Varley Divider and null detector.

Kelvin-Varley Divider

In its simplest form, this resistive divider may be drawn schematically as a potentiometer. The Kelvin-Varley is a switched circuit of series resistors of which any two of the series resistors are always shunted by a second resistance string of value equal to the shunted two. The Kelvin-Varley is readily constructed into a decade configuration; provides a mostly constant contact resistance for any setting; and appears as a nearly constant load on its source for any setting. The Kelvin-Varley is employed both as a voltage divider or as the ratio arm of a Wheatstone Bridge.

Linearity

Refers to the degree of accuracy for equal step changes relative to the previous level, setting, or reading. Expressed in percentage, ppm, or dB.

Parts Per Million (ppm)

Convenient means of expressing extremely small percentages of the whole number. Speaking or writing in terms of ppm reduces error in placing zeros when expressing a percentage of less than 0.1% e.g., 1 μ V is 0.0001% of 1 volt. It is also 1 ppm of 1 volt.

Passive Instrument

Any equipment which without being powered will perform its intended function such as resistors, thermal converters, standard cells. Accuracy statements for this type of equipment often includes an absolute number relative to a reference standard.

Potentiometric

Any equipment intended to measure emf incorporating resistive dividers. Generally the term applies to a bucking measurement scheme comparing a known voltage to the unknown voltage through a null detector, e.g., dc differential voltmeter.

Ratiometric

A measurement to compare relative values of two or more devices without regard to their absolute values; e.g., the Kelvin-Varley Divider is calibrated using the ratiometric technique to assure all resistors of a decade are the same value, but their actual ohmic is not known or needed.

Reference Cell

Synonymous with standard cell

Reference Divider

A resistive instrument which precisely establishes dc voltages by comparison to a standard cell. The reference divider is calibrated ratiometrically, e.g., Fluke Model 750A.

Reference Standard

Any device which provides known and predictable electrical units, e.g., the standard cell, standard resistor, thermal converter.

Report of Test/Calibration

Any Government Standards Lab (e.g., NBS) issues a "Report of Test" or a "Report of Calibration" for primary standards such as saturated standard cells, thermal converters, standard resistors, etc. The "Calibration Report" states the deviation of the device relative to the NBS reference and the uncertainty of the measurement. Calibration Reports are employed for thermal converters and standard resistors, etc. "Report of Test" states an absolute number of the device resulting from a comparison to the NBS reference. Report of Test is issued for the primary standard cell.

Resolution

The degree in which a whole quantity may be divided into a part of that quantity. Stated as a percentage, in ppm, or in dB of the whole.

Stability

Stability is a resistance to change relating to an instrument's performance and usually measured against time, temperature and humidity. If an instrument had perfect stability, recalibration would never be required and its performance would provide absolute accuracy under all conditions.

Standard Cell

A stable source of emf generated from chemical reaction employing mercury (+) and cadmium in a mercury amalgam (-) at the electrodes in an electrolyte solution of cadmium sulfate. Two types of standard cell are

employed. The saturated cell offers a strict stability of emf for long time periods, had a large temperature coefficient, is maintained at a constant temperature, is used as a primary reference at a nominal voltage of 1.0184. The unsaturated cell offers a relatively low temperature coefficient but demonstrates poor stability against time (40 ppm/year) and is used as a portable working reference standard at 1.019 volts nominal. Give credit to Weston (1894) for improvements over the Clark cell (1835). The Weston cell to date remains the practical dc volts primary standard.

Thermal Voltages

A thermal voltage is developed as a result of the Seebeck effect (thermocouple) which is a voltage generated resulting from the junction of two dissimilar metals. They occur at binding posts, switch contact, PCB connectors etc. Their levels display a large temperature coefficient and are usually controlled, never eliminated. Good habits to reduce their effect include: (1) tight connections; (2) clean (salt/grease free) connections; and (3) considerations for the use of similar materials for a connection; e.g., gold to gold, copper to copper, etc.



Figure 54. Fluke Model 332D D.C. Voltage Standard

A D.C. calibration standard should be an extremely stable voltage standard that will deliver any desired output, 0-1111 volts, with an accuracy of 20 ppm to 10 ppm. The instrument should be designed to satisfy the most critical requirements for a precision calibrator or voltage reference source with outstanding regulation and environmental specifications. Over voltage and over current protection features would indicate that the instrument is well suited for day to day use or in a controlled laboratory environment.



Figure 55. Fluke Model 335D D.C. Voltage Standard

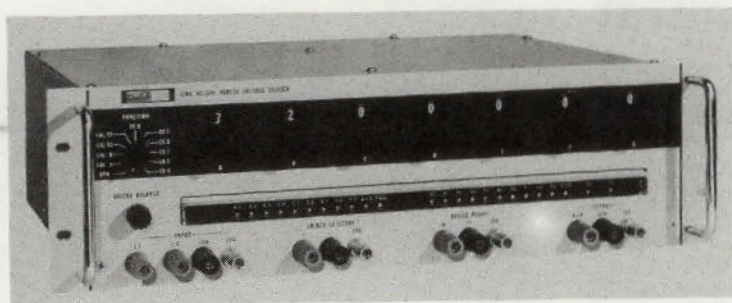

Figure 56. Fluke Model 720A Kelvin-Varley Voltage Divider

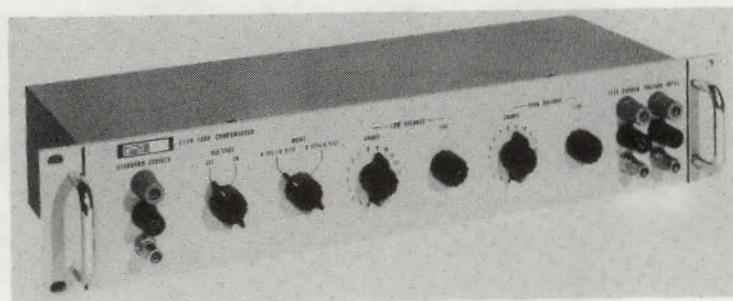

Figure 57. Fluke Model 721A Lead Compensator

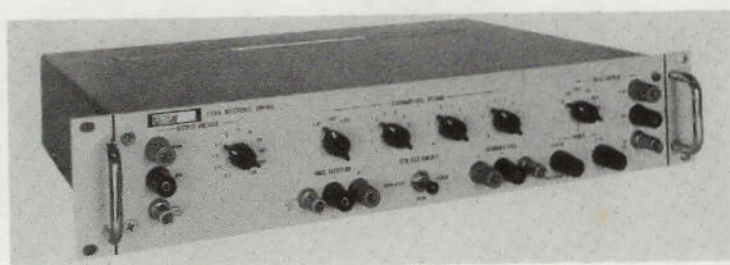
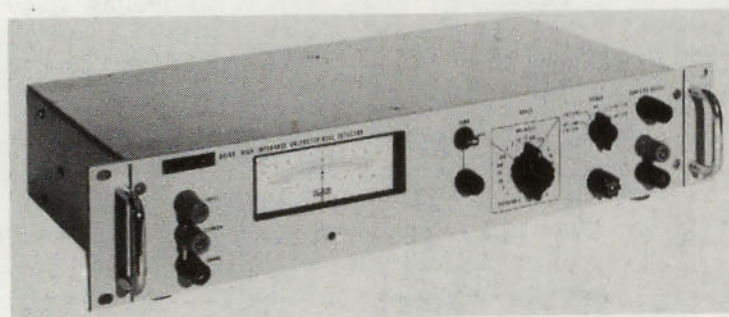

Figure 58. Fluke Model 750A Reference Divider



Fluke 59. Fluke Model 845AR Null Detector-High Impedance Voltmeter

A primary ratio standard should meet the most exacting requirements for the standards laboratory. Absolute linearity of 0.1 ppm, tempco of linearity of 0.1 ppm/°C, and self calibration would make it the most accurate instrument available for the comparison of primary and secondary voltage and resistance standards.

A lead compensator equalizes the voltage drop across two resistive dividers connected in parallel for calibration. Because there is almost always a difference between two dividers at their zero and full scale voltages, calculations must be made for each calibration point unless the effects of contact and lead resistance are eliminated from the measurement by compensation.

An accurate and stable reference voltage divider for precision calibration should be a 10 ppm divider with switched input taps from 1.1 to 1100 volts D.C. and switched output taps from 0.1 to 1100 volts D.C. the unit should have a separate output which covers 1.01700 steps so that it may be standardized directly to any known standard cell emf.

A solid state null detector should be designed for extremely high input impedance, sensitivity and isolation. It should offer resistance $\geq 10 \text{ M}\Omega$ on 1 μV to 100 mV ranges and $\geq 100 \text{ M}\Omega$ on 300 mV to 1000V ranges.

13

7105 DC Voltage and Ratio Calibration Systems

PURPOSE

The purpose of this is to familiarize users with the basic building blocks of the 7105 system and how that system can be used to its maximum accuracy. In general, no attempt will be made to explain the internal operation of each component of the system. However, special attention will be given to the theory of operation, calibration, and applications of the Model 720A and 750A which comprise the heart of the system.

7105 SYSTEM

The 7105 system is a versatile, self-calibrating system which is designed to perform accurate DC measurements. With a calibrated DC voltage source and a set of calibrated resistors, accuracies equal to or approaching standards laboratory accuracies can be achieved. In addition, ratio devices may be calibrated to accuracies near 1 part per million (ppm).

Model 335A

The Model 335A is a DC source with 10,100, and 1000 volt ranges. The resolution of the Model 335A is 0.1 ppm maximum.

The Model 335A performs two functions.

1. A working source to supply uncalibrated voltages.
2. A moderate accuracy calibration source.

The Model 335A also has an additional feature, a null detector, incorporated within.

Model 845AR

The Model 845AR serves as a high impedance null detector for the system. It has a recorder output for performing stability measurements.

Model 720A

The Model 720A is a self-calibrating Kelvin-Varley voltage divider which serves to make the ratio and transfer measurements for the system. In addition, the

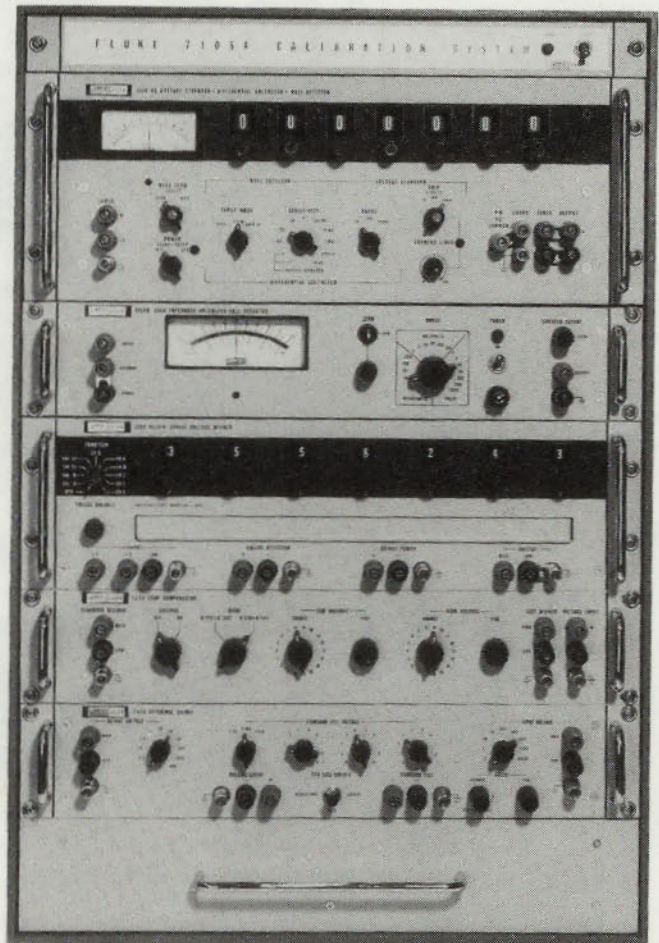

Figure 60. 7105 DC Voltage Calibration System

Model 720A in conjunction with the Model 721A serves as the basis for the system self-calibration.

Model 721A

The Model 721A is comparable to two reostats. Its function is to reduce errors caused by currents flowing through connecting leads. The Model 721A needs only periodic maintenance and does not need calibration.

Model 750A

The Model 750A is a resistive voltage divider which is protected from damaging currents. It can extend the

voltage measurement capability of the system to 1100 volts dc.

Accuracy

DC VOLTAGE

(Assumes 3 ppm for Standard Cell.)

1 volt to 1100V, 8 ppm

0.1 to 1 volt, 10 ppm +1 μ V

RESISTANCE

(Excluding Accuracy of standard resistor)

1. At decade values from 100 ohms to 100 k Ω using interchange, or substitution techniques transfer accuracies of 2 ppm can be achieved.
2. At decade values from 0.1 Ω to 10 Ω , transfer accuracies of 5 ppm can be achieved.
3. At decade values from 1M to 10M, transfer accuracies of 50 ppm can be achieved.
4. At resistance values between decade values, accuracies of approximately two times the highest adjacent accuracy can be achieved.

The above accuracies assume that good technique and high quality resistors are measured.

DC CURRENT

DC current accuracy is a function of the above voltage and resistance accuracies, worst case being the sum of each. Because of the voltage/current capabilities of the system alternate DC sources may have to be employed for some of the measurements above.

General Notes on DC Measurements

DC measurement results can be affected by many factors. Some of the factors which effect the result of a measurement are:

LEAKAGE CURRENT

Errors leakage currents are defined as current which bypass the item under test. Leakage currents can cause errors when the resistance of the leakage paths is significant compared to the resistance of the item under test. The effects of leakage currents can be reduced by techniques known as Guarding. Occasionally, large value resistors and voltage sources have what is known as a guard terminal. It is this terminal that collects the leakage current.

SELF-HEATING

Self-heating errors occur when power is dissipated in a resistor. The heat generated nearly always change the value of the resistor or voltage being measured.

MUTUAL HEATING

Errors due to mutual heating occur from heat being transferred from adjacent heat sources to the item under test. The effect is the same as self-heating the net effect of self-heating and mutual heating is often called "Power Coefficient."

LEAD WIRE ERRORS

Connecting lead wires can cause errors when their resistance is not properly accounted for. To eliminate the effects of lead wires the resistance of the wires should be balanced or zero current should flow within them. Generally, in a measurement, when zero current flows in a wire, the wire is called a "Sense Lead." Most good, low value resistors are composed of four terminals. Measurements made on the resistors are usually "Four-Terminal" measurements. Two of the terminals are "Current Terminals." These terminals inject the current into the resistor, and are normally the larger of the four terminals. The remaining terminals are called the potential or sense terminals. They allow the magnitude of the voltage across the resistor to be "Sensed" since very small current flows from these terminals, they are usually the smaller of the four terminals. Many voltage sources which supply current have current and potential terminals. They serve the same function as described above. In many cases, (such as standard cells) very small currents should flow from the voltage source. The measurement of such sources should be a potential measurement that is, no current should flow through the voltage source.

NOISE ERRORS

One of the limiting factors of any DC measurement is electrical noise which usually does not cause errors, but it does limit the "Resolution" of a measurement. Noise is usually reduced by good shielding techniques.

LOADING ERRORS

Loading errors occur when current passes through a voltage source with a finite source impedance.

THERMAL VOLTAGE ERRORS

When parts of a circuit that operate at different temperatures are interconnected, thermal voltages will normally be present.

These voltages can be greater than 10 μ V!

The effect of these voltages can be reduced several ways:

1. Keep all elements of a circuit at the same temperature. Because aluminum has good thermal conductivity, many circuits are enclosed in heavy aluminum cases.
2. Thermal shunts help reduce the effect of thermal

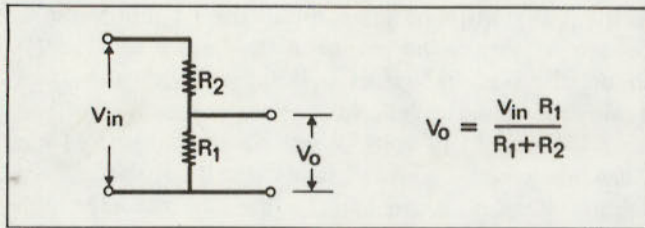

Figure 62.

Also note, if R_1 is changed by a given proportion, the ratio remains unaffected if R_2 is changed by the same proportion.

Therefore, if R_1 and R_2 are chosen to have the same or zero temperature coefficient of resistance, their ratio remains constant. Power coefficient of the divider is thereby reduced.

Kelvin-Varley Divider

Placed near the low side of the Model 750A divider string is a Kelvin-Varley Divider. In most DC voltage measurements a standard cell is the basic reference. As was mentioned before, the emf of most standard cells is close to either 1.018 or 1.019V dc. The four dials of the Kelvin-Varley Divider allow for selection of an output voltage which is equal to a given standard cell.

Voltage Trip Circuit

Figure 63 shows the basic circuit for over voltage protection of the Model 750A. K1 contacts are shown in normally closed position. If the input voltage is near rated voltage, i is about 0.07 mA. This current flowing through R207 is not sufficient to forward bias the base of Q2; however, if i is about 0.1 mA, or higher, Q2 is forward biased and a small current is provided for the base of Q1. Collector current of Q1 turns on Q2 harder.

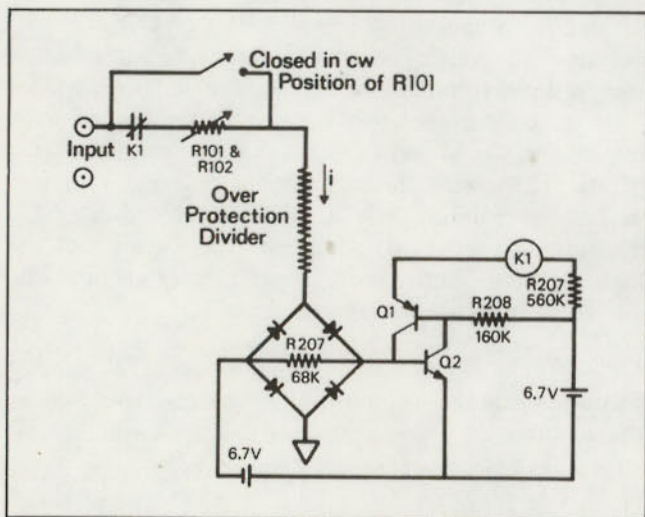

Figure 63.

This regeneration continues until both Q2 and Q1 are saturated. Saturation current through Q1 energizes the solenoid of K1 which opens the contacts of K1. Thus, overvoltage protection is afforded the input of the Model 750A. It should be noted that protection is provided only when R101 is "NOT" in the cw position. This provision is so noted on the front panel of the Model 750A.

Applications for the 7105 System

By using the 7105 system or portions thereof, most DC measurements can be made. Primarily, the 7105 system will be used for generation or measurement of accurate DC voltages.

USING THE MODEL 750A

Generation or Measurement of Accurate DC Voltage

The circuit shown in Figure 64 shows the basic 750A configuration. If approximately 1100V dc is applied to the input terminals with the input switch placed to the 1100V position, the voltage at the output will be approximately the voltage selected by the output switch. If at the same time a standard cell, of known emf, and a Model 845AR are connected to the appropriate connectors, with the Kelvin-Varley dials placed to the standard cells emf and the input voltage adjusted until a null is obtained on the 845AR, the voltage selected by the output switch will be very accurate.

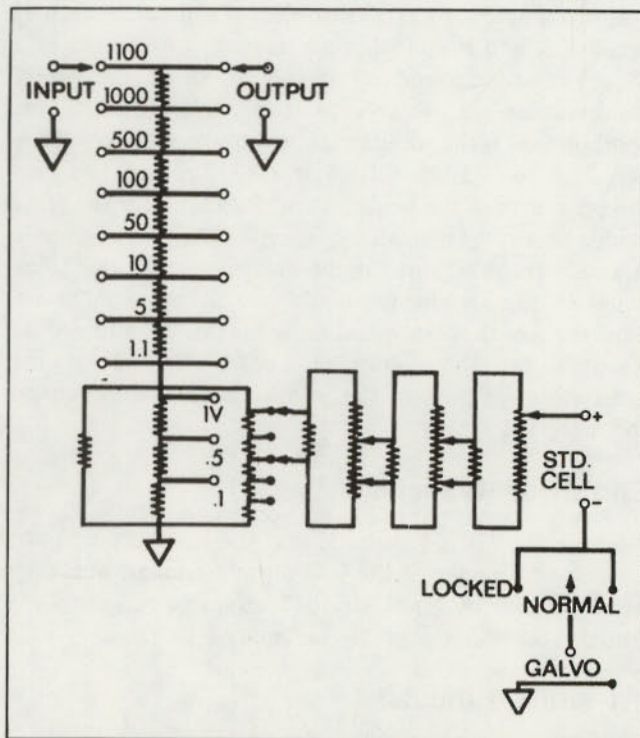

Figure 64. Model 750A, general schematic.

Referring to the standard cell (Figure 65) circuit, if the voltage across the 845AR is zero, no current flows in the standard cell. This is desirable, for two reasons. First, the standard cell may be damaged from excessive current and second, any current passing through the galvo indicates that the Model 750A is not standardized and, therefore, not accurate. Errors due to current flowing into or out of the output terminals of a divider are called "Loading Errors." Loading errors can be avoided by connecting the divider output terminals through a null detector to a voltage equal to the divider output voltage. For this reason, the Model 750A is excellent for calibrating power supplies or voltage calibration source.

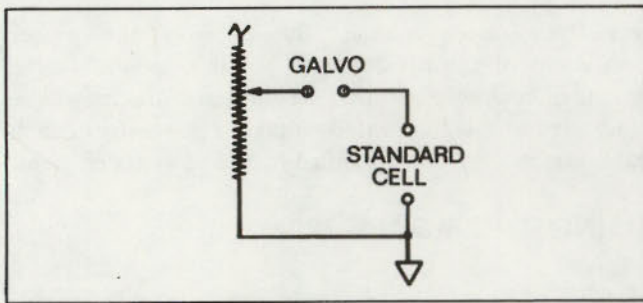

Figure 65.

750A A DC Voltage Source Calibrator

Figure 66 shows the Model 750A used as a voltage supply calibrator. If the standard cell circuit is properly nulled, then the Model 750A is standardized. Let the DC supply to be calibrated (V_x) have ranges of 10V, 100V, and 1000V (such as a Model 332B). By placing V_x range to 10V and the 750A output to 10V, the difference in the 750A and V_x output voltage can be seen. V_x can be calibrated on the 10V range by adjusting to 10V until a null is obtained on Galvo G. Note that no current flows through the Model 750A output terminals. The same procedure can be used to calibrate the 100V and 1000V ranges. In a similar manner the Model 750A can be used to calibrate Differential

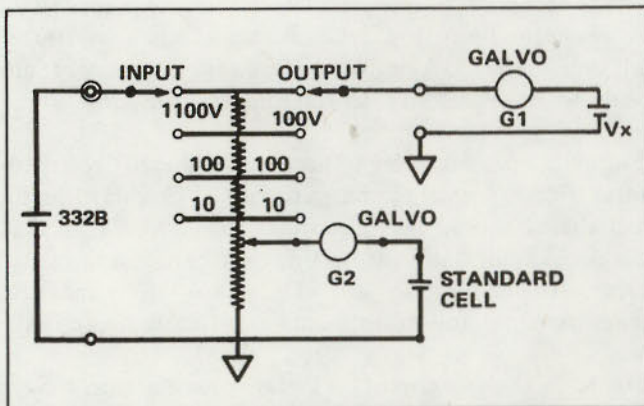

Figure 66. Used a power supply calibrator.

Voltmeters. Most differential voltmeters generate a voltage which oppose the unknown voltage, thus, no current flows from the voltage source being measured. Such differential voltmeters are said to have infinite impedance at null. The very high impedance of a differential voltmeter, at null, will cause negligible loading errors on the Model 750A. However, care should be exercised in calibrating some differential voltmeters, because of the input impedance of the voltmeter on the 100V and 1000V dc volt ranges is finite.

The manual for the voltmeter to be calibrated should be read to determine the input impedance. If the input impedance is finite the following procedure should be used. For example, say the 100V range of the differential voltmeter is to be calibrated. The impedance of the voltmeter is represented by Z_{in} . By using the technique shown in Figure 67, the current needed by the voltmeter is supplied by the source (335A) and not by the 750A. Consequently, loading errors on the 750A are avoided. There will be lead wire errors due to the leads connecting the differential voltmeter carrying current. These errors can be reduced by making the lead wire resistance much smaller than Z_{in} . For example, a differential voltmeter with 10 M Ω input impedance at 100V will have a calibration error of 1 ppm due to lead wires if the lead wire resistance is 10 Ω .

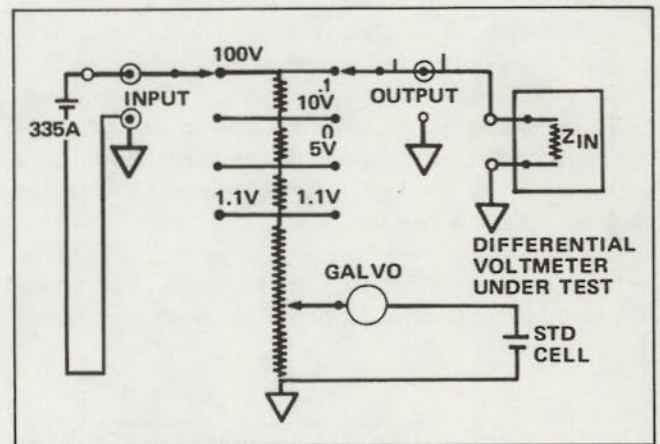

Figure 67. Circuit to use to avoid loading errors.

In general, in the case of finite impedance voltmeters, avoid supplying the voltmeter with current from the Model 750A, but use the working supply to supply the current to the voltmeter.

Measurement of Power Coefficient of a Divider

It was stated before that power coefficient is the lumped result of all heating effects. Figure 68 shows a method of measuring power coefficient. It should be noted that the test divider and the Model 750A should have the same nominal ratio as the divider under test and in no case should the voltage rating of the dividers be exceeded.

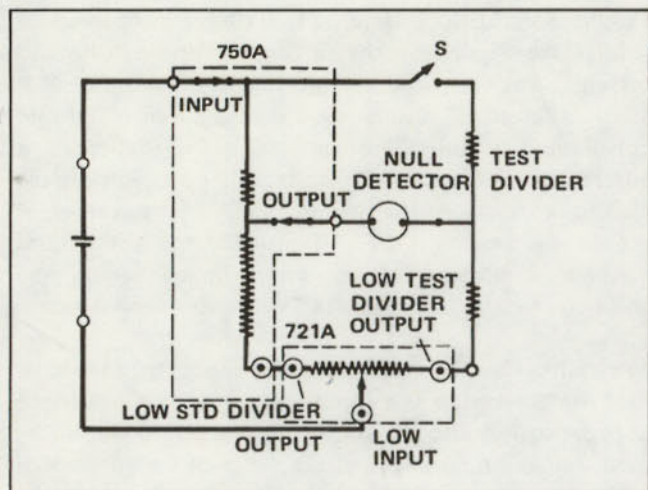

Figure 68.

Also, this test does not check absolute ratio accuracy, but changes in ratio due to power coefficient. One of the rheostats of the Model 721A is used to adjust for slight ratio differences between the test divider and the Model 750A. First, with Switch S open, the proper voltage is applied to the Model 750A for a few hours. This is to allow the effects of the Model 750A power coefficient to reach a steady state level. Then, Switch S is closed and the Model 721A rheostat is adjusted for a null on the null detector. Next, Switch S is opened and the test divider is allowed to cool to room temperature. This usually takes only a few minutes. Finally, Switch S is closed and the null detector deflection in μV is observed. Call this reading G_1 . Because of the power coefficient of the test divider, its ratio will begin changing. After a period of time, the null detector will reach a steady reading. Call this reading in μV , G_2 .

Let the output voltage in volts be V . Let the power dissipated in the test divider be W . The power coefficient in ppm/watt is:

$$\text{Power coefficient} = \frac{(G_2 - G_1 \times 10^6)/W}{V}$$

Where:

V is the divider output voltage

W is the total power dissipated in the test divider

A recorder can be placed on the recorder output of the null detector. In this way, a plot of ratio change with respect to time may be recorded.

Figure 69 shows typical plots which may result. Plot A illustrates a divider whose ratio is primarily influenced by self heating. Plot B shows a divider whose ratio is influenced by both self and mutual heating.

There are two reasons why the power coefficient is important: First, many times the divider will be used at

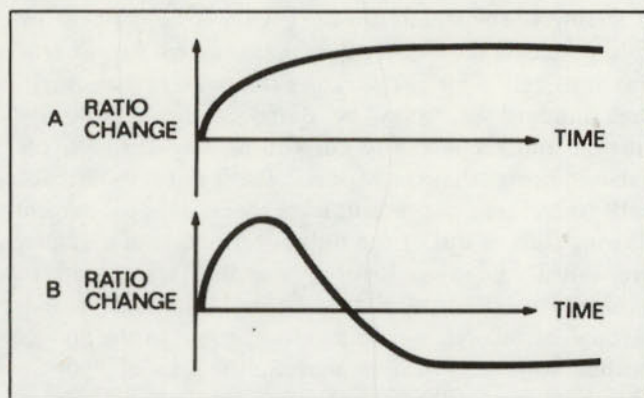

Figure 69.

less than rated voltage. By knowing the power coefficient of the divider it is possible to qualify the results of such tests. Second, very often a divider will be calibrated at less than rated voltage. The results of such calibrations should be qualified by the power coefficient.

USING THE MODEL 720A

Because of its excellent linearity and its ratio is variable from 0 to 1.0, the 720A is a versatile instrument for DC measurements. For the purposes of the following discussion, the Model 720A will be represented as shown in Figure 70.

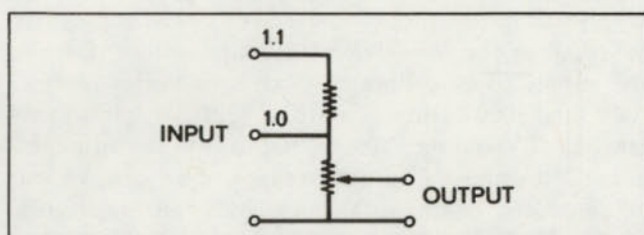

Figure 70.

For Linearity Tests

In most DC power supplies and calibrators, the linearity of the decades is as important as the full scale accuracy. A properly linearized DC calibrator (such as Fluke Models 332B, 335A or 343A) allows the accuracy of full scale to be transferred to intermediate outputs.

Linearity does not refer to accuracy. Linearity refers to ratio. For example, the output of a DC Calibrator with a 3 dialed should be three times the output with a 1 dialed. Any deviation from this condition is a linearity error. In calibrating any DC Calibrator linearity measurements and adjustments are usually made first.

Figure 71 shows a circuit for linearity measurement. Say for example, a 332B is to be linearized. Let this be the test supply. In any linearity measurement or adjustment,

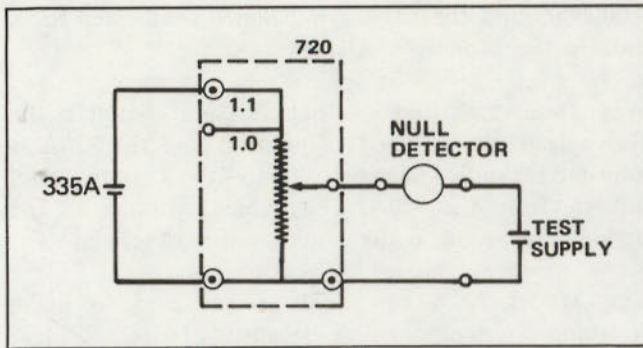

Figure 71.

a reference point must be taken. $X(10)$ on the third decade is chosen as the reference.

On the 100V range of the 332B place all decade dials to zero and place the 720 decade dials to zero. Adjust the 332B 100V zero adjustment to a null on the null detector. Place the 332B dials to 00.X and the 720A dials 0.1000000. Adjust the working source, 335A, to null the null detector (approximately 11.0V). do not change the 335A dial setting while linearizing the 332B. Now place the 332B dials to 01.000000. Adjust the second decade, step one linearity adjustment for a null. Successively place the 335A dials to 02.0000, 03.0000 etc. and the 720A dials to 0.200000, 0.300000 etc. and null the null detector with the appropriate linearization adjustment now, the second decade is linearized. Now place the 332B range switch to 10 and all decade dials to zero and zero the 332B 10V zero adjustment in the same way that the 100V zero adjustment was performed. Place the 332B output dials to 0.X00000 and the 720A dials to 0.1000000. Adjust the 335A for a null on the null detector. Now place the 332B output dials to 1.000000 and adjust the first decade, step 1 linearization adjustment for a null on the null detector. Finally, linearize each first decade step in the same manner used for the second decade. The 335A is now linearized. All that remains is to calibrate each range. The Model 750A can be used to perform this calibration.

CALIBRATING A VOLTAGE DIVIDER WITH THE MODEL 720A

Many voltage dividers can be calibrated with the Model 720A voltage divider.

One requirement a voltage divider should have for the most accurate calibration, with a Model 720A, is adjacent ratios should not be greater than 10:1 or less than 1:10.

A common divider in the use today has adjacent ratios of 2:1, 3:2, 4:3, 5:4, 2:1, 2:1, 3:2, 4:3 and so forth. The Model 750A has adjacent ratios of 5:1, 10:1, 1.1:1, 5:1.1,

10:5, 5:1, 2:1, 5:1, 2:1 and 1.1:1. Therefore the Model 750A can be calibrated with a Model 720A and is done so in the 7105A system.

A general scheme used to calibrate a voltage divider is shown in Figure 72 which is intended to show only the technique of measurement. The figure has sources of error which will be dealt with later. In any voltage divider a reference should be taken. In this example all inputs will be referred to the 1V output. Figure 72 shows the 720A measuring the 10V:1V ratio. Let this ratio be X_1 .

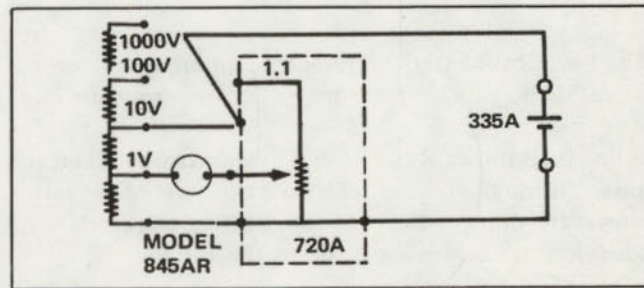

Figure 72.

Using algebra of small parts, X_1 can be expressed as:

$$X_1 = 10/1(1 + \Delta_1)$$

Where Δ_1 is the proportional error of the 10V/1V ratio. Δ_1 will be expressed in parts per million.

By using the same procedure, the ratio of the 100V input to the 10V output can be found. This ratio is X_2 . Again, using algebra of small parts:

$$X_2 = 100/10(1 + \Delta_2)$$

The ratio of the 100V input to the 1V output can be found by multiplying X_1 by X_2 .

The result of this multiplication using algebra of small parts, is $X_1 X_2 = 10/1(1 + \Delta_1) \times 100/10(1 + \Delta_2)$ or $X_1 X_2 = 100/1(1 + \Delta_1 + \Delta_2)$.

The error in proportional parts for the 100V/1V ratio is then $\Delta_1 + \Delta_2$.

Finally the ratio of the 1000V input to 100V output is found. The error in proportional parts is Δ_3 . The error in proportional parts for the 1000V/1V ratio is then $\Delta_1 + \Delta_2 + \Delta_3$.

A general expression for finding the ratio of any input to any output is:

$$X = A_n(1 + \sum_1^n \Delta_n)$$

Where A_n is the nominal ratio of the input voltage to output voltage and Δ_n is the individual ratio error expressed in ppm.

It was stated that Figure 72 has sources of error. The technique did not account for lead wire errors and a special lead wire error called "Rod Resistance" error.

Figure 73 illustrates "Rod Resistance" error:

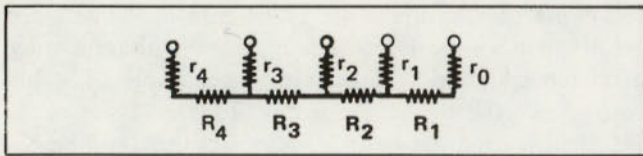

Figure 73.

The lower case letters represent the internal connecting wires of the divider resistors, called rod resistances.

When the ratio of R_2 to $R_1 + R_2$ was measured, current passed through r_2 . In other words r_2 is part of the ratio. However, during use, no current passes through r_2 . Therefore, r_2 causes an error in the ratio.

A way to avoid rod resistance errors is shown in Figure 74. Note that the Model 721A lead balance has been added to the circuit. Also, note that another terminal has been added to the low side of the output. The object of the calibration is to find the ratio of R_1 to $R_1 + R_2$ and to make r_0 and r_2 part of connecting leads.

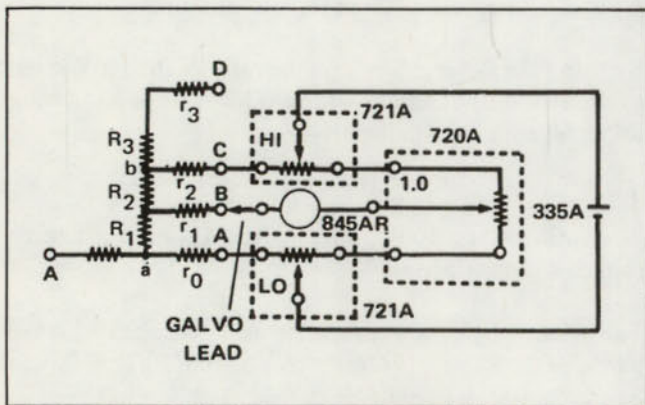

Figure 74.

This is accomplished by taking what is called high and low balances.

High balance is done by setting the 720A to 0.999999X and connecting the Galvo lead to point D. The 721A Hi balance is adjusted for a null on the Model 845AR. When this condition is achieved, no current flows through r_3 and R_3 . In other words the sense point becomes point b and r_2 becomes part of the lead wires and is balanced out so as to cause no error.

The low balance is taken in a similar manner. The Galvo lead is connected to point A', the 720A is dialed to

0.0000000 and the 721A low balance is adjusted for a null on the Model 845AR.

When both high and low balances are complete, the Galvo lead is connected to point B and the 720A is adjusted for null. The ratio of R_1 to $R_1 + R_2$ is then read directly from the 720A. The remaining ratios of the divider are found in the same manner described.

The Model 720A can easily be adapted to make resistance measurements. Because of its excellent linearity, the 720A can be used to find the ratio of an unknown resistor to a standard resistor.

Four Terminal Resistance Measurements

Four terminal resistors are generally low value resistors, 100 ohms and less. Often current shunts are four terminal resistors. As an example, assume we desire to measure a nominally, 4 ohm resistor. Figure 75 shows a method to measure such a resistor. Let R_s be a standard, 10Ω resistor such as a Rosa resistor. Leads a, b, c should be large enough to pass the required current. But, more important, the connecting wires a, b, and c should make good electrical and mechanical connection. Note that if these connections change 1 milli-ohm, the resultant measurement will be affected about 0.01%. Generally the working supply current is chosen so that the power rating of the resistors is not exceeded and at the same time enough voltage is developed across each resistor to give good resolution.

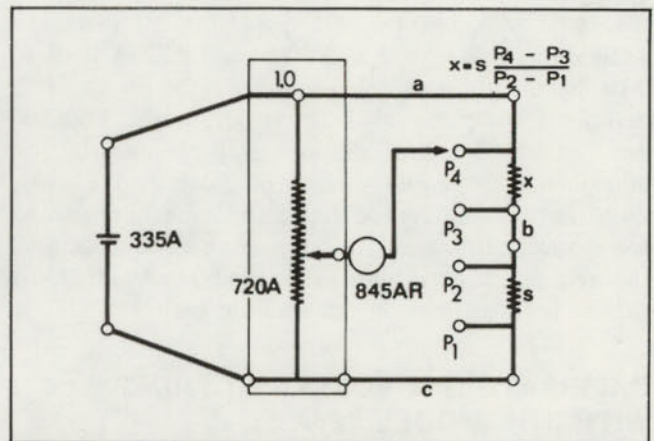

Figure 75. Four terminal resistance measurement.

In this case, 50 mA is chosen. This will give a resolution of about 10 ppm and a power dissipation of about 0.025 watt in the 10 ohm resistor.

The output of the 335A should be adjusted for about 50 mA, 0.7V. The Model 720A is successively adjusted for a null on the null detector with the Galvo lead connected to points P_1 , P_2 , P_3 , and P_4 . Call these four 720A readings P_1 , P_2 , P_3 and P_4 .

Then:

$$X = S P_4 - P_3 \div P_2 - P_1$$

Where:

X is the unknown resistor value

S is the value of the standard corrected for temperature

Two Terminal Resistance Measurement

Although the technique illustrated above can be extended to measurement of larger valued, two terminal resistors, a technique which avoids the cumbersome arithmetic of the preceding technique is the "direct reading method." This method requires a decade resistance box of about 1 or 0.1 ohm per step and a calibrated standard resistor. The standard resistor is chosen to be approximately equal to or not more than ten times the value of the unknown resistor.

Figure 76 shows a method of using the Model 720A to make direct reading resistance measurements. Take an instance when we desire to measure a nominally 4000 ohm resistor. To standardize the measurement system, substitute a 10k, calibrated resistor at points A and B.

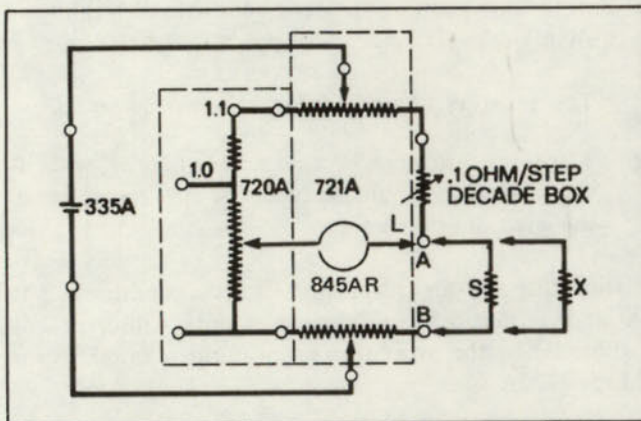

Figure 76. Direct reading resistance measurement.

Set the dials of the 720A to the value of the standard resistor. In other words, if the value of the standard resistor is 10,000 3.7 ohms set the dials of the 720A to 1.0000370. Adjust the decade box to as close null as possible on the Model 845AR final null will be obtained with the Hi balance pot of the Model 721A. Now connect Galvo lead, L, to point B and place the 720A dials to 0.0000000. Adjust the Model 721A Lo balance adjustment for a null on the Model 845AR. The Hi and Lo balance adjustments are continued with Galvo lead at point A (Hi balance) and at point B (Lo balance) until both Hi and Lo balance nulls are obtained. The system is now standardized. Resistor "X" is substituted for resistor "S" and the 720A is adjusted for a null on the Model 845AR. The value of resistor X is read directly from the Model 720A dials.

750A AND 720A AS A STANDARD CELL COMPARATOR

In most measurement laboratories one group of standard cells is used for maintaining the volt. These cells are usually saturated standard cells kept in a temperature regulated bath. A good method to maintain the volt is to assume that the mean (average) emf of all cells stays constant with time. The mean is known and results by transfers made to NBS. The emf of individual cells is assigned by determining the deviation of each cell from the mean. A little thought will show that the sum of deviations from the mean will be zero. The measurement problem is therefore determining how cells "compare" to each other.

Comparing standard cells give rise to several problems. As was mentioned before, as little as possible current should pass through the cells (preferably zero current). To make the measurements useful, the comparison of each cell should be made at least with a resolution of 0.5 μ V. Resolving 1/2 μ V requires shielding for noise and accounting for thermal voltages.

Figure 77 shows a way to use the 7105A system to compare standard cells. One cell is chosen to be the reference cell and for convenience, this cell can be the cell with the lowest emf. To save arithmetic time the Model 720A output is set to the nearest hundred μ V from the reference cell. For example, if the reference cell is approximately 1.0181320 volts place the 720A dials to 1.0181000. Be sure the 335A dials are placed to 1.1 volt on the 10 volt range. The reference cell is now placed in the circuit of the 720A and the 335A dials are adjusted for a null on the 845AR detector. If an exact null can not be obtained on the 845AR because of resolution of the 335A, note the deflection which is closest to null. This will now be the null point. Care should always be exercised not to pass excessive current through the standard cells. Now the unsaturated cell is connected in the 750A output circuit and the 750A standard cell dials

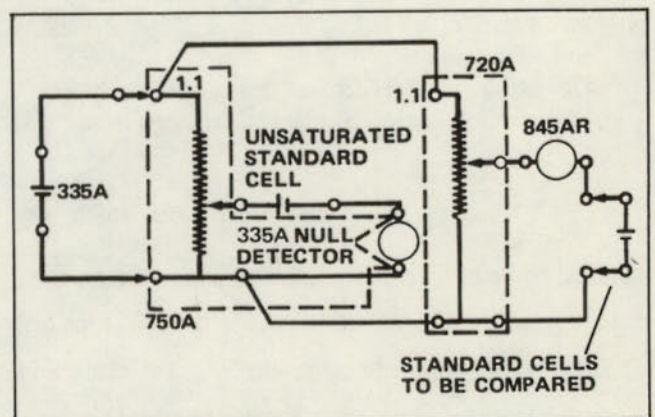

Figure 77.

are adjusted for a null on the 335A null detector. This null will be maintained throughout the cell comparison. Thus assures that the output of the 335A is constant during the cell comparison. With the 335A output held constant each of the remaining cells are substituted in the 720A output circuit and the 720A dials are adjusted to the 845AR null point. The difference of each cell from the reference cell, in μV , can be read directly from the 720A dials. Call each of the differences Δ_n . For example, the difference of the 3rd cell placed in the 720A output circuit would be recorded as Δ_3 . To eliminate the effect of thermal voltages, the output polarity of the 335A is reversed. Of course, the polarity of each cell will have to be reversed. The same procedure described above will be repeated. Call each difference between the reference cell in μV $\Delta_{\frac{1}{n}}$.

COMPUTING THE EMF OF EACH CELL

Let the emf, at the bath temperature, of the nth cell be X_n .

$$\text{Then: } X_1 - X_1 = \Delta_1 + \Delta_1 \div 2 = A_1 = 0$$

$$X_2 - X_1 = \Delta_2 + \Delta_2 \div 2 = A_2$$

$$X_3 - X_1 = \Delta_3 + \Delta_3 \div 2 = A_3$$

$$X_n - X_1 = \Delta_n + \Delta_n \div 2 = A_n$$

Adding all X and A columns

$$\sum_1^n X_n - nX_1 = \sum_1^n A_n$$

Dividing both sides by n

$$\frac{1}{n} \sum_1^n X_n - X_1 = \frac{1}{n} \sum_1^n A_n$$

$$M - X_1 = \frac{1}{n} \sum_1^n A_n$$

$$D_1 = \frac{1}{n} \sum_1^n A_n$$

M: Mean emf of all cells

X_1 : emf of reference cell

D_1 : Deviation of reference cell from mean emf

A_n : Measured deviation of nth cell from reference cell

Now $\frac{1}{n} \sum_1^n X_n$ is the mean emf of all cells which was assumed to be known and remain constant. Let $\frac{1}{n} \sum_1^n X_n = M$. Consequently, the deviation of the reference cell (D_1) is $\frac{1}{n} \sum_1^n A_n$. Now the deviation from the mean emf of any cell can be computed by the relationship:

$$D_n = D_1 - A_n$$

A good check on arithmetic is to add all D's. They should add to zero. Finally, before using any cell for calibrations, the cell emf is computed by subtracting the deviation from the mean and correcting the cells' emf for temperature.

The above calculations are cumbersome for more than four cells. However, a computer program can be written to perform the calculations.

CALIBRATING THE 7105A SYSTEM

The 7105A system is easy to calibrate. Except for calibrating the Model 335A, the total calibration can be performed within an hour. The Model 335A can be calibrated in about 1/2 hour if another source is available, otherwise the 335A calibration may take up to an hour. Since absolute accuracy is obtained from a reference cell (usually a saturated standard) or a Fluke Model 731A, the main calibration problem is to assure the Model 720A and 750A have minimum ratio errors.

CALIBRATING THE MODEL 720A, KELVIN-VARLEY DIVIDER

Recall that two conditions need be satisfied to calibrate a Kelvin-Varley Divider. Namely:

1. The resistors of each decade should be equal.
2. The total resistance of a decade in parallel with its shunt resistor should be twice the step resistance of the preceding decade.

Calibrating a Model 720A satisfies these conditions. The A and B decades and decade shunts can be easily calibrated by the procedure given in the manual for the Model 720A.

The manual for the 720A calls for the use of a 4007.6 ohm resistor to calibrate decade C and decade D shunt resistor. A procedure for calibrating decade C, which is an accurate and does not require the use of the 4007.6 ohm resistor, is given below:

1. Connect the 335A and the Model 845AR to the appropriate 720A terminals. Set the 335A dials to 10 volts.
2. Place the 720A dials to:
 - a. Internal function switch — Cal C
 - b. External function switch — operate
 - c. Bridge balance — mid position
 - d. R1130 (decade C) — mid position
 - e. Decade B — blank position
 - f. Decade C — zero
3. Adjust the bridge balance resistor (R205) for a null.

4. Place decade C to 1.
5. Adjust decade C resistor R1127 for a null.
6. With decade C switch placed on 2, 3, 4, etc. through cal position successively adjust R1125, R1121, R1118, etc. through R1100. Now all resistors of decade C are equal.
7. Place the internal function switch to cal S_3 and C decade switch to zero.
8. Adjust R1133 for null. Now both conditions for decade calibration are fulfilled.

CALIBRATION OF THE MODEL 750A

High Voltage Divider

The Model 720A, Kelvin-Varley Divider and Model 721A, lead balance adjust, are used to calibrate the Model 750A. The same procedure explained earlier to calibrate a voltage divider is used to calibrate the Model 720A. Because each of the ratios of the Model 750A are adjustable, there is no need to calculate a table of errors for each output tape.

CALIBRATION OF THE MODEL 335A

If another stable source capable of delivering 1000V is available, the Model 335A can be calibrated easily using the procedure explained previously. If another source is not available, another technique must be employed. This technique will also illustrate the effect of lead wire errors and how their effect can be reduced.

Look at Figure 78. Here is a simplified sketch of a way of calibrating a Model 335A. Notice that since the Model 335A is delivering current to the Model 750A, the lead wires ($L_1 + L_1'$) will cause errors. The magnitude of the errors can be found by finding the ratio of the lead wire resistance to the input resistance of the Model 750A. Normally, the lead wire resistance is about 100 milliohms. The input resistance to the Model 750A is 1000 ohm per volt.

Using the numbers above the lead wires will cause the following errors:

Range of 335A (Volts)	Lead Wire Error (ppm)
1000	0.1
100	1.0
10	10.0

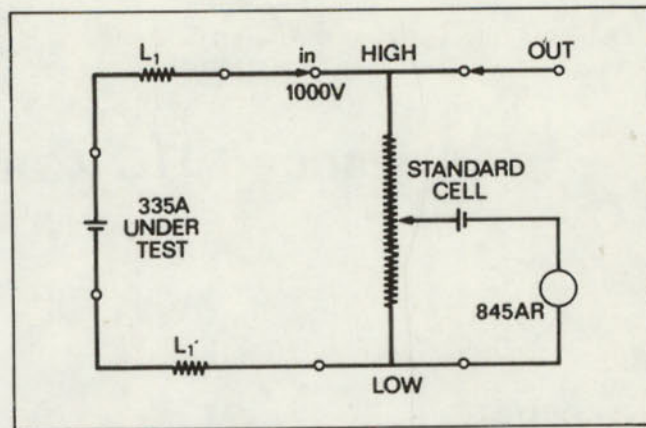

Figure 78. Two terminal calibration

NOTE

The error on the 10 volt range is significant.

A way of reducing this error on the 10 volt range is shown in Figure 79.

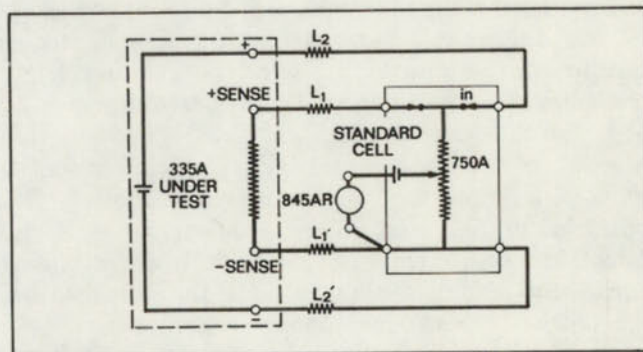

Figure 79. Four terminal calibration.

The Model 335A is represented by a 10V source and a series of resistors called the B string. The Model 335A functions to keep the current through the B string constant. Thus, the output voltage is directly related to the B string resistance. With 10V outputted at the Model 335A the B string resistance is 1 M Ω and the B string current is 0.01 mA. Now, notice 100 m Ω lead wires, $L_1 + L_1'$, are in series with 1 M Ω and the error is $10^{-1}/10^6 = 0.1$ ppm. Thus, the effect lead wires is reduced by a factor of 100.

A general rule to follow when calibrating a 335A, or any similar source, by the technique of Figure 78 and 79 is: Use four terminal calibration when the B string current is less than the Model 750A current. Use two terminal calibration when the B string current is equal or greater than the Model 750A current.

Advanced DC Calibration Techniques

INTRODUCTION

Over the last ten years we have seen a tremendous advance in the field of electrical and electronic measurements technology. Industries like those which are involved in missile and satellite programs, inertial navigation systems and computer design have asked — and are still asking — for better, faster and traceable measurements equipment, particularly for DC instrumentation. One of the answers of manufacturers of electronic test equipment was the presentation of digital — and differential voltmeters. Introduction of these instruments was probably the biggest advance in voltage measurements. The differential voltmeter for instance, is a portable, highly accurate voltmeter based on the principle of the standards laboratory potentiometer, it provides a means of obtaining laboratory accuracy (25 ppm) in the field and on the production line. Thus traceable measurements can be made where it is not convenient or not possible to bring the source to be measured to the standards laboratory.

As a result of this, there has been a big increase in the need for very accurate relatively easy calibrations and certifications. On the other hand, because of this increasing workload, national standardization laboratories prefer not to perform routine calibrations; but they carry out certifications concerning fundamental units exclusively. Hence the in-plant standards laboratory has become a necessity, so this has brought us to the situation that calibrations are now necessary on a level that previously only could be done in primary standards laboratories. Due to this the in-plant standards lab should be as self-supporting as possible, in other words self-calibration techniques for standardization should be used. Because of an ever increasing volume of work and the high labor-rate for these laboratories it is necessary to get the required accuracies in a minimum of time.

We, at John Fluke Mfg. Co., believe we have found the solution for these objectives with our new DC calibrations systems.

PHILOSOPHY OF SYSTEMS

The DC-standards laboratories depend primarily on two basic standards, the standard resistor and the standard cell. These two standards require reference to the fundamental units of voltage and resistance as maintained by National or International Laboratories. If this is done at regular intervals traceability has been achieved, which means that the fundamental unit has been transported to the user's facility. When the fundamental unit is available in the standards lab, it becomes necessary to multiply this unit to some other or higher levels by means of the so called voltage and resistance ratio measurements.

Consequently, it is required for a DC calibration system that traceability can be achieved for all necessary levels and with sufficient accuracy, in other words the error contribution of multiplying should be kept as low as possible.

Voltage ratios are usually obtained by a resistive divider. Resistive divider ratios may be established to an high accuracy without knowing the ohmic value of the resistors. It is not necessary to have traceability of ratio measurements to any national standardization laboratory because ratios are dimensionless quantities. Anybody can calibrate a divider, assuming he does this job in a well equipped laboratory. What has to be done is to compare a fraction of the voltage in a divider to another one and to determine the difference; this can be performed without absolute resistance standards. It may seem necessary to trace this ratio measurements to a divider which has been calibrated by some other laboratory having adequate comparison equipment. In getting the best results; however, it is recommendable to perform the ratio calibration locally. An "in-house" performed calibration at the same ambient temperature is more reliable than a certified value also because there is no transportation error at all.

Operations of Ohms and Kirchoffs Laws convert resistive ratios to voltage ratios, when ratio calibrated resistors are electrically connected as voltage dividers. Accordingly we come to the conclusion that voltage

ratios can be established with high accuracy independent of a national standardization lab; furthermore, when the voltage output of a ratio calibrated resistive divider is equal to a certified emf of a standard cell (by means of an one to one ratio), it is very well possible to calibrate the voltage divider in terms of the legal unit of voltage with an accuracy or uncertainty that depends mainly on the ratio accuracy obtained.

SYSTEM REQUIREMENTS

Based on what has been said so far we are able to determine some essential requirements for a DC voltage measuring and generating calibration system;

1. A *resistive* ratio device and a means to establish a ratio resolution and "accuracy" of at least 0.1 ppm.
2. A *voltage* ratio device the output of which is directly traceable to the legal unit of emf.

There are a number of possibilities to make up a DC calibration system using ratio devices. Equipment choice must be made on the basis of cost versus performance, existing instruments and last but not least the system accuracy requirements. Because nowadays, as already mentioned, differential and digital voltmeters with specified accuracies of 50 and 25 ppm are commonly used in production and quality control areas, our calibration system must have an *accuracy of at least ± 10 ppm* with respect to the unit of emf as maintained at the user's facility.

It furthermore is usual practice to use corrections tables or graphs to get the maximum accuracy with the ratio divider. This always is a time consuming business with the additional drawback that there is always a real change in making mistakes while working with these correction figures. To avoid these disadvantages our engineers set before themselves the objective to develop the system in such a way that without degrading above requirements it *should not be necessary to use corrections or graphs* during the self calibration and the use.

Indeed, not an easy job. But they did it!

	7101B	7104A	7105A
Voltage Source	332B	335A	335A
Null Detector	845AR	335A	845AR 335A
Voltage Divider	750A	750A	750A
Kelvin-Varley	720A	720A	720A
Lead Compensator	721A	721A	721A

Figure 80.

The new Fluke DC Calibration System now available meet all postulated requirements. It is a complete and fast self-calibrating system; to obtain the stated specifications, no correction tables and the like are needed. The overall system accuracy depends primarily on the accuracy of adjustment of the Voltage Reference Divider and on the uncertainty of the standard cell value. Figure 80 shows different configurations of our system, the photograph shows one possibility. We shall restrict ourselves to one model which consists of:

1. A Reference Divider, Model 750A, with an accuracy of at least 10 ppm.
2. A Kelvin-Varley Divider, Model 720A, with a linearity of 0.1 ppm.
3. A Lead Compensator, Model 721A, to use in conjunction with the 720A.
4. A Null Detector, Model 845AR, with a sensitivity of 1 μ V end scale.
5. A Voltage Calibrator, Model 332B, a 20 ppm, highly stable, DC generator.

The Kelvin-Varley Divider is used as the *primary calibration tool* for the entire system, so let us discuss this basic device and have a quick look what's behind the front panel.

KELVIN-VARLEY DIVIDER, MODEL 720A

Although the names, intended use and design of resistive ratio devices vary widely (Potentiometers, Volt Boxes, Direct Reading Ratio Sets, Universal Ratio Sets and Kelvin-Varley Dividers), they all are ratio sets, establishing a unitless quantity requiring no traceability. Potentiometers, Volt Boxes and Direct Reading Ratio Sets all have rather limited uses as compared to the Universal Ratio Set and the Kelvin-Varley Divider.

The Universal Ratio Set and Kelvin-Varley Divider are probably the most widely used standards laboratory instruments. In resistance measurement the choice of whether to use a Universal Ratio Set or a Kelvin-Varley Divider formerly was governed by the attainable galvanometer sensitivity, the Kelvin-Varley Divider being more responsive at higher resistances and the URS at lower, but with the advent of high impedance, high sensitivity null detectors, the K-V Divider now has the advantage over the URS in that it can cover a greater resistance measurements range. The K-V Divider has other distinct advantages over the URS; it has higher input resistance for higher voltage capability.

Maximum input voltage for a URS is typically 25 volts to 50 volts.

Maximum input voltage for a K-V Divider is typically from 300V to 700V (the 720A is rated at 1100 volts), therefore it is superior in the measurement of voltages and the certification of other voltage dividers. Finally, the Universal Ratio Set is more complex to build, therefore more expensive. We are all familiar with the Kelvin-Varley Divider, I am sure, but let's take a few minutes to review the theory behind this device.

A Kelvin-Varley Divider consists of several decades of resistors interconnected as shown in Figure 81. Normally the first decade is composed of 11 equal resistors of a value R, however to get an overranging capability of 10% as in the Model 720A the first deck is built up with 12 resistors of 10k.

At any given setting of the first decade switch, two of these resistors are shunted by a second decade element of resistors with an input resistance equal to the value of the two resistors shunted. So the current is divided equally and the voltage drop across the two resistors, shunted, is equal to the voltage across the unshunted couple; i.e., the "end-to-end" resistance of the decade will be that of 11 resistors, rather than 12. Two definite advantages are immediately evident, the input resistance measured from the input to the common terminal, with the output terminals disconnected or unloaded, is constant and the effect of contact resistance in the switch points is somewhat reduced because of the division of current.

The second, third and higher decades are also K-V elements, covering the range of one step of the preceding decade in steps of one tenth up to nine tenth. The last decade consists of ten equal resistors and may be set to values of zero through ten. It is only by use of this eleventh setting (dial reads 10) of the last dial that the divider can be set to full scale. Since it is desirable to use in the following decades, resistors which make the total resistance higher than two resistors of the preceding deck, a shunt resistor has been connected across the second through last decade to reduce the combined value to that of the two shunted resistors. So this gives Figure 81 as the basic schematic of our Kelvin-Varley Divider, Model 720A with the big difference being, in comparison with other dividers, that all resistors in the first three decades are adjustable.

There are, however, a few problems inherent with the Kelvin-Varley Divider not the least of these is the problem of uneven temperature distribution. Figure 82 shows the effect of full power on a two decade divider.

The chart on the left shows the resistance values and the uneven distribution of current. The chart on the right shows the temperature distribution among the resistors.

By taking the temperature rise of the individual resistors of the first decade as $\Delta t/4$.

The individual resistors of the second decade reach a value of $\Delta t/20$ except for the two that are bridged which

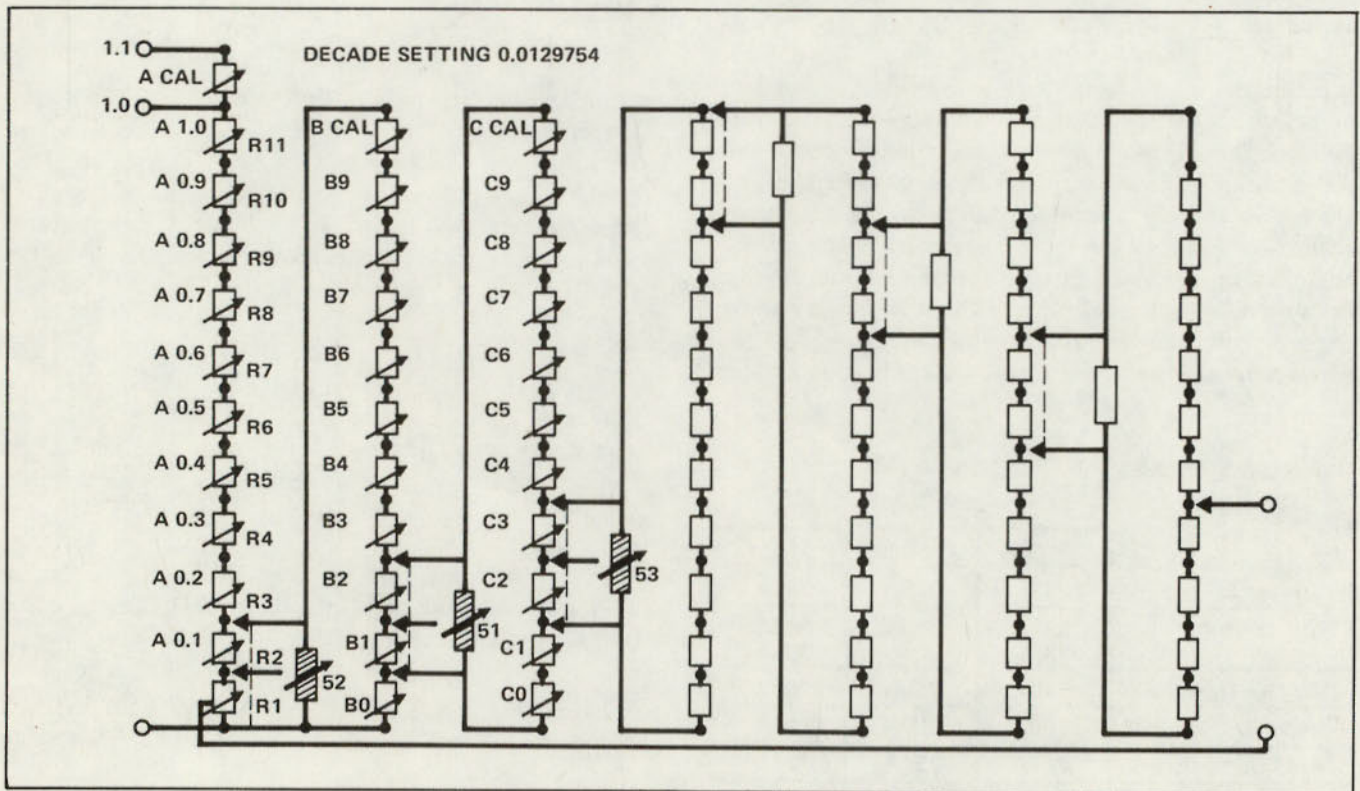

Figure 81. Schematic of a Kelvin-Varley Divider

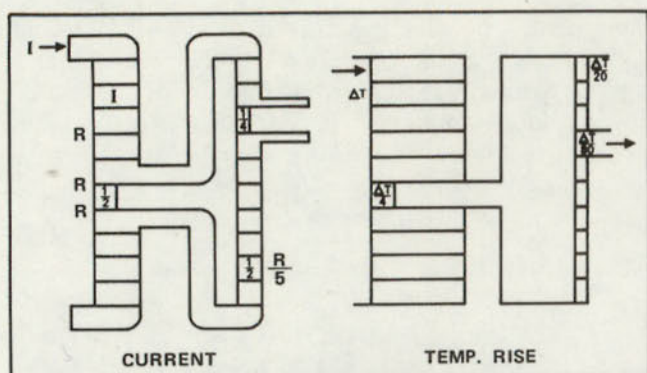

Figure 82.

only reach a temperature of $\Delta t/80$. The temperature rise of the third and later decades is so small it can be ignored. But on the first decade the difference in temperature rise between the bridged resistors and the rest of the resistors is significant. This means that it is not enough to match the resistors just with respect to temperature coefficients (T.C). If the divider is to be run at high power levels, the resistors must have a T.C. very close to zero. If we were worried just about ambient temperature, T.C. — matching would be sufficient.

Each resistor in the first decade actually consists of four — “close to zero” — temperature coefficient matched resistors in series, thereby reducing the effect of non-uniform temperature rise with an increase in voltage and at the same time decreasing total voltage coefficient. Immersing the resistors of the first deck in oil helps to reduce these effects of self-heating and environmental variations.

This design and a special selection of highly stable Fluke resistors in all decades gives us some remarkable specifications, like a power coefficient of linearity of better than 0.2 ppm/Watt coupled with an input power of 1 WATT/step on the first decade, a temperature coefficient of linearity of better than 0.1 ppm/°C and a stability of linearity of 1 ppm per year without recalibration.

One of the most important characteristics of a resistive divider such as the Kelvin-Varley Divider is linearity.

This is actually another word for uniformity. If the steps in a decade of ten resistors are completely uniform than the linearity error is zero.

The Model 720A has an absolute linearity of ± 0.1 ppm of input. To understand the meaning of this specification we need to know what linearity deviation is. *Linearity deviation* indicates how close the output voltage comes to the nominal or dialed value in ppm of the input voltage. But which input voltage? Is it the voltage across the input terminals or the voltage which

exists between the maximum and minimum ratio settings? Consequently there are two linearities to be discerned:

1. Terminal linearity; this deals with the voltage across the input terminals. *Terminal linearity is the maximum value of the Terminal Linearity Deviation:*

$$\Gamma_t = \frac{U_a + U_o}{U_t} - R \quad (1)$$

For the meaning of the applied symbols see Figure 83 (U_t -voltage between the input terminals).

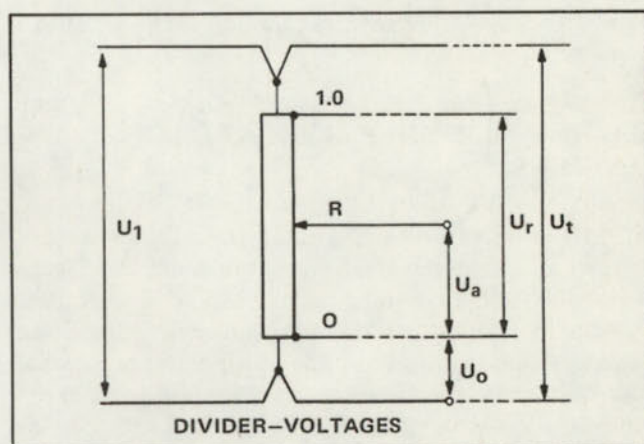

Figure 83.

2. Absolute linearity this linearity is relative to the voltage put between the maximum and minimum settings of the divider and is to be found as *the maximum of the Absolute Linearity Deviation:*

$$\Gamma_a = \frac{U_a}{U_r} - R \quad (2)$$

Absolute linearity, in contrast with terminal linearity, is independent of external connections, end errors, etc. Variations with regard to lead lengths and connections, when using a thus calibrated divider, will not affect the defined values of the absolute linearity deviation.

Suppose we have a divider string of ten nominal equal resistors. The absolute linearity deviation can be found by mutually comparing the resistors in the string, in other words to measure the resistance deviations of nine with respect to one, according to:

$$R_n = R_s (1 + d_n) \quad (3)$$

Formula (2) can easily be converted in terms of the resistance deviation d_n ;

$$\Gamma_a = 0.1 \sum_{n=1}^{10} (d_n - \bar{d}_{10}) \quad (4)$$

Where:

- n = number of resistors to tappoint,
- d_n = resistor deviation of the nth resistor,
- \bar{d}_{10} = average deviation of ten resistors,
- R = nominal ratio-setting.

Since the value of resistance does not show up in the ratio, the ratio and its corrections are absolute and independent of physical quantities.

We will use formula (4) for our discussion how to calibrate Kelvin-Varley Dividers in general and in particular the self-calibrating feature of our 720A which makes it unique and provides the state of the art at this moment.

CALIBRATION OF KELVIN-VARLEY DIVIDERS

At first it might seem desirable to calibrate a K-V Divider at each possible setting. If the divider had seven decades with 10% overranging, as does the Model 720A, this would amount to 1.21×10^7 calibration points. Not exactly a quick calibration! There just has to be another way, and there is. A complete calibration of linearity deviation may be given a Kelvin-Varley Divider by comparing it precisely with a ten-step calibrated resistor string (standard divider).

As already mentioned the technique is to intercompare each resistor in the standard divider. The resulting deviations from the "standard" are recorded and used in expression (4); this means that we have to calculate the average deviation, next to subtract this average from each deviation to get the difference from average. Finally we must sum n differences and multiply this sum by 0.1 to get the linearity deviation of the nth step.

These figures are now used as corrections to calibrate the Kelvin-Varley Divider. This calibration involves connection of the calibrated resistor string across the Kelvin-Varley Divider dial resistors under test in a Wheatstone Bridge configuration with means available for adjustment of leads and end errors, such as the 721A Lead Compensator, so that the divider reads correctly at zero and maximum. Comparison is made of each step of the decade under test to the standard divider. The calibration is repeated for each decade.

Observations are recorded for each of the two methods of obtaining a given ratio — for example, 0.49999910 and 0.5000000. If at the setting 0.5000000, the corrected ratio of the standard divider is 0.5000002 and our K-V Divider nulls at 0.5000001, the linearity deviation at setting is +0.1 ppm and the correction is +0.1 ppm. The correction at a setting of 0.4500000 is the linear

interpolation between the corrections at 0.4000000 and 0.49999910 plus the correction for the second dial 5 setting. Normally the linearity deviations of one decade are graphically presented in a manner like the given example in Figure 84. Such linearity deviations graphs are made for each decade and are used to find and to combine the contributions of each decade.

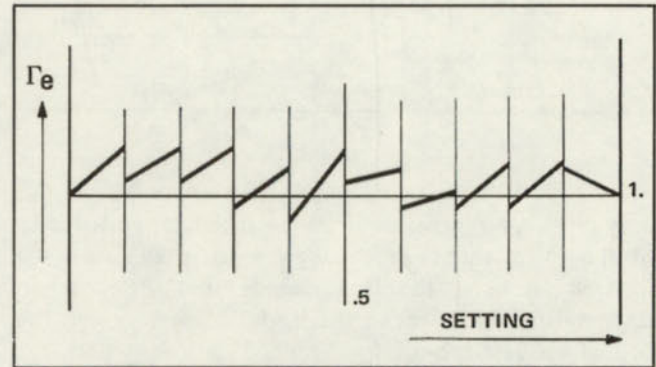

Figure 84.

This method of calibrating a Kelvin-Varley Divider requires 20 to 22 measurements per decade, or over 140 measurements for a seven decade divider, which means at least one day's workload. Another day, needed to make the necessary calculations, graphs and correction tables, makes this method a time consuming operation, while we will forget the time involved with the calibration of the standard divider. And what about the chance of making mistakes?

This certainly beats checking every possible setting, but it still leaves something to be desired. In order to use the so calibrated divider to its fullest accuracy capability, the linearity deviation or correction must still be read and calculated from the calibration date each time that a measurement with this K-V Divider is made.

Besides that, let's not forget the restrictions of such calibration data. An important drawback, many times overlooked, is that a graph as presented in Figure 6 is only valid for *one* temperature, namely the calibration temperature.

The corrections to be applied will change with various ambient temperatures. When in use the ambient temperature differs from the one of calibration, you may not be able to use the graph. With a temperature coefficient of linearity of ± 0.3 ppm/ $^{\circ}$ C for instance, it does not make sense to compose such graph or correction table for corrections better than 1 ppm, supposing the divider is used in an airconditioned laboratory with a temperature regulation of $\pm 1^{\circ}$ C. In other words, the T.C. of linearity restricts the use of corrections or graphs in getting a linearity better than specified.

The 720A incorporates an internal Wheatstone Bridge and adjustable ratio resistors to make this K-V Dividers a *completely independent* ratio standard *without* the need for correction curves and *without* any restriction with respect to ambient temperatures when an absolute linearity of ± 0.1 ppm is needed.

SELF-CALIBRATION OF THE 720A

With the introduction of a self-calibrating Kelvin-Varley Divider Fluke shows us new simplicities for standardization.

Through the special selection of resistors, only the first two decades require individually adjustable resistors; however, the third decade was made adjustable for those cases where extremely good linearity is needed. Adjustments for the third decade and fourth decade shunts are inside the case; the self-calibration of the first two decades is performed from front panel controls and accomplished with a total of 24 adjustments requiring only a null detector and a power supply as auxiliary equipment. Shunt resistance of the second and third decades is also adjustable from the front panel.

The procedure is as follows: with 20 volts applied to bridge, the bridge balance and "A" decade adjustments may be nulled to better ± 0.5 microvolt as read on the null detector, this will insure sufficient resolution to obtain a linearity of better than 0.1 ppm.

First, R_1 is inserted in the bridge as shown in Figure 85 and R_3 is adjusted for a null on the galvo. Next R_1 is removed, the setting of R_3 is not disturbed. R_n is inserted and adjusted for a null. Using this procedure R_n is made to equal $R_1 \pm$ ppm. Eleven resistors are inserted and adjusted when calibrating the "A" deck; they all agree to

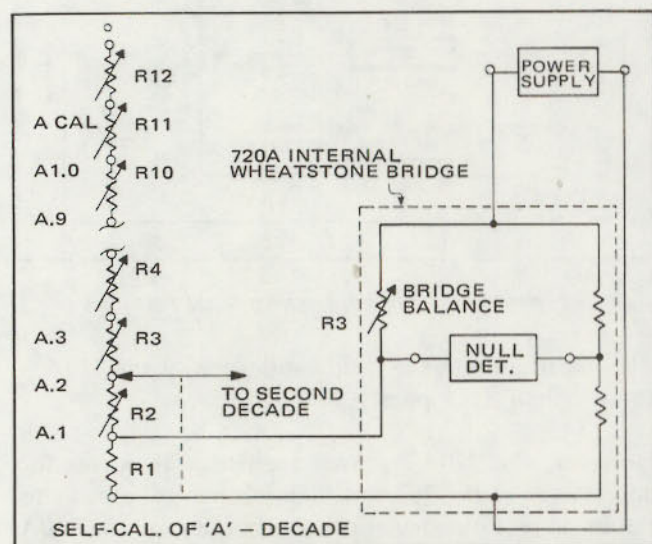

Figure 85.

within 0.1 ppm (may be adjusted to within 0.05 ppm) of each other and R_1 after they have been calibrated.

Each "B" deck resistor is calibrated in the same manner, after which the equivalent resistance of the successive decades is placed in parallel with two series connected "B" deck resistors and is made equal to one resistor of the "B" deck by means of the adjustable shunts. In an identical manner the total equivalent resistance of the "B" deck plus the successive decks is matched to the "A" deck. With reference to formula (4) the Model 720A is thus calibrated so that its linearity is an absolute linearity of ± 0.1 ppm of input with ratio settings from 0.1 to 1.1.

With this self-calibration technique, the 720A can easily be specified — and maintained during its whole life — at this 0.1 ppm *without* corrections and *independent* of ambient temperatures. In other words: *this self-calibration features removes linearity deviations caused by time and temperature.* To obtain this result only about one hour is needed. Quite a difference with the normally required days to calibrate a "fixed" Kelvin-Varley Divider. After the self-calibration has been performed and with the addition of a Model 721A Lead Compensator, a complete self-sustaining system for calibration of other ratio devices like potentiometers, bridge elements and voltage dividers, such as the Model 750A, has been obtained.

REFERENCE VOLTAGE DIVIDER, MODEL 750A

The 750A is the voltage ratio device of our system. Let us have a quick look at the schematic which is represented in Figure 86.

It provides a means of accurately comparing specific voltages from 0.1 volt to 1100 volts to the known potential of a standard cell. It may be used as a standardizing link in a DC calibration system or it may be used for direct comparison of power supply output and standard cell voltage. The use of switches for the election of input and output voltage taps makes the Model 750A fast and convenient to use.

The total effective resistance of the main divider string is 1.1 M Ω . The input resistance is 1000 Ω per volt of rated input up to 1100V resulting in a nominal current of 1 mA. The input voltage may be adjusted by rheostats located on the front panel. The span of adjustment of 10 millivolts and resolution of better than 1 mV permit the operator to achieve an exact null. An adjustment in each step of the main divider string is used to compensate for drift.

The "standard cell voltage" shunt controls the lower end of the main divider string from common to the 1.1V tap.

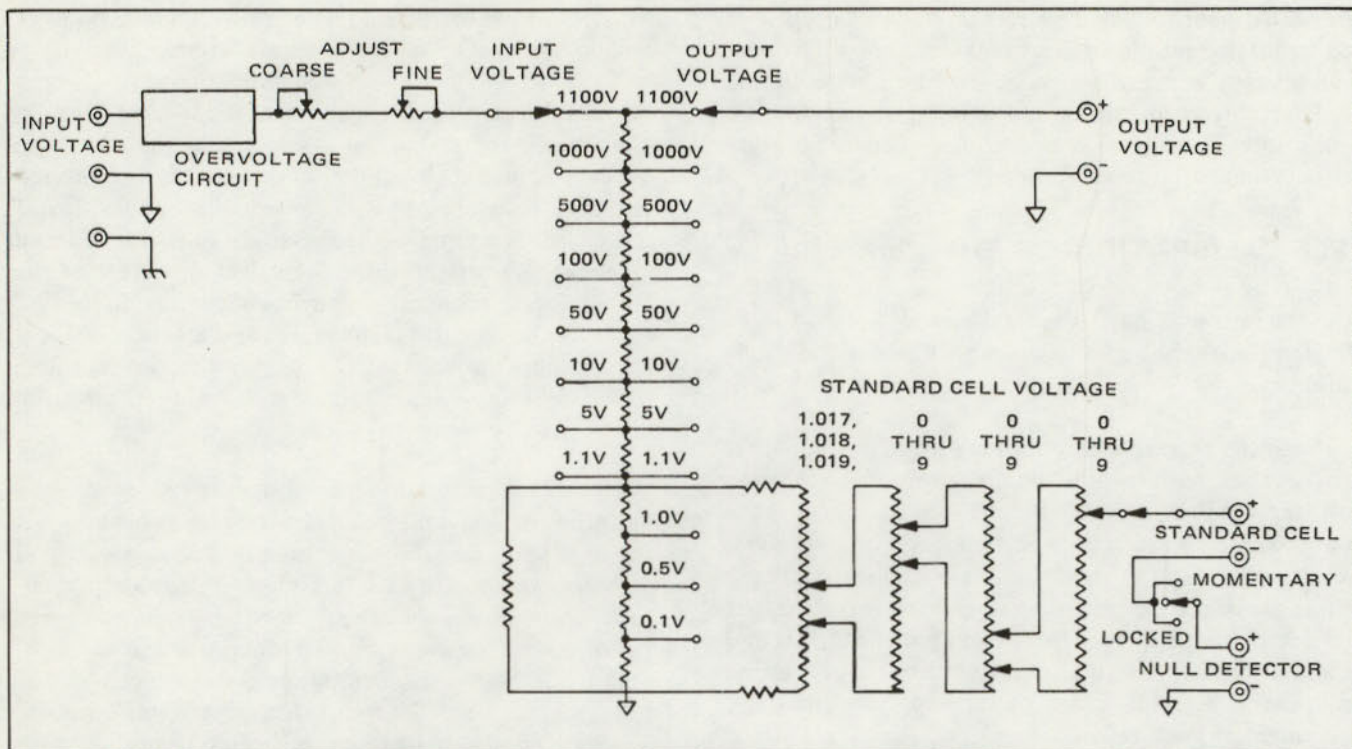

Figure 86. Simplified Schematic Diagram — model 750A.

These controls form a modified Kelvin-Varley circuit spanning the range from 1.017000V to 1.019999V. They are used by the operator to obtain from the divider a voltage which will exactly equal the standard cell voltage when the input is at nominal value. This voltage is compared to the output of the standard cell by a null detector and the input to the divider is adjusted to obtain a null. The overvoltage circuit (overvoltage trip) removes the input voltage from the divider when it exceeds approximately 1.4 times the setting of the input voltage switch.

CALIBRATION AND TRACEABILITY OF THE 750A

As previously mentioned, traceability of the DC calibration system depends mainly on the standard cell voltage and the ratio accuracy of the Model 750A. Thus the voltage ratios must be checked at regular intervals. This begins the case it was decided that the ratios could be adjusted for minimum error. Therefore, the 750A has calibration adjustment for all ranges above 1.1V, consequently, these adjustments eliminate the need for correction curves and the like where the ratio error required is better than 10 ppm.

An example of this type of requirement is the calibration of our 25 ppm differential voltmeter, Model 885A, where a 15 ppm overall uncertainty in the cal system would be a sizeable portion of the advertised

specification. It is essential here to reduce the overall system uncertainty to a minimum by adjusting the 750A ratios to better than 6 ppm. The block diagram in Figure 87 illustrates the calibration of the 750A, by means of the Standard Kelvin-Varley Divider, together with the 721A Lead Compensator.

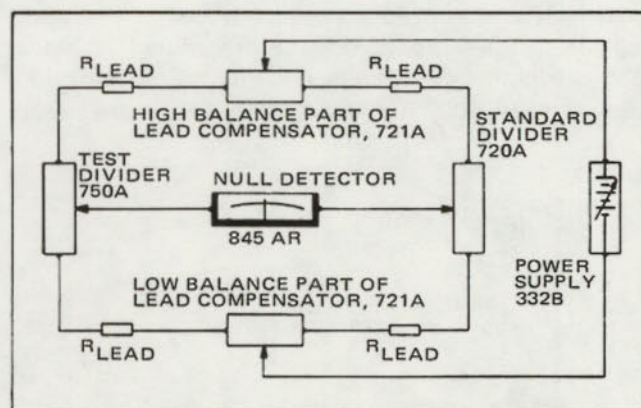

Figure 87. Voltage Divider Calibration.

The uncertainty in the ratio calibration of the 720A is smaller than ± 0.1 ppm.

However, the 720A's power coefficient increases the uncertainty of the 750A at higher input voltages. This results in a ratio deviation or accuracy of the 750A which ranges from 7 ppm at 1100 volts to 4 ppm at the one volt tap at the time of calibration.

Normally standard cells are not supplied with the cal system. Therefore, the uncertainty of the cells is not included in the specified accuracy of the systems. However, the overall accuracy of a cal system will be no better than the accuracy of the applied standard cell.

The National Bureau of Standards for instance, will certify the emf of a cell to an uncertainty of no more than ± 1 ppm at the time of certification in the NBS laboratory. When it arrives at the user's facility the uncertainty of the cell is greater than ± 1 ppm (transportation errors) and becomes progressively worse with the passage of time. The user with a large number of cells in enclosures with different controlled internal temperatures reduces his uncertainty, with respect to the legal unit, to 2 ppm if he maintains the enclosures in a controlled external environment and properly monitors and evaluates the cell emf changes. A user with one bank of three or four cells mounted in one temperature controlled enclosure probably has uncertainty in his "volt" of 4 to 6 ppm with respect to the legal unit as maintained by national standard laboratories.

When handled very carefully, saturated standard cells are very stable and no means are available to check the stability of a cell, except other saturated cells. Consequently, between certifications of the NBS or performed by some other Standardization Laboratory, the standards lab technician has to have means to compare the cells with each other than to detect a possible drift in one or more cells. In general there are two methods; one is based on the assumption that the certified average, calculated from the Certificate will remain constant between the certifications (statistical method), the other one makes use of plotting the certified and measured differences between the cells on a graph. The last method is advisable if you have to work with a group of three or four cells; the other method should be used when a large number of cells are to be monitored. To go into detail about cell drift and its measurements is beyond the scope of this lecture.

Finally, it is to be concluded that the previously mentioned uncertainty in cell values should be added to the uncertainty of the calibration system; thus the sum is the *overall system accuracy*.

DC CALIBRATION SYSTEM

Now that we have found the basic standards for our calibration system, we must select some "auxiliary" equipment like a power supply and a null detector. The Model 332B Voltage Calibrator was chosen as the voltage source because of its extremely good stability (10 ppm/month), low noise and ripple (less than $40 \mu\text{V}$ at maximum output) and a high resolution (0.1 ppm). In fact the Model 332B is a calibrator which will deliver

any desired voltage up to 1111 volts with an accuracy of 20 ppm/6 months. Overvoltage and overcurrent limits are provided to give protection in the event of component failure or operator errors.

The already mentioned 845AR was designed to provide us with a high sensitive Null Detector with a $1 \mu\text{V}$ full scale range, an overload capability of 1100 volts on any range with a typical recovery time of 4 seconds and a $10 \text{ M}\Omega$ input impedance. Coupled with this are the features of leakage resistance of $10^{12} \Omega$ and capabilities for being floated to 1100V above ground and used as an isolation amplifier.

Figure 88 shows us one application of the calibration system. The actual operation of this system is very simple. At first the standard cell voltage controls on the 750A are adjusted to match the particular standard cell in use. The desired input voltage is selected on the 750A and matched on the DC supply. Then the supply is energized and the standard cell switch closed. The input voltage is adjusted for a null in the standard circuit. Rheostats in series with the divider aid in reaching a null where the voltage source resolution is not better than 1 ppm. If current is required at a particular output voltage, then in general the input voltage should be the same level to prevent drawing current from the divider. Care must be taken to avoid errors due to excessive IR drop along output leads especially in the lower voltage ranges. In the majority of applications the current required will be small. If small amounts of current are required at intermediate output voltages one simply adjusts the input voltage to some slightly higher point for a new null on the null detector with the load applied at the desired output.

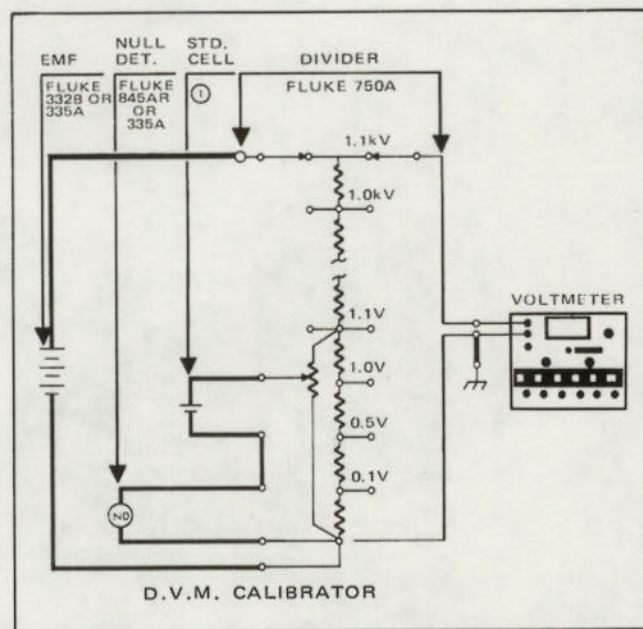

Figure 88.

This done, it can be shown that the voltage will be correct for the output voltage selected and every lower tap point on the divider.

Finally, we will summarize the *applications* of this system.

The 7105 system can be used as a:

1. Power Supply Calibrator; accuracy 5-7 ppm (accuracy standard cell not included).
2. Voltmeter Calibrator; accuracy 5-8 ppm.

3. Differential Voltmeter; accuracy 5-8 ppm (100V and below).
4. Ratio Calibrator; absolute linearity 0.1 ppm of input.
5. Power Standard Cell

Keep in mind that the 332B itself (or the 335A) may be used as a Voltage Calibrator if accuracies better than 20 ppm are *not* needed. By means of the 750A it can be calibrated to this accuracy, which is valid for a six-month period.

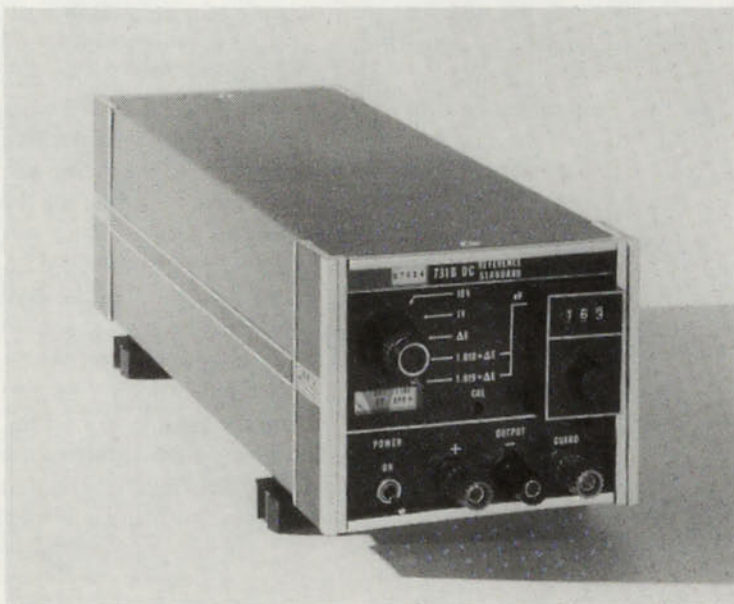

An instrument providing standard cell accuracy, but utilizing performance capabilities of solid state technology provides outputs of 10.0, 1.0, 1.018 + ΔE, 1.019 + ΔE and ΔE, being a variable output of 0-999 μV.

Figure 89. Fluke Model 731B D.C. Reference Standard.



A precision ac voltage source that can be used as a calibration standard or as a fixed frequency source for test applications.

Figure 90. Fluke Model 510A A.C. Reference Standard.

15

Thermal Transfer Standards

Thermal transfer standard provides a means for defining the rms value of a given AC voltage or current in terms of a DC voltage. This is the recognized method for defining the absolute rms magnitude of an AC voltage or current waveform and is considered traceable to NBS.

The effective or rms (root-mean-square) value of an AC voltage or current is that value which produces the same heating effect as an equivalent amount of DC voltage.

A thermal transfer standard, such as the Fluke Model 540B, may be used to determine the rms value of a subaudio to radio frequency AC voltage or current in terms of a DC voltage or current. This method utilizes a thermoelement device to indicate the rms value of an AC waveform without regard to the harmonic content or form of the wave.

A thermal voltage converter is a thermoelement of low current input rating with an associated series impedance,

such that the emf developed at the output terminals gives a measure of the rms voltage applied to the input terminals.

Thermocouple operation is dependent on the fact that the junction of two dissimilar metals produces an emf, the magnitude of which is dependent on the temperature of the junction. Figure 92 illustrates the electrical construction of the thermal converter used in the 540B.

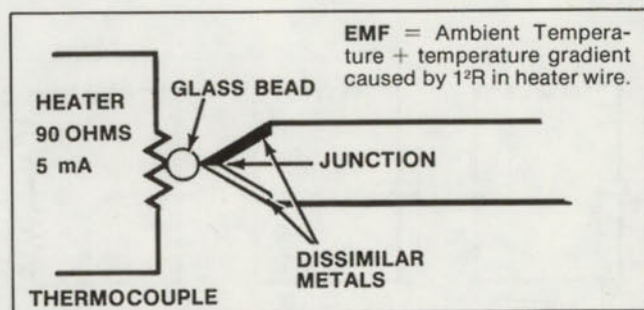

Figure 92.

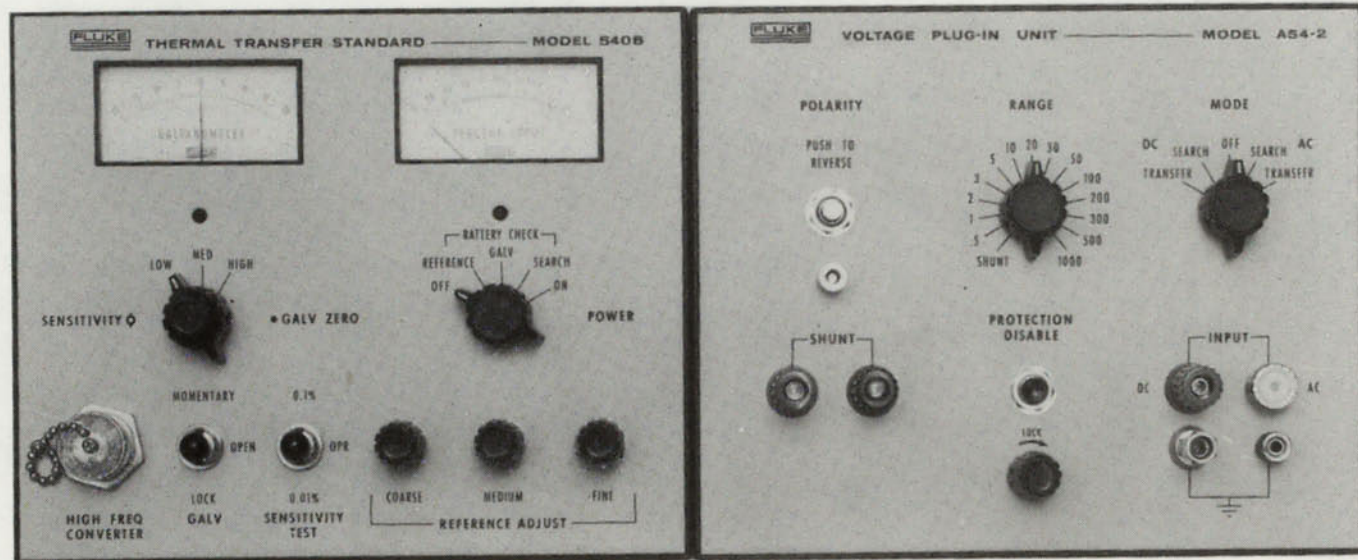

Figure 91. Model 540B Thermal Transfer Standard. A thermal transfer type instrument is needed for precise measurement and calibration of AC voltage and current, voltage capability should be 0.25V to 1000 VRMS AC, with a frequency range of 5 Hz to 1 MHz. Basic AC to DC transfer accuracy of $\pm 0.01\%$ without the use of calibration curves or corrected tables.

The current to be measured flows through the heater wire which is electrically insulated from the thermocouple junction by a glass bead. The glass bead is designed to be an excellent conductor of heat. The temperature of the thermocouple junction is proportional to the ambient temperature, plus the heat generated in the heater wire.

Since the output voltage of a thermal element is a function of heat generated in thermocouple it should produce the same heat for equal amounts of rms AC and DC voltage or current. This presupposes that the AC and DC impedance of the thermal element are equal.

From the equivalent circuits in Figure 93, it can be seen that as the measurement frequency increases the capacitance and inductance associated with elements of a thermal transfer device tend to have a greater effect on the equivalent impedances. By using compensation networks, it is possible to minimize the AC impedance change at higher frequencies. This enables us to specify the accuracy of a thermal transfer standard in terms of AC/DC difference.

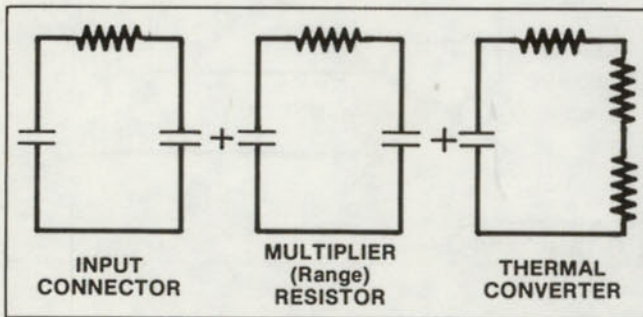

Figure 93.

PRINCIPLES OF OPERATION

Figure 94 illustrates principle parts of a thermal transfer standard.

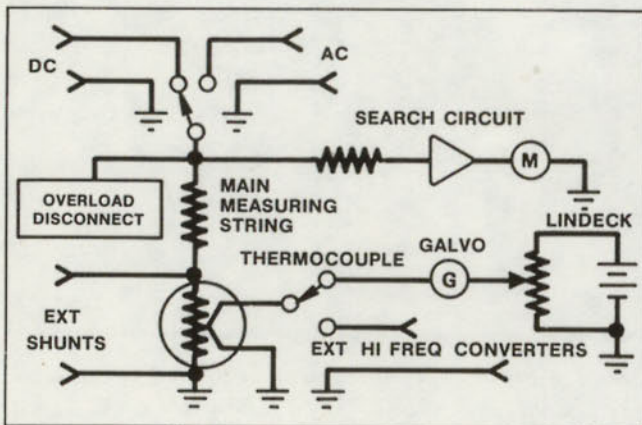

Figure 94.

Input Circuit

The use of a grounded input connector prevents the thermocouple from being floated at some high voltage above or below ground. This is necessary because the glass bead that isolates the heater in the thermocouple from the thermocouple junction has a voltage rating of 100V dc, therefore if one input connector was not grounded and the thermocouple was floated at voltages in excess of 100V breakdown would occur between heater and thermocouple junction.

Because the 540B is a transfer device and has AC and DC voltages applied to separate input connectors, special care has been taken to insure that the resistances of the lines from the input binding posts to the transfer switch are equal.

Because a constant AC/DC input impedance is a prime factor in a transfer measurement, the transfer switch in the 540B utilizes the gold bifurcated contacts to insure repeatability of contact resistance.

Search Circuit

A search circuit is provided to roughly determine the correct range prior to the transfer.

Main Measuring String

The accuracy of a transfer standard is dependent on keeping the AC and DC impedance equal. It is easily seen that the multiplier resistors and associated compensation networks in the main measuring string hold the key to equivalent AC and DC impedances. Each range has its own resistor and compensation network to facilitate compensation. This configuration allows an AC/DC difference specification of 0.01%.

The resistors in the main string consist primarily of metal film resistors (five wire wound resistors are used). Accuracy of the resistors is 1% with a temperature coefficient of <math><25 \text{ ppm}/^\circ\text{C}</math>. The division ratio accuracy is not of prime importance because the instrument is a transfer device.

Input resistance is $182\Omega/\text{V}$ and 5 mA of current flow at rated input voltage.

With input voltage levels of 500 and 1000V a 5 to 6 minute heat build-up stabilization time is required.

Thermocouple Circuit

The thermocouple used in the 540B is of a standard pattern with a 5 mA current rating and a 90Ω heater.

Output of the thermocouple is approximately 7 mV, at rated input. The couples are tested for a reversal error of less than 0.01%. Padding resistance is added to the heater to bring it to $90\Omega \pm 3\%$ and the couple is encapsulated to minimize drift due to temperature change. Thermocouples have temperature coefficients of approximately 0.1% which necessitates making the transfer within one minute following thermocouple stabilization.

The equivalent thermocouple circuit shown in Figure 2 indicates the shunt capacity and series inductance of the couple. This inductance and capacitance will change the impedance of the couple at higher frequencies. In order to compensate the thermocouple and maintain the same AC/DC impedance at higher frequencies, a 10Ω resistor is connected in series with the thermocouple and a compensation network is added to extend its AC/DC response.

Reversal error is the difference in output voltage from the converter with DC current flowing in one direction compared to the output voltage with current flowing in the opposite direction. The effect of reversal error on a measurement will be equal to the average of the readings with two polarities of DC current applied. For example, if the reversal error of a thermocouple in the 540B were 0.006%, then the error contributed to the measurement if reversal error was disregarded would be equal to $0.006\% \div 2$ or 0.003%.

Protection Circuit

The protection circuit utilizes diodes that are connected across the thermocouple to prevent instantaneous current surges from destroying the thermocouple. These diodes are series connected with one diode biased on to set the beginning of the conduction level at 0.9 volts. The diodes will withstand up to 100 amps at peak current for 50 mS. A trigger amplifier senses the overload condition and operates a reed switch to disconnect the input from both search and transfer circuits. Operating time is less than 1 mS.

Lindeck Circuit

The Lindeck circuit consists of a 1.34V mercury battery, series resistors in the form of a twenty position switch plus two high resolution potentiometers. The galvanometer input impedance is 18Ω . This closely matches the 10Ω output impedance of the thermocouple, thereby providing maximum galvanometer sensitivity.

Model A55 high frequency thermal converters may be used in conjunction with the Lindeck circuit via a connection jack.

OPERATION

Operation of the 540B is simple but it is necessary to be aware of basic measurement uncertainties that can negate the measurement accuracy.

Interference

The presence of external signals in the input circuit of the mount or unwanted signals linking the circuit of the converter.

Repeatability

The ability to repeat transfer measurements a number of times with the same indication on the transfer instrument. Differences are usually caused by changing impedances in the circuit when transferring from a DC signal to an AC signal, hysteresis in the indicating circuit, and so forth.

Reversal Error

The difference in output emf from the converter with DC current flowing in the heater in one direction compared to the output with current flowing in the opposite direction. Reversal error and AC/DC differences as related.

Galvanometer Resolution

The limit of the ability to detect changes in the output emf of the converter on the indicating galvanometer.

Source Stability

Variations in the amplitude of either the DC or AC sources utilized in making transfer measurements during the period of time the output emf of the converter is being compared to the internal reference.

Thermal Drift

Generally the drift in the internal reference circuit during the period of time the transfer between DC and AC input is made.

APPLICATIONS

Standard Laboratories, Systems Work, General Purpose Lab Work.

Calibration of AC Sources

Because the 540B is a transfer device and is directly traceable to NBS, it can be used for the calibration of AC sources.

Frequency Response Measurements

The frequency response versus output voltage level can be determined for an oscillator or signal generator that

operates within the frequency range of the 540B. The units must have sufficient output power capabilities to drive the 540B.

By setting the output of the oscillator at some convenient level and calibrating the galvanometer in percentage of input voltage change, we can determine the output voltage versus frequency response of an oscillator or generator.

AC Calibration of Voltmeters

The 540B Transfer Standard can be used in conjunction with a stable oscillator and power amplifier to calibrate

the AC section of both differential and digital voltmeters.

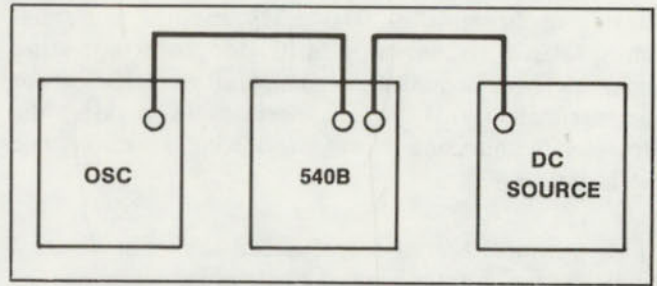

Figure 95. Equipment set up for frequency response measurements.



16

AC Voltage Calibration

INTRODUCTION

The main function of an AC calibrator is to generate an AC voltage which can be precisely selected over wide ranges of frequency and amplitude. Output sensing of the amplitude should be provided, either at the load or the calibrator output, so that the calibrator operates as a closed-loop control system and provides accurate output voltages over a wide range of loads and selected amplitude. It is the purpose of this section to acquaint you with the requirements of an AC calibrator by presenting the general concepts in a basic analysis.

ANALYSIS

Referring to Figure 97, a simplified block diagram of an AC calibrator, the AC signal source is a double-integrator type oscillator whose output is selectable over a wide range of frequencies by means of front panel

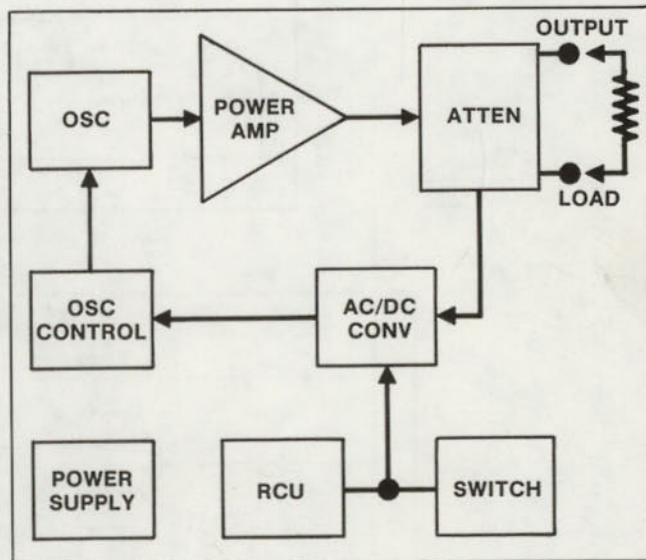

Figure 97.

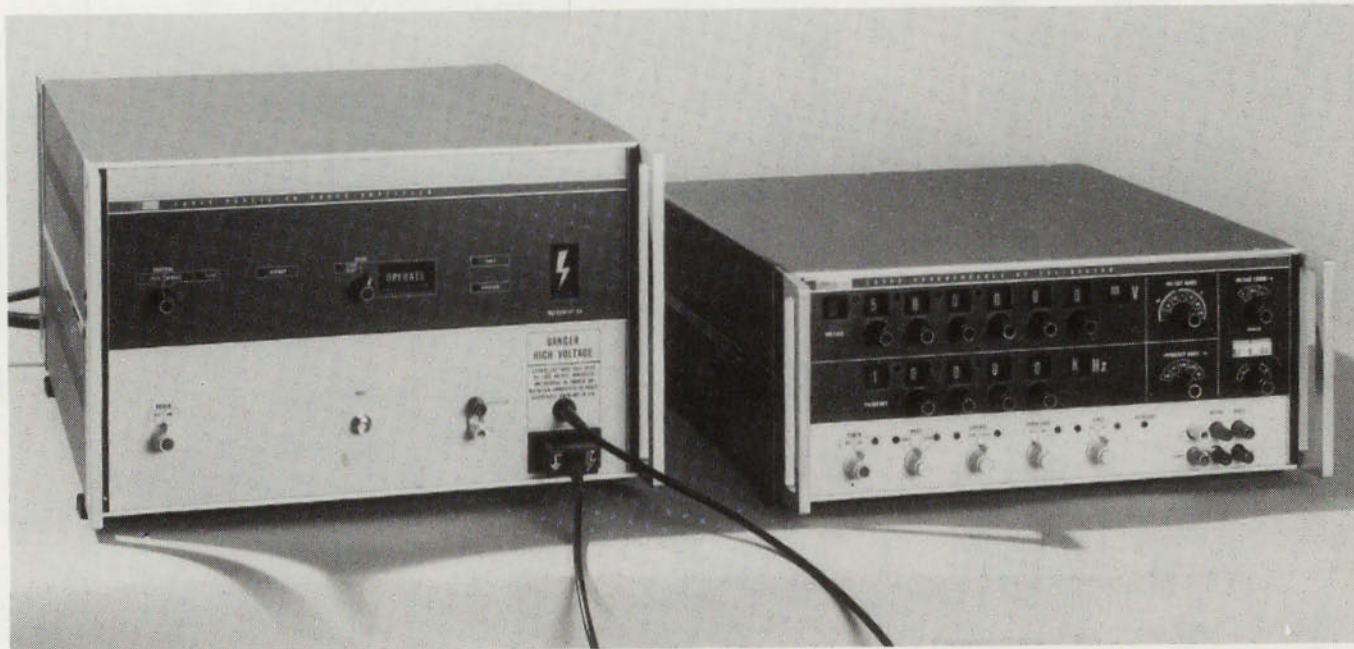

Figure 96. Fluke Models 5200A/5205A Precision AC Calibration Standard. An AC Calibration System Brings To Manufacturing And Laboratory Environments Greater Precision Over Wider Operating Frequencies. The operating AC Frequency Range Should Be 10 Hz to 1.2 MHz And Provide Accurate AC Voltages From 100 μ V To 1200 Volts RMS.

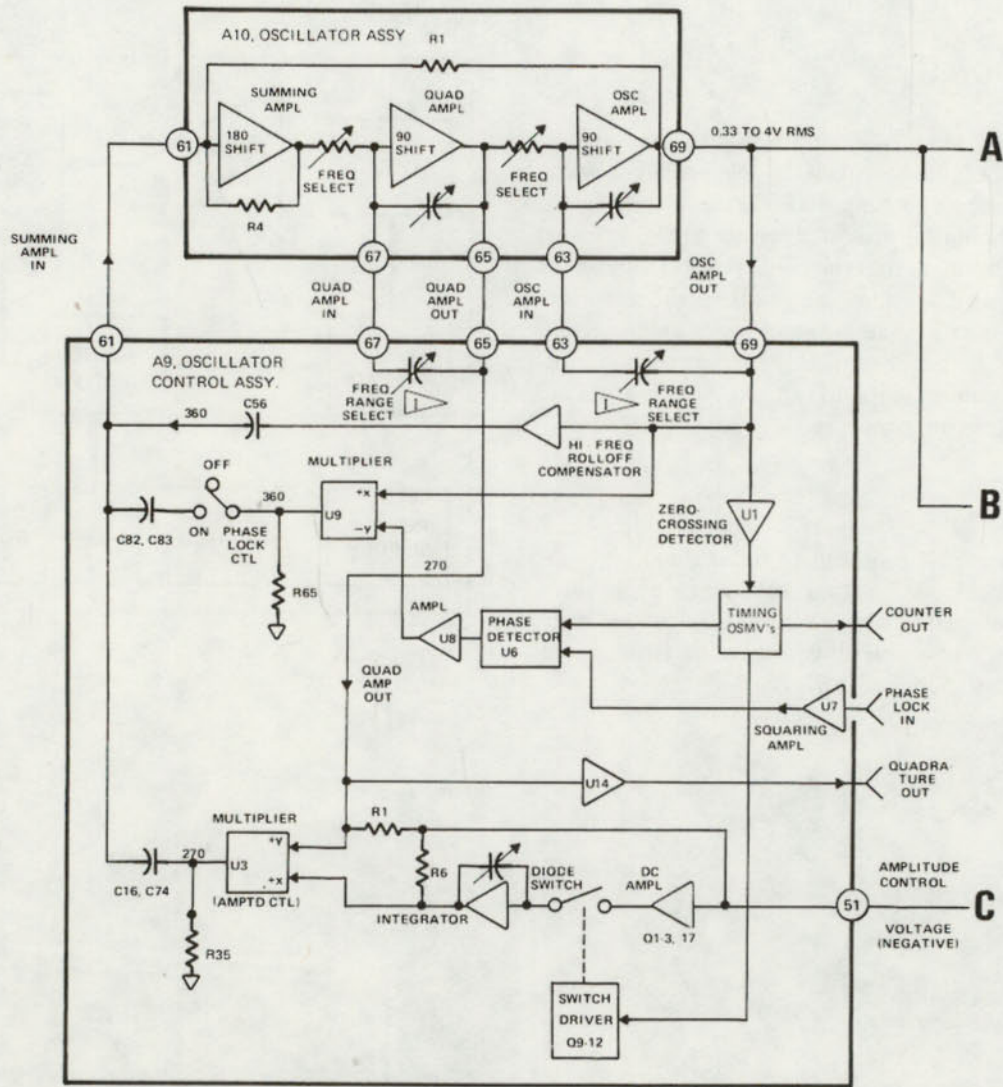
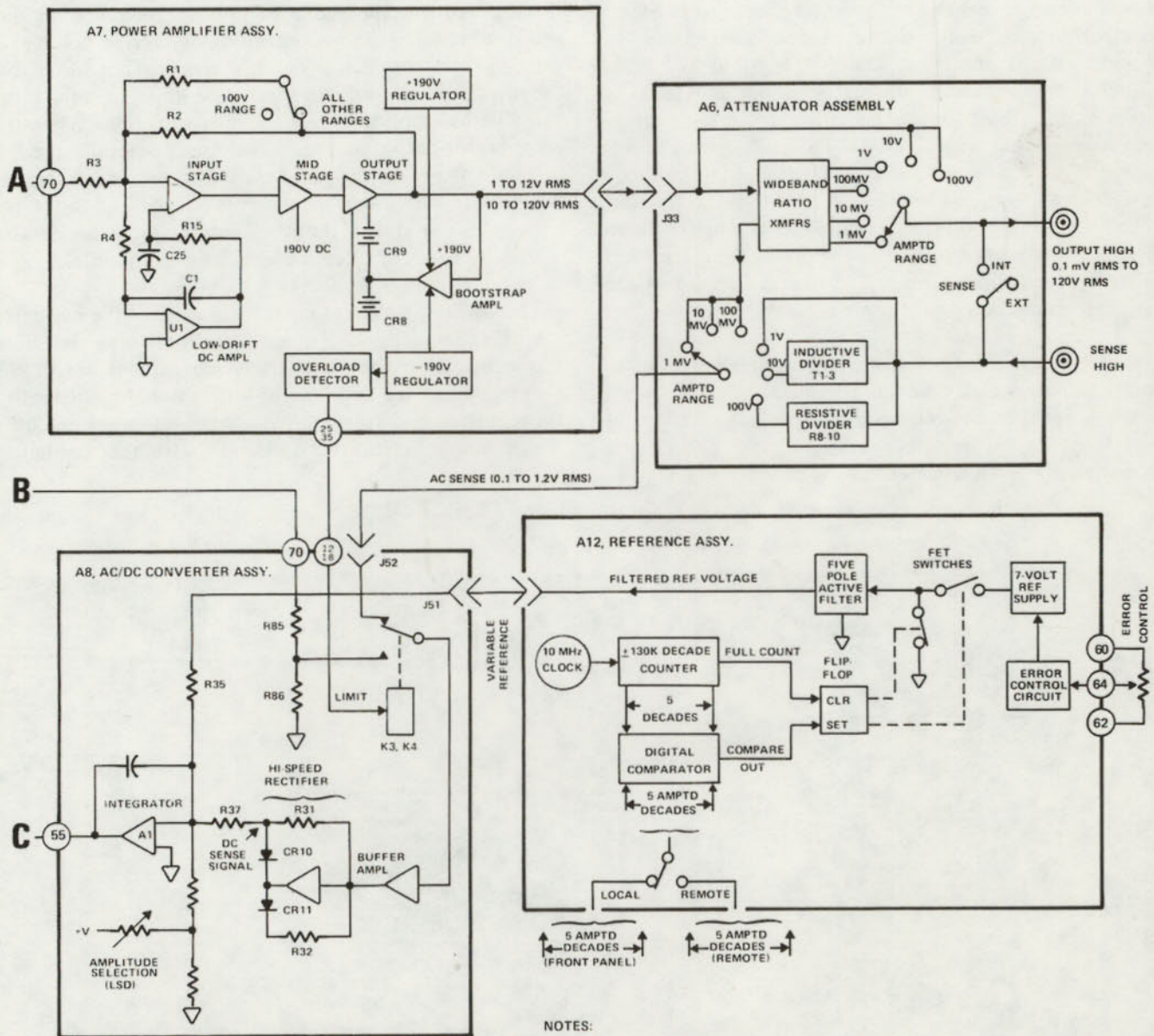

Figure 98. Functional Diagram of Fluke 5200A AC Calibrator.



switching, and is fed to the input of a power amplifier. The power amplifier provides the gain necessary to accommodate the higher amplitude ranges, and feeds the attenuator which accommodates the lower amplitude ranges. The attenuator output connects the selected AC signal to the load, which could be converted to either front panel or rear panel connectors.

In order to maintain precise control of the output amplitude, the calibrator operates as a closed-loop control system using output sense connections to complete the loop. These sense connections are made either at the load or the attenuator output, and feed the sense signal back into the calibrator via a high-impedance input within the AC-DC converter. The AC sense signal is converted to a proportional DC value by a wide band rectifier contained in the AC-DC converter. The DC sense signal is then compared (summed) with an amplitude reference voltage of the opposite polarity and a difference (error) voltage is produced to adjust the oscillator amplitude to the proper value.

The amplitude reference voltage is produced within the calibrator as a result of the amplitude selector switch settings. That is, the reference interprets the settings of the front panel amplitude switches and generates a corresponding reference voltage. The reference voltage

is compared to the DC sense voltage and any error voltage produced by the integrator is fed to the oscillator control which, in turn, uses that voltage to control the amount of feedback to the oscillator.

The action of the described control loop is such that when a different output amplitude is selected, a change in amplitude reference voltage results. Since the sense input has not yet changed and the DC sense voltage is compared with the changed amplitude reference voltage, a resulting amplitude control voltage (error voltage) is fed to the oscillator control circuit. The oscillator control circuit uses this error voltage to adjust the oscillator amplitude in the proper direction. When the calibrator output reaches the selected amplitude, the DC sense voltage (at the rectifier output) becomes balanced with the amplitude reference voltage, and no error voltage is produced. At this point, the oscillator control circuit ceases to alter the oscillator amplitude.

The oscillator control circuit will control the oscillator amplitude over a 12:1 range. Amplitude range selection is provided by the two selectable gain values of the power amplifier and several settings of the attenuator. Frequency and frequency range selection are made by switching selected value of R and C within the oscillator.

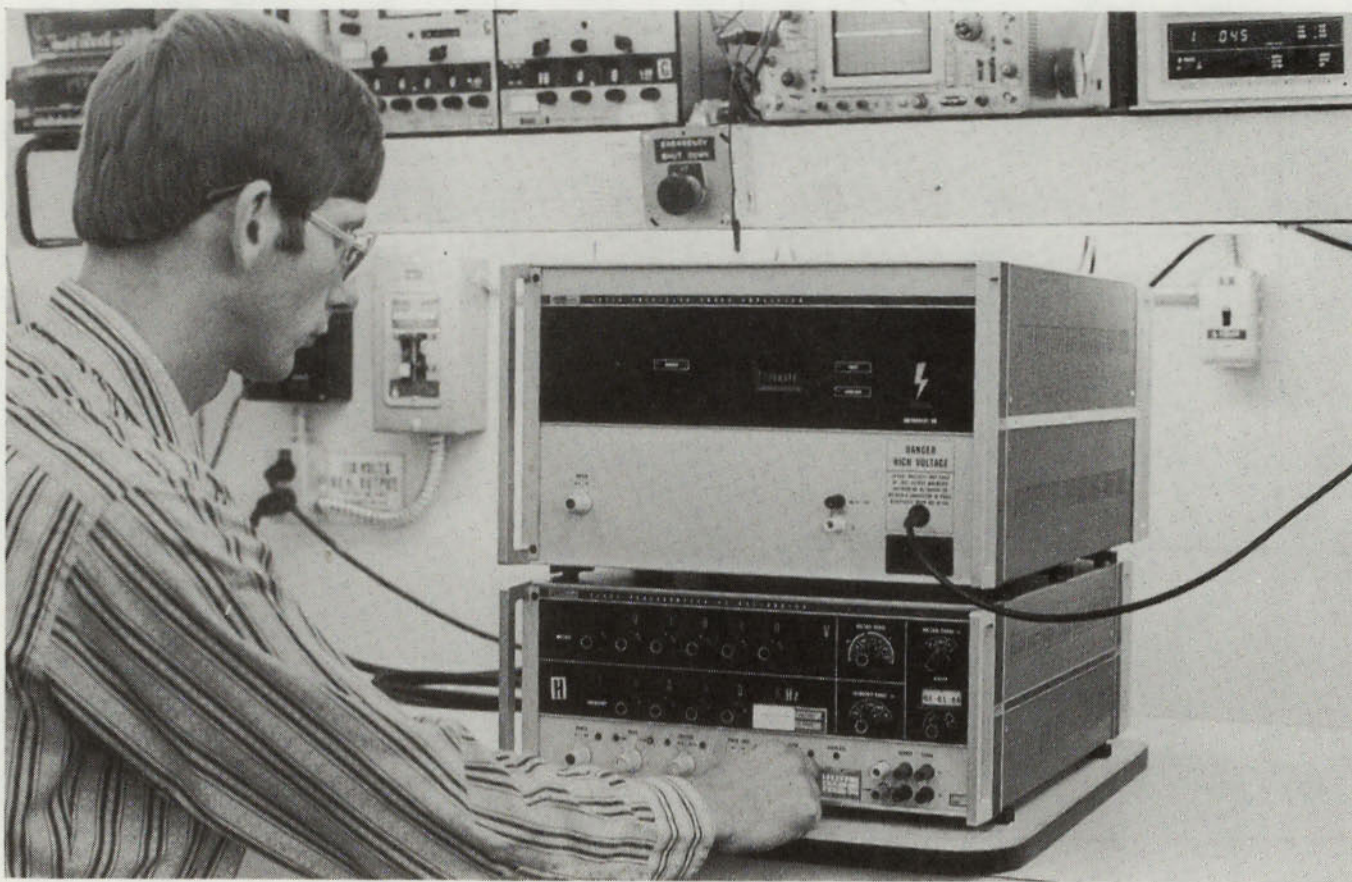

Time and Frequency Standards

INTRODUCTION

This section gives pertinent characteristics of the various techniques, including advantages and limitations, and refers the reader to in-depth studies of various aspects. In this cursory survey lack of space prevents comprehensive analysis of various systems; some of the newer and more promising techniques are described at some length.

STANDARD FREQUENCY AND TIME BROADCASTS

The World Administrative Radio Council (WARC) has allocated certain frequencies in five bands for standard frequency and time signal emission as shown in Figure 99. For such dedicated standard frequency transmissions the CCIR recommends that carrier frequencies be maintained so that the average daily fractional frequency deviations from the internationally designated standard for measurement of time interval should not exceed $\pm 1 \times 10^{-10}$. The map in Figure 100 shows the location of many radio stations used for TFD.

VERY LOW FREQUENCY (VLF) TIME AND FREQUENCY SYSTEMS

TFD systems in VLF band nominally operate at frequencies from 10 to 30 kHz. The 10-13 kHz band is used by the Omega Navigation system. In this section we describe briefly the development and uses of VLF apart from the Omega system. VLF and the related LF transmissions are not new; they were used in the early 1900's for long range communications between colonial empires, by various navies, and for general transoceanic services. Even at the time VLF transmissions showed good reliability with relatively low signal attenuation over large distances. Many of these transmissions were replaced later by the lower-cost high frequency (HF) broadcasts which employed much smaller antennas, at increased efficiency over VLF antennas. Many different VLF antenna configurations have been built, e.g., long cables have been strung several km across volcano craters and valleys or from towers several hundred meters in height. The present NAS antenna at Cutler, Maine (radiated power 1 Megawatt) is a top hat system supported by 26 masts $\sim 300\text{m}$ in height, covering an

Band No.	Designation	Frequency Range
4	VLF (Very Low Frequency).	20.0 kHz \pm 50 Hz.
6	MF (Medium Frequency).	2.5 MHz \pm 5 kHz.
7	HF (High Frequency).	$\left\{ \begin{array}{l} 5.0 \text{ MHz } \pm 5 \text{ kHz.} \\ 10.0 \text{ MHz } \pm 5 \text{ kHz.} \\ 15.0 \text{ MHz } \pm 10 \text{ kHz.} \\ 20.0 \text{ MHz } \pm 10 \text{ kHz.} \\ 25.0 \text{ MHz } \pm 10 \text{ kHz.} \end{array} \right.$
9	UHF (Ultra High Frequency).	400.1 MHz \pm 25 kHz. (satellite).
10	SHF (Super High Frequency).	$\left\{ \begin{array}{l} 4.202 \text{ GHz } \pm 2 \text{ MHz} \\ \text{(satellite space to earth).} \\ 6.427 \text{ GHz } \pm 2 \text{ MHz} \\ \text{(satellite earth to space).} \end{array} \right.$

Figure 99. International standard time and frequency radio assignments.

area $\sim 2.2 \text{ km}^2$; its radial ground system consists of $\sim 3.3 \times 10^6\text{m}$ of buried copper wire.

During World War II and shortly thereafter, attention was directed again to the low frequency band for navigation and communication. From such interest evolved the "Radius" navigation system, where the low frequency carriers showed the excellent stability required for navigation systems. From the mid-1950's onward, there have been great strides in worldwide frequency and time comparisons via low frequency broadcasts. Methods used by Pierce, Mitchell, and Essen; Pierce; and Crombie et al., among others showed improvement in frequency comparisons of two to three orders of magnitude better than those of HF techniques. It is particularly noteworthy that the more stable atomic frequency standards were replacing the crystal oscillator control of many of the VLF transmissions about this same time; thus in 1960, Pierce, Winkler and Corke showed that transatlantic phase comparisons of a 16-kHz carrier frequency could be made to about $2 \mu\text{s}$ in a 24 hr period using atomic cesium standards. Attention thus was directed towards VLF standard frequency broadcasts, and the VLF method has proven advantageous for comparing atomic frequency standards at

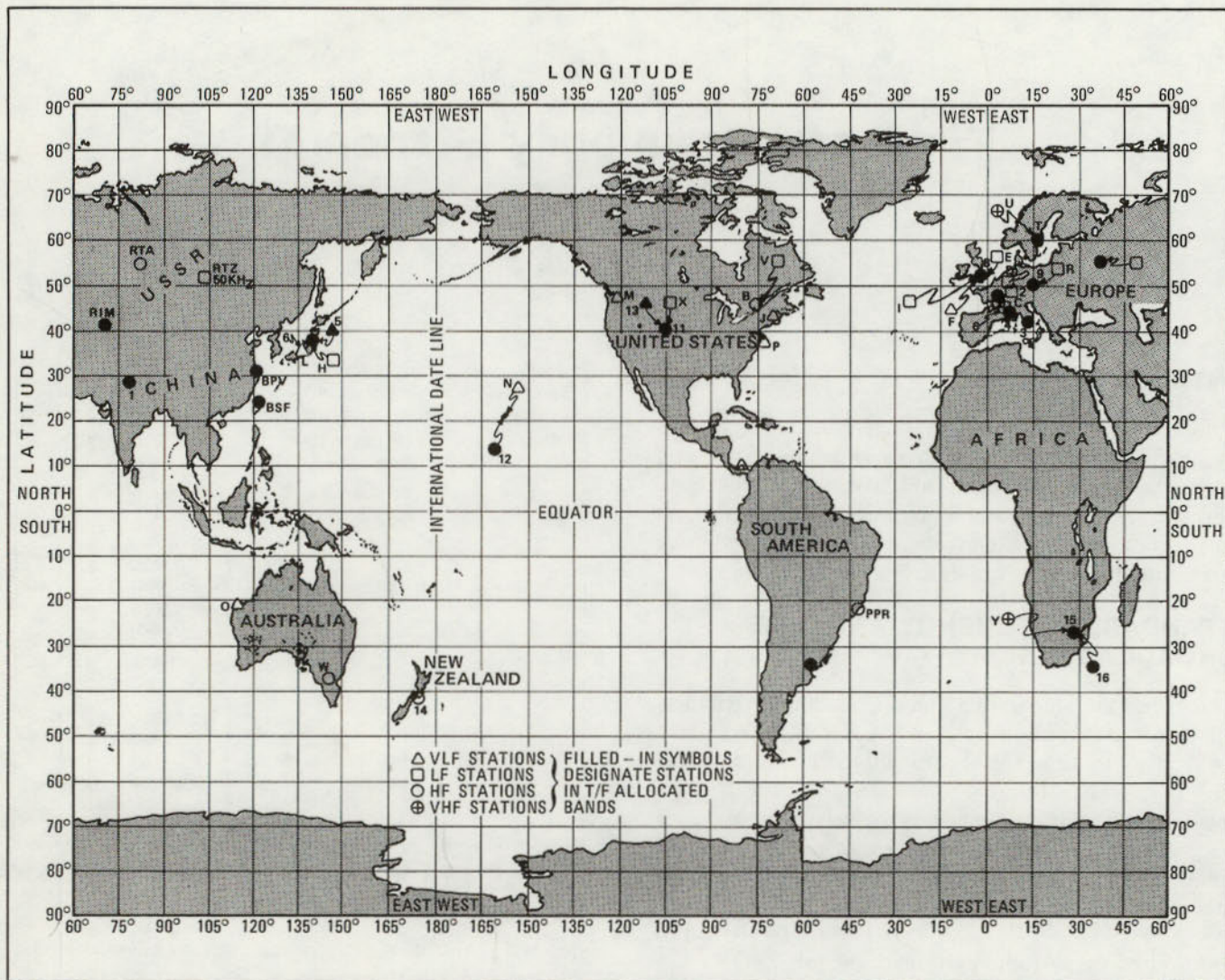

Figure 100. Worldwide location of broadcasting stations useful for TFD.

global distances. Today most VLF transmissions used for TFD are controlled by atomic frequency standards referenced to a coordinated international time base. This has resulted in a reasonably economic and reliable means of disseminating frequency to several parts in 10^{11} or better in a 24 hr period.

Of particular significance are the diurnal phase shifts which are somewhat frequency dependent but quite distance related. Typically, these predictable shifts range from ~ 20 to $80 \mu\text{s}$ for distances of 2000 to 10,000 km at frequencies of ~ 14 to 20 kHz.

Within the last decade a variety of VLF techniques have been developed for time and frequency comparison. These methods have confirmed the excellent stability shown in the 1950's and even today there is evidence that the limiting precision of VLF measurements has not been reached. We will briefly review several VLF time and frequency techniques.

VLF Single Frequency Comparison

A common and economical VLF method utilizes single frequency phase comparison, such as shown in Figure 101. In such an electromechanical system the servo-driven phase shifter continuously phase locks a synthesized signal from the local standard to the received VLF signal. A linear potentiometer output, connected to a constant direct voltage, generates a voltage signal and permits an analog recording of the phase shifter position. In other words, the recording shows the amount of phase shift the local synthesized signal experiences to agree with the phase of the received signal. A very narrow bandwidth (~ 0.01 to 0.001 Hz) is required for extraction of the coherent VLF signal level from characteristic higher noise levels >20 to 40 dB. (Electronic-servo VLF comparators with internal calibrator-signal generators are now available; these units are more stable than the electromechanical type and provide improved control for clock (synchronization).

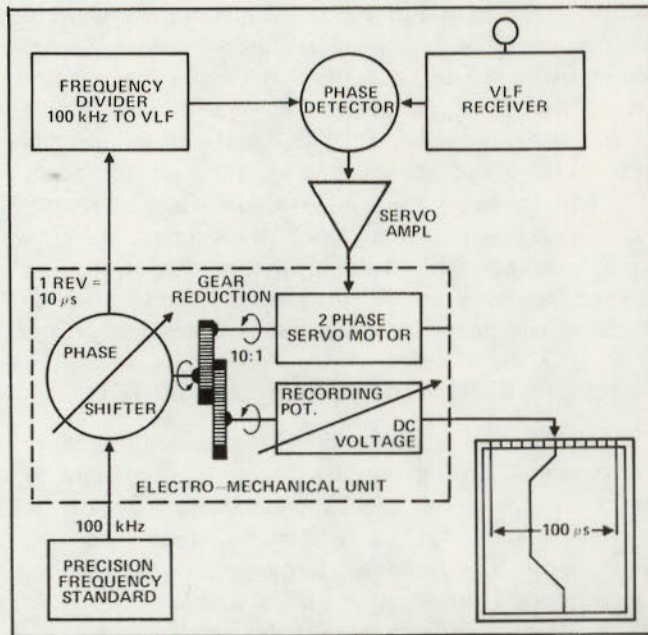

Figure 101. Typical VLF single-frequency comparator.

Measurements are made on the phase records generally at 24 hr intervals and at times when the propagation path is sunlit and phase fluctuations are minimal. The duration of such a quiet period varies with the seasons, reception path, and the path direction. (The standard deviation of phase fluctuations in NBA signals received and compared at NBS, Boulder — 4300 km — were several tenths of a μs for a series of 20 min measurements taken over a 7 hr period. The single VLF comparison technique does not permit initial clock synchronization; it does, however, give day to day comparisons of a local clock to microseconds. Corrections to many VLF broadcasts can be made after the fact from periodic publications of various laboratories such as NBS, the USNO, and the Research Institute of the Swedish National Defense.

Multiple-Frequency VLF Techniques

Another VLF approach is the so-called multiple-frequency technique which uses two or more coherently related, closely spaced signals which are transmitted sequentially. The method is based on similar principles as the Radux-Omega Navigation system. It is the hope that this method might permit initial synchronization of clocks at remote sites and/or resynchronization of interrupted clocks. There is a distinction between such synchronizations; i.e., initial synchronization, via a radio signal, requires accurate knowledge of the propagation delay. Initial synchronization along with direct measure of the propagation delay, however, can be performed by transportation of a portable clock to the site. On the other hand, clocks can be resynchronized through the multiple frequency technique by adjusting for the known propagation delay. There is

evidence that theoretical predictions of propagation delay compare favorably with experimental results.

The multiple carrier VLF method extracts timing information in the difference frequencies, allowing individual *cycle identification* of one of the carrier frequencies. The method has been used with WWVL and is applicable to the Omega frequencies. The technique demands extreme stability in the signals as transmitted, the transmission medium, and the receiving/ comparison equipment. In a typical synchronization, coarse time would be set initially via HF radio transmissions to several ms to resolve the difference frequency ambiguity ($<1/2$ of the difference frequency period; i.e., ~ 2.5 ms for the dual Omega frequencies of 12.5 and 12.7 kHz). In using Omega frequencies of 12.5 and 12.7 kHz, it is necessary that the residual phase error (differential propagation delay corresponding to one cycle offset = $\pm 1.26 \mu\text{s}$) be less than $0.6 \mu\text{s}$ for resolving cycle ambiguity at 12.5 kHz. That is, each cycle of 12.5 kHz (individual cycle period of $80 \mu\text{s}$) shows a differential phase offset of $1.26 \mu\text{s}$ at an appropriate comparison point of the 12.7 kHz signal. The number of error cycles within the difference frequency interval depends upon the so called *magnification factor*, $f_2/f_2 - f_1$, or 63.5 in the example of the 12.5 and 12.7-kHz signals (f_2 and f_1 respectively). Thus, the product of the magnification factor and the f_2 period gives the period of the difference frequency. A lower magnification factor places lesser demands on the measurement sensitivity.

The multiple carrier VLF method includes a local calibration signal for simulating the frequency of the received signal to relate the local time scale to that of the transmitter. Agreement between the received and calibrated VLF phases is made systematically and the local clock phase-shifter adjusted until all simulated signal phases are identical to the actual received signal phases for a single setting of the phase shifter. This phase relationship remains essentially unchanged (except for clock interruption and phase loss), and the VLF receiver can be turned off and on without affecting the calibration.

A basic paradox in using 2 VLF signals for clock synchronization is that an increase in the spacing of the frequencies improves the cycle resolution problem but places more stringent requirements on the coarse timing. Reception of three or more VLF signals, such as provided by Omega, gives a combination of both narrow and wide separation of frequency pairs, thus insuring cycle identification of the prime carrier; the stability, after synchronization, should be equivalent to that of the single frequency system. Several laboratories have used the multifrequency VLF techniques in combination with other systems for resynchronization timing.

VLF Timing Transfer Techniques

A time transfer VLF technique has been demonstrated by Becker. This method also uses a simulated carrier calibration which obtains a daily time difference between the local time scale and the received signal. The USNO simultaneously each day makes identical measurements. The daily differences of these Δt 's gives a time difference of the time scales of the PTB and USNO via given VLF transmissions. These measurements, confirmed by Loran-C data, averaged over an 18 month period (NSS to PTB path ~ 6000 km) show an uncertainty of $\sim 1 \times 10^{-13}$. Becker also asserts that filtering and averaging techniques used at the PTB for analysis of VLF data could be employed profitably by the BIH in formation of the International Time Scale (TAI).

VLF Pulse Methods

Several VLF transmitters periodically broadcast time signals. Time pulses transmitted at VLF show a slow rise time (15 ms at NBA — 18 kHz in 1960) because of the high Q of the antennas and a resultant large time delay. Stone determined time from the NBA transmitted pulses at Summit, Canal Zone to a receiver at NRL in Washington, DC to a precision of $\sim 500 \mu\text{s}$. While such time determinations might be resolved to higher precision, limiting factors include the difficulty in fixing the start of the pulse and the uncertainty of the transmitter, propagation, and receiver delays.

Statistical Smoothing of VLF Data

Allan and Barnes and Guetrot et al. have shown means for statistically reducing phase fluctuations on long term data. Guetrot applied optimum smoothing techniques to differential VLF data of NSS (21.4 kHz) and WWVL (20.0 kHz) over reciprocal paths in a study with the USNO. The results were compared with portable clock measurements and showed day to day deviations of 70 ns over this 2400 km path.

Time Comparison Via Frequency Shift Keying (FSK) of VLF Carriers

Frequency Shift Keying (FSK) of VLF stabilized communication transmission has been proposed for TFD. This method shifts two carrier frequencies either plus or minus 50 Hz with bit lengths of 20 ms and a transition time between shifts of 2 ms. At such rates, phase coincidence of the two carrier frequencies occurs at a point within each transition time. The 20 ms time markers will occur nearly continuously and permit coarse timing to such a level. The transition points are "on time" within $\pm 1 \mu\text{s}$ of the station clocks, and it is believed that the mid-point transition times can be resolved at a receiving site to $\pm 10 \mu\text{s}$ since the VLF signal periods range from ~ 30 to $60 \mu\text{s}$ a particular cycle

can be identified and time extracted from the cycle zero crossing to $\sim 1 \mu\text{s}$. It is proposed also to transmit time-code pulses once an hour, possibly the last five minutes before the hour. Stone et al. give results of two techniques for resolving FSK signals at a receiving station to about $\pm 10 \mu\text{s}$; e.g., through frequency discriminator techniques and/or those of a synchronous detector as used in many VLF tracking receivers. A signal averager is used for optimum resolution. The method shows promise for precise timing although receiving equipment is somewhat complex and costly.

Summary Statement of VLF Use in TFD

The stability and reliability of VLF standard frequency transmissions during the last decade is attested to by their use for international comparisons of atomic frequency standards as previously mentioned; for control of HF standard frequency emissions; for navigation; for propagation studies; and for adjustment of rubidium frequency standards which control the frequency of color TV broadcasts. The Sperry report on methods for synchronizing remote clocks states in its conclusions: "Do not overlook the possibilities of obtaining both accuracy and low cost in the combination of a clock stabilized by reference to VLF signals and set once by a master clock."

Advantages of VLF Systems for TFD

1. VLF phase comparisons can be made to several μs continuously at continental distances from a transmitter up to $\sim 10,000$ km and with low signal attenuation and stable propagation. This is an improvement of several orders of magnitude over HF techniques.
2. Generally continuous transmission (24 hr per day) and many stations located at widely separated points.
3. Single frequency comparisons can be made with relatively low-cost receiving equipment.
4. Most VLF transmitters today are stabilized with atomic frequency standards, which, in part, accounts for VLF signal stability.
5. Many VLF transmissions are monitored by national laboratories which publish corrections and permit reference to their time scales (after the fact).
6. Although VLF signals are subject to diurnal phase variations, such changes are both predictable and repeatable.
7. Once a propagation path is calibrated, multiple frequency VLF techniques can permit resynchronization of clocks at a remote site.

Limitations of VLF Systems Used for TFD

1. Atmospheric noise at VLF is quite high and coherent signals often must be detected well below the noise. Noise from lightning strokes is a maximum at these frequencies, and the low attenuation rates of atmospheric noise at VLF allows worldwide propagation of such static.
2. VLF propagation is subject to many phase anomalies diurnal variations, cycle slips, strong attenuation over ice fields, solar disturbances (Sudden Ionospheric Disturbances-SID's), long versus short path interference, nuclear blast effects, seasonal changes, and nighttime irregularities. In many cases, however, these are easily recognizable and can be accounted for. Some reduction in phase anomalies can be realized through composite wave analysis suggested by Pierce.
3. For best results, phase measurements should be made when the transmitter-receiver path is sunlit. Some paths at high latitude can show limited sunlit conditions, however.
4. Maximum success in VLF measurements requires atomic frequency standards at both the transmitter and receiver; good temperature control of equip-

ment; back up battery supply for AC power; periodic phase and amplitude calibration for detection of phase drifts or jumps in the local equipment; and periodic checks of antenna connections, circuit board and chassis contacts.

5. VLF transmissions received at distances of 1000 km or less from a transmitter are difficult to interpret because of the interference between ground and sky waves. There are also sensitive path distances at which modal interference critically destruct a received VLF signal, particularly during sunset and sunrise.
6. VLF techniques alone are not now capable for initial clock setting at a remote site. Generally, propagation delay is determined and initial clock setting is performed by a portable clock visit.
7. VLF signals experience dispersion (different phase velocities) and this can result in prohibitive variation in received signals for cycle identification in the multiple frequency technique.
8. VLF techniques, although simple in concept and design, require experienced personnel to properly interpret and analyze the signals as transmitted, propagated and received at a remote site.

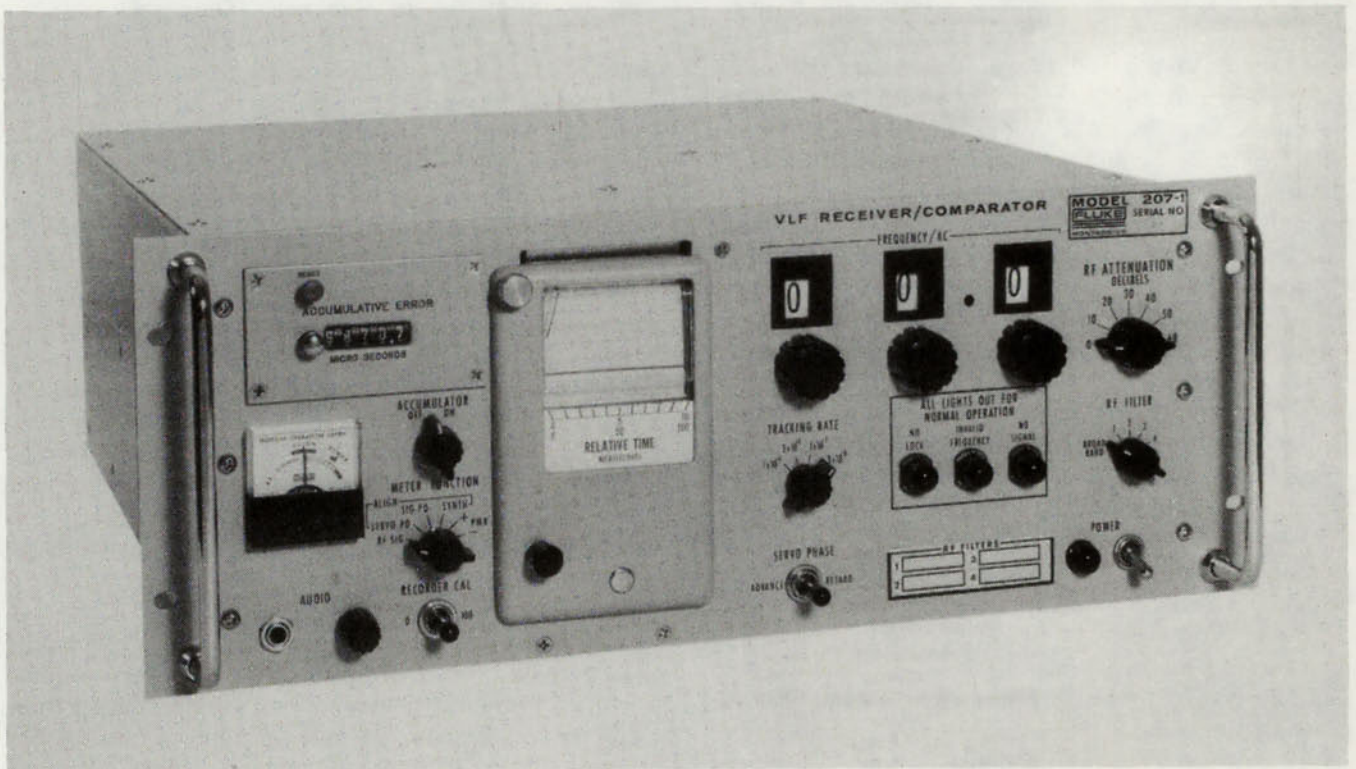

Figure 102. Fluke Model 207/205 VLF Receiver/Comparator

18

Errors in Measurement

Errors may be classified in many ways for different purposes. It is usually desirable, however, to distinguish as well as possible between systematic errors and random errors in measurement processes. First, we shall consider what is meant by "systematic errors."

The classification "systematic errors" includes those errors that remain constant through all repetitions of a measurement process, or produce a drift, trend, or other predictable pattern among repeated measurement results. Errors that remain constant through all repetitions of a measurement process are not ordinarily evident from looking at data. Constant errors in measurement results can exist, and their magnitude and sign may remain unknown until comparisons are made with results from other processes or other methods. The metrologist can determine limits of systematic error so that the uncertainty of the measurement result may be better understood by others who must make use of the result. Often it is necessary to determine limits of systematic error by rather subjective means. However, estimates made by an experienced metrologist who is familiar with the particular measurement process are generally accepted. A drift, trend, or cyclic variation in data can often be correlated with a similarly changing environmental factor such as temperature or humidity, or factors associated with the equipment such as the applied power, frequency, or line voltage. The search for causes of systematic errors in measurement processes can be a difficult task. It requires a rather complete knowledge of the specifications of the measurement method and process, including the characteristics of the particular equipment used. The burden of the search is on the shoulders of the metrologist in charge of the measurement process. He must use his resources and ingenuity to find the causes of error, and then take corrective action.

Random errors presumably result from a number of relatively small and independent error sources. Random errors, as a class, can now be defined as non-systematic errors, i.e., those residual errors exhibited by repeated measurement results that vary in an irregular manner without a discernible and predictable pattern. "Randomness" has been found to be one of the most elusive of

all concepts to define and, as a property, one of the most difficult to distinguish sharply from "nonrandomness." The presence of nonrandom errors is more or less evident from an examination of measurement results plotted graphically in the order taken. When the results appear to be random, independent, and spread somewhat symmetrically about a central value, and when small deviations from the central value are more frequent than large ones, the "normal law of error" is customarily used as a basis for describing the distribution of results. Statistical methods are available for treating random errors in measurements.

It is clear that when measurements of greatest accuracy are to be made, it is necessary to define the measurement process rather well and to state exactly what constitutes a repetition of the measurement. Only then can the separation of random and systematic errors be done in a meaningful way. Suppose an instrument with a scale and pointer reads erroneously because the "zero" adjustment is not properly set. The error will affect the recorded value and every further use that is made of it. It is a constant error in further use. If the measurement is repeated, and the adjustment still is not made, the result will be in error again, the same amount — a typical systematic error, regular and predictable in effect, although its size may be unknown.

When a systematic error is known to exist, as in this case, the metrologist must state the limits to systematic error that he is allowing to exist in the measurement process. This gives the user of the measurement results information that he needs. Along with a measure of the imprecision, to judge the accuracy associated with the results.

However, if the "zero" adjustment is carefully set before each repetition of the measurement, the small residual error from this particular source of error is likely to be different each time. After many repetitions of the measurements, it becomes apparent that the errors are distributed normally and the sample standard deviation would be a good measure of their dispersion. The systematic error from the "zero" adjustment has been reduced or eliminated. The random errors in the

measurements may be slightly larger than they were before. The systematic error has been reduced at the expense of a slight increase in random errors by the alteration in procedure.

Means of a number of such readings would be expected to exhibit more precision; i.e., they would show less variability than single readings. This kind of change in the measurement method is an improvement. The metrologist should strive to ensure that all systematic errors are reduced to negligible size or removed entirely, leaving only random errors which can be treated in more objective ways.

Some instruments draw power from the measurement circuit, thereby disturbing it and, perhaps, causing undesired or unknown changes. Sometimes the connections between the instrument and the circuit are ill-defined or produce an error that is difficult to correct. Perhaps environmental conditions affect the performance of an instrument. Whether the errors from such causes can be called systematic or random obviously depends on the answer to the question, "what is a repetition of the measurement?" We have seen that the determination of limits of systematic error is sometimes rather subjective, i.e., depends on the judgement of the metrologist. The treatment of random errors can be done much more objectively by using statistical methods.

When repetitive measurements are made in a calibration laboratory or on a production line, and all known systematic effects are believed to have been removed, the presumptions that "only random errors remain" and that "the random errors are within acceptable bounds" need to be tested at frequent intervals. The criterion for deciding when "it is safe" to proceed for the present as if "only random errors remain" is provided by control charts and associated techniques for judging the statistical significance of apparent trends, fluctuations, and other indications of possible nonrandomness. Control charts are graphical indicators of variability that provide visual evidence of statistical control, or the lack of it.

To obtain verification of the quality of a measurement process, the metrologist should use a "check standard" and keep control charts on the check standard. The check standard should be selected for best stability. A small group of standards of ordinary stability can be used for this purpose; the means of the group would be expected to exhibit better stability than a single standard. The check standard is measured as if it were an item to be routinely calibrated, and preferably through indirect comparison with other items and standards.

Control charts are visually prepared for either individual measurement results X or the mean \bar{X} of a group of measurement results, and either the computed standard deviations of a group or the range W of a group. A "group" of measurement should be reasonably coherent and deemed likely to exhibit only randomness within the group. Variations from group to group that are out of control will be recognizable on the control charts, and corrective action can be taken. In calibration laboratories an appropriate group may be a set of five measurements, taken one each day. At the end of the week the control charts would indicate the validity of the work done during the week and would give timely notice of trouble.

A control chart is prepared on graph paper by making a scale of the controlled-variable quantity of the vertical axis versus order (or time) on the horizontal axis. Horizontal lines are drawn to denote the central line and upper and lower control limits, as shown in Figure 103. As values of the quantity become available, they are plotted on the chart; thus the control chart is maintained as a continuing record of the process. The scattering of points above and below the central line is indicative of the variability of the process with respect to the quantity plotted. Charts may be used to monitor the measured value, the mean of a number of measured values, the computed standard deviation of the values in a group, the computed range of values in a group, etc. Control charts are not difficult to construct, and they can be developed to meet the requirements of many different measurement processes.

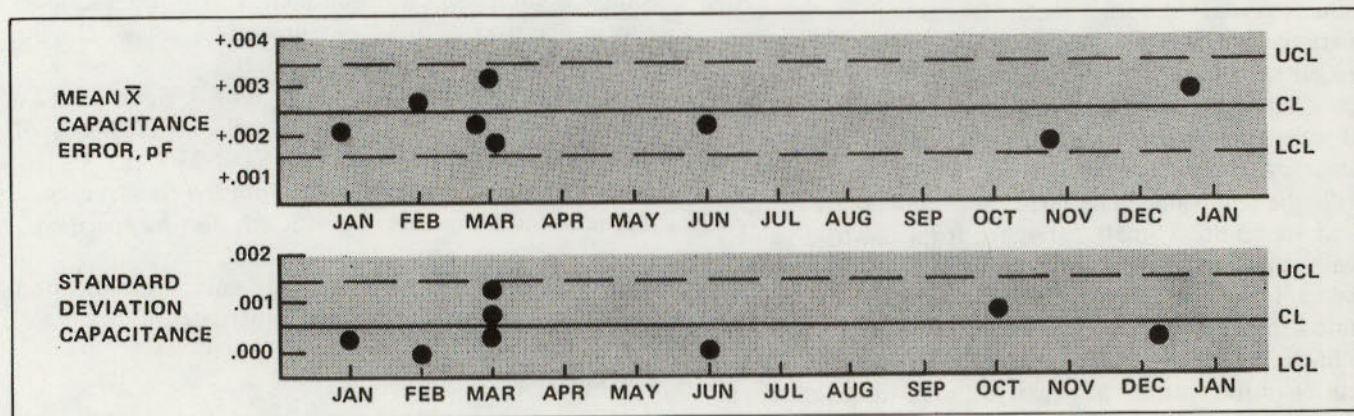

Figure 103. Set of controls charts.

19

Precision and Accuracy

In metrology the terms "accuracy" and "precision" are considered as characteristics of the measuring process. Accuracy refers to the typical "closeness to the true value," and "precision" refers to the typical "closeness together" of measurement results in a large population of results that have been obtained.

When measurements of the same quantity are repeated, the dispersion of the results can be seen by examining the data. A set of data that shows little variation may be said to "exhibit" greater precision than a set of data showing larger variation. For example, observe the variations in the data in the left column of Figure 104 and compare with the large variations in the right column. The sets of data are from measurements of voltage of two slightly different measurement processes corresponding to condition A and B. It must be understood that a single set of measurement data from a measurement process will exhibit greater or less precision than that which is characteristic of the measurement process. Terms like "high precision" and "low precision" leave much to be desired. The "high" and "low" modifiers must be considered relative to some known value of precision. Furthermore, in discussing precision, it is customary to think of the small differences among the results, which are really related directly to imprecision rather than precision.

The term "accuracy" in measurements refers to the typical closeness of a measurement result to the true value. Associated with a particular measurement result there is some error. We make inferences about the magnitude of the error, i.e., of the "accuracy," from our knowledge of the measurement process, or the method of measurement that produced it. As used in metrology, accuracy comprises both precision and conformance with the true value. The term "accuracy" is frequently used to denote a small difference from the true value, really the "inaccuracy" of a measurement. Advertisements for electronic instruments commonly contain statements such as "the accuracy is $\pm 0.1\%$ of full scale." What is intended is that "the limits of inaccuracy are $\pm 0.1\%$ of full scale." The negative and positive limits are intended as outer bounds for the errors that may reside in, or be caused by, the instrument, giving rise to the term

"limits of error." Numerical measures of imprecision and numerical limits of systematic error are needed to describe the accuracy of measurements; so it is important that all metrologists use the terms "accuracy" and "precision" in a consistent way.

TEST NO.	CONDITION "A" VOL.	CONDITION "B" VOL.
1	1.000002	1.000010
2	1.000005	1.000025
3	1.000001	1.000008
4	1.000002	1.000009
5	1.000003	1.000013
6	1.000002	1.000009
7	1.000004	1.000018
8	1.000001	1.000008
9	1.000002	1.000009
10	1.000003	1.000013
Max. Deviation From Meas Process	4 μ V	16 μ V

Figure 104. Deviation of 1 volt output from single DC source.

SPECIFICATIONS — WHAT DO THEY MEAN?

Specifications are a written description of the quality, capabilities, size, and features of an instrument. Instrument specifications are found to vary in simplicity depending upon the complexity and cost of the instrument. For example, the performance rating of a basic inexpensive DC analog voltmeter may include a simple accuracy specification such as $\pm 1\%$ of full scale on any range over a 10-40°C temperature range. On the other hand, the performance rating of a complex, expensive differential voltmeter may include a more detailed accuracy specification such as $\pm(0.005\%$ of reading + 0.004% of range + 1 μ V) at 23°C $\pm 1^\circ$ C, less than 70% relative humidity. In addition to accuracy, a stability and temperature coefficient may be specified.

This section will define some of the common specification terms as they relate to different instrument types.

Sensitivity

Sensitivity is defined as the smallest voltage level to which the instrument can respond and normally is specified as

the voltage level represented by the last detectable change on the lowest range.

Resolution

Resolution is the degree to which small changes in a voltage level can be identified. This specification may be stated in several ways depending upon the instrument type. The resolution of a basic DC analog voltmeter is normally quoted as one minor scale division. While resolution for a differential voltmeter is expressed as a percentage of full scale or parts per million at full scale. For example, a typical specification might list resolution as follows: null meter gives full-scale indication of $\pm 0.01\%$ of range; maximum resolution 1 ppm at full scale. The latter statement refers to the smallest discernible quantity on the scale of the meter. The resolution of a digital voltmeter is usually expressed as the number of significant digits available in the readout.

Accuracy

Accuracy is a statement of the largest allowable error expressed as a percentage or an absolute value. It can be a difficult specification to interpret, because from four different accuracy statements which exist, as many as three may be combined together to express the accuracy.

The four types of accuracy statements normally used are;

1. Percent of (reading or setting) ≥ 100 (Indicated Value - True Value) \div True Value
2. Percent of Full Scale or Range ≥ 100 (Indicated Value - True Value) \div Full Scale Value
3. X Units of the Smallest Readout Division Expressed in Counts \geq (Indicated Value - True Value)
4. X Volts \geq Indicated Value - True Value

The use of these accuracy specifications depends upon the type and complexity of the instrument. Regardless of which specification(s) used (1, 2, 3, or 4) the user will, in the final analysis, want to know what the maximum error is in percent of reading or setting. It is easy to determine what the maximum error is in percent of reading or setting from specification 1, but what about the others? The other three represent a constant quantity which must be applied anywhere across the scale on a given range. It is important to note, for instance, that at 0.1 scale the absolute quantity is ten times larger in percentage than at full scale. To be more specific, suppose the accuracy of a basic analog voltmeter is specified as $\pm 2\%$ of full scale. This represents a ± 20 mV uncertainty on the 1V range. At 0.1 scale (100 mV), a ± 20 mV uncertainty represents $\pm 20\%$ error in reading. Another example is the accuracy specification for a 3-1/2 digit DVM. The specification is

expressed as the sum of specification 1 and 4 such as $\pm 0.2\%$ of reading ± 2 counts. Here ± 2 counts is a constant quantity of ± 2 mV on the 1 volt range. This also represents larger measurement errors at readings less than full scale. It is not uncommon for the accuracy of an expensive, highly accurate instrument to be specified using the sum of specifications 1, 2, and 4. A typical specification may read $\pm(0.005\%$ of reading or setting $+0.0004\%$ of range $+1 \mu\text{V}$). The maximum percent of error for any instrument indication can be evaluated in a manner similar to the example cited above for the 3-1/2 digit DVM.

Stability

Stability is a measure of an instrument's ability to remain within its rated accuracy for some specified period of time. Stability may be specified in two parts, long-term stability and short-term stability. For a specified period of time, stability is often stated as an accuracy specification. For example, the long-term stability for a highly accurate DVM may be stated as $\pm(0.04\%$ of reading, $+0.002\%$ of range) over a 90-day calibration period while the short-term stability is stated as $\pm(0.002\%$ of reading $+0.001\%$ of range) per day. Another way short-term stability may be stated is in terms of a change in percent or ppm of reading over a given time period. Examples are 1 ppm per hour and 5 ppm per day. The stability specification is used only for highly accurate, precision instrumentation.

Response Time

The response-time specification is a statement of the time from the application of a full-scale step input or output to the time the instrument settles within its rated accuracy. For autoranging DVM's, response time would include the maximum time required for polarity and range changes.

Input Impedance

The input-impedance specification relates to the complex loading that a given instrument may present to a network under test. A DC resistance and shunt capacitance are often listed. The user may be interested in the input impedance for determining measurement accuracy. He must also be aware of network-stability problems which might be encountered when the network under test is presented the complex loading of an instrument.

Normal Mode Rejection

Normal mode rejection (NMR) is an expression of an instrument's ability to reject a superimposed AC signal at the input. A normal mode source C_n is shown in Figure 105. There are two ways in which NMR is typically specified. First, it may be specified as the ratio of the normal mode voltage to the resulting error in reading at a

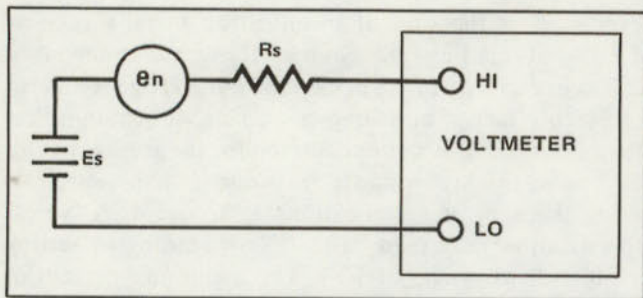

Figure 105. Voltmeter with normal mode generator

particular frequency. This ratio should apply at all signal levels from zero to full scale. Normal mode rejection ratio (NMRR IN dB) is;

$$\text{NMRR} = 20 \text{ LOG}_{10} C_n (\text{Peak Volts}) \div \text{Voltmeter Error (Peak Volts)} \text{ dB}$$

An example of AN/NMRR specification is 60 dB at 100 Hz. Second, NMR may be specified as a peak value of C_n which restricts the voltmeter error to be less than specified. A typical example for a basic analog voltmeter is as follows: AC voltages 60 Hz and above which are 80 dB (10,000 times) greater than end scale will affect readings <2%.

Common Mode Rejection

Common mode voltage sources which exist between the chassis ground of a voltmeter and the ground of the source tend to introduce normal mode voltages in the measurement loop connected to the Hi and Lo terminals of the voltmeter. A common mode source C_{cm} shown in Figure 106 develops a ground current I_g which flows through the 1 k Ω resistor in the line connected to the Lo terminal. A normal mode voltage C_n is developed across the 1 k Ω resistor which is measured by the voltmeter. The ability of the voltmeter to reject or minimize the current I_g is referred to as common mode rejection (CMR). CMR is

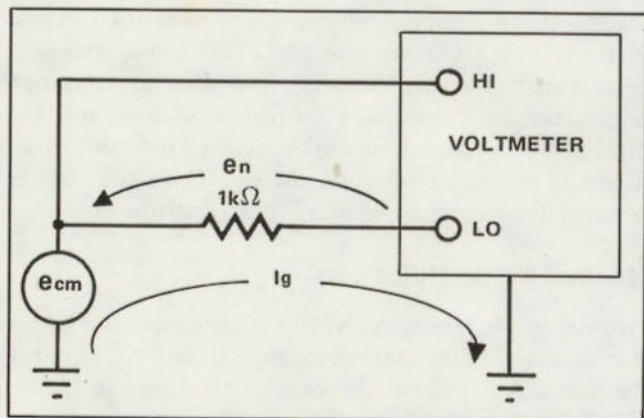

Figure 106. Voltmeter with common mode generator.

usually specified as the ratio of the peak common mode voltage to the resultant error in the reading caused by the normal mode voltage generated across a 1 k Ω unbalance in either input lead. This ratio (CMRR) is usually expressed (IN dB) as;

$$\text{CMRR} = 20 \text{ LOG}_{10} C_{cm} (\text{Peak Volts}) \div \text{Voltmeter Error (Peak Volts)} \text{ dB}$$

Expensive differential and digital voltmeters have a special guarding feature which is designed to reduce common mode signal interference. A typical specification is 120 dB at 100 Hz. A second method of specifying CMR is to list the peak value of C_{cm} which restricts voltmeter error to be less than specified. The frequency at which the specification applies must be listed along with a given unbalanced resistance in the input.

Temperature Coefficient

Environmental conditions usually limit the usefulness of an instrument because most laboratory-type instruments are not designed to operate in extreme hot, cold, or humid environments. Consequently, the performance rating, especially accuracy, must be qualified for a given range of environmental operating conditions. Most often an operating temperature and humidity range is specified. In special cases, where high accuracy instruments are concerned, a temperature coefficient of accuracy for a specified range of temperatures is given. An example of an accuracy and temperature coefficient specification for a high accuracy instrument will best illustrate the environmental operating conditions.

Accuracy: $\pm(0.005\%$ of reading or setting $+0.0004\%$ of range $+1 \mu\text{V}$) at $23^\circ\text{C} \pm 1^\circ\text{C}$, less than 70% relative humidity.

Temperature Coefficient: Less than $\pm(2 \text{ ppm}$ of reading or setting $+1 \mu\text{V}$) per $^\circ\text{C}$, 10°C to 40°C .

Volt-Hertz Rating

The volt-hertz rating states the maximum of the product of the input rms voltage and the frequency, constant with the bandwidth and range specification, that can be measured. The limitation on this specification is usually the slew rate of the amplifiers. Typical AC voltmeters range from 10^5 to $10^8\text{V}\cdot\text{Hz}$. If this specification is exceeded, the amplifiers will pass a distorted version of the input wave, which will result in an erroneous reading.

Crest Factor

Crest factor is defined as the ratio of peak voltage to rms voltage of a periodic waveform. This term applies to rms-responding voltmeters only. It is a statement of the maximum ratio which the signal to be measured may

have. Crest factor is of primary importance when measurement of low duty cycle pulsed waves is desired. It essentially limits the pulsed energy to which the rms voltmeter can respond. Typical crest factor specifications range from 5:1 to 10:1.

Ripple and Noise

Ripple is the periodic portion of the residual AC component of the DC power-supply output, and is harmonically related to the AC input line frequency. Not all AC output components are periodic — the ones that are not are called noise. Because these two AC output components occupy overlapping frequency spectra and are difficult to measure separately, they are usually lumped together for specification purposes. It is usually understood that either the positive or negative power supply output terminal must be grounded for this specification to be applicable — some degradation can be expected if the power supply is “floated.” Most laboratory power supplies have their output ripple and noise specified in terms of an rms value. A drawback of the rms ripple specification is that a power supply with high output ripple spikes of short duration can have the same rms specification as a competitive unit with lower peak-to-peak ripple (see Figure 107). Yet the ripple spikes may be of serious consequence in some applications — causing, for example, false triggering of low level digital IC logic circuitry. Since significant design changes are often required to reduce peak-to-peak ripple spikes. Many power supplies include a peak-to-peak, as well as an rms, ripple specification. Such a peak-to-peak specification preferably includes an indication of the bandwidth of the measurement. A 500 kHz oscilloscope measurement of peak-to-peak ripple is usually inadequate to preserve waveform peaks, since most of the energy content of ripple spikes lies at frequencies above 1 MHz. The measuring technique should have a bandwidth of 20 MHz or more. In fact, the ripple and noise

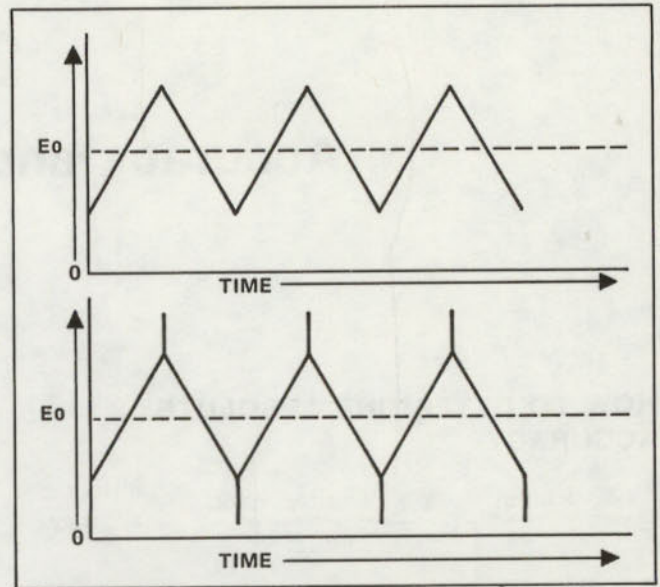

Figure 107. Two ripple waveshapes with essentially identical RMS value, except lower waveshape has twice the peak-to-peak value with periodic spikes.

specification should include both an upper and lower frequency limit — the latter is necessary in order to distinguish between low-frequency noise and drift. Although this lower frequency limit may not be explicitly stated, it is usually implied by the manufacturer's recommended measuring technique for ripple and noise, which typically cuts off somewhere below 10 or 20 Hz. The ripple performance of which a power supply is capable may not be achieved when remote sensing and remote programming are used, unless the user takes adequate precautions to shield the sensing and programming leads from stray pickup. It is equally important that such shields not be used as current-carrying conductors, instead, the sheath should be connected to a “quiet” potential, such as ground, at one end only.

20

Accuracy and Specmanship

HOW TO DETERMINE ABSOLUTE ACCURACY

$$\underbrace{X\% \text{ of input}}_{\text{input spec}} + \underbrace{Y\% \text{ of range} + Z \mu\text{V}}_{\text{floor spec}} = \text{absolute accuracy}$$

Detailed Example:

Conditions:

Meter accuracy $\pm(0.002\%$ of input $+0.001\%$ of range $+10 \mu\text{V})$

Meter range — 0.1V

Voltage level — 25 mV

Step 1:

$$\pm 0.002\% \text{ of } 25 \text{ mV} = \pm 0.000005 = \pm 0.5 \mu\text{V}$$

Step 2:

$$\pm 0.001\% \text{ of } 0.1\text{V} = \pm 0.000001 = \pm 1 \mu\text{V}$$

Step 3: $\pm 10 \mu\text{V}$

$$= \pm 10 \mu\text{V}$$

Step 4: Add:

$$\pm 11.5 \mu\text{V}$$

Step 5: Divide:

$$11.5 \mu\text{V} \text{ by } 25000 \mu\text{V} \times 100 = \pm 0.044\% \text{ absolute}$$

Note the non-linear effect that the floor causes!

Simple Example:

Conditions:

Meter accuracy $\pm(0.002\%$ of input $+0.001\%$ of range)

Meter range — 0.1V

Voltage level — 10 mV

Step 1: Assume

$$\text{Step 2: } \pm 0.001\% \times 10 = \pm 0.01\% \text{ approx. absolute}$$

Another Example:

Conditions:

Meter accuracy — 0.002% of input $+0.001\%$ of range

Meter range — 0.1V

Voltage level — 2.5 mV

Step 1: Assume 0.002% of input is insignificant

Step 2: Multiply: $\pm 0.001\%$ by 40 = $\pm 0.04\%$ approx. absolute

WHAT'S A PPM?

$$1 \text{ ppm} = \frac{1}{1,000,000} = 0.0001\% = \text{Standard Lab accuracy}$$

$$10 \text{ ppm} = \frac{10}{1,000,000} = 0.001\% = \text{Max. resolution } 5\text{-}1/2 \text{ digit DVM}$$

$$100 \text{ ppm} = \frac{100}{1,000,000} = 0.01\% = \text{Max. resolution } 4\text{-}1/2 \text{ digit DVM}$$

$$\text{Remember These } \rightarrow 0.1\% = \text{Max. resolution } 3\text{-}1/2 \text{ digit DVM}$$

HOW TO CONVERT %FS TO % OF RANGE

Formula: $\%FS + (\%FS \times \text{overrange}) = \% \text{ of range.}$

Example: $0.1\% \text{ FS} + (0.1 \times 20\%) = 0.12\% \text{ of range}$

$$0.1\% \text{ FS} + (0.1 \times 60\%) = 0.16\% \text{ of range}$$

$$0.1\% \text{ FS} + (0.1 \times 100\%) = 0.2\% \text{ of range}$$

$$0.1\% \text{ FS} + (0.1 \times 200\%) = 0.3\% \text{ of range}$$

$$0.1\% \text{ FS} + (0.1 \times 300\%) = 0.4\% \text{ of range}$$

$$0.1\% \text{ FS} + (0.1 \times 400\%) = 0.5\% \text{ of range}$$

HOW TO CONVERT 1 DIGIT TO % OF RANGE

For DVM's utilizing 1, 10, 100, 1000V ranges.

$$1 \text{ digit} = 0.1\% \text{ of range for } 3\text{-}1/2 \text{ digit DVM which is maximum resolution.}$$

$$1 \text{ digit} = 0.01\% \text{ of range for } 4\text{-}1/2 \text{ digit DVM which is maximum resolution.}$$

$$1 \text{ digit} = 0.001\% \text{ of range for } 5\text{-}1/2 \text{ digit DVM which is maximum resolution.}$$

$$2 \text{ digits} = 0.2\% \text{ of range for } 3\text{-}1/2 \text{ digit DVM which is maximum resolution.}$$

ACCURACY TEMPERATURE SPAN

Common Spans:

23°C ±1°C for use in temperature controlled calibration labs or very short-term relative measurement usage.

23°C ±5°C applied to most 4-1/2 and 5-1/2 digit DVM's

23°C ±10°C applies to the better 3-1/2 digit DVM's like the 8000A and also the 8100B and 8120A

(25°C is also used)

Typical Spec:

(0.001% of input +0.001% of range)/°C, 0°C to 50°C
or

(0.001% of input +0.001% of range)/°C, 0°C to 18°C
and 28°C to 50°C

Example:

Conditions:

Meter accuracy — 0.002% of input +0.001% of range,
23°C ±1°C

Meter tempo — (0.0001% of input +0.0001% of
range)/°C

Test temperature — 28°C

Step 1: Determine degrees of temperature above specification 28°C -24°C = 4°C

Step 2: Multiply: 4 X (0.0001% of input +0.0001% of range)/°C = 0.0004% of input +0.0004% of range

Step 3: Add to accuracy specification 0.002% of input +0.001% of range = 0.0024% of input +0.0014% of range

ACCURACY TIME SPAN

Typical Spans:

24 hours — considered short-term

30 days — used by some

90 days — most popular

6 months — military and older instruments

1 year — common with better 3-1/2 digit DVM's such as 8000A. Has lowest after sale cost because of fewer required calibrations.



21

Guarding of Digital Voltmeters, Digital Thermometers and Calibrators

INTRODUCTION

The primary purpose of this section is to show the proper use of the guard (Blue Terminal) and to clarify related specifications. Another purpose of this section is to show how the guard reduces common mode errors. If you are a DVM user, but don't have the time to completely read this section, at least read the answer to the questions, "What happens if I leave the guard disconnected; and, do I need to use a third wire for the guard for every measurement?"

GUARD USAGE

What is the proper hook-up for the guard? (See Figure 108)

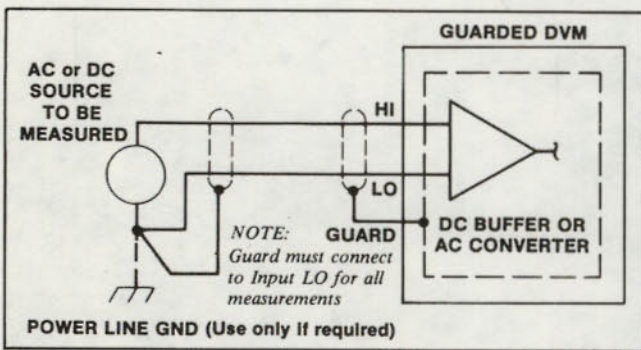

Figure 108.

Do I need to use a third wire for the guard for every measurement?

No, not all measurements need the third guard wire brought out to the source to be measured. A jumper strap between Lo and Guard at the front or rear panel will do for some measurements as the following general guidelines indicate:

Third Guard Wire Required:

1. When Common Mode voltages exist
2. When making accurate measurements

3. When making sensitive measurements with resolution below $10 \mu\text{V}$
4. When using long signal leads
5. When using an input scanner in system applications (Guard must be switched also)

Lo to Guard Jumper Strap Okay:

1. When no Common Mode voltage exists
2. When making low accuracy measurements
3. When making insensitive measurements with resolution above $10 \mu\text{V}$
4. When using short signal leads

Also note that the third wire for the guard can be the shield of a two conductor shielded cable.

What happens if I leave the guard disconnected?

DON'T! If you do, one of two things can happen. You will end up either calling the Fluke Sales Department complaining of incorrect readings or you will be unhappily calling a Fluke Technical Service Center to get your DVM repaired. Here's why. Leaving the guard disconnected, in the presence of a common mode current, will allow the current to flow in the signal leads through the series combination of the Lo to the Guard (C_{LG}) and Guard to Chassis (C_{GC}) capacitances and through the stray capacitance from the sensitive points in the DVM's amplifiers (the guard now being somewhere between Lo and Chassis potential), both of which will cause reading errors (almost guaranteed). The DVM can also be destroyed by leaving the guard disconnected because the voltage stored on the Lo to Guard capacitance (C_{LG}) may exceed the 100 volt maximum due to static charge accumulating or by the current supplied by an added common mode voltage.

Most Fluke DVM's and many others are rated for only 100 volts breakdown between Lo and Guard. A high

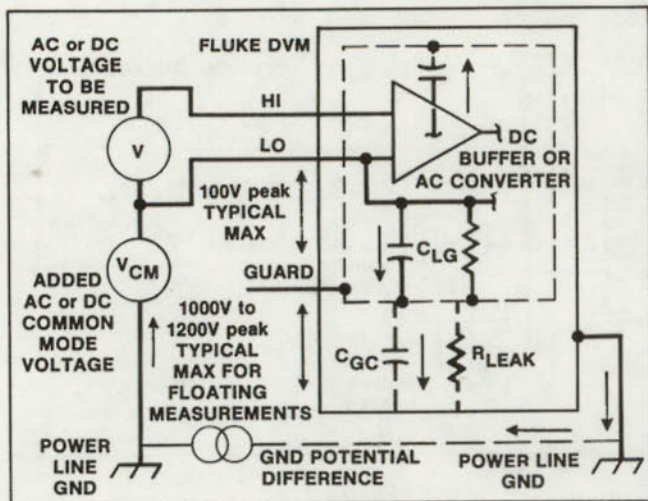

Figure 109.

common mode voltage could cause a greater than 100 volt condition from Lo to Guard due to the divider action of the Lo to Guard and Guard to Chassis capacitance and leakage resistances. All guarded Fluke DVM's can make a floating-guarded measurement to 1000 volts or 1200 volts (depending on the model used) above chassis (power line ground).

What do I do with the guard during accurate, 4-wire resistance measurements especially when the unknown resistance is at ground or at some potential? (See Figure 110)

For high value resistance measurements, a Guard Shield can be added around the unknown resistance (connect to Guard) to reduce noise pick-up.

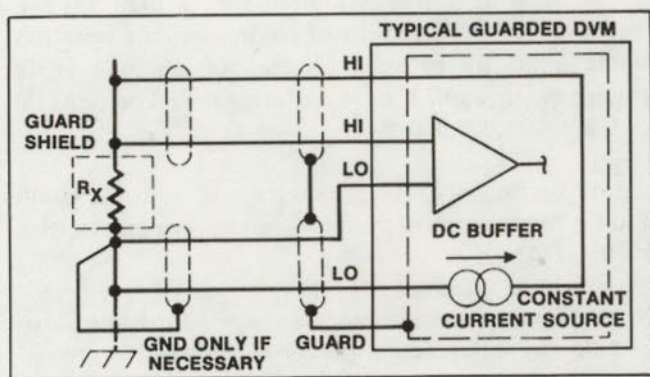

Figure 110.

What do I do with the guard during non-critical resistance measurements?

Leave the Guard strapped to Lo on the front panel.

What do I do with the guard when using a guarded source? (See Figure 111)

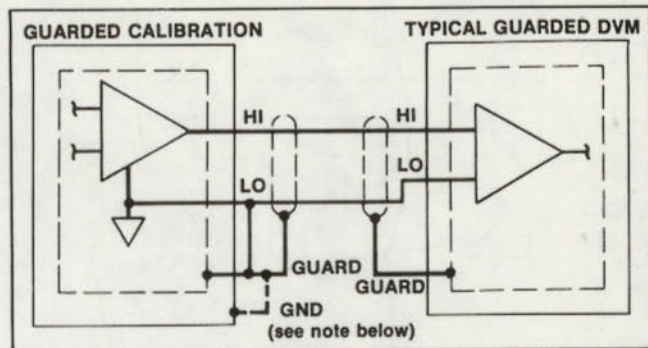

Figure 111.

NOTE

Connect only one Lo to Guard Jumper strap. For most applications, it should be placed at the calibrator end. If the calibrator has a ground terminal (white or metal), follow the hook-up instructions issued with the calibrator.

Does guarding apply to a digital thermometer? (See Figure 112)

YES, a digital thermometer is essentially a DVM that measures the voltage produced between two junctions of two dissimilar metals. The DVM also must linearize the non-linear output of a thermocouple but still needs to be properly guarded.

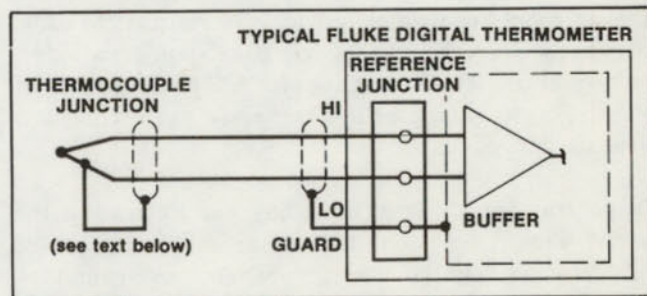

Figure 112.

For accurate measurements in application where there is a large common mode voltage present (example-thermocouple attached to a power transistor collector), the guard wire should be attached to the low thermocouple leads as close to the junction as possible without causing the temperature gradient at the couple.

What do I do with the guard for a bridge hook-up?

For a bridge, refer to the hook-up shown in Figure 113.

In this application, a guard driver amplifier is required for accurate measurements, especially for AC measurements. The function of the guard driver amplifier is to

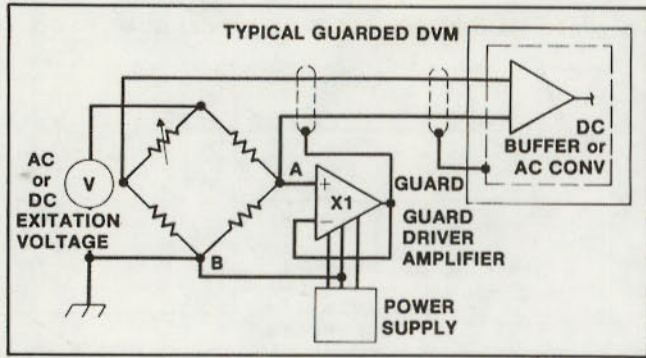

Figure 113.

minimize the loading at point A while driving the DVM guard and cable shield at the same potential as that at point A. If the guard is attached directly to point A (which can be done for lesser accurate measurements), the Guard to Chassis impedance will load point A (typical impedance is 100 M Ω /200 pF for a plastic cased DVM and 100 M Ω /5000 pF for a metal cased DVM).

The guard driver amplifier should be selected with enough output drive capability without oscillating to drive the DVM's Guard to Chassis capacitance and also to have high input resistance and low input capacitance. It should be hooked-up in the unity gain non-inverting mode. The amplifiers power supply common must be connected to point B, not to the DVM.

An intermediate solution would be to replace the Guard Driver Amplifier with a third pair of resistors to drive the guard. The ratio of these resistors should provide a voltage nearly the same as at point A. The impedance of these resistors should be low compared to the Guard to Chassis impedance.

In general, for all three hook-ups, the Lo lead of the DVM should be connected to the mid-point of the bridge which has the lowest impedance to ground.

What other applications require a guard driver amplifier?

Most off ground accurate ac measurements need a guard driver amplifier. (See Figure 114)

Note also that the difference in loading capacitance and loading resistance across each attenuator resistor must be compensated for. The typical input impedance of a DVM in the ac volts mode is 1 M Ω /100 pF.

Do all DVM's have a guard?

NO, a typical 3-1/2 digit DVM is not sensitive enough to require one. Generally, a 4-1/2 digit DVM with a plastic case doesn't require one because of its small capacitance between Input Lo and Power Line Ground.

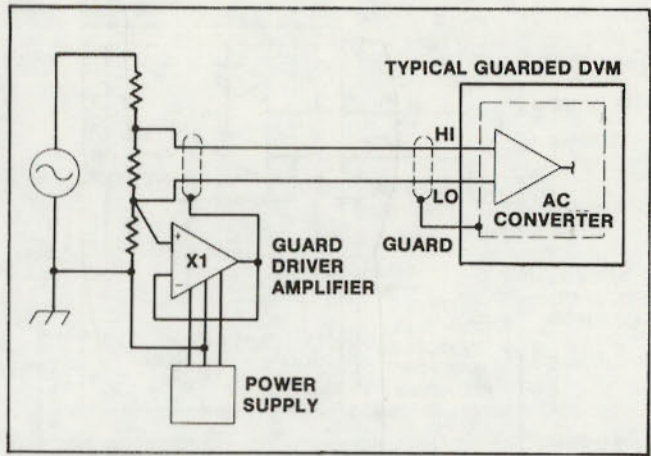

Figure 114.

What happens when I use a battery operated DVM?

Using a DVM on battery power (or using a floating source) with the power line disconnected, almost completely eliminates the common mode current and any errors it causes. How well it is eliminated will depend upon capacitance and leakage resistance (spacing) to Power Line Ground. Don't forget most electronic instruments and metal bench tops are at Power Line Ground.

COMMON MODE SPECIFICATIONS

How do I interpret the 120 dB or 140 dB CMRR specifications?

120 dB is a ratio of 1,000,000 to 1 and 140 dB is a ratio of 10,000,000 to 1. For example, if 100.000 mV is to be measured with 1 μ V resolution (5-1/2 digit DVM), then a DVM with 120 dB of common mode rejection would allow up to one volt peak of common mode voltage before a one digit (1 μ V) error would be seen (1V \div 1 μ V = 1,000,000:1).

A DVM with 140 dB of common mode rejection would allow 10 volts peak of common mode voltage, etc. (See Figure 115)

Note that the common mode voltage added must also include any difference in potential between the ground lines.

What does 1 kilohm unbalance resistance mean?

It means that either the Hi or Lo lead may have up to 1 k Ω in series with it while still meeting the common mode rejection spec. Some applications require an unbalance resistance. Note that some DVM's specify the 1 k Ω resistance in the Lo lead. This is because the Lo lead is more critical to common mode currents.

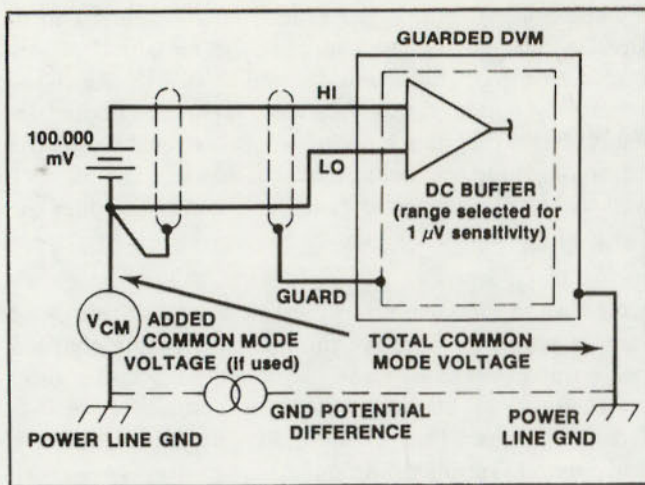

Figure 115.

Also note that for ac measurements and some other DVM's 100Ω unbalance is often specified instead of 1 kΩ. A DVM that does not specify an unbalance resistance means that it can not be used with an unbalance resistance without degrading the Common Mode Rejection Specification.

GUARD THEORY

The purpose of the guard is to reduce common mode currents which in turn will increase the Common Mode Rejection of a DVM (Reduce Common Mode Errors) for DC, AC and Resistance measurements.

What is common mode?

It is a current between a DVM and the source being measured that causes errors in the measurement being made. (See the Simplified Block Diagram, Figure 116.)

The distributed capacitance (AC) and the leakage resistance (DC) associated with the power transformer and between Input Lo and Chassis (C_{L.C}) in the DVM, cause a current to flow from the AC power lines through the ground system through the similar capacitance and leakage resistances of the source to be measured. The common mode current flows through the Hi and Lo leads causing a voltage drop across the lead resistances. The DVM sees the voltage across the source plus the voltage across the lead resistances, thereby causing an error especially for sensitive measurements.

Common mode currents also cause errors that are different from instrument to instrument. The current through the capacitance and leakage resistances from critical parts of the DVM's sensitive amplifier to the chassis causes errors.

Figure 116 also shows how non-isolated analog outputs and non-isolated digital outputs can cause common mode currents via external digital and analog equipment. Besides line frequency common mode currents, non-isolated digital outputs create digital pulse type common mode currents through externally connected equipment such as a computer.

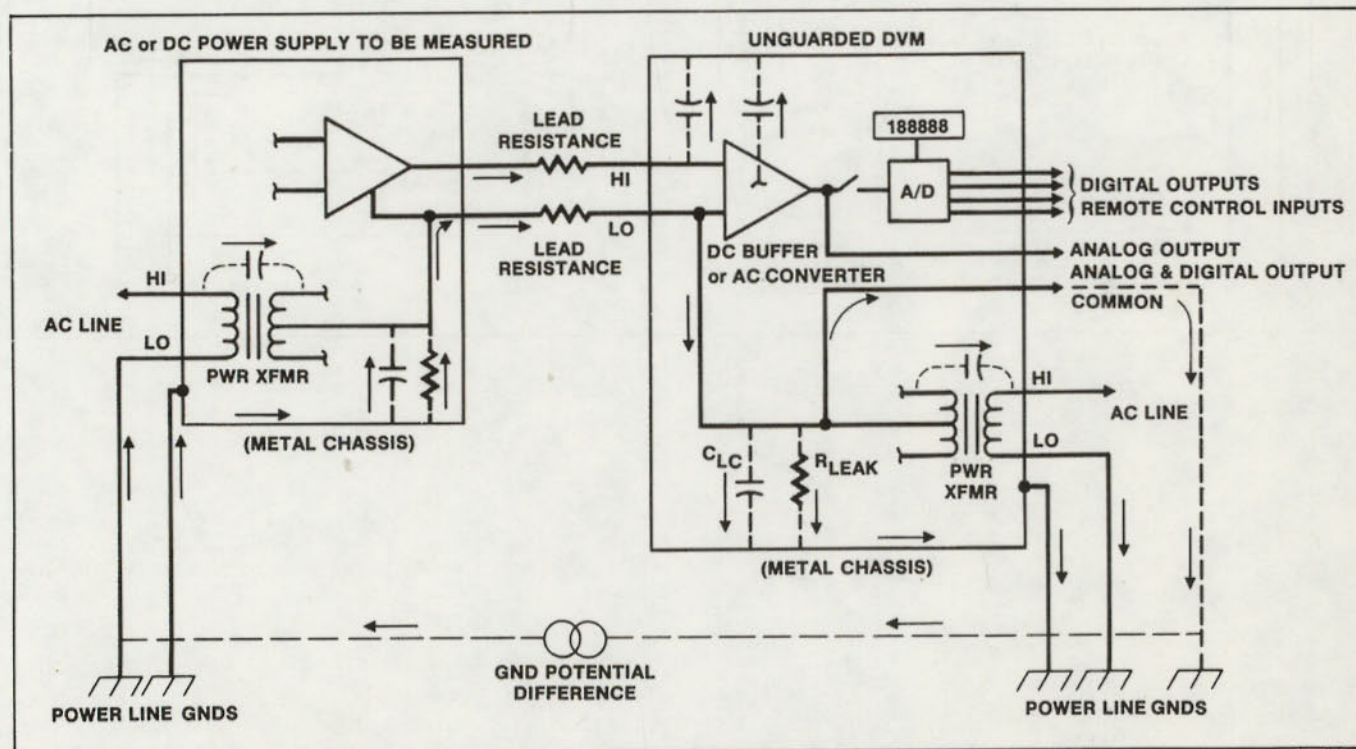

Figure 116.

How does the guard help?

By adding a guard shield (metal box within a box-type construction), the common mode current is reduced considerably but only when the guard is properly connected. (See Figure 117)

The guard shield also surrounds the secondary windings of the DVM power transformer utilizing a foil type shield with the secondary winding wound completely separately from the primary windings and other secondary windings that feed digital circuits outside of the guard. By doing this, the capacitance from the guarded secondary winding to the primary winding and the transformer core can be kept typically below one picofarad. This causes a reduction in the common mode current.

Another reduction in the common mode current effect can be made; however, it is up to the user to accomplish.

By attaching a third wire to the Guard terminal and to the Lo terminal of the source to be measured, a low impedance path has been formed that will shunt the remaining common mode current out of the Lo and Hi leads. Note that the Hi lead is not as sensitive to the common mode problem because it has less capacitance and leakage resistance to guard or chassis than does the Lo lead for most DVM's.

Common mode currents caused by digital outputs and remote control inputs are minimized by using guarded pulse transformers or photo isolators. Note that a good guarded DVM actually has three commons; Chassis Ground (Power Line Ground), Input Common (Lo), and Digital Output Common. Analog outputs are more costly to provide because they require a modulator/demodulator approach to a D to A converter approach to isolate the commons. This is why isolated analog outputs are not found on isolated (Guarded) DVM's.

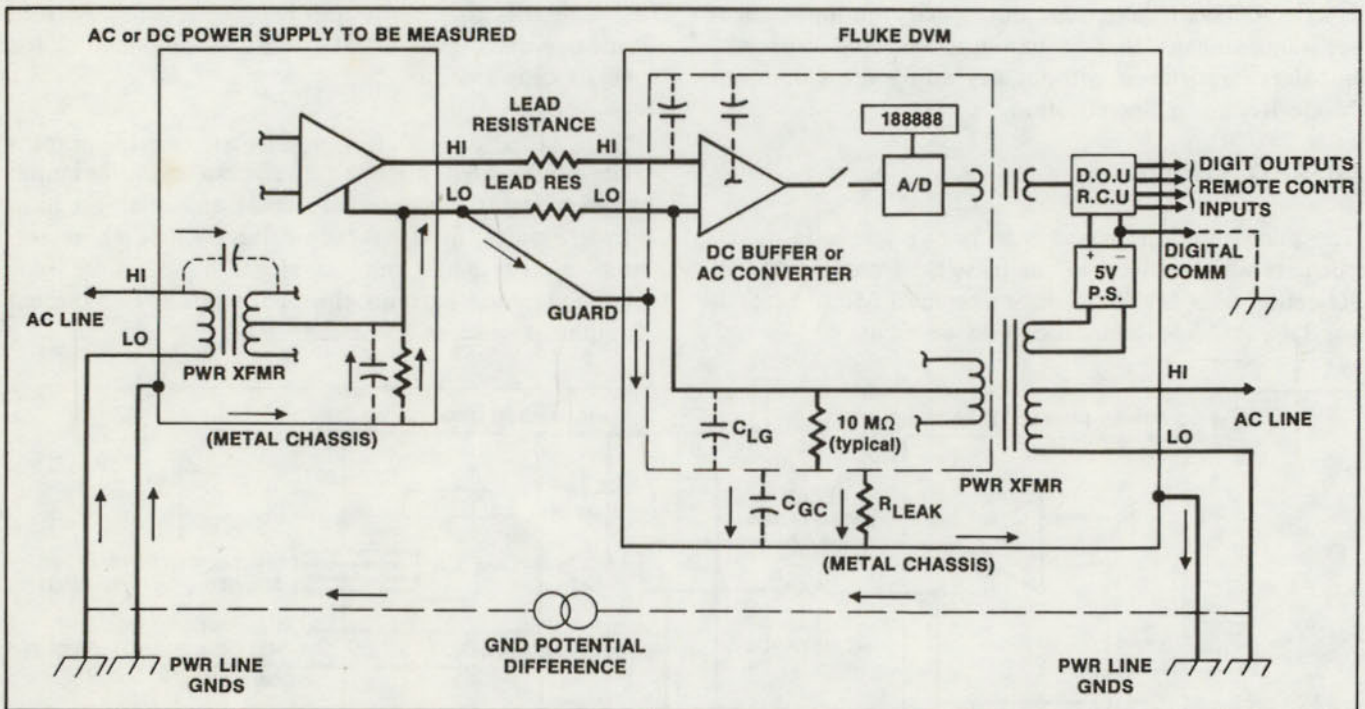

Figure 117.

Bibliography

NBS Special Publication 300 Vol. 3. *Precision Measurement and Calibration: Electricity—Low Frequency*: U.S. Department of Commerce/National Bureau of Standards 1968.

F.B. Silsbee. *Suggested Practices for Electrical Standardizing Laboratories*.

J.L. Thomas. *Precision Resistors and Their Measurement*.

W.J. Hamer. *Standard Cells, Their Construction, Maintenance and Characteristics*.

Clyde F. Coombs Jr. *Basic Electronic Instrument Handbook*: Copyright © 1972 McGraw-Hill, Inc.

NBS Monograph 140. *Time and Frequency: Theory and Fundamentals*: U.S. Department of Commerce/National Bureau of Standards 1974.

Byron E. Blair. *Time and Frequency Dissemination: an Overview of Principals and Techniques*.

B.F. Field and V.W. Hesterman. *The Josephson Junction Based Voltage Standard*: Reprint Courtesy U.S. Department of Commerce/National Bureau of Standards.

The Rise of the Calculable Capacitor: Copyright © 1975, Reprint Courtesy NBS/Dimension's Vol. 59 No. 12, Dec. 1975.

Criteria for Air Force Precision Measurement Equipment Laboratory, Design and Construction: AF Manual 88-4 Chpt. 10 June 1974.

Paul P.B. Brooks NBS Monograph 39. *Calibration Procedures for Direct-Current Resistance Apparatus*: U.S. Department of Commerce/National Bureau of Standards 1962.

Frank A. Laws, S.B. *Electrical Measurements*: Copyright © 1938, McGraw-Hill, Inc.

Rolf B.F. Schumacher. *Control Chart for Saturated Standard Cells*: Copyright © 1966 Institute of Electrical and Electronic Engineers, Reprint Courtesy IEEE/Transactions Vol. IM-15, No. 1-2 March-June 1966.

H.W. Carlson. *Philosophy of Calibration; Intercomparison of Standard Cells*: Reprint Courtesy John Fluke Mfg. Co., Inc.

Jan Slijper. *Advanced DC Calibration Techniques*: Reprint Courtesy John Fluke Mfg. Co., Inc.

Guarding of Digital Voltmeters, Digital Thermometers, and Calibrators: Application Bulletin 20. Reprint Courtesy John Fluke Mfg. Co., Inc.

7105A DC Voltage and Ratio Calibration System: Reprint Courtesy John Fluke Mfg. Co., Inc.

Precision Instrumentation: Reprint Courtesy John Fluke Mfg. Co., Inc.

Thermal Transfer Standards: Reprint Courtesy John Fluke Mfg. Co., Inc.

Accuracy and Specmanship: Reprint Courtesy John Fluke Mfg. Co., Inc.

