

# CEP7030L/CEB7030L

## N-Channel Logic Level Enhancement Mode Field Effect Transistor

### FEATURES

- 30V , 65A ,  $R_{DS(ON)}=8m\Omega$  @  $V_{GS}=10V$ .  
 $R_{DS(ON)}=12m\Omega$  @  $V_{GS}=4.5V$ .
- Super high dense cell design for extremely low  $R_{DS(ON)}$ .
- High power and current handling capability.
- TO-220 & TO-263 package.

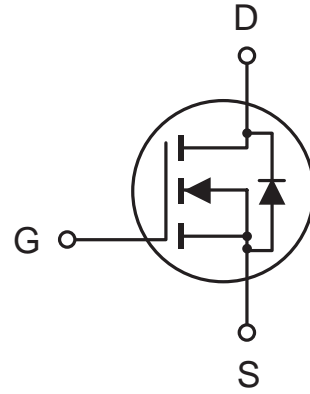
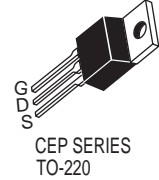

### ABSOLUTE MAXIMUM RATINGS (Tc=25°C unless otherwise noted)

Parameter	Symbol	Limit	Unit
Drain-Source Voltage	V <sub>DS</sub>	30	V
Gate-Source Voltage	V <sub>GS</sub>	±16	V
Drain Current-Continuous -Pulsed	I <sub>D</sub>	65	A
	I <sub>DM</sub>	180	A
Drain-Source Diode Forward Current	I <sub>S</sub>	65	A
Maximum Power Dissipation @Tc=25°C Derate above 25°C	P <sub>D</sub>	60	W
		0.4	W/°C
Operating and Storage Temperature Range	T <sub>J</sub> , T <sub>STG</sub>	-65 to 175	°C

### THERMAL CHARACTERISTICS

Thermal Resistance, Junction-to-Case	R <sub>θJC</sub>	2.5	°C/W
Thermal Resistance, Junction-to-Ambient	R <sub>θJA</sub>	62.5	°C/W

# CEP7030L/CEB7030L

## ELECTRICAL CHARACTERISTICS (Tc=25°C unless otherwise noted)

4

Parameter	Symbol	Condition	Min	Typ	Max	Unit
<b>OFF CHARACTERISTICS</b>						
Drain-Source Breakdown Voltage	BV <sub>DSS</sub>	V <sub>GS</sub> = 0V, I <sub>D</sub> = 250μA	30			V
Zero Gate Voltage Drain Current	I <sub>DSS</sub>	V <sub>DS</sub> = 30V, V <sub>GS</sub> = 0V			1	μA
Gate-Body Leakage	I <sub>GSS</sub>	V <sub>GS</sub> = ±16V, V <sub>DS</sub> = 0V			±100	nA
<b>ON CHARACTERISTICS<sup>a</sup></b>						
Gate Threshold Voltage	V <sub>GS(th)</sub>	V <sub>DS</sub> = V <sub>GS</sub> , I <sub>D</sub> = 250μA	1		3	V
Drain-Source On-State Resistance	R <sub>DS(ON)</sub>	V <sub>GS</sub> = 10V, I <sub>D</sub> = 35A		7.4	8	mΩ
		V <sub>GS</sub> = 4.5V, I <sub>D</sub> = 28A		10.6	12	mΩ
On-State Drain Current	I <sub>D(ON)</sub>	V <sub>GS</sub> = 10V, V <sub>DS</sub> = 10V	65			A
Forward Transconductance	g <sub>FS</sub>	V <sub>DS</sub> = 10V, I <sub>D</sub> = 35A		50		S
<b>DYNAMIC CHARACTERISTICS<sup>b</sup></b>						
Input Capacitance	C <sub>ISS</sub>	V <sub>DS</sub> = 15V, V <sub>GS</sub> = 0V f = 1.0MHz		2000		pF
Output Capacitance	C <sub>OSS</sub>			1011		pF
Reverse Transfer Capacitance	C <sub>RSS</sub>			131		pF
<b>SWITCHING CHARACTERISTICS<sup>b</sup></b>						
Turn-On Delay Time	t <sub>D(ON)</sub>	V <sub>DD</sub> = 15V, I <sub>D</sub> = 60A, V <sub>GEN</sub> = 10V R <sub>G</sub> = 1.8Ω		15		ns
Rise Time	t <sub>r</sub>			210		ns
Turn-Off Delay Time	t <sub>D(OFF)</sub>			30		ns
Fall Time	t <sub>f</sub>			55		ns
Total Gate Charge	Q <sub>g</sub>	V <sub>DS</sub> = 24V, I <sub>D</sub> = 60A, V <sub>GS</sub> = 10V		60	72	nC
Gate-Source Charge	Q <sub>gs</sub>			9		nC
Gate-Drain Charge	Q <sub>gd</sub>			20		nC

# CEP7030L/CEB7030L

## ELECTRICAL CHARACTERISTICS ( $T_c=25^\circ\text{C}$ unless otherwise noted)

4

Parameter	Symbol	Condition	Min	Typ	Max	Unit
<b>DRAIN-SOURCE DIODE CHARACTERISTICS<sup>a</sup></b>						
Diode Forward Voltage	$V_{SD}$	$V_{GS} = 0V, I_s = 35A$		0.93	1.3	V

### Notes

a. Pulse Test: Pulse Width  $\leq 300 \mu s$ , Duty Cycle  $\leq 2\%$ .

b. Guaranteed by design, not subject to production testing.

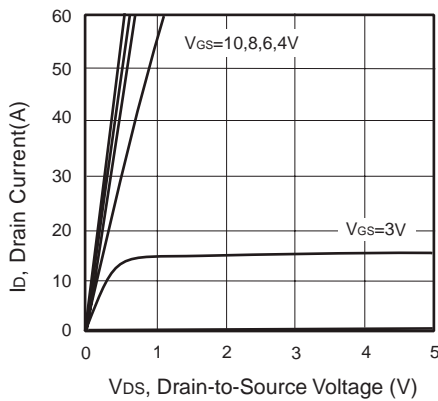

Figure 1. Output Characteristics

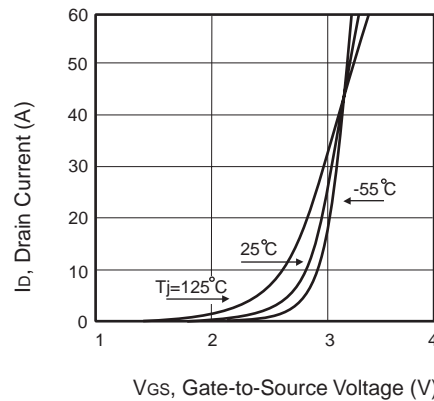

Figure 2. Transfer Characteristics

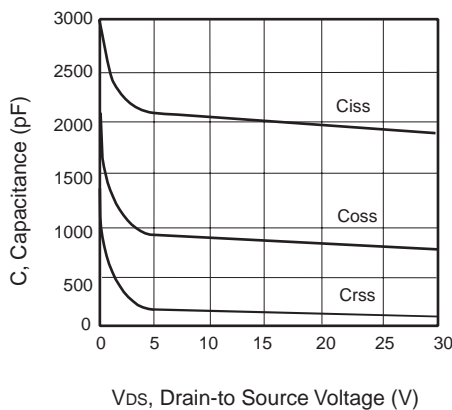

Figure 3. Capacitance

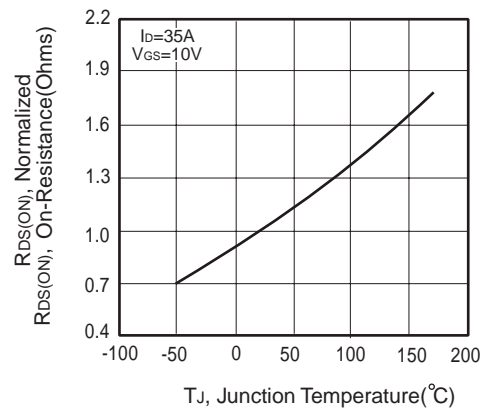
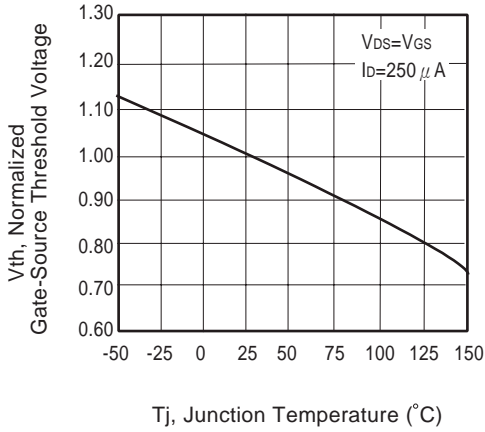

Figure 4. On-Resistance Variation with Temperature

# CEP7030L/CEB7030L

4



**Figure 5. Gate Threshold Variation with Temperature**

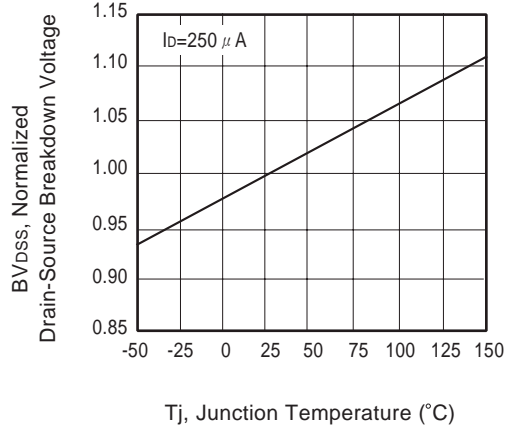

**Figure 6. Breakdown Voltage Variation with Temperature**

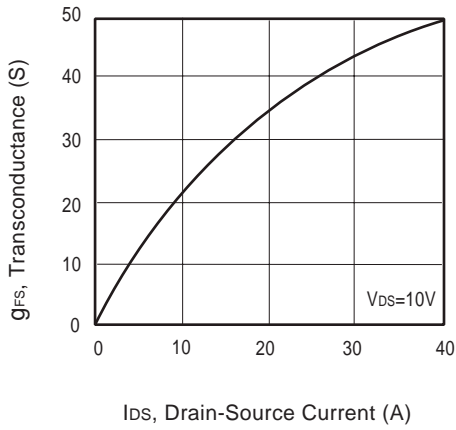

**Figure 7. Transconductance Variation with Drain Current**

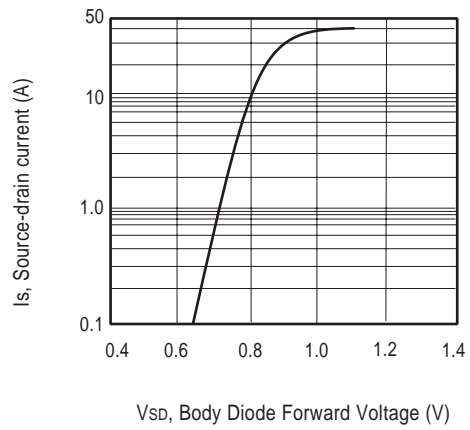

**Figure 8. Body Diode Forward Voltage Variation with Source Current**

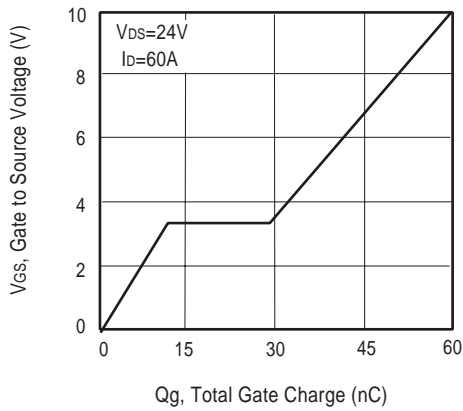

**Figure 9. Gate Charge**

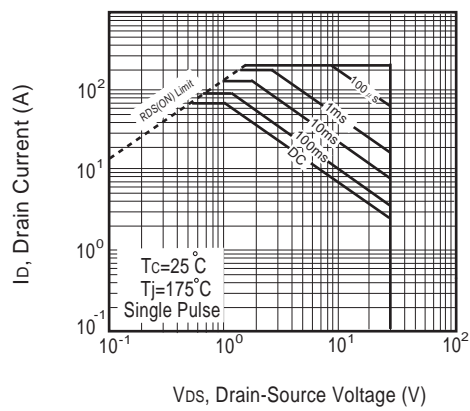

**Figure 10. Maximum Safe Operating Area**

# CEP7030L/CEB7030L

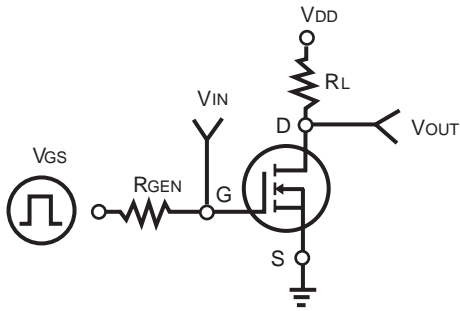

Figure 11. Switching Test Circuit

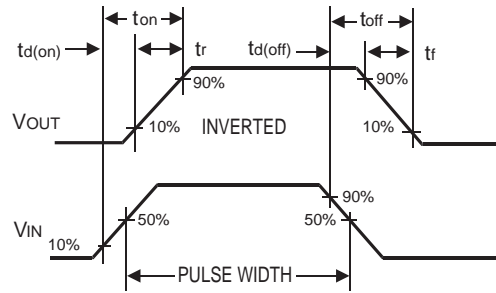

Figure 12. Switching Waveforms

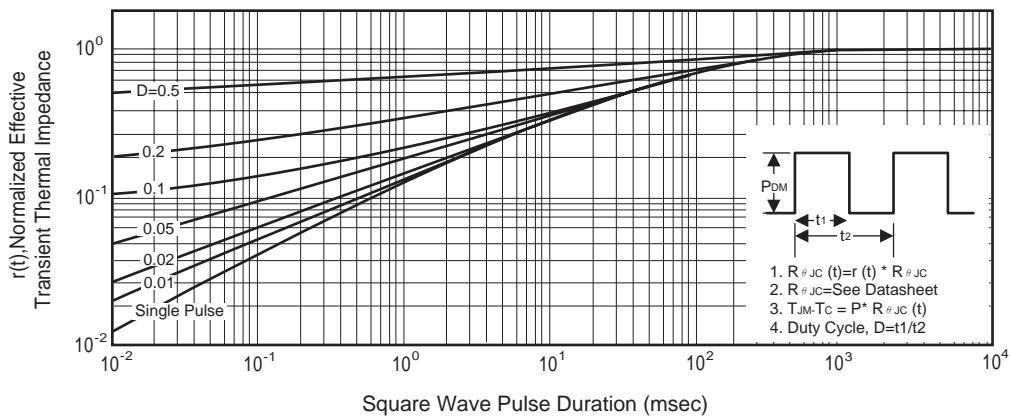

Figure 13. Normalized Thermal Transient Impedance Curve