

NBS
PUBLICATIONS

A11102 696988

U.S. DEPARTMENT OF
National Bureau of Standards

NAT'L INST OF STANDARDS & TECH R.I.C.



A11102696988

Field, Bruce F/Solid-state voltage stand
QC100 .U5753 NO.1239 1987 1987 C.2 NBS-P

NBS Technical Note 1239

*Solid-State Voltage Standard
Performance and Design Guidelines*

Bruce F. Field

National Bureau of Standards

QC
100
.U5753
No.1239
1987
C.2

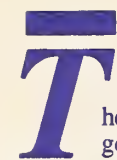

The National Bureau of Standards¹ was established by an act of Congress on March 3, 1901. The Bureau's overall goal is to strengthen and advance the nation's science and technology and facilitate their effective application for public benefit. To this end, the Bureau conducts research to assure international competitiveness and leadership of U.S. industry, science and technology. NBS work involves development and transfer of measurements, standards and related science and technology, in support of continually improving U.S. productivity, product quality and reliability, innovation and underlying science and engineering. The Bureau's technical work is performed by the National Measurement Laboratory, the National Engineering Laboratory, the Institute for Computer Sciences and Technology, and the Institute for Materials Science and Engineering.

The National Measurement Laboratory

Provides the national system of physical and chemical measurement; coordinates the system with measurement systems of other nations and furnishes essential services leading to accurate and uniform physical and chemical measurement throughout the Nation's scientific community, industry, and commerce; provides advisory and research services to other Government agencies; conducts physical and chemical research; develops, produces, and distributes Standard Reference Materials; provides calibration services; and manages the National Standard Reference Data System. The Laboratory consists of the following centers:

- Basic Standards²
- Radiation Research
- Chemical Physics
- Analytical Chemistry

The National Engineering Laboratory

Provides technology and technical services to the public and private sectors to address national needs and to solve national problems; conducts research in engineering and applied science in support of these efforts; builds and maintains competence in the necessary disciplines required to carry out this research and technical service; develops engineering data and measurement capabilities; provides engineering measurement traceability services; develops test methods and proposes engineering standards and code changes; develops and proposes new engineering practices; and develops and improves mechanisms to transfer results of its research to the ultimate user. The Laboratory consists of the following centers:

- Applied Mathematics
- Electronics and Electrical Engineering²
- Manufacturing Engineering
- Building Technology
- Fire Research
- Chemical Engineering³

The Institute for Computer Sciences and Technology

Conducts research and provides scientific and technical services to aid Federal agencies in the selection, acquisition, application, and use of computer technology to improve effectiveness and economy in Government operations in accordance with Public Law 89-306 (40 U.S.C. 759), relevant Executive Orders, and other directives; carries out this mission by managing the Federal Information Processing Standards Program, developing Federal ADP standards guidelines, and managing Federal participation in ADP voluntary standardization activities; provides scientific and technological advisory services and assistance to Federal agencies; and provides the technical foundation for computer-related policies of the Federal Government. The Institute consists of the following divisions:

- Information Systems Engineering
- Systems and Software Technology
- Computer Security
- Systems and Network Architecture
- Advanced Computer Systems

The Institute for Materials Science and Engineering

Conducts research and provides measurements, data, standards, reference materials, quantitative understanding and other technical information fundamental to the processing, structure, properties and performance of materials; addresses the scientific basis for new advanced materials technologies; plans research around cross-cutting scientific themes such as nondestructive evaluation and phase diagram development; oversees Bureau-wide technical programs in nuclear reactor radiation research and nondestructive evaluation; and broadly disseminates generic technical information resulting from its programs. The Institute consists of the following Divisions:

- Ceramics
- Fracture and Deformation³
- Polymers
- Metallurgy
- Reactor Radiation

¹Headquarters and Laboratories at Gaithersburg, MD, unless otherwise noted; mailing address Gaithersburg, MD 20899.

²Some divisions within the center are located at Boulder, CO 80303.

³Located at Boulder, CO, with some elements at Gaithersburg, MD

11-2
QC100
4-27-83
10-12-89
1987
C.2

NBS Technical Note 1239

Solid-State Voltage Standard Performance and Design Guidelines

Bruce F. Field

Electricity Division
Center for Basic Standards
National Measurement Laboratory
National Bureau of Standards
Gaithersburg, MD 20899

September 1987

Sponsored in part by:
DC and Low Frequency Subgroup of the Calibration
Coordination Group, Department of Defense



U.S. Department of Commerce
Clarence J. Brown, Acting Secretary

National Bureau of Standards
Ernest Ambler, Director

National Bureau of Standards
Technical Note 1239
Natl. Bur. Stand. (U.S.),
Tech. Note 1239
26 pages (Sept. 1987)
CODEN: NBTNAE

U.S. Government Printing Office
Washington: 1987

For sale by the Superintendent
of Documents,
U.S. Government Printing Office,
Washington, DC 20402

TABLE OF CONTENTS

	page
List of Figures.....	iv
List of Tables.....	iv
I. Introduction.....	1
II. Performance Guidelines.....	2
P1. Long-term drift (stability) of the voltage outputs.....	2
P2. Sensitivity of the voltage outputs to power interruptions.....	4
P3. Noise on the voltage outputs.....	7
P4. Temperature coefficient of the voltage outputs.....	7
P5. Regulation of the voltage outputs with respect to the supply voltage.....	9
P6. Load regulation of the voltage outputs.....	10
P7. Change of the voltage outputs with ac imposed on the output terminals.....	10
P8. Operating time under battery power.....	11
P9. Recovery time of the voltage outputs after transport.....	12
P10. Electrical isolation of the voltage outputs.....	12
P11. Protection of the voltage outputs.....	13
P12. Battery recharge time.....	13
P13. Adjustment range of the voltage outputs.....	13
P14. Terminal posts for the voltage outputs.....	13
P15. Environmental operating conditions.....	14
P16. Physical shock during shipment.....	14
P17. Weight.....	15
P18. Panel indicators.....	15
P19. Battery life.....	15
P20. Provision for an extra battery.....	16
P21. Compliance with electrical safety standards.....	16
III. Design Guidelines.....	16
D1. Multiple independent references.....	16
D2. Independence of multiple outputs.....	17
D3. Quality of the 1.018 V output.....	17
D4. Isolation.....	17
IV. Conclusions.....	18
References.....	21

LIST OF FIGURES

Figure	page
1. Long term drift of a typical 10 V standard	3
2. Detail of structure in the voltage output of a typical 10 V standard.....	3
3. NBS measurements of the ten volt outputs of two temperature-controlled standards	5
4. NBS measurements of the ten volt outputs of two temperature-controlled standards	6
5. Measurements of ten volt outputs of a nontemperature-controlled standard	6
6. Deviation of the ten volt outputs of a temperature-controlled standard when subjected to changes in ambient temperature.....	8
7. Deviation of the ten volt output of a nontemperature-controlled standard when subjected to changes in ambient temperature	8
8. Change of the ten volt output of a non-temperature controlled standard when switched from ac mains to batter operation at time 0	9
9. Test circuit for measuring the sensitivity of an unknown solid-state standard to ac generated by the measuring instrument.....	11

LIST OF TABLES

Table	page
I. List of Guidelines	2
II. Summary of Performance Goals	19

Solid-State Voltage Standard Performance and Design Guidelines

BRUCE F. FIELD

I. INTRODUCTION

OVER the past six years the Electricity Division has examined and analyzed the performance of nearly all high-quality commercially-available solid-state (Zener) voltage standards. Based on our observations to date we offer the following set of design guidelines to define what we believe is required in a modern solid-state voltage standard to supplement or replace current standards using saturated cadmium-sulfate standard cells. This document is not a complete specification for a voltage standard but the ideas contained herein should be considered when defining the requirements for a voltage standard. It should also not be inferred that any standards that meet the requirements of this document are necessarily endorsed by NBS as the best or only suitable standards available.

For our purpose here we define a voltage standard as a complete instrument in one box that is based on a solid-state reference, is powered by the ac line or internal batteries, and continuously produces one or more stable voltages. This note presents guidelines that describe two types of solid-state standards with outputs at the 10 V and 1.018 V levels. The first type is a laboratory standard intended for maintenance of a local unit of voltage, while the second is a transport standard designed for comparing two laboratory units of voltage at the 10 V and 1.018 V levels. The laboratory standard is intended to be used as part of a group of like standards to maintain a unit of voltage at the 10 V level to an accuracy of 0.3 ppm (1σ) after corrections have been applied for drift of the standard, and the transportable standard is to be used to transfer a unit of voltage between laboratories to an accuracy of 0.1 ppm (1σ). (All uncertainties in this note are expressed as one standard deviation estimates.)

The guidelines have been divided into two categories, one describing the operational performance of a standard and the second describing important circuit design considerations. The performance guidelines identify the important characteristics of standards such as voltage output stability, output noise, battery life, weight, etc. In the discussion of the performance guidelines we generally do not recommend a particular design for the circuitry of the standard, we only consider the end performance. However, there are several qualities we consider important in the design of the electrical circuitry and these are discussed as design guidelines. Table I is a list of all the guidelines in approximate order of importance.

For each performance guideline a specific goal has been developed to serve as a guide for writing a detailed solid-state voltage standard specification and also as a guide to anyone evaluating such a standard. Certain goals have been made intentionally stringent because either they are additive in nature or they are easily achievable with present technology. We believe that most of the goals described here are attainable using present technology. Where appropriate, differing goals between the laboratory standard and transport standard are noted in the discussion of the guideline. A summary of all the performance goals is given in Table II at the end of the paper.

TABLE I
List of Guidelines

Performance

- P1. Long-term drift (stability) of the voltage outputs.
- P2. Sensitivity of the voltage outputs to power interruptions.
- P3. Noise on the voltage outputs.
- P4. Temperature coefficient of the voltage outputs.
- P5. Regulation of the voltage outputs with respect to the supply voltage.
- P6. Load regulation of the voltage outputs.
- P7. Change of the voltage outputs with ac imposed on the output terminals.
- P8. Operating time under battery power.
- P9. Recovery time of the voltage outputs after transport.
- P10. Electrical isolation of the voltage outputs.
- P11. Protection of the voltage outputs.
- P12. Battery recharge time.
- P13. Adjustment range of the voltage outputs.
- P14. Terminal posts for the voltage outputs.
- P15. Environmental operating conditions.
- P16. Physical shock during shipment.
- P17. Weight.
- P18. Panel indicators.
- P19. Battery life.
- P20. Provision for an extra battery.
- P21. Compliance with electrical safety standards.

Design

- D1. Multiple independent references.
 - D2. Independence of multiple outputs.
 - D3. Quality of the 1.018 V output.
 - D4. Electrical isolation.
-

II. PERFORMANCE GUIDELINES

- P1. *Long-term drift (stability) of the voltage outputs.*

Goal P1: The long term drift of each reference should be less than 2 ppm/year at 10 V with day-to-day variations less than 0.1 ppm.

A standard with a stable low-drift output voltage is essential when the standard is to be used to maintain a local laboratory unit of voltage. Although we have observed that the drifts of most standards are generally linear and predictable, a standard with a large drift may require that it be periodically adjusted or that corrections be applied to the data. Presently-available standards are capable of stabilities of ± 4 ppm/year or better at the 10 V level. Figure 1 shows the stability performance of the 10 V output of a typical commercial standard. This particular standard has a drift of +0.95 ppm/year with a residual standard deviation of the fitted line of 0.07 ppm.

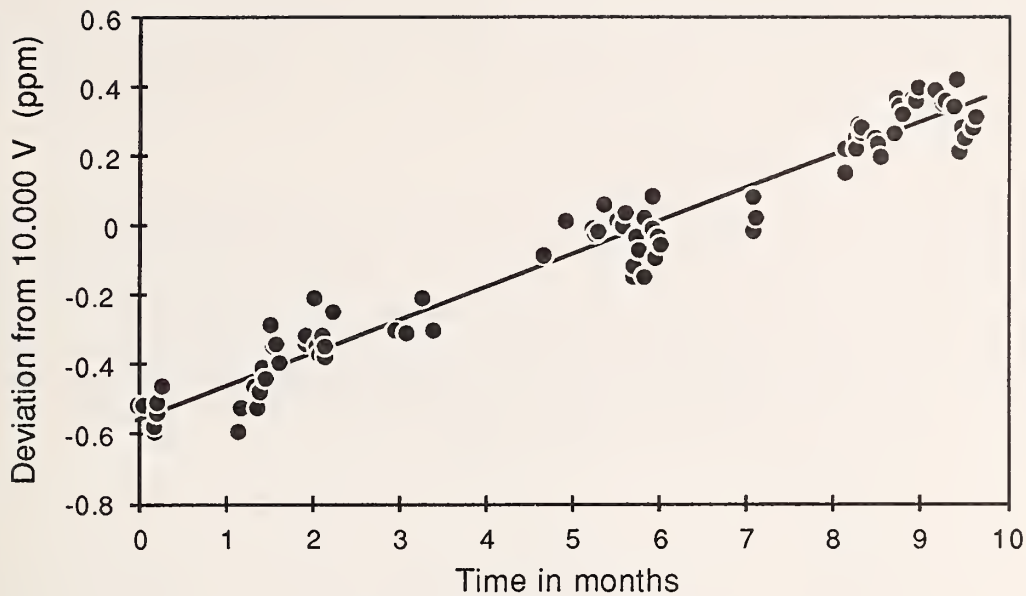

Fig. 1. Long term drift of a typical 10 V standard.

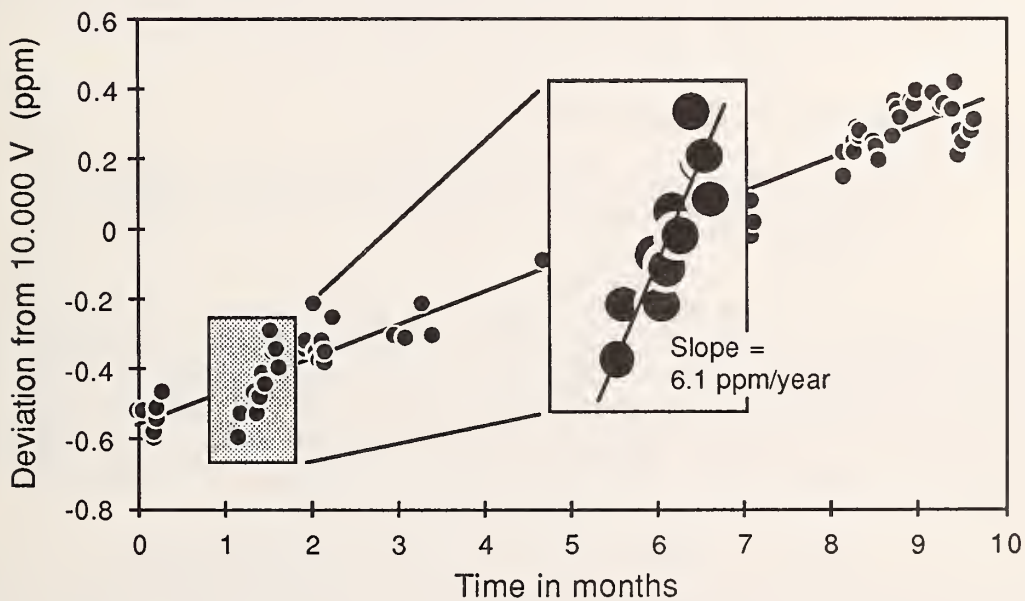

Fig. 2. Detail of structure in the voltage output of a typical 10 V standard.

As can be seen in Fig. 1 there is additional structure in the output voltage that produces day-to-day variations of up to several tenths of a part-per-million from the general drift line. This is typical of most standards tested but the cause is not yet understood. For best accuracy in deter-

mining the stability of the standard it should be monitored for at least six months to predict an annual drift rate. Figure 2 illustrates what can happen if insufficient data are used. Using data taken over a three week period between months 1 and 2, a slope of +6.1 ppm/year is calculated, but this is in error by a factor of six! (In fact for this example no one month period of data comes close to predicting the annual drift rate.) This day-to-day variation in the output makes it difficult to accurately predict an annual drift rate with much less than six months of data. (This problem also exists with standard cells!)

Most standards tested exhibited fairly linear drift rates. For each standard used as part of a volt maintenance procedure the drift rate should be accurately determined by long-term measurements and periodic corrections applied to the value of the standards to correct for the expected drift. If instead each standard is assumed constant between calibrations an additional uncertainty must be added due to its drift. Data to date show that the drift rate of most standards is considerably larger than the uncertainties of the drift corrections, thus the uncertainty of maintaining a volt at the 10 V level can be reduced substantially, usually from about 2 ppm to better than 0.5 ppm, by correcting for the expected drift.

In all presently-available commercial standards the 1.018 V (and 1 V) outputs are derived from the 10 V output using internal resistive dividers. The 1.018 V (and 1 V) outputs of most standards have been found to be significantly less stable and have more day-to-day variation than the 10 V outputs. Drift rates are typically 2 or 3 times worse than the drift rate of the 10 V output. Two standards have been observed for which the 1.018 V output drifted at a rate of greater than 1 ppm/week while the 10 V output showed random variations of 0.2 ppm with no detectable drift. For presently-available standards we do not recommend that the 1.018 V outputs be used as a general replacement for standard cells. One exception is the use of the 1.018 V output as a transfer standard where it is carefully calibrated and used within a short period of time (<1 day).

P2. *Sensitivity of the voltage outputs to power interruptions.*

Goal P2: Voltage output shifts resulting from power interruptions or abrupt ambient temperature changes of 20 °C or less should be less than 0.1 ppm.

Although standards based on Zener diodes generally perform best if the diode is continuously powered and kept at a constant temperature, it is likely, especially during shipment, that the standard will occasionally lose power. In addition to the interruption of current to the diode, the temperature-controlled oven (if there is one) may cool to ambient temperature. The power loss may be due to lengthy shipping times or an extended ac power outage in the laboratory. If this happens it is necessary that after restoration of ac power the standard return to exactly the same voltage it had before the power outage occurred.

We have conducted power interruption tests on a number of commercial standards and have found that the magnitude of the observed voltage shift is vaguely dependent on the individual standard rather than the type of standard being tested; some standards consistently showed small changes while others exhibited changes as large as 2 ppm [1,2].

Figure 3 shows NBS measurements of the 10 V outputs of two temperature-controlled standards. During the two gaps the standards were shipped to (and returned from) another laboratory with the oven turned off during shipment. We estimate the units were off power for approximately 8 hours during each shipment. The first one or two points of SN 10 starting at 3 months and possibly the first six points at 4.6 months may be inconsistent with the remaining points and likely indicate a change and recovery of the standard. Fitting straight lines to the two

sets of data (excluding the two points at 3 months) yield residual standard deviations of 0.100 ppm and 0.052 ppm for SN 10 and SN 11, respectively. Examining the deviations of the individual points from the fitted lines, we conclude that except for the initial recovery of SN 10 there is no indication that the standards were significantly affected (<0.1 ppm) by the shipping process.

A second test on the same two temperature-controlled standards was conducted by carefully calibrating their 10 V output in terms of the U.S. Legal Volt for a five-day period, abruptly removing the power and allowing the ovens to cool to room temperature for a two-day period (typically Saturday and Sunday), and then restoring the power Monday morning and repeating the process six times. The first six points for each of the standards in Fig. 4 represent the mean of the five (approximately) measurements. After the sixth week, the standards were shipped to other laboratories with the power turned off during shipment. The last four points of Fig. 4 are the calibrations while at NBS. Each point represents the mean of from 11 to 64 daily measurements. Least-square lines were fitted to the data where each point was weighted inversely proportional to the number of daily measurements. The residual standard deviations based on an average of ten daily measurements are 0.049 and 0.045 ppm for SN's 10 and 11, respectively.

One nontemperature-controlled standard was tested by cooling the standard from room temperature (23°C) to approximately 4°C and holding it there for about 10 hours with the power removed. Measurements were begun one day after resumption of power to the standard and its return to room temperature. Figure 5 summarizes the results of the test. The 10 V output of the standard showed a consistent increase in value after each outage but the magnitude of the shift was unpredictable.

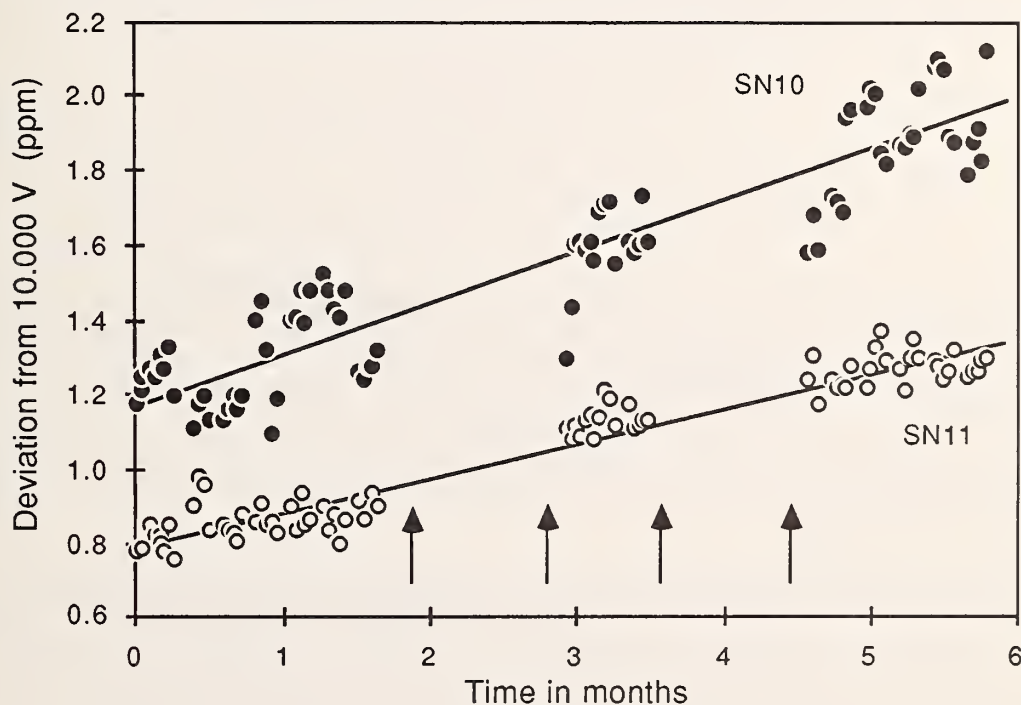

Fig. 3. NBS measurements of the ten volt outputs of two temperature-controlled standards. The standards were shipped via air freight to another laboratory and returned to NBS at the times indicated by the arrows. During all four shipments the power was turned off.

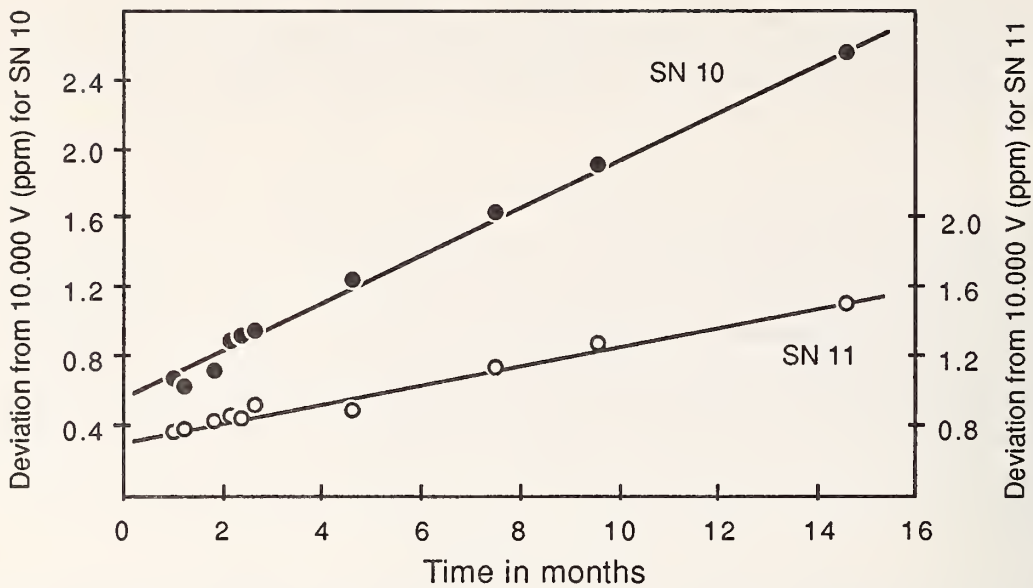

Fig. 4. NBS measurements of the ten volt outputs of two temperature-controlled standards. Each point represents the mean of a number of measurements. For the first six points the power was turned off between each point to simulate the shipping environment. The standards were shipped air freight to several laboratories between the latter four points.

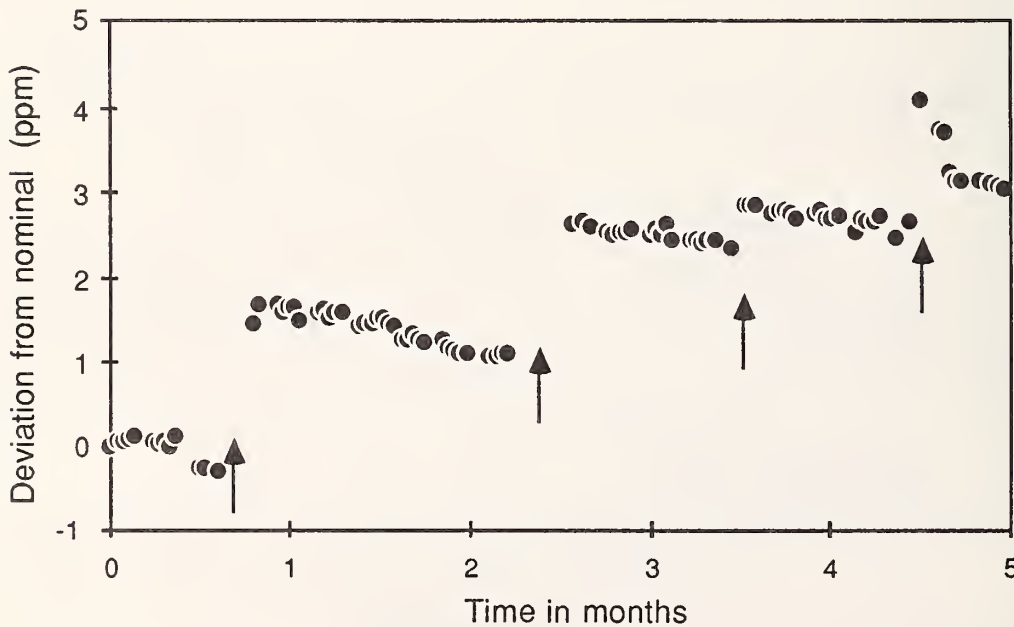

Fig. 5. Measurements of ten volt outputs of a nontemperature-controlled standard. At the times indicated by the arrows, power was removed from the unit and it was cooled to 4 °C for approximately 10 hours. Measurements were resumed after the unit was returned to room temperature (23 °C).

Almost all standards tested (temperature-controlled or not) showed non-reproducible shifts when subjected to power interruptions and abrupt temperature changes. Although it was not generally possible to predict exactly the direction and magnitude of the shift, several standards consistently showed small random shifts, <0.1 ppm. Such a value could be used for these standards as a reliable estimate of the uncertainty caused by power interruptions.

P3. *Noise on the voltage outputs.*

Goal P3: Noise output of any voltage output should be <0.1 ppm rms in a bandwidth of 0.01 - 10 Hz. Day-to-day variations (where sufficient measurements are averaged to negligibly reduce short-term noise) should be less than 0.1 ppm (1σ).

Measurement errors caused by self-generated noise on the voltage standard outputs in the frequency range 0.01 - 10 Hz (short-term noise) can be reduced by having the measuring system integrate the signal over a suitable period. Noise produced at higher frequencies is (or should be) rejected by the measuring system. Noise in the frequency range 0.00001 - 0.01 Hz (day-to-day scatter) in some cases may be reduced by averaging measurements of the standard over several days, but for many tests it must be included as part of the uncertainty of the standard. Available standards typically limit the noise at the output terminals to <0.1 ppm (<1 μ V rms on the 10 V range, and <0.1 μ V rms on the 1.018 V range) in a bandwidth of 0.01 - 10 Hz which is consistent with the day-to-day scatter observed for most standards [4-6]. The short term noise should be smaller than the day-to-day scatter of the standard so as not to contribute significantly to the latter. Special tests may be required to ensure that all parts of the measuring system are insensitive to noise produced in any other part of the measuring system.

P4. *Temperature coefficient of the voltage outputs.*

Goal P4: The temperature coefficient of any voltage output should be less than 0.01 ppm/ $^{\circ}$ C.

Standards intended for use in a laboratory environment (± 2 $^{\circ}$ C) should have temperature coefficients of the output voltages of 0.01 ppm/ $^{\circ}$ C or less to preclude the necessity of applying temperature corrections. This can be readily achieved with temperature-controlled standards. Figure 6 shows the temperature dependence of the 10 V output of a typical temperature-controlled standard. An additional allowance will usually have to be included for the 1.018 V output because of the temperature coefficient of the resistive divider. Including the divider in the oven will minimize the temperature coefficient and eliminate any temperature hysteresis effect of the resistors.

Figure 7 shows the temperature dependence of the 10 V output of a typical nontemperature-controlled standard with respect to the ambient temperature. The standard is designed to have a zero-temperature-coefficient at normal room temperature but does not meet goal P4. Nontemperature-controlled standards may also have compensation circuits to monitor the ambient temperature and apply an electrical correction to the output voltage. This can be done with reasonable success over a limited temperature range. But, nontemperature-controlled standards may be affected by large abrupt changes in ambient temperature causing their output to permanently change. Any nontemperature-controlled standard intended for transport should be checked for this property.

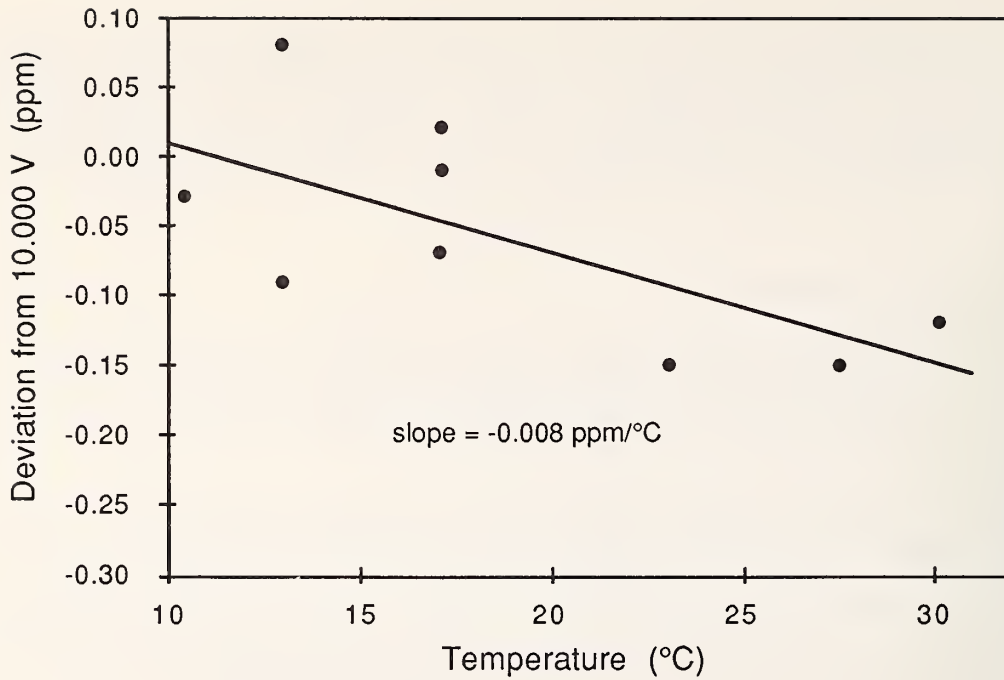

Fig. 6. Deviation of the ten volt output of a temperature-controlled standard when subjected to changes in ambient temperature.

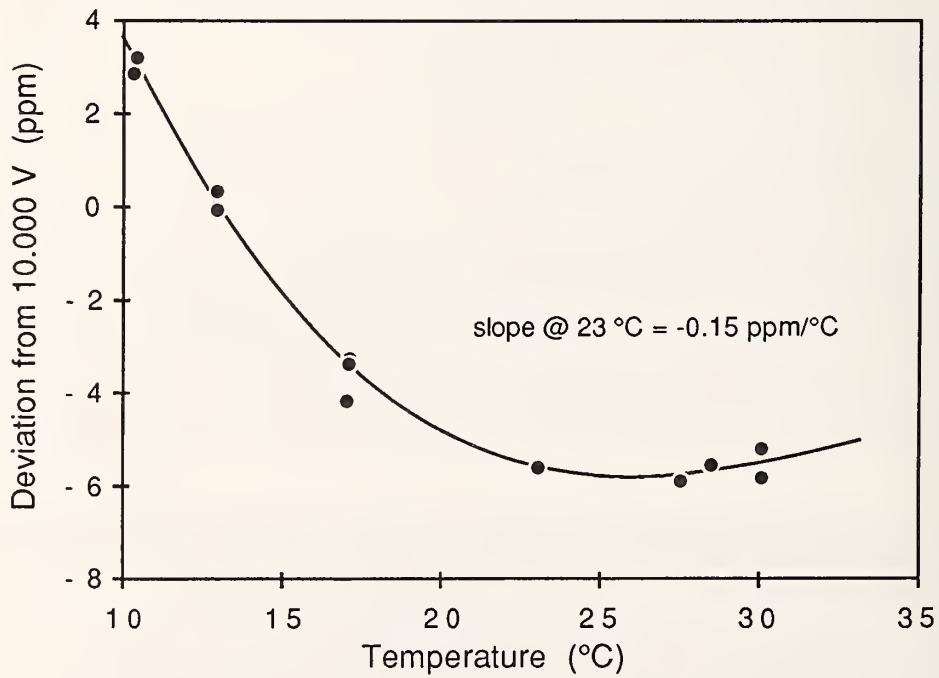

Fig. 7. Deviation of the ten volt output of a nontemperature-controlled standard when subjected to changes in ambient temperature.

P5. Regulation of the voltage outputs with respect to the supply voltage.

Goal P5: The maximum change in any output voltage should be 0.01 ppm or less over the supply voltage range (ac and battery) of the standard.

Specifications for the maximum change in the output voltages of presently-available standards are typically 0.05 ppm or less for a momentary or prolonged change in the ac mains voltage anywhere within the operating range specified for the standard. In some cases a small settling time is also specified. If the standard is to be operational at full accuracy under battery power then the supply regulation specification must also apply to battery operation. A light or other indicator should be included to indicate when the battery voltage is sufficient for the standard to be within specifications. For highest-accuracy standards, supply-regulation-dependence should be 0.01 ppm or less over the operating range.

Figure 8 demonstrates a typical change in a nontemperature-controlled standard when it is unplugged from the ac mains at time 0 and allowed to run from its internal batteries. In this case we believe the initial drift during the first hour is due to cooling of the power transformer within the standard as the output voltage is not correlated with the supply voltage. A similar but opposite change is observed when the standard is reconnected to ac power.

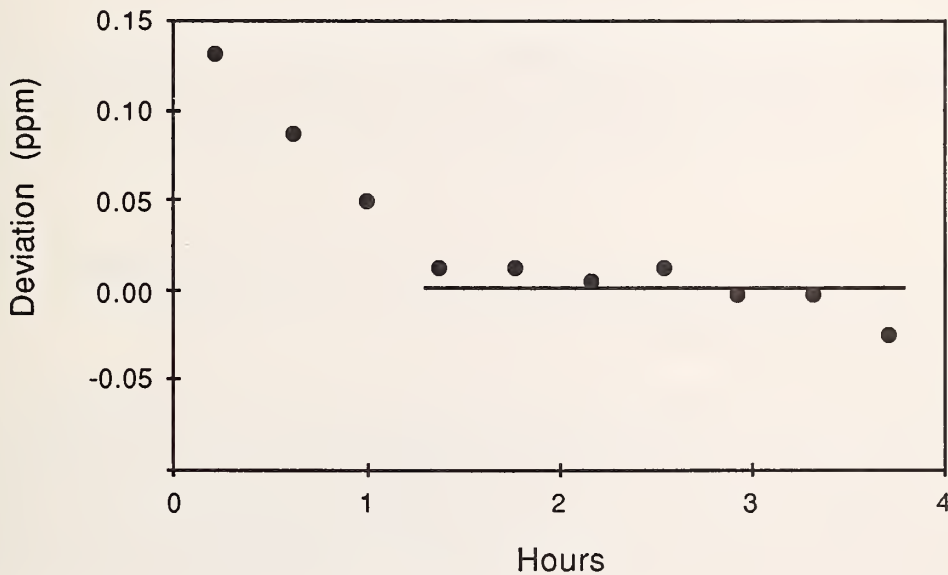

Fig. 8. Change of the ten volt output of a nontemperature-controlled standard when switched from ac mains to battery operation at time 0.

P6. *Load regulation of the voltage outputs.*

Goal P6: The output resistance of the 10 V range should be 0.001 Ω or less with a 2 mA current capability for a laboratory standard and less than 1 k Ω for a transport standard. Output resistance of the 1.018 V range should be 1 k Ω or less. The output resistances of all ranges should be specified by the manufacturer so that the user may apply a loading correction if desired.

All presently-available commercial standards use a buffer amplifier to provide a low resistance output at the 10 V level which is capable of supplying or sinking 2 to 10 mA. The 10 V output may be used in a limited manner to accurately drive a Kelvin-Varley divider for calibration purposes.

Available standards specify output resistances from 0.005 to $\leq 0.5 \Omega$. Connecting a 100 k Ω Kelvin-Varley divider to the 10 V tap of a standard with a 0.005 Ω output resistance will change the output 0.05 ppm, while a standard with an output resistance of 0.5 Ω will change 5 ppm. We have observed that even standards with output resistances as high as 0.5 Ω provide a stable, albeit different, output voltage when driving a divider. But, caution must be used if the standard is calibrated without the divider and then used with the divider to calibrate other instruments. In this situation it is preferable to leave the divider permanently attached and calibrate the standard through the Kelvin-Varley, i.e., set the divider to 0.999999X and use the output of the divider. Small errors from voltage drops in the input leads to the divider are also cancelled using this method.

The 1.018 V outputs of standards are generally derived from the 10 V outputs by internal resistive dividers with typical output resistances from 800 to 1000 Ω . Thus no loading is permitted on the 1.018 V output – all measurements should be done using a potentiometric method.

P7. *Change of the voltage outputs with ac imposed on the output terminals.*

Goal P7: All voltage outputs should exhibit a change of less than 0.01 ppm when a DVM (8 mV noise pk-pk, 1 kHz - 5 MHz BW) is connected to that output.

Diodes and other non-linear elements in the circuitry can rectify ac noise introduced at the output terminals from external sources such as digital voltmeters [3]. This can produce a substantial dc shift in the output voltage of the standard when the noise source is connected to the standard. These shifts have been observed using the monitoring system shown in Fig. 9. A digital voltmeter was used as the measuring instrument shown in the figure and was alternately connected and disconnected to the standard under test while null detector (D) was monitored. The null detector must be known to be insensitive to ac for this test; a mechanical galvanometer is recommended. Additionally a filter may be added at the output of the divider to reduce ac coupling to the detector and the standard cell. A number of standards were tested and showed changes in the range of <0.01 ppm to 30 ppm. In each case the outputs immediately returned to their original values when the digital voltmeter was disconnected from the circuit. The voltmeter used for this test was a common 6-1/2 digit model that produced approximately 8 mV of noise peak-peak in the 1 kHz to 5 MHz frequency band.

This problem can introduce a nearly undetectable systematic error in a calibration process if the user is unaware of it. Suppose the standard is calibrated in the calibration laboratory against standard cells using passive apparatus with presumably little ac noise; the "correct" value is thus obtained. If later the standard is used on the production line to calibrate a digital voltmeter, the

standard's output shifts because of ac noise produced by the voltmeter and the voltmeter reading is in error. We found that the dc changes produced by individual instruments (e.g. voltmeters) are extremely reproducible from day-to-day and thus reproducible measurements cannot be taken as a sign that there is no problem.

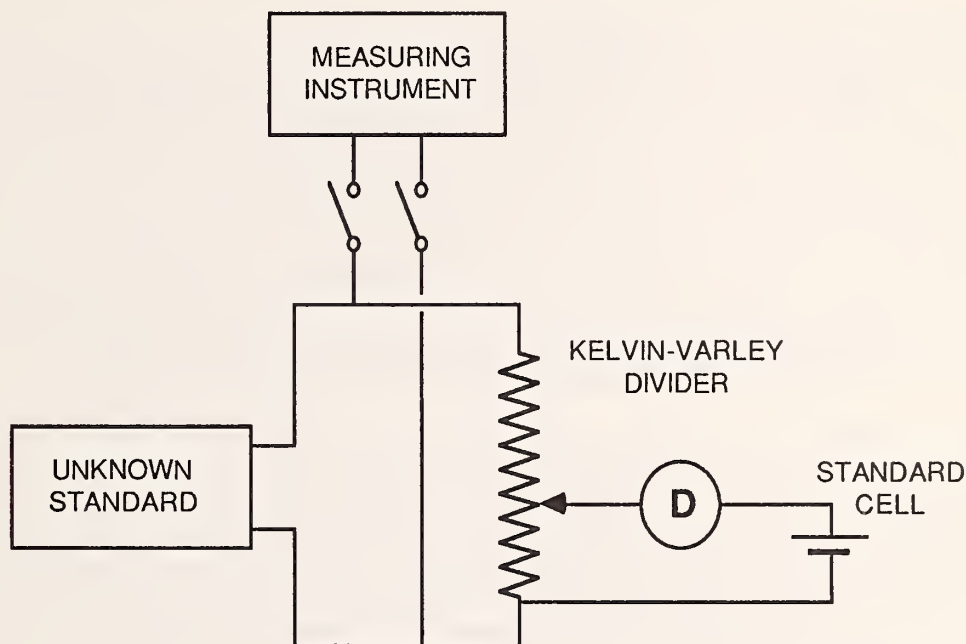

Fig. 9. Test circuit for measuring the sensitivity of an unknown solid-state standard to ac generated by the measuring instrument.

P8. *Operating time under battery power.*

Goal P8: The battery should supply power for operation of a transport standard for 72 hours at a 20 °C ambient temperature.

Laboratory standards may require battery operation for maintenance of the standard during laboratory ac power outages to prevent unpredictable shifts in the outputs, or for special tests that require the standard to be completely isolated from the ac mains and/or ground. The duration of power outages is unpredictable of course, but an 8 to 24 hour battery operating time would seem reasonable. Special tests involving the standards may impose other battery operating conditions and require a more lengthy battery operating time.

Transport standards that are to be shipped under battery power via air freight will need considerably longer battery operating times. Our experience with transporting three standards within the United States via several guaranteed 24-hour/overnight delivery services leads us to conclude that 72 hour battery operation is desirable [1]. Shipping standards by air within a 24 hour time frame requires careful coordination between the laboratories, often with laboratory personnel delivering the standard to, and picking up the standard from, the airport. We consider a battery operating time of 24 hours to be unacceptable for a transport standard, although in some cases it is possible to extend the operating time by including additional batteries in the shipping container. This is less desirable as two massive objects in the same container are more likely to cause damage to each other than one alone.

An alternative to this approach is to design the standard to be shipped with the power turned off. Thus there is no limit imposed on shipping time by the battery operating time. (This may also save substantially on the weight of the standard; see guideline P17.)

P9. *Recovery time of the voltage outputs after transport.*

Goal P9: All voltage outputs should recover to within 0.02 ppm of their final value in less than 2 hours after restoration of ac power.

If the standard is shipped under battery power with the oven operating there is no reason to expect a significant change in the output after restoration of ac power and hence no recovery time is expected. Most manufacturers recommend shipping their standards under power for highest accuracy transfers. If the manufacturer suggests that transfers can be made not under power a recovery or settling time to the final-expected-value should be specified to indicate when the standard will be ready for use. For example: "After shipping, the output voltage will be within 0.5 ppm of it's final value 8 hours after restoration of ac power."

We have made a number of transfers with two temperature-controlled standards that were shipped not-under-power (see guideline P2). One of the units never showed any significant recovery effects; the unit was received in the laboratory one day, and measurements begun the next day agreed with succeeding measurements within the normal day-to-day scatter. But, the first two or three day's measurements on the second unit often, but not always, were in slight disagreement with succeeding measurements. Figure 3 shows an example of this recovery behavior where both standards were shipped together in the same shipping container. SN 10 at 3 and 4.6 months apparently shows recovery effects, while SN 11 appears to be unaffected.

A special situation may exist where the unit is manually switched to a "transit" mode and during this time the standard is not intended to provide it's specified accuracy. In this mode the batteries may be used only to maintain a constant diode current while the oven control is turned off to conserve battery power or, the diode current may not be closely regulated. In this case a recovery or settling time should be specified, or a front panel light provided, to indicate when the standard is at full specified accuracy after being switched back to "operate".

P10. *Electrical isolation of the voltage outputs.*

Goal P10: Greater than $10^{11} \Omega$ from any output to any other output, to ground, or to the ac mains.

The output(s) of the standard must be well isolated from the ac mains and ground, and when multiple references are provided they should be isolated from each other. Many experiments and calibration procedures rely on the standard producing an output that may be "floated" off ground. The typical user is most likely familiar with standard cells which usually have excellent isolation, between cells, to ground, and to the ac mains, and is unlikely to consider that Zener standards should behave any differently. If the multiple outputs of the standard cannot be connected in series to produce a larger voltage, the user should be specifically warned of this. Unlike the cell, the Zener standard is connected to the ac mains and operates with much higher internal voltages; they typically have voltages as large as 24 V at some portions of the circuitry. Thus a 1.018 V output could possibly be driven to as much as 24 V above ground by leakage resistances from the circuitry to ground.

P11. *Protection of the voltage outputs.*

Goal P11: There should be no lasting effects from shorting or applying up to 1000 V (current limited to 25 mA) across any output or between any output and ground.

As a minimum, the standard should be unaffected by indefinitely shorting any of the outputs; the output should return to its original value soon after the short is removed. If the time required to return to the original value is greater than a few seconds, a settling time should be specified. There should also be protection against inadvertent application of 1000 V to any of the outputs. Such a situation could happen during calibration of a dc calibrator with 1000 V capability.

P12. *Battery recharge time.*

Goal P12: The battery recharge time should be 24 hours or less for fully discharged batteries and the charging circuit should not overcharge the batteries.

The time required to recharge the internal battery (if any) is generally not a problem. If the standard is being shipped to a laboratory for calibration, several days at a minimum will be required for the calibration and this usually far exceeds the battery recharge time. The optimum recharge time will depend on the charging method and the particular battery being used. A recharge time from 14 to 24 hours for fully discharged batteries is reasonable. The charging circuit should not overcharge that batteries if left permanently connected.

P13. *Adjustment range of the voltage outputs.*

Goal P13: No adjustable elements should be included for regulation of the final output voltages.

For best stability we recommend that there be no adjustable elements in the output circuitry. The output should be trimmed initially at the factory using fixed-valued components, and not adjusted afterward. The standard should be used the same way standard cells currently are; each standard is assigned a calibrated value which is not necessarily the nominal value. We also recognize, however, that some applications require standards that produce an exact nominal value. In this case a separate adjustable output, with an adjustment range only large enough to compensate for the expected drift of the standard, may be added to the standard. The adjustment device should have a continuous resolution of 0.1 ppm or better.

Because of the physical shock encountered by transport standards during shipping (we have observed over 120 g's), we recommend that adjustable elements never be included in standards designed for transport.

P14. *Terminal posts for the voltage outputs.*

Goal P14: The standard should have separate low-thermal-emf terminals for each reference output, arranged for easy interconnection.

Low-thermal-emf (e.g., copper) binding posts should be used for all voltage outputs. Separate common terminals should be provided for each voltage output. We judge separate common terminals to be more reliable as only one wire or lug is connected to the terminal. Where multiple references or output voltages use a single common terminal, there is a greater likelihood that one or more of the wires on the terminal will make a poor contact. Switched outputs (i.e., multiple references switched to a single output) should not be used under any circumstances because of the probability of poor switch performance and the inability to use the standard with an automated switching system.

In a standard with multiple references, intercomparisons between the references can be done easily, even with multiple commons, if the common terminals are arranged in line with one another to permit a single copper shorting wire to be placed across all of them. The measuring instrument can then be connected between pairs of positive terminals to complete the measurement circuit.

P15. *Environmental operating conditions.*

Goal P15: The standard should operate at full accuracy under normal temperature, pressure, and humidity excursions encountered in the laboratory.

All accuracy specifications should apply when the standard is at laboratory conditions. If degradation of the specifications is necessary for use under less optimum conditions, e.g., on a production line, the revised accuracy specifications should also be stated.

Laboratory conditions

Temperature range:	(23 ± 2) °C
Humidity:	10 to 60 %RH
Altitude:	-300 to 2000 m

P16. *Physical shock during shipment.*

Goal P16: A transport standard and its shipping container should be designed to accept g-forces as high as 120 g's in any direction without damage. A shipping container should be recommended or supplied.

Standards designed for transport will likely require protection with a shipping container containing additional packing material. We have shipped a number of standards in foam lined shipping containers and have instrumented them with ball-and-spring type shock indicators. The combined weight of the standard and shipping container was approximately 27 to 36 kg, and the shock indicators were securely fastened to the standards. These indicators are rated for a particular g-force and the internal springs and balls fly apart if the enclosure is subjected to the rated or greater force. During almost all shipments forces of at least 60 g's were encountered, and during one shipment a force of greater than 120 g's was recorded.

During this time we noted a pattern of serious damage when standards were shipped in a particular shipping container with approximately 5 cm of foam insulation surrounding the standard. In each case the standard was of a type with a removeable battery pack, and a printed circuit board that mates with a connector inside the instrument shifted during shipment, shorting out the battery and charring the printed circuit board.

P17. *Weight.*

Goal P17: A transport standard should weigh less than 9 kg (20 lb.), 13.6 kg (30 lb.) including its shipping container.

Since laboratory standards are (or should be) rarely moved, weight is not an important consideration. Practically, the standard should be movable by one person, and most presently-available standards meet this criteria having a weight of 18 kg or less.

Weight is more of a problem with transport standards as heavy items generally suffer rougher handling during shipment. This is one area where present standards are seriously lacking. It is necessary to produce a multiple reference transport standard that weighs less than 9 kg. Anything weighing much more than this is unwieldy and distinctly less useful as a transport standard. Remember, the competition is a 4-cell standard cell enclosure weighing 11 kg (13.6 kg with the shipping container). As batteries usually account for a substantial portion of the weight of a standard, a considerable savings in weight can be achieved if they can be reduced or eliminated. Thus, the weight of a transport standard can be reduced by designing it to be shipped with the power turned off.

P18. *Panel indicators.*

Goal P18: A standard should have suitable front-panel indicators to clearly verify that the unit is operating properly.

The standard should have suitable front-panel indicators to verify that the unit is operating properly. These include (1) an oven temperature indicator or monitoring device, (2) a battery charge light to indicate whether the battery is charging and when it has reached full charge, (3) a power failure indicator to monitor any power interruptions to the reference or oven, (4) an ac power light to show when the unit is operating from the ac mains, and (5) an indicator to show when the battery is within its operating voltage limits.

P19. *Battery Life.*

Goal P19: Batteries should supply at least 50% of rated capacity for 2 years.

As batteries age, their capacity decreases, decreasing the operating time of the standard while on battery power. One of the most annoying problems we have had is verifying the capacity of a set of batteries installed in a standard. The most frequent cause of unsuccessful transfers is unknown battery capacity that is a fraction of the specified capacity. The manufacturer should recommend a test procedure for verifying the capacity of the batteries. Alternatively, a regular replacement schedule could be recommended.

It would be extremely desirable to include some kind of test circuit in the standard to detect marginal or failing batteries. Another approach might be to mount the batteries in a chassis or box that can be removed without opening the instrument, to provide for the easy interchange of suspect batteries with good batteries. The suspect batteries could then be tested outside the standard using a procedure recommended by the manufacturer.

P20. *Provision for an extra battery.*

Goal P20: A connector should be provided on the standard to permit the use of additional external batteries to extend the operating time of the standard.

Transport standards should provide a connector on the standard for connecting an external battery to extend the operating time for lengthy shipments. The extra batteries should be charged by the internal charger of the standard. A desirable feature would be to provide for operation on 12 V dc so that during shipment by automobile the electrical system of the car can be used to power the standard.

P21. *Compliance with electrical safety standards*

Goal P21: The standard should comply with all applicable U.S. and international safety standards, such as UL 1244, IEC 348, and VDE 0411-1973.

III. DESIGN GUIDELINES

D1. *Multiple independent references.*

It is absolutely necessary to use multiple standards, or a standard containing multiple references, to evaluate the errors associated with transporting a standard from one location to another. When only one reference/standard is used there is no way to assess the uncertainty of a particular transfer other than by using data from similar previous experiments. When using multiple references/standards, changes in the relative differences between the references as measured at both locations can be used as a statistical check or assessment of that part of the uncertainty involved with the transport of the standard.

Multiple independent references contained within a single standard (not multiple outputs from the same reference) are a convenient way to provide redundancy in establishing or transporting a unit of voltage. Just as standard cell enclosures are never designed for only one cell, Zener standards should contain more than one reference device. More is almost always better, however a reasonable number of reference outputs is on the order of four to six, with each reference providing a 10 V and 1.018 V output. If there are too few references there is not enough redundancy, if there are too many references then too many measurements are required. The alternative of using multiple standards instead of a single standard with multiple references is not recommended. This approach is expensive (i.e., more standards, more shipping weight), inconvenient, and more likely to produce damage to the standards because of rougher handling during shipment.

As noted above (P14.), each reference within a standard should have its own separate terminals brought out to the front panel. This permits intercomparison of the individual references and allows the user to identify noisy references or references that are drifting excessively with respect to the rest of the group. Algorithms can be developed and applied for statistical removal of abnormal references from the group to improve the overall stability of the group mean.

D2. *Independence of multiple outputs.*

The statistical procedures and evaluation of uncertainties referred to in the last section generally require that the multiple outputs (references) of the standard be independent from one another with respect to all environmental conditions. If independence is not achieved then the procedures will underestimate the uncertainty.

Independence among multiple references can be achieved (but not guaranteed) by having separate power supplies, separate pre-regulators, separate voltage dividers, and separate ovens, for each diode reference, i.e., build several completely separate standards and house them in one cabinet. If it can be shown that one or more of these items contribute very little to the overall performance of the standard then it may be possible to have one common element for all the references, e.g., a common power supply or oven. We recommend that wherever practical the designer should avoid using circuit elements common to all the references.

We have evaluated several multiple-reference standards and have observed that the day-to-day fluctuations in the output voltages are correlated with one another indicating a dependence between the references. This may be caused by the power supply or the oven (or both) which are common to all the references. The manufacturer claims that the diode references are specifically chosen with different temperature coefficients to minimize correlation between the outputs.

D3. *Quality of the 1.018 V output.*

Zener standards are currently being used as replacements for standard cells and will continue to be used as such for some time. The quality of the 1.018 V output in most standards is very poor compared to the 10 V output. Improved dividers must be developed for this application. Bulk-metal-film dividers may be considered for use in a high-quality 1.018 V standard.

Another divider technology of interest is the time division divider (TDD) used in most high-quality dc calibrators. This technique involves switching the output between two references, usually zero volts and some other fixed voltage, and filtering the output to produce a voltage that is equal to the duty cycle times the fixed voltage. Linearities of 0.1 ppm or better have been claimed by manufacturers. This application requires only a simple version of the TDD as only stability is required – it will operate at a fixed duty cycle. An added advantage, if the duty cycle is adjustable, is that any required voltage adjustment may be made digitally.

D4. *Isolation.*

We recommend that each reference in a multiple-reference standard be fully and independently guarded, starting with a shield on the secondary of the power transformer and continuing to the front panel binding posts. If a single transformer is used for multiple references it should have multiple secondaries, each with its own shield. Ideally, each reference should have an individual battery contained within its guard, although this presents other problems with testing, recharging, and replacing the batteries. As an alternative, high-isolation switches (relays) could be used to disconnect one set of batteries from all the reference circuits when the batteries are not needed.

IV. CONCLUSIONS

Presently-available Zener voltage standards are reasonable and useful tools for maintenance of a unit of voltage at the 10 V level to an accuracy of 1 ppm. It has been demonstrated that when selected standards are carefully used as a transport standard a 10 V unit of voltage may be transferred between two laboratories to an accuracy of 0.08 ppm. However, present day standards are lacking in many areas and the preceding guidelines and goals are intended to address their shortcomings. The goals are generally realistic, being well within the grasp of current technology; major breakthroughs in technology are not required.

We also recognize that the quality of any individual standard depends heavily upon the quality of the particular Zener reference contained within it. This problem can be traced back to the poorly understood diode manufacturing process. Additional research needs to be done on the relationship between Zener diode performance characteristics, especially stability, and manufacturing process parameters before significantly improved Zener standards can be developed.

TABLE II
Summary of Performance Goals

Guideline number

- P1. *Long-term drift (stability) of the voltage outputs.*
The long term drift of each reference should be less than 2 ppm/year at 10 V with day-to-day variations less than 0.1 ppm.
- P2. *Sensitivity of the voltage outputs to power interruptions.*
Voltage output shifts resulting from power interruptions or abrupt ambient temperature changes of 20 °C or less should be less than 0.1 ppm.
- P3. *Noise on the voltage outputs.*
Noise output of any voltage output should be <0.1 ppm rms in a bandwidth of 0.01 - 10 Hz. Day-to-day variations should be less than 0.1 ppm (1 σ).
- P4. *Temperature coefficient of the voltage outputs.*
The temperature coefficient of any voltage output should be less than 0.01 ppm/°C.
- P5. *Regulation of the voltage outputs with respect to the supply voltage.*
The maximum change in any output voltage should be 0.01 ppm or less over the supply voltage range (ac and battery) of the standard.
- P6. *Load regulation of the voltage outputs.*
The output resistance of the 10 V range should be 0.001 Ω or less with a 2 mA current capability for a laboratory standard and less than 1 k Ω for a transport standard. Output resistance of the 1.018 V range should be 1 k Ω or less. The output resistances of all ranges should be specified by the manufacturer so that the user may apply a loading correction if desired.
- P7. *Change of the voltage outputs with ac imposed on the output terminals.*
All voltage outputs should exhibit a change of less than 0.01 ppm when a DVM (8 mV noise pk-pk, 1 kHz - 5 MHz BW) is connected to that output.
- P8. *Operating time under battery power.*
The battery should supply power for operation of a transport standard for 72 hours at a 20 °C ambient temperature.
- P9. *Recovery time of the voltage outputs after transport.*
All voltage outputs should recover to within 0.02 ppm of their final value in less than 2 hours after restoration of ac power.

- P10. *Electrical isolation of the voltage outputs.*
Greater than $10^{11} \Omega$ from any output to any other output, to ground, or to the ac mains.
- P11. *Protection of the voltage outputs.*
There should be no lasting effects from shorting or applying up to 1000 V (current limited to 25 mA) across any output or between any output and ground.
- P12. *Battery recharge time.*
The battery recharge time should be 24 hours or less for fully discharged batteries and the charging circuit should not overcharge the batteries.
- P13. *Adjustment range of the voltage outputs.*
No adjustable elements should be included for regulation of the final output voltages.
- P14. *Terminal posts for the voltage outputs.*
The standard should have separate low-thermal-emf terminals for each reference output, arranged for easy interconnection.
- P15. *Environmental operating conditions.*
The standard should operate at full accuracy under normal temperature, pressure, and humidity excursions encountered in the laboratory.
- P16. *Physical shock during shipment.*
A transport standard and its shipping container should be designed to accept g-forces as high as 120 g's in any direction without damage. A shipping container should be recommended or supplied.
- P17. *Weight.*
A transport standard should weigh less than 9 kg (20 lb.), 13.6 kg (30 lb.) including its shipping container.
- P18. *Panel indicators.*
A standard should have suitable front panel indicators to clearly verify that the unit is operating properly.
- P19. *Battery life.*
Batteries should supply at least 50% of rated capacity for 2 years.
- P20. *Provision for an extra battery.*
A connector should be provided on the standard to permit the use of additional external batteries to extend the operating time of the standard.
- P21. *Compliance with electrical safety standards.*
The standard should comply with all applicable U.S. and international safety standards, such as UL 1244, IEC 348, and VDE 0411-1973.

REFERENCES

- [1] L. S. R. Becker, B. F. Field, and T. E. Kiess, "10-V Round-Robin Test Conducted on a Solid-State DC Voltage Standard," *IEEE Trans. Instrum. Meas.*, vol. IM-35, pp. 383-386, Dec. 1986.
- [2] "Transportable Ten Volt DC Standard," *NBS-CCG Quarterly Progress Report - 1 July 1985 - 30 September 1985*.
- [3] W. G. Eicke, "Operating Characteristics of Zener Reference Diodes and Their Measurements," *ISA Trans.*, vol. 3, no. 2, pp. 93-99, Apr. 1964.
- [4] *732A DC Reference Standard Instruction Manual*, John Fluke Mfg. Co., Inc., 1985.
- [5] *Trancell Precision Solid State Voltage Reference Standards Specifications*, Koep Precision Standards, Inc.
- [6] *2734A Direct Voltage Reference Bank, Operation and Maintenance Manual*, Valhalla Scientific, 1987.

U.S. DEPT. OF COMM. BIBLIOGRAPHIC DATA SHEET <i>(See instructions)</i>	1. PUBLICATION OR REPORT NO. NBS/TN-1239	2. Performing Organ. Report No.	3. Publication Date Sept. 1987
4. TITLE AND SUBTITLE Solid-State Voltage Standard Performance and Design Guidelines			
5. AUTHOR(S) Bruce F. Field			
6. PERFORMING ORGANIZATION <i>(If joint or other than NBS, see instructions)</i> NATIONAL BUREAU OF STANDARDS U.S. DEPARTMENT OF COMMERCE GAITHERSBURG, MD 20899		7. Contract/Grant No.	8. Type of Report & Period Covered Final
9. SPONSORING ORGANIZATION NAME AND COMPLETE ADDRESS <i>(Street, City, State, ZIP)</i> Sponsored in part by the DC and Low Frequency Subgroup of the Calibration Coordination Group (CCG) of the Department of Defense			
10. SUPPLEMENTARY NOTES <input type="checkbox"/> Document describes a computer program; SF-185, FIPS Software Summary, is attached.			
11. ABSTRACT <i>(A 200-word or less factual summary of most significant information. If document includes a significant bibliography or literature survey, mention it here)</i> The Electricity Division has examined and analyzed the performance of all presently available high-quality solid-state (Zener) dc voltage standards. Based on these examinations and our knowledge of standards laboratory requirements we have developed a set of guidelines to define what is needed in a modern solid-state standard to supplement or replace cadmium-sulfate standard cells. Specific design goals are presented to serve as a guide for writing a detailed solid-state voltage standard specification and also as a guide to anyone evaluating such a standard.			
12. KEY WORDS <i>(Six to twelve entries; alphabetical order; capitalize only proper names; and separate key words by semicolons)</i> dc voltage standard; standard cells; Zener diode			
13. AVAILABILITY <input checked="" type="checkbox"/> Unlimited <input type="checkbox"/> For Official Distribution. Do Not Release to NTIS <input checked="" type="checkbox"/> Order From Superintendent of Documents, U.S. Government Printing Office, Washington, DC 20402. <input type="checkbox"/> Order From National Technical Information Service (NTIS), Springfield, VA 22161		14. NO. OF PRINTED PAGES 26	15. Price

INSTRUCTIONS

FORM NBS-114A: BIBLIOGRAPHIC DATA SHEET. This bibliographic data sheet meets the standards adopted for use by all U.S. Government agencies. It is needed for NTIS processing and must accompany all NBS papers, those appearing in nongovernmental media as well as those in NBS series, since all reports of NBS technical work are normally entered into the NTIS system. For all GPO publications, it becomes an integral part of the document and is widely used by librarians and abstractors.

- Items 1, 2** - Complete if information is available; otherwise Publications Office will complete later. If non-NBS publication, state "see item 10" (Enter other agency sponsor's report number if requested to do so, and enter NBSIR number under item 2).
- Item 3** - Complete if known; otherwise Publications Office will complete.
- Items 4, 5** - Complete as shown on manuscript. When NBS-114A is resubmitted along with NBS-266, following publication of non-NBS media papers, these items must agree with published paper.
- Item 6** - If not NBS, blank out and enter Grantee/Contractor name and address, or if performed jointly, show both.
- Item 7** - Complete when applicable.
- Item 8** - Enter "Interim," "Final," or period covered.
- Item 9** - Enter all sponsors' names and addresses. Include NBS if also a sponsor.
- Item 10** - Enter other relevant information, i.e., related or superseded documents. Also used by Publications Office for Library of Congress catalog number, and entry of non-NBS media citation upon receipt of Form NBS-266 from author. Check block if appropriate and attach SF185.
- Item 11, 12** - Prepare abstract and key words with special care. These are published separately by NBS, NTIS, and other bibliographic services, and are vital elements in guiding readers to your paper. The key words will be used as entries in a subject index. See NBS Communications Manual for additional guidance.
- Item 13** - Indicate "Unlimited" - for open-literature documents cleared under NBS editorial procedures, or "For official distribution. Do not release to NTIS" - for limited, restricted, or need-to-know material (See Communications Manual). Publications Office will mark appropriate "order" box and complete Stock Number when known.
- Items 14, 15** - Leave blank. To be completed by Publications Office or call Printing and Duplicating for NBSIR's.

NBS *Technical Publications*

Periodical

Journal of Research—The Journal of Research of the National Bureau of Standards reports NBS research and development in those disciplines of the physical and engineering sciences in which the Bureau is active. These include physics, chemistry, engineering, mathematics, and computer sciences. Papers cover a broad range of subjects, with major emphasis on measurement methodology and the basic technology underlying standardization. Also included from time to time are survey articles on topics closely related to the Bureau's technical and scientific programs. Issued six times a year.

Nonperiodicals

Monographs—Major contributions to the technical literature on various subjects related to the Bureau's scientific and technical activities.

Handbooks—Recommended codes of engineering and industrial practice (including safety codes) developed in cooperation with interested industries, professional organizations, and regulatory bodies.

Special Publications—Include proceedings of conferences sponsored by NBS, NBS annual reports, and other special publications appropriate to this grouping such as wall charts, pocket cards, and bibliographies.

Applied Mathematics Series—Mathematical tables, manuals, and studies of special interest to physicists, engineers, chemists, biologists, mathematicians, computer programmers, and others engaged in scientific and technical work.

National Standard Reference Data Series—Provides quantitative data on the physical and chemical properties of materials, compiled from the world's literature and critically evaluated. Developed under a worldwide program coordinated by NBS under the authority of the National Standard Data Act (Public Law 90-396).

NOTE: The Journal of Physical and Chemical Reference Data (JPCRD) is published quarterly for NBS by the American Chemical Society (ACS) and the American Institute of Physics (AIP). Subscriptions, reprints, and supplements are available from ACS, 1155 Sixteenth St., NW, Washington, DC 20056.

Building Science Series—Disseminates technical information developed at the Bureau on building materials, components, systems, and whole structures. The series presents research results, test methods, and performance criteria related to the structural and environmental functions and the durability and safety characteristics of building elements and systems.

Technical Notes—Studies or reports which are complete in themselves but restrictive in their treatment of a subject. Analogous to monographs but not so comprehensive in scope or definitive in treatment of the subject area. Often serve as a vehicle for final reports of work performed at NBS under the sponsorship of other government agencies.

Voluntary Product Standards—Developed under procedures published by the Department of Commerce in Part 10, Title 15, of the Code of Federal Regulations. The standards establish nationally recognized requirements for products, and provide all concerned interests with a basis for common understanding of the characteristics of the products. NBS administers this program as a supplement to the activities of the private sector standardizing organizations.

Consumer Information Series—Practical information, based on NBS research and experience, covering areas of interest to the consumer. Easily understandable language and illustrations provide useful background knowledge for shopping in today's technological marketplace.

Order the above NBS publications from: Superintendent of Documents, Government Printing Office, Washington, DC 20402.

Order the following NBS publications—FIPS and NBSIR's—from the National Technical Information Service, Springfield, VA 22161.

Federal Information Processing Standards Publications (FIPS PUB)—Publications in this series collectively constitute the Federal Information Processing Standards Register. The Register serves as the official source of information in the Federal Government regarding standards issued by NBS pursuant to the Federal Property and Administrative Services Act of 1949 as amended, Public Law 89-306 (79 Stat. 1127), and as implemented by Executive Order 11717 (38 FR 12315, dated May 11, 1973) and Part 6 of Title 15 CFR (Code of Federal Regulations).

NBS Interagency Reports (NBSIR)—A special series of interim or final reports on work performed by NBS for outside sponsors (both government and non-government). In general, initial distribution is handled by the sponsor; public distribution is by the National Technical Information Service, Springfield, VA 22161, in paper copy or microfiche form.

U.S. Department of Commerce
National Bureau of Standards
Gaithersburg, MD 20899

Official Business
Penalty for Private Use \$300