

Spectrum Analyzer Fundamentals – Theory and Operation of Modern Spectrum Analyzers Primer

This primer examines the theory of state-of-the-art spectrum analysis and describes how modern spectrum analyzers are designed and how they work. That is followed by a brief characterization of today's signal generators, which are needed as a stimulus when performing amplifier measurements.

testforce

Contents

1	Overview	3
2	Basics of Spectral Analysis	4
2.1	Correlation between the Time and Frequency Domains	4
2.2	Fast Fourier Transform (FFT) Analyzers.....	7
2.2.1	Architecture	7
2.2.2	How an FFT Analyzer Works.....	7
2.2.3	Difference between FFT Analyzers and Oscilloscopes.....	10
2.3	Analyzers that Use the Heterodyne Principle.....	11
2.3.1	Architecture	11
2.3.2	Frequency Selection	13
2.3.3	Step-by-Step Tuning of the Local Oscillator (LO).....	17
2.3.4	Intermediate Frequency (IF) Signal Processing.....	18
2.3.5	Envelope Detection and Video Filter	22
2.3.6	Detectors	25
2.4	Combining Both Implementation Approaches.....	30
2.5	Important Terms and Settings	32
3	Generators and Their Use	34
3.1	Analog Signal Generators	34
3.2	Vector Signal Generators	35
3.3	Arbitrary Waveform Generators (AWGs).....	39
4	Nonlinearities of the Device under Test (DUT)	42
4.1	1 dB Compression Point.....	42
4.2	Mathematic Description of Small-Signal Nonlinearities.....	43
4.3	Intercept Points IP2 and IP3	49
5	Crest Factor and Complementary Cumulative Distribution Function (CCDF).....	53
6	Phase Noise.....	57
7	Mixers.....	60
8	References.....	64

1 Overview

This primer is divided into eight chapters. Chapter 2 examines the theory of state-of-the-art spectrum analysis and describes how modern spectrum analyzers are designed and how they work. That discussion is followed in Chapter 3 by a brief characterization of today's signal generators, which are required as a stimulus when performing amplifier measurements. Chapter 4 concludes the theoretical part by showing how the effects on the spectrum that are caused by the nonlinearity of real devices under test are derived mathematically. Chapter 5 discusses measurements on signals with a high crest factor, and Chapter 6 explains phase noise measurements. Chapter 7 concludes the primer by looking into mixers and mixer measurements.

2 Basics of Spectral Analysis

For the most part, the structure and content of this chapter have been taken from the book *Fundamentals of Spectrum Analysis* by Christoph Rauscher [1]. That work contains further references and links for a more in-depth look at this subject.

2.1 Correlation between the Time and Frequency Domains

Electrical signals can be represented and observed in both the time domain and the frequency domain (see Fig. 1).

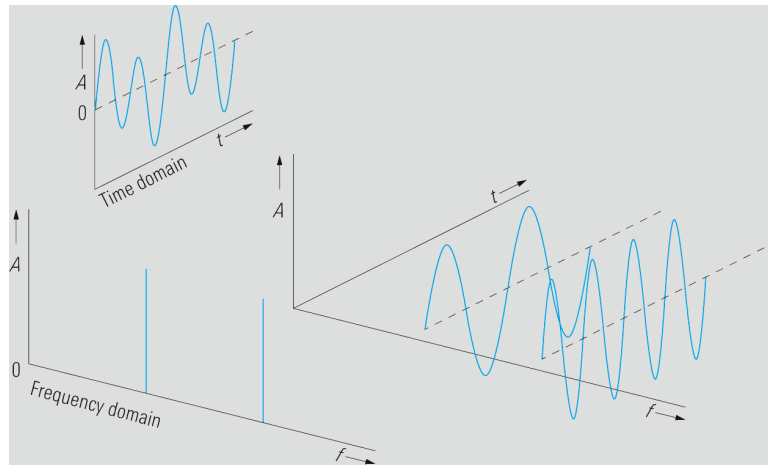

Fig. 1: Representation of signals in the time and frequency domains.

These two methods of representation are linked together via the Fourier transform, which means that a characteristic frequency spectrum for every signal can be represented in the time domain. The following applies:

$$\underline{X}_f(f) = F\{x(t)\} = \int_{-\infty}^{\infty} x(t) \cdot e^{-j2\pi ft} \cdot dt \quad (1)$$

Or:

$$x(t) = F^{-1}\{\underline{X}_f(f)\} = \int_{-\infty}^{\infty} \underline{X}_f(f) \cdot e^{j2\pi ft} \cdot df \quad (2)$$

Where

$\underline{X}_f(f)$	Complex signal in the frequency domain
$x(t)$	Signal in the time domain
$F\{x(t)\}$	Fourier transform of $x(t)$
$F^{-1}\{\underline{X}_f(f)\}$	Inverse Fourier transform of $\underline{X}_f(f)$

Periodic signals

Any periodic signal in the time domain can be represented by the sum of sine and cosine signals of different frequencies and amplitudes. The resulting sum is called a Fourier series.

$$x(t) = \frac{A_0}{2} + \sum_{n=1}^{\infty} A_n \cdot \sin(n \cdot 2\pi f_0 \cdot t) + \sum_{n=1}^{\infty} B_n \cdot \cos(n \cdot 2\pi f_0 \cdot t) \quad (3)$$

Where

$$A_0 = \frac{2}{T_0} \int_0^{T_0} x(t) \cdot dt$$

$$A_n = \frac{2}{T_0} \int_0^{T_0} x(t) \cdot \sin(n \cdot 2\pi f_0 \cdot t) \cdot dt$$

$$B_n = \frac{2}{T_0} \int_0^{T_0} x(t) \cdot \cos(n \cdot 2\pi f_0 \cdot t) \cdot dt$$

Because the frequency spectra of the sine and cosine signals having the frequency f_0 can be represented by Dirac delta functions at the frequencies f_0 and $-f_0$, the signal spectrum of a periodic signal can consist only of discrete spectral lines of defined amplitudes.

$$F\{\sin(2\pi f_0 \cdot t)\} = \frac{1}{2j} (\delta(f - f_0) - \delta(f + f_0)) \quad (4)$$

$$F\{\cos(2\pi f_0 \cdot t)\} = \frac{1}{2j} (\delta(f - f_0) + \delta(f + f_0)) \quad (5)$$

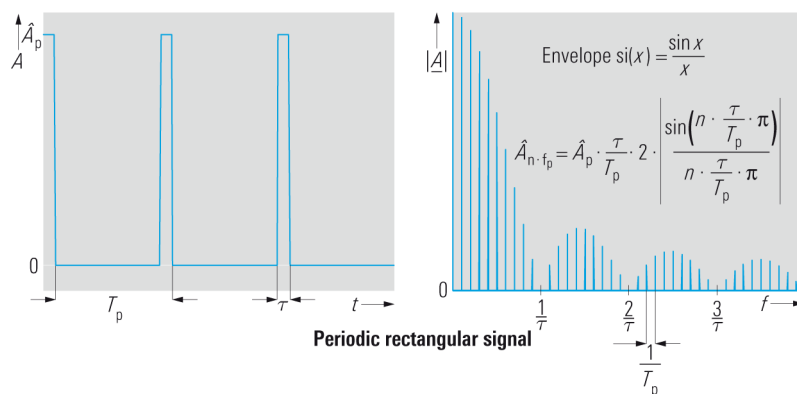

Fig. 2: Periodic rectangular signal in the time and frequency domains.

Nonperiodic signals

Signals with a nonperiodic time characteristic cannot be represented by a Fourier series. Time signals of this kind have no discrete spectral components, but rather a continuous frequency spectrum. Here, as for sinusoidal signals, a closed-form solution can be found for many signals (using Fourier-transform tables).

Nevertheless, there is seldom a closed-form solution for signals with a random time characteristic, such as noise or random bit sequences. In such cases, it is easier to determine the spectrum using a numeric solution for Equation (1).

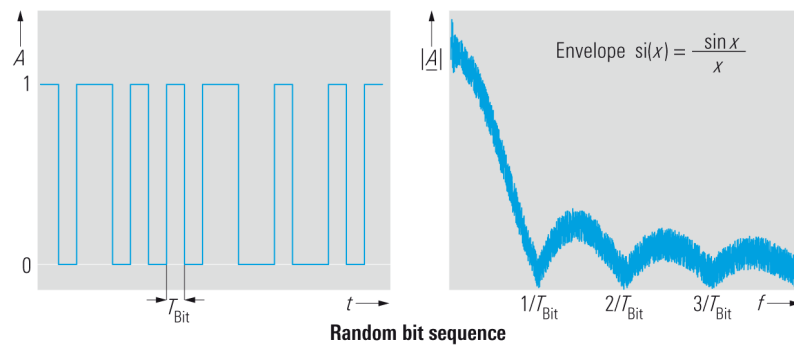

Fig. 3: A nonperiodic sequence of random bits in the frequency and time domains.

As noted earlier, signals can be described in both the time domain and the frequency domain. Consequently, a signal can also be acquired in both domains. Provided the general conditions remain within certain limits, it is possible to convert the respective results back and forth.

For this reason, the next section will first cover fast Fourier transform (FFT) analyzers, which capture signals in the time domain. Then, the discussion will move on to traditional spectrum analyzers, which tune the frequency range directly. Finally, a state-of-the-art signal and spectrum analyzer is used to show that combining the advantages of both approaches is possible.

2.2 Fast Fourier Transform (FFT) Analyzers

An FFT analyzer calculates the frequency spectrum from a signal captured in the time domain. Nevertheless, performing an exact calculation would require an observation period of infinite length. Furthermore, achieving an exact result for Equation (1) on page 4 would require knowledge of the signal amplitude at every point in time. The result of that calculation would be a continuous spectrum, meaning that the frequency resolution would be unlimited.

Obviously, performing such calculations in practice is impossible. Nonetheless, under certain circumstances, the signal spectrum can be determined with sufficient accuracy.

2.2.1 Architecture

Fig. 4 shows a block diagram outlining the primary elements that make up an FFT analyzer.

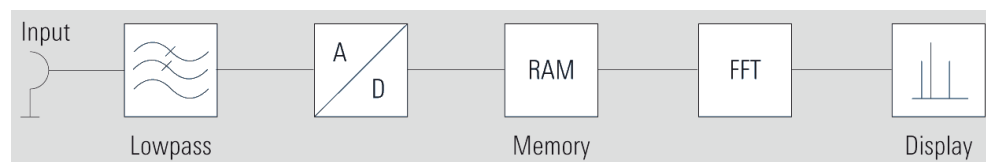

Fig. 4: Block diagram of an FFT analyzer.

In practice, the Fourier transform is performed with the aid of digital signal processing (discrete Fourier transform [DFT]), which means that the signal to be analyzed must first be sampled by an analog-to-digital converter (ADC), and its amplitude has to be quantized. To enforce conformity with the sampling theorem, an analog lowpass filter ($f_g = f_{e,\max}$) is employed to limit the input signal's bandwidth before the signal arrives at the ADC. Once the time-domain signal has been digitized, the discrete time values of a specific amplitude are stored temporarily in RAM, and those values are used to calculate the spectral components by applying the FFT. Then, the spectrum is displayed.

2.2.2 How an FFT Analyzer Works

Sampling system

To ensure that aliasing effects do not cause ambiguity during signal sampling, the bandwidth of the input time-signal must be limited. According to Shannon's sampling theorem, the sampling frequency $f_s = \frac{1}{T_s}$ of a lowpass-filtered signal must be at least twice as high as the maximum signal frequency $f_{in,\max}$. The following applies:

$$f_s \geq 2 \cdot f_{in,max} \quad (6)$$

Because the edge slope of the lowpass filter that is used to limit the bandwidth is finite, the sampling frequencies used in practice are significantly higher than $2 \cdot f_{e,max}$.

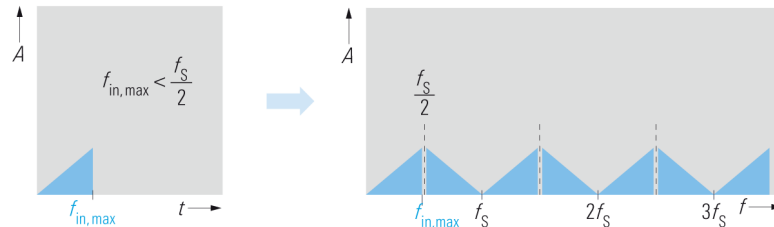

Fig. 5: Sampling a lowpass signal without aliasing:

$$f_{in,max} < \frac{f_s}{2}$$

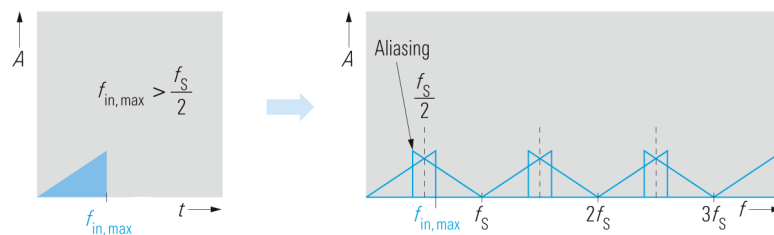

Fig. 6: Sampling a lowpass signal with aliasing:

$$f_{in,max} > \frac{f_s}{2}$$

Windowing

Only a portion of the signal is considered for the Fourier transform. Consequently, only a limited number of samples are used to calculate the spectrum. During this windowing process, the input signal that has been discretized after sampling is then multiplied with a certain window function.

Sampling turns Equation (1) into the DFT:

$$\underline{X}(k) = \sum_{n=0}^{N-1} x(n \cdot T_s) \cdot e^{-j2\pi kn / N} \quad (7)$$

Where

$\underline{X}(k)$	Complex discrete frequency spectrum
$x(n \cdot T_s)$	Sample at the time $n \cdot T_s$
k	Index of the discrete frequency bins, $k = 0, 1, 2, \dots$
n	Index of the samples, $n = 0, 1, 2, \dots$
N	Length of the DFT

This results in a discrete frequency spectrum that has individual components in what are known as frequency bins: $f(k) = k \cdot \frac{f_s}{N} = k \cdot \frac{1}{N \cdot T_s}$. Here, it is possible to recognize that the spectral resolution – i.e., the minimum spacing that two of the input signal's spectral components must exhibit in order to display two different frequency bins, $f(k)$ and $f(k + 1)$ – depends on the observation period $N \cdot T_s$.

The following prerequisites must be met to enable precise calculation of the discrete signal spectrum:

- The signal must be periodic (length of the period T_0).
- The observation period $N \cdot T_s$ must be an integer multiple of T_0 .

Here is the reason why:

In the frequency domain, multiplying the time signal with a square window corresponds to convolution of the spectrum with a si function.

$$|W(f)| = N \cdot T_s \cdot \text{si}(2\pi f \cdot N \cdot T_s / 2) = \frac{\sin(2\pi f \cdot N \cdot T_s / 2)}{2\pi f \cdot N \cdot T_s / 2} \tag{8}$$

If the input signal is periodic and the observation period is an integer multiple of the period's length, no error arises because – with the exception of the signal frequencies – the samples coincide with the si function's zero-crossings.

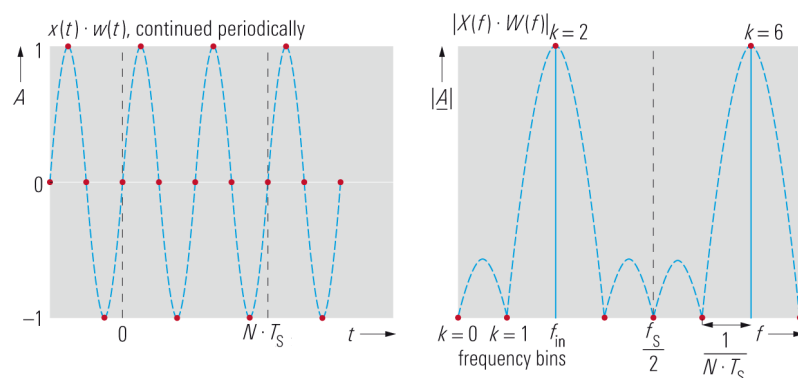

Fig. 7: Error-free DFT for a periodic input signal at integer multiples of the period's length.

If the above-mentioned conditions are not met, convolution with the window function according to Equation (8) will smear the resulting signal spectrum, thus widening it significantly. This effect is referred to as leakage. Simultaneously, amplitude errors arise.

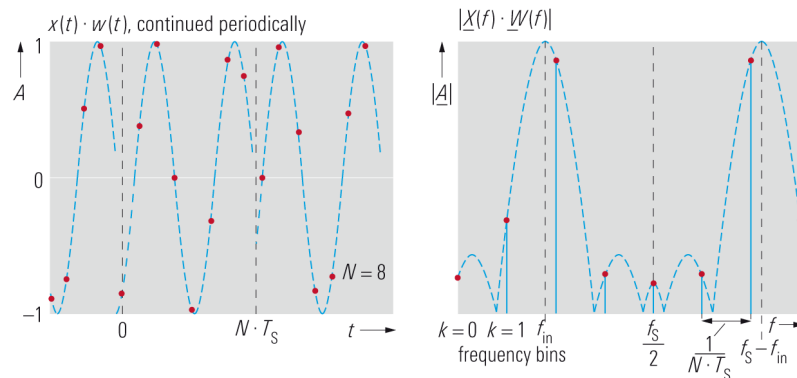

Fig. 8: DFT for a periodic input signal when the multiples of the period length are not integers (leakage).

While extending the observation period can reduce leakage by boosting the resolution, this does not decrease the amplitude error. Reducing both effects is possible, however, by employing an optimized window function instead of the rectangular window. Such window functions (e.g., a Hann window) exhibit lower secondary maximums in the frequency domain, which reduces leakage. Window functions can reduce the amplitude errors with a flat main lobe (flattop window: maximum level error of 0.05 dB); however, this results in the disadvantage of a relatively wide main lobe, which leads to a lower frequency resolution.

When a nonrectangular window is used, a systematic error always arises, even when the observation period is an integer multiple of the signal period (because the zero-crossings are no longer the same).

2.2.3 Difference Between FFT Analyzers and Oscilloscopes

Fig. 4 displays a block diagram of an FFT analyzer. FFT analyzers and oscilloscopes are similar in that they both sample the signal in the time domain and offer the option of spectral display. During the design process, however, different criteria are applied when selecting the ADC. The distinguishing feature of a spectrum analyzer is its high dynamic range. When developing oscilloscopes, engineers tend to select converters with a high sampling rate to be able to properly represent the steep edges of square waves and pulsed signals in the time domain. Nevertheless, the ADC's quantization depth depends on its maximum sampling rate. ADCs follow this general principle: the higher the sampling rate, the lower the available quantization depth. The quantization depth is determined by the number of bits used to represent a sample. The quantization noise and the maximum dynamic range can be derived from the quantization depth. Therefore, to enable spectrum analyzers to achieve the ideal dynamic range, developers select ADCs with a greater quantization depth and a correspondingly lower sampling rate.

2.3 Analyzers that Use the Heterodyne Principle

To represent the spectra of radio-frequency (RF) signals all the way up into the microwave or millimeter-wave band, analyzers with frequency converters (heterodyne principle) are used. Here, the input signal's spectrum is not calculated from the time characteristic; instead, it is calculated by performing analysis directly in the frequency domain. The input signal's spectrum can be broken down into its individual components by using a bandpass filter selected to match the analysis frequency, whereby the filter bandwidth represents the resolution bandwidth (RBW). From an engineering perspective, realizing such narrowband filters that can be tuned across the entire input frequency range is difficult. In addition, filters have a constant relative bandwidth with reference to the center frequency, which causes the absolute bandwidth to increase as the center frequency rises. For this reason, this concept is not suitable for spectrum analyzers.

As a rule, analyzers for higher input frequency ranges operate in the same way as a heterodyne receiver. Section 2.3.1 below shows that the RBW remains constant in such cases.

2.3.1 Architecture

Fig. 9 shows a block diagram outlining the design of a spectrum analyzer that employs the heterodyne principle.

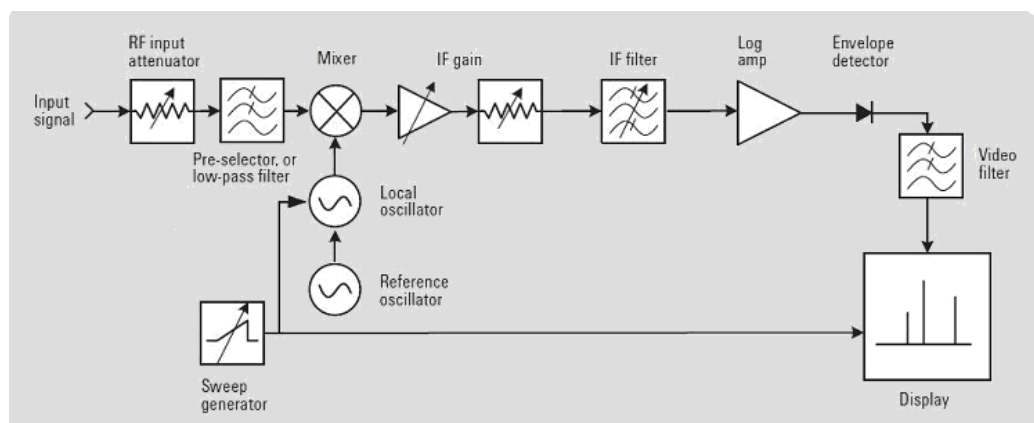

Fig. 9: Block diagram of a traditional spectrum analyzer that uses the heterodyne principle [2].

In a heterodyne receiver, a mixer and a local oscillator (LO) are used to convert the (lowpass-filtered) input signal to an intermediate frequency (IF). The LO in Fig. 9 is tuned by a sweep generator to convert the entire input frequency range to a constant intermediate frequency. The IF signal is amplified and arrives at the IF filter with a definable bandwidth. The input signal is essentially "swept past" this filter with a fixed center frequency (Fig. 10).

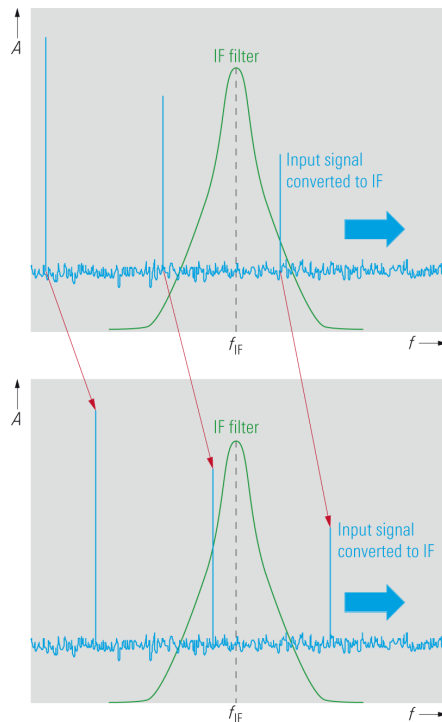

Fig. 10: A signal "swept past" the resolution filter inside the heterodyne receiver.

The IF filter, as shown in Fig. 9, determines the analyzer's RBW.

To display signals with a wide variety of levels on the screen simultaneously, the IF signal is compressed with the aid of a logarithmic amplifier. After that, the envelope detector and the video filter acquire the signal's envelope, and the noise is reduced through an averaging process, which smooths out the displayed video signal.

With earlier technology, the video signal was fed through a vertical cathode ray tube's vertical deflection. To display the frequency dependency, the tube's horizontal deflection was accomplished with the aid of the same sawtooth sweep signal that was used to tune the LO. Because the IF and the LO frequency are known, the relationship between the input signal and the display on the frequency axis is unambiguous.

Today's advanced analyzers use high-speed digital processing: An ADC samples the IF signal, and the signal is then processed digitally.

With modern analyzers, the LO is locked to a reference frequency with the aid of a phase-locked loop (PLL) and coordinated in discrete steps by varying the scaling factors.

In addition, the video signal is prepared digitally, and a liquid-crystal display replaces the cathode ray tube.

2.3.2 Frequency Selection

The following mathematical context applies when converting the input signal in the mixer to the IF with the aid of an LO signal:

$$|m \cdot f_{LO} \pm n \cdot f_{in}| = f_{IF} \quad (9)$$

Where

m, n	Natural numbers
f_{in}	Frequency of the input signal to be converted
f_{LO}	Frequency of the LO
f_{IF}	IF

The following applies for the signal's fundamental (1st harmonic):

$$|f_{LO} \pm f_{in}| = f_{IF} \quad (10)$$

Or, when solving for f_{in}

$$f_{in} = |f_{LO} \pm f_{IF}| \quad (11)$$

Taking a close look at Equation (11) reveals that for the oscillator frequencies and IFs, two receiving frequencies always exist for which the criterion from Equation (10) is fulfilled. This means that besides the desired input frequency range, there is another one, the "image frequency band."

To ensure unambiguous results, possible input signals for the image frequencies must be suppressed by employing corresponding filters ahead of the mixer's RF input.

Low IF

A spectrum analyzer should be able to process the widest possible input frequency range; here, having a low IF leads to limitations:

If the input frequency range is greater than $2 \cdot f_{IF}$, the input frequency and image frequency ranges overlap (see Fig. 11).

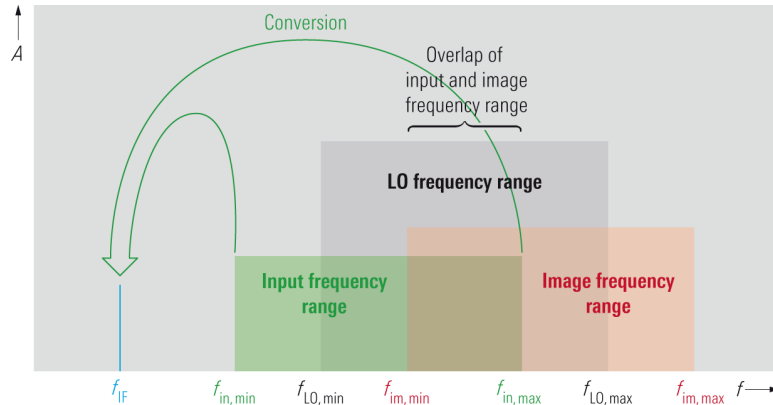

Fig. 11: Low IF, large input-frequency range: The input and image frequency ranges overlap.

With the lower LO frequencies, a signal is received both from the green input frequency range and from the red image frequency range. To achieve image frequency rejection without harming the desired input signal, the input filter must be implemented as a tunable bandpass filter. Doing so is highly complex from a technical standpoint.

Principle of using a high first IF

When a high first IF is used, the IF lies above the input frequency range. Consequently, the image frequency range is then located above the input frequency range. The two ranges do not overlap; therefore, image rejection can be accomplished with a lowpass filter that has fixed tuning (see Fig. 12).

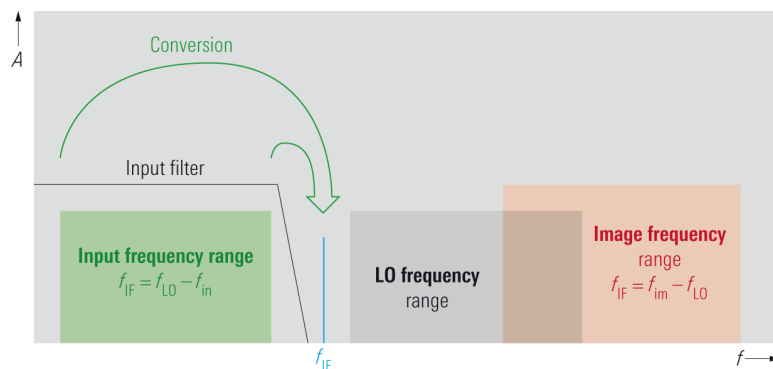

Fig. 12: The high-IF principle.

The following applies for conversion of the input signal:

$$f_{IF} = f_{LO} - f_{in} \quad (12)$$

Or for the image reception areas:

$$f_{IF} = f_{in} - f_{LO} \quad (13)$$

Example

The following description applies for the R&S®FSV40 signal analyzer (see Fig. 13). To arrive at the shared intermediate frequency IF2, this analyzer uses different techniques for frequencies up to 7 GHz and for those higher than 7 GHz. In addition, a bypass for low frequencies allows direct sampling of the input signal. (These ranges and frequencies are similar with other analyzer models.)

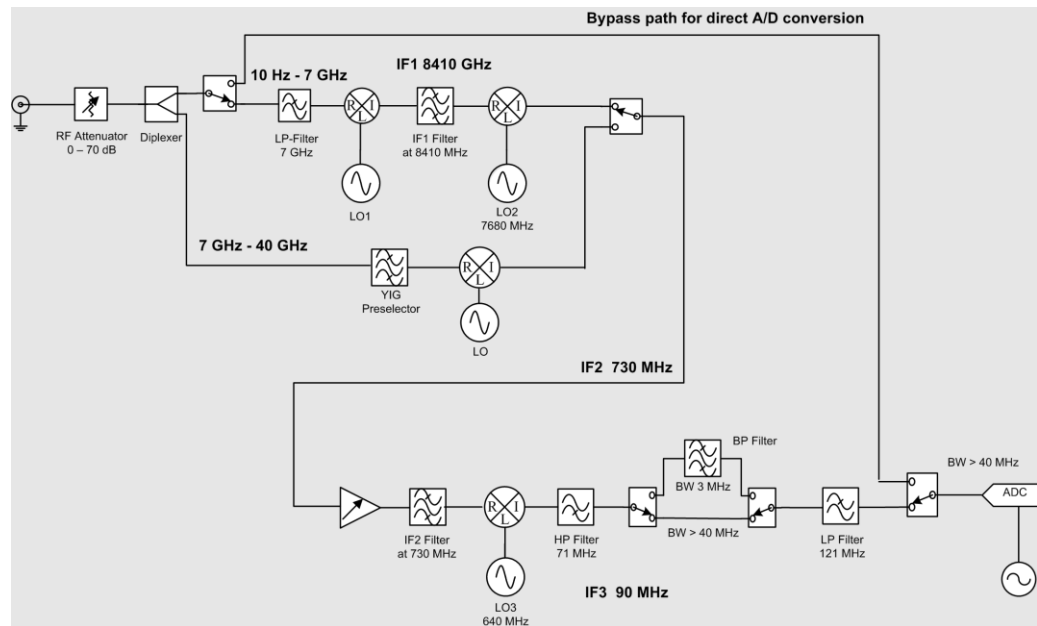

Fig. 13: Block diagram of the analog portion in the R&S®FSV40 signal analyzer.

Path for frequencies from 10 Hz to 7 GHz

The high-IF concept is employed here. The first intermediate frequency (IF1) is 8.41 GHz; thus, it lies above the highest receiver frequency. To convert the entire input frequency range from 10 Hz to 7 GHz to 8.41 GHz, the LO1 signal must be tunable in the frequency range from 8.41 GHz to 15.41 GHz. The image range then lies in the frequency range from 16.82 GHz to 23.82 GHz. In this way, the lowpass filter (up to 7 GHz) employed ahead of the mixer has no trouble filtering out the input frequency range and sufficiently suppressing the image frequency.

To add narrowband filtering on the 8.41 GHz signal and perform further processing on it, the signal must be reduced to a lower IF (in this case, approximately 90 MHz). Because IF1 is high, a very complex filter with a steep edge slope is required for direct conversion to 90 MHz to suppress the nearby image frequencies. For this reason, the IF1 signal is first reduced to the middle intermediate frequency, IF2 (730 MHz); then, it is amplified and filtered before being mixed down to IF3 at about 90 MHz.

Path for frequencies above 7 GHz

The principle of using a high IF1 becomes increasingly difficult to implement as the upper input frequency rises. For this reason, this principle is not used here for input signals above 7 GHz; instead, those signals are converted directly to a low IF. Doing this requires a tracking bandpass filter for image frequency rejection. Converting this frequency range to a lower IF is possible because the frequency range from 7 GHz to 40 GHz covers less than a decade (the range from 10 Hz to 7 GHz, on the other hand, corresponds to 8.8 decades), and YIG technology makes it possible to build a narrowband bandpass filter that is tunable across this frequency range.

As with the lower frequencies, the frequencies above 7 GHz cannot be mixed down to the desired low intermediate frequency IF3 (approximately 90 MHz), in a single step. For this reason, these frequencies, too, are first converted to 730 MHz. After that, the signal is amplified and coupled into the IF signal path for the low-frequency input stage.

Further processing of the IF2 signal is examined in Section 2.3.4.

2.3.3 Step-by-Step Tuning of the Local Oscillator (LO)

Due to the broad tuning range and low phase-noise that this technology offers, a YIG oscillator is usually employed as the LO. Some spectrum analyzers also use voltage-controlled oscillators (VCOs) for the LO.

In both cases, modern analyzers use a PLL to tie the oscillator to a reference signal. That is the only way to achieve good frequency accuracy and stability. Nevertheless, only discrete frequency steps are possible for this task. Consequently, such analyzers can only be tuned in discrete steps.

The step width required for this depends on the setting for the RBW. A narrow RBW requires small tuning steps because larger steps could result in lost information or level errors (see Fig. 14 on page 18). To prevent such errors, the analyzer automatically selects a step width that is significantly smaller than the RBW (e.g., $0.1 \cdot \text{RBW}$) (see Section 2.4.6 for more information).

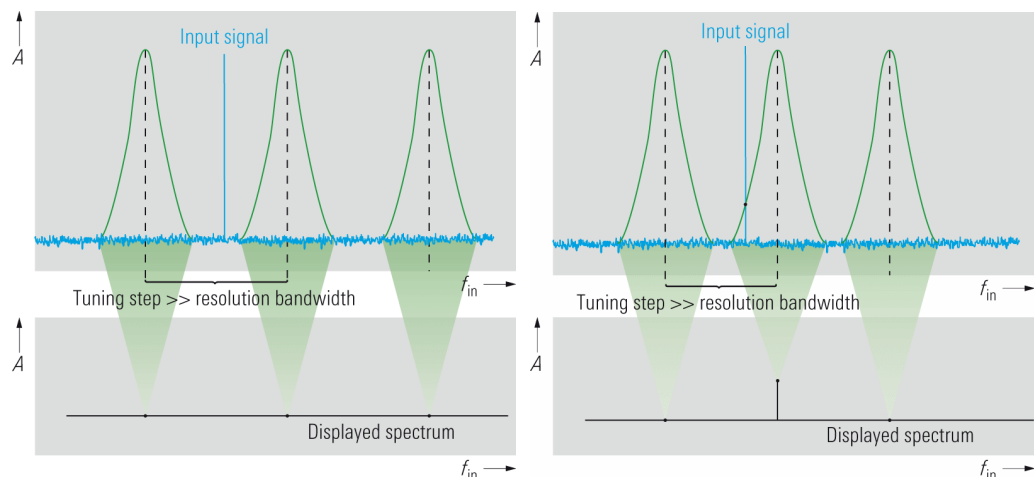

Fig. 14: Effects of using a tuning step width that is too large: Left: Input signal is completely lost; Right: Level errors arise in the representation of the input signal

2.3.4 Intermediate Frequency (IF) Signal Processing

The amplified and filtered IF2 signal with 730 MHz is converted to the IF3 (approximately 90 MHz), using the LO3 mixer.

In the IF3, the signal is amplified again in certain stages and limited to the selected bandwidth by filters. Here, the amplification can be set in steps, which keeps the maximum signal level constant in a way that is independent of the attenuator setting and thus independent of the mixer level. The settings for the IF gain can be chosen to allow the best possible exploitation of the ADC's dynamic range by setting the ADC's maximum input level so that it corresponds to the level of the largest signal within the IF bandwidth.

Depending on the concept used for the specific spectrum analyzer, with some analyzers, users can influence this gain. This is usually done by selecting the reference level. High reference levels result in a low IF gain; low reference levels result in high gain. With some spectrum analyzers, however, the reference level setting is decoupled from the IF gain, which means that the IF gain remains constant. In those cases, changing the reference level only influences the representation of the signal on the display through numeric scaling inside the computer.

With a traditional spectrum analyzer, the IF amplification is followed by what is referred to as resolution filtering, which is defined by the selected RBW. The resolution filter shows the portion of the input signal that was converted to the IF range and is to be displayed at a specific point on the frequency axis.

Due to their steep edge slopes and the resulting spectral selection characteristics, rectangular filters would be very well suited to serve as resolution filters. Due to their long settling times, however, it would only be possible to tune the LO frequency very slowly, as level errors could arise. That translates to long sweep times and slow measurements.

Short measurement periods can be achieved by using Gaussian filters optimized for settling times. Because – unlike rectangular filters – the transition from passband to stopband is not abrupt, a definition must be found for the bandwidth. In general spectral analysis, the 3 dB bandwidth is usually specified. This is the frequency spacing between the two points for the transfer function that exhibit a magnitude reduction of 3 dB compared with the transfer function for the center frequency.

When measuring noise signals or noise-like signals, one must reference the levels to the measurement bandwidth, i.e., to the RBW. For this reason, the equivalent noise bandwidth B_{noise} for the IF filter must be known, and it is calculated as follows:

$$B_{noise} = \frac{1}{H_{V,0}^2} \cdot \int_{-\infty}^{\infty} H_V^2(f) \cdot df \quad (14)$$

Where

B_{noise}	Noise bandwidth, in Hz
$H_V(f)$	Voltage transfer function
$H_{V,0}$	Value of the voltage transfer function at the center frequency f_0

To visualize this, think of the noise bandwidth as the width of a rectangle that has the same area as the area beneath the transfer function.

For measurements performed on correlated signals, such as the measurements normally used with radar technology, for instance, the pulse bandwidth B_l is also of interest. Unlike the noise bandwidth, this bandwidth results from the integration of the voltage transfer function. The following applies:

$$B_l = \frac{1}{H_{V,0}} \cdot \int_{-\infty}^{\infty} H_V(f) \cdot df \quad (15)$$

For Gaussian or Gaussian-like filters, the pulse bandwidth corresponds approximately to the 6 dB bandwidth (which is customary in interference measurement equipment). For test and measurement tasks, the correlations between 3 dB, 6 dB, noise, and pulse bandwidths are of particular interest.

According to the Fourier transform, when a sinusoidal input signal is acquired with a spectrum analyzer, an individual spectral line should appear on the screen at the signal frequency. In reality, however, the resolution filter's transfer function appears. The reason for this lies in the fact that the input signal that has been converted to the IF is "swept past" the resolution filter during the sweep period and is multiplied with that filter's transfer function (as in a convolution operation). It is also possible to think of this as the filter being "swept past" a fixed signal as shown in Fig. 15.

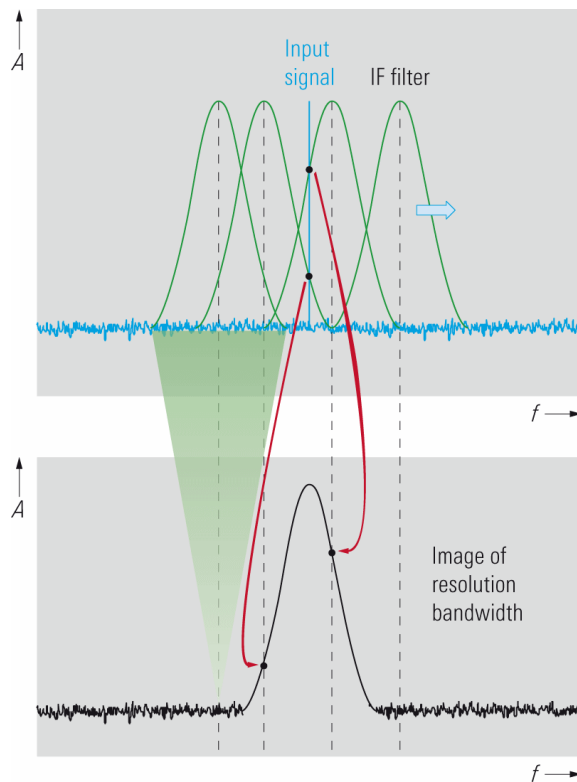

Fig. 15: Displaying the resolution by "sweeping it past" the input signal.

The analyzer's spectral resolution capabilities are therefore determined primarily by the RBW (the bandwidth of the resolution filter in the IF signal processing stage), which is why these capabilities are also referred to as the RBW. The IF RBW (3 dB bandwidth) corresponds to the minimum required difference in frequency that two signals of the same level must exhibit so that they can be distinguished in the display by a dip of about 3 dB.

If a significant difference in levels arises between adjacent signals, the weaker signal can no longer be displayed if the RBW is too large. To improve the filter's selectivity, it is possible to reduce the RBW and also to steepen the resolution filter's edge slope. The edge slope is determined by the shape factor (SF), which is calculated as follows:

$$SF_{60/3} = \frac{B_{3dB}}{B_{60dB}} \quad (16)$$

Where

B_{3dB} 3 dB bandwidth
 B_{60dB} 6 dB bandwidth

Fig. 16 shows how the RBW and edge slope affect the results.

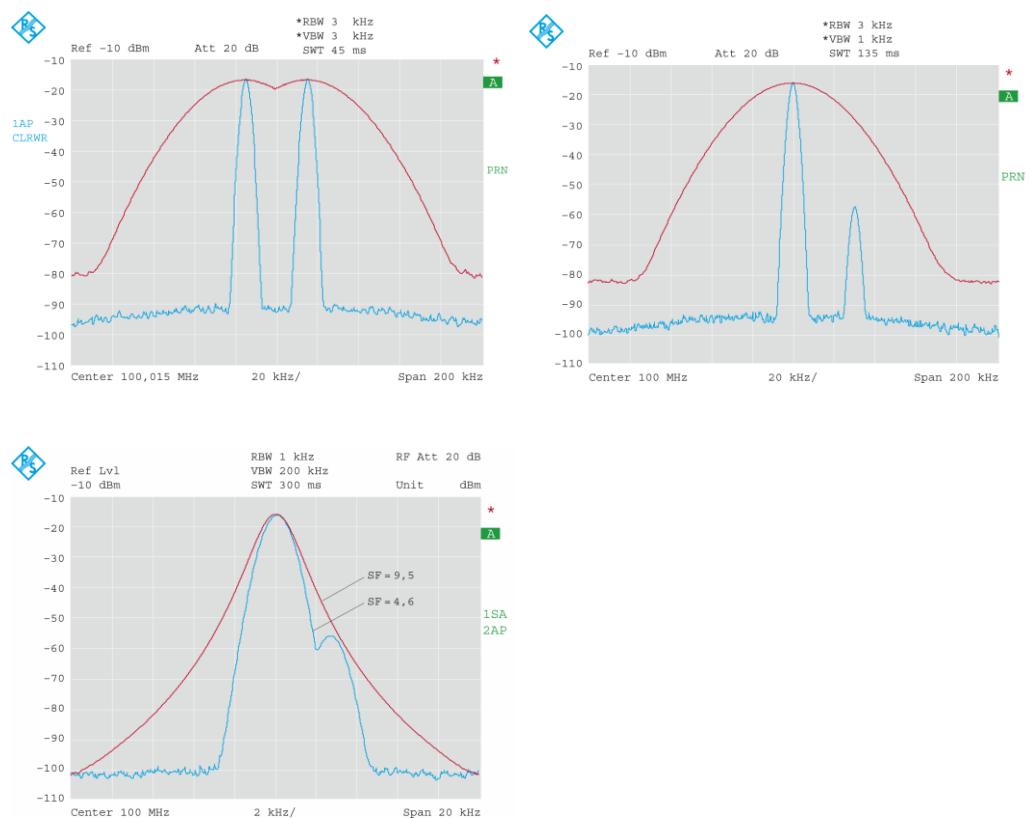

Fig. 16: How resolution bandwidth and the edge slope affect the representation of two signals.

As the information above shows, the highest resolution is achieved with narrowband resolution filters. Because a narrowband resolution filter has longer settling times, the minimum sweep time must be raised accordingly. This means that it must always be possible to match the resolution capabilities with the measurement speed. For this reason, modern spectrum analyzers must be able to set the RBW across a wide range (10 Hz to 10 MHz).

State-of-the-art spectrum analyzers indicate when the sweep time has been set too low – i.e., to a point at which the filter no longer has enough time to settle to a steady state.

Three basic types of filters are commonly used.

Analog filters

Traditionally, spectrum analyzers have been equipped with analog filters for resolution filtering. Because analog filters provide a close approximation of Gaussian filters up to a bandwidth of 20 dB, their settling behavior is almost as good. The selectivity depends on the number of filter circuits. It is possible to achieve SFs of about 10 (4.6 for an ideal Gaussian filter).

Even advanced spectrum analyzers that already work with digital filters (see below) do not go completely without analog filters. With an analyzer built as depicted in Fig. 13 (page xx), an analog prefilter with a bandwidth of approximately 3 MHz is switched into the IF3 signal path when small RBWs are used. This prefilter suppresses large signals located outside of the RBW being observed, making it possible to employ a higher IF gain without overamplifying the ADC. The prefilter also lowers the noise bandwidth and suppresses undesired intermodulation products from the upstream mixing stages. These two aspects lead to a larger spurious-free dynamic range (SFDR).

Digital filters

Current digital signal processing makes it easy to achieve all required bandwidths, i.e., 1 Hz to more than 50 MHz. In this way, designing ideal Gaussian filters ($SF = 4.6$) is possible, thus achieving better selectivity than is possible when analog filters are employed (at a reasonable expense). Beyond that, digital filters do not have to be aligned; they remain stable across a range of temperatures, and they are not subject to aging – all of which enables them to achieve greater bandwidth accuracy.

The settling time of a digital filter is always given. Correction calculations make it possible to shorten the sweep time – without changing the RBW – to a greater extent than is possible with analog filters.

Because digital filters do not have to be implemented in hardware, many different filter types can be made available on a spectrum analyzer. For instance, in addition to Gaussian filters, rectangular filters can be provided for signal analysis (demodulation).

Using FFT

This is not filtering in the traditional sense, but rather a combination of a tuned spectrum analyzer and an FFT analyzer. Here, small subranges of the spectrum to be represented are calculated using FFTs. For further details on this operating mode, see Section 2.4.

2.3.5 Envelope Detection and Video Filter

As with amplitude-modulated signals, the information on the input signal's level is contained in the level of the IF signal, in its envelope. For this reason, after resolution filtering is performed on the last IF, the system determines this IF signal's envelope.

The procedure for doing this compares to demodulation of an AM signal, which means, for instance, that an analog envelope demodulator can be used. Here, the IF signal is rectified, and the RF signal components can be eliminated by a lowpass filter. The "video voltage" then arises at the output.

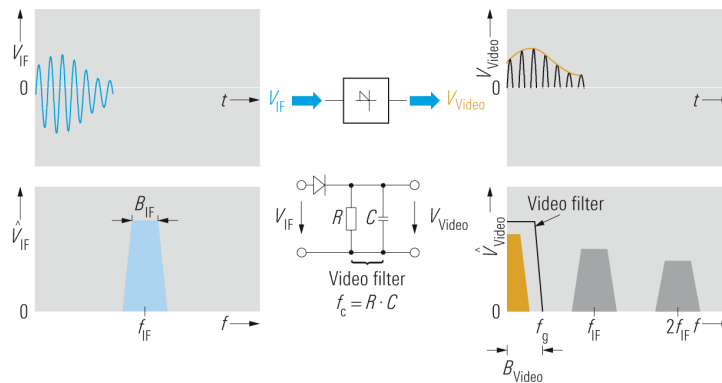
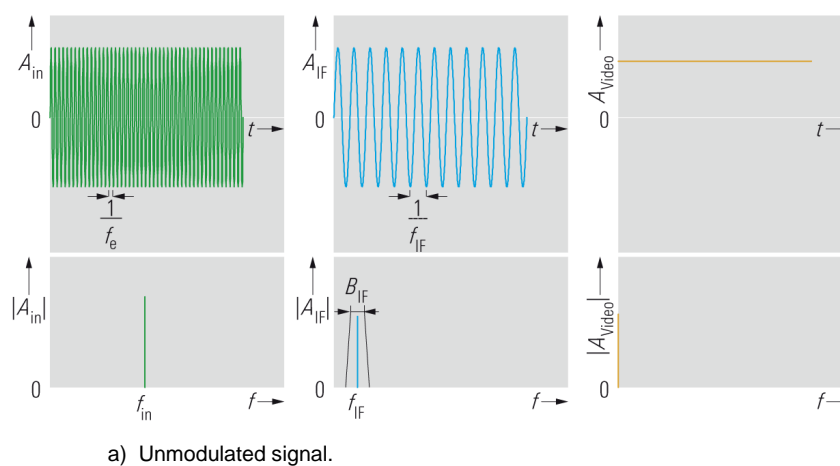

Fig. 17: Envelope demodulation.

If the IF signal processing is realized with the aid of a digital filter, the envelope is determined from the digital samples. The IF signal's envelope can be represented as the length of the complex rotating phasor that rotates with ω_{IF} (which can only accept discrete values). As noted in Section 2.2, the main difference from an FFT analyzer lies in the fact that the phase information is lost when the absolute value is determined.

The spectrum analyzer's dynamic range (which is > 100 dB with modern spectrum analyzers) is largely determined by the envelope detector's dynamic range. Simultaneously displaying large differences in levels does not make sense with a linear scale. Consequently, a logarithmic calculation can be optionally performed with the aid of a log amplifier positioned ahead of the envelope detector, increasing the display's dynamic range.

As Fig. 18 shows, the resulting video signal depends on the input signal and on the selected RBW.



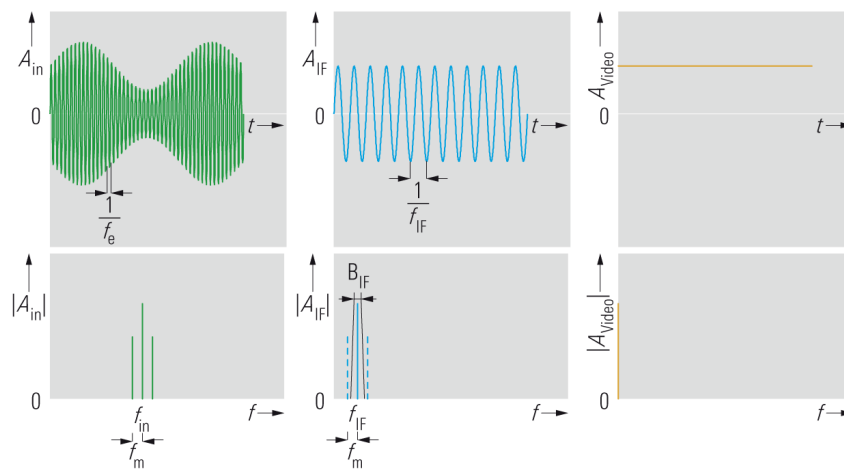

b) AM signal, RBW less than the twice the modulation width.

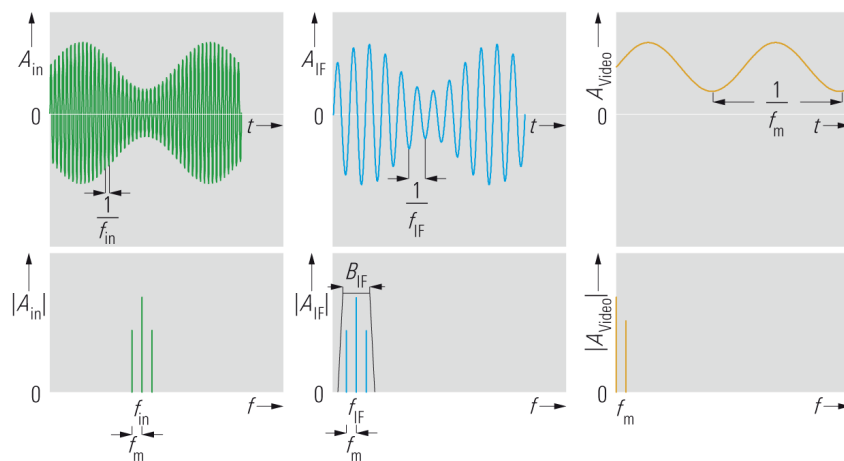

c) AM signal, RBW greater than the twice the modulation width.

Fig. 18: For the input signal (green trace), the IF signal after a resolution filter with a specific RBW (blue trace) and the video signal (yellow trace).

The video signal contains all of the signal information only when the RBW is large enough.

The envelope detector is followed by the "video filter," which is used to establish the video bandwidth (BW). This filter is a first-order lowpass filter, which frees the video signal of noise, i.e., it smooths out the trace that is displayed later. (With the signal analyzer used in the lab exercises, the video filter is also digital.)

If the video BW is narrower than the RBW, the former determines the maximum sweep speed.

Fig. 18 shows that the video BW should be set to suit the current measurement application: When measuring sinusoidal signals with a sufficient signal-to-noise ratio, the video BW is selected to be the same as the RBW. If the signal-to-noise ratio decreases, the noise can be averaged by reducing the video BW, thus making it possible to achieve a significantly more stable display. (If the video BW is selected to be lower than the bandwidth of the signal to be displayed, the system no longer displays the entire spectrum, which means that information is lost.)

2.3.6 Detectors

To display information, modern spectrum analyzers use liquid crystal displays (LCDs) with a discrete number of pixels. Since the LO's tuning step is approximately 1/10 of the RBW (see Section 2.4.2), and the span is larger than the RBW, multiple measurement results (samples) are available for each pixel. This affects the accuracy of the numerically displayed marker frequencies as well as the accuracy of the displayed measurement results.

The accuracy of the numerically displayed frequency at a marker position (e.g., with the *Marker to Peak* function) depends on the span and on the selected number of pixels (sweep points). Reducing the span or increasing the number of pixels boosts accuracy. For high precision, the analyzer used in the lab exercises has a *Signal Count* marker function. This function works independently of the evaluation of multiple samples and indicates the frequency with a high degree of accuracy.

Which level sample is displayed depends on which detector has been selected; the detector assesses all of the samples responsible for a given pixel. Fig. 19 on page 26 illustrates the various results that arise in this way.

Most spectrum analyzers have minimum peak, maximum peak, auto peak, and sample detectors. With the analyzer used in the lab exercise, the detectors have been implemented digitally (the video signal is sampled before it reaches the video filter). Consequently, besides the detectors already mentioned, an average detector and an RMS detector, as well as a quasi-peak detector (for interference measurements), were also realized.

Description of the detector functions

Maximum peak detector

The maximum peak detector displays the maximum value. Of all of the samples available for a specific pixel, the sample with the largest signal level is selected and displayed. Even when large frequency ranges are displayed with a RBW that has been set to be very narrow, no input signals are lost (which is important for EMC measurements).

Minimum peak detector

Of all of the samples allocated to a specific pixel, the minimum peak detector displays the one with the lowest level, i.e., it indicates the minimum value.

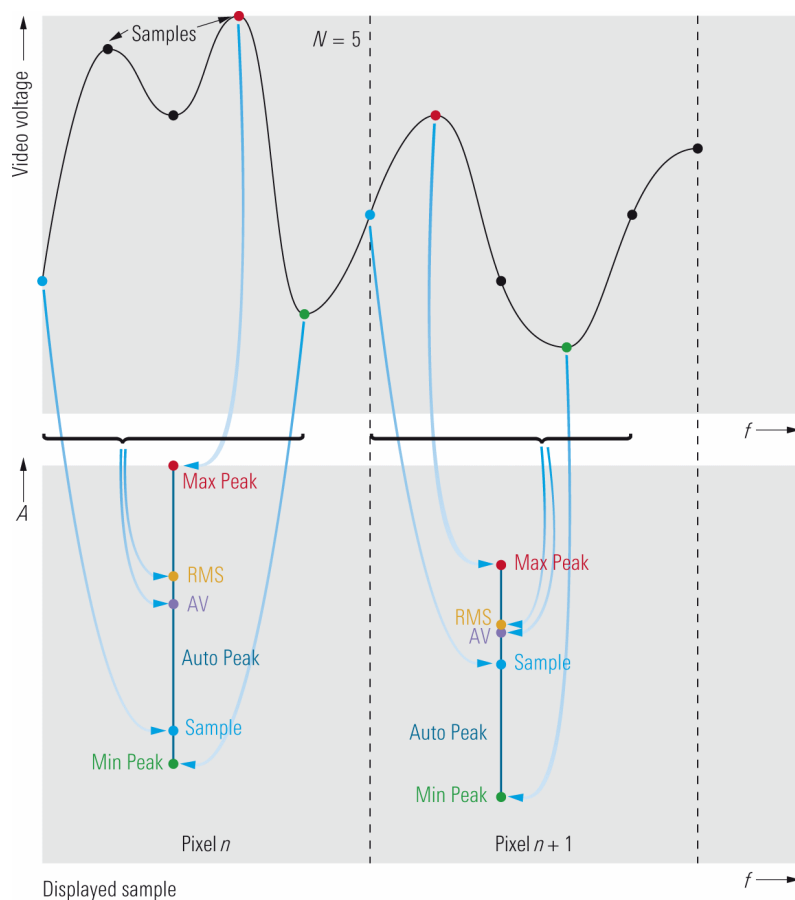

Fig. 19: Selection of the samples to be displayed based on the chosen detector.

Auto peak detector

When the auto peak detector is used, the maximum and minimum values are displayed simultaneously. Both values are measured and then indicated with a vertical line connecting the two values.

Sample detector

At a constant time interval, the sample detector takes one of the samples assigned to a particular pixel, which means that it only samples the IF envelope once for each pixel of the trace to be displayed. When the frequency range to be displayed is much larger than the RBW, the input signals are no longer acquired reliably.

RMS detector (average value)

The RMS detector uses the corresponding samples to calculate the power for every pixel of the displayed trace. The envelope samples are required in a linear level scale to perform this calculation. The following applies:

$$V_{RMS} = \sqrt{\frac{1}{N} \cdot \sum_{i=1}^N v_i^2} \quad (17)$$

Where

- V_{RMS} = RMS value for the voltage, in V
 N = Number of samples that are allocated to a pixel
 v_i = Samples for the envelope, in V

The power at the reference impedance is:

$$P = \frac{V_{RMS}^2}{R} \quad (18)$$

Average (AV) detector

The AV detector calculates the linear average for each pixel of the displayed trace from the corresponding samples. The envelope samples are required in a linear level scale to perform this calculation. The following applies:

$$V_{AV} = \frac{1}{N} \cdot \sum_{i=1}^N v_i \quad (19)$$

V_{AV} = Average voltage, in V

Quasi-peak detector

The quasi-peak detector detects the peaks for interference measurements with a defined charge and discharge time. It is used to measure electromagnetic interference.

How detectors affect representation of different input signals

Depending on the input signal, the different detectors lead to different measurement results. For sinusoidal input signals with a sufficient signal-to-noise ratio, the video voltage is constant. The level of the displayed signal is therefore independent of the selected detector because all samples have the same level, and the values (RMS, AV) calculated from them correspond to the level of each individual sample.

With random signals such as noise or noise-like signals, the instantaneous power varies over time, which means that the maximum and minimum instantaneous values as well as the average and RMS values for the envelope differ. The power for signals with a limited observation period T is calculated as follows:

$$P = \frac{1}{R} \cdot \frac{1}{T} \cdot \int_{t-T/2}^{t+T/2} v^2(t) \cdot dt \quad (20)$$

Furthermore, during the observation period T , the peak for the instantaneous power can be determined and that value used to calculate the crest factor.

$$CF = 10 \cdot \lg\left(\frac{P_{peak}}{P_{RMS}}\right) \quad (21)$$

Where

- CF Crest factor, in dB
- P_{peak} Peak power during the observation period T , in W
- P_{RMS} RMS power, in W

With a pure noise signal, it is theoretically possible for all voltages to occur (the crest factor can be of any size). Nevertheless, the probability that very high or very low voltage values will arise is very low. Consequently, in practice, values that can be displayed are achievable when the observation periods are long enough (e.g., crest factor = 12 dB for Gaussian noise).

How the selected detector and the sweep time influence the display of stochastic signals

Maximum peak detector

The system responds too strongly to stochastic signals; they result in the highest level display. If the sweep time increases, the dwell time in a frequency range assigned to a pixel rises. This increases the probability of higher instantaneous values, and the levels of the displayed pixels rise.

Using short sweep times delivers the same display as with the sample detector because only one sample is recorded per pixel.

Minimum peak detector

The minimum peak detector can be considered in the same way as the maximum peak detector, but for low signal levels.

Auto peak detector

The results of the maximum peak and minimum peak detectors are connected with a line and displayed simultaneously. If the sweep time increases, the displayed noise bandwidth becomes significantly larger.

Sample detector

Because only one sample is used at a defined time, the displayed trace varies due to the distribution of the instantaneous value around the average value for the envelope of the IF signal that results from the noise. In the case of Gaussian noise, this average value is 1.05 dB below the RMS value (also, using a narrow video BW in the logarithmic scale results in display values that are lower by an additional 1.45 dB). Thus, the displayed noise is a total of 2.5 dB below the RMS value.

With this detector, changing the sweep time does not affect the display because the number of evaluated samples is constant.

RMS detector

An input signal's actual power can be measured independently of its time variation. When the signal power is determined using data from the sample detector or maximum peak detector, the parameters for signal statistics must be known if working with stochastic signals. This information is not needed when the RMS detector is used.

Increasing the sweep time also increases the number of samples that enter the calculation, which smooths out the displayed trace. Because averaging through a narrow video BW falsifies the RMS display, the video BW must be at least three times as large as the RBW.

AV detector

In the linear level scale, an input signal's actual average value can be measured independently of its time variation. When averaging logarithmic values, the display level determined in this way would be too low because higher signal values are subjected to greater compression. Raising the sweep time makes more samples available per pixel for the calculation, which smooths out the displayed trace.

Using linear levels at the video filter's input and reducing the video BW will smoothen the signal.

As mentioned above, reducing the video BW smooths out the trace display through averaging. The prerequisite for this, however, is that the signal levels ahead of the envelope detector or video filter must be in the linear scale. The resulting display then represents the actual average value. If, on the other hand, the IF signal is logarithmized, the displayed average value is lower than the actual average value.

Marker functions

The *Marker to Peak* and *Signal Count* marker functions make it possible to work with a limited screen resolution and to read measurement results at a substantially higher resolution.

2.4 Combining Both Implementation Approaches

As explained in Sections 2.2 and 2.3, both FFT analyzers and spectrum analyzers that use the heterodyne principle offer specific advantages.

The benefits of using an FFT analyzer include the use of high measurement speeds at low RBWs and the ability to record the signal in the time domain with all of the phase information. This makes it possible to also analyze complex modulations (signal analysis).

An advantage of spectrum analyzers that employ the heterodyne scheme is that the input frequency range is independent of the ADC rate. When preselection is used, excellent suppression of harmonics and of other undesired spectral components can be achieved.

All of these benefits can be realized by skillfully combining an FFT analyzer with a traditional spectrum analyzer. One of the key features of modern analyzers is that many of the processing steps performed by traditional analog spectrum analyzers are now digitalized, meaning that they are implemented in software or digital hardware (such as an FPGA or ASIC). To provide sufficient dynamic range, ADCs that allow a high quantization depth are used for this.

Fig. 20 on page 31 shows the analog portion of a modern analyzer. Its functions correspond to those of a heterodyne spectrum analyzer – until the last IF stage. After that, further processing is accomplished digitally.

As with FFT analyzers, a sampled time-domain signal is made available after A/D conversion. That opens up the possibility for signal analysis, i.e., for demodulation of the signal. (The IF3 signal's bandwidth amounts to more than 40 MHz, making it possible to acquire data in the formats employed for all commonly used communications standards and then demodulate and analyze that information using the corresponding software options. For this reason, modern spectrum analyzers are often referred to as "signal and spectrum analyzers." Nevertheless, the focus here will remain on "spectral analysis.")

The ADC in Fig. 20 on page 31 does not sample a baseband signal, but rather an IF signal. The system performs bandpass sampling, i.e., it samples a signal associated with bandwidth B . The sampling rate used here can be even lower than the level of twice the largest frequency that arises ($IF3+B/2$). Nonetheless, the sampling rate must at least meet the Nyquist criterion for the signal bandwidth (i.e., it must be larger than $2*B$). For the analyzer outlined in Fig. 20, the bandpass filtering is realized before sampling through use of the 71 MHz highpass filter and the 121 MHz lowpass filter.

The result of the bandpass sampling is a time-discrete and value-discrete IF signal. In another processing step, "digital down-conversion" is used to generate a complex baseband signal from this digital IF signal.

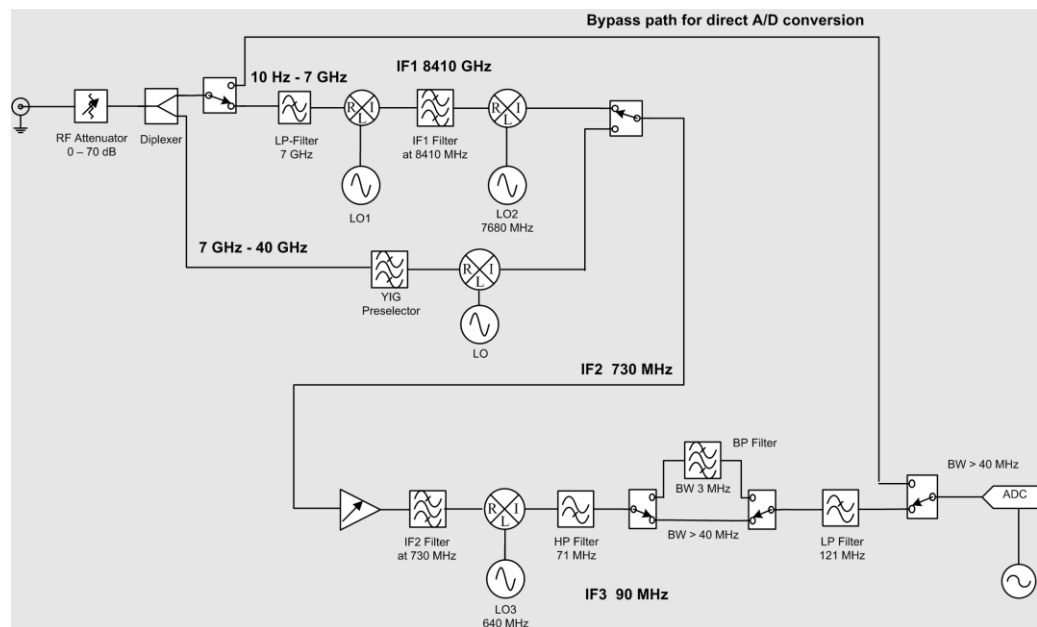

Fig. 20: Block diagram of the analog portion of a modern signal and spectrum analyzer.

The complex baseband signal contains a relative phase. Here, having a relative phase means that drawing conclusions about the absolute phase value is not possible, but the phase relationships within the signals remain constant.

A frequency-domain display can be prepared from the time-domain signal in two ways:

1. Use of digital filters with the RBW: The magnitude of the signal filtered in this way now corresponds to the power within the RBW; in other words, this is the exact value that is to be displayed for the current input frequency. That corresponds to the way that an analog spectrum analyzer works, whereby the filtering and formation of the absolute value are accomplished digitally. Digital filters with low delay distortion can be designed to settle to a steady state at a speed that is approximately 100 times faster than that achieved by the corresponding analog filters. Nevertheless, the sweep speed's dependency span/RBW^2 remains.
2. Calculation of an FFT: Here, the calculation and recording parameters are set so that the FFT's resolution corresponds exactly to the RBW setting. Because no narrowband filters are used for this, their long settling time does not dominate the sweep speed. Here, the maximum FFT width is limited by the analyzer's IF bandwidth (B); thus, in this case, it is approximately 40 MHz. The observation period, i.e., the length of the recording, determines the RBW that can be achieved for an FFT.

In both cases, it is necessary to "run through" the frequency range that has been set on the analyzer. With the first variant, this is done in very small steps: $f_{\text{Step}} \ll \text{RBW}$. That corresponds to the method described for traditional spectrum analyzers. With the second variant, the selected step width can be as large as the RBW. This means that the number of span/RBW FFT calculations can cover a specific span. Consequently, the sweep time is no longer proportional to span/RBW^2 . For this reason, the variant for settings with a small RBW is particularly well suited for this task.

Modern spectrum analyzers take advantage of the fact that the input signal can be switched directly to the ADC. The bypass in Fig. 20 is meant to accomplish this. Such direct sampling offers the advantage that neither mixers nor LOs influence the signal to be measured. This concept offers special advantages for noise and phase noise measurements: Using the direct path makes it possible to use a mid-range spectrum analyzer to measure signals that have a phase noise less than -130 dBc/Hz at a 10 kHz offset.

Direct sampling is, however, restricted to frequencies lower than half the sampling rate for the ADC being used. Depending on the settings, the spectrum analyzer used for the lab exercises employs this possibility up to frequencies just higher than 20 MHz.

2.5 Important Terms and Settings

Frequency range to be displayed

The frequency range to be displayed can be set either by using the start and stop frequencies or by using the center frequency and the span.

Level range to be displayed

This range is set by establishing the maximum level to be displayed (referred to as the reference level) and by establishing the span. The levels can be displayed in the linear or logarithmic scale. The damping of the attenuator on the input end also depends on these settings.

Attenuator

To be able to display high signal levels, the spectrum analyzer's input has been equipped with an attenuator set in steps. This attenuator can be used to set the signal level at the input for the first mixer – the mixer level.

Frequency resolution

With analyzers that employ the heterodyne principle, the frequency resolution is set via the resolution filter's bandwidth (see Section 2.3), referred to as the RBW.

Sweep time (only for analyzers that employ the heterodyne principle)

This is the time required to record the entire relevant frequency spectrum. The shortest sweep time is set automatically by the analyzer software, based on the selected bandwidths (RBW and video BW).

Dependencies for the sweep time, span or RBW and video BW

The shortest permissible sweep time is derived from the settling time of the resolution filter and the video filter. The video filter only influences the sweep time if the video BW is smaller than the RBW. This is expressed by the following equation:

$$T_{sweep} = k \cdot \frac{\Delta f}{B^2} \quad (22)$$

Where

T_{sweep} Minimum required sweep time (for the given span and RBW), in s

B RBW if $RBW \leq$ Video BW
Video BW if $Video\ BW \leq$ RBW

Δf Frequency range to be displayed (span)

k Proportionality factor, depending on the type of filter and on the required level accuracy.

3 Generators and Their Use

RF generators are classified into two main types:

- Analog signal generators
- Vector signal generators

Many other possible classifications exist based on various characteristics: frequency range or output power, form factor, capabilities for remote control, power supply, and others. This document will not examine those classifications.

Analog and vector signal generators generate their output signals in completely different ways, resulting in different modulation types and applications.

3.1 Analog Signal Generators

With analog signal generators, the focus is on generating a high-quality RF signal. These devices support the analog modulation types: AM / FM and ϕ M. Some devices can also be used to generate precise pulsed signals.

Analog generators are available for frequencies extending up to the microwave range. Their distinguishing features are:

- Very high spectral purity (nonharmonics), e.g., -100 dBc
 - Very low inherent broadband noise, e.g., -160 dBc
 - Very low single-sideband (SSB) phase noise, e.g., -139 dBc/Hz
- (at these settings: 20 kHz carrier offset, $f = 1$ GHz, 1 Hz measurement bandwidth)

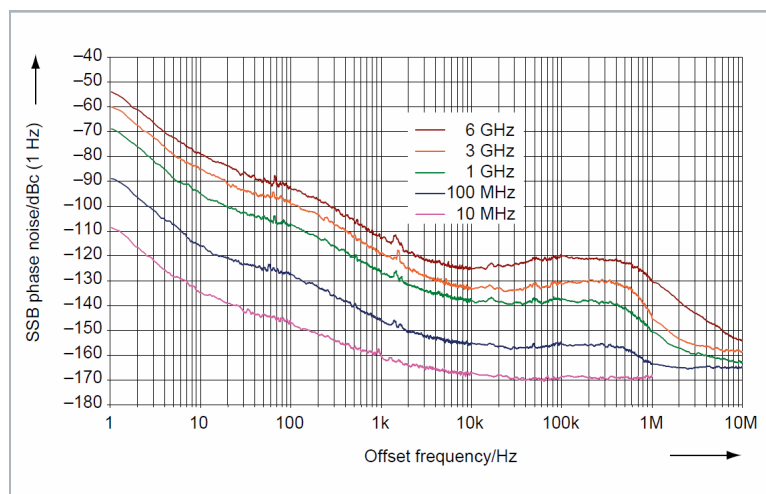

Fig. 21: An analog signal generator's very low SSB phase noise.

Analog signal generators are used:

- As stable reference signals (local oscillator [LO], source for measuring phase noise, or as a calibration reference)
- As a universal instrument for measuring gain, linearity, bandwidth, etc.
- In the development and testing of RF chips and other semiconductor chips, such as those used for ADCs
- For receiver tests (two-tone tests, generation of interferer, and blocking signals)
- For EMC tests
- For automated test equipment (ATE) and production
- For avionics applications (such as VOR, ILS)
- For military applications
- For radar tests

Fig. 22 shows an example of a special impulse sequence for radar applications.

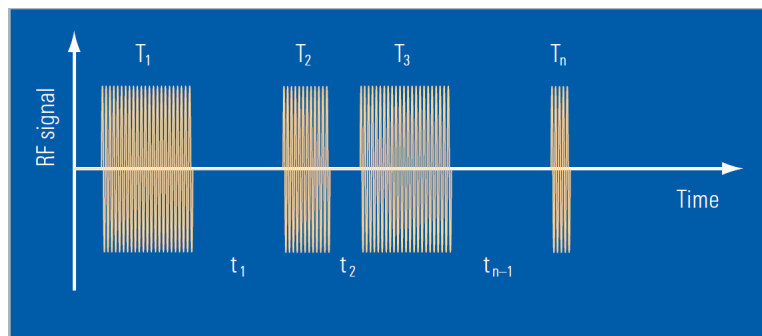

Fig. 22: Combination of impulses with different widths and interpulse periods for radar applications.

Analog signal generators are available with various specifications in all price classes. As with vector signal generators, additional criteria can be crucial for making the right selection. These include, for instance, requirements for a high output power or for fast settling of frequency and level, a specific degree of accuracy for the signal level and frequency, a low voltage-standing-wave-ratio (VSWR), and also possibly the instrument's form factor and weight.

3.2 Vector Signal Generators

Vector signal generators are distinguished by the fact that they generate and process the modulation signal computationally in the baseband as a complex IQ data stream. This also includes computational filtering, and (if necessary) limitation of the amplitude (clipping); it can also include other capabilities, such as generating asymmetric characteristics. Some generators can calculate Gaussian noise into the signal. Moreover, some generators are able to numerically simulate multipath propagation (fading, multiple in/multiple out [MIMO]) that will later occur for the RF signal.

In general, the complete generation of the baseband signal is accomplished through real-time computation. Arbitrary waveform generators (AWGs) are an exception to this (see Section 3.3).

The baseband IQ data are ultimately converted to an RF operating frequency. (Some vector generators operate exclusively in the baseband without generating RF signals.)

Often, vector signal generators are also equipped with analog or digital IQ inputs to feed external baseband signals into the instrument.

Using IQ technology makes it possible to realize any modulation types – whether simple or complex, digital or analog – as well as single-carrier and multicarrier signals. The requirements that the vector signal generators must meet are primarily derived from the requirements established by wireless communications standards, but also from digital broadband cable transmission and from A&D applications (generation of modulated pulses).

The main areas of application for vector signal generators are:

- Generating standards-compliant signals for wireless communications, digital radio and TV, GPS, modulated radar, etc.
- Testing digital receivers or modules in development and manufacturing
- Simulating signal impairments (noise, fading, clipping, insertion of bit errors)
- Generating signals for multi-antenna systems (MIMO), with and without phase coherence for beam forming
- Generating modulated sources of interference for blocking tests and for measuring suppression of adjacent channels

As an example, Fig. 23 shows a portion of the preprogrammed standards that a vector signal generator supports.

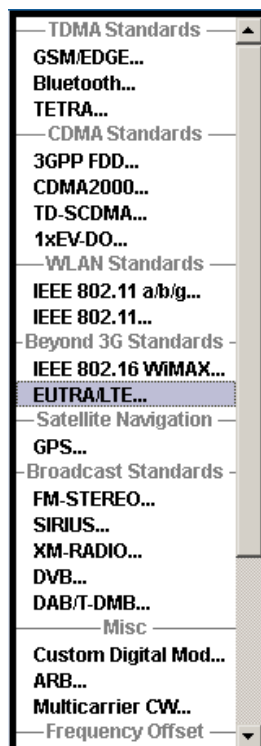

Fig. 23: Preprogrammed standards for a vector signal generator.

The individual communications standards generally specify test signals with a defined parameter configuration. In a vector signal generator, these signals can be preprogrammed. Fig. 24 shows a selection of these "test models" of the LTE standard (for the same generator).

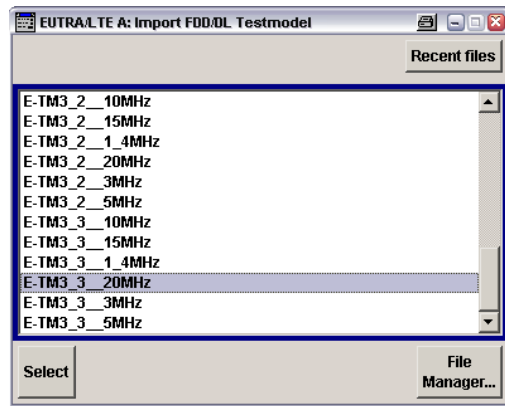

Fig. 24: Some of the preprogrammed test models for the LTE wireless communications standard.

Fig. 25 shows the spectrum for the E-TM3_3__20MHz test model selected in Fig. 24.

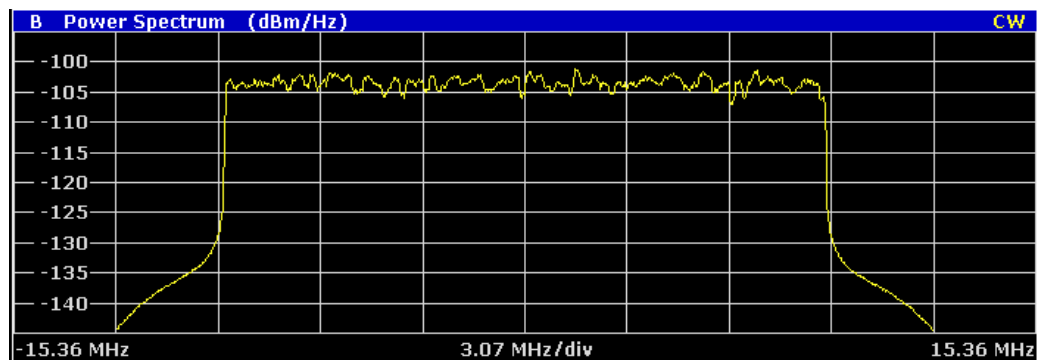

Fig. 25: Multicarrier spectrum for the E-TM3_3__20MHz test model from the LTE standard.

The spectrum is approximately 18 MHz wide. A closer examination reveals that it consists of 1201 OFDM single carriers that are each spaced apart by 15 kHz but merge into each other in this display due to the screen-resolution setting.

Fig.26 shows the test model's constellation diagram (IQ display).

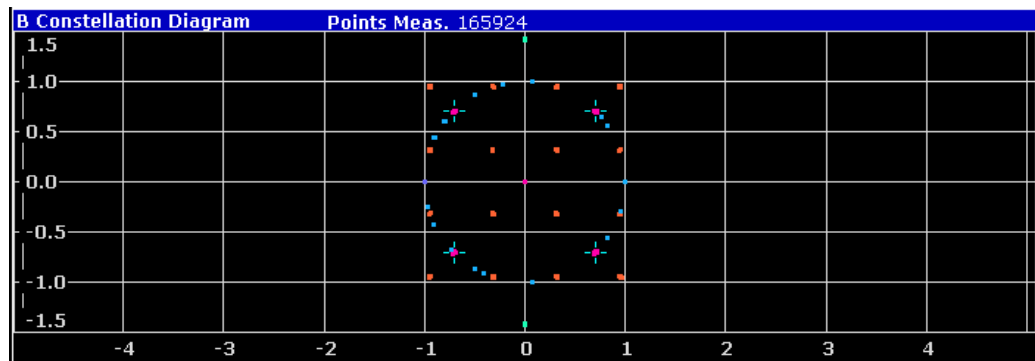

Fig.26: Overall constellation for the E-TM3_3_20MHz LTE test model.

With the signal used in this case, the individual channels are modulated differently. Here, all of the modulation types that are used are summarized in one representation: BPSK (cyan), QPSK (red with blue crosses), 16 QAM (orange) and the constant amplitude zero autocorrelation (CAZAC, blue) bits that are typical for LTE on the unit circle.

Vector signal generators usually provide convenient triggering capabilities. This makes it possible, for example, to fit generator bursts precisely into a prescribed time grid (such as putting GSM bursts into the right time slots).

Parallel with the data stream, the generators generally also supply what are known as marker signals at the device's jacks. These signals can be programmed for activation at any position in the data stream (e.g., at the beginning of a burst or frame) to control a device under test (DUT) or measuring instruments.

Unlike analog signals, digitally modulated signals sometimes have very high crest factors. This means that the ratio between the average value and peak value can often be more than 10 dB. Even small nonlinearities in the generator's amplifiers, mixers, and output stages can more easily cause harmonics and intermodulation products. In this respect, the quality of individual generators differs greatly.

Important characteristics for vector signal generators are the modulation bandwidth and the achievable symbol rate, the modulation quality (error vector magnitude [EVM]), and the adjacent channel power (ACP). State-of-the-art generators are prepared to meet future requirements, which means that they exceed the requirements of the current wireless communications standards significantly.

General criteria for selecting the instrument include (as with analog generators) the required output power, the settling time and accuracy for frequency and level, low VSWR, and sometimes the instrument's form factor and weight.

3.3 Arbitrary Waveform Generators (AWGs)

AWGs are vector signal generators for which the modulation data are calculated in advance (rather than in real time) and stored in the instrument's RAM. This RAM content is then read out at the real-time symbol rate. (Many vector signal generators are equipped with an AWG option; see the menu list in Fig. 23 on page xx.)

Regarding their use and applications, AWGs differ from real-time vector generators as follows:

- No restrictions exist for configuring the content of an AWG's IQ-data stream.
- It is only possible to use time-limited or periodically repeated signals (the RAM's depth is finite).

The IQ data sets' memory depth and word size are additional characteristics of AWGs.

As with real-time generators, there are different triggering options and the ability to output "marker signals" for controlling hardware and measuring instruments that are connected to the device.

For production tests, users can concatenate various sequences of different lengths (e.g., data streams with different bit rates that have to be checked during the manufacturing process).

Some AWGs can computationally generate additional Gaussian noise; some are also able to simulate multipath propagation (fading) or multi-antenna systems (MIMO). In all cases, this is done in real time in the baseband.

In many cases, vendors that offer AWGs also offer software for creating standard modulation sequences (IQ data sets). As an example, Fig. 27 on page xx shows several windows from such a program.

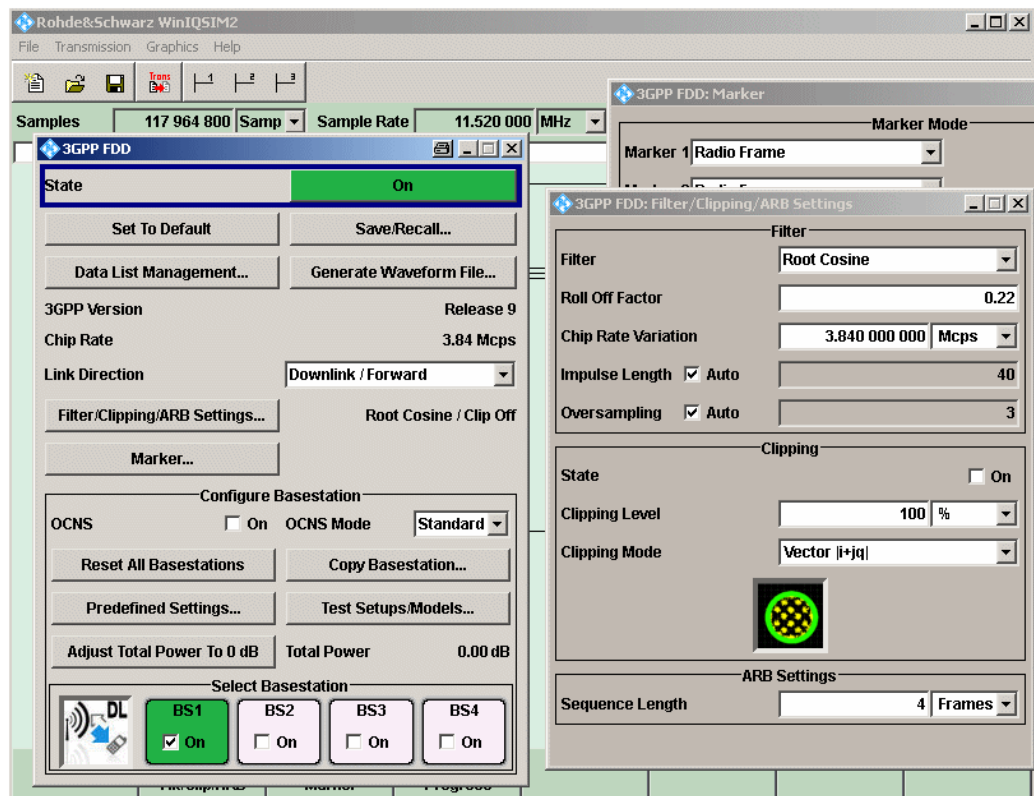

Fig. 27: PC program for calculating the IQ data for standard signals.

In the example shown here, the 3GPP FDD (UMTS) wireless communications standard has been selected. The system is creating a downlink, which is the signal from a base station (BS) to a mobile phone. The program can generate the signals from up to four BSs; in Fig. 27, only BS1 is active. The filtering complies with the UMTS standard. No *Clipping* is performed. Later, the *Marker1* device jack will deliver a signal with each new *Radio Frame*. Once all the required entries have been made, the user initiates calculation of the IQ data by clicking the *Generate Waveform File* button. Once that step is completed, the data are transferred from the program to the AWG, and the output can be started immediately.

4 Nonlinearities of the Device under Test (DUT)

For the most part, the structure and content of this chapter have been taken from the lecture notes on practical exercises entitled "Hochfrequenztechnik Labor, Spektrumanalysator" from the University of Graz, Austria [2]. Further information is available, for instance, in the white paper "Interaction of Intermodulation Products between DUT and Spectrum Analyzer" [4].

An ideal two-port device transfers signals from the input to the output without distorting them. The output signal follows any variation in the input signal in strict proportion. Only the same frequencies that are fed into the input arise at the output. The DUT, a real amplifier, is not an ideal two-port:

1. As the input power rises, the effective power gain decreases.
2. In addition, the higher-order harmonics and the intermodulation products from the input frequencies and their harmonics rise at the output.

This first observation describes an amplifier's large-signal behavior. Above a certain input level, the amplifier reaches saturation. The maximum permissible input level is defined by the 1 dB compression point.

The second observation describes the small-signal distortions that always arise. Even when driven with small signals, an amplifier's characteristic curve is never purely linear. The fact that spectral components that were not present in the input signal arise in the output signal can be substantiated mathematically. Specifying intercept points makes it possible to compare amplifiers and to properly dimension hardware setups.

(The fact that new spectral components arise at nonlinearities is, to some extent, employed intentionally in RF engineering, e.g., to multiply frequencies on a diode characteristic curve or to convert frequencies in mixers.)

4.1 1 dB Compression Point

An amplifier's "1 dB compression point" is defined as the output power at which the nominal gain has dropped by 1 dB. Correspondingly, the output power has decreased by 1 dB compared with the nominal output power. In Fig. 28, the 1 dB compression point is located at P_{1dB} .

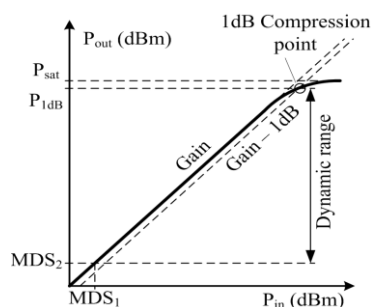

Fig. 28: Correlation between the input power (P_{in}) and output power (P_{out}) of an amplifier (logarithmic scale) with the 1 dB compression point.

The low end of the linear dynamic range is limited by the smallest signal power that can be differentiated from noise at the system's input. There must be a "minimum detectable signal" (MDS_1) present that is x dB larger than the unavoidable thermal noise floor (-174 dBm per Hz at 290 kbit). For most applications, the minimum signal power should be twice as large as the noise power; thus, x dB = 3 dB. When, however, we take the amplifier's actual bandwidth B and noise factor F into account, we arrive at the following:

$$MDS_1 = -174dBm + 10\log B + 10\log F + x \quad (23)$$

The following then holds true for the power that arises at the output in combination with gain G :

$$MDS_2 = -174dBm + 10\log B + 10\log F + x + 10\log G \quad (24)$$

When the level is rising, the 1 dB compression point defines the end of the linear area. The output power P_{1dB} supplied at this point is normally indicated in product data sheets as the maximum power that the amplifier can deliver.

$$P_{1dB} = P_{in1dB} + 10\log G - 1dB \quad (25)$$

The amplifier's linear dynamic range D is now the decrease in amplitude between the 1 dB compression point and the power generated at the output MDS_2 [2]:

$$D(dB) = P_{1dB}(dBm) + 174dBm - 10\log B - 10\log F - x - 10\log G \quad (26)$$

The more an amplifier is operated in the range that is no longer linear, the more the output power is spread into harmonics and intermodulation products. Power is then "shifted" to spectral components other than the ones that originally had the power (see the introduction to Chapter 4.)

For this reason, the 1 dB compression point must be determined in a frequency-selective manner using a spectrum analyzer. In such cases, a broadband thermal power meter registers the entire spectrum and delivers incorrect results.

4.2 Mathematic Description of Small-Signal Nonlinearities

One simple method that can be used to describe a nonlinear two-port is to express the output voltage $v_a(t)$ as a power series for the input voltage $v_m(t)$:

$$v_{out}(t) = \sum_{n=1}^{\infty} a_n \cdot v_{in}^n(t) = a_1 \cdot v_{in}(t) + a_2 \cdot v_{in}^2(t) + a_3 \cdot v_{in}^3(t) + \dots \quad (27)$$

Where

$v_{out}(t)$ Signal at the output port

$v_{in}(t)$ Signal at the input port

a_n Coefficient

In general, $v_{in}(t)$ is any band-limited signal in the time domain. If $v_{in}(t)$ is periodic, it can be described as the sum of sinusoidal signals with different amplitudes and frequencies (see Section 2.1).

Consequently, as a simplification, for the following derivatives, $v_{in}(t)$ is to first consist of two sinusoidal signals with the amplitudes V_1 and V_2 and the frequencies ω_1 and ω_2 :

$$v_{in}(t) = V_1 \cdot \sin(\omega_1 \cdot t) + V_2 \cdot \sin(\omega_2 \cdot t)$$

If this is plugged into Equation (27), the following results are reached when the angle theorems are applied:

$$\begin{aligned} v_{out}(t) = & \frac{1}{2} \cdot a_2 \cdot (V_1^2 + V_2^2) && \text{DC component} \\ & + (a_1 \cdot V_1 + \frac{3}{4} \cdot a_3 \cdot V_1^3 + \frac{3}{2} \cdot a_3 \cdot V_1 V_2^2) \cdot \sin(\omega_1 \cdot t) && \text{Fundamental (first harmonic)} \\ & + (a_1 \cdot V_2 + \frac{3}{4} \cdot a_3 \cdot V_2^3 + \frac{3}{2} \cdot a_3 \cdot V_1^2 V_2) \cdot \sin(\omega_2 \cdot t) \\ & - \frac{1}{2} \cdot a_2 \cdot V_1^2 \cdot \cos(2 \cdot \omega_1 \cdot t) && \text{Second harmonic} \\ & - \frac{1}{2} \cdot a_2 \cdot V_2^2 \cdot \cos(2 \cdot \omega_2 \cdot t) \\ & + a_2 \cdot V_1 \cdot V_2 \cdot \cos((\omega_2 - \omega_1) \cdot t) && \text{Second-order} \\ & - a_2 \cdot V_1 \cdot V_2 \cdot \cos((\omega_2 + \omega_1) \cdot t) && \text{intermodulation products} \\ & - \frac{1}{4} \cdot a_3 \cdot V_1^3 \cdot \sin(3 \cdot \omega_1 \cdot t) && \text{Third harmonic} \\ & - \frac{1}{4} \cdot a_3 \cdot V_2^3 \cdot \sin(3 \cdot \omega_2 \cdot t) \\ & + \frac{3}{4} \cdot a_3 \cdot V_1^2 V_2 \cdot \sin((2 \cdot \omega_1 - \omega_2) \cdot t) && \text{Third-order} \\ & - \frac{3}{4} \cdot a_3 \cdot V_1^2 V_2 \cdot \sin((2 \cdot \omega_1 + \omega_2) \cdot t) && \text{intermodulation products} \\ & + \frac{3}{4} \cdot a_3 \cdot V_1 V_2^2 \cdot \sin((2 \cdot \omega_2 - \omega_1) \cdot t) \end{aligned}$$

$$- \frac{3}{4} \cdot a_3 \cdot V_1 V_2^2 \cdot \sin((2 \cdot \omega_2 + \omega_1) \cdot t) \dots \tag{28}$$

The series is ended here after the third power.

This shows that other spectral components arise in addition to the fundamental: a DC component and harmonics with a multiple of the fundamental frequency, plus "intermodulation products" at the sums and differences of the fundamental frequencies and harmonics.

The order number for these spectral lines is defined by the number of terms required for the calculation. This calculation, for instance, requires three terms; consequently, it is a third-order frequency:

$$2\omega_1 - \omega_2 = \omega_1 + \omega_1 - \omega_2$$

When the stimulus signal has only one sine wave (V_1 or V_2 is equal to zero), there are no intermodulation products.

The frequencies that arise follow the rules for forming Pascal's triangle:

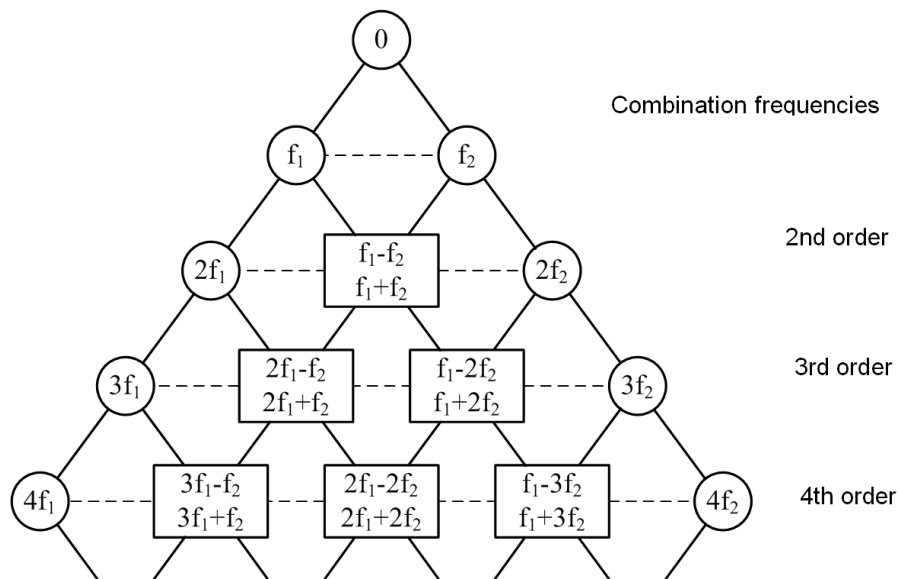

Fig. 29: A version of Pascal's triangle for forming the combination frequencies.

The polynomial's degree, *deg* (Equation 27) determines the highest order of the harmonics that arise or of the combination frequencies. The following applies:

$$|n_1| + |n_2| \leq G.$$

Where

- n_1 Number of terms f_1
- n_2 Number of terms f_2

Equation (28) was derived for voltages. One obtains the output power, when V is substituted with $\frac{V^2}{R}$. The equation maintains its form.

When comparing the coefficients of the individual spectral components in Equation (28), it becomes clear that the second-order intermodulation products are always 6 dB higher than the second harmonic and that the third-order intermodulation products are always 9.54 dB higher than the third harmonic. This is so because

$$(20 \cdot \log(\frac{1}{2})) = -6 \text{ dB} \quad \text{bzw.} \quad 20 \cdot \log(\frac{1/4}{3/4}) = -9.54 \text{ dB}.$$

The third-order intermodulation products are particularly important. These components are very pronounced, and some arise close to the fundamental frequencies. In practice, filtering out nearby interference signals is difficult.

With wireless communications systems, for instance, the adjacent channel might possibly be affected. For this reason, the various wireless communications standards always include measurements that examine the extent of the TX stage's emissions into the neighboring channel by measuring the adjacent channel leakage ratio (ACLR).

Fig. 30 shows the spectral components for a two-tone measurement (up to the third order) taken at an amplifier output.

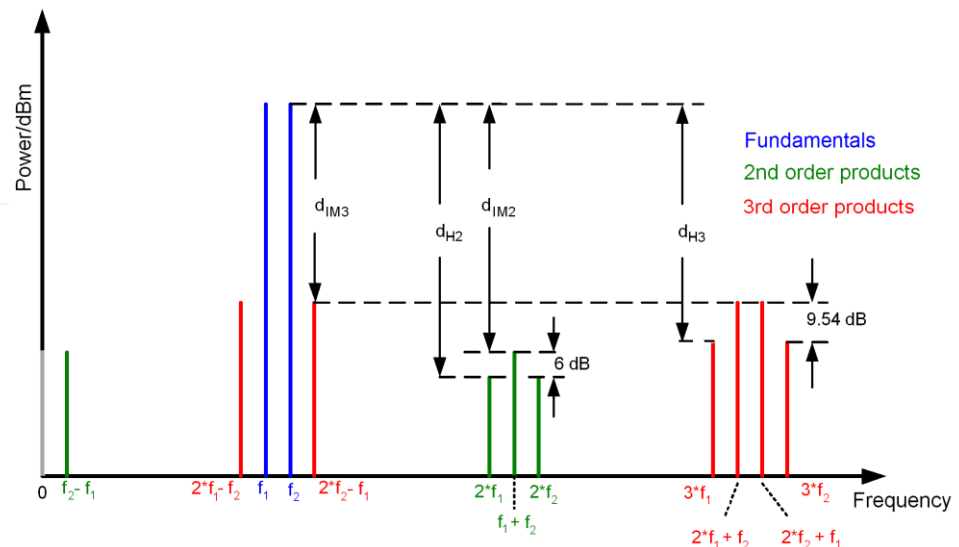

Fig. 30: Result of a two-tone measurement with the level differences for harmonics and intermodulation products.

Fig. 30 clearly shows that two third-order intermodulation products arise near the operating frequencies. The difference between the level of the wanted signals and level of the intermodulation products is referred to as the intermodulation distance (d_{IMv}). The difference in the level of the wanted signal and the level of the harmonics is called the harmonic distance d_{Hv} (and sometimes d_{kv}).

The current relationship between the levels for the various spectral components (as shown in Fig. 30, for example) is only valid for the current input or output level.

Equation (28) on page 42 was derived for two drive frequencies. The larger the number of frequencies that are applied, the more intermodulation products arise (see Fig. 31). Even when the nonlinearities are weak, a dense interference spectrum can arise. This is often observed, for example, in the case of cable TV systems that use many channels.

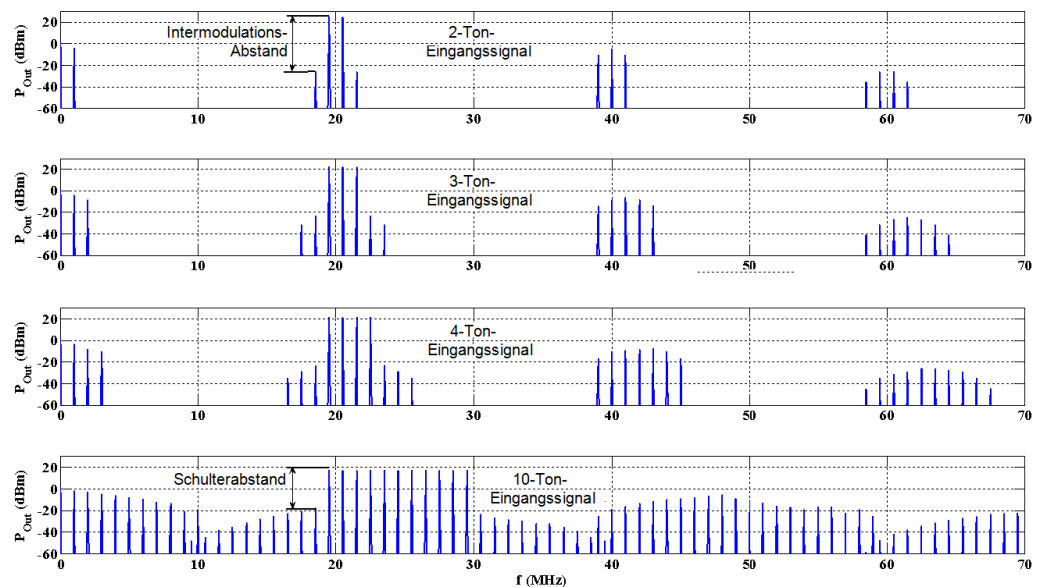

Fig. 31: Output spectra for slight nonlinearity for 2, 3, 4, and 10 carriers [2].

When the number of carriers rises (multicarrier systems), instead of intermodulation products, the "shoulder distance" is indicated to characterize the system's nonlinearity (Fig. 31).

With real multicarrier systems, the interference spectrum can take on noise-like characteristics.

The trace

The current relationship between the levels for the various spectral components (see Fig. 30) is only valid for the current input or output level. This section will discuss how the harmonics and the intermodulation products are a function of the drive level.

To simplify, we first set $V_1 = V_2 = 1$.

By ending after the third-order terms, Equation (28) on page xx ignores components; this begins as early as the fifth power on third-order frequencies. This is permissible as an approximation, because the absolute value of a spectral component decreases significantly as the order rises. For instance, with an average amplifier in its linear range, the third harmonic is usually already more than 30 dB below the fundamental, which means that coefficient a_3 in Equation (28) is much smaller than a_1 .

For this reason, for the fundamental, the term $\frac{3}{4} \cdot a_3 \cdot U_1^3 + \frac{3}{2} \cdot a_3 \cdot U_1 U_2^2$ can be ignored compared with $a_1 \cdot U_1$. For the following general assessment of the power, the stimulus $\sin(\omega_v \cdot t)$ is also left out. The goal here is not to determine the behavior in the time domain, but rather to determine the relationships between the individual spectral components. Because Equation (28) is also valid for powers, one arrives at the following when both input signals have the same level:

$$P_{f0} = a_2 \cdot P^2 \quad \text{DC component} \quad (29a)$$

$$P_{f1} = a_1 \cdot P \quad \text{Fundamental (first harmonic)}$$

$$P_{f2} = a_1 \cdot P \quad (29b)$$

$$P_{2f1} = \frac{1}{2} \cdot a_2 \cdot P^2 \quad \text{Second harmonic}$$

$$P_{2f2} = \frac{1}{2} \cdot a_2 \cdot P^2 \quad (29c)$$

etc.

In a logarithmic representation, the following arises:

$$\log P_{f0} = \text{const}_2 + 2 \cdot \log P \quad \text{DC component} \quad (30a)$$

$$\log P_{f1} = \text{const}_1 + 1 \cdot \log P \quad \text{Fundamental (first harmonic)}$$

$$\log P_{f2} = \text{const}_1 + 1 \cdot \log P \quad (30b)$$

$$\log P_{2f1} = \text{const}_{21} + 2 \cdot \log P \quad \text{Second harmonic}$$

$$\log P_{2f2} = \text{const}_{21} + 2 \cdot \log P \quad (30c)$$

$$\log P_{f2-f1} = \text{const}_{22} + 2 \cdot \log P \quad \text{Second-order}$$

$$\log P_{f2+f1} = \text{const}_{22} + 2 \cdot \log P \quad \text{intermodulation products} \quad (30d)$$

$$\log P_{3f1} = \text{const}_{31} + 3 \cdot \log P \quad \text{Third harmonic}$$

$$\log P_{3f2} = \text{const}_{31} + 3 \cdot \log P \quad (30e)$$

$$\log P_{3f1-f2} = \text{const}_{32} + 3 \cdot \log P \quad \text{Third-order}$$

$$\log P_{3f1+f2} = \text{const}_{32} + 3 \cdot \log P \quad \text{intermodulation products}$$

$$\log P_{3f2-f1} = \text{const}_{32} + 3 \cdot \log P$$

$$\log P_{3f2+f1} = \text{const}_{32} + 3 \cdot \log P \quad (30f)$$

For operation in the amplifier's linear range, it follows from the discussion above that:

- If the input is increased by 1 dB in each case, the fundamental's output power also increases by 1 dB.
- If the input is increased by 1 dB in each case, the output power for the spectral components of the n -th order increases by n dB.
- This holds true for harmonics and for intermodulation products. If, for example, an amplifier's input level is increased by 3 dB, the third-order intermodulation product grows by 9 dB.

Fig. 32 illustrates this relationship using the second- and third-order intermodulation products as an example.

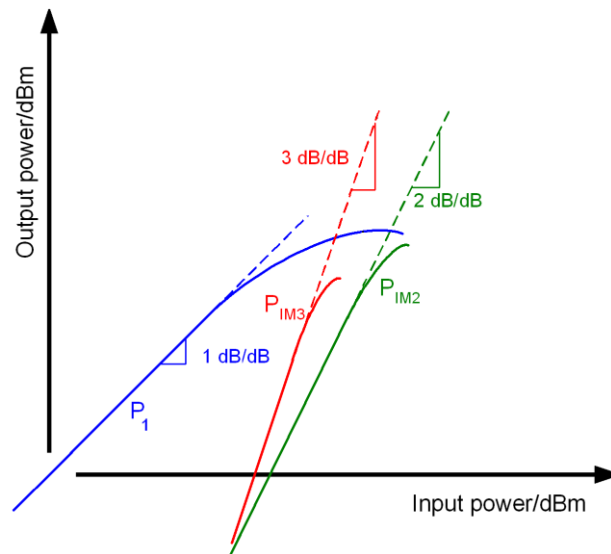

Fig. 32: Characteristic curves for the fundamental (blue) and for the second-order (green) and third-order (red) intermodulation products.

In Fig. 32, the curve for the second harmonic lies 6 dB below the green curve, and the curve for the third harmonic lies 9.54 dB below the red curve.

4.3 Intercept Points IP2 and IP3

The harmonics and intermodulation products that arise for a nonlinear two-port depend on the input level. For example, to compare an amplifier independently of the excitation and to estimate the interference that is to be expected from a specific drive level, intercept points were introduced.

In the logarithmic representation of output power vs. input power, interfering spectral components (in the two-port's linear range) take the form of straight lines. The characteristic curves for components of the n -th order exhibit a slope of n dB per 1 dB of change in the input power.

If the straight characteristic curves – for example, for the second and third intermodulation products in the diagram – are extrapolated far beyond the possible operating range, these straight lines intersect with the extrapolated lines for the fundamental frequency (see Fig. 33).

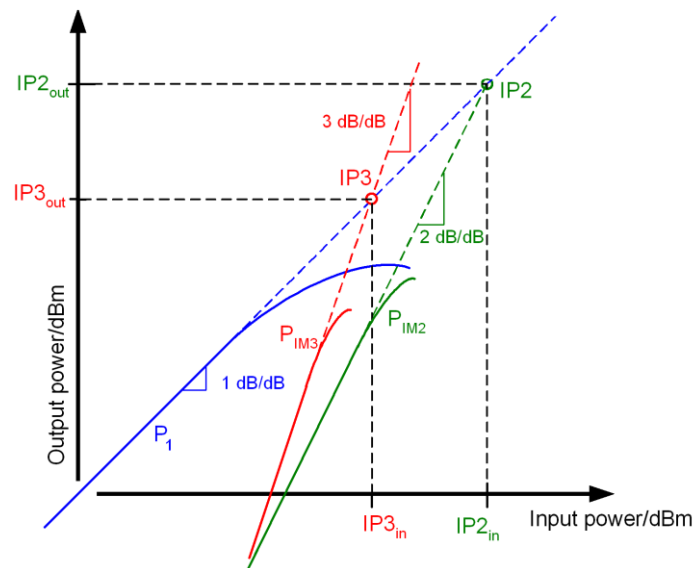

Fig. 33: Determining the (fictitious) intercept points.

The points at which these lines intersect are defined as the intercept points. Determining the intercept points depends on which spectral components are being observed:

- The intercept points for the second- and third-order harmonics are referred to as the second-order harmonic intercept point (SHI) and third-order harmonic intercept point (THI).
- The intercept points for the second- and third-order intermodulation products are expressed simply as the second-order intercept point (SOI) and third-order intercept point (TOI).

In practice, the intercept point for the third-order intermodulation products (the TOI) is of utmost interest (e.g., this value is generally specified in product data sheets).

These intermodulation products are particularly pronounced, and some are very close to the wanted frequencies, making them difficult to suppress with filters. Higher-order harmonics, on the other hand, generally have very low levels and can usually be ignored.

For applications that use pure, unmodulated signals, the THI is of interest. The THI is located 9.54 dB above the TOI.

Knowing the (fictitious) output power at the intercept points makes it possible to predict the levels that can be expected for the harmonics or for intermodulation products in the selected operating range:

For an output signal that is x dB below the n -th-order IPs, the power P_n for the n -th component is:

$$P_n = \text{fictitious output power for IP}_n - n \cdot x \quad (31)$$

For example, an output signal that is 40 dB below a TOI of 35 dBm comes with a third-order intermodulation product of the power P_3 :

$$P_3 = 35\text{dBm} - 3 \cdot 40\text{dB} = -85\text{dBm}$$

From a test and measurement perspective, two methods are used to determine the intercept points:

- Measure the spectral components with a sinusoidal input signal, or
- Use the two-tone method (See Section 4.2).

Measuring harmonics with a pure sinusoidal input signal requires a high dynamic range. This is done by performing multiple series of measurements to determine the characteristics and then plotting them on a graph and extrapolating the curves by extending them with straight lines that have the corresponding slopes. The power at the intercept points of the fundamental line and the corresponding interference lines can then be read from the graph or calculated using the formula below. Performing test series to measure the data only makes sense when the intention is to work with pure sinusoidal signals.

The dynamic-range requirements are less stringent for the two-tone measurement method because the IPs are higher than the harmonics. That makes the measurement more reliable. Because they are close together, the important IM3 products and the fundamentals can be captured together in one span. The intercept point can then be determined with a single two-tone measurement and a simple calculation.

The calculation exploits the fact that the n -th order characteristic curve rises by n dB per 1 dB. In such a case, one can imagine the extrapolation of the straight lines as a diagonal inside a rectangle with an aspect ratio of 2:1 for second-order components or 3:1 for third-order components (See Fig. 34).

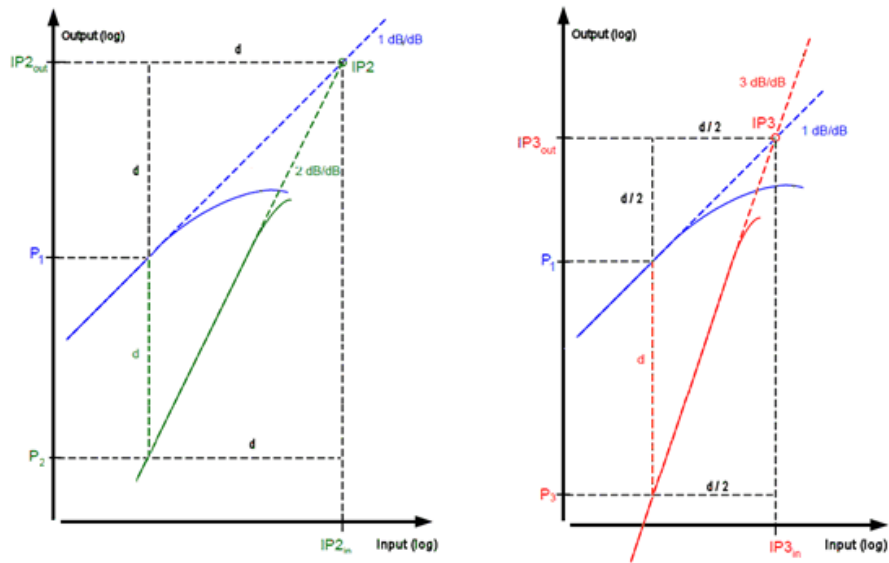

Fig. 34: Geometric considerations for calculating the intercept points.

The SOI can be obtained by taking the difference d from the measured second-order line and adding it to the current amplifier output power, P_1 . The TOI can be determined by taking half the difference from the measured third-order line and adding it to the current amplifier output power, P_1 , and so forth.

$$IP_n = P_1 + \frac{d}{n-1} \quad (32)$$

Advanced spectrum analyzers support the two-tone method for the TOI: They analyze the spectrum and supply numeric values for the TOI.

5 Crest Factor and Complementary Cumulative Distribution Function (CCDF)

This chapter covers RF signals that have a high crest factor, i.e., signals with peaks high above the RMS value:

$$C_F = \frac{\textit{Peak}}{\textit{RMS}}$$

Those types of signals arise primarily when advanced digital modulation schemes such as n-Phase Shift Keying (nPSK), Quadrature Modulation (QAM), Code Division Multiple Access (CDMA), or Orthogonal Frequency Division Multiplex (OFDM) are employed. Signals with a high crest factor arise in cellular networks, in digital television, and in many broadband transmission systems. In the time domain, as in the allocated frequency range, these signals are similar to thermal noise at first glance.

An RF signal's crest factor can refer to the overall signal or only to the modulated envelope. The discussion below is based exclusively on the latter view (modulated envelope). Consequently, the crest factor is the same for generation in the baseband as it is for the operating frequency: The crest factor for an unmodulated RF signal is $C_F = 0$. If the first perspective had been taken, its crest factor would have been $C_F = 3.01$ dB (sine-wave carrier).

Indicating the crest factor in dB makes sense in that only one value is required to examine both the voltage and power levels.

The crest factor focuses the view on the signal peaks. This is important for configuring a system to have the proper amount of electrical strength.

In practice, however, the probability of signal peaks arising is low. The probability of what the level might be at a given point in time is determined using the complementary cumulative distribution function (CCDF). Advanced spectrum analyzers offer this measurement function (see Fig. 35 page 54).

The yellow line shows the probability that certain levels will be exceeded. This line is typical in that a relative flat beginning is followed by a rapidly increasing drop. This means that the larger the peaks, the lower the probability that they will arise. A theoretical maximum level can be calculated.

For reference purposes, the red line shows the CCDF for white noise. Unlike the CCDF for the 3GPP-FDD signal, in this case, there is no rapid decrease of that kind and no maximum level. Theoretically, over the course of an infinite acquisition time (AQT), an infinitely high level would arise at least once.

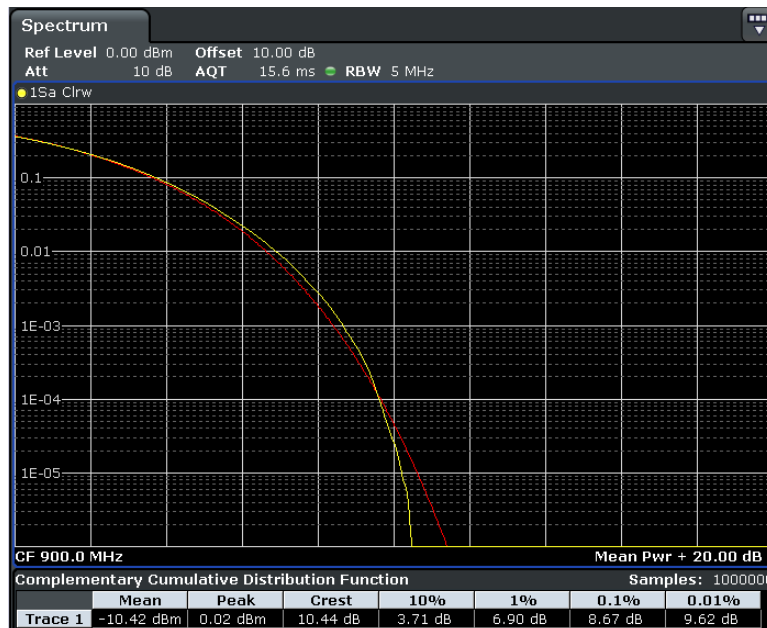

Fig. 35: CCDF for a UMTS signal, derived from 1,000,000 samples.

Significant, individual measurement results are indicated numerically on the bottom edge of the screen: For example, for 10% of the observation period, the average value is exceeded by more than approximately 3.71 dB. This also means that for 90% of the observation period, the signal remains below the level equal to approximately twice the RMS value (more precisely, below the RMS value + 3.71 dB).

The CCDF derives frequency distribution for the level and for the RMS value from many individual measurements. The longer the measurement period, the more measurements are made, and, as a result, more "rare" levels can be acquired. Consequently, the numerically indicated crest factor in the figure refers to the AQT of 15.6 ms selected here. With the R&S[®] FSV, this corresponds to a count of exactly 10^6 samples. From a statistical perspective, no events with a probability of $< 10^{-6}$ will be acquired within this time frame. (To acquire components for which $P < 10^{-6}$, 10^{-7} to $< 10^{-8}$ samples should be considered.)

The signal peaks that can arise in a system directly influence the selection and dimensioning of the required components. Transmitter and receiver antennas, for instance, must be configured to achieve sufficient electrical strength. Voltage flashovers usually put electric components out of operation immediately. Passive elements, such as cables, are also susceptible to permanent damage from even just one overvoltage event.

When a drive signal's peaks extend into an amplifier's nonlinear range, powerful, unwanted intermodulation products can arise both in the operating frequency range and at adjacent frequencies (spectral regrowth). For this reason, all wireless communications standards, for instance, require tests to keep these undesired products below the useful-channel power by a certain minimum amount, which is known as the minimal "adjacent channel leakage ratio" (ACLR).

In practice, to be able to use components that do not have the ability to withstand such high loads, and thus to lower costs, engineers reduce a signal's crest factor by cutting off the signal peaks, a process known as "clipping." Theoretically, this does not influence the ACLR. Nevertheless, by its very nature, clipping lowers the signal quality and thus the transmission reliability. A measurement of modulation errors, the error vector magnitude (EVM) rises, and the bit error rate increases. With digital transmissions systems, it is assumed, however, that rare bit or symbol errors that could arise in the clipped peaks can be tolerated and corrected by implementing effective methods for error detection. The percentage of the signal that can be clipped without exceeding a certain EVM must be examined carefully in each individual case.

When the peaks of a modulated signal are reduced to 50% of the maximum value, for instance, the signal's crest factor does not decrease in equal measure by half (i.e., by 3 dB). This is due to the fact that when the peaks are cut off, not only does the maximum value change but also the average value has to be recalculated. The new ratio depends on the current signal statistics.

Modern digital modulation schemes always map a fixed number of bits into symbols and then transmit those symbols. A "constellation diagram" shows the modulation signal's phase and amplitude states for each symbol (see Fig. 36).

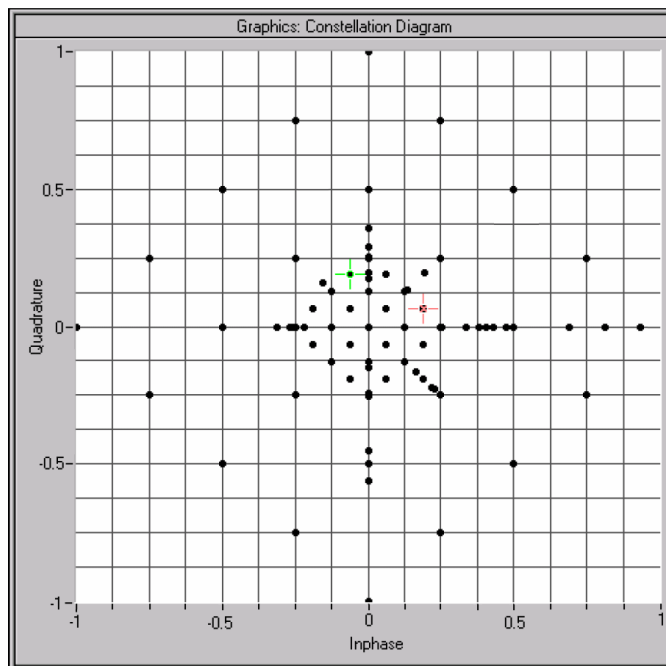

Fig. 36: Sum constellation of a UMTS signal without clipping.

In this example, the symbols of all the transmission channels in one UMTS signal are displayed. (Here, groups of channels are modulated in different ways.)

The distance of each symbol point from the diagram's origin is proportional to the modulation signal's amplitude for this symbol; its angle determines the phase. The amplitudes are normalized to 1: All symbols are located within a circle or on the circle around the origin with a radius of 1. Clipping to 50% means that all points outside a new circle with the radius of 0.5 in the constellation diagram are moved to this circle, preserving the angles.

As can be seen in Fig. 37, after clipping, it makes sense to normalize again to achieve the maximum word size and thus return to the digital signal processing's highest dynamic range. All symbols are stretched "outward" to the unit circle. This increases the average value at the same peak amplitude as before, and the crest factor decreases. The automatic level control in a signal generator reduces amplification of the output stage to maintain the RMS value.

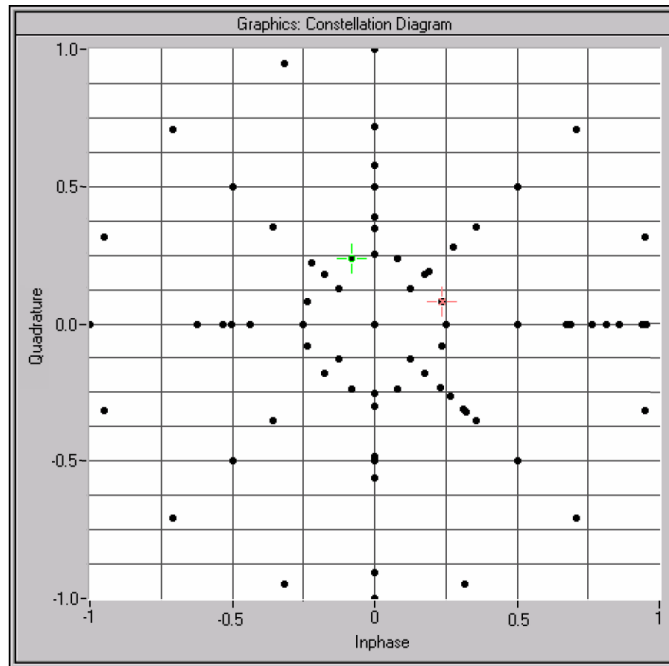

Fig. 37: Sum constellation for a UMTS signal after a 50% clipping.

Theoretically, clipping does not influence the ACLR. Nonetheless, because the crest factor becomes lower while the signal's RMS value remains the same, a lower peak modulation amplitude arises at an amplifier's input. This can lower the ACLR at the output.

6 Phase Noise

The information provided in this chapter has been taken largely from the application note "Phase Noise Measurements with Spectrum Analyzers of the FSE Family" by Josef Wolf [6].

Phase noise describes a frequency's short-term stability, which makes it one of the signal source's important characteristics (along with other characteristics such as the frequency range and long-term stability, power, and spectral purity).

An oscillator's phase noise is the reason why the oscillator not only appears as a line in the spectrum, but also appears continuously at frequencies below and above the target frequency – although the probability decreases sharply as the distance increases.

Phase noise, or rather the measurement of the phase noise of oscillators and synthesizers, is very important, particularly in wireless transmission systems. With receivers, the conversion oscillators' phase noise reduces sensitivity in adjacent channels when a strong input signal is present. With transmitters, the oscillator's phase noise is, together with the modulator characteristics, responsible for the undesired power emitted in the adjacent channels.

Mathematically, the output signal $u(t)$ of an ideal oscillator can be described as follows:

$$v(t) = V_0 \sin(2\pi f_0 t) \quad \text{Where}$$

V_0 Signal amplitude
 f_0 Signal frequency and
 $2\pi f_0 t$ Signal phase

With real signals, both the signal's amplitude and its phase are subject to variation:

$$v(t) = (V_0 + \varepsilon(t)) \sin(2\pi f_0 t + \Delta\varphi(t)) \quad \text{Where}$$

$\varepsilon(t)$ The signal's amplitude variation and
 $\Delta\varphi(t)$ The signal's (phase variation or) phase noise

When working with the term $\Delta\varphi(t)$, it is necessary to differentiate between two types:

- Deterministic phase variation due, for instance, to AC hum or to insufficient suppression of other frequencies during signal processing. These fluctuations appear as discrete lines of interference.
- Random phase variation caused by thermal, shot, or flicker noise in the active elements of oscillators.

One measure of phase noise is the noise power density with reference to 1 Hz of bandwidth:

$$S_{\Delta\phi}(f) = \frac{\Delta\phi_{rms}^2 \text{ rad}^2}{1\text{Hz} \cdot \text{Hz}}$$

In practice, single-sideband (SSB) phase noise L is usually used to describe an oscillator's phase-noise characteristics. L is defined as the ratio of the noise power in one sideband (measured over a bandwidth of 1 Hz) P_{SSB} to the signal power $P_{Carrier}$ at a frequency offset f_m from the carrier).

$$L(f_m) = \frac{P_{SSB}[1\text{Hz}]}{P_{Carrier}}$$

If the modulation sidebands are very small due to noise, e.g., if phase deviation is much smaller than 1 rad, the SSB phase noise can be derived from the noise power density:

$$L(f) = \frac{1}{2} S_{\Delta\phi}(f)$$

The SSB phase noise is commonly specified on a logarithmic scale [dBc / Hz]:

$$L_c(f_m) = 10\log(L(f_m))$$

Measurement methods

The simplest and fastest way to determine an oscillator's phase noise is to perform a direct measurement using a spectrum analyzer.

For this measurement, these conditions must be met:

- The frequency drift of the device under test (DUT) must be small relative to the spectrum-analyzer sweep time. Otherwise, the signal-to-noise ratio will not be calculated correctly. The synthesizers commonly used in radiocommunications always fulfill this condition. The DUT can be locked to a reference of sufficient stability, or the DUT and analyzer can be synchronized directly.
- The spectrum analyzer's phase noise and AM noise must be low enough to ensure that the focus is on the DUT's phase noise and that it is not the spectrum analyzer's characteristics that are measured. The analyzer always provides the sum of the DUT's AM noise and phase noise and its own phase noise and AM noise.
- The DUT's amplitude noise must be significantly lower than the phase noise. This requirement is certainly met in the range close to the carrier frequency.

7 Mixers

The explanations provided in this chapter are primarily from the "Upconverting Modulated Signals to Microwave with an External Mixer and the R&S®SMF100A" application note by C. Tröster, F. Thümmel and T. Röder [7].

Mixers are three-port components with two inputs and one output. An ideal mixer multiplies the two signals fed into its input ports. This makes it possible to convert signals to different frequencies. In the case of sinusoidal signals where

$$f_1 = \omega_1 / 2\pi \quad \text{and} \quad f_2 = \omega_2 / 2\pi ,$$

it is possible to transform the multiplication operation

$$A(t) = A_1 \sin(\omega_1 t + \varphi_1) \cdot A_2 \sin(\omega_2 t + \varphi_2) \text{ as follows:}$$

$$= \frac{A_1 A_2}{2} \left\{ \cos[(\omega_1 - \omega_2)t + (\varphi_1 - \varphi_2)] - \cos[(\omega_1 + \omega_2)t + (\varphi_1 + \varphi_2)] \right\}$$

This equation shows that the output signal from a mixer that multiplies in an ideal way consists of (exactly) two frequency components: One is the sum of the two input signals, and the other is the difference between them.

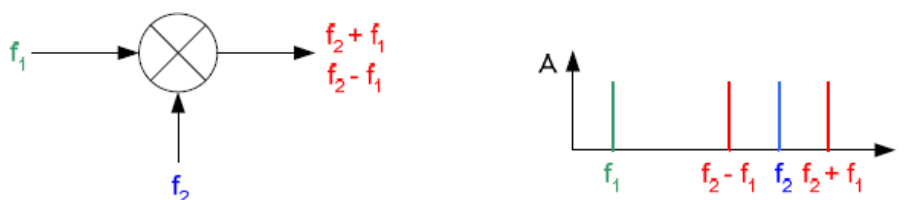

Fig. 39: Input and output signals of an ideal mixer.

In standard nomenclature, the mixer ports are referred to as the RF port, the local oscillator (LO) port, and the intermediate frequency (IF) port. If the mixer operates as an upconverter (meaning that its output frequency is higher than its input frequency, as shown in Fig. 39), the IF port serves as the input, and the RF port as the output. Conversely, with a downconverter (when the output frequency is lower than the input frequency), the RF port serves as the input and the IF port as the output. In both cases, a constant signal is applied at the LO at a fixed power level and at the suitable frequency.

A spectrum at the input (e.g., with a modulated signal) appears – once in the normal position and once in the inverted position – in the output signal spectrum as the upper and lower sideband. Generally, only one sideband is used, and the other is filtered out. The characteristics of a real-world mixer differ from the theoretical ideal. The primary characteristic variables for a real mixer are:

- Conversion loss
- Isolation
- Harmonics and intermodulation products
- Linearity, 1 dB compression
- Impedance and voltage-standing-wave-ratio (VSWR)

The relative importance of these individual characteristics varies depending on the application at hand. For example, with an upconverter employed in a transmission system, the harmonics and the intermodulation products determine the quality of the overall system.

Conversion loss

Conversion loss is a measure of how efficiently a mixer transports the input signal's energy to the output and is defined as the ratio between the input power and output power. Conversion loss depends on the frequencies that are used on the signal level itself and on the power level at the LO. In particular, the broadband signals used in advanced communications technology require a flat curve for the frequency response.

Isolation

Isolation is a measure of the signal leakage or "crosstalk" between mixer ports.

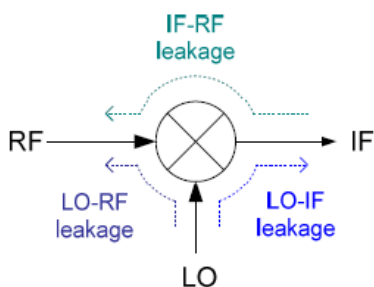

Fig. 40: Signal leakage in a mixer.

Generally, the level at the LO is very high compared, for instance, with the level at the signal input. For this reason, even with good mixers, the LO frequency is usually clearly visible in the output signal spectrum. Particularly with upconverters, LO-RF isolation is the most important parameter; the smaller the LO component in the output signal, the higher the quality.

Harmonics and mixing products

An ideal mixer produces exactly two frequencies:

$$f = |f_{LO} \pm f_{in}|.$$

A real mixer, on the other hand, produces mixing products and harmonics in accordance with the formula

$$f_{\mu,\nu} = |\mu \cdot f_{LO} + \nu \cdot F_{in}|$$

where μ and ν are integers (...,-2, -1, 0, 1, 2,...). For example, the lower sideband arises with the values $\mu = 1$ and $\nu = -1$, and the upper sideband arises with the value $\mu = \nu = 1$. The individual components differ inherently in amplitude. The lower and upper sidebands are the strongest mixer products; all other mixing products have lower amplitudes. Nevertheless, those other products can still result in a relatively large power level in the output spectrum. That is particularly true for the LO harmonics.

The higher f_{LO} is, the higher the frequencies of the LO harmonics. Because the system is band-limited at the mixer output, these harmonics do not appear in their full strength.

Linearity

With mixers, as with amplifiers, the power level at the output only remains proportional to the level at the input within a certain range. At a certain input power, the output signal begins to reach saturation. The 1 dB compression point is defined as the input power at which the output power sinks to 1 dB below the ideal linear characteristic curve.

The difference in amplitude between the noise floor and the 1 dB compression point is referred to as the (linear) dynamic range.

Intermodulation products

Like amplifiers, mixers do not offer ideal linearity, even when they are driven within the range below the 1 dB compression point. For this reason, when two or more signals are applied simultaneously at the input, a whole series of intermodulation products – most of which are interference – arise at the output (in addition to the harmonics and mixing products with the LO signal).

When there are two signals with the frequencies f_1 and f_2 at the input of a component that is not ideally linear, the output contains spectral components at the frequencies

$$f_{n,m} = |n \cdot f_1 + m \cdot f_2|$$

where m and n are integers (...,-2, -1, 0, 1, 2,...). The most problematic type are the third-order intermodulation products at the frequencies $2 \cdot f_1 - f_2$ and $2 \cdot f_2 - f_1$, because they are close to the fundamental frequency.

The same principles and measurement procedures apply here as do those for amplifiers.

8 References

- [1] Rauscher, Christoph. *Fundamentals of Spectrum Analysis*. Munich, Germany: Rohde & Schwarz[®], 5th Edition, 2011.
- [2] Leitinger, Erik; Magerl, Gottfried; Gadringer,, Michael. Radio Frequency Equipment Lab, Spectral Analysis, Script for Lab Exercise Technical Universities of Graz and Vienna, Austria, 2011.
- [3] Minihold, Roland. Measuring the Nonlinearities of RF Amplifiers Using Signal Generators and a Spectrum Analyzer, Application Note 1MA71. Munich, Germany: Rohde & Schwarz[®], 2006.
- [4] Simon, Michael. Interaction of Intermodulation Products between DUT and Spectrum Analyzer, White Paper. Munich, Germany, Rohde & Schwarz[®], 2012.
- [5] Kaes, Bernhard. The Crest Factor in DVB-T (OFDM) Transmitter Systems and its Influence on the Dimensioning of Power Components, Application Note 7TS02_2E. Munich, Germany: Rohde & Schwarz[®], 2007
- [6] Wolf, Josef. Phase Noise Measurements with Spectrum Analyzers of the FSE Family, Application Note 1EPAN 16E. Munich, Germany: Rohde & Schwarz[®], 1995.
- [7] Tröster, C; Thümmel, F; Röder, T. Upconverting Modulated Signals to Microwave with an External Mixer and the R&S[®]SMF100A, Application Note 1GP65. Munich, Germany: Rohde & Schwarz[®], 2008.

About Rohde & Schwarz

Rohde & Schwarz is an independent group of companies specializing in electronics. It is a leading supplier of solutions in the fields of test and measurement, broadcasting, radiomonitoring, and radiolocation, as well as secure communications. Established more than 75 years ago, Rohde & Schwarz has a global presence and a dedicated service network in more than 70 countries. Company headquarters are in Munich, Germany.

Regional contact

Europe, Africa, Middle East

+49 89 4129 12345

customersupport@rohde-schwarz.com

North America

1-888-TEST-RSA (1-888-837-8772)

customer.support@rsa.rohde-schwarz.com

Latin America

+1-410-910-7988

customersupport.la@rohde-schwarz.com

Asia/Pacific

+65 65 13 04 88

customersupport.asia@rohde-schwarz.com

China

+86-800-810-8228 /+86-400-650-5896

customersupport.china@rohde-schwarz.com

testforce

+1(888) 880-6804

sales@testforce.com

