

7.1V Ultra-stable reference ----- xDevs.com FX -----

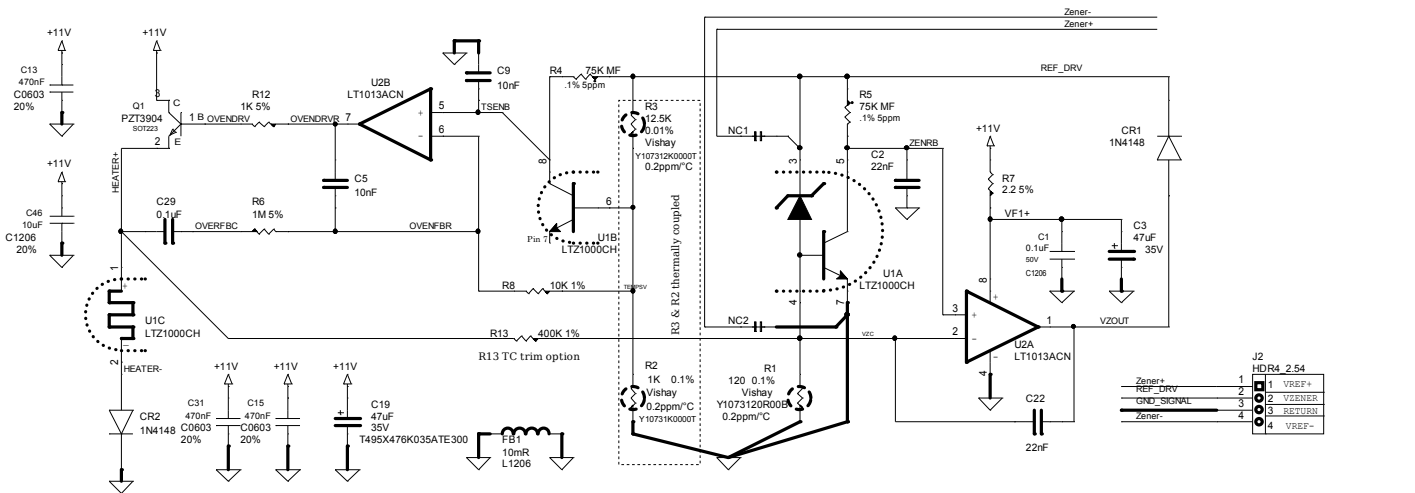

Low-noise linear PSU ----- 7V -> 10V gain stage -----

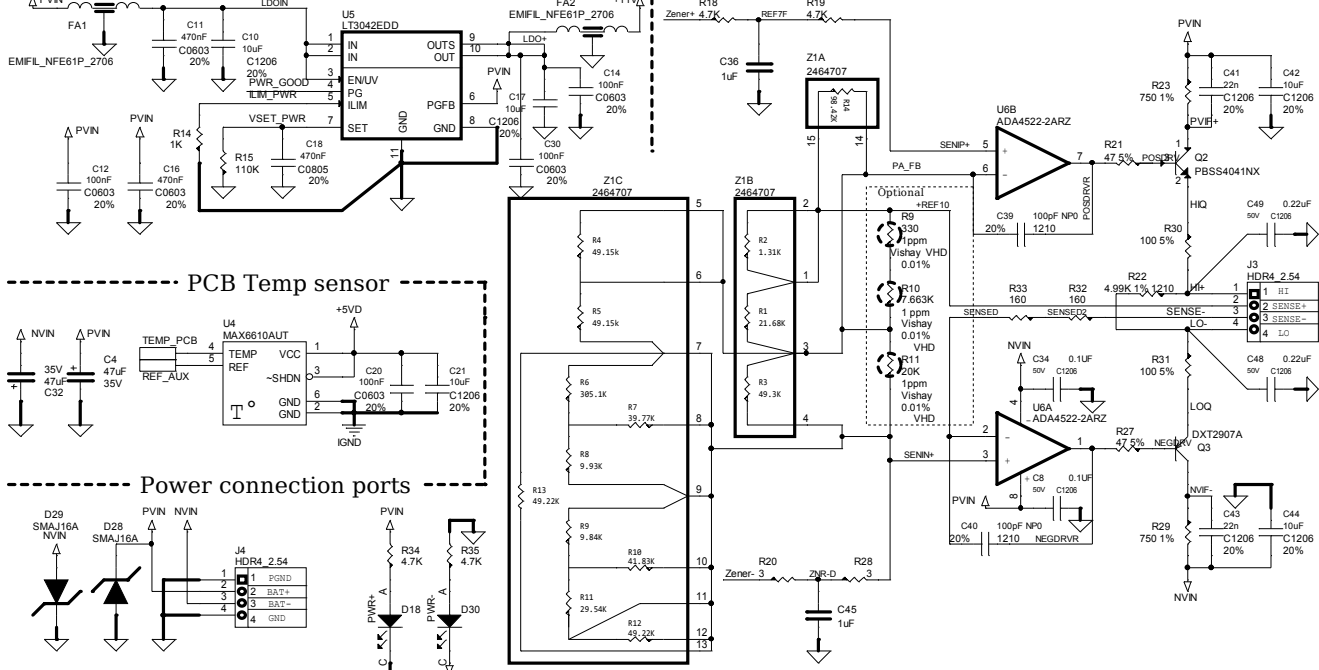

PCB Temp sensor

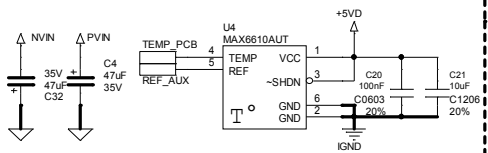

Power connection ports

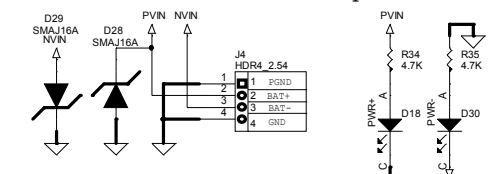

Aux Power

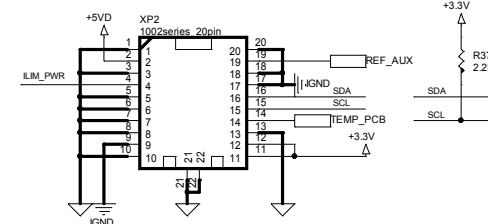

EEPROM

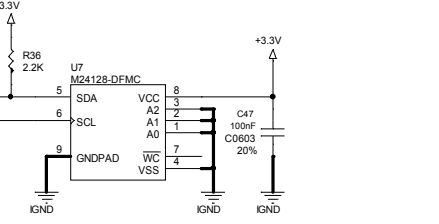

Kelvin sense output only

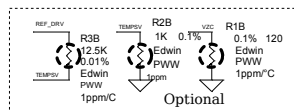

Title		
xDevs.com FX reference		
Size	Document Number	Rev
Custom <Doc>		0.0
Date:	Friday, November 10, 2017	Sheet 1 of 1