

## General Description

The DS28E80 evaluation system (EV system) consists of a single evaluation kit (EV kit) that includes a package of five DS28E80 devices in a 6-pin TDFN package, a DS9120Q+ socket board with RJ11 cable, and a DS9481R-3C7+ USB-to-1-Wire®/iButton® adapter with USB cable for PC connectivity. This EV system provides the special hardware and software system to exercise the features of the DS28E80. The evaluation software runs under Windows® 8, Windows 7, Windows Vista®, and Windows XP® operating systems (32-bit and 64-bit versions). It provides a handy user interface to exercise the DS28E80 features.

The DS28E80 is a user-programmable nonvolatile memory chip. In contrast to the floating-gate storage cells, the DS28E80 employs a storage-cell technology that is gamma radiation resistant. The DS28E80 has 248 bytes of user memory, organized in blocks of 8 bytes. Individual blocks can be write-protected. Each memory block can be written eight times. The DS28E80 communicates over the single-contact 1-Wire bus at standard speed or overdrive speed. Each device has its own guaranteed unique 64-bit registration number factory programmed into the chip. The communication follows the 1-Wire protocol with a 64-bit registration number acting as node address in the case of a multiple-device 1-Wire network.

**Ordering Information appears at end of data sheet.**

## Benefits and Features

- Demonstrates the Features of the DS28E80 IC
- 1-Wire USB Adapter Creates a Virtual COM Port on Any PC
- Fully Compliant with USB 2.0 Specification
- Standard USB Cable Interface
- Software Runs on Windows 8, Windows 7, Windows Vista, and Windows XP Operating Systems (32-Bit and 64-Bit Versions)
- 3.3V ±3% 1-Wire Operating Voltage
- Convenient On-Board Test Points and TO-92 Socket
- Standard RJ11 Connector Interfaces to DS9120 Socket Boards
- Evaluation Software Available Upon Request
- Proven PCB Layout
- Fully Assembled and Tested

## EV Kit Contents

QTY	DESCRIPTION
5	DS28E80Q+ 1984-bit gamma radiation resistant 1-Wire memory (6-pin TDFN)
1	DS9120Q+ socket board (TDFN, TO-92)
1	DS9481R-3C7+ USB-to-1-Wire/iButton adapter
1	USB type-A to Mini-USB type-B cable
1	RJ11 cable

*1-Wire, and iButton are registered trademarks of Maxim Integrated Products, Inc.*

*Windows, Windows Vista, and Windows XP are registered trademarks and registered service marks of Microsoft Corporation.*

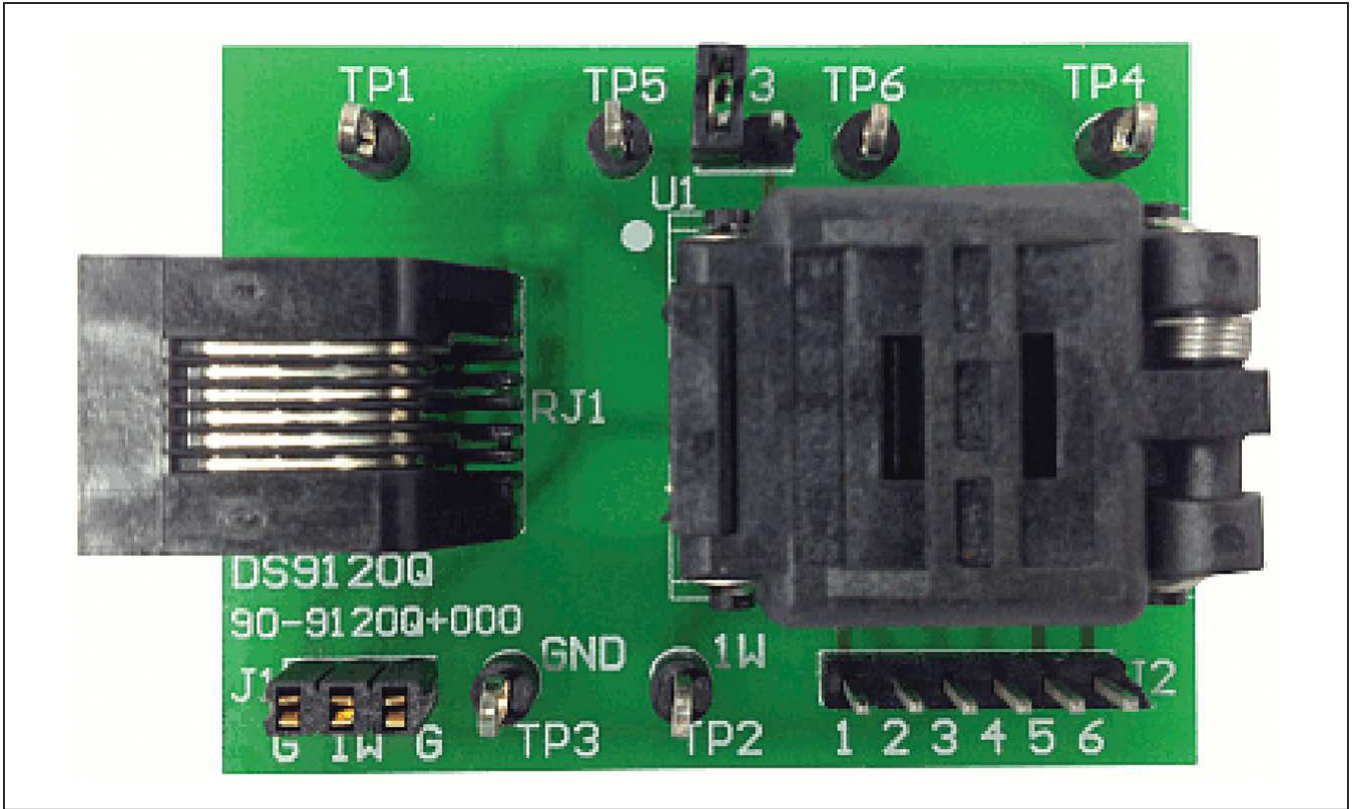

Figure 1. DS9120Q+ Socket Board



Figure 2. DS9481R-3C7+ USB-to-1-Wire/iButton Adapter

## DS28E80 EV Kit Files

FILE	DESCRIPTION
DS28E80_Evaluation_Program_Setup.exe	Evaluation Software (Installation file)

## Quick Start

### Required Equipment

- DS28E80 EV kit
- DS9481R-3C7+ USB-to-1-Wire/iButton adapter (included)
- USB type-A to Mini-USB type-B cable (included)
- DS9120Q+ TDFN, TO-92 socket board (included)
- RJ11 cable assembly (included)
- Computer with a Windows 8, Windows 7, Windows Vista, or Windows XP operating system (32-bit or 64-bit version) and a spare USB 2.0 or higher port
- DS28E80Q+ (five devices included)
- DS28E80 EV kit software (go to <http://www.maximintegrated.com/en/design/tools/applications/evkit-software>, search for the DS28E80, and click the link to download files).

**Note:** In the following sections, software-related items are identified by bolding. Text in **bold** refers to items directly from the adapter software. Text in **bold and underlined** refers to items from the Windows operating system.

### Procedure

The EV kit is fully assembled and tested. Follow the steps below to verify board operation:

- 1) Install the 1-Wire drivers. See the *Installing 1-Wire Drivers* section for instructions.
- 2) The PL-2303 Prolific Driver needs to be installed. See the *Installing the Prolific Device Driver for the DS9481R-3C7+* section for instructions.
  - a) Insert the DS28E80 in the TDFN-EP socket on the DS9120Q+ EV board. See Figure 3 for the pin configuration.

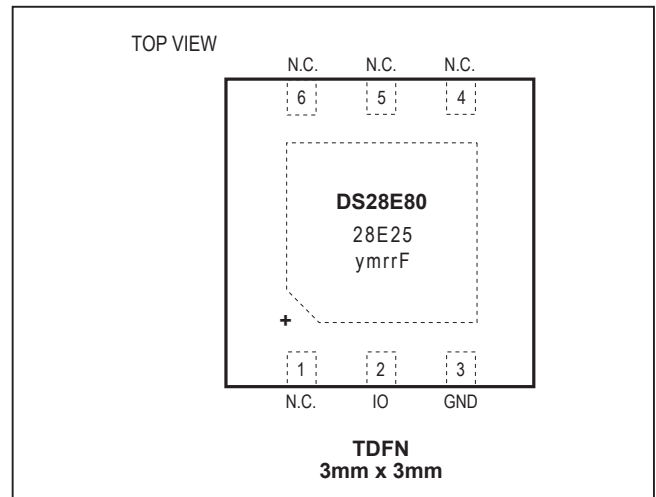

Figure 3. DS28E80 Chip Orientation for TDFN-EP Socket

**Note:** Pin 1 is indicated by a white dot on the DS9120Q+ PCB.

- 3) Orientation in the socket
  - a) Insert one of the DS28E80 devices into the TDFN-EP socket on the DS28E80 EV kit board.
  - b) Close the burn-in socket.
- 4) Connect the DS9481R-3C7+ with the DS9120Q+ using the RJ11 cable assembly.
- 5) Connect the DS9481R-3C7+ in a vacant USB port on the PC using the USB type-A to Mini-USB type-B cable.
  - a) Unzip the **DS28E80\_EVKit\_Rev2.zip** file to a known location.
- 6) Open the **Installation** folder and double-click the **Setup.exe** file.
- 7) When properly installed, the graphical user interface (GUI) window shown in Figure 4 should appear.

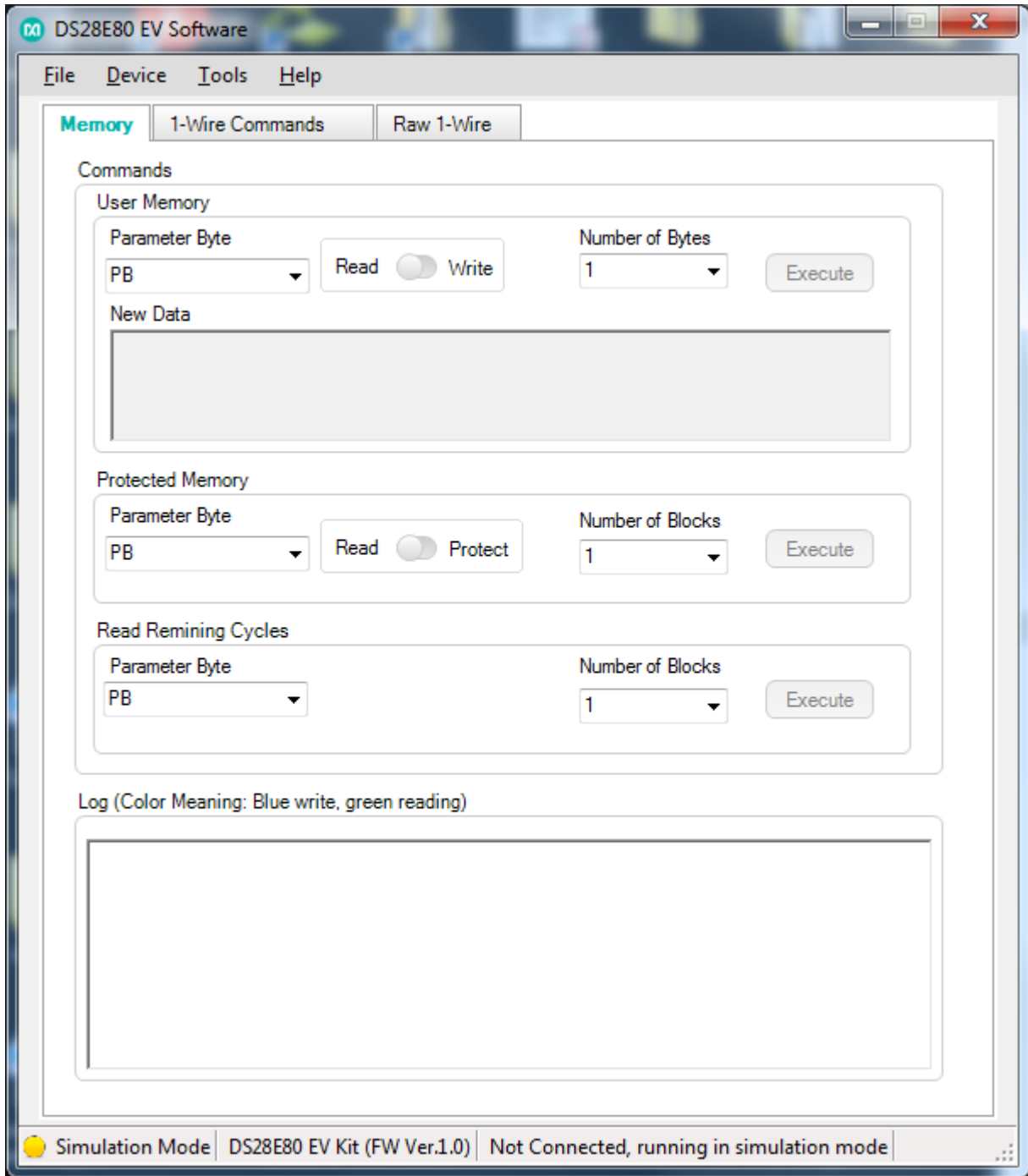

Figure 4. Initial Screen

- 8) To start communicating with the part, it is necessary to have the DS9481R adapter connected and have a part placed into the DS9120 socket. Once adapter is connected, select **Device** → **Connect**.
  - a) The **Connect** feature can also be used to refresh the connection settings. This is helpful for the user if a new device is attached to the DS9120 adapter. The software needs to reconfigure the number of devices in the network and be ready to work with the new device. Clicking the **Connect** option refreshes the selections (Figure 5).
- 9) Under **Device** → **Setup**, the user can review the settings, change the device, port, 1-Wire speed, or review the selected device ROM ID (Figure 6).
- 10) If more than one device is in the 1-Wire network, it will be displayed under **Device** → **Setup** → **Device Selection** (Figure 7). From there, the user can select any DS28E80 in the 1-Wire network. The new selected device ROM ID will be displayed under **Device** → **Setup** → **Selected Device ROM ID**.

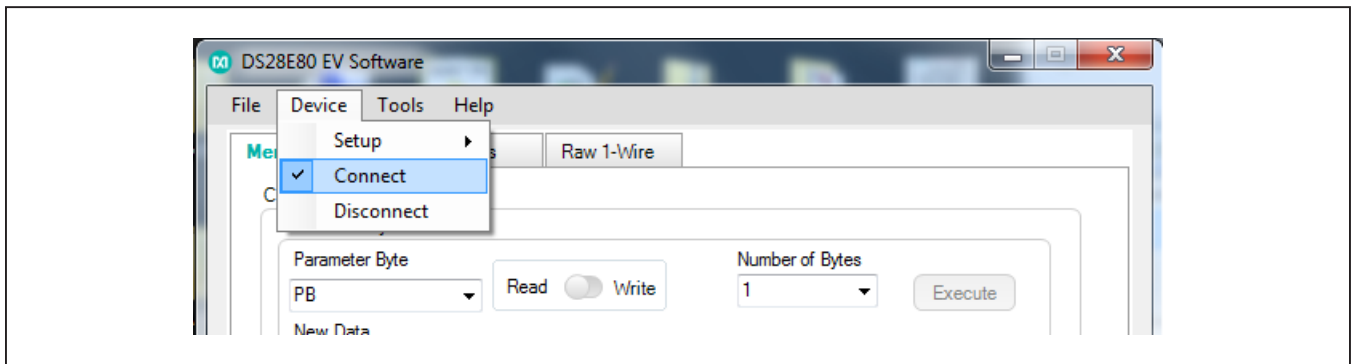

Figure 5. Connect

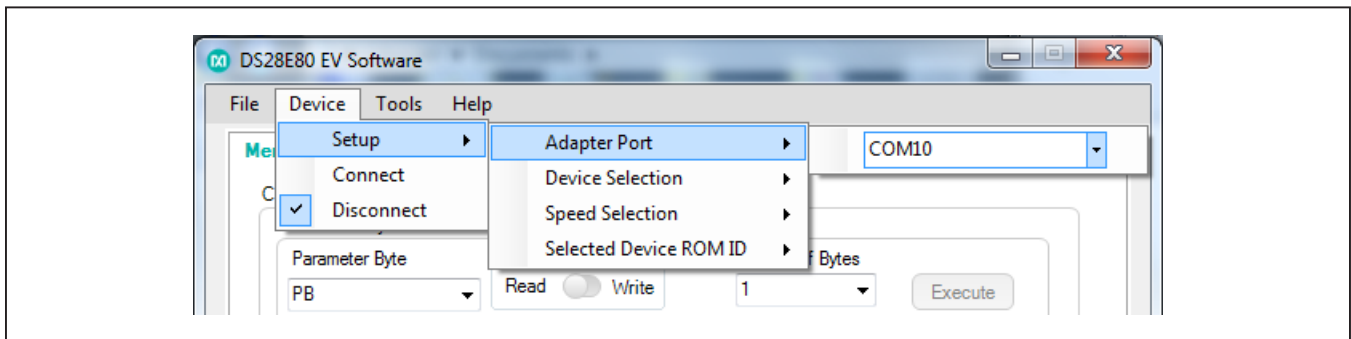

Figure 6. Review/Change Settings

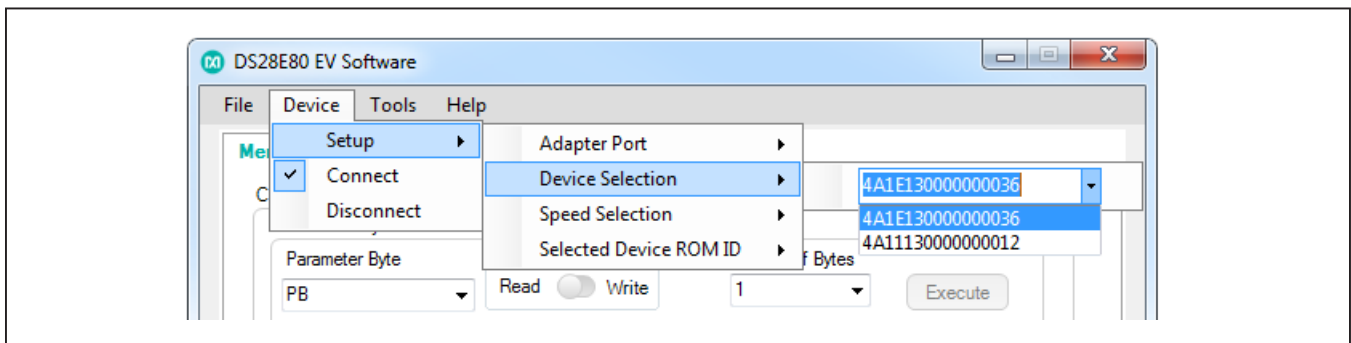

Figure 7. Device Selection

### Detailed Description of Software

The DS28E80 evaluation program user interface (Figure 8) has three tabs used to write, read, or protect memory contents by selecting memory blocks or a memory range. Under this tab, the user has the option to write to memory using a programming file instead of typing each memory block content. The **1-Wire Commands** tab is the main tool to evaluate the DS28E80-specific functions. The **Raw 1-Wire** tab provides 1-Wire communication

functions down to the bit level plus power-delivery and program-pulse options. These functions allow the user to manually create communication sequences beyond those found on the **Memory** tab, or to communicate with other 1-Wire devices that are electrically compatible to the DS9481R-3C7+ adapter.

By default, the software opens in simulation mode to provide the user the opportunity to navigate the software and get familiar with the options and software interface.

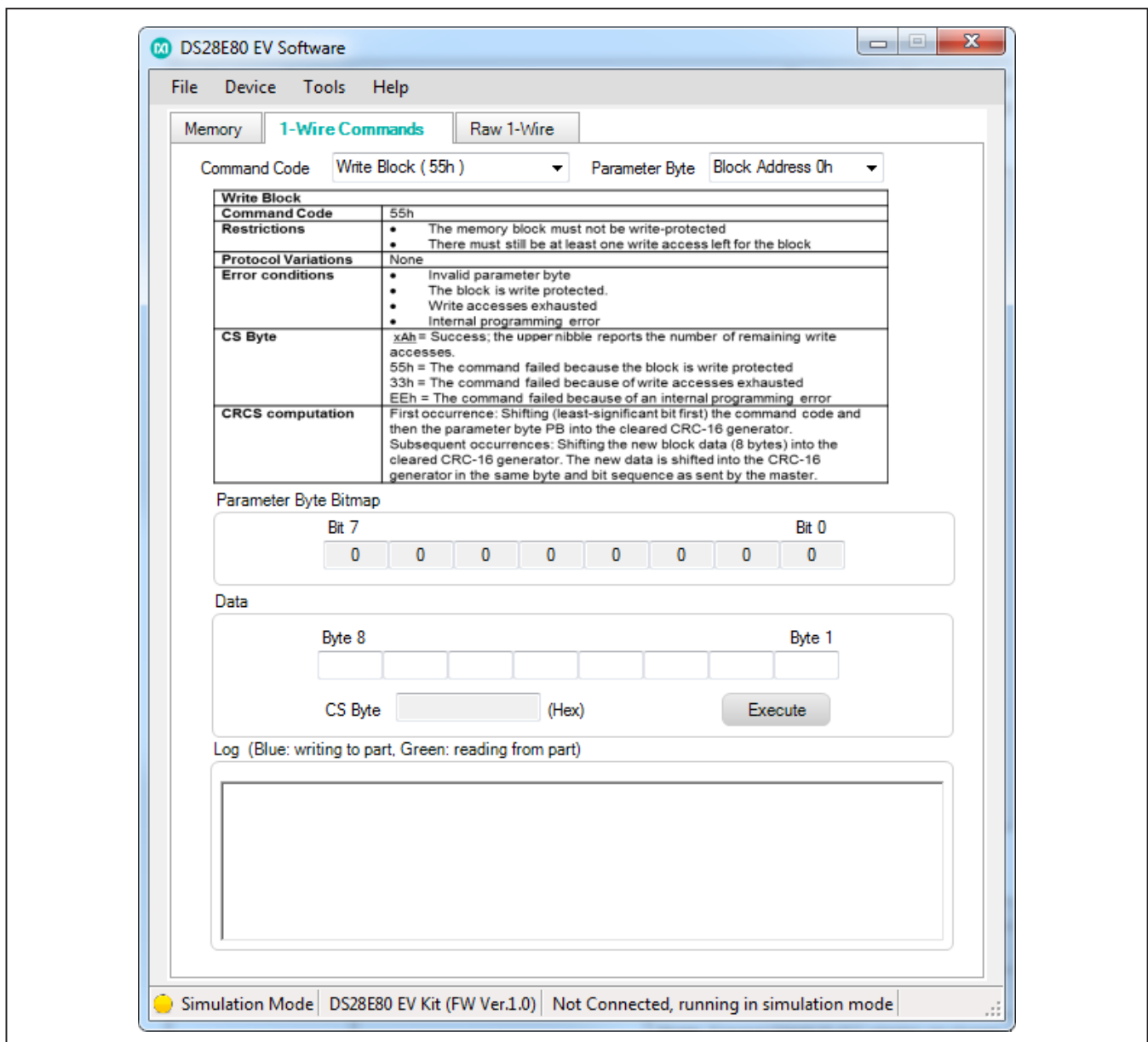

Figure 8. Main GUI Interface

**Menu Bar → File Menu Item**

- **Save Current Log:** Takes the current data contained in the **Log** group box and gives the user the option to save the log to a specific disk location.
- **View Log Files:** Opens the interface and shows the current saved logs in the computer so the user can review or print the data.
- **Exit:** Closes the 1-Wire connection and exits applications.

**Menu Bar → Device Menu Item**

Provides all the connection information and settings required for 1-Wire transactions.

- **Setup**
  - **Adapter Port:** COM port used by the DS9481R.
  - **Device Selection:** Indicates the selected DS28E80 device, if currently placed in the DS9490 adapter. If more than one DS28E80, the user can change the current device and interact with a different DS28E80 in the list.

- **Speed Selection:** Option to select the speed the software will connect with the part. The software works by default in standard speed and provides the user an option to change to overdrive or regular speed.
- **Selected Device ROM ID:** Provides the selected DS28E80 ROM ID number.

**Note:** Before being able to read this information, the **Connect** option must be selected. In simulation mode, the boxes do not show real information.

- **Connect:** Connects software with the DS9481R, enabling software to interact with the DS28E80 hardware (Figure 9). It is important to have the DS9481R connected to the software before initial start. If the DS9481R is not attached, or the 1-Wire drivers are not installed, the software prompts the user to connect the adapter and closes automatically (Figure 10).
- **Disconnect:** Switches back to simulation mode and disconnects the hardware connection to the DS28E80. To connect back to hardware manipulation, the user must select the **Connect** option again.

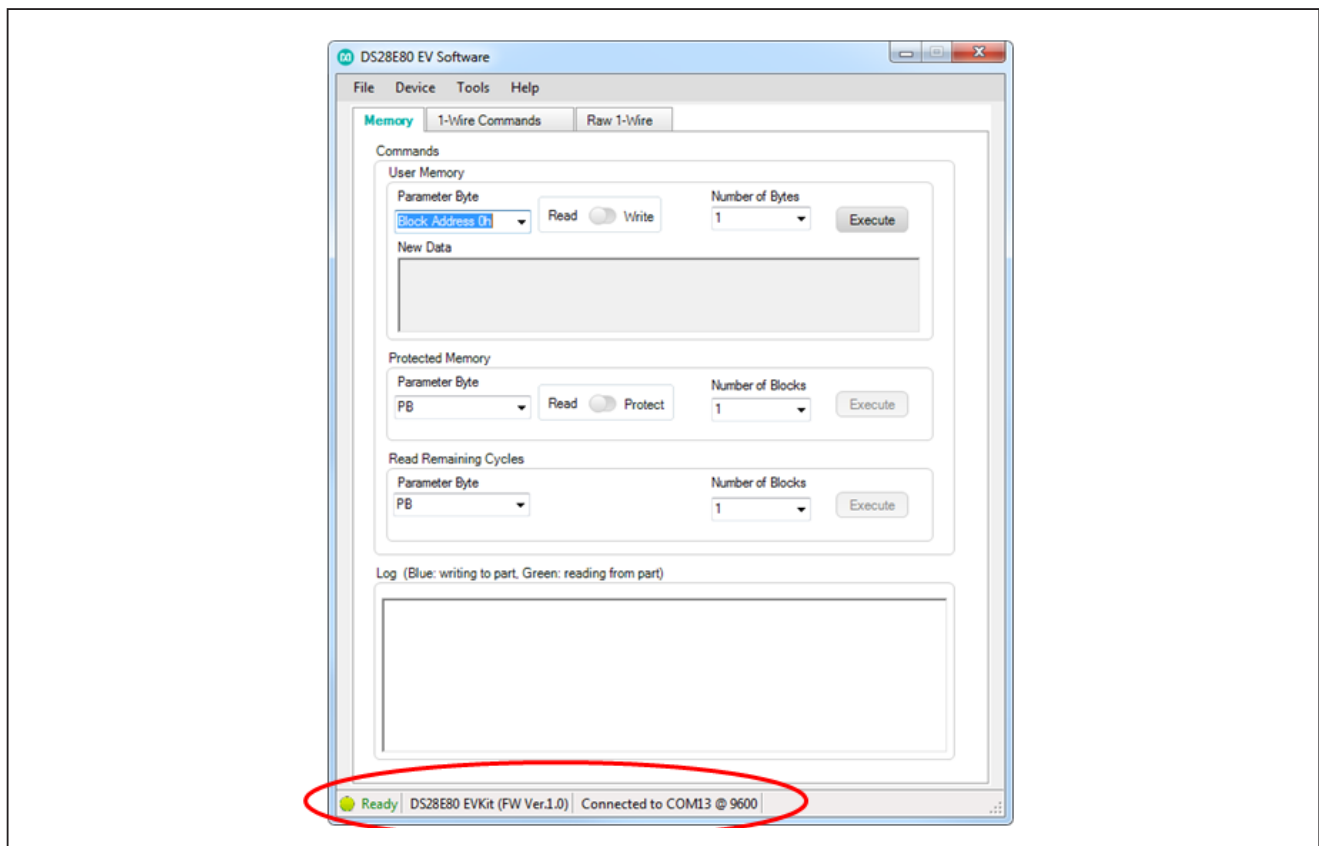

Figure 9. Adapter Connected

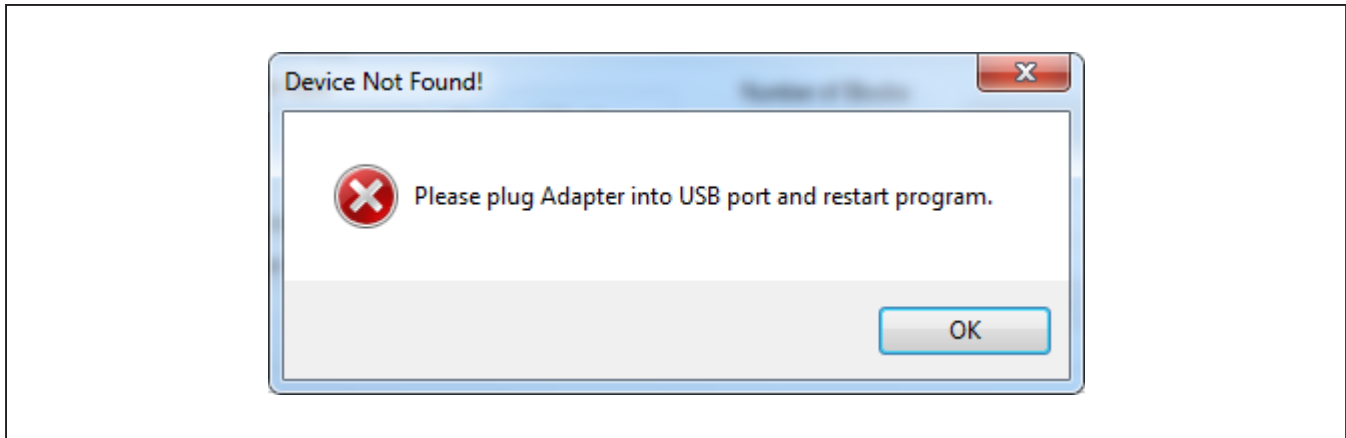

Figure 10. Adapter Not Connected

**Menu Bar → Tools Menu Item**

- **Auto Save Data Log:** When selected, it automatically saves the log box information into a preloaded default path selected by the software. If this option is not selected, the log will not be saved until the user chooses to save the log by using the **File Menu Item → Save Current Log** option.
- **Select Programming File:** The EV kit includes an option under the **Memory** tab when writing, to select the data from a file instead of typing manually the bytes to write to the memory. To use the **From File** option under the user memory block, the user must manually make a text file and following the 8-bytes-per-block requirement write the data in the file representing hex values. This provides an option to load contents into the **New Data** edit box under the **Memory** tab.

**Menu Bar → Help Menu Item**

- **About:** Splash screen disable option and Company contact information.
- **General:** Provides basic DS28E80 information.
- **Log Path:** Displays the current path where the **Auto Save Data Log** option stores the log files.

**Loading Text File to Software**

Using any text editor, the user can create a programming file that can be input to the **New Data** edit

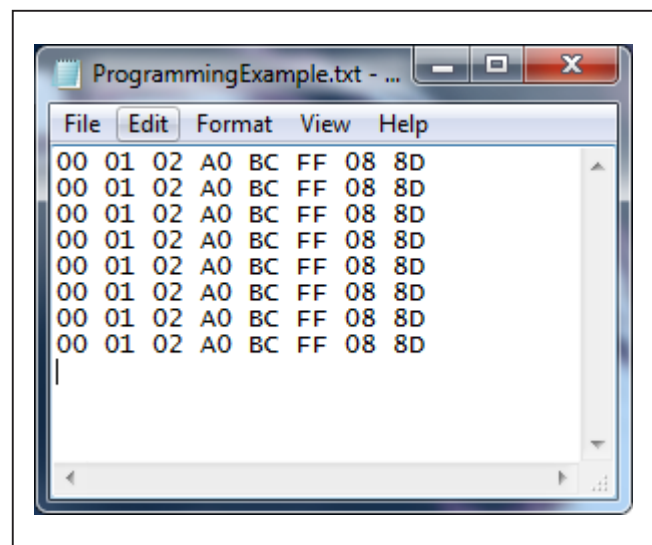

Figure 11. Programming File Example

box. This helps the user program the device memory faster using a preconfigured file (Figure 11). The only requirement is to follow the format for each block page, with 8 bytes per block in hex format. To do this, click the **Tools** menu item, and select the **Select Programming File → No file selected** option. A second popup screen gives the user the option to select the text file (Figure 12 and Figure 13).



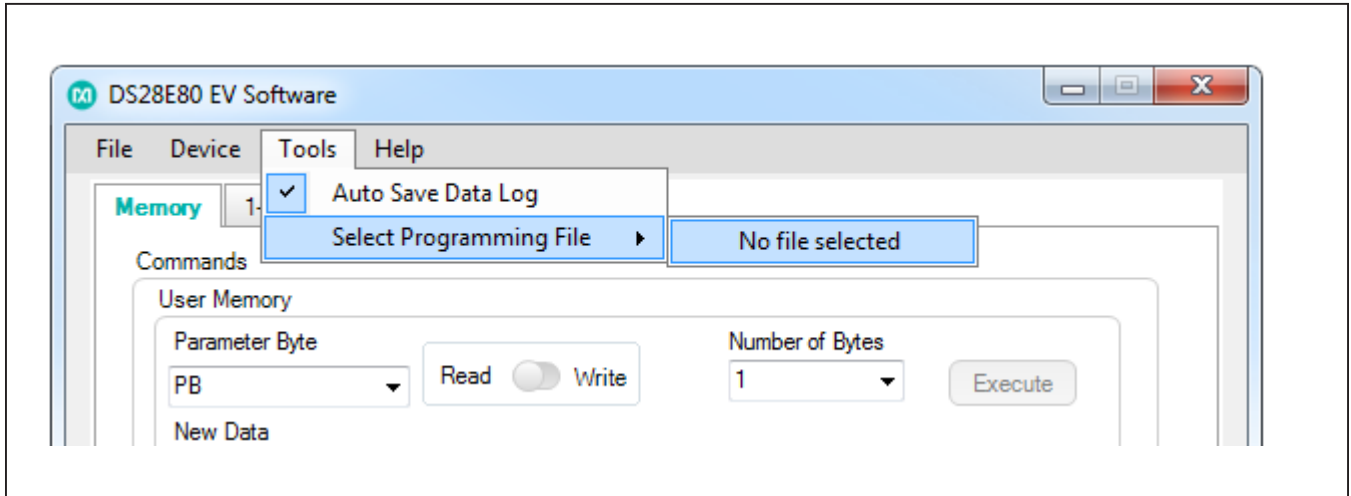

Figure 12. Import Programming File

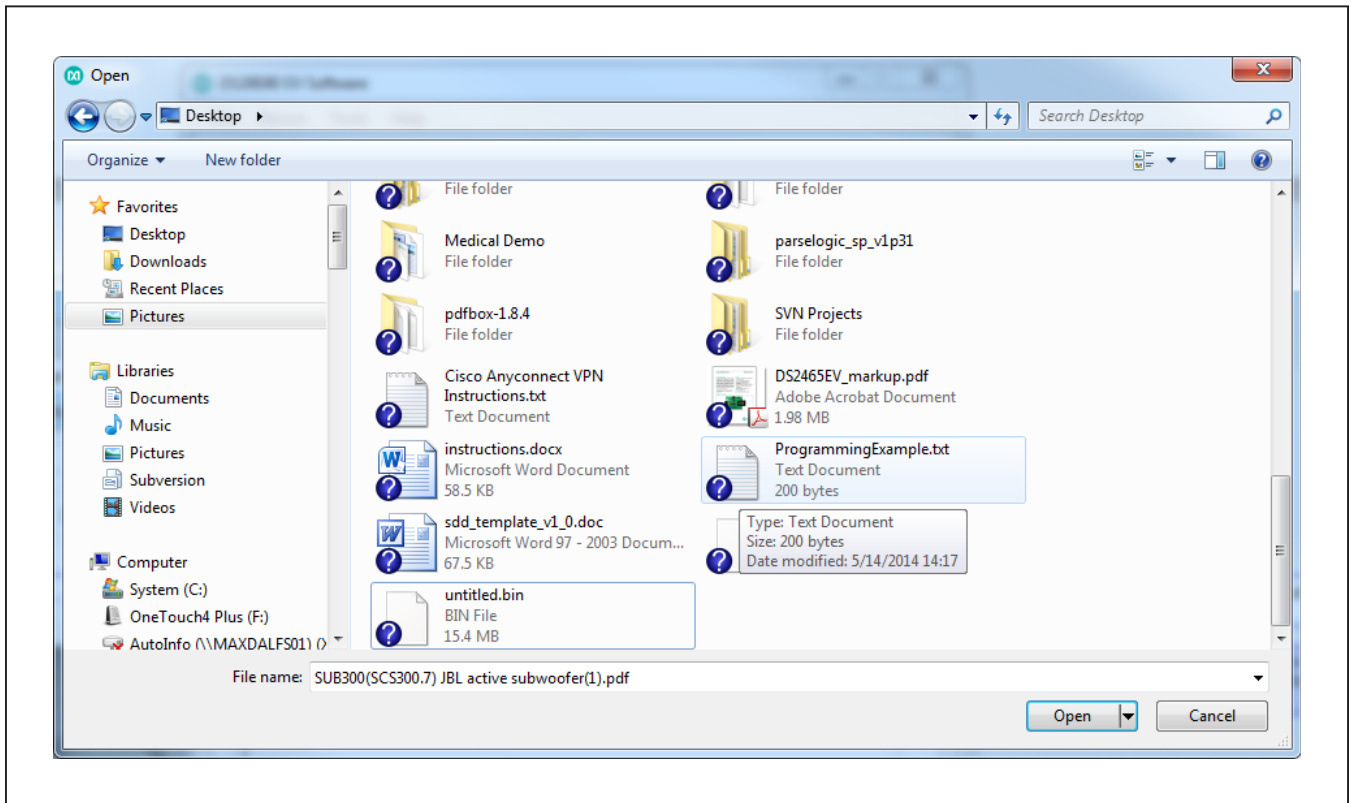

Figure 13. File Selection

**User Interface → Memory Tab**

The **Memory** tab has four group boxes: **User Memory**, **Protected Memory**, **Read Remaining Cycles**, and **Log** (Figure 14). Table 1 explains the elements in the **User Memory** group box. Table 2 provides details on the

elements in the **Protected Memory** group box, and Table 3 explains the elements in the **Read Remaining Cycles** group box. The **Log** group box displays the 1-Wire communication commands.

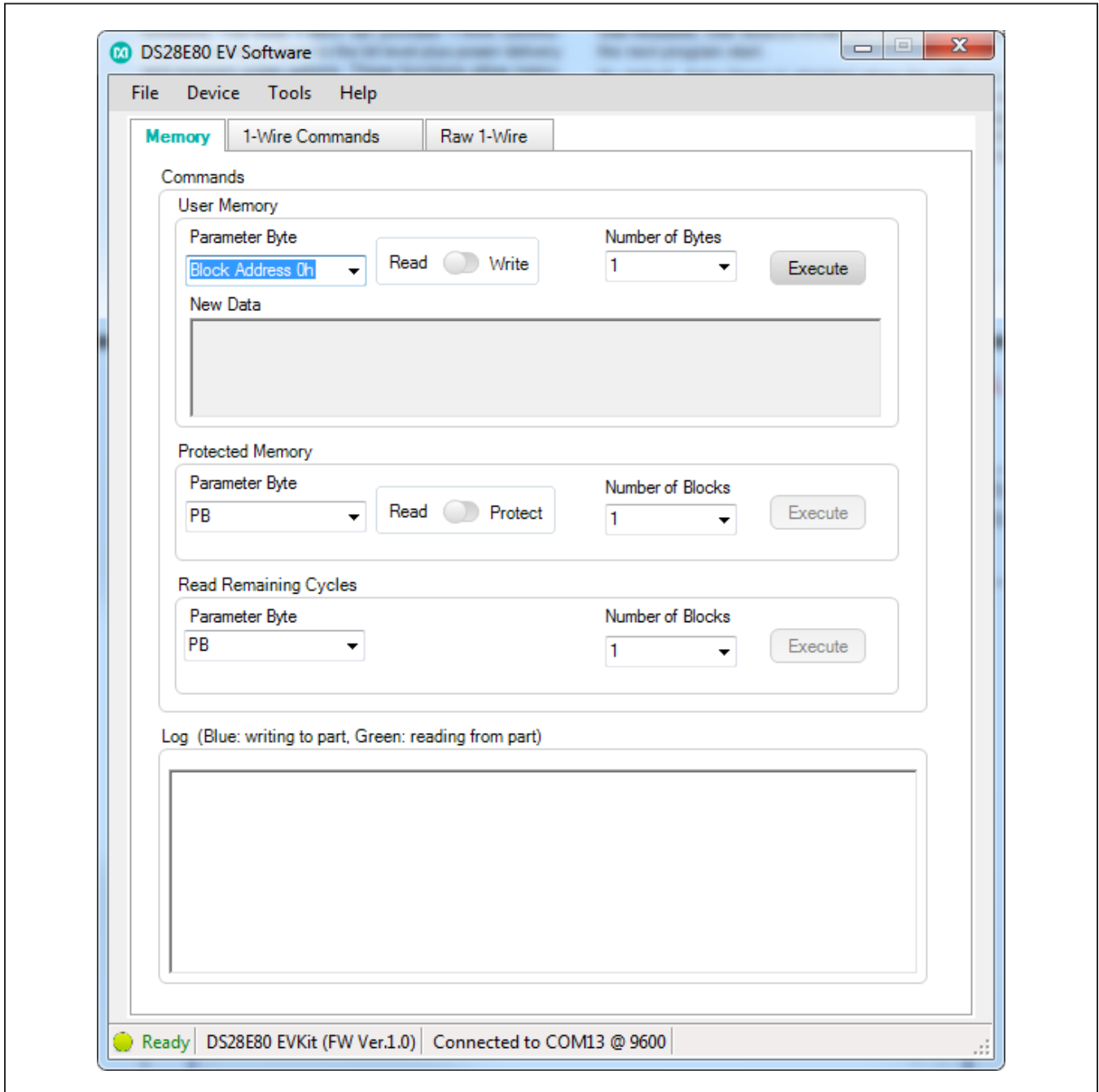

Figure 14. Memory Tab Functions

**Table 1. Memory Tab (User Memory Group Box)**

ELEMENT NAME (TYPE)	PURPOSE	USAGE, SETTINGS
<b>Parameter Byte</b> (drop-down list)	Starting <b>Block Address</b> selection	Indicates the starting address to start writing or reading data from user memory.
<b>Read/Write</b> (toggle button)	Toggles between read or write from selected starting block	Switches between read or write option. The write option opens a second option to input data into the <b>New Data</b> edit box.
<b>Number of Bytes</b> (drop-down list)	Option displays only under reading	Indicates how many bytes will be read from user memory, starting from the selected parameter byte address.
<b>New Data</b> (edit box)	Field in which to type data to write to DS28E80 memory	Disabled under <b>Read</b> option. Open when <b>Write</b> is selected.
<b>Manual/From File</b> (drop-down list) (Figure 15)	Select when user wants to type data into <b>New Data</b> or load data from file	If <b>Manual</b> is selected, the user must type data in hex representation in the field and have at least 8 bytes for an acceptable transaction. If <b>From File</b> is selected, program uses the selected input file and populates data into the edit box. If a file is not selected yet, the program prompts to open file and load contents to edit box.
<b>Execute</b> (button)	Executes the selected options	Sends command to DS28E80 to write or read bytes depending on all selections made.

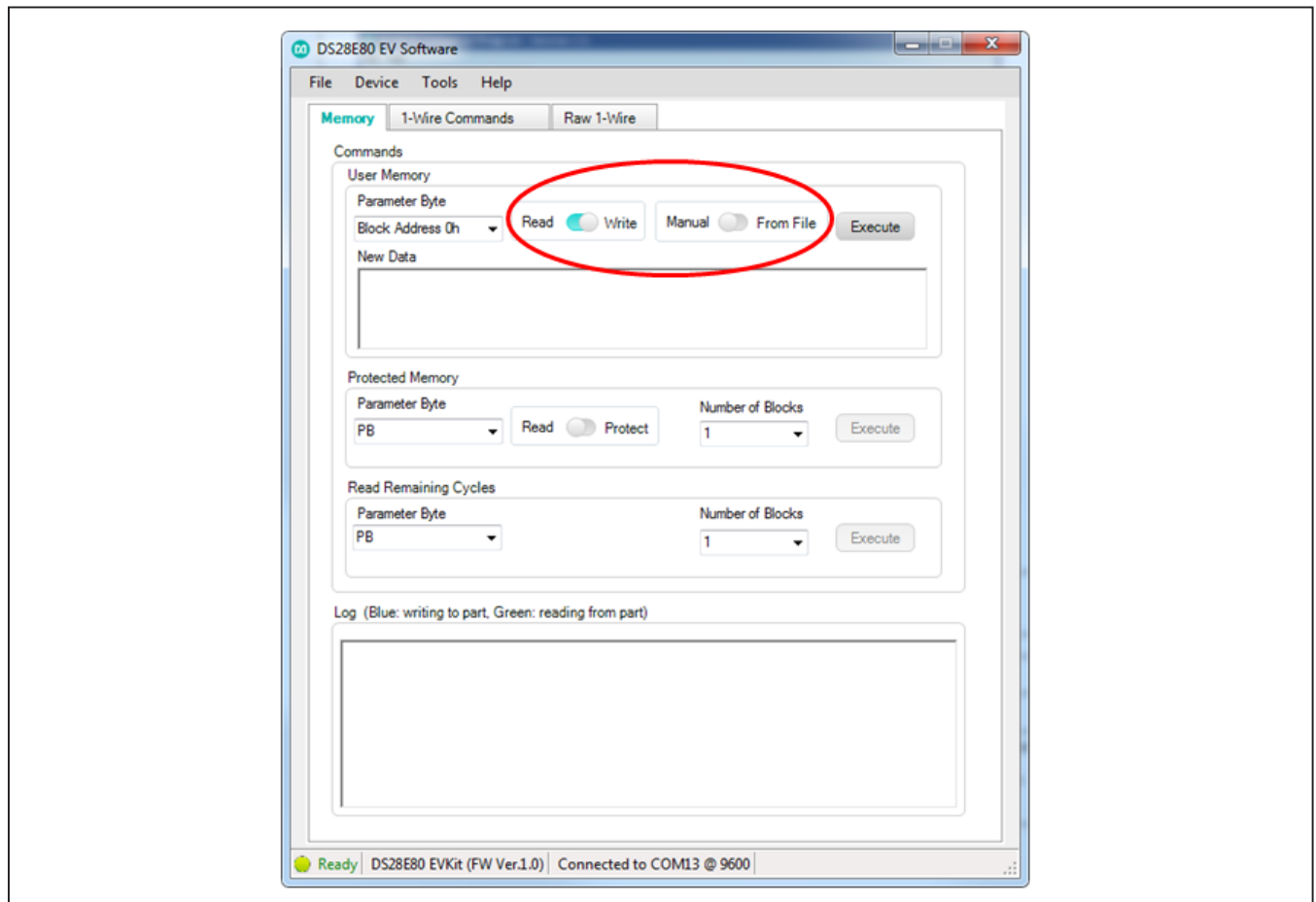

Figure 15. Write Toggle Selected

**Table 2. Memory Tab (Protected Memory Group Box)**

ELEMENT NAME (TYPE)	PURPOSE	USAGE, SETTINGS
<b>Parameter Byte</b> (drop-down list)	Starting <b>Block Address</b> selection	Indicates the starting address to start protecting or reading protection status.
<b>Read/Protect</b> (toggle-button)	Toggles between read or write protect from selected starting block	The <b>Protect</b> option disables the <b>Number of Blocks</b> and protects only the block selected in the <b>Parameter Byte</b> drop-down list.
<b>Manual/From File</b> (toggle-button)	Select if data is going to be typed in to the <b>New Data</b> edit box or if the data is coming from a preselected file	When <b>Manual</b> is selected, the user must type the byte values in the <b>New Data</b> edit box. When <b>From File</b> is selected, the <b>New Data</b> edit box is populated using the data contained in the loaded text file. To see how to load file, see the <b>Select Programming File</b> option under the <b>Tools</b> menu item.
<b>Number of Blocks</b> (drop-down list)	Option enabled only under reading	Indicates how many blocks are read from user memory, starting from the selected parameter byte address.
<b>Execute</b> (button)	Execute the selected options	Sends command to DS28E80 to protect or read the protection status from the selected <b>Parameter Byte</b> drop-down list.

**Table 3. Memory Tab (Read Remaining Cycles Group Box)**

ELEMENT NAME (TYPE)	PURPOSE	USAGE, SETTINGS
<b>Parameter Byte</b> (drop-down list)	Starting <b>Block Address</b> selection	Indicates the starting address to read the remaining writing cycles.
<b>Number of Blocks</b> (drop-down list)	Option enabled only under reading	Indicates how many blocks are read from user memory, starting from the selected parameter byte address.
<b>Execute</b> (button)	Executes the selected options	Sends command to DS28E80 to read remaining cycles.

**User Interface → 1-Wire Commands Tab**

The **1-Wire Commands** tab ([Figure 16](#)) helps the user understand the process between each command and shows the memory contents separated by memory blocks. [Table 4](#) provides details on each control.

**Note:** A read of the memory is performed each time the command from the **Command Code** drop-down list is selected, as shown in [Figure 17](#), or each time the block address from the **Parameter Byte** drop-down list is selected, as shown in [Figure 18](#).

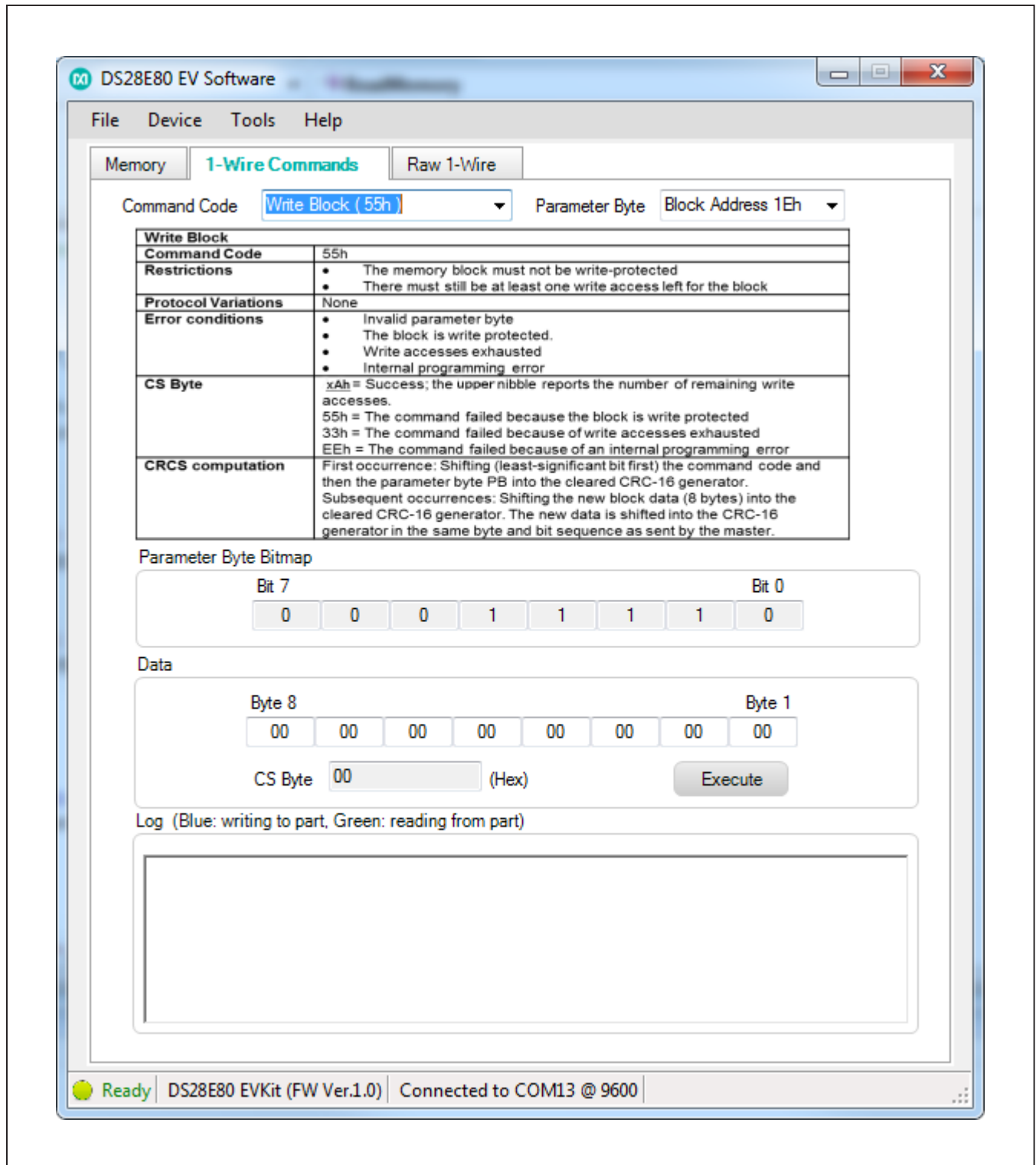

Figure 16. 1-Wire Commands Tab Selected

**Table 4. 1-Wire Commands**

ELEMENT NAME (TYPE)	PURPOSE	USAGE, SETTINGS
<b>Command Code</b> (drop-down list)	Selects the 1-Wire command	Displays what the 1-Wire command byte is, provides information on the operation, and the expected results for each transaction (see Figure 19).
<b>Parameter Byte</b> (drop-down list)	Starting memory block address	Selects the memory block to be accessed or manipulated.
<b>Parameter Byte Bitmap</b>	Displays the current memory contents of each parameter byte	Displays the parameter byte in bit format.
<b>Data</b>	Displays the contents of the memory block selected	While writing, the user can manipulate the bytes in each block and write back to the memory block selected. While reading, this shows the contents in the block. Depending on the command selected, this section changes and displays results accordingly (see Figures 20–22).
<b>Log</b>	1-Wire communication commands	Displays all 1-Wire commands and transactions for each selected option.

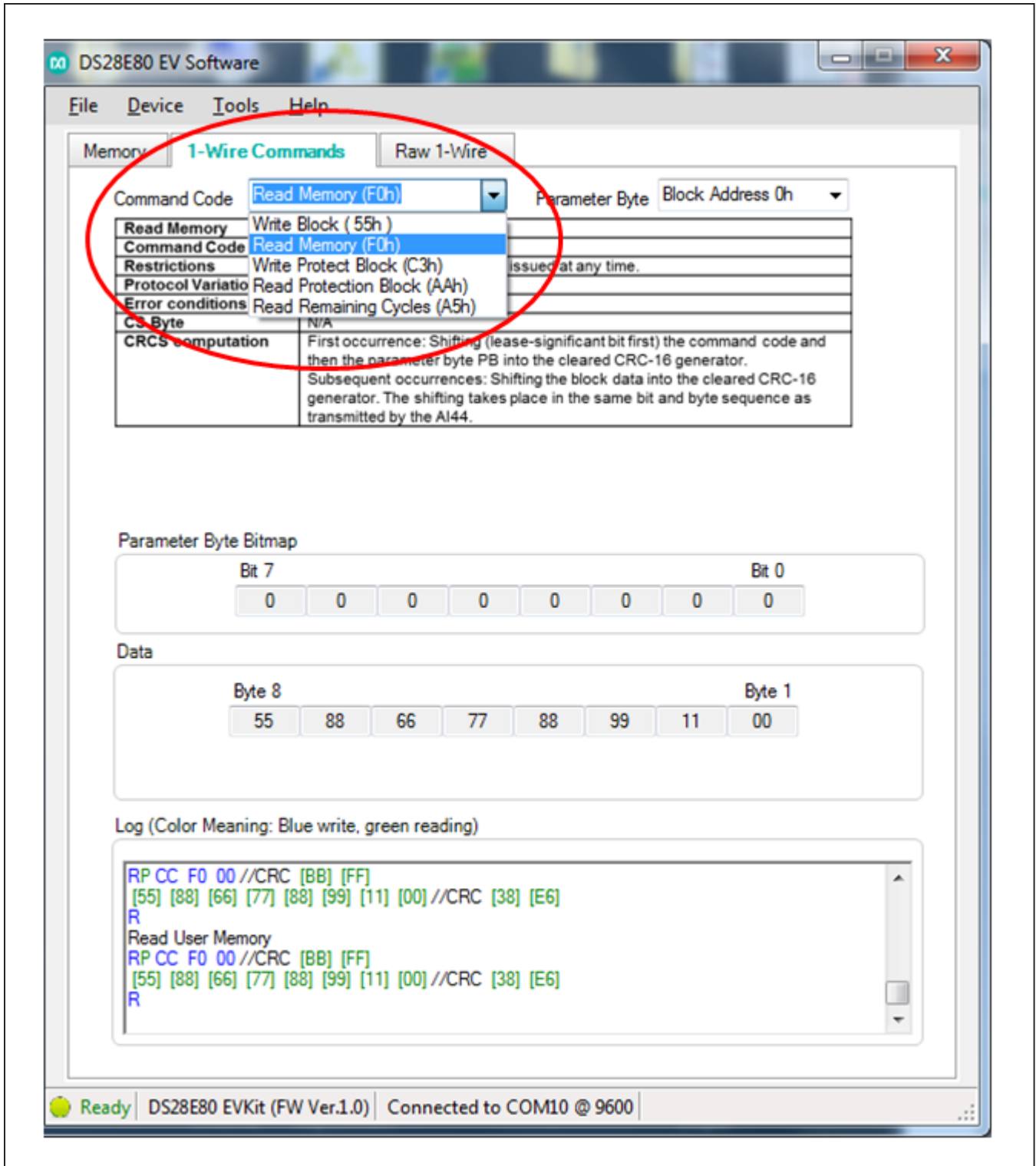

Figure 17. Read Memory Occurs When Command Code Selected

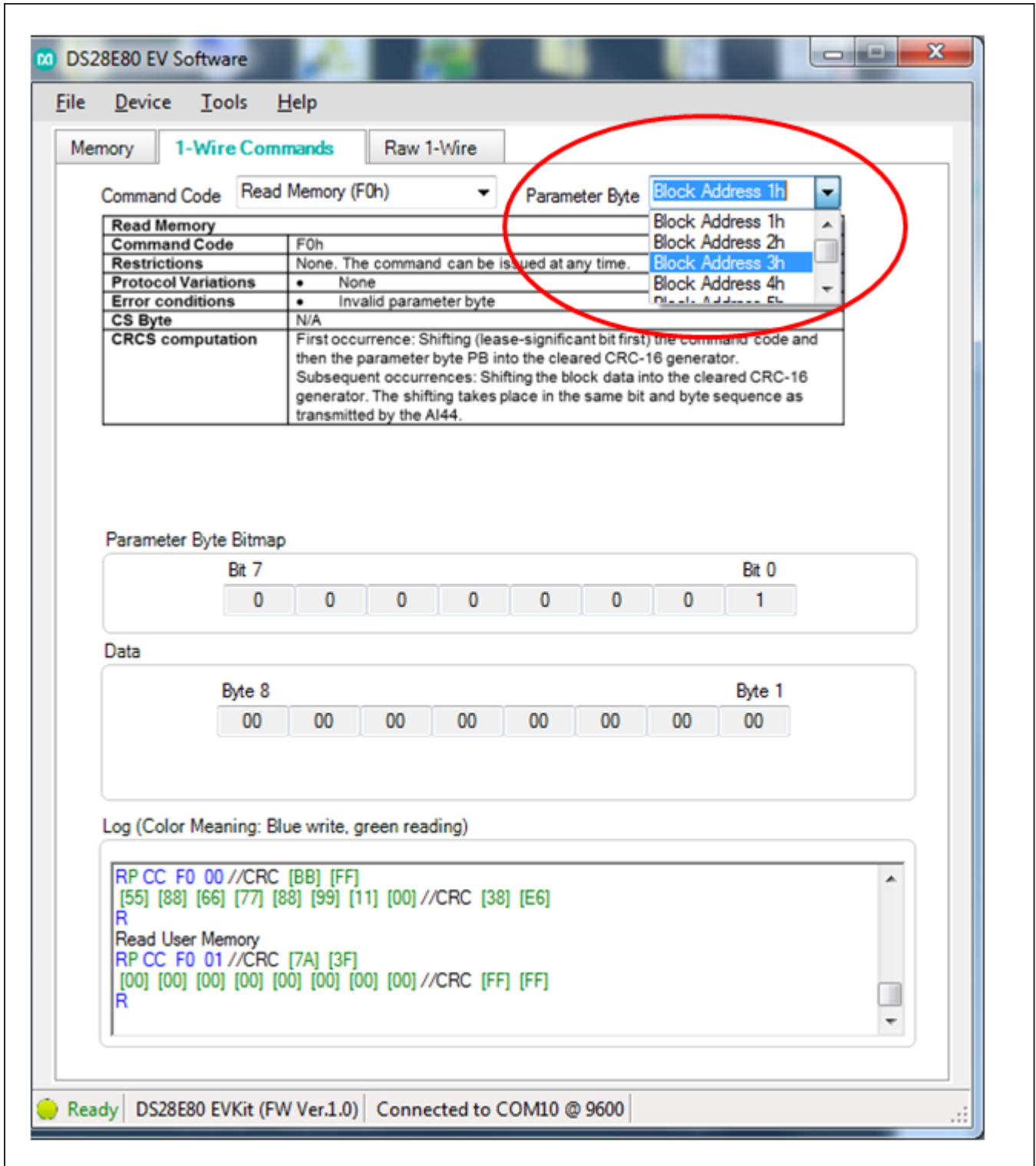

Figure 18. Read Memory Occurs When Parameter Byte Selected



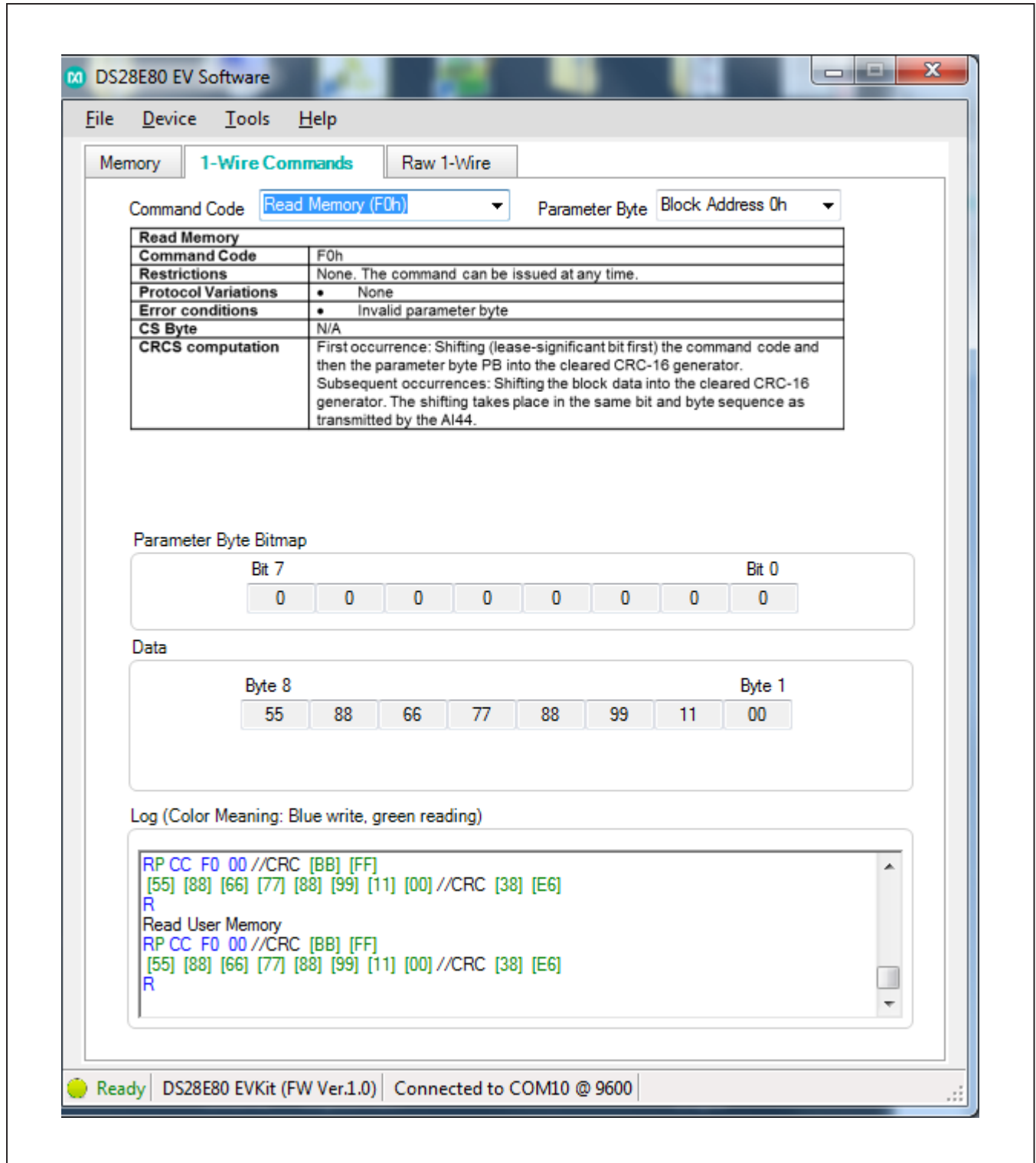

Figure 19. Read Memory Selected

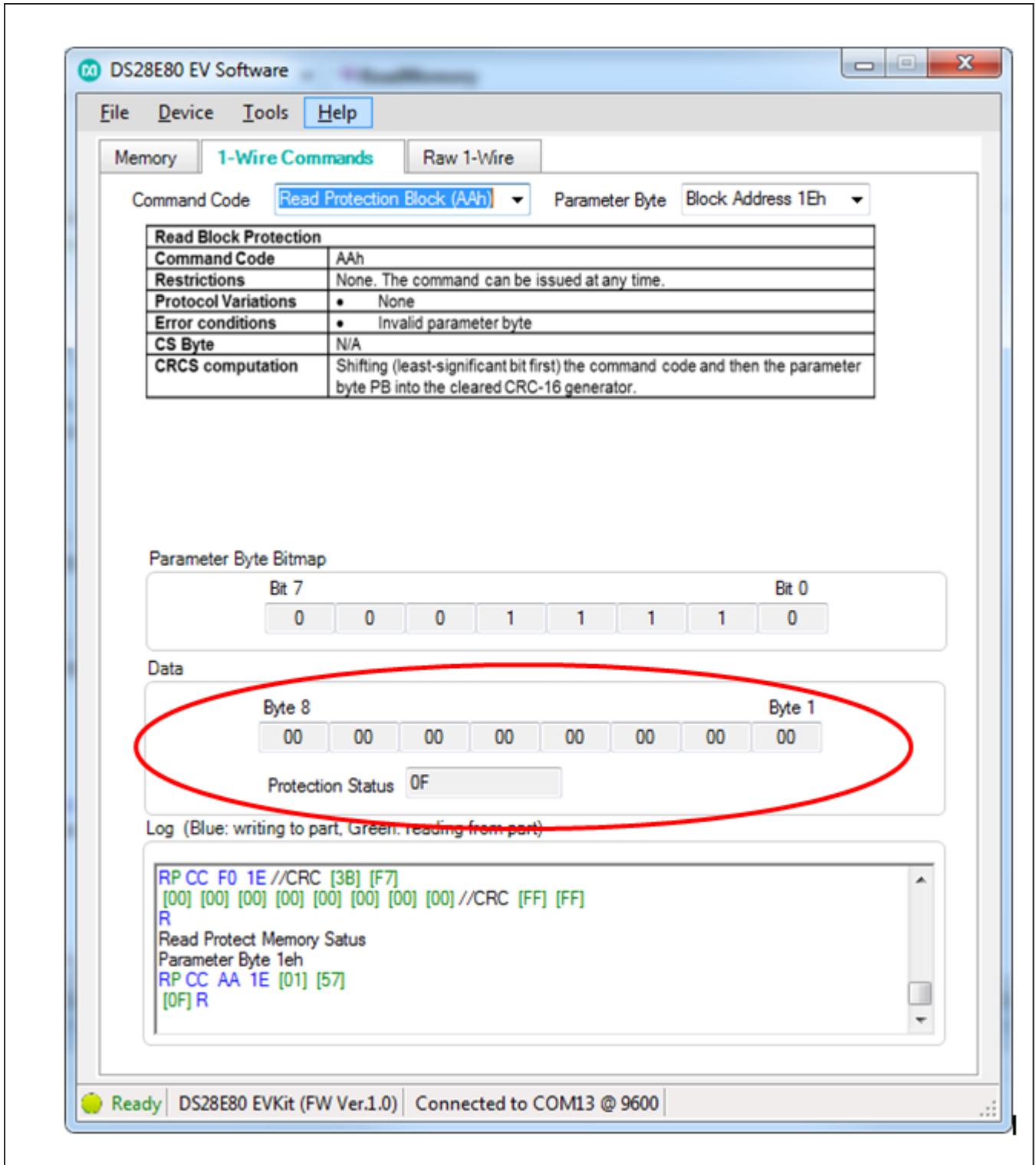

Figure 20. Read Protection Selected

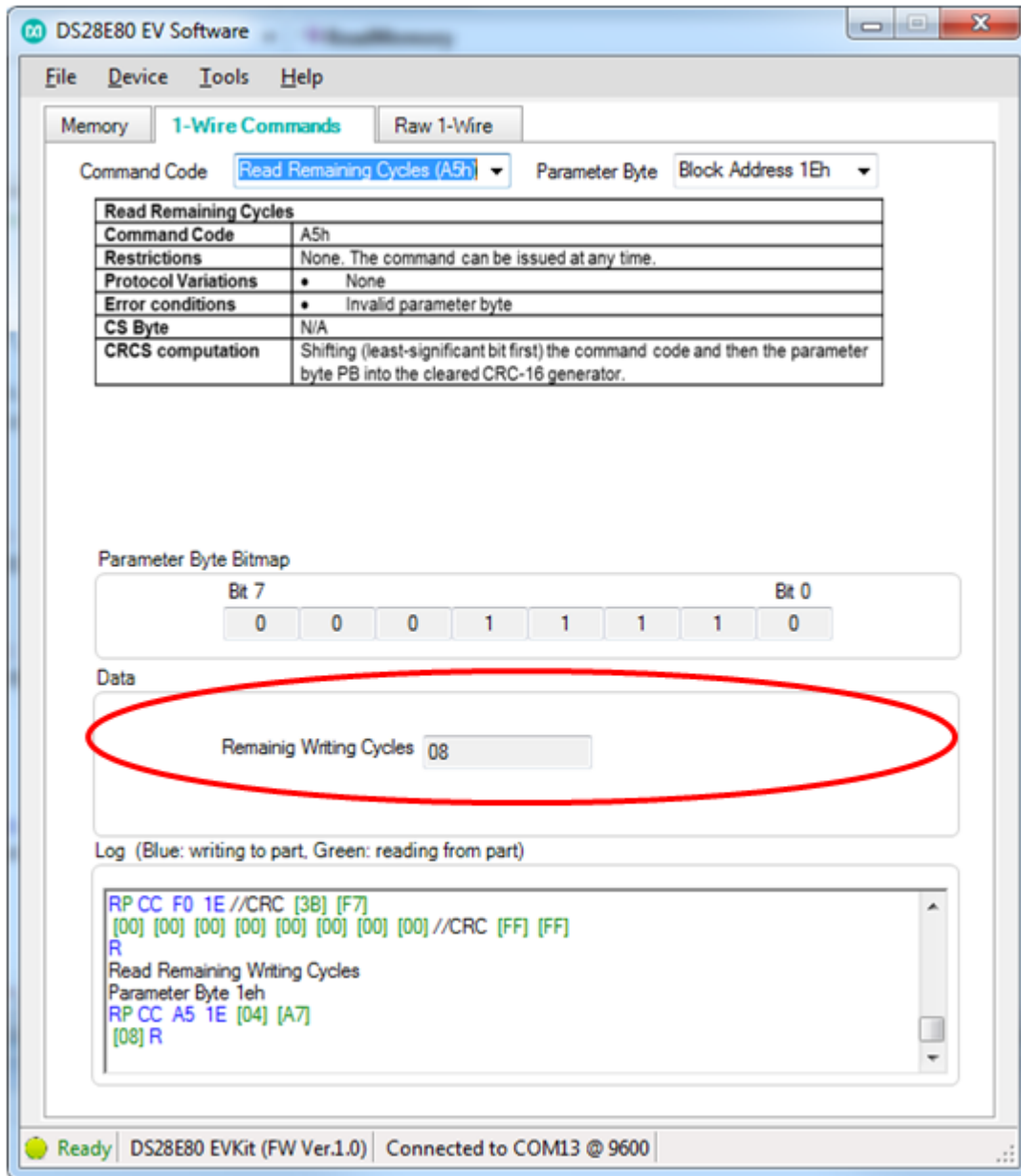

Figure 21. Read Remaining Cycles Selected

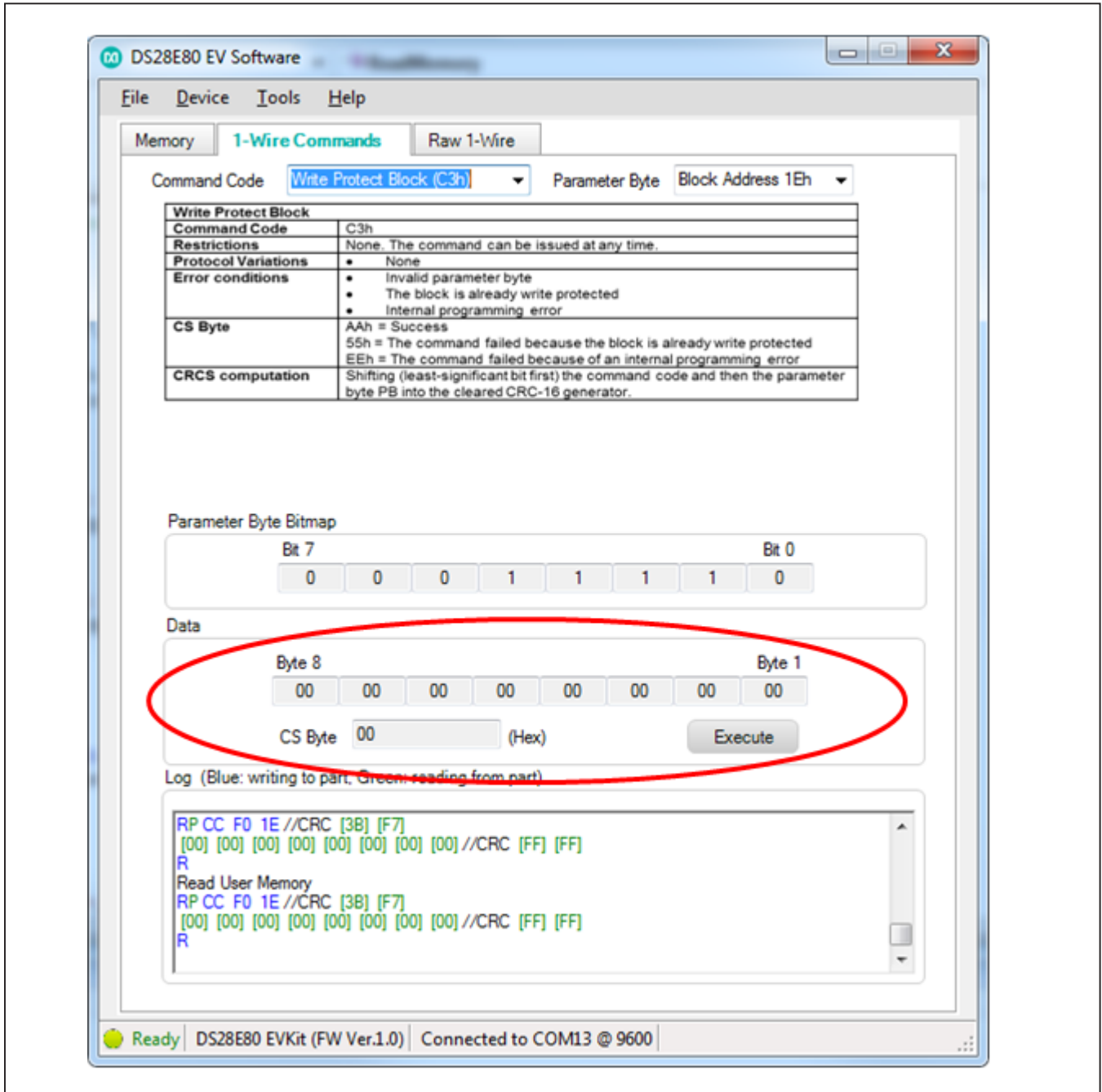

Figure 22. Write Protect Block Selected

### User Interface → Raw 1-Wire Tab

The **Raw 1-Wire** tab (Figure 23) has two main group boxes: **Low Level** and **ROM Level**. Table 5 details the elements in the **Low Level** group box and Table 6 details the **ROM Level** elements. The **Low Level** group box provides the low-level 1-Wire primitives that can be used to construct any 1-Wire communication sequence.

Choices made in the **Low Level** group box (e.g., speed, which toggles between standard and overdrive) apply also to ROM-level functions. The **ROM Level** group box has functions that implement the 1-Wire ROM function commands that use the 64-bit ROM ID that each 1-Wire slave device has for device discovery and selection.

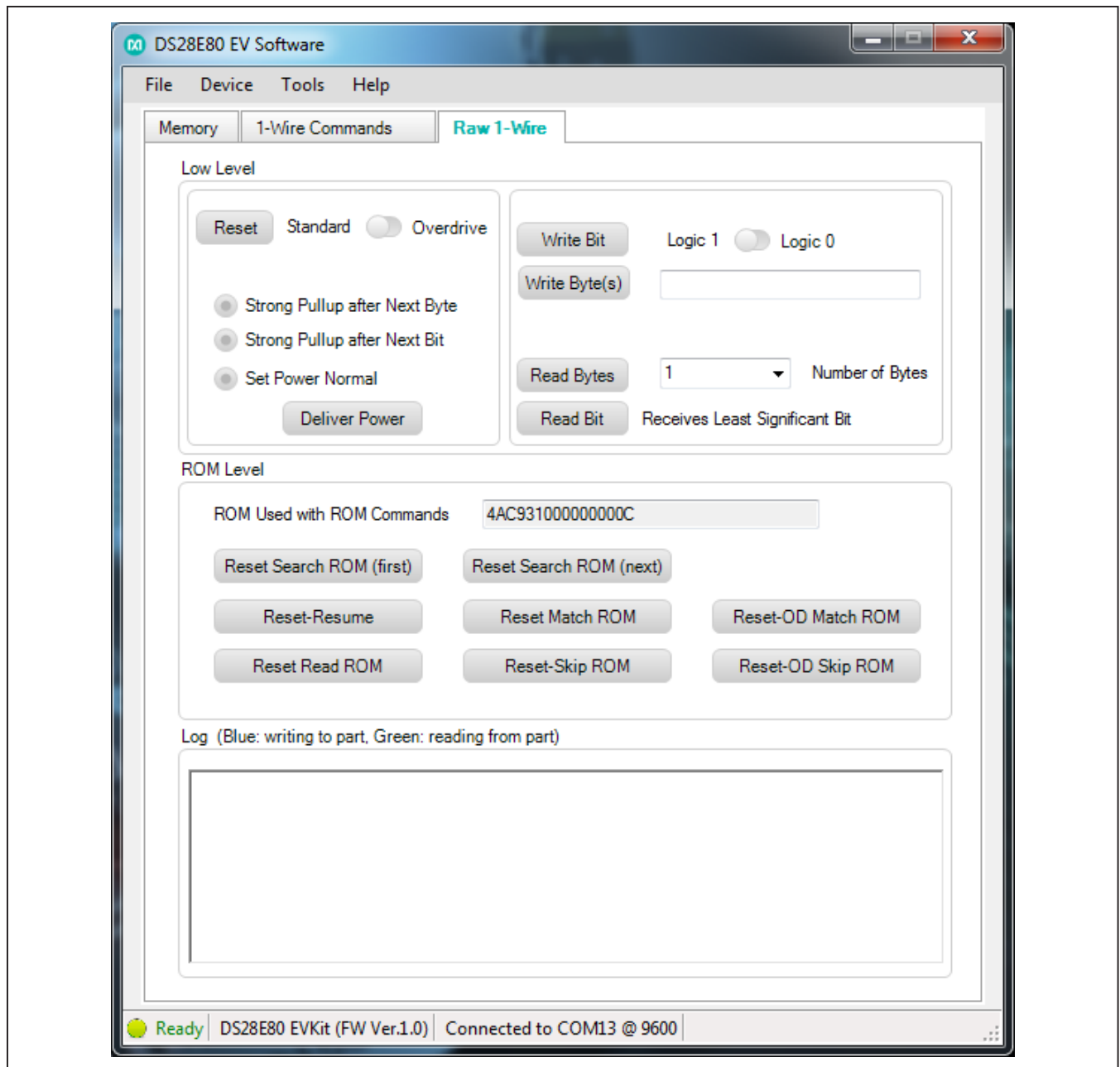

Figure 23. Raw 1-Wire Tab Functions

**Table 5. Raw 1-Wire Tab (Low Level Group Box)**

ELEMENT NAME (TYPE)	DESCRIPTION
<b>Reset</b> (button)	Generates a 1-Wire reset at the speed specified by the toggle button.
<b>Standard/Overdrive</b> (toggle button)	Defines the speed to be used for 1-Wire communication.
<b>Strong Pullup after Next Byte</b> (radio button)	Starts the 1-Wire strong-pullup power delivery after the next byte (either read or write).
<b>Strong Pullup after Next Bit</b> (radio button)	Starts the 1-Wire strong-pullup power delivery after the next communication bit (either read or write).
<b>Set Power Normal</b> (radio button)	Ends the 1-Wire strong-pullup power-delivery mode. Returns the 1-Wire bus from power-down state to normal power.
<b>Deliver Power</b> (button)	Delivers power to the device at the power selected by the radio buttons.
<b>Write Bit</b> (button)	Generates a write time slot on the 1-Wire bus. Bit sent is specified in the <b>Logic 1 Logic 0</b> toggle button.
<b>Write Byte(s)</b> (button)	Transmits the bytes displayed in the <b>Write Byte(s)</b> edit box/drop-down list on the 1-Wire bus.
<b>Read Bytes</b> (button)	Reads as many bytes from the 1-Wire bus, specified by the <b>Number of Bytes</b> to read counter.
<b>Number of Bytes</b> (drop-down list)	Specifies the number of bytes to be read when using the <b>Read Bytes</b> button.
<b>Read Bit</b> (button)	Generates a read-data time slot on the 1-Wire bus.

**Table 6. Raw 1-Wire Tab (ROM Level Group Box)**

ELEMENT NAME (TYPE)	DESCRIPTION
<b>ROM Used with ROM Commands</b> (edit box)	The data in this field is used with the ROM function buttons to select a particular 1-Wire slave device. This field can be manually edited to input the ROM ID of the device to be selected. It is automatically filled when using one of the following buttons: <b>Reset Search-ROM (first)</b> , <b>Reset Search-ROM (next)</b> , or <b>Reset Read ROM</b> .
<b>Reset Search ROM (first)</b> (button)	Sends a 1-Wire reset and performs the search-ROM sequence to discover the first 1-Wire slave device on the network. The ROM IDs and binary search sequence, not physical location, determine the order of the devices discovered. Refer to Application Note 187: <i>1-Wire Search Algorithm</i> for details.
<b>Reset Search-ROM (next)</b> (button)	Sends a 1-Wire reset and continues the search-ROM sequence from where the last binary search left off and finds the next 1-Wire slave device on the bus.
<b>Reset-Resume</b> (button)	Sends a 1-Wire reset, followed by the Resume command, A5 (hex).
<b>Reset Match ROM</b> (button)	Sends the 1-Wire reset followed by the Match ROM command (55h), followed by the 8 bytes of the ROM ID in the <b>ROM Used with ROM Commands</b> . A warning is displayed if the <b>ROM Used with ROM Commands</b> edit box is empty.
<b>Reset-OD Match ROM</b> (button)	Sends the 1-Wire reset, followed by the Overdrive Match ROM command (69h), followed by the 8 bytes of the ROM ID in the <b>ROM Used with ROM Commands</b> edit box.
<b>Reset Read ROM</b> (button)	Sends the 1-Wire reset followed by the Read ROM command (33h), and then reads the 64-bit ROM ID of the 1-Wire slave device. The CRC8 within the number is checked to verify the ROM ID's validity. A warning is logged if the CRC8 is not valid. The ROM ID is also loaded into the <b>ROM Used with ROM Commands</b> edit box.
<b>Reset-Skip-ROM</b> (button)	Sends a 1-Wire reset followed by the CCh Skip ROM command. This selects all devices on the 1-Wire bus.
<b>Reset-OD Skip ROM</b> (button)	Sends a 1-Wire Reset followed by the 3Ch Overdrive Skip ROM command. This sets all devices on the 1-Wire bus to <b>Overdrive</b> speed.

**Table 7. Communication Log Decoder**

CODE	1-WIRE ACTIVITY	DESCRIPTION
R	Reset Pulse	The 1-Wire master generates a reset pulse.
RP	Presence Pulse	The 1-Wire master generates a reset pulse and receives a presence pulse.
RN	No Presence Pulse	The 1-Wire master generates a reset pulse and does not receive a presence pulse.
HH	Writing 1 byte	The 1-Wire master transmits a single byte. The byte value (a pair of hex digits) is shown in place of HH.
[HH]	Reading 1 byte	The 1-Wire master reads a single byte. The byte value (a pair of hex digits) is shown in place of HH.
1b	Write a 1 bit	The 1-Wire master generates a write-one time slot.
0b	Write a 0 bit	The 1-Wire master generates a write-zero time slot.
[1b]	Read 1 bit	The 1-Wire master generates a read-data time slot and reads 1.
[0b]	Read 0 bity	The 1-Wire master generates a read-data time slot and reads 0.
//	(none)	Lines beginning with // are comments.
<OVD>	Overdrive Speed	Overdrive speed mode.
<STD>	Standard Speed	Standard speed mode.

**Table 8. RJ11 Pin Assignment**

PIN NUMBER	SIGNAL NAME	DESCRIPTION
1	VCC	Not used for the DS28E80
2	VCC GND	Not used for the DS28E80
3	1W	1-Wire data
4	GND	1-Wire ground geference
5	PULSE	Not used for the DS28E80
6	(Reserved)	Not used for the DS28E80

## Detailed Description of Hardware

### RJ11 Pin Assignment

[Table 8](#) shows the pin assignment at RJ11 on the DS9120Q+ socket board and the DS9481R-3C7+ USB-to-1-Wire/iButton adapter.

### Evaluation Socket Schematic and Layout

[Figure 24](#) and [Figure 25](#) show the schematic and layout of the socket board.

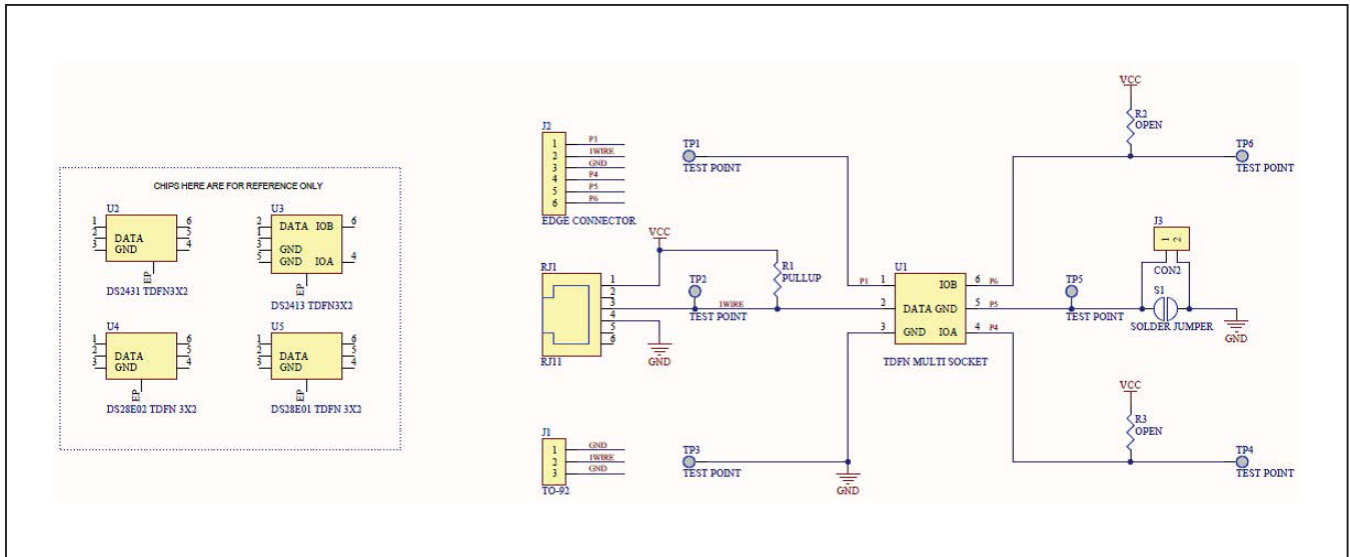

Figure 24. DS9120Q+ Socket Board Schematic

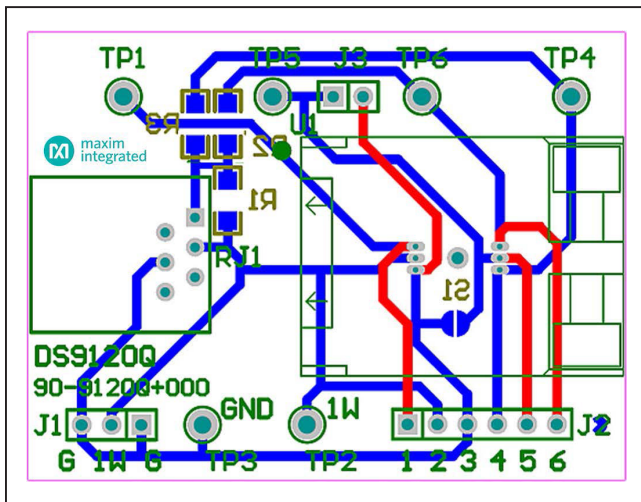

Figure 25. DS9120Q+ Socket Board Composite Layout

Table 9. PCB Color Legend

COLOR	DESCRIPTION
Red	Top metal layer
Green	Top silk screen
Brown	Bottom silk screen
Blue	Bottom metal layer
Grey	All metal layers
Purple	Board outline



## Appendix A: Extended Setup Guide

### Installing the Prolific Device Driver for the DS9481R-3C7+

The DS9481R-3C7+ USB-to-1-Wire/iButton adapter uses both the Prolific PL-2303HXD and a microcontroller to provide a 1-Wire port on the computer. Many Microsoft operating systems have a version of the PL-2303 Prolific Driver preloaded. Plugging in the DS9481R-3C7+ device for the first time often completes the installation. If the Microsoft operating system in question cannot install the device driver, then do the following:

- 1) Unplug the DS9481R-3C7+.
- 2) Download the driver file labeled PL2303\_Prolific\_DriverInstaller\_v1\_9\_0.zip or newer from [http://files.maximintegrated.com/sia\\_bu/public/PL2303\\_Prolific\\_DriverInstaller.zip](http://files.maximintegrated.com/sia_bu/public/PL2303_Prolific_DriverInstaller.zip).
- 3) Unzip the downloaded archive and run the executable file that begins with PL2303\_Prolific\_DriverInstaller. Follow the directions of the Install Wizard until the PL-2303 USB-to-serial driver install is finished.
- 4) Close the installation by clicking the **Finish** button.
- 5) Verify correct installation of the virtual COM port by inserting the DS9481R-3C7+ into a spare USB port on the computer. Check the COM port by looking in Control Panel → System Hardware → Device Manager and expand Ports (COM & LPT). If the driver installed correctly it should be displayed, as in the example shown in [Figure 26](#). Note that your COM port number may be different. **Warning:** The 1-Wire drivers only support COM ports up to COM15.
- 6) Once installed, return to the *Procedure* section and execute Step 5.

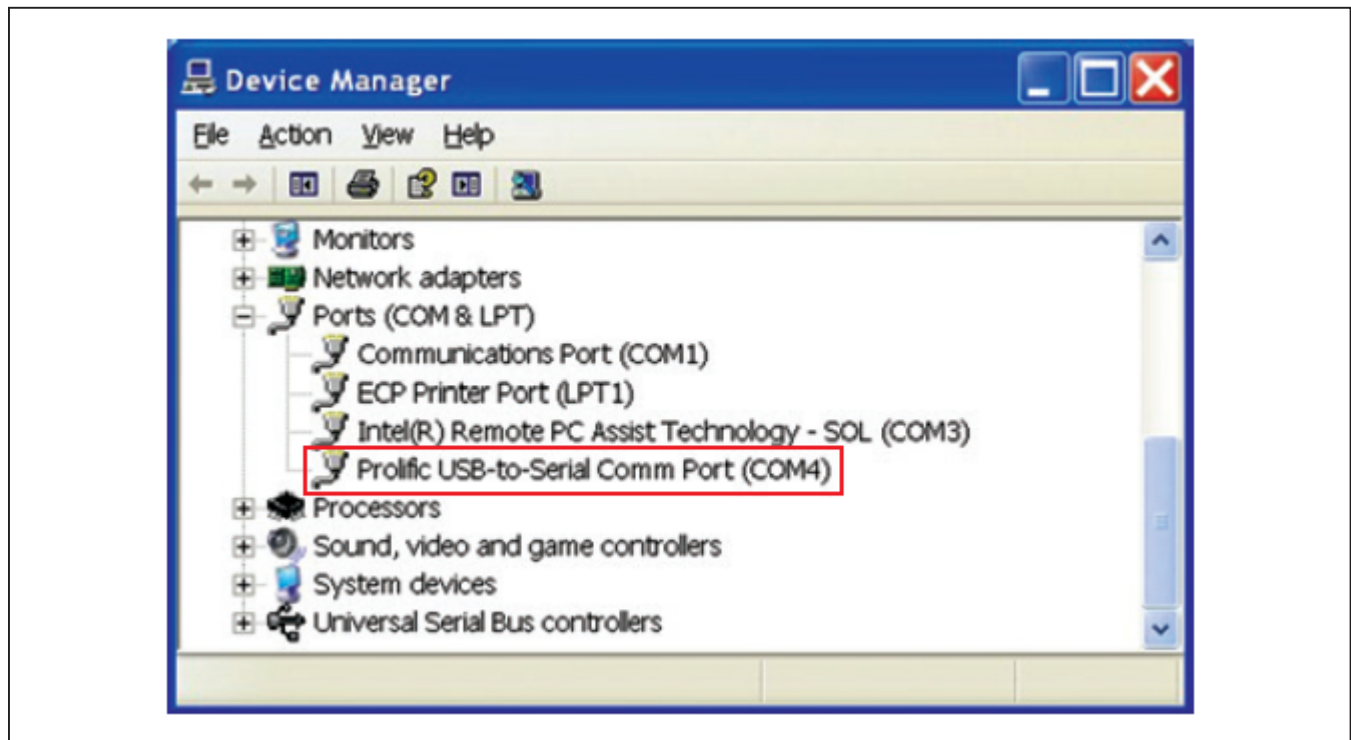

Figure 26. DS9481R-3C7+ “Prolific” COM Port

### Installing 1-Wire Drivers

The DS9481R-3C7+ USB-to-1-Wire/iButton adapter also requires 1-Wire drivers to operate the 1-Wire port. Unless you have been using 1-Wire devices before (e.g., with a different adapter), the drivers need to be installed before the EV kit software can function. Follow the steps below to install the 1-Wire Drivers software package. For expanded installation details, refer to Tutorial 4373: *OneWireViewer and iButton Quick Start Guide*, which is available at [www.maximintegrated.com/app-notes/index.mvp/id/4373](http://www.maximintegrated.com/app-notes/index.mvp/id/4373).

To download the 1-Wire Drivers software package, do the following:

- 1) Go to [www.maximintegrated.com/1-wiredrivers](http://www.maximintegrated.com/1-wiredrivers). Click on the button that takes you to the download page. Select the applicable version of the Windows operating system, and then select the file that corresponds to your computer's configuration (i.e., 32-Bit 1-Wire Drivers or 64-Bit 1-Wire Drivers), and finally, click **Download**.
- 2) When prompted with the question **Do you want to run or save this file?**, select **Run**.
- 3) When you get a security warning that states **Do you want to run the software?**, select **Run**.
- 4) Read and check the box if you accept the license agreement and click **Install**.
- 5) Click **Finish** to exit the **Setup Wizard**.
- 6) Return to the *Procedure* section and execute Step 5.

### Installing Microsoft .NET Framework

The DS28E80 EV kit software requires the Microsoft .NET Framework Version 3.5 SP1 for the program to run. To check whether it is installed, look in the Control Panel under Add/Remove Programs. If Microsoft.NET is not listed, it is not installed. For installation instructions and download, go to <http://msdn.microsoft.com/en-us/vstudio/aa496123>.

### Ordering Information

PART	TYPE
DS28E80EVKIT#	EV System

#Denotes RoHS compliant.

## Revision History

REVISION NUMBER	REVISION DATE	DESCRIPTION	PAGES CHANGED
0	11/14	Initial release	—

For pricing, delivery, and ordering information, please contact Maxim Direct at 1-888-629-4642, or visit Maxim Integrated's website at [www.maximintegrated.com](http://www.maximintegrated.com).

*Maxim Integrated cannot assume responsibility for use of any circuitry other than circuitry entirely embodied in a Maxim Integrated product. No circuit patent licenses are implied. Maxim Integrated reserves the right to change the circuitry and specifications without notice at any time.*