

## Single-Lane PCIe Equalizer/Redriver

### General Description

The MAX14950A dual equalizer/redriver improves PCI Express® (PCIe) signal integrity by providing programmable input equalization. This feature reduces deterministic jitter and redrives circuitry to reestablish deemphasis, which compensates for circuit-board loss at high frequencies. The device permits optimal placement of key PCIe components and allows for longer runs of stripline, microstrip, or cable.

The device contains two identical channels capable of equalizing PCIe Gen III (8GT/s), Gen II (5GT/s), and Gen I (2.5GT/s) signals and features electrical idle and receiver detection.

The MAX14950A is available in a small, 40-pin, 5.0mm x 5.0mm TQFN package with flow-through traces for optimal layout and minimal space requirements. It is specified over the 0°C to +70°C commercial operating temperature range.

### Applications

Servers  
Test Equipment  
External Graphics Applications  
Communications Switchers  
Storage Area Networks

### Benefits and Features

- ◆ **Innovative Design Eliminates Need for Costly External Components**
  - ◇ Single +3.3V Supply Operation
- ◆ **Increased Design Flexibility for Backward-Compatible Applications**
  - ◇ Optimized for PCIe Gen III (8GT/s) and Gen II (5GT/s) Signals and Compatible with Gen I (2.5GT/s) Signals
- ◆ **High Level of Integration for Performance**
  - ◇ Random Jitter: 0.5ps<sub>RMS</sub>, Deterministic Jitter: 7ps<sub>p-p</sub>
  - ◇ Four-Level-Programmable Input Equalization
  - ◇ Eight-Level-Programmable Output Emphasis
  - ◇ Electrical Idle Detection
  - ◇ Receiver Detection Permits Completely Transparent Operation
- ◆ **Ideal for Space-Sensitive Applications**
  - ◇ On-Chip 50Ω Input/Output Terminations
  - ◇ 40-Pin, 5.0mm x 5.0mm TQFN Packaging

*Ordering Information appears at end of data sheet.*

For related parts and recommended products to use with this part, refer to [www.maximintegrated.com/MAX14950A.related](http://www.maximintegrated.com/MAX14950A.related).

### Typical Operating Circuit

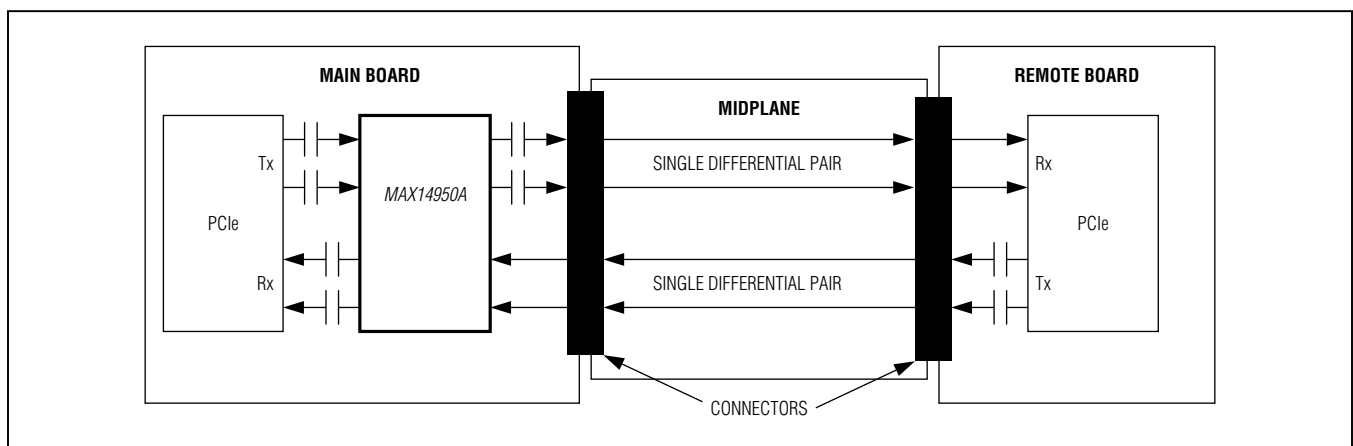

PCI Express is a registered service mark of PCI-SIG Corporation.

# MAX14950A

## Single-Lane PCIe Equalizer/Redriver

### ABSOLUTE MAXIMUM RATINGS

(Voltages referenced to GND.)

V <sub>CC</sub> .....	-0.3V to +4.0V
All Other Pins (Note 1) .....	-0.3V to (V <sub>CC</sub> + 0.3V)
Continuous Current IN_P, IN_M, OUT_P, OUT_M.....	±30mA
Peak Current IN_P, IN_M, OUT_P, OUT_M (pulsed for 1μs, 1% duty cycle).....	±100mA

Continuous Power Dissipation (T<sub>A</sub> = +70°C)

TQFN (derate 35.7mW/°C above +70°C).....	2857mW
Operating Temperature Range.....	0°C to +70°C
Junction Temperature Range.....	-40°C to +150°C
Storage Temperature Range.....	-65°C to +150°C
Lead Temperature (soldering, 10s) .....	+300°C
Soldering Temperature (reflow) .....	+260°C

**Note 1:** All I/O pins are clamped by internal diodes.

Stresses beyond those listed under "Absolute Maximum Ratings" may cause permanent damage to the device. These are stress ratings only, and functional operation of the device at these or any other conditions beyond those indicated in the operational sections of the specifications is not implied. Exposure to absolute maximum rating conditions for extended periods may affect device reliability.

### PACKAGE THERMAL CHARACTERISTICS (Note 2)

TQFN

Junction-to-Ambient Thermal Resistance (θ <sub>JA</sub> ) .....	28°C/W
Junction-to-Case Thermal Resistance (θ <sub>JC</sub> ).....	2°C/W

**Note 2:** Package thermal resistances were obtained using the method described in JEDEC specification JESD51-7, using a four-layer board. For detailed information on package thermal considerations, refer to [www.maximintegrated.com/thermal-tutorial](http://www.maximintegrated.com/thermal-tutorial).

### ELECTRICAL CHARACTERISTICS

(V<sub>CC</sub> = +3.0V to +3.6V, C<sub>CL</sub> = 200nF coupling capacitor on each output, R<sub>L</sub> = 50Ω on each output, T<sub>A</sub> = 0°C to +70°C, unless otherwise noted. Typical values are at V<sub>CC</sub> = +3.3V and T<sub>A</sub> = +25°C.) (Note 3)

PARAMETER	SYMBOL	CONDITIONS	MIN	TYP	MAX	UNITS
<b>DC PERFORMANCE</b>						
Power-Supply Range	V <sub>CC</sub>		3.0	3.3	3.6	V
Supply Current	I <sub>CC</sub>	EN = V <sub>CC</sub>	OEQ_2 = OEQ_1 = OEQ_0 = GND	102	135	mA
			OEQ_2 = OEQ_1 = GND, OEQ_0 = V <sub>CC</sub>	106	140	
			OEQ_2 = OEQ_0 = GND, OEQ_1 = V <sub>CC</sub>	107	140	
			OEQ_2 = GND, OEQ_1 = OEQ_0 = V <sub>CC</sub>	125	160	
			OEQ_2 = V <sub>CC</sub> , OEQ_1 = OEQ_0 = GND	106	140	
			OEQ_2 = OEQ_0 = V <sub>CC</sub> , OEQ_1 = GND	132	170	
			OEQ_2 = OEQ_1 = V <sub>CC</sub> , OEQ_0 = GND	140	180	
			OEQ_2 = OEQ_1 = OEQ_0 = V <sub>CC</sub>	165	210	

# MAX14950A

## Single-Lane PCIe Equalizer/Redriver

### ELECTRICAL CHARACTERISTICS (continued)

( $V_{CC} = +3.0V$  to  $+3.6V$ ,  $C_{CL} = 200nF$  coupling capacitor on each output,  $R_L = 50\Omega$  on each output,  $T_A = 0^\circ C$  to  $+70^\circ C$ , unless otherwise noted. Typical values are at  $V_{CC} = +3.3V$  and  $T_A = +25^\circ C$ .) (Note 3)

PARAMETER	SYMBOL	CONDITIONS	MIN	TYP	MAX	UNITS	
Standby Current	I <sub>STBY</sub>	EN = GND	OEQ_2 = OEQ_1 = OEQ_0 = GND		57	80	mA
			OEQ_2 = OEQ_1 = GND, OEQ_0 = V <sub>CC</sub>		61	85	
			OEQ_2 = OEQ_0 = GND, OEQ_1 = V <sub>CC</sub>		62	85	
			OEQ_2 = GND, OEQ_1 = OEQ_0 = V <sub>CC</sub>		75	100	
			OEQ_2 = V <sub>CC</sub> , OEQ_1 = OEQ_0 = GND		62	80	
			OEQ_2 = OEQ_0 = V <sub>CC</sub> , OEQ_1 = GND		85	110	
			OEQ_2 = OEQ_1 = V <sub>CC</sub> , OEQ_0 = GND		92	120	
			OEQ_2 = OEQ_1 = OEQ_0 = V <sub>CC</sub>		120	150	
Differential Input Impedance	Z <sub>RX-DIFF-DC</sub>	DC	80	100	120	Ω	
Differential Output Impedance	Z <sub>TX-DIFF-DC</sub>	DC	80	100	120	Ω	
Common-Mode Resistance to GND, Input Termination Not Powered	Z <sub>RX-HIGH-IMP-DC</sub>	-150mV ≤ V <sub>IN-CM</sub> ≤ +200mV	50			kΩ	
Common-Mode Resistance to GND, Input Termination Powered	Z <sub>RX-DC</sub>		20	25	30	Ω	
Output Short-Circuit Current	I <sub>TX-SHORT</sub>	Single-ended (Note 4)	90			mA	
Common-Mode Delta, Between Active and Idle States	V <sub>TX-CM-DC-ACTIVE-IDLE-DELTA</sub>				100	mV	
DC Output Offset, During Active State	V <sub>TX-ACTIVE-DIFF-DC</sub>	V <sub>OUT_P</sub> - V <sub>OUT_M</sub>			65	mV	
DC Output Offset, During Electrical Idle	V <sub>TX-IDLE-DIFF-DC</sub>	V <sub>OUT_P</sub> - V <sub>OUT_M</sub>			65	mV	

# MAX14950A

## Single-Lane PCIe Equalizer/Redriver

### ELECTRICAL CHARACTERISTICS (continued)

( $V_{CC} = +3.0V$  to  $+3.6V$ ,  $C_{CL} = 200nF$  coupling capacitor on each output,  $R_L = 50\Omega$  on each output,  $T_A = 0^\circ C$  to  $+70^\circ C$ , unless otherwise noted. Typical values are at  $V_{CC} = +3.3V$  and  $T_A = +25^\circ C$ .) (Note 3)

PARAMETER	SYMBOL	CONDITIONS	MIN	TYP	MAX	UNITS
<b>AC PERFORMANCE (Note 4)</b>						
Input Return Loss, Differential	RL <sub>RX-DIFF</sub>	f = 0.05GHz to 1.25GHz	9			dB
		f = 1.25GHz to 2.5GHz	8			dB
		f = 2.5GHz to 4GHz	5			dB
Input Return Loss, Common Mode	RL <sub>RX-CM</sub>	f = 0.05GHz to 2.5GHz	6			dB
		f = 2.5GHz to 4GHz	4			dB
Output Return Loss, Differential	RL <sub>TX-DIFF</sub>	f = 0.05GHz to 1.25GHz	10			dB
		f = 1.25GHz to 2.5GHz	8			dB
		f = 2.5GHz to 4GHz	4			dB
Output Return Loss, Common Mode	RL <sub>TX-CM</sub>	f = 0.05GHz to 2.5GHz	6			dB
		f = 2.5GHz to 4GHz	4			dB
Redriver-Operation Differential Input-Signal Range	V <sub>RX-DIFF-PP</sub>		100		1400	mV <sub>P-P</sub>
Full-Swing Differential Output Voltage (No Deemphasis)	V <sub>TX-DIFF-PP</sub>	OEQ_2 = OEQ_1 = OEQ_0 = GND	800	1000	1400	mV <sub>P-P</sub>
Output Deemphasis Ratio, 0dB	V <sub>TX-DE-RATIO-0dB</sub>	OEQ_2 = OEQ_1 = OEQ_0 = GND, Figure 1		0		dB
Output Deemphasis Ratio, 3.5dB	V <sub>TX-DE-RATIO-3.5dB</sub>	OEQ_2 = OEQ_1 = GND, OEQ_0 = V <sub>CC</sub> , Figure 1		3.5		dB
Output Deemphasis Ratio, 6dB	V <sub>TX-DE-RATIO-6dB</sub>	OEQ_2 = OEQ_0 = GND, OEQ_1 = V <sub>CC</sub> , Figure 1		6		dB
Output Deemphasis Ratio, 6dB with Higher Amplitude	V <sub>TX-DE-HA-RATIO-6dB</sub>	OEQ_2 = GND, OEQ_1 = OEQ_0 = V <sub>CC</sub> , Figure 1		6		dB
Output Deemphasis Ratio, 3.5dB with Preshoot	V <sub>TX-DE-PS-RATIO-3.5dB</sub>	OEQ_2 = V <sub>CC</sub> , OEQ_1 = OEQ_0 = GND, Figure 1		3.5		dB
Output Deemphasis Ratio, 6dB with Preshoot	V <sub>TX-DE-PS-RATIO-6dB</sub>	OEQ_2 = OEQ_0 = V <sub>CC</sub> , OEQ_1 = GND, Figure 1		6		dB
Output Deemphasis Ratio, 9dB with Preshoot	V <sub>TX-DE-PS-RATIO-9dB</sub>	OEQ_2 = OEQ_1 = V <sub>CC</sub> , OEQ_0 = GND, Figure 1		9		dB
Output Deemphasis Ratio, 9dB with Preshoot and Higher Amplitude	V <sub>TX-DE-PS-HA-RATIO-9dB</sub>	OEQ_2 = OEQ_1 = OEQ_0 = V <sub>CC</sub> , Figure 1		9		dB
Input Equalization, 5dB	V <sub>RX-EQ-5dB</sub>	INEQ_1 = INEQ_0 = GND (Note 5)		5		dB

# MAX14950A

## Single-Lane PCIe Equalizer/Redriver

### ELECTRICAL CHARACTERISTICS (continued)

( $V_{CC} = +3.0V$  to  $+3.6V$ ,  $C_{CL} = 200nF$  coupling capacitor on each output,  $R_L = 50\Omega$  on each output,  $T_A = 0^\circ C$  to  $+70^\circ C$ , unless otherwise noted. Typical values are at  $V_{CC} = +3.3V$  and  $T_A = +25^\circ C$ .) (Note 3)

PARAMETER	SYMBOL	CONDITIONS	MIN	TYP	MAX	UNITS
Input Equalization, 8dB	$V_{RX-EQ-8dB}$	$INEQ_1 = GND, INEQ_0 = V_{CC}$ (Note 5)		8		dB
Input Equalization, 12dB	$V_{RX-EQ-12dB}$	$INEQ_1 = V_{CC}, INEQ_0 = GND$ (Note 5)		12		dB
Input Equalization, 16dB	$V_{RX-EQ-16dB}$	$INEQ_1 = INEQ_0 = V_{CC}$ (Note 5)		16		dB
Output Common-Mode Voltage	$V_{TX-CM-AC-PP}$	$MAX(V_{OUT\_P} + V_{OUT\_M})/2 - MIN(V_{OUT\_P} + V_{OUT\_M})/2$			100	mV <sub>P-P</sub>
Propagation Delay	$t_{PD}$		90	160	240	ps
Rise/Fall Time	$t_{TX-RISE-FALL}$	(Note 6)	20			ps
Rise/Fall Time Mismatch	$t_{TX-RF-MISMATCH}$	(Note 6)			20	ps
Deterministic Jitter	$t_{TX-DJ-DD}$	K28.5 pattern, AC-coupled, $R_L = 50\Omega$ , no deemphasis, no preshoot, data rate = 8GT/s		7	23.5	ps <sub>P-P</sub>
Random Jitter	$t_{TX-RJ-DD}$	D10.2 pattern, no deemphasis, no preshoot, data rate = 8GT/s		0.5	1.5	ps <sub>RMS</sub>
Electrical Idle Entry Delay	$t_{TX-IDLE-SET-TO-IDLE}$	From input to output, D10.2 pattern, data rate = 1GT/s		5		ns
Electrical Idle Exit Delay	$t_{TX-IDLE-TO-DIFF-DATA}$	From input to output, D10.2 pattern, data rate = 1GT/s		5		ns
Electrical Idle Detect Threshold	$V_{TX-IDLE-THRESH}$	D10.2 pattern, data rate = 1GT/s (Note 3)	50	112	190	mV <sub>P-P</sub>
		D10.2 pattern, data rate = 1GT/s to 8GT/s		112		
Output Voltage During Electrical Idle (AC)	$V_{TX-IDLE-DIFF-AC-P}$	$ (V_{OUT\_P} - V_{OUT\_M}) $			20	mV <sub>P-P</sub>
Receiver-Detect Pulse Amplitude	$V_{TX-RCV-DETECT}$	Voltage change in positive direction		600		mV

# MAX14950A

## Single-Lane PCIe Equalizer/Redriver

### ELECTRICAL CHARACTERISTICS (continued)

( $V_{CC} = +3.0V$  to  $+3.6V$ ,  $C_{CL} = 200nF$  coupling capacitor on each output,  $R_L = 50\Omega$  on each output,  $T_A = 0^\circ C$  to  $+70^\circ C$ , unless otherwise noted. Typical values are at  $V_{CC} = +3.3V$  and  $T_A = +25^\circ C$ .) (Note 3)

PARAMETER	SYMBOL	CONDITIONS	MIN	TYP	MAX	UNITS
Receiver-Detect Pulse Width				100		ns
Receiver-Detect Retry Period				200		ns
<b>CONTROL LOGIC</b>						
Input-Logic Level Low	$V_{IL}$				0.6	V
Input-Logic Level High	$V_{IH}$		1.4			V
Input-Logic Hysteresis	$V_{HYST}$			0.1		V
Input Pulldown Resistance	$R_{PD}$		200	375		$k\Omega$
<b>ESD PROTECTION</b>						
ESD Voltage		Human Body Model (HBM)		$\pm 4$		kV

**Note 3:** All devices are 100% production tested at  $T_A = +70^\circ C$ . Specifications over operating temperature range are guaranteed by design.

**Note 4:** Guaranteed by design, unless otherwise noted.

**Note 5:** Equivalent to same amount of deemphasis driving the input.

**Note 6:** Rise and fall times are measured using 20% and 80% levels.

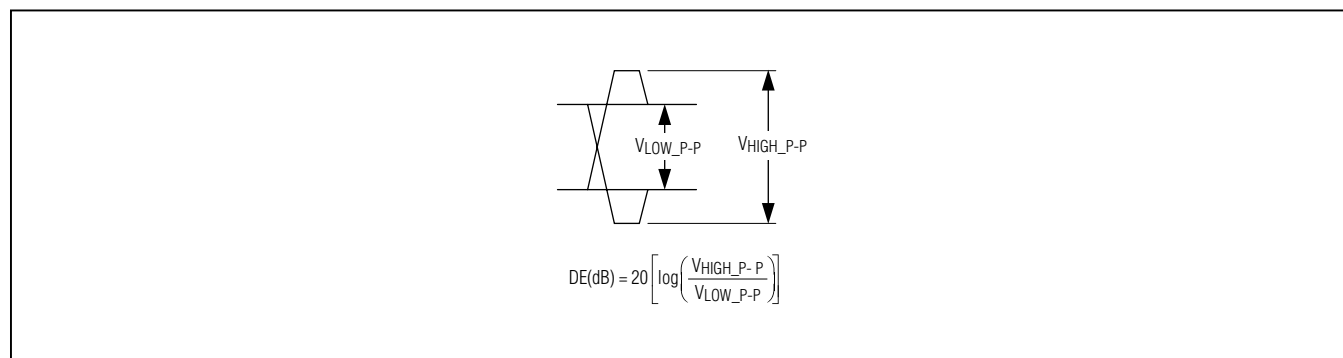

Figure 1. Illustration of Output Deemphasis

# MAX14950A

## Single-Lane PCIe Equalizer/Redriver

### Typical Operating Characteristics

( $V_{CC} = +3.3V$ ,  $T_A = +25^\circ C$ , unless otherwise noted.)

**INEQ0 = INEQ1 = 0,  $V_{IN} = 200mV_{P-P}$ ,  
OEQ0 = 0, OEQ1 = 0, OEQ2 = 0,  
DATA RATE = 5GT/s**

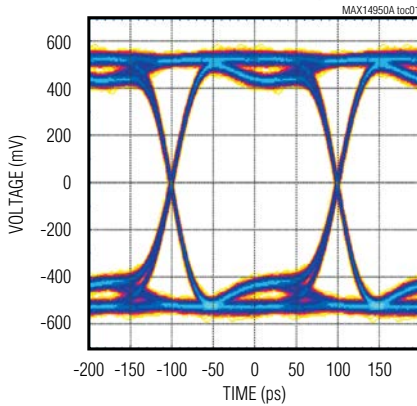

**INEQ0 = INEQ1 = 0,  $V_{IN} = 200mV_{P-P}$ ,  
OEQ0 = 1, OEQ1 = 0, OEQ2 = 0,  
DATA RATE = 5GT/s**

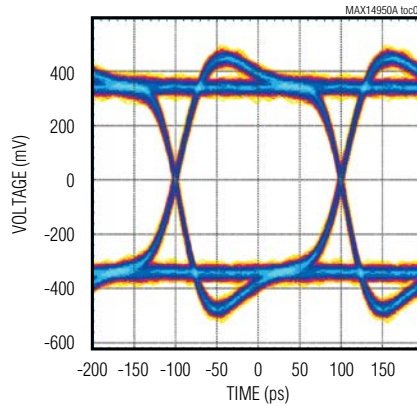

**INEQ0 = INEQ1 = 0,  $V_{IN} = 200mV_{P-P}$ ,  
OEQ0 = 0, OEQ1 = 1, OEQ2 = 0,  
DATA RATE = 5GT/s**

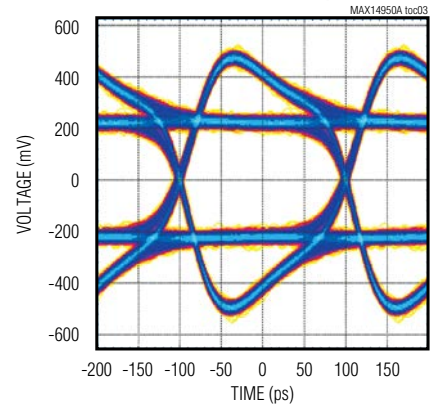

**INEQ0 = INEQ1 = 0,  $V_{IN} = 200mV_{P-P}$ ,  
OEQ0 = 1, OEQ1 = 1, OEQ2 = 0,  
DATA RATE = 5GT/s**

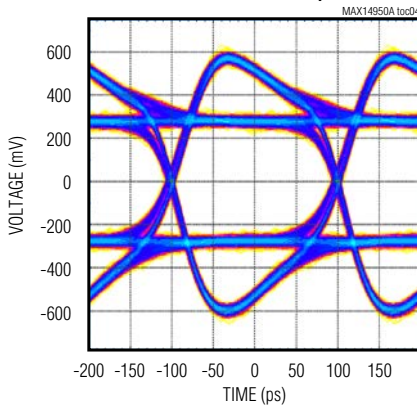

**INEQ0 = INEQ1 = 0,  $V_{IN} = 200mV_{P-P}$ ,  
OEQ0 = 0, OEQ1 = 0, OEQ2 = 1,  
DATA RATE = 5GT/s**

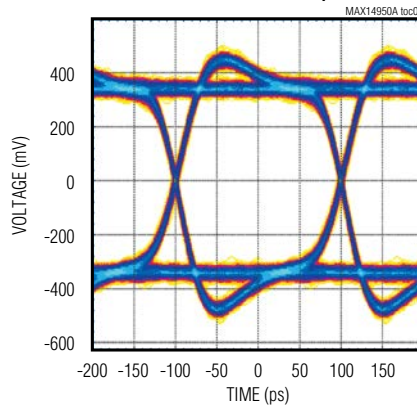

**INEQ0 = INEQ1 = 0,  $V_{IN} = 200mV_{P-P}$ ,  
OEQ0 = 1, OEQ1 = 0, OEQ2 = 1,  
DATA RATE = 5GT/s**

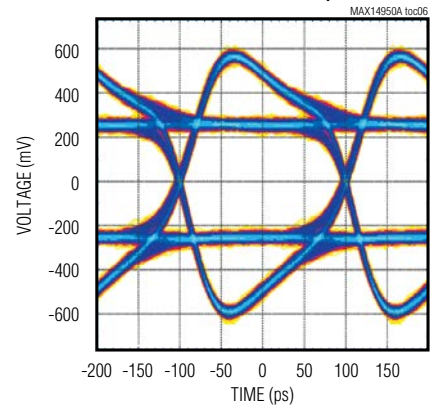

# MAX14950A

## Single-Lane PCIe Equalizer/Redriver

### Typical Operating Characteristics (continued)

( $V_{CC} = +3.3V$ ,  $T_A = +25^\circ C$ , unless otherwise noted.)

**INEQ0 = INEQ1 = 0,  $V_{IN} = 200mVp-p$ ,  
OEQ0 = 0, OEQ1 = 1, OEQ2 = 1,  
DATA RATE = 5GT/s**

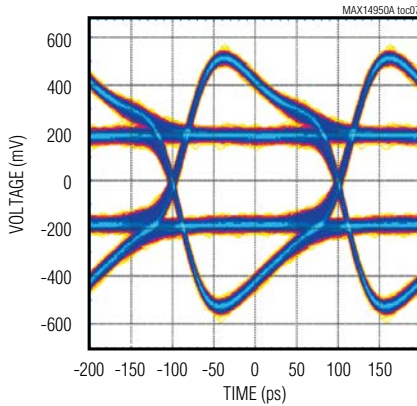

**INEQ0 = INEQ1 = 0,  $V_{IN} = 200mVp-p$ ,  
OEQ0 = 1, OEQ1 = 1, OEQ2 = 1,  
DATA RATE = 5GT/s**

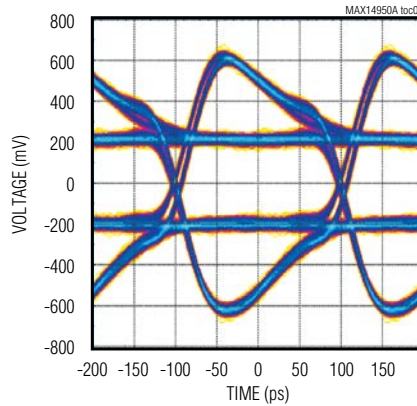

**INEQ0 = 1, INEQ1 = 0,  $V_{IN} = 500mVp-p$ ,  
OEQ0 = OEQ1 = OEQ2 = 0, 6in. MICROSTRIP  
ON INPUT, DATA RATE = 5GT/s**

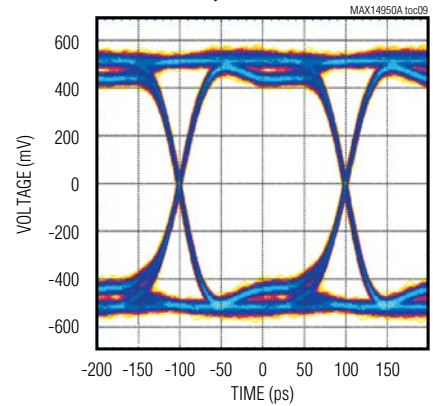

**INEQ0 = 1, INEQ1 = 0,  $V_{IN} = 500mVp-p$ ,  
OEQ0 = OEQ1 = OEQ2 = 0, 12in. MICROSTRIP  
ON INPUT, DATA RATE = 5GT/s**

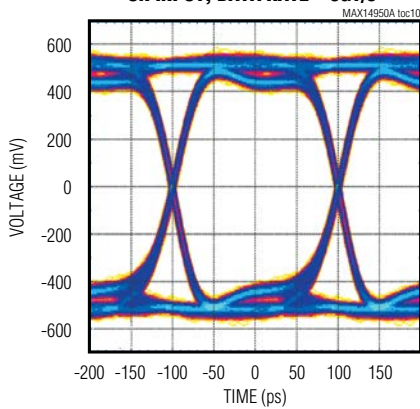

**INEQ0 = 0, INEQ1 = 1,  $V_{IN} = 500mVp-p$ ,  
OEQ0 = OEQ1 = OEQ2 = 0, 18in. MICROSTRIP  
ON INPUT, DATA RATE = 5GT/s**

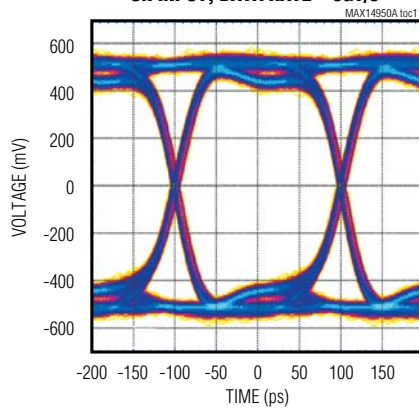

**INEQ0 = 1, INEQ1 = 1,  $V_{IN} = 500mVp-p$ ,  
OEQ0 = OEQ1 = OEQ2 = 0, 24in. MICROSTRIP  
ON INPUT, DATA RATE = 5GT/s**

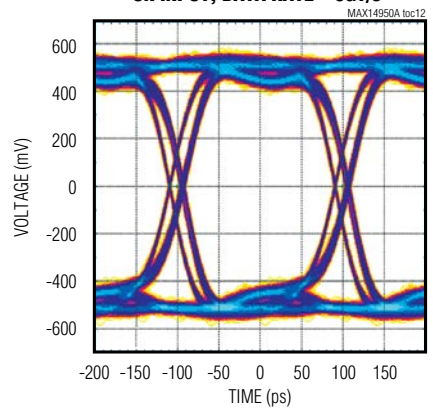



# MAX14950A

## Single-Lane PCIe Equalizer/Redriver

### Typical Operating Characteristics (continued)

( $V_{CC} = +3.3V$ ,  $T_A = +25^\circ C$ , unless otherwise noted.)

**DATA RATE = 5Gbps,  
OUTPUT AFTER 19in STRIP LINE,  
INEQ\_1 = 0,  $V_{IN} = 200mV_{p-p}$ ,  
OEQ\_0 = 1, OEQ\_1 = 0, OEQ\_2 = 0**

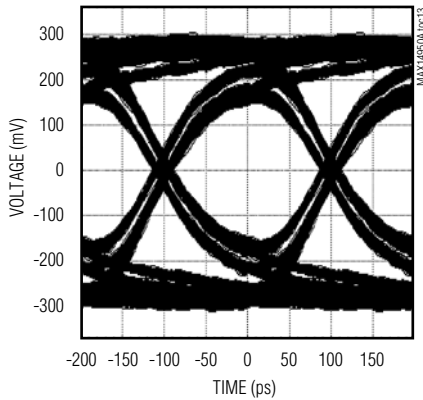

**DATA RATE = 5Gbps,  
OUTPUT AFTER 19in STRIP LINE,  
INEQ\_1 = 0,  $V_{IN} = 200mV_{p-p}$ ,  
OEQ\_0 = 1, OEQ\_1 = 0, OEQ\_2 = 0**

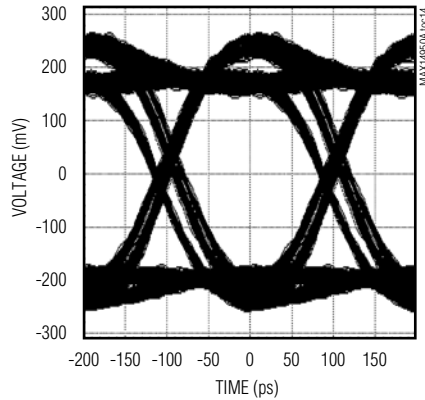

**DATA RATE = 5Gbps,  
OUTPUT AFTER 19in STRIP LINE,  
INEQ\_1 = 0,  $V_{IN} = 200mV_{p-p}$ ,  
OEQ\_0 = 1, OEQ\_1 = 0, OEQ\_2 = 0**

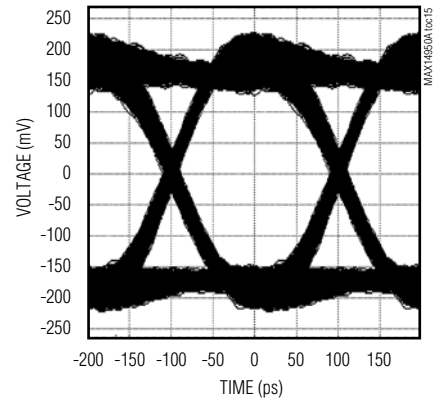

**DATA RATE = 5Gbps,  
OUTPUT AFTER 19in STRIP LINE,  
INEQ\_1 = 0,  $V_{IN} = 200mV_{p-p}$ ,  
OEQ\_0 = 1, OEQ\_1 = 0, OEQ\_2 = 0**

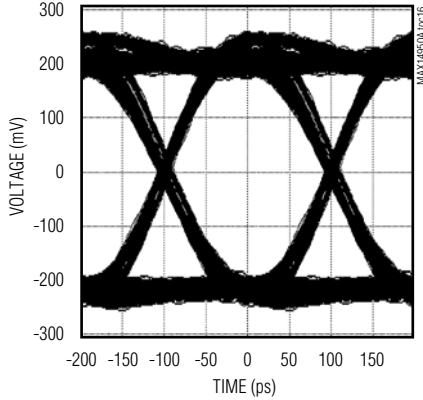

**DATA RATE = 5Gbps,  
OUTPUT AFTER 19in STRIP LINE,  
INEQ\_1 = 0,  $V_{IN} = 200mV_{p-p}$ ,  
OEQ\_0 = 1, OEQ\_1 = 0, OEQ\_2 = 0**

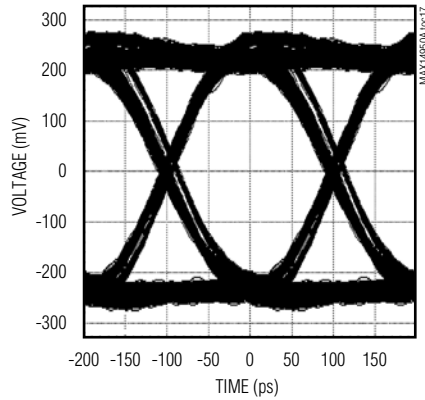

**DATA RATE = 5Gbps,  
OUTPUT AFTER 19in STRIP LINE,  
INEQ\_1 = 0,  $V_{IN} = 200mV_{p-p}$ ,  
OEQ\_0 = 1, OEQ\_1 = 0, OEQ\_2 = 0**

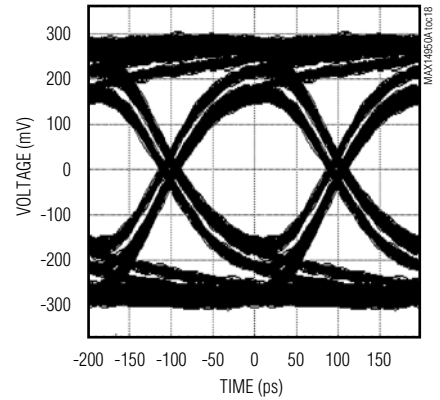

# MAX14950A

## Single-Lane PCIe Equalizer/Redriver

### Typical Operating Characteristics (continued)

( $V_{CC} = +3.3V$ ,  $T_A = +25^\circ C$ , unless otherwise noted.)

**DATA RATE = 5Gbps,  
OUTPUT AFTER 19in STRIP LINE,  
INEQ\_1 = 0,  $V_{IN} = 200mV_{P-P}$ ,  
OEQ\_0 = 1, OEQ\_1 = 0, OEQ\_2 = 0**

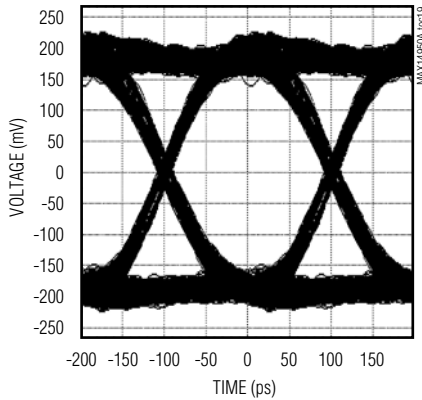

**DATA RATE = 5Gbps,  
OUTPUT AFTER 19in STRIP LINE,  
INEQ\_1 = 0,  $V_{IN} = 200mV_{P-P}$ ,  
OEQ\_0 = 1, OEQ\_1 = 0, OEQ\_2 = 0**

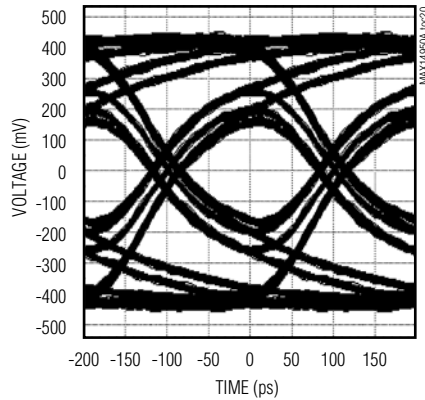

**INEQ0 = INEQ1 = 0,  $V_{IN} = 200mV_{P-P}$ ,  
OEQ0 = 0, OEQ1 = 0, OEQ2 = 0,  
DATA RATE = 8GT/s**

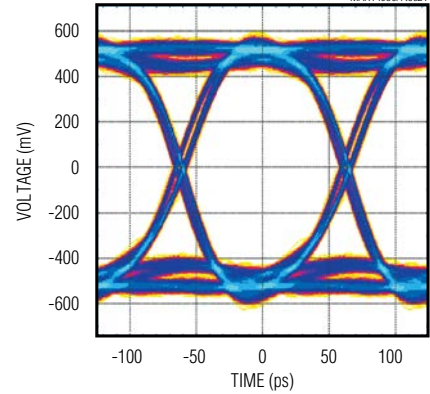

**INEQ0 = INEQ1 = 0,  $V_{IN} = 200mV_{P-P}$ ,  
OEQ0 = 1, OEQ1 = 0, OEQ2 = 0,  
DATA RATE = 8GT/s**

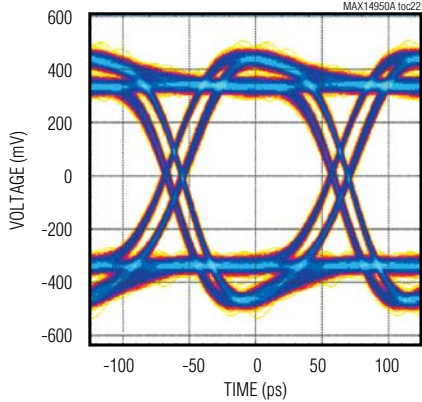

**INEQ0 = INEQ1 = 0,  $V_{IN} = 200mV_{P-P}$ ,  
OEQ0 = 0, OEQ1 = 1, OEQ2 = 0,  
DATA RATE = 8GT/s**

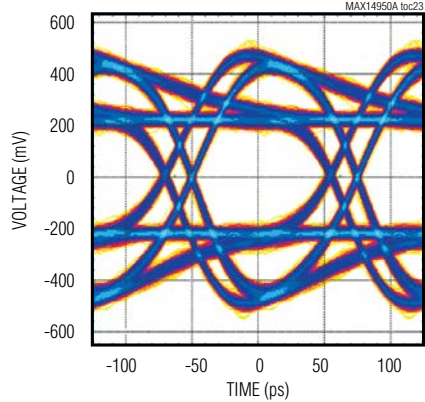

**INEQ0 = INEQ1 = 0,  $V_{IN} = 200mV_{P-P}$ ,  
OEQ0 = 1, OEQ1 = 1, OEQ2 = 0,  
DATA RATE = 8GT/s**

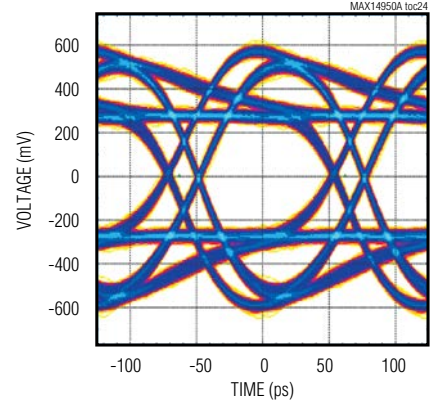

# MAX14950A

## Single-Lane PCIe Equalizer/Redriver

### Typical Operating Characteristics (continued)

( $V_{CC} = +3.3V$ ,  $T_A = +25^\circ C$ , unless otherwise noted.)

**INEQ0 = INEQ1 = 0,  $V_{IN} = 200mVp-p$ ,  
OEQ0 = 0, OEQ1 = 0, OEQ2 = 1,  
DATA RATE = 8GT/s**

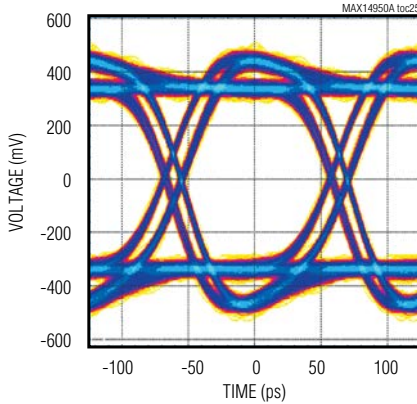

**INEQ0 = INEQ1 = 0,  $V_{IN} = 200mVp-p$ ,  
OEQ0 = 1, OEQ1 = 0, OEQ2 = 1,  
DATA RATE = 8GT/s**

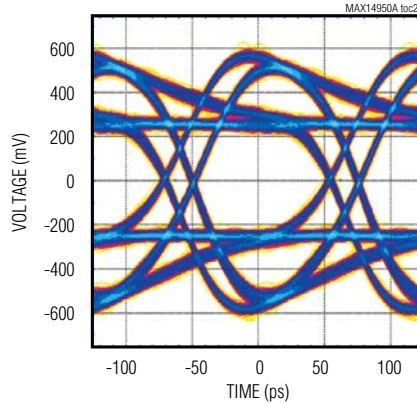

**INEQ0 = INEQ1 = 0,  $V_{IN} = 200mVp-p$ ,  
OEQ0 = 0, OEQ1 = 1, OEQ2 = 1,  
DATA RATE = 8GT/s**

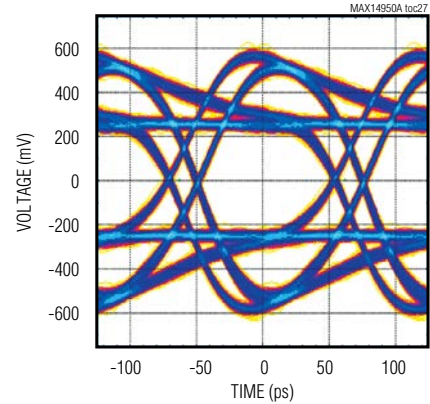

**INEQ0 = INEQ1 = 0,  $V_{IN} = 200mVp-p$ ,  
OEQ0 = 1, OEQ1 = 1, OEQ2 = 1,  
DATA RATE = 8GT/s**

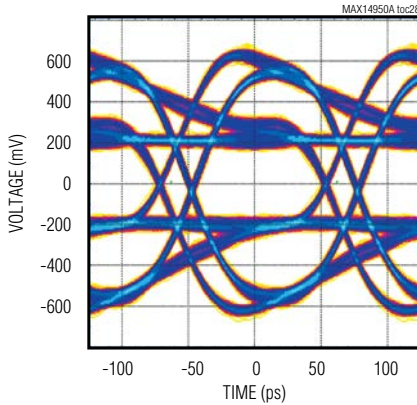

**INEQ0 = 0, INEQ1 = 0,  $V_{IN} = 500mVp-p$ ,  
OEQ0 = OEQ1 = OEQ2 = 0, 6in. MICROSTRIP  
ON INPUT, DATA RATE = 8GT/s**

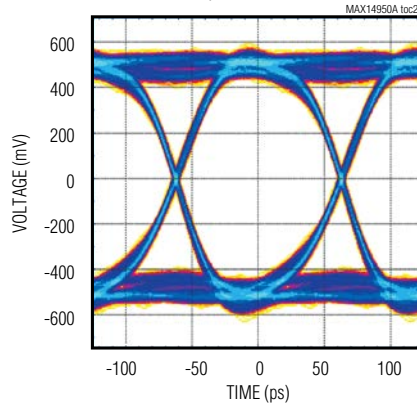

**INEQ0 = 1, INEQ1 = 0,  $V_{IN} = 500mVp-p$ ,  
OEQ0 = OEQ1 = OEQ2 = 0, 12in. MICROSTRIP  
ON INPUT, DATA RATE = 8GT/s**

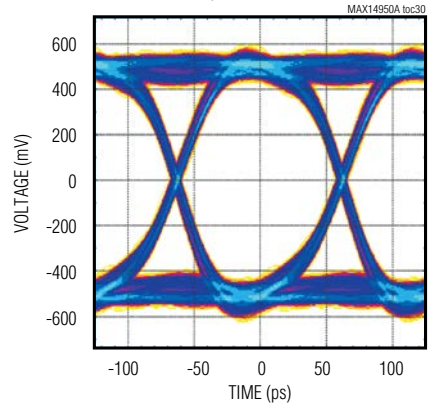

# MAX14950A

## Single-Lane PCIe Equalizer/Redriver

### Typical Operating Characteristics (continued)

( $V_{CC} = +3.3V$ ,  $T_A = +25^\circ C$ , unless otherwise noted.)

**INEQ0 = 0, INEQ1 = 1,  $V_{IN} = 500mVp-p$ ,  
OEQ0 = OEQ1 = OEQ2 = 0, 18in. MICROSTRIP  
ON INPUT, DATA RATE = 8GT/s**

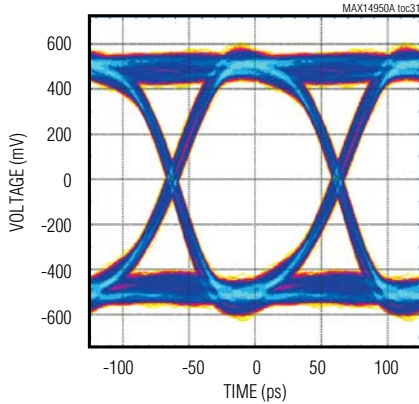

**INEQ0 = 1, INEQ1 = 1,  $V_{IN} = 500mVp-p$ ,  
OEQ0 = OEQ1 = OEQ2 = 0, 24in. MICROSTRIP  
ON INPUT, DATA RATE = 8GT/s**

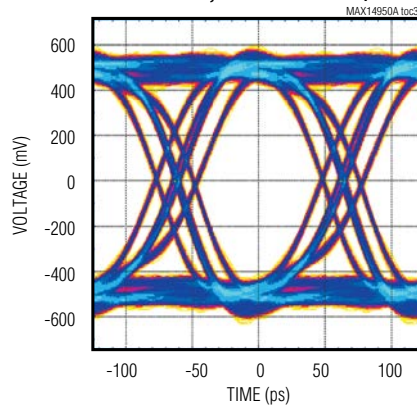

**DATA RATE = 8Gbps, OUTPUT AFTER  
19in STRIPLINE, INEQ\_0 = INEQ\_1 = 0,  
 $V_{IN} = 200mVp-p$ ,  
OEQ\_0 = 1, OEQ\_1 = 0, OEQ\_2 = 0**

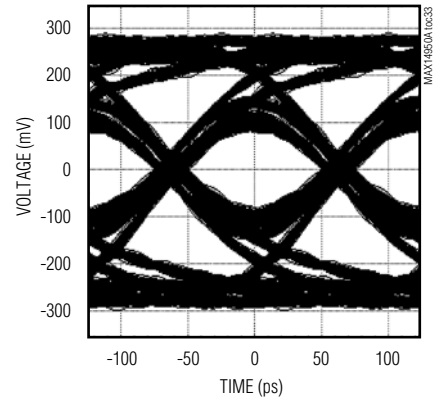

**DATA RATE = 8Gbps, OUTPUT AFTER  
19in STRIPLINE, INEQ\_0 = INEQ\_1 = 0,  
 $V_{IN} = 200mVp-p$ ,  
OEQ\_0 = 1, OEQ\_1 = 0, OEQ\_2 = 0**

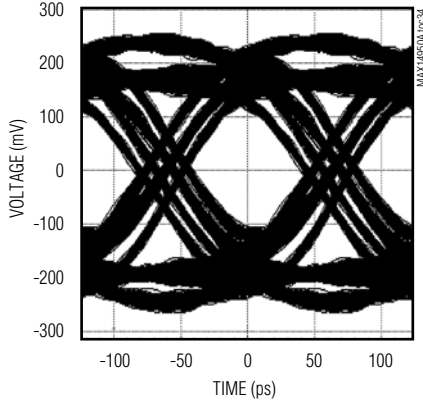

**DATA RATE = 8Gbps, OUTPUT AFTER  
19in STRIPLINE, INEQ\_0 = INEQ\_1 = 0,  
 $V_{IN} = 200mVp-p$ ,  
OEQ\_0 = 1, OEQ\_1 = 0, OEQ\_2 = 0**

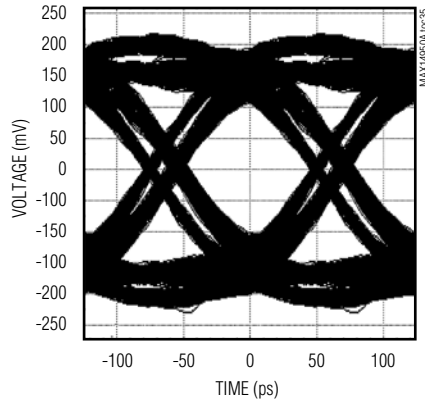

**DATA RATE = 8Gbps, OUTPUT AFTER  
19in STRIPLINE, INEQ\_0 = INEQ\_1 = 0,  
 $V_{IN} = 200mVp-p$ ,  
OEQ\_0 = 1, OEQ\_1 = 0, OEQ\_2 = 0**

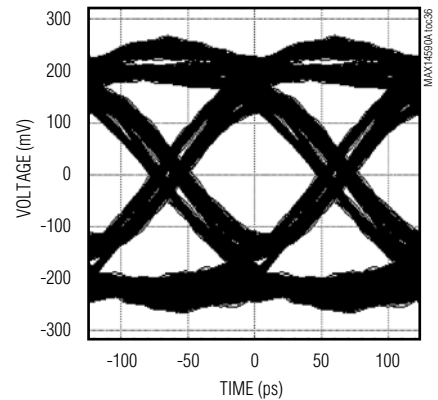

# MAX14950A

## Single-Lane PCIe Equalizer/Redriver

### Typical Operating Characteristics (continued)

( $V_{CC} = +3.3V$ ,  $T_A = +25^\circ C$ , unless otherwise noted.)

**DATA RATE = 8Gbps, OUTPUT AFTER  
19in STRIPLINE, INEQ\_0 = INEQ\_1 = 0,  
 $V_{IN} = 200mV_{p-p}$ ,  
OEQ\_0 = 1, OEQ\_1 = 0, OEQ\_2 = 0**

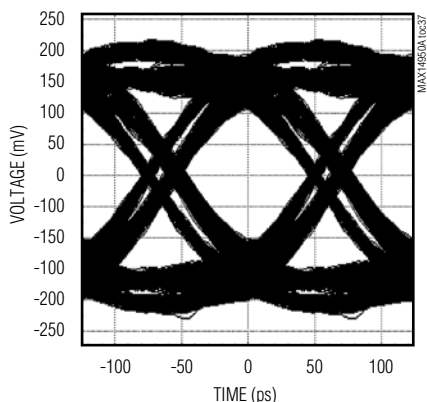

**DATA RATE = 8Gbps, OUTPUT AFTER  
19in STRIPLINE, INEQ\_0 = INEQ\_1 = 0,  
 $V_{IN} = 200mV_{p-p}$ ,  
OEQ\_0 = 1, OEQ\_1 = 0, OEQ\_2 = 0**

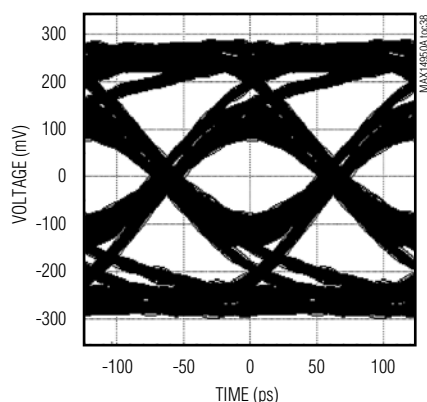

**DATA RATE = 8Gbps, OUTPUT AFTER  
19in STRIPLINE, INEQ\_0 = INEQ\_1 = 0,  
 $V_{IN} = 200mV_{p-p}$ ,  
OEQ\_0 = 1, OEQ\_1 = 0, OEQ\_2 = 0**

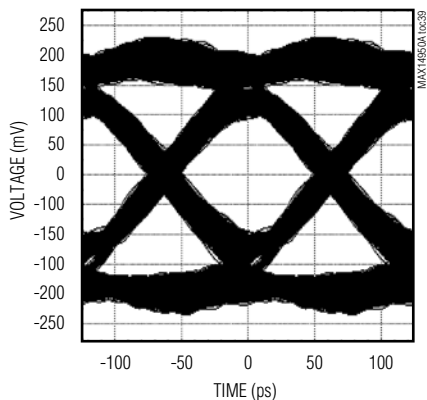

**DATA RATE = 8Gbps, OUTPUT AFTER  
19in STRIPLINE, INEQ\_0 = INEQ\_1 = 0,  
 $V_{IN} = 200mV_{p-p}$ ,  
OEQ\_0 = 1, OEQ\_1 = 0, OEQ\_2 = 0**

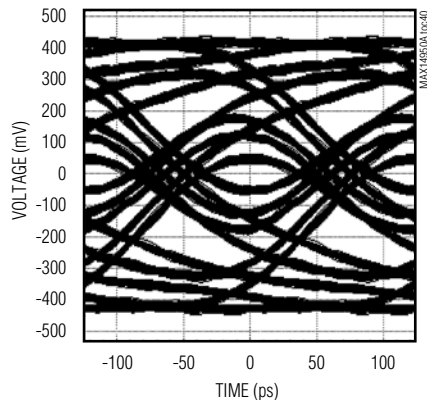

# MAX14950A

## Single-Lane PCIe Equalizer/Redriver

### Pin Configuration

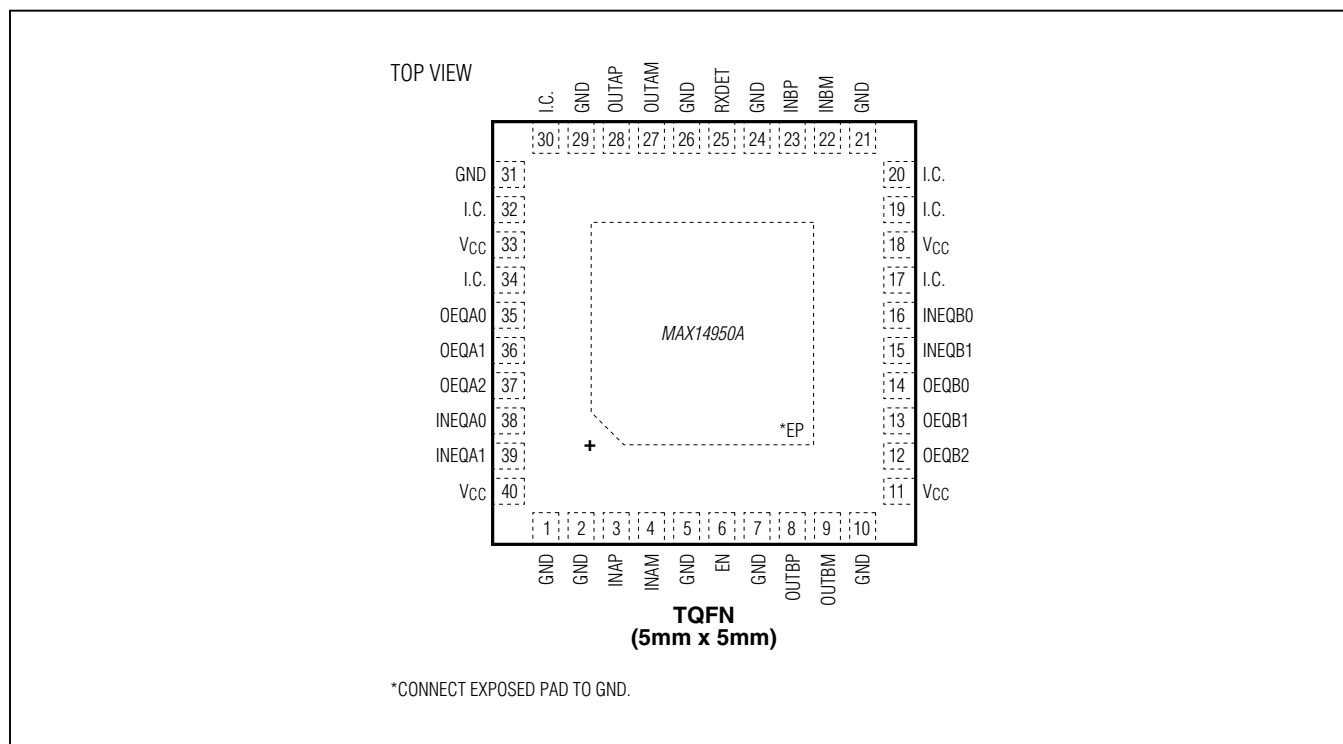

### Pin Description

PIN	NAME	FUNCTION
1, 2, 5, 7, 10, 21, 24, 26, 29, 31	GND	Ground
3	INAP	Noninverting Input, Channel A
4	INAM	Inverting Input, Channel A
6	EN	Enable Input. Drive EN low for standby mode. Drive EN high for normal mode. EN has a 375k $\Omega$ (typ) internal pulldown resistor.
8	OUTBP	Noninverting Output, Channel B
9	OUTBM	Inverting Output, Channel B
11, 18, 33, 40	V <sub>CC</sub>	Power-Supply Input. Bypass V <sub>CC</sub> to GND with 0.1 $\mu$ F and 0.01 $\mu$ F capacitors in parallel as close as possible to the device.

# MAX14950A

## Single-Lane PCIe Equalizer/Redriver

### Pin Description (continued)

PIN	NAME	FUNCTION
12	OEQB2	Output Deemphasis Control MSB, Channel B. OEQB2 has a 375k $\Omega$ (typ) internal pulldown resistor.
13	OEQB1	Output Deemphasis Bit 1, Channel B. OEQB1 has a 375k $\Omega$ (typ) internal pulldown resistor.
14	OEQB0	Output Deemphasis Control LSB, Channel B. OEQB0 has a 375k $\Omega$ (typ) internal pulldown resistor.
15	INEQB1	Input Equalization Control MSB, Channel B. INEQB1 has a 375k $\Omega$ (typ) internal pulldown resistor.
16	INEQB0	Input Equalization Control LSB, Channel B. INEQB0 has a 375k $\Omega$ (typ) internal pulldown resistor.
17, 19, 20, 30, 32, 34	I.C.	Internally connected. Leave I.C. unconnected.
22	INBM	Inverting Input, Channel B
23	INBP	Noninverting Input, Channel B
25	RXDET	Receiver Detection Control Bit. Toggle RXDET to initiate receiver detection. RXDET has a 375k $\Omega$ (typ) internal pulldown resistor.
27	OUTAM	Inverting Output, Channel A
28	OUTAP	Noninverting Output, Channel A
35	OEQA0	Output Deemphasis Control LSB, Channel A. OEQA0 has a 375k $\Omega$ (typ) internal pulldown resistor.
36	OEQA1	Output Deemphasis Control Bit 1, Channel A. OEQA1 has a 375k $\Omega$ (typ) internal pulldown resistor.
37	OEQA2	Output Deemphasis Control MSB, Channel A. OEQA2 has a 375k $\Omega$ (typ) internal pulldown resistor.
38	INEQA0	Input Equalization Control LSB, Channel A. INEQA0 has a 375k $\Omega$ (typ) internal pulldown resistor.
39	INEQA1	Input Equalization Control MSB, Channel A. INEQA1 has a 375k $\Omega$ (typ) internal pulldown resistor.
—	EP	Exposed Pad. Internally connected to GND. Connect EP to a large ground plane to maximize thermal performance and ground conductivity to the device. Do not use EP as the only GND connection.

# MAX14950A

## Single-Lane PCIe Equalizer/Redriver

### Functional Diagram

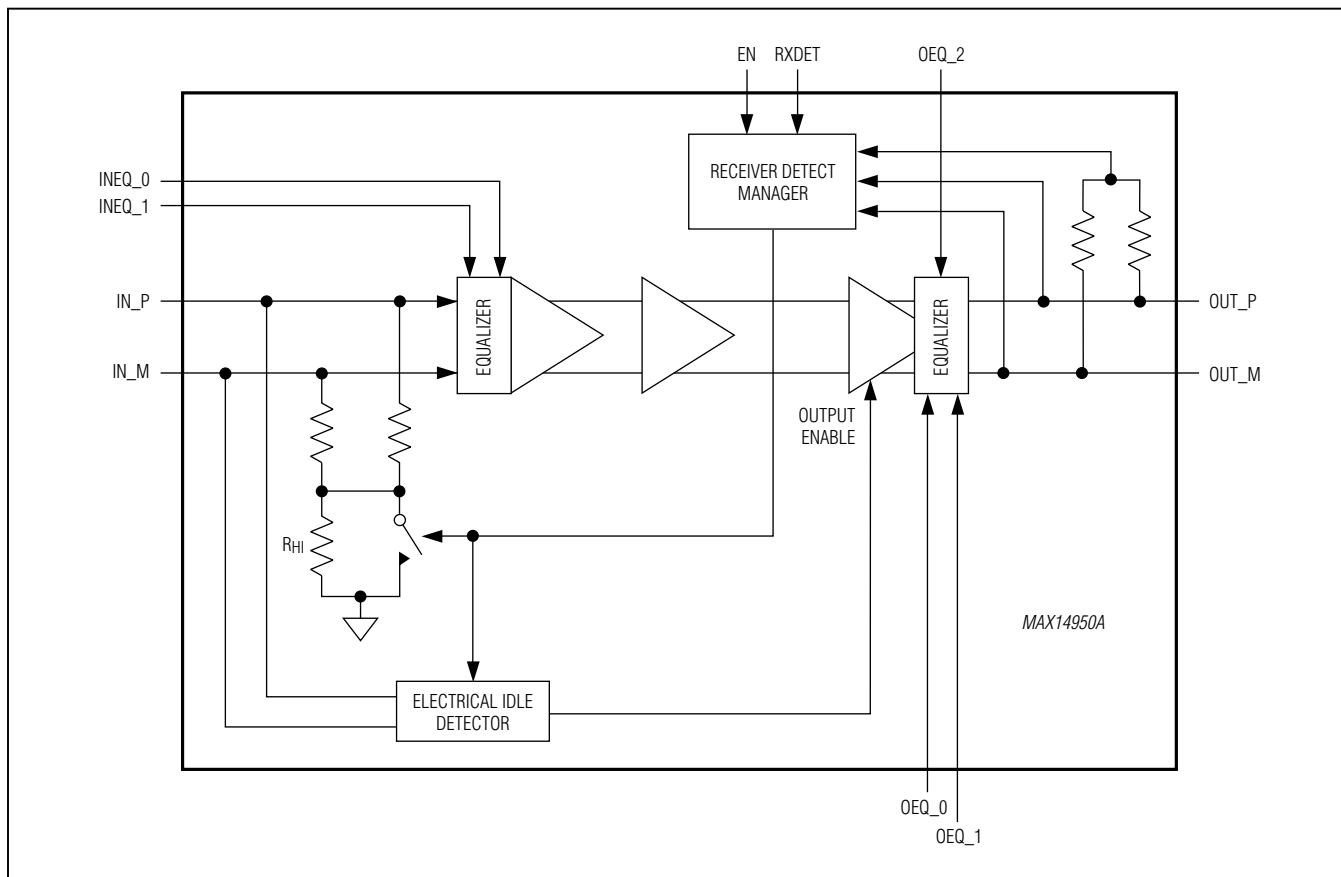

### Detailed Description

The MAX14950A dual equalizer/redriver supports Gen III (8GT/s), Gen II (5GT/s), and Gen I (2.5GT/s) PCIe data rates. The device contains two identical drivers with idle/receive detect on each lane and equalization/deemphasis/preshoot to compensate for circuit board loss. Programmable input equalization circuitry reduces deterministic jitter, improving signal integrity. The device features programmable output deemphasis/preshoot, permitting optimal placement of key PCIe components and longer runs of stripline, microstrip, or cable.

### Programmable Input Equalization

Programmable input equalization for channel A is controlled by two bits: INEQA1 and INEQA0 and for channel B is controlled by two bits: INEQB1 and INEQB0 ([Table 1.](#))

**Table 1. Input Equalization**

INEQ_1	INEQ_0	INPUT EQUALIZATION (dB)
0	0	5
0	1	8
1	0	12
1	1	16



# MAX14950A

## Single-Lane PCIe Equalizer/Redriver

### Programmable Output Deemphasis

Programmable output deemphasis/preshoot for channel A is controlled by the three bits: OEQA2, OEQA1, OEQA0 and channel B is controlled by the three bits: OEQB2, OEQB1, OEQB0 (Table 2.)

### Receiver Detection

The device features receiver detection on each channel. Upon initial power-up, if EN is high, receiver detection initializes. Receiver detection can also be initiated on a rising or falling edge of the RXDET input when EN is high. During this time, the part remains in low-power standby mode and the outputs are squelched, despite the logic-high state of EN. Until a channel has detected a receiver,

the receiver detection repeats indefinitely on each channel. If a channel detects a receiver, the other channel is limited to a few retries. Upon receiver detection, input common-mode termination and electrical idle detection are enabled (Table 3.)

### Electrical Idle Detection

The device features electrical idle detection to prevent unwanted noise from being redriven at the output. When the device detects the differential input has fallen below the electrical idle low threshold, it squelches the output. For differential input signals that are above the electrical idle high threshold, the device turns on the output and redrives the signal.

**Table 2. Output Deemphasis/Preshoot**

OEQ_2	OEQ_1	OEQ_0	OUTPUT DEEMPHASIS RATIO (dB)	PEAK-TO-PEAK SWING (V)	PRESHOOT
0	0	0	0	1.0	No
0	0	1	3.5	1.0	No
0	1	0	6	1.0	No
0	1	1	6	1.2	No
1	0	0	3.5	1.0	Yes
1	0	1	6	1.0	Yes
1	1	0	9	0.9	Yes
1	1	1	9	1.0	Yes

**Table 3. Receiver Detection Input Function**

RXDET	EN	DESCRIPTION
X	0	Receiver detection is inactive
X	1	Following a rising edge of EN signal, indefinite retry until a receiver is detected for at least one channel. Retries stop a few times after any channel is detected.
Rising/Falling Edge	1	Initiate receiver detection

X = Don't care.

# MAX14950A

## Single-Lane PCIe Equalizer/Redriver

### Applications Information

#### Layout

Circuit board layout and design can significantly affect the performance of the device. Use good high-frequency design techniques, including minimizing ground inductance and using controlled-impedance transmission lines on data signals. Power-supply decoupling capacitors must be placed as close as possible to  $V_{CC}$ . Always connect  $V_{CC}$  to a power plane. It is recommended to run receive and transmit on different layers to minimize crosstalk.

#### Exposed-Pad Package

The exposed-pad, 40-pin TQFN package incorporates features that provide a very low thermal resistance path for heat removal from the IC. The exposed pad on the device must be soldered to the circuit board ground plane for proper thermal performance. For more information on exposed-pad packages, refer to Maxim Application Note HFAN-08.1: *Thermal Considerations of QFN and Other Exposed-Paddle Packages*.

#### Power-Supply Sequencing

**Caution: Do not exceed the absolute maximum ratings because stresses beyond the listed ratings could cause permanent damage to the device.**

Proper power-supply sequencing is recommended for all devices. Always apply GND then  $V_{CC}$  before applying signals, especially if the signal is not current limited.

### Ordering Information

PART	TEMP RANGE	PIN-PACKAGE
MAX14950ACTL+	0°C to +70°C	40 TQFN-EP*

+Denotes a lead(Pb)-free/RoHS-compliant package.

\*EP = Exposed pad.

### Chip Information

PROCESS: BiCMOS

### Package Information

For the latest package outline information and land patterns (footprints), go to [www.maximintegrated.com/packages](http://www.maximintegrated.com/packages). Note that a "+", "#", or "-" in the package code indicates RoHS status only. Package drawings may show a different suffix character, but the drawing pertains to the package regardless of RoHS status.

PACKAGE TYPE	PACKAGE CODE	OUTLINE NO.	LAND PATTERN NO.
40 TQFN-EP	T4055+2	<a href="#">21-0140</a>	<a href="#">90-0002</a>

# MAX14950A

## Single-Lane PCIe Equalizer/Redriver

### Revision History

REVISION NUMBER	REVISION DATE	DESCRIPTION	PAGES CHANGED
0	6/11	Initial release	—
1	4/13	Updated <i>Benefits and Features</i> section, <i>Electrical Characteristics</i> table; replaced <i>Typical Operating Characteristics</i> 1–12 and 21–32, updated <i>Pin Configuration</i> and <i>Pin Description</i> . Updated Tables 1 and 2. Deleted Table 4.	1, 3, 4, 5, 7, 8, 10–12, 14–17



Maxim Integrated cannot assume responsibility for use of any circuitry other than circuitry entirely embodied in a Maxim Integrated product. No circuit patent licenses are implied. Maxim Integrated reserves the right to change the circuitry and specifications without notice at any time. The parametric values (min and max limits) shown in the *Electrical Characteristics* table are guaranteed. Other parametric values quoted in this data sheet are provided for guidance.

**Maxim Integrated 160 Rio Robles, San Jose, CA 95134 USA 1-408-601-1000**

19

**MAX14950A**

**Single-Lane PCIe Equalizer/Redriver**