



MAX17085B Evaluation Kit

General Description

The MAX17085B evaluation kit (EV kit) is a complete and fully assembled and tested PCB that features the MAX17085B IC, a highly integrated, multichemistry battery-charger controller with dual step-down converters and dual LDOs. The EV kit is capable of supplying power to a system load while simultaneously charging multichemistry battery packs. During operation, the EV kit circuit automatically selects the ADAPTER input or the battery as the main power source for supplying power to the system load and step-down converters. Whenever the EV kit circuit current limit is exceeded, the battery-charge current is reduced automatically, giving priority to the system load and converters.

The EV kit's input source-current limit, battery-charge voltage, maximum battery-charge current threshold, and output current limit on the step-down converters are configurable. These thresholds are adjusted by using on-board circuitry, or by connecting analog signals to the EV kit. Digital output signals indicate the presence of a valid ADAPTER and valid step-down converter voltages. An analog output signal indicates the total current drawn from either the adapter or the battery.

Features

- ◆ Analog Control Charge Current, Voltage, and Input Source Current
- ◆ Monitor Outputs
 - AC Adapter Current/Battery Discharge Current
 - AC Adapter Presence
 - Valid Step-Down Converter Output Voltages
- ◆ 5V, Up to 8A Step-Down Converter Outputs
- ◆ 3.3V, Up to 8A Step-Down Converter Outputs
- ◆ 5V, 3.3V Linear Regulator Outputs
- ◆ Automatic Power-Source Selection
- ◆ Up to 17.5V (4-Cell) Battery Voltage
- ◆ 8V to 22V Input Operation
- ◆ 4A Input Current Limit
- ◆ System Short-Circuit Protection
- ◆ Cycle-by-Cycle Current Limit
- ◆ Up to 1.4MHz Frequency Operation (Charger)
- ◆ Multichemistry Battery Charger
- ◆ Fully Assembled and Tested

Ordering Information

PART	TYPE
MAX17085BEVKIT+	EV Kit

+Denotes lead(Pb)-free and RoHS compliant.

Component List

DESIGNATION	QTY	DESCRIPTION
ADAPTER, BATT_IN, PGND (x5), SYSLD, VOUT3, VOUT5	10	Noninsulated banana-jack connectors
C1	0	Not installed, ceramic capacitor (0805)
C2	1	1.0 μ F \pm 10%, 50V X7R ceramic capacitor (0805) Murata GRM21BR71H105K
C3, C11, C25, C26	4	0.01 μ F \pm 10%, 50V X7R ceramic capacitors (0603) Murata GRM188R71H103K

DESIGNATION	QTY	DESCRIPTION
C4, C9	0	Not installed, ceramic capacitors (1206)
C5, C12, C14, C22, C27, C28	6	0.1 μ F \pm 10%, 50V X7R ceramic capacitors (0603) Murata GRM188R71H104K
C6, C7, C8	3	4.7 μ F \pm 20%, 25V X7R ceramic capacitors (1206) Murata GRM31CR71E475M
C10, C17, C21, C29	4	1.0 μ F \pm 10%, 10V X5R ceramic capacitors (0603) Murata GRM188R61A105K
C13, C19, C23, C24	4	10 μ F \pm 10%, 25V X5R ceramic capacitors (1206) Murata GRM31CR61E106K



MAX17085B Evaluation Kit

Evaluates: MAX17085B

Component List (continued)

DESIGNATION	QTY	DESCRIPTION
C15, C20	2	100 μ F, 6V, 18m Ω capacitors (D case) SANYO 6TPE100MI
C16, C18	2	4.7 μ F \pm 10%, 6.3V X5R ceramic capacitors (0603) Murata GRM188R60J475K
C30, C31	0	Not installed, ceramic capacitors (0603)
C32	1	1000pF \pm 20%, 50V X7R ceramic capacitor (0603) Murata GRM188R71H102M
D1, D2	2	3A, 40V Schottky diodes (SMA) Central Semi CSMH3-40MA
D3, D4	2	Green LEDs (0603)
D5, D6	2	200mA, 100V dual diodes (SOT23) Fairchild MMBD4148SE (Top Mark: D4)
D7	1	350mA, 40V Schottky diode (SOD123) Diodes Inc. SD103AW (Top Mark: S4)
D8	1	100mA, 80V diode (SOD323) Diodes Inc. 1N4148WS-7-F
JU1, JU2, JU3, JU6	4	2-pin headers
JU4, JU5	2	3-pin headers
L1	1	2.0 μ H, 4.5A inductor Sumida CDR7D28MN-2R0
L2, L3	2	1.5 μ H, 11.8A inductors Sumida CEP125NP-1R5MC
N1, N2	2	30V, 8.3A n-channel MOSFETs (8 SO) International Rectifier IRF7807D1PBF
N3	1	30V, 8.5A n-channel MOSFET (8 SO) Fairchild FDS8884
N4	1	30V, 10A n-channel MOSFET with Schottky (8 SO) Fairchild FDS6690AS

DESIGNATION	QTY	DESCRIPTION
N5, N7	2	30V, 13A n-channel MOSFETs (8 SO) Fairchild FDS6298
N6, N8	2	30V, 13A n-channel MOSFETs (8 SO) Fairchild FDS6670A
N9, N10	2	60V, 115mA n-channel MOSFETs (SOT23) Fairchild 2N7002
P1	1	30V, 8.8A p-channel MOSFET (8 SO) Fairchild FDS4435BZ
R1	1	249k Ω \pm 1% resistor (0603)
R2	1	36.5k Ω \pm 1% resistor (0603)
R3	1	0.015 Ω \pm 1%, 1W sense resistor (2010) IRC LRC-LRF2010LF-01-R015-F
R4	1	0.01 Ω \pm 1%, 1W sense resistor (2010) IRC LRC-LRF2010LF-01-R010-F
R5	1	150k Ω \pm 5% resistor (0603)
R6, R7, R26	3	1k Ω \pm 5% resistors (0603)
R8, R36	2	0 Ω \pm 5% resistors (0603)
R9	1	200k Ω potentiometer (single turn) Murata PVG3A204C01R00
R10, R17, R18, R25, R28, R29, R30	0	Not installed, resistors (0603) R10, R28, R29, and R30 are short; R17, R18, and R25 are open
R11, R15	2	66.5k Ω \pm 1% resistors (0603)
R12, R16	2	82.5k Ω \pm 1% resistors (0603)
R13	1	301k Ω \pm 1% resistor (0603)
R14	1	47 Ω \pm 5% resistor (0603)
R19, R20, R23, R32	4	100k Ω \pm 1% resistors (0603)
R21, R22	2	4.7 Ω \pm 5% resistors (0603)
R24	1	21k Ω \pm 1% resistor (0603)
R27	1	10k Ω \pm 1% resistor (0603)
R31	1	78.7k Ω \pm 1% resistor (0603)
R33, R34	2	10 Ω \pm 1% resistors (0603)

MAX17085B Evaluation Kit

Component List (continued)

DESIGNATION	QTY	DESCRIPTION
R35	1	4.99Ω ±1% resistor (0603)
TP1–TP5	5	Miniature test points
U1	1	Integrated battery charger (40 TQFN-EP*) Maxim MAX17085BETL+

DESIGNATION	QTY	DESCRIPTION
U2	1	Single OR gate (5 SOT23) Fairchild NC7S32M5X (Top Mark: 7S32)
—	6	Shunts (JU1–JU6)
—	1	PCB: MAX17085B EVALUATION KIT+

*EP = Exposed pad.

Component Suppliers

SUPPLIER	PHONE	WEBSITE
Central Semiconductor Corp.	631-435-1110	www.centrasemi.com
Diodes Incorporated	805-446-4800	www.diodes.com
Fairchild Semiconductor	888-522-5372	www.fairchildsemi.com
International Rectifier	310-322-3331	www.irf.com
IRC, Inc.	361-992-7900	www.irctt.com
Murata Electronics North America, Inc.	770-436-1300	www.murata-northamerica.com
SANYO Electric Co., Ltd.	619-661-6835	www.sanyo.com
Sumida Corp.	847-545-6700	www.sumida.com

Note: Indicate you are using the MAX17085B when contacting these component suppliers.

Quick Start

Recommended Equipment

- MAX17085B EV kit
- 8V to 22V, 5A variable power supply
- Nine voltmeters

Procedure

The EV kit is a fully assembled and tested surface-mount board. Follow the steps below to verify board operation.

Caution: Do not turn on the power supply until all connections are completed.

- 1) Verify that a shunt is not installed across jumper JU1 (ISET voltage is set by potentiometer R9).
- 2) Verify that a shunt is installed across jumper JU2 (OUT5 enabled).
- 3) Verify that a shunt is installed across jumper JU3 (OUT3 enabled).
- 4) Verify that a shunt is installed across pins 2-3 of jumper JU4 (BATT voltage set to 13.1V [3 cell x 4.375V]).
- 5) Verify that a shunt is installed on only one pin (forced-PWM mode).
- 6) Verify that a shunt is installed across jumper JU6 (relearn disable).
- 7) Connect a voltmeter across the following EV kit PCB pads:
 - BATT_IN and PGND
 - SYSLD and PGND
 - VOUT3 and PGND
 - VOUT5 and PGND
 - LDO3 and PGND
 - LDO5 and PGND
 - VAUX and PGND
 - IINP and PGND
 - PWM and PGND
- 8) Connect the power supply across the ADAPTER and PGND banana jacks.
- 9) Turn on the power supply.

Evaluates: MAX17085B

MAX17085B Evaluation Kit

- 10) Set the power-supply voltage to 20V.
- 11) Adjust potentiometer R9 until the PWM voltmeter measures 425mV. This sets the charge current to 2A.
- 12) Verify the following :

PARAMETER	MEASURE OUTPUT (V)
BATT_IN	13.1
SYSLD	20
VOUT3	3.3
VOUT5	5
LDO5	5
LDO3	3.3
IINP	0

- 13) Verify that green LEDs D3 (\overline{ACOK} signal) and D4 (PGOOD signal) are on.
- 14) The EV kit is now ready for additional testing.

Detailed Description of Hardware

The MAX17085B EV kit is a complete and fully assembled and tested PCB that demonstrates the highly integrated MAX17085B controller of multichemistry battery charger, two step-down converters, and two LDOs. The EV kit circuit is capable of supplying power to a system load (SYSLD) and two converters connected to the SYSLD output, while simultaneously charging the battery pack. The EV kit circuit also integrates a third step-down, DC-DC converter to implement a precision constant-current/constant-voltage battery charger.

During operation, the EV kit circuit selects the ADAPTER or the BATT_IN input as the main power source for SYSLD. Once the main power source is selected, the EV kit circuit monitors the input source current. This input source current is defined as the combined SYSLD current, OUT3 and OUT5 converter input currents, and battery-charge current when the ADAPTER input is the main power source, or as the battery-discharge current when the battery is the main power source. When the input source current exceeds the EV kit input current-limit threshold, the battery-charge current is reduced to give priority to the system load.

The EV kit features on-board circuitry that allows the user to adjust and set battery-charge voltage and maximum battery-charge current. The EV kit also features a PWM PCB pad that is used to connect an analog input signal or a PWM signal that configures maximum battery-charge current up to 3.5A. The BATT battery-charge voltage threshold can be configured up to 17.5V by adjusting the voltage at the VCTL and CELLS input pins.

The EV kit features PCB output pads to access the 5V/100mA and the 3.3V/50mA LDOs integrated in the IC. The low-current LDOs are available for external use. The EV kit's \overline{ACOK} digital output signal indicates the presence of a valid input source, such as an AC adapter. The PGOOD digital output signal indicates that the OUT3 and OUT5 converter outputs (3.3V and 5V, respectively) are within specification. The IINP analog output signal is a scaled voltage of the total current drawn from the ADAPTER input or the battery.

Input Source

The EV kit requires a 5A power source with an 8V to 22V output voltage range connected to the ADAPTER banana-jack connector, or a power source with an 8V to 19V output voltage range connected to the BATT_IN banana-jack connector for normal operation. In a typical application, the battery pack is connected to BATT_IN and a DC supply, such as an AC adapter, to the ADAPTER banana-jack connectors. When the ADAPTER voltage is higher than 7.2V and the DCIN pin is greater than $V_{BATT} + 500\text{mV}$, the ADAPTER is selected as the main power source. The battery at BATT_IN is charged when the adapter is selected as the main power source and the system load current is less than the input current limit.

Input Current Limit

The EV kit input source-current limit is set to 4A with sense resistor R3 (15m Ω). The input current is the sum of the system load current, input current to the OUT3 and OUT5 step-down converters, and battery-charge current when the ADAPTER input is the main power source, or is the battery-discharge current when the battery at BATT_IN is the main power source. When the input current exceeds the input current limit, the charging current is reduced to provide priority to the SYSLD load current. As the SYSLD current approaches the limit threshold, the charge current drops linearly to zero.

The maximum input source-current limit can be reconfigured by replacing sense resistor R3. Use the following equation to select a new sense resistor value:

$$R3 = \frac{60\text{mV}}{I_{LIMIT}}$$

where I_{LIMIT} is the new maximum input source-current limit and R3 is the value of the sense resistor.

Refer to the *Setting Input Current Limit* section in the MAX17085B IC data sheet for further details.

MAX17085B Evaluation Kit

Battery Charging Charge Voltage

The EV kit battery-charge voltage can be configured for up to 17.5V by configuring the per-cell voltage at the VCTL pin. The EV kit per-cell voltage is configured to 4.375V by default with shorting resistor R10, which connects the VCTL pin to REF (2.1V). However, the per-cell voltage can be set by setting the VCTL voltage between 0 and 2.1V and multiplying that voltage by 2.083. Cut open the PC trace at resistor R10 and install resistors R10 and R18 to reset the VCTL pin voltage. Use the following equations to calculate new resistor values and configure the per-cell voltage:

$$V_{CELL} = VCTL \times 2.083$$

$$R10 = \left(\frac{REF}{VCTL} - 1 \right) R18$$

where V_{CELL} is the per-cell voltage, $VCTL$ is the pin voltage, REF is 2.1V, and $R18$ is typically 100k Ω .

The resistor values should not overload the REF linear regulator. The VCTL voltage must be set between 0 and 2.1V. **Note:** The cell battery-termination voltage is a function of the battery chemistry and construction. Consult the battery manufacturer to determine this voltage.

The total BATT battery-charge voltage can be calculated with the following equation:

$$V_{BATT} = N_{CELLS} \times VCTL \times 2.083$$

where V_{BATT} is the battery-charge voltage and N_{CELLS} is the multiplying cell factor (2, 3, or 4) selected. See Table 1 to select the multiplying factor and jumper JU4 configuration.

Table 1. Mode Configuration (JU4)

SHUNT POSITION	CELLS PIN	BATT VOLTAGE SETTING
1-2	Connected to LDO5	4 x VCTL x 2.083
Open	Not connected	2 x VCTL x 2.083
2-3	Connected to GND	3 x VCTL x 2.083

Charge Current

The EV kit maximum battery-charge current can be set up to 3.5A by using potentiometer R9 to vary the ISET voltage between 0 and 2.1V. Set the ISET voltage below 26mV, or install a shunt across jumper JU1, to shut down the charger. See Table 2 for jumper JU1 configuration. The actual battery-charge current depends on the input source-current limit and the system load current. When the system load current exceeds the input source-current limit, the charging current is reduced to provide priority to the SYSLD load current. As the SYSLD current increases to 4A, the charge current drops linearly to zero.

Use the following equation to calculate the required voltage at the ISET pin to set a new maximum charge current. The maximum charge current of 3.5A is achieved when the ISET voltage reaches 740mV:

$$V_{ISET} = \frac{R4 \times REF \times I_{CHG}}{100mV}$$

where V_{ISET} is the voltage at the ISET pin, REF is 2.1V, I_{CHG} is the charge current, and $R4$ is the value of the sense resistor (10m Ω).

The maximum charge current can be reconfigured by replacing sense resistor $R4$. Use the following equation to select a new sense resistor value:

$$R4 = \frac{100mV}{I_{CHG}}$$

where I_{CHG} is the new maximum charge current and $R4$ is the value of the new sense resistor.

The maximum 3.5A charge current can also be set by removing the shunt across jumper JU1 and connecting a PWM input signal to the PWM PCB pad. The PWM signal should have a 100Hz to 500kHz frequency range and a duty cycle of 0 to 100%. Refer to the *Setting Charge Current (ISET)* section in the MAX17085B IC data sheet for more details.

MAX17085B Evaluation Kit

IINP Output Signal

The EV kit features an analog output (IINP) to allow current monitoring through sense resistor R3. The measured current is either the input adapter current (SYSLD current, charge current, and input current for OUT3 and OUT5 converters) or the battery discharge current. Use an ADC to measure the voltage at the IINP PCB pad. The voltage at the IINP output can be calculated with the following equation:

$$V_{IINP} = I_{INPUT} \times R3 \times 2.8 \frac{\mu A}{mV}$$

where V_{IINP} is the voltage at the IINP output pad, I_{INPUT} is the ADAPTER input current or the battery-discharge current, and R3 is the value of the sense resistor (15m Ω).

The IINP output can be enabled or disabled by configuring jumper JU1. Battery charging is also disabled when IINP is disabled. See Table 2 for jumper JU1 configuration.

VOUT3 and VOUT5 Step-Down Converters

The MAX17085B IC also integrates two step-down converters (VOUT5 and VOUT3) with the outputs set internally to 5V and 3.3V, respectively. The VOUT5 DC output-current limit is set to 8A (typ) with resistors R11 and R12. The VOUT3 DC output-current limit is set to 8A (typ) with resistors R15 and R16. Use the following equations to select new resistor values to reconfigure the current limit for each step-down converter output:

$$ILIM5 = \frac{R12 \times REF}{(R11 + R12) \times 20 \times N8_{RDS(ON)}}$$

$$ILIM3 = \frac{R16 \times REF}{(R15 + R16) \times 20 \times N6_{RDS(ON)}}$$

where $ILIM5$ is the current-limit valley for the OUT5 converter and $ILIM3$ is the current-limit valley for the OUT3 converter, REF equals 2.1V, $N8_{RDS(ON)}$ is the static drain-to-source on-resistance for MOSFET N8, $N6_{RDS(ON)}$ is the static drain-to-source on-resistance for MOSFET N6, R11 and R12 are the voltage-divider resistors for the OUT5 converter, and R15 and R16 are the voltage-divider resistors for the OUT3 converter.

The IC includes two input pins to independently enable and disable the VOUT5 and VOUT3 step-down converters. The EV kit features jumpers JU2 and JU3 to configure control input pins for VOUT5 and VOUT3, respectively. See Tables 3 and 4 for jumpers JU2 and JU3 configuration.

Switching Frequency

The IC's switching frequency is set to 542kHz with resistor R13 (301k Ω). Replace resistor R13 with a new resistor value to reconfigure the switching frequency between 300kHz and 800kHz.

Use the following equation to choose the appropriate R13 resistor value to reconfigure the switching frequency (f_{sw}):

$$R13 = \frac{1}{f_{sw} \times 6pF} - 6.5k\Omega$$

Table 2. ISET Configuration (JU1)

SHUNT POSITION	ISET PIN	EV KIT FUNCTION
Open	Not connected	Set maximum current with potentiometer R27 or PWM signal
Installed	Connected to GND	Charger and IINP output are disabled

Table 3. ON5 Configuration (JU2)

SHUNT POSITION	ON5 PIN	OUT5 OUTPUT
Installed	Connected to LDO5	Enabled
Open	Connected to GND through resistor R20	Disabled

Table 4. ON3 Configuration (JU3)

SHUNT POSITION	ON3 PIN	OUT3 OUTPUT
Installed	Connected to LDO5	Enabled
Open	Connected to GND through resistor R19	Disabled

MAX17085B Evaluation Kit

Evaluates: MAX17085B

Switching Mode

The IC's switching mode can be configured to one of three modes: pulse skipping, forced PWM, or ultrasonic. The EV kit circuit provides jumper JU5 to configure the switching mode. See Table 5 for jumper JU5 configuration. Refer to the *Modes of Operation* section in the MAX17085B IC data sheet for details on the three switching modes.

LDO3, LDO5 Linear Regulators and VAUX Output

The IC integrates two low-dropout linear regulators: LDO3 and LDO5. The EV kit circuit provides access to these linear regulators with PCB pads. The LDO3 output provides 50mA at 3.3V and the LDO5 output provides 100mA at 5V. The linear regulators can be used to power external circuitry.

The EV kit also includes circuitry that uses the VOUT5 output and the DL5 gate-driver output to generate an unregulated 12V to 15V, 30mA output at the VAUX output pad (shunt installed on pins 1-2 of jumper JU5).

ACOK and PGOOD Output Logic Signals

The EV kit features the ACOK output-logic signal that indicates whether a valid DC source is connected to the ADAPTER banana-jack connector. The ACOK signal is pulled low and green LED D3 is turned on when the voltage at the ADAPTER input is greater than 16.5V; otherwise, ACOK is pulled high to 5V and LED D3 is turned off.

Table 5. Switching Mode Configuration (JU5)

SHUNT POSITION	SKIP PIN	SWITCHING MODE
1-2	Connected to LDO5	Pulse skipping
Open	Not connected	Determined by feedback
2-3	Connected to GND	Ultrasonic

The EV kit's PGOOD output-logic signal indicates whether the VOUT3 and VOUT5 outputs are within the specified limits. The PGOOD signal is pulled high to 5V and the green LED (D4) is turned on when the VOUT3 and VOUT5 voltages are above $VOUT_{-} - 250mV$ and below $VOUT_{+} \times 1.16$; otherwise, PGOOD is pulled low and LED D3 is turned off.

Relearn Mode

Relearn mode is implemented on the EV kit by configuring jumper JU6. To enable relearn mode, remove the shunt on JU6. In relearn mode, the IC's PDSL gate-drive adapter-selector MOSFET (N2) is disabled, thus enabling the battery-selector MOSFET (P1). The battery applied at the BATT_IN and PGND PCB pads services the loads applied at SYSLD, VOUT5, and VOUT3.

The EV kit also monitors the battery-discharge voltage during relearn, when the ADAPTER power source is not present. When the battery reaches its critical discharge-voltage threshold, the system attempts to reenables the ADAPTER selection MOSFET (N1) if the proper voltage is applied at the ADAPTER input.

Note: Before activating relearn mode, battery charging should be disabled (shunt installed at jumper JU1).

To disable relearn mode, install a shunt on jumper JU6. See Table 6 for jumper JU6 configuration.

An external signal can also be applied at the RELEARN PCB pad to enable/disable the EV kit relearn feature.

Table 6. Relearn Mode Configuration (JU6)

SHUNT POSITION	EV KIT FUNCTION
Not installed	Relearn mode enabled
Installed	Relearn mode disabled

MAX17085B Evaluation Kit

Evaluates: MAX17085B

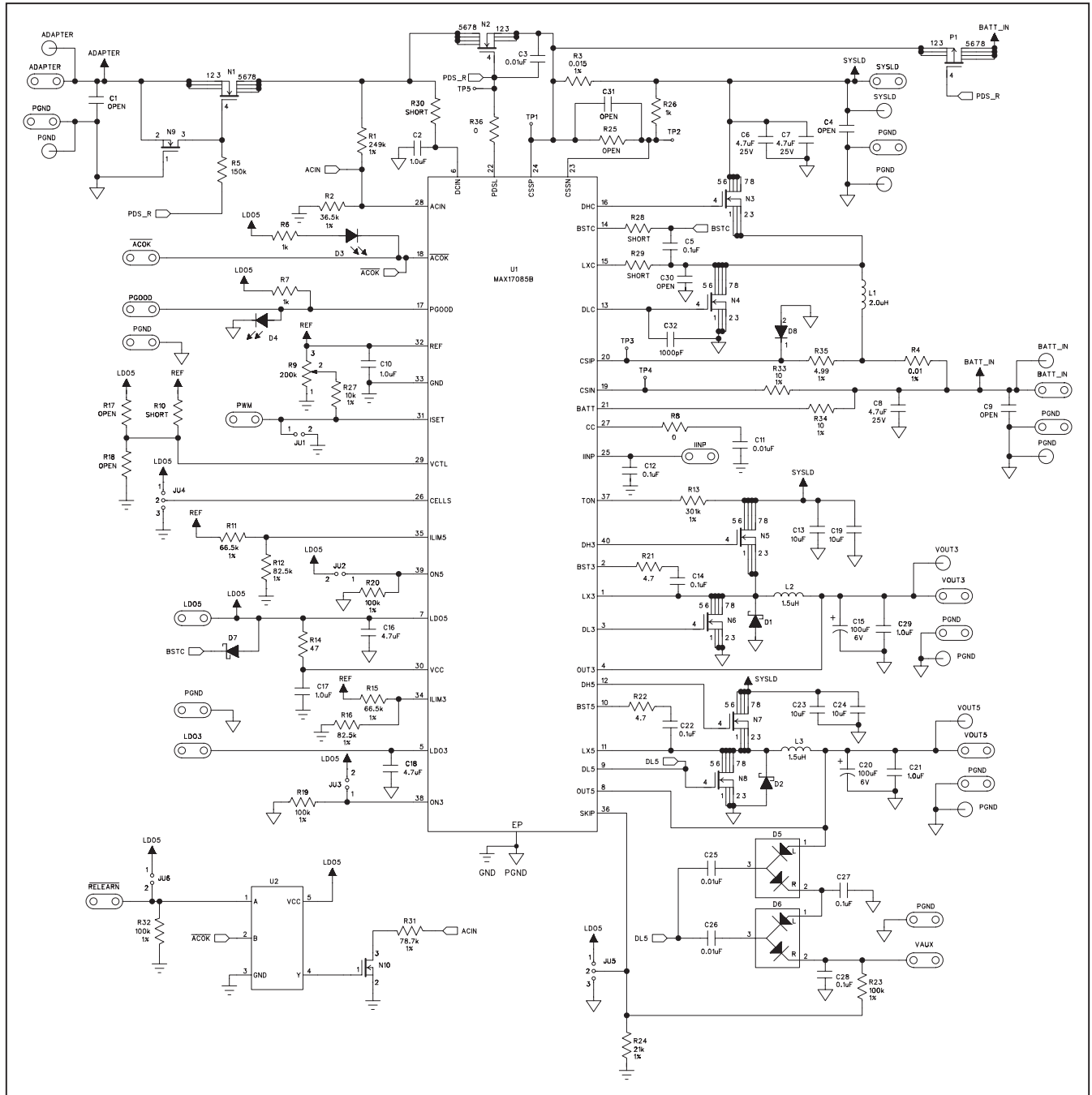

Figure 1. MAX17085B EV Kit Schematic

MAX17085B Evaluation Kit

Evaluates: MAX17085B

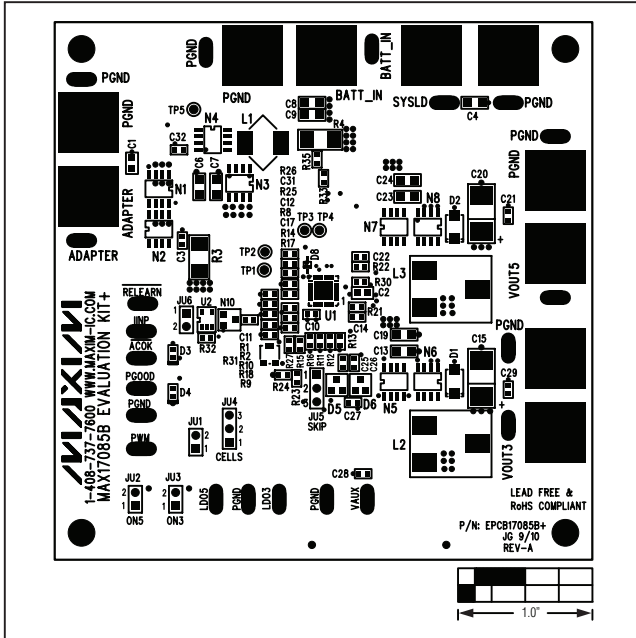

Figure 2. MAX17085B EV Kit Component Placement Guide—Component Side

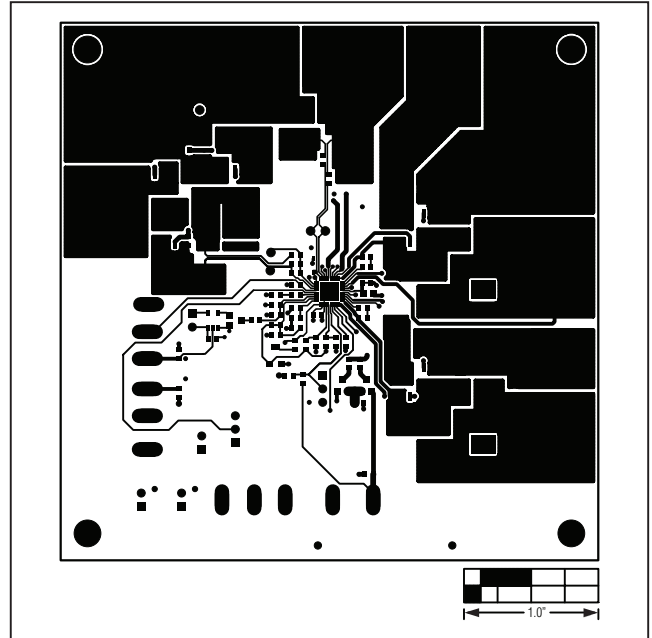

Figure 3. MAX17085B EV Kit PCB Layout—Component Side

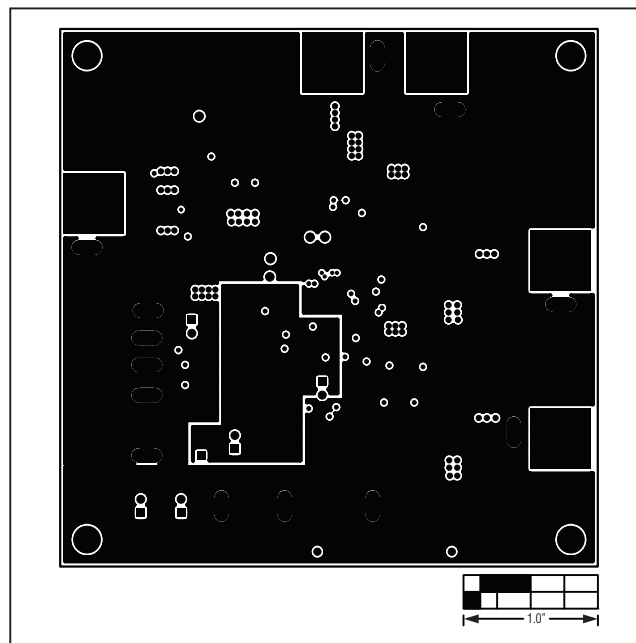

Figure 4. MAX17085B EV Kit PCB Layout—Ground Planes (Layer 2)

MAX17085B Evaluation Kit

Evaluates: MAX17085B

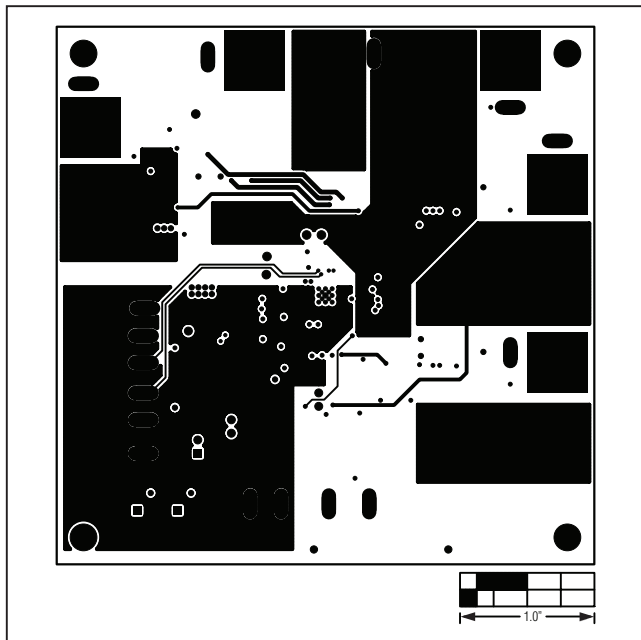

Figure 5. MAX17085B EV Kit PCB Layout—Power Planes (Layer 3)

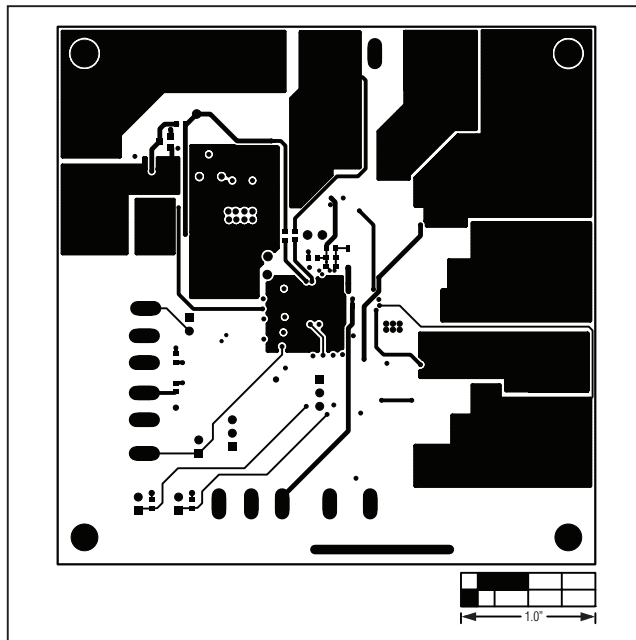

Figure 6. MAX17085B EV Kit PCB Layout—Solder Side

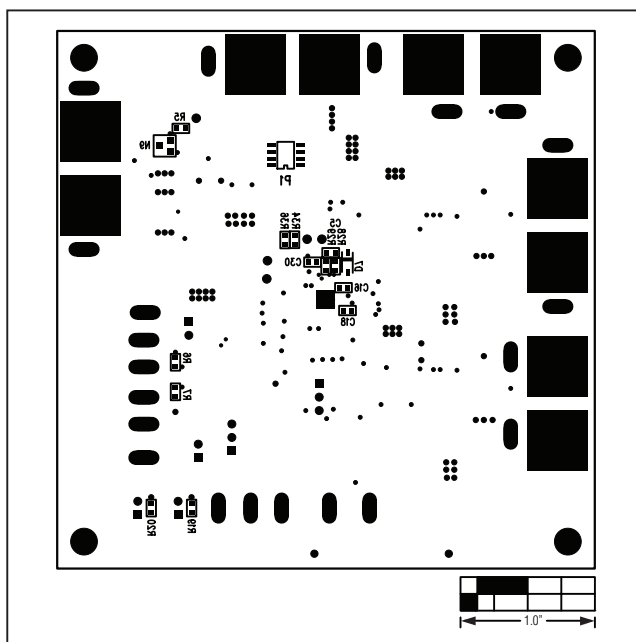

Figure 7. MAX17085B EV Kit Component Placement Guide—Solder Side

MAX17085B Evaluation Kit

Revision History

REVISION NUMBER	REVISION DATE	DESCRIPTION	PAGES CHANGED
0	10/10	Initial release	—

Evaluates: MAX17085B

Maxim cannot assume responsibility for use of any circuitry other than circuitry entirely embodied in a Maxim product. No circuit patent licenses are implied. Maxim reserves the right to change the circuitry and specifications without notice at any time.

Maxim Integrated Products, 120 San Gabriel Drive, Sunnyvale, CA 94086 408-737-7600 _____ 11