

# High-Accuracy, Adjustable Power Limiter

# MAX17525

## General Description

The Olympus series of ICs are the industry's smallest and robust integrated system protection solutions. The MAX17525 adjustable overvoltage, undervoltage, and overcurrent protection device guards systems against overcurrent faults in addition to positive overvoltage and reverse-voltage faults. When used with an optional external pMOSFET, the device also protects downstream circuitry from voltage faults up to +60V, -60V (for  $-(60V + V_{OUT})$  external pFET rating). The device features a low, 31mΩ, on-resistance integrated FET.

During startup, the MAX17525 is designed to charge large capacitances on the output in a continuous mode for applications where large reservoir capacitors are used on the inputs to downstream devices. Two additional part options that feature a dual-stage, current-limit mode in which the current is continuously limited to 1.5x and 2x the programmed limit are available upon request. These options enable faster charging of large load capacitances during startup.

The MAX17525 also features reverse-current and overtemperature protection. The device is available in a 20-pin (5mm x 5mm) TQFN package and operate over the -40°C to 125°C temperature range.

## Applications

- Industrial Power Systems
- Control and Automation
- Motion System Drives
- Human Machine Interfaces
- High-Power Applications

## Benefits and Features

- Robust, High-Power Protection Reduces System Downtime
  - Wide Input-Supply Range: +5.5V to +60V
  - Programmable Input-Supply Overvoltage Setting Up To 40V
  - -60V Negative Input Tolerance with External pFET (for  $-(60 + V_{OUT})$  External pFET Rating)
  - Low 31mΩ (typ)  $R_{ON}$
  - Reverse Current-Blocking Protection with External pFET
- Enables Fast Startup and Brownout Recovery
  - Thermal Foldback Current-Limit Protection
  - 1.5x, 2x Startup Current Limit Options
- Flexible Design Enables Reuse and Less Requalification
  - Adjustable OVLO and UVLO Thresholds
  - Programmable Forward Current Limit From 0.6A to 6A with  $\pm 15\%$  Accuracy Over Full Temperature Range
  - Normal and High-Voltage Enable Inputs (EN and HVEN)
  - Protected External pFET Gate Drive
- Saves Board Space and Reduces External BOM Count
  - 20-Pin 5mm x 5mm TQFN Package
  - Integrated nFET

[Ordering Information](#) appears at end of data sheet.

## Typical Application Circuit

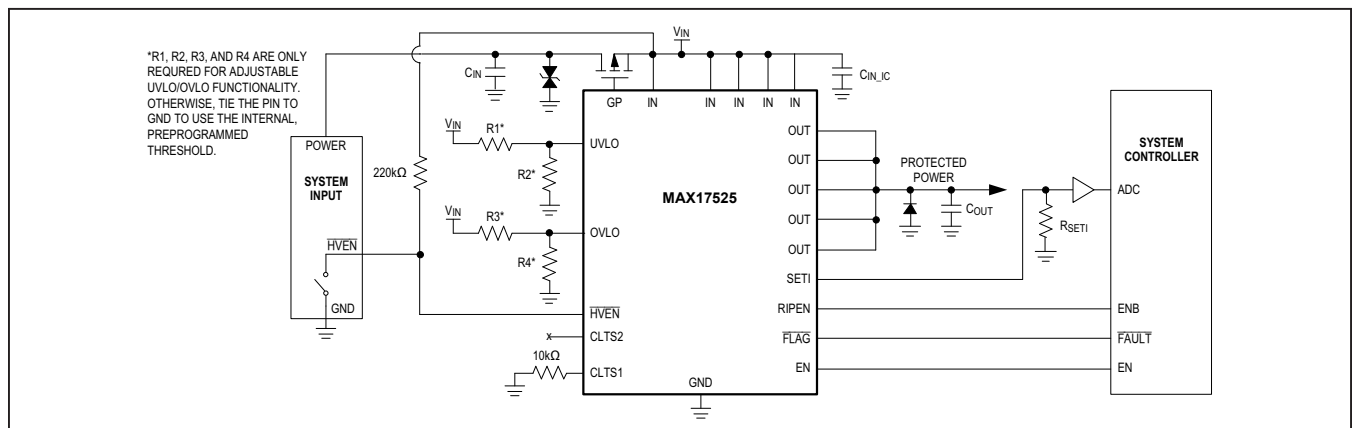

19-8572; Rev 4; 3/22

### Absolute Maximum Ratings

(All voltages referenced to GND.)

IN (Note 1)	-0.3V to +62V
OUT	-0.3V to $V_{IN} + 0.3V$
HVEN (Note 1)	-0.3V to $V_{IN} + 0.3V$
GP	max (-0.3V, $V_{IN} - 20V$ ) to $V_{IN} + 0.3V$
UVLO, OVLO	-0.3V to min ( $V_{IN} + 0.3V$ , 20V)
FLAG, EN, RIPEN, CLTS1, CLTS2	-0.3V to +6V
Maximum Current Into IN (DC) (Note 2)	6.9A

SETI	-0.3V to min ( $V_{IN} + 0.3V$ , 6V)
Continuous Power Dissipation ( $T_A = +70^\circ C$ )	
TQFN (derate 34.5mW/°C above +70°C)	2758mW
Operating Temperature Range	-40°C to +125°C
Junction Temperature	+150°C
Storage Temperature Range	-65°C to +150°C
Lead Temperature (soldering, 10s)	+300°C
Soldering Temperature (reflow)	+260°C

Stresses beyond those listed under "Absolute Maximum Ratings" may cause permanent damage to the device. These are stress ratings only, and functional operation of the device at these or any other conditions beyond those indicated in the operational sections of the specifications is not implied. Exposure to absolute maximum rating conditions for extended periods may affect device reliability.

**Note 1:** An external pFET or diode is required to achieve negative input protection.

**Note 2:** DC current-limited by  $R_{SETI}$ , as well as by thermal design.

### Package Information

<b>PACKAGE TYPE: 20 TQFN</b>	
Package Code	T2055+5C
Outline Number	<a href="#">21-0140</a>
Land Pattern Number	<a href="#">90-0010</a>
<b>THERMAL RESISTANCE, FOUR-LAYER BOARD</b>	
Junction to Ambient ( $\theta_{JA}$ )	29°C/W
Junction to Case ( $\theta_{JC}$ )	2°C/W

For the latest package outline information and land patterns (footprints), go to [www.maximintegrated.com/packages](http://www.maximintegrated.com/packages). Note that a "+", "#", or "-" in the package code indicates RoHS status only. Package drawings may show a different suffix character, but the drawing pertains to the package regardless of RoHS status.

Package thermal resistances were obtained using the method described in JEDEC specification JESD51-7, using a four-layer board. For detailed information on package thermal considerations, refer to [www.maximintegrated.com/thermal-tutorial](http://www.maximintegrated.com/thermal-tutorial).

## Electrical Characteristics

( $V_{IN} = 5.5V$  to  $60V$ ,  $T_A = -40^\circ C$  to  $+125^\circ C$ , unless otherwise noted. Typical values are at  $V_{IN} = 12V$ ,  $T_A = +25^\circ C$ ) (Note 3)

PARAMETER	SYMBOL	CONDITIONS	MIN	TYP	MAX	UNITS
<b>POWER SUPPLY</b>						
IN Voltage Range	$V_{IN}$		5.5		60	V
Shutdown IN Current	$I_{SHDN}$	$V_{EN} = 0V, V_{HVEN} = 5V, V_{IN} < 40V$		4	15	$\mu A$
		$V_{EN} = 0V, V_{HVEN} = 5V$		4	150	
Supply Current	$I_{IN}$	$V_{IN} = V_{OUT} = 24V, V_{HVEN} = 0V$		1.4	2.16	mA
Shutdown OUT Current	$I_{OFF}$	$V_{EN} = 0V, V_{HVEN} = 5V$		50	100	$\mu A$
<b>UVLO, OVLO</b>						
Internal UVLO Trip Level	$V_{UVLO\_INT}$	$V_{IN}$ falling, UVLO trip point	11.5	12	12.5	V
		$V_{IN}$ rising	11.9	12.4	13.1	
UVLO Hysteresis		% of typical UVLO		3		%
Internal OVLO Trip Level	$V_{OVLO\_INT}$	$V_{IN}$ falling	34.5	35.5	36.6	V
		$V_{IN}$ rising, OVLO trip point	34.7	36.2	37.6	
External UVLO Adjustment Range (Note 4)			5.5		24	V
External UVLO Select Voltage	$V_{UVLO\_SEL}$		0.15	0.38	0.5	V
External UVLO Leakage Current	$I_{UVLO\_LEAK}$		-250		+250	nA
External UVLO Set Voltage	$V_{SET\_UVLO}$	Falling, UVLO trip point	1.18	1.22	1.27	V
		Rising	1.22	1.25	1.29	
External OVLO Adjustment Range (Note 4)			6		40	V
External OVLO Select Voltage	$V_{OVLO\_SEL}$		0.15	0.38	0.5	V
External OVLO Set Voltage	$V_{SET\_OVLO}$	Falling	1.15	1.19	1.23	V
		Rising, OVLO trip point	1.18	1.22	1.27	
External OVLO Leakage Current	$I_{OVLO\_LEAK}$		-250		+250	nA
Undervoltage Trip Level on OUT	$V_{UVLO\_OUT}$	$V_{OUT}$ falling, UVLO trip point	11.5	12	12.5	V
		$V_{OUT}$ rising	11.9	12.4	13	
<b>GP</b>						
Gate Clamp Voltage	$V_{GP}$		10	16.1	20	V
Gate Active Pullup				11	22	$\Omega$
Gate Active Pulldown		$V_{EN} = 5V$	47	110		$\mu A$
Shutdown Gate Active Pullup		$V_{EN} = 0V, V_{HVEN} = 5V$		2.4		M $\Omega$
<b>INTERNAL FETs</b>						
Internal FETs On-Resistance	$R_{ON}$	$I_{LOAD} = 100mA, V_{IN} \geq 10V, T_A = +25^\circ C$		31	44	m $\Omega$
Current Limit Adjustment Range	$I_{LIM}$		0.6		6	A
Current Limit Accuracy	$I_{LIM\_ACC}$	$1A \leq I_{LIM} \leq 6A (T_A = +25^\circ C)$	-10		+10	%
		$0.6A \leq I_{LIM} \leq 6A$	-15		+15	

## Electrical Characteristics (continued)

(V<sub>IN</sub> = 5.5V to 60V, T<sub>A</sub> = -40°C to +125°C, unless otherwise noted. Typical values are at V<sub>IN</sub> = 12V, T<sub>A</sub> = +25°C) (Note 3)

PARAMETER	SYMBOL	CONDITIONS	MIN	TYP	MAX	UNITS
FLAG Assertion Drop Voltage Threshold	V <sub>FA</sub>	Increase in (V <sub>IN</sub> - V <sub>OUT</sub> ) drop until FLAG asserts, V <sub>IN</sub> = 24V		490		mV
Slow Reverse Current-Blocking Threshold	V <sub>RIB_SLOW</sub>	V <sub>IN</sub> - V <sub>OUT</sub>	-0.5	-5.4	-10.5	mV
Slow Reverse Current-Blocking Response Time	t <sub>RIB_SLOW</sub>	See the <i>Slow Reverse-Current Fault Timing Diagram</i>		17	30	μs
Fast Reverse Current-Blocking Threshold	V <sub>RIB_FAST</sub>	V <sub>IN</sub> - V <sub>OUT</sub>	-85	-100	-115	mV
Fast Reverse Current-Blocking Response Time	t <sub>RIB_FAST</sub>	(V <sub>IN</sub> - V <sub>OUT</sub> ) changes from 0.2V to -0.3V in 100nsec, t <sub>RIB</sub> is the interval between V <sub>IN</sub> - V <sub>OUT</sub> = V <sub>RIB_FAST</sub> and V <sub>IN-GP</sub> = 0.5V with C <sub>IN-GP</sub> = 5nF		0.7	1	μs
Reverse-Blocking Supply Current	I <sub>RBS</sub>	V <sub>OUT</sub> = 24V		3280	5110	μA
<b>LOGIC INPUT (HVEN, CLTS1, CLTS2, EN, RIPEN)</b>						
HVEN Threshold Voltage	V <sub>HVEN_TH</sub>		1	2	3.1	V
HVEN Threshold Hysteresis				5		%
HVEN Input Leakage Current	I <sub>HVEN_LEAK</sub>	V <sub>HVEN</sub> = 60V		51	72	μA
EN, RIPEN, CLTS1, CLTS2 Input Logic-High	V <sub>IH</sub>		1.4			V
EN, RIPEN, CLTS1, CLTS2 Input Logic-Low	V <sub>IL</sub>				0.4	V
EN Input Leakage Current	I <sub>EN_LEAK</sub>	V <sub>EN</sub> = 0V, 5V	-1		+1	μA
CLTS_ Leakage Current		CLTS_ = GND		25		μA
RIPEN Leakage Current	I <sub>RIPEN_LEAK</sub>	RIPEN = GND		25		μA
<b>LOGIC OUTPUT (FLAG)</b>						
Logic-Low Voltage		I <sub>SINK</sub> = 1mA			0.4	V
Input Leakage Current		V <sub>IN</sub> = 5.5V, FLAG deasserted			1	μA
<b>SETI</b>						
R <sub>SETI</sub> × I <sub>LIM</sub>	V <sub>RI</sub>	See the <i>Setting the Current-Limit Threshold</i> section		1.5		V
Current Mirror Output Ratio	C <sub>RATIO</sub>	See the <i>Setting the Current-Limit Threshold</i> section		25000		

### Electrical Characteristics (continued)

( $V_{IN} = 5.5V$  to  $60V$ ,  $T_A = -40^{\circ}C$  to  $+125^{\circ}C$ , unless otherwise noted. Typical values are at  $V_{IN} = 12V$ ,  $T_A = +25^{\circ}C$ ) (Note 3)

PARAMETER	SYMBOL	CONDITIONS	MIN	TYP	MAX	UNITS
<b>DYNAMIC PERFORMANCE (NOTE 5)</b>						
Switch Turn-On Time	$t_{ON}$	$V_{IN} = 24V$ , switch OFF to ON, $R_{LOAD} = 240\Omega$ , $I_{LIM} = 1A$ , $C_{OUT} = 4.7\mu F$ , $V_{OUT}$ from 20% to 80% of $V_{IN}$		68		$\mu s$
Fault Recovery nFET Turn-On Time	$t_{ON\_NFET}$	Turn-on delay after fault timers expired		200	500	$\mu s$
Fault Recovery pFET Turn-on Time	$t_{ON\_PFET}$	$V_{OUT} > V_{UVLO\_OUT}$ , turn-on delay of pFET after fault timers expired	1.08	1.2	1.32	ms
Reverse-Current Fault Recovery Time	$t_{REV\_REC}$		0.4	0.45	0.5	ms
OVP Switch Response Time	$t_{OVP\_RES}$			3		$\mu s$
Overcurrent Switch Response time	$t_{OCP\_RES}$	$I_{LIM} = 4A$		3		$\mu s$
Startup Timeout	$t_{STO}$	Initial start current-limit foldback timeout (Figure 1)	1090	1200	1320	ms
Startup Initial Time	$t_{STI}$	Current is continuously limited to 1x/1.5x/2x in this interval (Figure 1)	21.8	24	26.4	ms
IN Debounce Time	$t_{DEB}$	Additional turn-on delay if $V_{OUT} < V_{UVLO\_OUT}$ , see the <i>Timing Diagrams</i>	1.09	1.2	1.32	ms
Blanking Time	$t_{BLANK}$	(Figures 3 and 4)	21.8	24	26.4	ms
Autoretry Time	$t_{RETRY}$	(Figure 3, Note 6)	554	720	792	ms
<b>THERMAL PROTECTION</b>						
Thermal Foldback	$T_{J\_FB}$			150		$^{\circ}C$
Thermal Shutdown	$T_{J\_MAX}$			170		$^{\circ}C$
Thermal-Shutdown Hysteresis				20		$^{\circ}C$

**Note 3:** All devices are 100% production-tested at  $T_A = +25^{\circ}C$ . Specifications over the operating temperature range are guaranteed by design.

**Note 4:** Not production-tested, user-adjustable. See the *Overvoltage Lockout (OVLO)* and *Undervoltage Lockout (UVLO)* sections.

**Note 5:** All timing is measured using 20% and 80% levels, unless otherwise specified.

**Note 6:** The autoretry time-to-blanking time ratio is fixed and is equal to 30.

Timing Diagrams

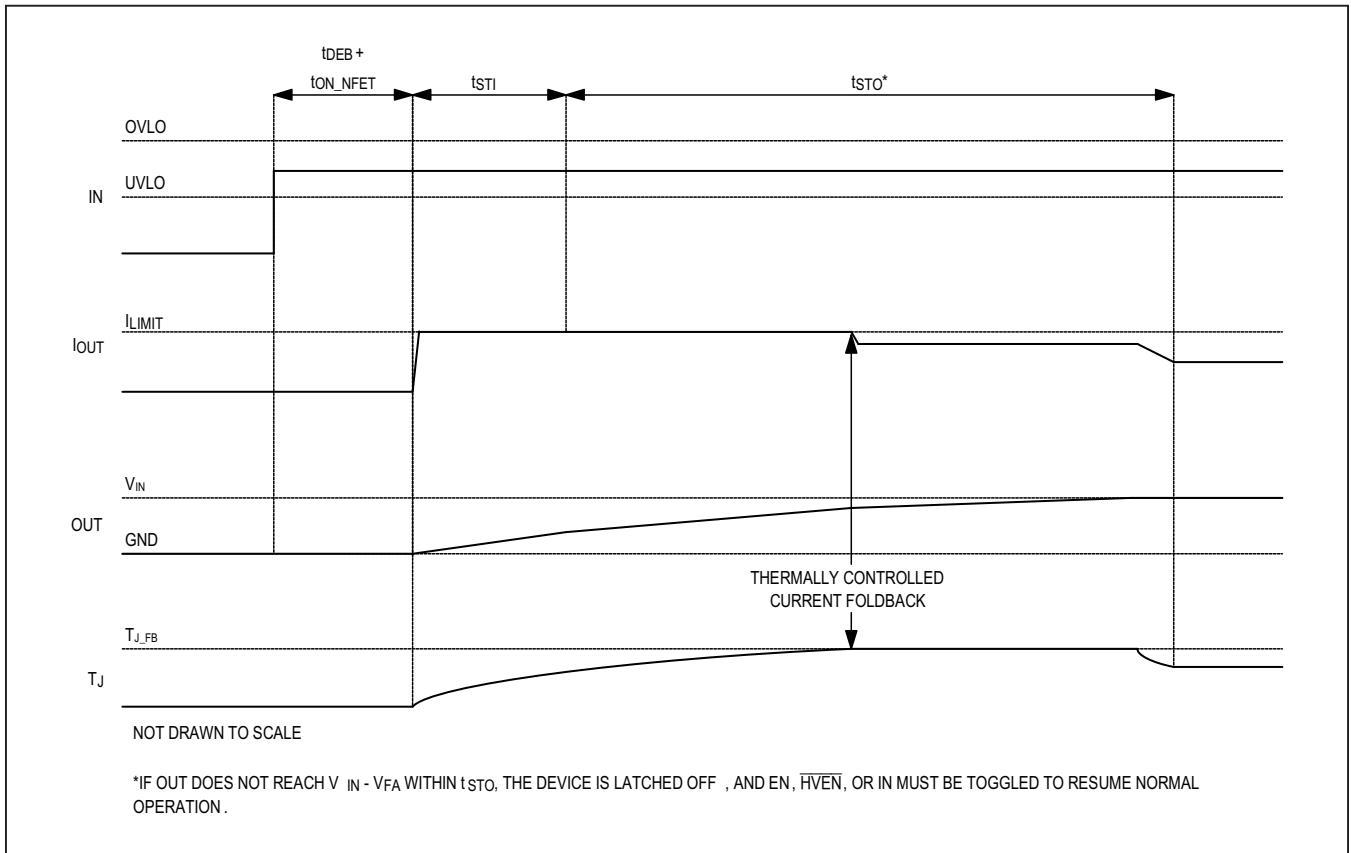

Figure 1. Startup Timing

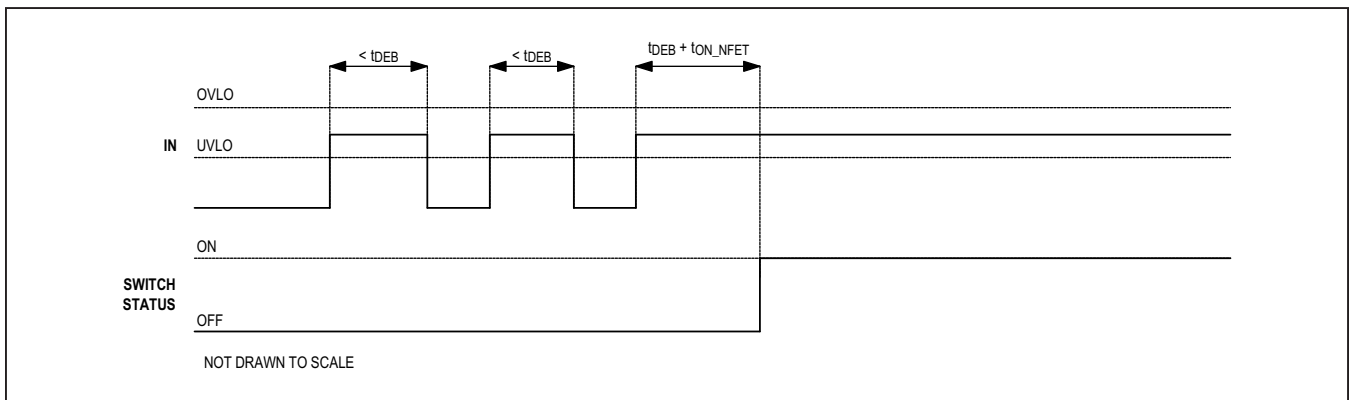
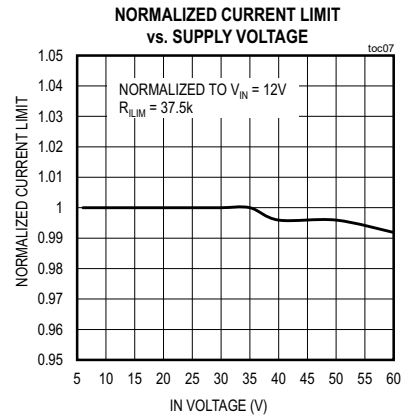
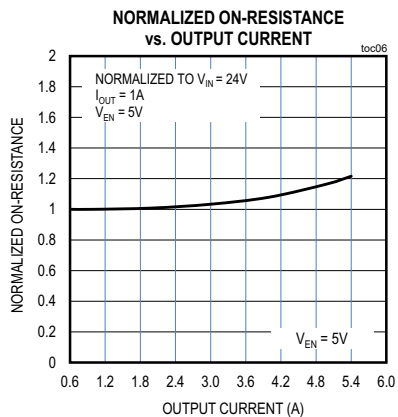
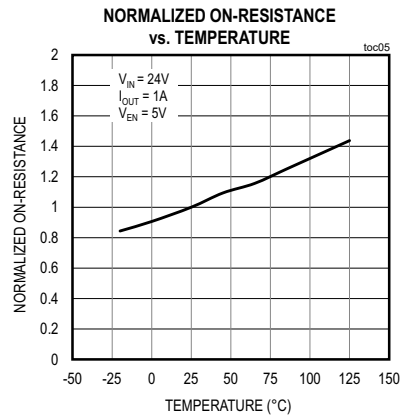
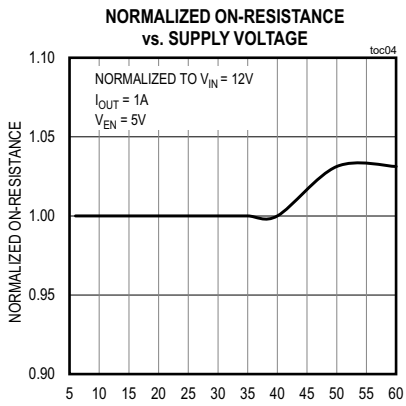
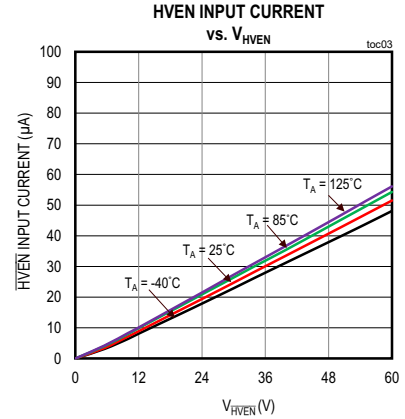
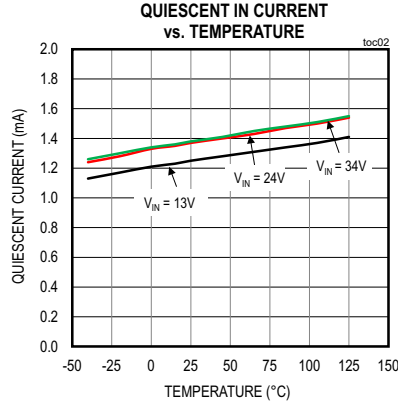
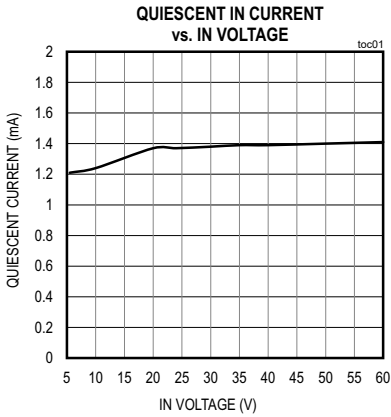

Figure 2. Debounce Timing

Typical Operating Characteristics

( $V_{IN} = 12V$ ,  $C_{IN} = 1\mu F$ ,  $C_{OUT} = 4.7\mu F$ ,  $T_A = +25^\circ C$ , unless otherwise noted.)



Typical Operating Characteristics (continued)

( $V_{IN} = 12V$ ,  $C_{IN} = 1\mu F$ ,  $C_{OUT} = 4.7\mu F$ ,  $T_A = +25^\circ C$ , unless otherwise noted.)

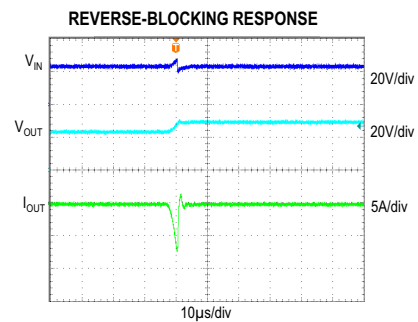
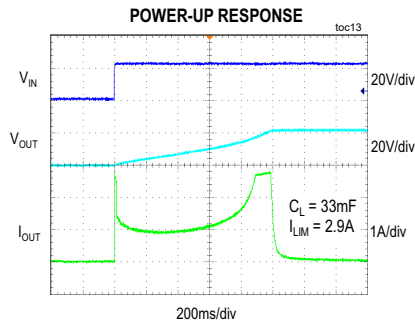
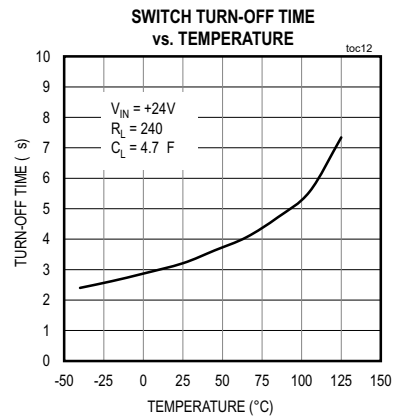
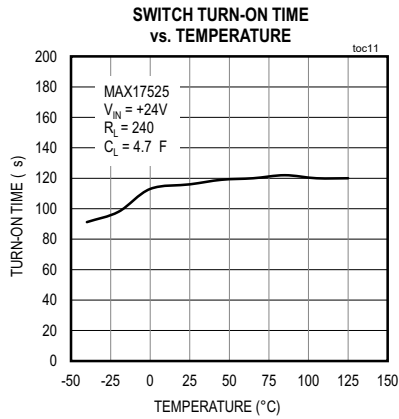
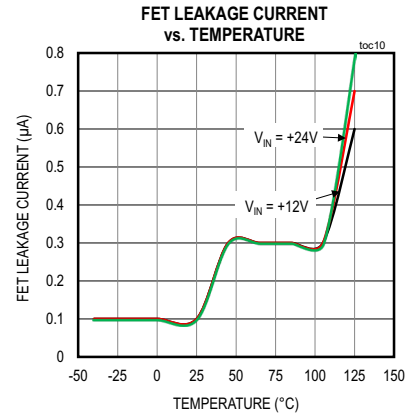
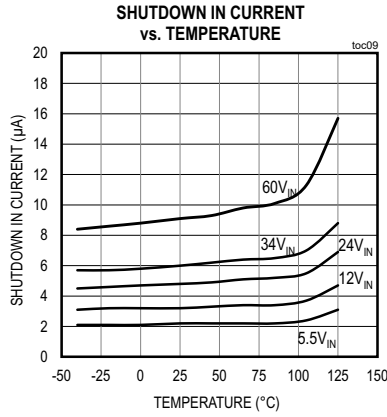
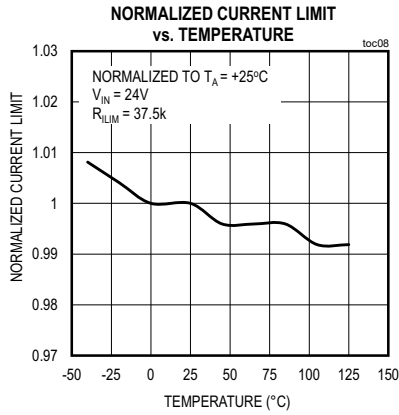



Typical Operating Characteristics

( $V_{IN} = 12V$ ,  $C_{IN} = 1\mu F$ ,  $C_{OUT} = 4.7\mu F$ ,  $T_A = +25^\circ C$ , unless otherwise noted.)

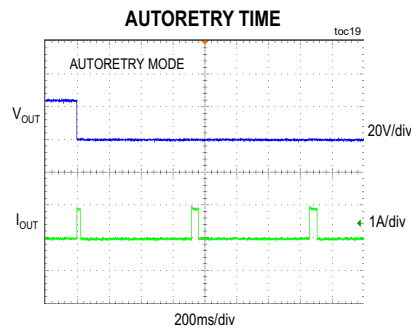
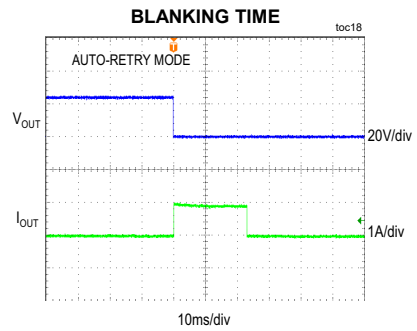
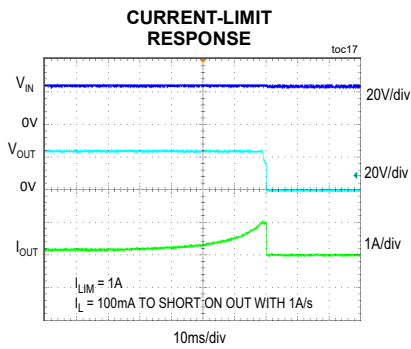
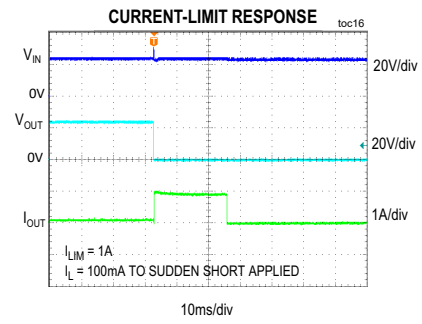
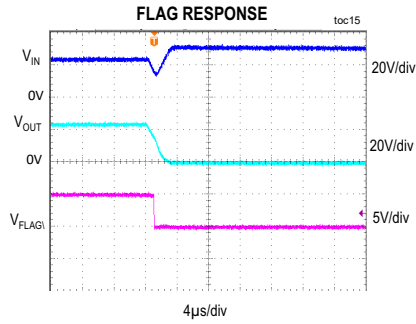

Pin Configurations

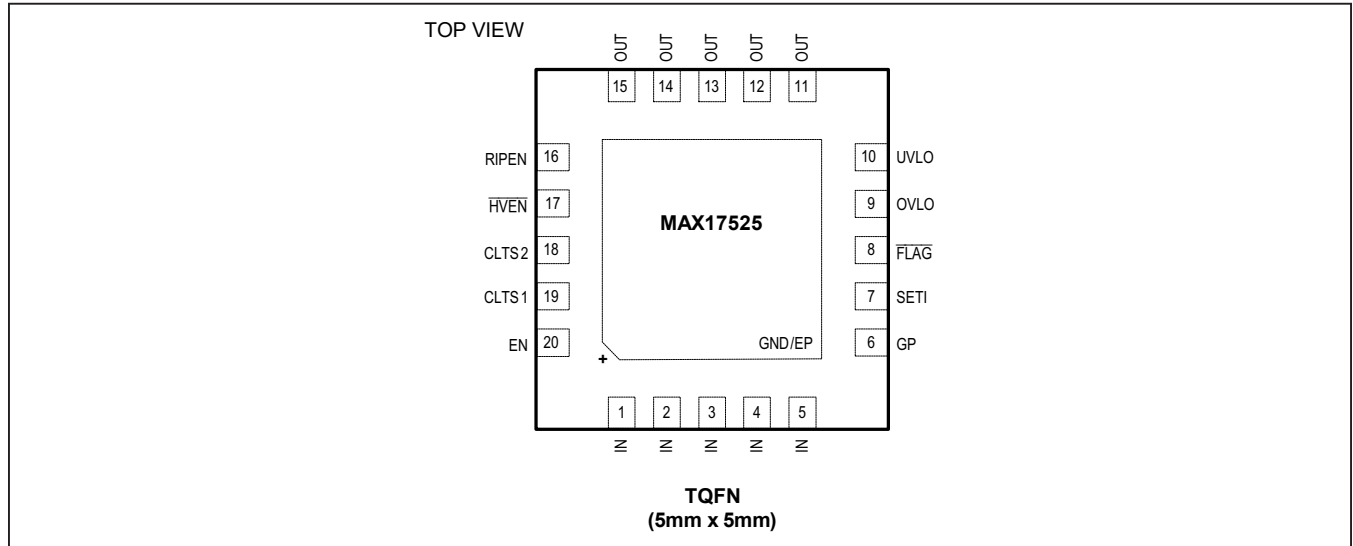

Pin Description

PIN	NAME	FUNCTION
1–5	IN	Switch Input. Bypass IN to ground with a 1µF ceramic capacitor. In applications in which an external pFET is used, a 4.7µF capacitor should be placed at the drain of the pFET and a reduced capacitor of 10nF to 100nF should be placed at IN. The maximum slew rate allowed at IN is 30V/µs. IN serves as the undervoltage/overvoltage sensed input when preprogrammed UVLO/OVLO is used.
6	GP	Gate Driver Output for External pFET.
7	SETI	Overload Current-Limit Adjust. Connect a resistor from SETI to GND to program the overcurrent limit. SETI must be connected to a resistor. If SETI is connected to GND during startup, then the switch does not turn on. Do not connect more than 30pF to SETI.
8	FLAG	Open-Drain Fault Indicator Output. FLAG asserts low when the $V_{IN} - V_{OUT}$ voltage exceeds $V_{FA}$ , reverse current is detected, thermal shutdown mode is active, OVLO or UVLO threshold is reached, or SETI is connected to GND.
9	OVLO	Externally-Programmable Overvoltage-Lockout Threshold. Connect OVLO to GND to use the default internal OVLO threshold. Connect OVLO to an external resistor-divider to define a threshold externally and override the preset internal OVLO threshold.
10	UVLO	Externally Programmable Undervoltage-Lockout Threshold. Connect UVLO to GND to use the default internal UVLO threshold. Connect UVLO to an external resistor-divider to define a threshold externally and override the preset internal UVLO threshold.
11–15	OUT	Switch Output. Bypass OUT to GND with a 4.7µF ceramic capacitor placed as close as possible to the device.
16	RIPEN	Reverse-Current Protection Enable. Connect RIPEN to GND with 10kΩ pulldown resistor to disable the reverse-current flow protection. Leave RIPEN open or connect RIPEN to logic-high to activate the reverse-current flow protection.
17	HVEN	60V Capable Active-Low Enable Input. See Table 1.
18	CLTS2	Current-Limit Type Select 2. See Table 2.
19	CLTS1	Current-Limit Type Select 1. See Table 2.
20	EN	Active-High Enable Input. See Table 1.
—	GND/EP	Ground/Exposed Pad. Connect to a large copper ground plane to maximize thermal performance.

Functional Diagram

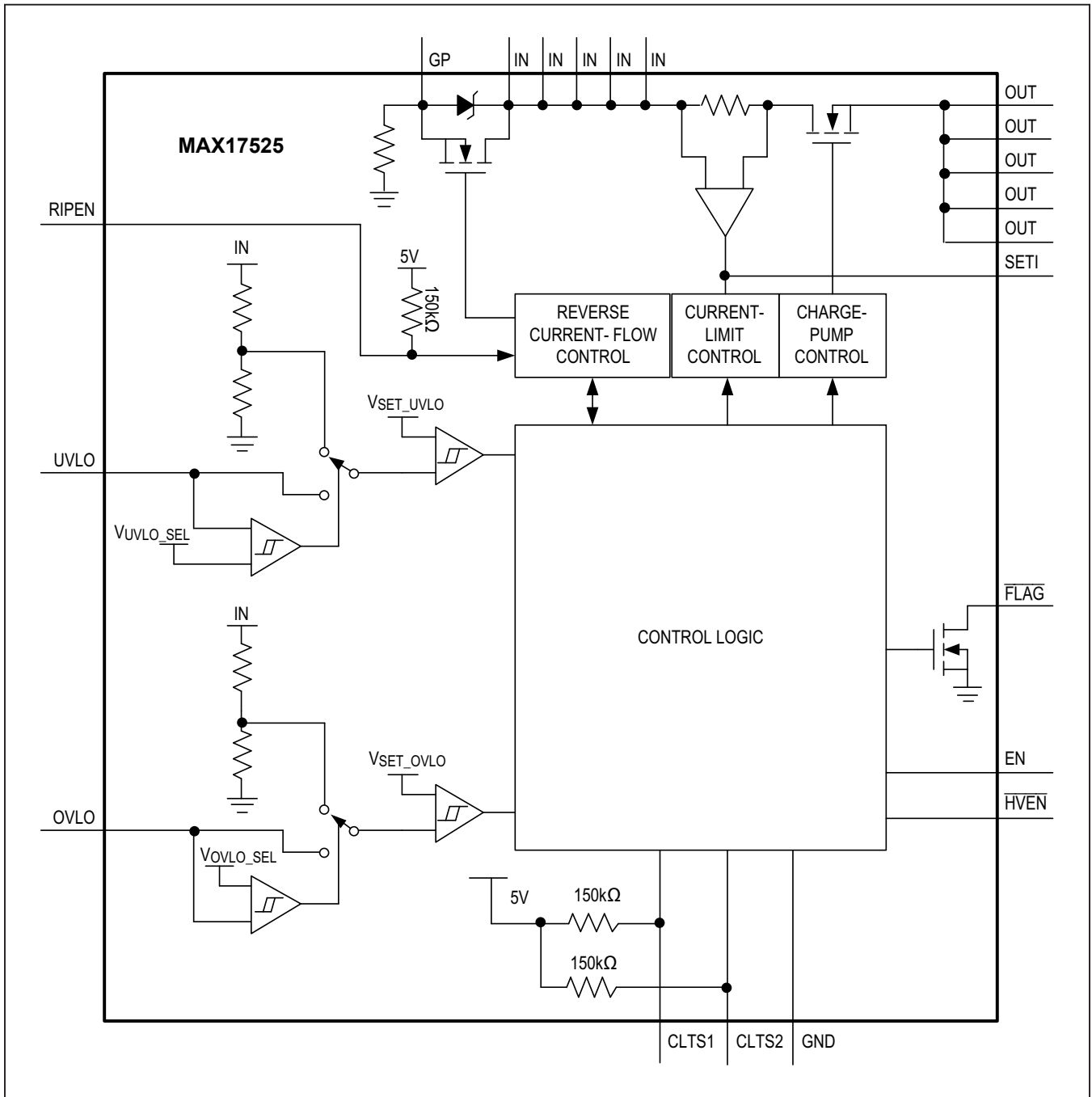

## Detailed Description

The MAX17525 adjustable overvoltage, undervoltage, and overcurrent protection device guards systems against overcurrent faults in addition to positive overvoltage and reverse-voltage faults. When used with an optional external pMOSFET, the device also protects downstream circuitry from voltage faults up to +60V, -60V (for  $-(60 + V_{OUT})$  external pFET rating). The device features a low, 31mΩ, on-resistance integrated FET.

During startup, the MAX17525 is designed to charge large capacitances on the output in a continuous mode for applications where large reservoir capacitors are used on the inputs to downstream devices. Two additional part options that feature a dual-stage current-limit mode in which the current is continuously limited to 1.5x and 2x the programmed limit, are available upon request. These options enable faster charging of large load capacitances during startup.

The device features the option to set the overvoltage-lockout (OVLO) and undervoltage-lockout (UVLO) thresholds manually using external voltage-dividers or to use the factory-preset internal thresholds by connecting the OVLO and/or UVLO pin(s) to GND. The permitted external overvoltage setting range of the device is 6V to 40V. Therefore, the pFET and internal nFET must be kept off in the 40V to 60V range by appropriate OVLO resistor-divider.

The device's programmable current-limit threshold can be set for currents up to 6A in autoretry, latching, or continuous-fault-response mode. When the device is set to autoretry mode and the current exceeds the threshold for more than 24ms (typ), both FETs are turned off for 720ms (typ), then turned back on. If the fault is still present, the cycle repeats. In latching mode, if a fault is present for more than 24ms (typ), both FETs are turned off until enable is toggled or the power is cycled. In continuous mode, the current is limited continuously to the programmed current-limit value. In all modes,  $\overline{FLAG}$  asserts if  $V_{IN} - V_{OUT}$  is greater than the  $\overline{FLAG}$  assertion drop voltage threshold ( $V_{FA}$ ).

### Startup Control

The MAX17525 limits the current to 1x the set limit during this period. Two additional part options that feature a dual-stage startup sequence that continuously limits the current to 1.5x and 2.0x the set current limit during the startup initial time ( $t_{STO}$ ), allowing large capacitors present on the output of the switch to be rapidly charge. If the temperature of any device rises to the thermal-foldback threshold ( $T_{J\_FB}$ ), the device enters power-limiting mode (Figure 1). In this mode, the device thermally regulates

the current through the switch to protect itself while still delivering as much current as possible to the output regardless of the current-limit type selected. If the output is not charged within the startup timeout period ( $t_{STO}$ ), the switch turns off and IN, EN, or HVEN must be toggled to resume normal operation.

The  $t_{STO}$  timeout period is also applied when there is a restart after a turn-off event caused by UVLO, OVLO, or reverse-current block event. If the output is not charged to  $(V_{IN} - V_{FA})$  level during this time, the device turns off and IN, EN, or HVEN must be toggled to resume normal operation.

### Overvoltage Lockout (OVLO)

The device features two methods for determining the OVLO threshold. By connecting the OVLO pin to GND, the preset internal OVLO threshold of 36V (typ) is selected. If the voltage at OVLO rises above the OVLO select threshold ( $V_{OVLO\_SEL}$ ), the device enters adjustable OVLO mode. Connect an external voltage-divider to the OVLO pin, as shown in the [Typical Application Circuit](#) to adjust the  $V_{SET\_OVLO}$  rising threshold at which the device detects an  $\overline{OVLO}$  event. The permitted overvoltage lockout set point range of the device is 6V to 40V.  $R3 = 2.2M\Omega$  is a good starting value for minimum current consumption. Since  $V_{SET\_OVLO}$  is known (1.22V typ),  $R3$  has been chosen, and  $V_{IN\_OVLO}$  is the target OVLO value,  $R4$  can then be calculated by the following equation:

$$R4 = \frac{R3 \times V_{SET\_OVLO}}{V_{IN\_OVLO} - V_{SET\_OVLO}}$$

### Undervoltage Lockout (UVLO)

The device features two methods for determining the UVLO threshold. By connecting the UVLO pin to GND, the preset, internal UVLO threshold of 12V (typ) is selected. If the voltage at UVLO rises above the UVLO select threshold ( $V_{UVLO\_SEL}$ ), the device enters adjustable UVLO mode. Connect an external voltage-divider to the UVLO pin, as shown in the [Typical Application Circuit](#) to adjust the  $V_{SET\_UVLO}$  falling threshold at which the device detects an  $\overline{UVLO}$  event. The permitted undervoltage lockout set point range of the device is 5.5V to 24V.  $R1 = 2.2M\Omega$  is a good starting value for minimum current consumption. Since  $V_{SET}$  is known (1.22V typ),  $R1$  has been chosen, and  $V_{IN\_UVLO}$  is the target UVLO value,  $R2$  can then be calculated by the following equation:

$$R2 = \frac{R1 \times V_{SET\_UVLO}}{V_{IN\_UVLO} - V_{SET\_UVLO}}$$

**Table 1. Enable Inputs**

$\overline{\text{HVEN}}$	EN	SWITCH STATUS
0	0	ON
0	1	ON
1	0	OFF
1	1	ON

**Switch Control**

There are two independent enable inputs on the devices:  $\overline{\text{HVEN}}$  and EN.  $\overline{\text{HVEN}}$  is a high-voltage-capable input, accepting signals up to 60V. EN is a low-voltage input, accepting a maximum voltage of 5V. In case of a fault condition, toggling  $\overline{\text{HVEN}}$  or EN resets the fault. The enable inputs control the state of the switch based on the truth table (Table 1).

**Input Debounce**

The device features a built-in input debounce time ( $t_{\text{DEB}}$ ). The debounce time is a delay between a POR event and the switch being turned on. If the input voltage rises above the UVLO threshold voltage or if, with a voltage greater than  $V_{\text{UVLO}}$  present on IN, the enable pins toggle to the on state, the switch turns on after  $t_{\text{DEB}}$ . In cases where the voltage at IN falls below  $V_{\text{UVLO}}$  before  $t_{\text{DEB}}$  has passed, the switch remains off (Figure 2). If the voltage at OUT is already above  $V_{\text{UVLO\_OUT}}$  when the device is turned on through either enable pin or coming out of OVLO, there is no debounce interval. This is due to the device already being out of the POR condition with OUT above  $V_{\text{UVLO\_OUT}}$ .

**Current-Limit Type Select**

The MAX17525 feature three selectable current-limiting modes. During power-up, all devices default to continuous mode and follow the procedure defined in the [Startup Control](#) section. Once the part has been successfully powered on and  $t_{\text{STO}}$  has expired, the device senses the condition of CLTS1 and CLTS2. The condition of CLTS1 and CLTS2 sets the current-limit mode type according to Table 2. CLTS1,2 are internally pulled up to an internal 5V supply. Therefore, the device is in continuous current-limit mode when CLTS1 and 2 are open. To set CLTS\_ state to low, connect a 10k $\Omega$  resistor or below to ground.

In addition to the selectable current-limiting modes, the device has a protection feature against a severe over load condition. If the output current exceeds 2 times the set current limit, the device will turn off the internal nFET and external pFET immediately and will attempt to restart to allow the overcurrent to last for  $t_{\text{BLANK}}$  time. The off duration depends on fault condition occurred after the FETs turn

**Table 2. Current-Limit Type Select**

CLTS2	CLTS1	CURRENT-LIMIT TYPE
0	0	LATCHOFF MODE
0	1	AUTORETRY MODE
1	0	CONTINUOUS MODE
1	1	CONTINUOUS MODE

off, with the shortest duration of 420 $\mu\text{s}$  ( $t_{\text{ON\_FET}}$ ) if there is no fault. In latchoff mode, the device will latch off if the overcurrent fault last longer than  $t_{\text{BLANK}}$ .

**Autoretry Mode (Figure 3)**

In autoretry current-limit mode, when current through the device reaches the threshold, the  $t_{\text{BLANK}}$  timer begins counting. The  $\overline{\text{FLAG}}$  output asserts low when the voltage drop across the switch rises above  $V_{\text{FA}}$ . If the overcurrent condition is present for  $t_{\text{BLANK}}$ , the switch is turned off. The timer resets if the overcurrent condition disappears before  $t_{\text{BLANK}}$  has elapsed. A retry time delay ( $t_{\text{RETRY}}$ ) starts immediately once  $t_{\text{BLANK}}$  has elapsed. During the retry time, the switch remains off and, once  $t_{\text{RETRY}}$  has elapsed, the switch is turned back on. If the fault still exists, the cycle is repeated and  $\overline{\text{FLAG}}$  remains low. If the fault has been removed, the switch stays on.

The autoretry feature reduces system power in case of overcurrent or short-circuit conditions. When the switch is on during  $t_{\text{BLANK}}$  time, the supply current is held at the current limit. When the switch is off during  $t_{\text{RETRY}}$  time, there is no current through the switch. Thus, the output current is much less than the programmed current limit. Calculate the average output current using the following equation:

$$I_{\text{LOAD}} = I_{\text{LIM}} \left[ \frac{t_{\text{BLANK}} + t_{\text{STI}} \times K}{t_{\text{BLANK}} + t_{\text{RETRY}} + t_{\text{STI}}} \right]$$

where K is the multiplication factor of the initial current limit (1x, 1.5x or 2x). With a 24ms (typ)  $t_{\text{BLANK}}$ , 24ms  $t_{\text{STI}}$ ,  $K = 1$  and 720ms (typ)  $t_{\text{RETRY}}$ , the duty cycle is 3.1%, resulting in 97% power saving when compared to the switch being on the entire time.

**Latchoff Mode (Figure 4)**

In latchoff current-limit mode, when current through the device reaches the threshold, the  $t_{\text{BLANK}}$  timer begins counting.  $\overline{\text{FLAG}}$  asserts when the voltage drop across the switch rises above  $V_{\text{FA}}$ . The timer resets if the overcurrent condition disappears before  $t_{\text{BLANK}}$  has elapsed. The switch turns off if the overcurrent condition remains for the blanking time. The switch remains off until the control logic (EN or  $\overline{\text{HVEN}}$ ) is toggled or the input voltage is cycled.

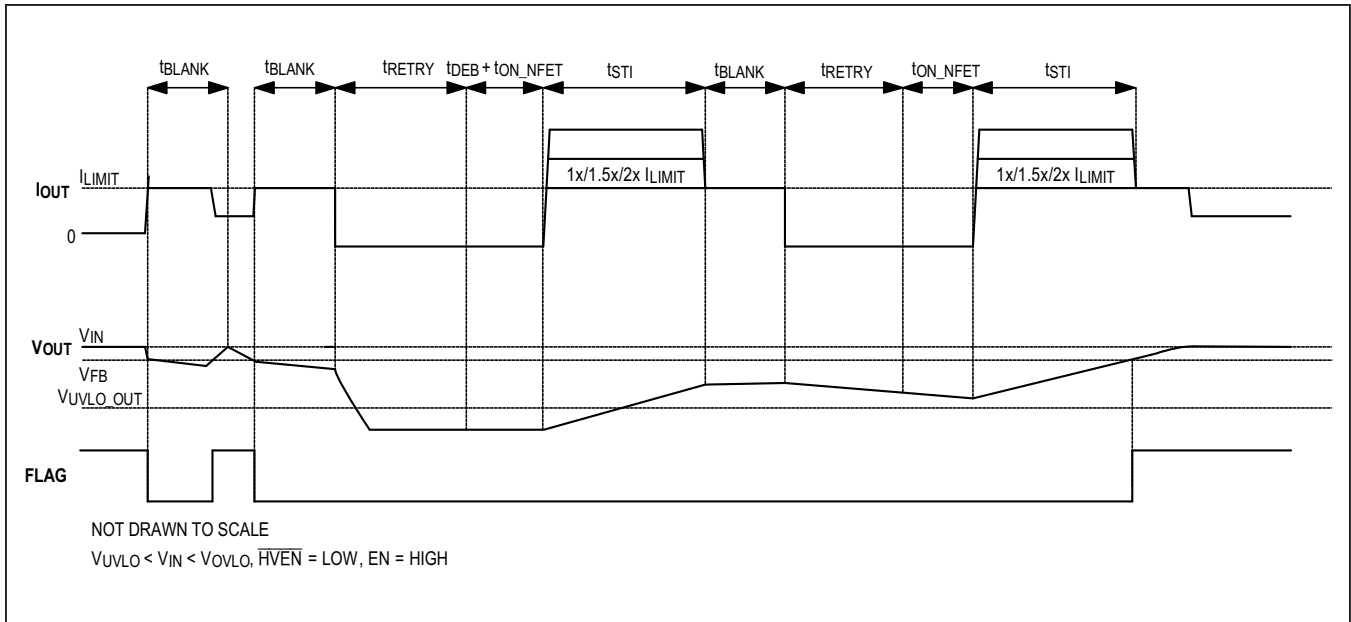

Figure 3. Autoretry Fault Diagram

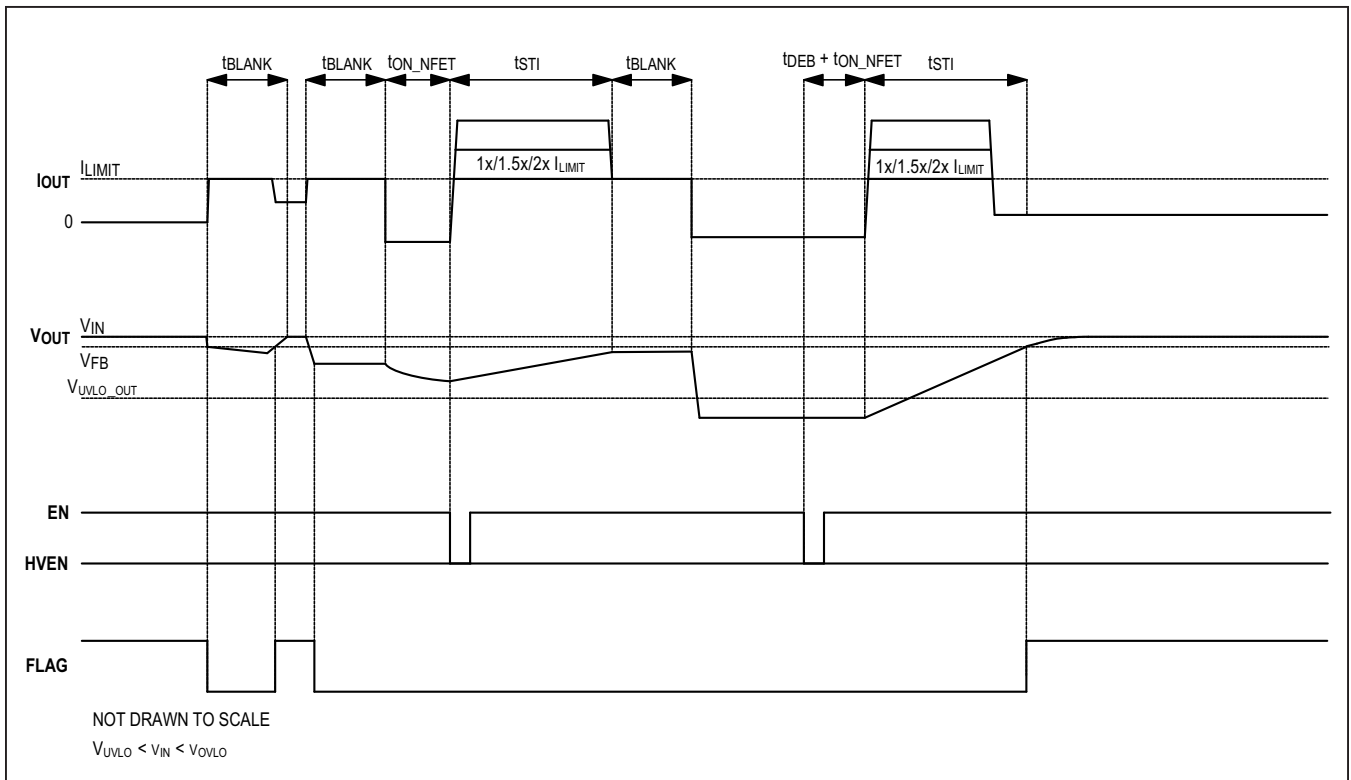

Figure 4. Latchoff Fault Diagram

**Continuous Mode (Figure 5)**

In continuous current-limit mode, when current through the device reaches the threshold, the device limits the current to the programmed limit.  $\overline{\text{FLAG}}$  asserts when the voltage drop across the switch rises above  $V_{FA}$ , and deasserts when it falls below  $V_{FA}$ .

**Reverse-Current Blocking (Figure 6, Figure 7)**

The device features current-blocking functionality to be used with external pFET. To enable the reverse-current blocking feature, pull RIPEN high or leave RIPEN unconnected as it is internally pulled high. With RIPEN high, if a reverse-current condition is detected ( $V_{IN} - V_{OUT} < V_{RIB}$ ), the internal nFET and the external pFET are turned off for  $450\mu\text{s}$  ( $t_{REV\_REC}$ ). During and after this time, the device monitors the voltage difference between OUT and IN pins to determine whether the reverse current is still present. Once  $t_{REV\_REC}$  expired and the reverse-current condition

has been removed, the nFET and pFET are turned back on after an additional time delay followed by the dual-stage startup control mechanism, defined in the [Startup Control](#) section above, is applied. The additional time delay will be  $200\mu\text{s}$  ( $t_{ON\_NFET}$ ) for nFET and  $1.2\text{ms}$  ( $t_{ON\_PFET}$ ) for pFET if voltage at OUT is greater than or equal to  $V_{UVLO\_OUT}$  falling at the end of  $t_{REV\_REC}$  delay, otherwise the delay will be  $1.4\text{ms}$  ( $t_{DEB} + t_{ON\_NFET}$ ) for nFET and  $2.4\text{ms}$  ( $t_{DEB} + t_{ON\_PFET}$ ) for pFET. After a reverse-current event, the device will attempt a restart regardless of the current-type select.

The device contains two reverse-current thresholds with slow ( $< 30\mu\text{s}$ ) and fast ( $< 1\mu\text{s}$ ) response time for reverse current protection. This feature results in robust operation in a noisy environment, while still delivering fast protection for severe fault, such as input short circuit.

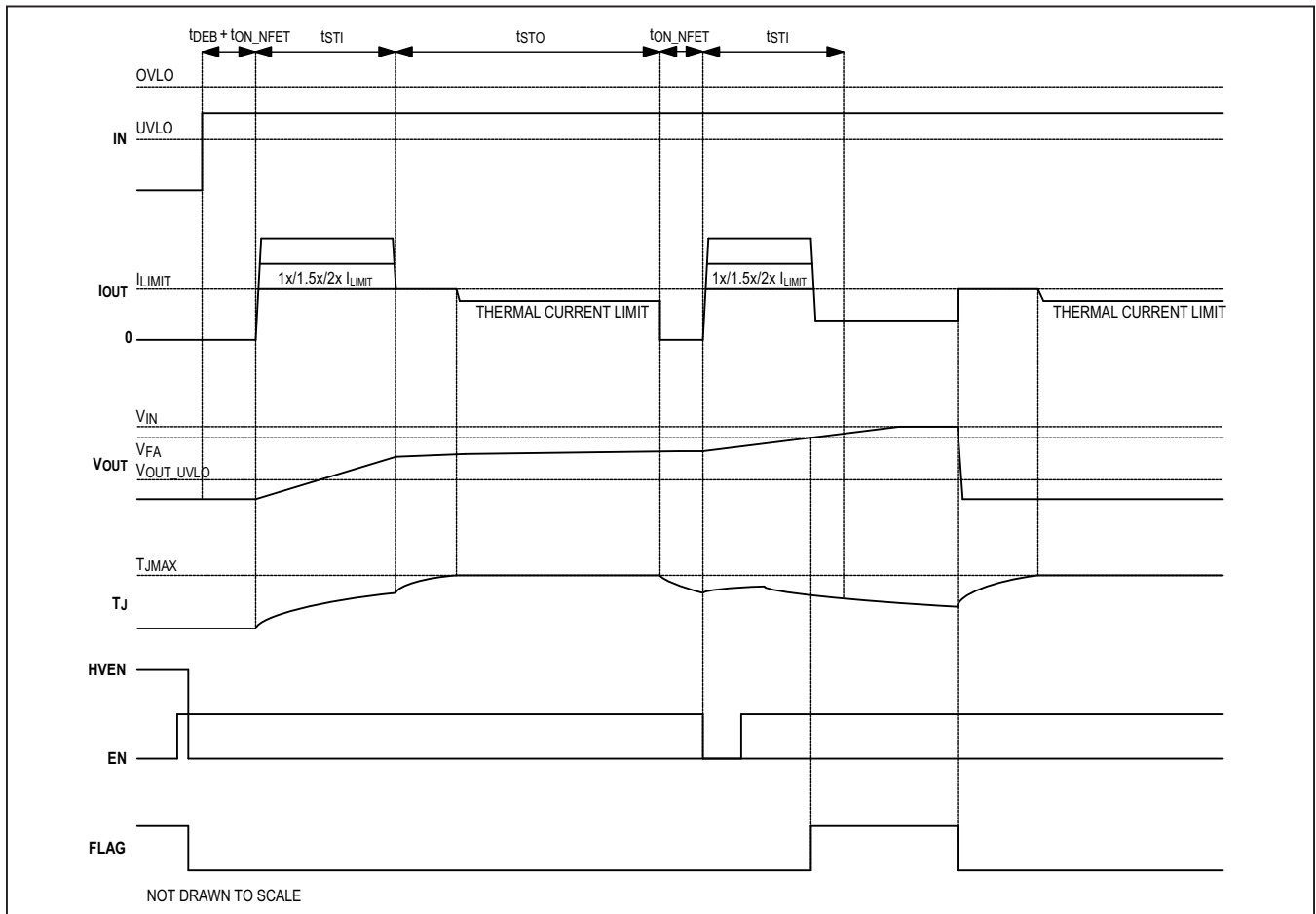

Figure 5. Continuous Fault Diagram

**Fault Indicator (FLAG) Output**

FLAG is an open-drain fault-indicator output. It requires an external pullup resistor to a DC supply. FLAG asserts when any of the following conditions occur:

- $V_{IN} - V_{OUT} > V_{FA}$
- Reverse-current protection is tripped
- Die temperature exceeds +170°C
- SETI is connected to ground
- UVLO threshold has not been reached
- OVLO threshold is reached

**Thermal Shutdown Protection**

Thermal-shutdown circuitry protects the devices from overheating. The switch turns off and FLAG asserts when the junction temperature exceeds +170°C (typ). The device exits thermal shutdown and resumes normal operation once the junction temperature cools by 20°C (typ) when

the device is in autoretry or continuous current-limiting mode. When in latching mode, the device remains latched off until the input voltage is cycled or one of the enable pins is toggled.

The thermal shutdown technology built into the devices behaves in accordance with the selected current-limit mode. While the device is in autoretry mode, the thermal limit uses the autoretry timing when coming out of a fault condition. When the device detects an overtemperature fault, the switch turns off. Once the temperature of the junction falls below the falling thermal threshold, the device turns on after the time interval  $t_{RETRY}$ . In latching mode, the device latches off until the input is cycled or one of the enable pins is toggled. In continuous current-limiting mode, the device turns off while the temperature is over the limit, then turns back on after  $t_{DEB}$  when the temperature reaches the falling threshold. There is no retry time for thermal protection.

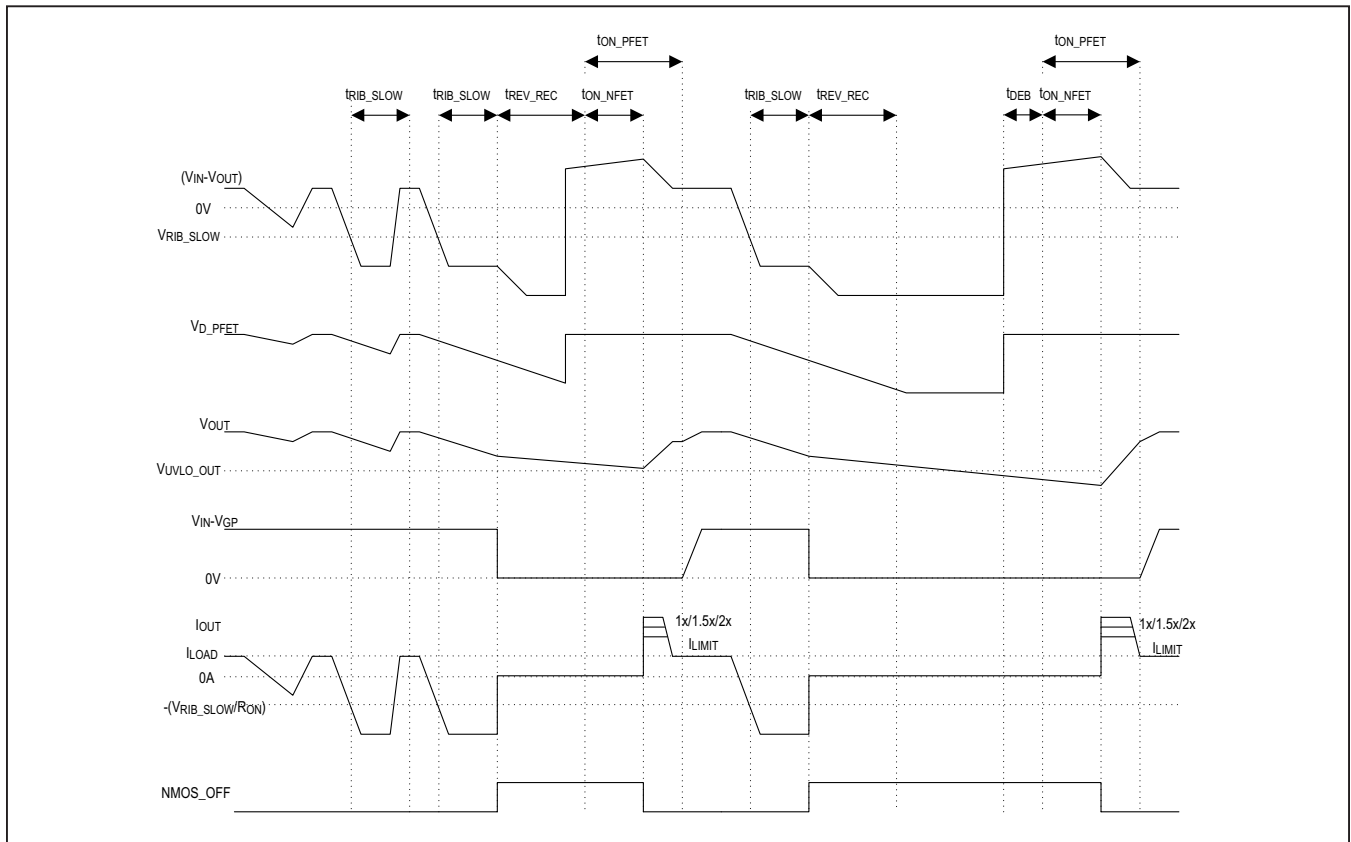

Figure 6. Slow Reverse-Current Fault Timing Diagram



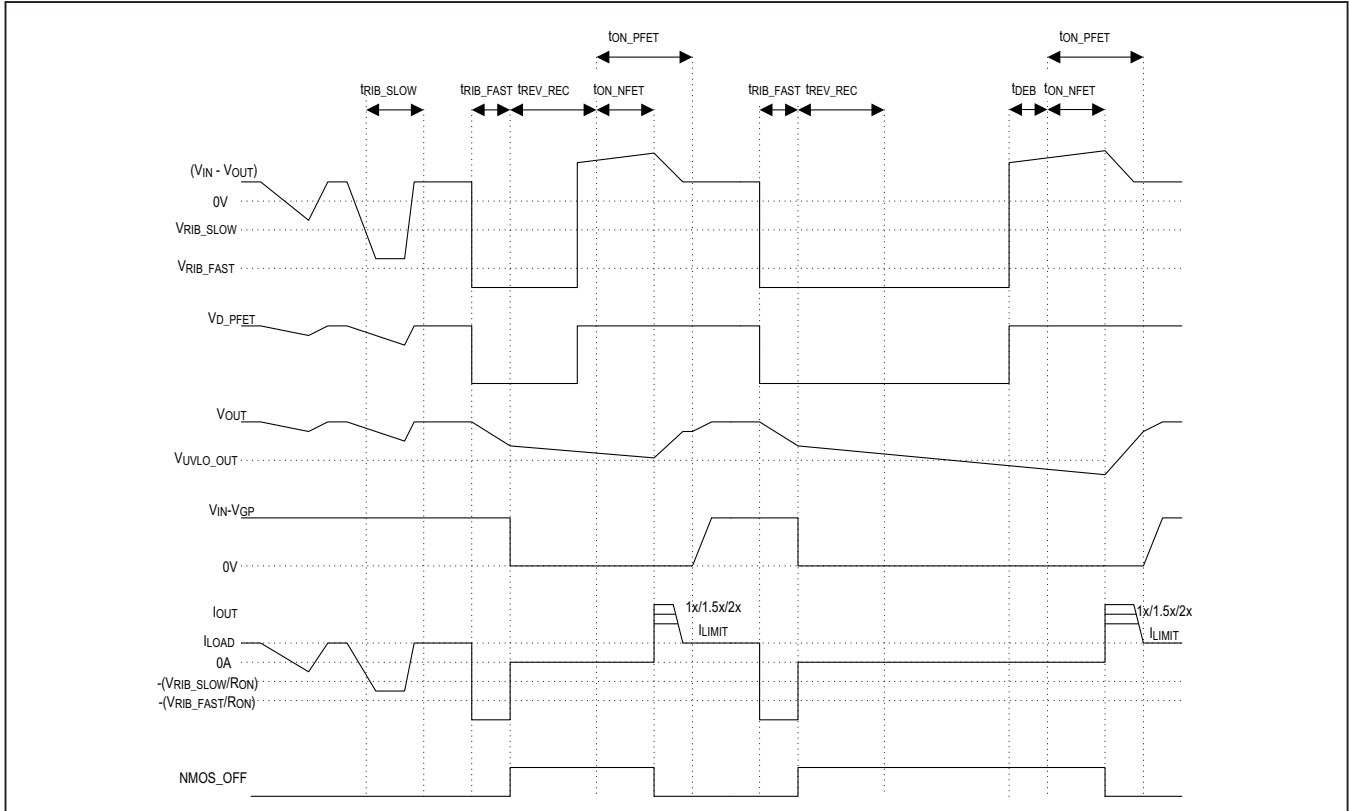

Figure 7. Fast Reverse-Current Fault Timing Diagram

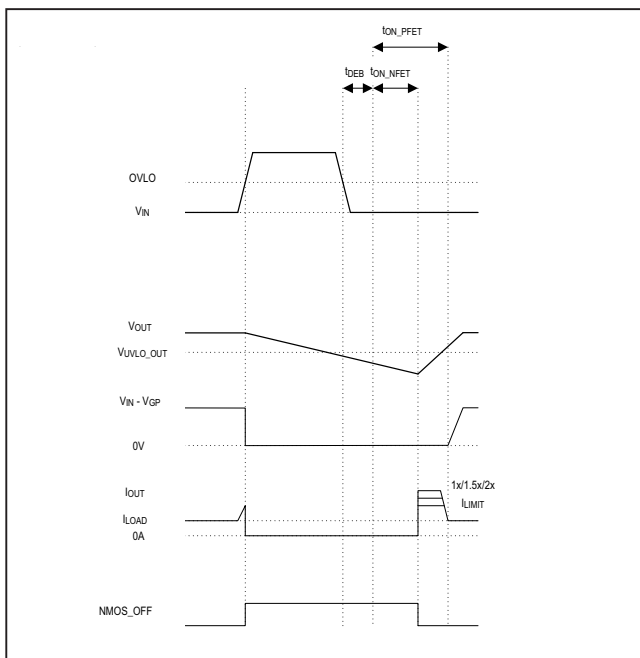

Figure 8. Overvoltage Fault Timing Diagram

## Applications Information

### Setting the Current-Limit Threshold

Connect a resistor between SET1 and ground to program the current-limit threshold for the device. Leaving SET1 unconnected sets the current-limit threshold to 0A and, since connecting SET1 to ground is a fault condition, this causes the switch to remain off and FLAG to assert. Use the following formula to calculate the current-limit threshold:

$$R_{SET1}(k\Omega) = \frac{V_{RI}(\Omega \times A)}{I_{LIM}(mA)} \times C_{IRATIO}$$

Do not use a  $R_{SET1}$  smaller than 6k $\Omega$ . [Table 3](#) shows current-limit thresholds for different resistor values at SET1.

A current mirror with a ratio of  $C_{IRATIO}$  is implemented with a current-sense auto-zero operational amplifier. The mirrored current of the IN-OUT FET is provided on the SET1 pin. Therefore, the voltage ( $V_{SET1}$ ) read on the SET1 pin should be interpreted as the current through the IN-OUT FET, as shown below:

$$I_{IN-OUT} = I_{SET1} \times C_{IRATIO} = \frac{V_{SET1}(V)}{R_{SET1}(k\Omega)} \times C_{IRATIO} = \frac{V_{SET1}(V)}{V_{RI}(V)} \times I_{LIM}$$

### IN Bypass Capacitor

In application in which an external pFET is not used, connect a minimum of 1 $\mu$ F capacitor from IN to GND to limit the input voltage drop during momentary output short-circuit conditions. Larger capacitor values further reduce the voltage droop at the input caused by load transients. In applications in which an external pFET is used a 4.7 $\mu$ F capacitor is placed at the drain of the pFET, and capacitor at IN is reduced to 10nF (100nF, max).

### Hot Plug-In

In many power applications, an input filtering capacitor is required to lower the radiated emission and enhance the ESD capability, etc. In hot-plug applications, parasitic cable inductance, along with the input capacitor, causes overshoot and ringing when a powered cable is suddenly connected to the input terminal. This effect causes the protection device to see almost twice the applied voltage. An input voltage of 24V can easily exceed 40V due to ringing. The device contains internal protection against hot-plug input transient. on the IN pins, with slew rate up to 30V/ $\mu$ s. However, in the case where the harsh industrial EMC test is required, use a transient voltage suppressor (TVS) placed close to the input terminal that is capable of limiting the input surge to 60V (max).

### OUT Capacitance

For stable operation over the full temperature range and over the entire programmable current-limit range, connect a 4.7 $\mu$ F ceramic capacitor from OUT to ground. Other circuits connected to the output of the device may introduce additional capacitance, but it should be noted that excessive output capacitance on the device can cause faults. If the capacitance is too high, the device may not be able to charge the capacitor before the startup timeout.

Calculate the maximum capacitive load ( $C_{MAX}$ ) value that can be connected to OUT using the following formula:

$$C_{MAX}(mF) = I_{LIM}(A) \left[ \frac{M \times t_{STI}(ms) + t_{STO}(ms)}{V_{IN\_MAX}(V)} \right]$$

where M is the multiplier (1x/1.5x/2x) applied to the current limit during startup. For example, when using MAX17525, if  $V_{IN\_MAX} = 30V$ ,  $t_{STO}(\min) = 1090ms$ ,  $t_{STI}(\min) = 22ms$ , and  $I_{LIM} = 3A$ ,  $C_{MAX}$  results in the theoretical maximum of 111mF. In this case, any capacitance larger than 111mF will cause a fault condition because the capacitor cannot be charged to a sufficient voltage before  $t_{STO}$  has expired. In practical applications, the output capacitor size is limited by the thermal performance of the PCB. Poor thermal design can cause the thermal-foldback current-limiting function of the device to kick in too early, which may further limit the maximum capacitance that can be charged. Therefore, good thermal PCB design is imperative to charge large capacitor banks.

**Table 3. Current-Limit Threshold vs. Resistor Values**

$R_{SET1}$ (k $\Omega$ )	CURRENT LIMIT (A)
62.5	0.6
37.5	1.0
25.0	1.5
18.75	2.0
15.0	2.5
12.5	3.0
10.7	3.5
9.375	4.0
8.3	4.5
7.5	5.0
6.82	5.5
6.25	6.0

### OUT Freewheeling Diode for Inductive Hard Short to Ground

In applications with a highly inductive load, a freewheeling diode is required between the OUT terminal and GND. This protects the device from inductive kickback that occurs during short-to-ground events.

### PCB Layout Recommendations

To optimize the switch response to output short-circuit conditions, it is important to reduce the effect of undesirable parasitic inductance by keeping all traces as short as possible. Place input and output capacitors as close as possible to the device (no more than 5mm). IN and OUT must be connected with wide short traces to the power bus. During steady-state operation, the power dissipation is typically low and the package temperature change is usually minimal.

PCB layout designs need to meet two challenges: high-current input and output paths and important heat dissipation.

#### Heat Dissipation

Maxim recommends the use of 2oz copper on FR4 isolator in a four-layer configuration.

The layer stack needs to be Top (routing), GND (plane), Power (plane, connected to  $V_{OUT}$ ) and Bottom (routing), in this order, from top to bottom.

Install the IC on an exposed pad landing of minimum 100 x 100 mils, with at least five through vias to the GND plane. The vias should be 32mils in diameter, with a 16mils plated hole. The hole plating needs to be at least 0.5oz copper.

Provide a minimum of 1in x 1in area of copper plane on all four layers. It is important to remember that the inner planes do not contribute much to heat dissipation, due to FR4 isolation, but are important from an electrical point of view.

If possible, keep the top and bottom copper areas clear of solder mask, as this will greatly improve heat dissipation.

Use a similarly large copper area connected directly to the OUT pins. A dimension of 1in x 1in is also recommended. This might look oversized for current path requirements,

but is essential for heat dissipation. Keep in mind that heat is generated at the drain junction of the internal nMOS pass FET, which is then eliminated through the five OUT pins and needs to be dissipated on this same copper area.

#### Current Path Requirements

Connect all five IN pins to a copper area that is at least 150mils wide. Using 2oz copper may reduce this requirement to 100mils. Remember to provide the same copper trace width on the source connection, when using the external pMOS pass FET (with the source connected to the IN pins).

Use extreme caution when placing the decoupling capacitors to the IN and OUT pins. The tendency to go as close as possible to the IC pins might interfere with the minimum requirement of the trace width above.

It is important to note that the return load current does not flow through the IC; therefore, it is important to provide an external ground trace of at least the same width as the input/output one.

Maxim recommends the use of a GND plane. Connect the input and output grounds to this plane using at least four plated vias each. The vias should be 84mils in diameter (or 60mils x 60mils, if square), with a 35mils plated hole.

#### Additional Information

For more information on heat dissipation, see the *IC Application Section* on <http://www.maximintegrated.com>.

#### ESD Test Conditions

The devices are specified for  $\pm 15\text{kV}$  (HBM) ESD on IN when IN is bypassed to ground with a  $1\mu\text{F}$ , low ESR ceramic capacitor. No capacitor is required for  $\pm 2\text{kV}$  (typ) (HBM) ESD on IN. All pins have  $\pm 2\text{kV}$  (HBM) ESD protection. In applications in which an external pFET is used, see the [IN Bypass Capacitor](#) section.

#### HBM ESD Protection

[Figure 9](#) shows the Human Body Model and [Figure 10](#) shows the current waveform it generates when discharged into low impedance. This model consists of a 100pF capacitor charged to the ESD voltage of interest, which is then discharged into the device through a  $1.5\text{k}\Omega$  resistor.

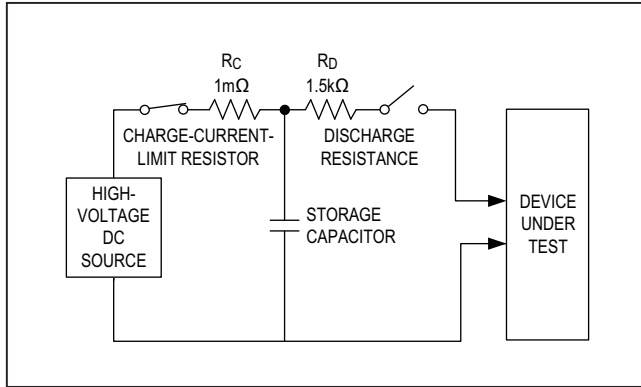

Figure 9. Human Body ESD Test Model

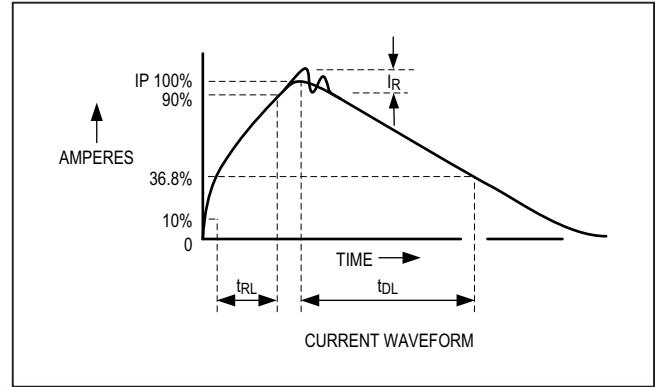

Figure 10. Human Body Current Waveform

### Ordering Information

PART	INITIAL CURRENT LIMIT	TEMP RANGE	PIN-PACKAGE
MAX17525ATP+T	1.0x	-40°C to +125°C	20 TQFN-EP*

+Denotes a lead(Pb)-free/RoHS-compliant package.

T = Tape and reel.

\*EP = Exposed pad.

### Chip Information

PROCESS: BiCMOS

## Revision History

REVISION NUMBER	REVISION DATE	DESCRIPTION	PAGES CHANGED
0	6/16	Initial release	—
1	1/17	Updated text to reflect single part present in data sheet	1, 11–12, 14–15, 17
2	12/17	Updated the <i>Benefits and Features</i> , <i>Absolute Maximum Ratings</i> , <i>Overvoltage Lockout (OVLO)</i> , <i>Undervoltage Lockout (UVLO)</i> , and <i>Hot Plug-In</i> sections. Added the <i>ESD Test Conditions</i> section. Replaced <i>Typical Application Circuit</i> and updated the <i>Functional Diagram</i> .	1–2, 10–11, 17–18
3	2/22	Updated <i>General Description</i> , <i>Overvoltage Lockout (OVLO)</i> , and <i>Undervoltage Lockout (UVLO)</i> sections, <i>Typical Application Circuit</i> , <i>Electrical Characteristics</i> table, and <i>Functional Diagram</i>	1, 3, 11, 12
4	3/22	Updated <i>Undervoltage Lockout (UVLO)</i> section	12



Information furnished by Analog Devices is believed to be accurate and reliable. However, no responsibility is assumed by Analog Devices for its use, nor for any infringements of patents or other rights of third parties that may result from its use. Specifications subject to change without notice. No license is granted by implication or otherwise under any patent or patent rights of Analog Devices. Trademarks and registered trademarks are the property of their respective owners.