

## MAX17651 Evaluation Kit

Evaluates: MAX17651

### General Description

The MAX17651 evaluation kit (EV kit) is a fully assembled and tested circuit board that demonstrates the performance of the MAX17651 high-voltage, ultra-low quiescent current linear regulator. The EV kit operates over a wide input voltage range of 4V to 60V and provides up to 100mA load current. It draws only 8 $\mu$ A supply current under no-load conditions. The device is simple to use and easily configurable with minimal external components. It features overload current protection and thermal shutdown. The EV kit comes installed with the MAX17651AZT+ in a 6-pin, compact TSOT package.

### Features

- Extremely Easy to Use
  - Stable with Tiny 4.7 $\mu$ F, 0805 Output Capacitor
  - Only Four External Components Required
- Reduces Number of Linear Regulators to Stock
  - Wide 4V to 60V Input Voltage Range
  - Adjustable 0.6V to 59V Output Voltage
  - Up to 100mA Load Current Capability
- Operates Reliably in Adverse Industrial Environments
  - Built-In Output Voltage Monitoring with PGOOD Pin
  - High-Voltage ENABLE Input
  - Low 8 $\mu$ A Quiescent Current
  - Overload Protection
  - Overtemperature Protection

**Ordering Information** appears at end of data sheet.

### Quick Start

#### Required Equipment

- MAX17651 EV kit
- 60V, 0.2A DC power supply
- Electronic load up to 100mA
- Digital voltmeter (DVM)

#### Procedure

The EV kit is fully assembled and tested. Follow the steps below to verify board operation. Caution: Do not turn on the power supply until all connections are completed.

- 1) Verify that shunts are installed between pins 1 and 2 of jumper JU1 (EN).
- 2) Place a shunt on JU2 or JU3, depending on the desired output voltage (see [Table 3](#) for details).
- 3) Set the electronic load to constant-current mode, 100mA, and disable the electronic load.
- 4) Connect the electronic load's positive terminal to the V<sub>OUT</sub> PCB pad. Connect the negative terminal to the GND PCB pad.
- 5) Connect the voltmeter across the V<sub>OUT</sub> and GND PCB pads.
- 6) Set the power-supply output to greater than the selected output voltage. Disable the power supply.
- 7) Connect the power-supply output to the V<sub>IN</sub> PCB pad. Connect the supply ground to the GND PCB pad.
- 8) Turn on the power supply.
- 9) Enable the electronic load and verify that output voltage is at 3.3V or 5V with respect to GND.
- 10) Vary the input voltage from 4V to 60V.
- 11) Vary the load current from 1mA to available maximum load current (from thermal dissipation calculation, see the [Available Output Current Calculation](#) section for more details) and verify that output voltage is 3.3V or 5V with respect to GND.

### Detailed Description of Hardware

The MAX17651 EV kit is a fully assembled and tested circuit board that demonstrates the performance of the MAX17651 high-voltage, ultra-low quiescent current linear regulator. The EV kit operates over a wide input-voltage range of 4V to 60V and provides up to 100mA load current. It draws only 8µA supply current under no-load conditions. The MAX17651 is simple to use and easily configurable with minimal external components. It features overload current protection and thermal shutdown.

The EV kit includes an EN PCB pad and JU1 to enable control of the converter output. Jumpers JU2, JU3, and JU4 are provided for selecting the output voltage of the converter. PGOOD PCB pad is available for monitoring the PGOOD output.

#### Enable Control (JU1, JU2)

The EN PCB pad of the EV kit serves as an on/off control. See [Table 1](#) to configure JU1.

#### Active-Low, Open-Drain PGOOD Output (PGOOD)

The EV kit provides a PCB pad to monitor the status of the PGOOD output. PGOOD goes high when the output voltage rises above 92% (typ) of its nominal regulated output voltage. PGOOD goes low when the output voltage falls below 89.5% (typ) of its nominal regulated voltage. The voltage on the PGOOD pin should not exceed 5V. If the output voltage is greater than 5V, calculate the value of resistance R6 from the following equation:

$$R6 = \frac{500}{V_{OUT} - 5} \text{ k}\Omega$$

#### Output Voltage Setting

The output voltage can be programmed from 0.6V to 59V. If the output voltage is neither 5V or 3.3V, calculate the value of R4 using the following equation. Place a shunt on one of JU2, JU3, and JU4, according to [Table 2](#).

$$R4 = 98.3 \times (V_{OUT} - 0.6)\text{k}\Omega$$

#### Output Capacitor Selection

The voltage rating of the output capacitor (C3) installed on the board is 10V. If the programmed output voltage is greater than 10V, an output capacitor with a higher voltage rating should be installed.

### Available Output Current Calculation

Ensure that the junction temperature of the MAX17651 does not exceed +125°C under the operating conditions specified for the power supply.

At a particular operating condition, the power loss that led to the temperature rise of the part is estimated as follows:

$$P_{LOSS} = (V_{IN} - V_{OUT}) \times I_{LOAD}$$

where,  $V_{IN}$  is the input voltage,  $V_{OUT}$  is the output voltage, and  $I_{LOAD}$  is the load current.

Package thermal resistance obtained using the method described in JEDEC specification JESD51-7 is

$$\theta_{JA} = 110^\circ\text{C/W}$$

The junction temperature of the MAX17651 can be estimated at any given maximum ambient temperature ( $T_{A\_MAX}$ ) from the equation below:

$$T_J = T_{A\_MAX} + (\theta_{JA} \times P_{LOSS})$$

Calculate the maximum allowable output current in mA using the following formula:

$$I_{LOAD(MAX)} = \frac{(125 - T_{A\_MAX})}{0.11 \times (V_{IN} - V_{OUT})}$$

Example:  $T_{A\_MAX} = +70^\circ\text{C}$ ,  $V_{IN} = 24\text{V}$ ,  $V_{OUT} = 5\text{V}$ .

$$I_{LOAD(MAX)} = \frac{(125 - 70)}{0.11 \times (24 - 5)} \cong 26.3\text{mA}$$

**Table 1. Enable Control (EN)**

JU1 SHUNT POSITION	EN PIN	OUTPUT
1-2*	Connected to VIN	Enabled
2-3	Connected to GND	Disabled

\*Default position.

**Table 2. Output Voltage**

OUTPUT VOLTAGE	PLACE SHUNT ON
$V_{OUT} = 5\text{V}$	JU2*
$V_{OUT} = 3.3\text{V}$	JU3
$V_{OUT} = \text{Other than } 5\text{V and } 3.3\text{V}$	JU4

\*Default position.

### EV Kit Performance

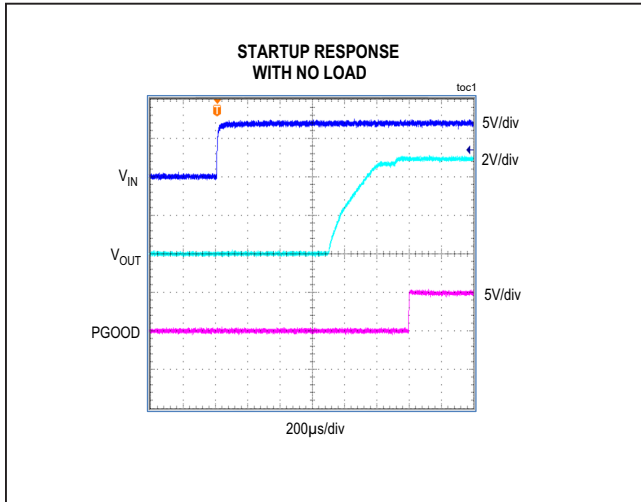

Figure 1. Startup Sequence at No-Load

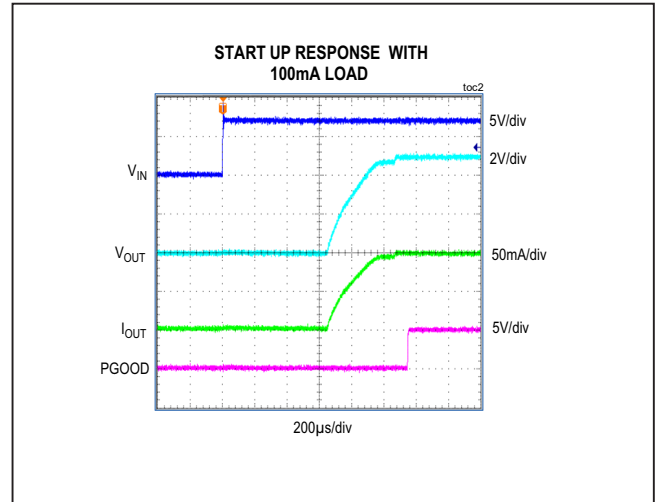

Figure 2. Startup Sequence at Full-Load

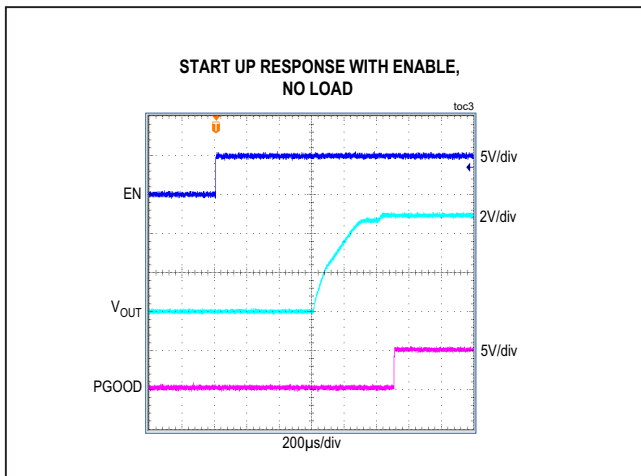

Figure 3. Enable Turn-On Sequence at No-Load

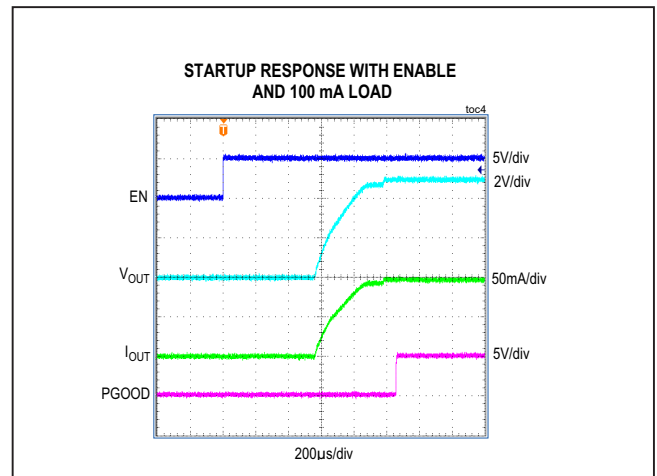

Figure 4. Enable Turn-On Sequence at Full-Load

EV Kit Performance (continued)

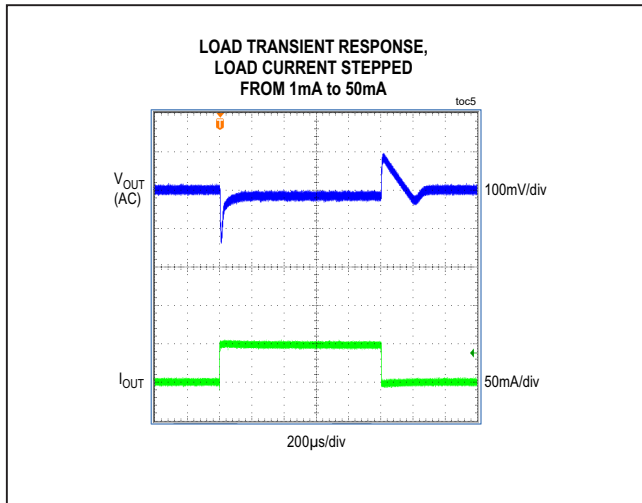

Figure 5. 1mA to 50mA Load Transient Response

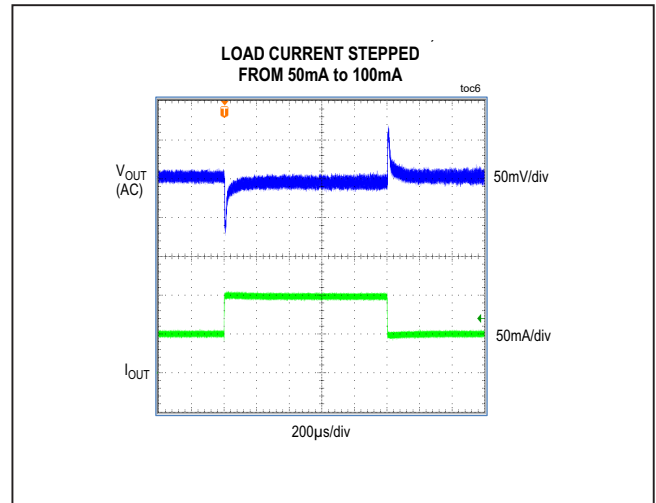

Figure 6. 50mA to 100mA Load Transient Response

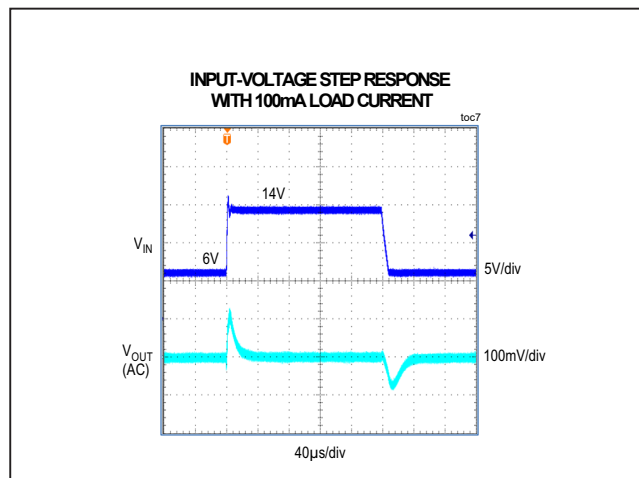

Figure 6. Input Voltage Step (6V to 14V) Response

### Component Suppliers

SUPPLIER	WEBSITE
Murata Americas	www.murata.com
Panasonic	www.industrial.panasonic.com

### Ordering Information

PART	TYPE
MAX17651EVKIT#	EV KIT

#Denotes RoHS compliant.

### MAX17651 EV Kit Bill of Materials

Serial No.	Description	Quantity	Designator	Part Number
1	10µF, 80V electrolytic capacitor (6.6mm x 6.6mm)	1	C1*	PANASONIC EEE-FK1K100XP
2	0.1µF ±10%, 100V X7R ceramic capacitor (0603)	1	C2	MURATA GRM188R72A104K
3	4.7µF ±10%, 10V X7R ceramic capacitor (0805)	1	C3	Murata GRM21BR71A475K
4	Not installed, OPEN (0805)	0	C4	
5	3-pin headers	1	JU1	Sullins:GRPB031VWVN-RC
6	2-pin headers	3	JU2-JU4	Sullins: GRPB021VWVN-RC
7	432k ohm ±1%, resistor (0402)	1	R1	
8	59k ohm ±1%, resistor (0402)	1	R2	
9	267k ohm ±1%, resistor (0402)	1	R3	
10	Not installed	1	R4	
11	100k ohm ±1%, resistor (0402)	1	R5	
12	Not installed	1	R6	
13	60V, 100mA, ultra-low quiescent current, Linear regulator MAX17651AZT+	1	U1	MAX17651AZT+
14	Shunt	4	See Jumper Table	SULLINS NPB02SVAN-RC

Note: \* denotes optional. The electrolytic capacitor C1 is required only when the input power source is located far from the MAX17651 Evkit

Jumper Table	
JUMPER	SHUNT POSITION
JU1	1-2
JU2	1-2
JU3	OPEN
JU4	OPEN

MAX17651 EV Kit Schematic

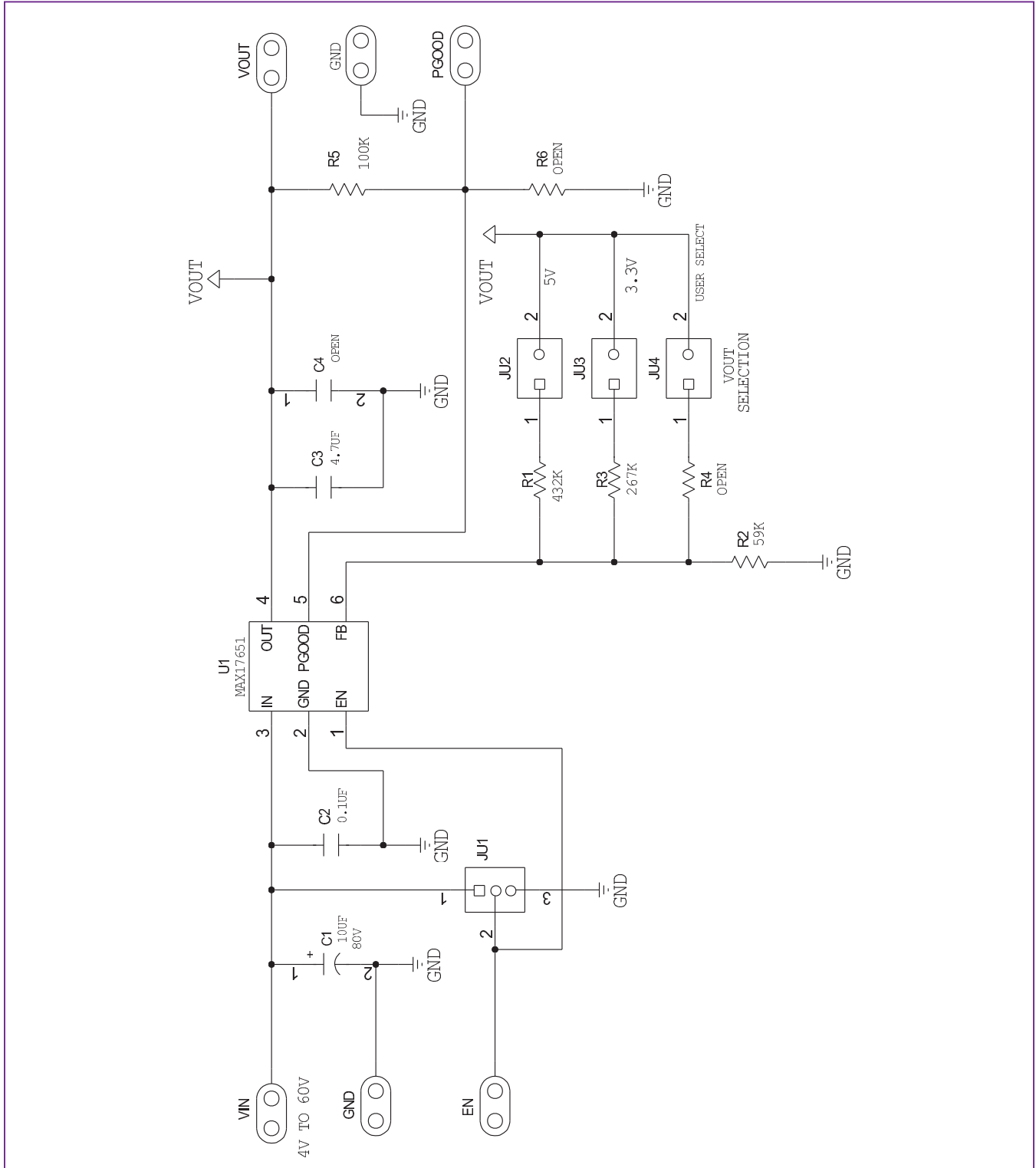

MAX17651 EV Kit PCB Layout

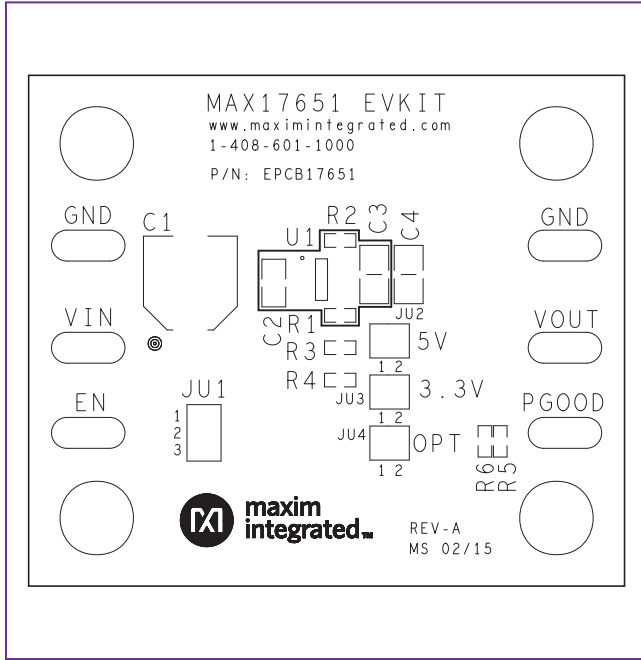

MAX17651 EV Kit PCB Layout—Top Silkscreen

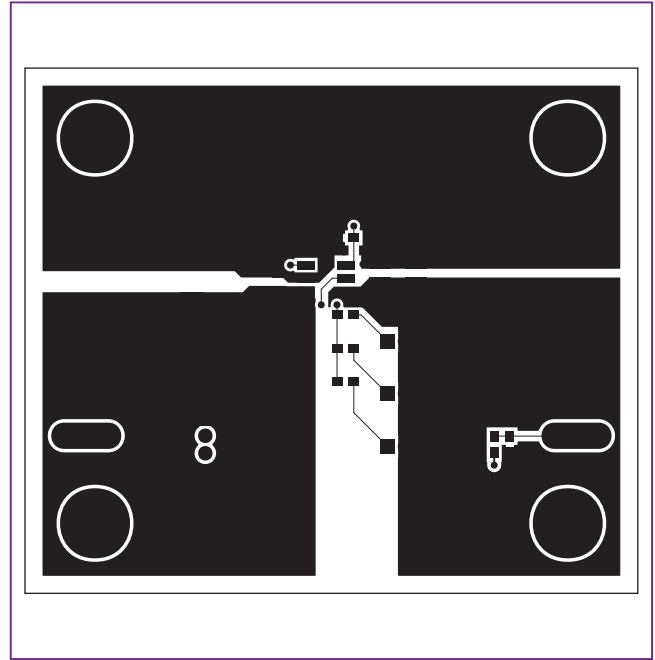

MAX17651 EV Kit PCB Layout—Top Layer

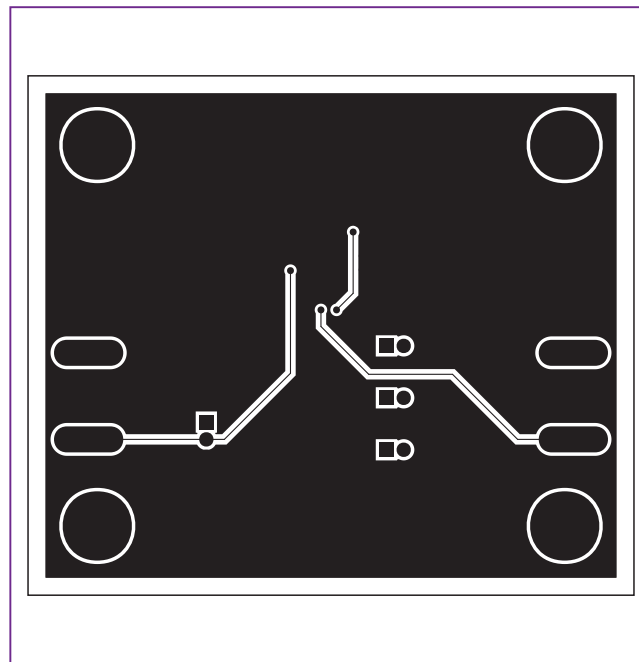

MAX17651 EV Kit PCB Layout—Bottom Layer

**MAX17651 EV Kit PCB Layout**

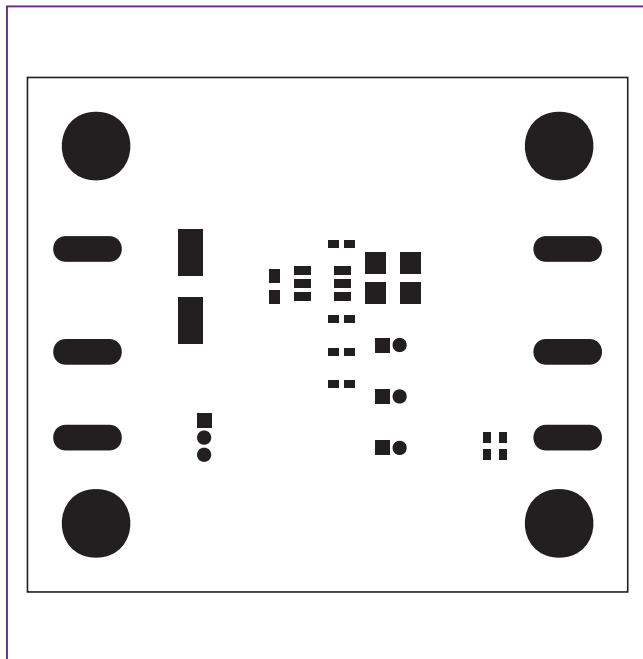

*MAX17651 EV Kit PCB Layout—Top Mask*

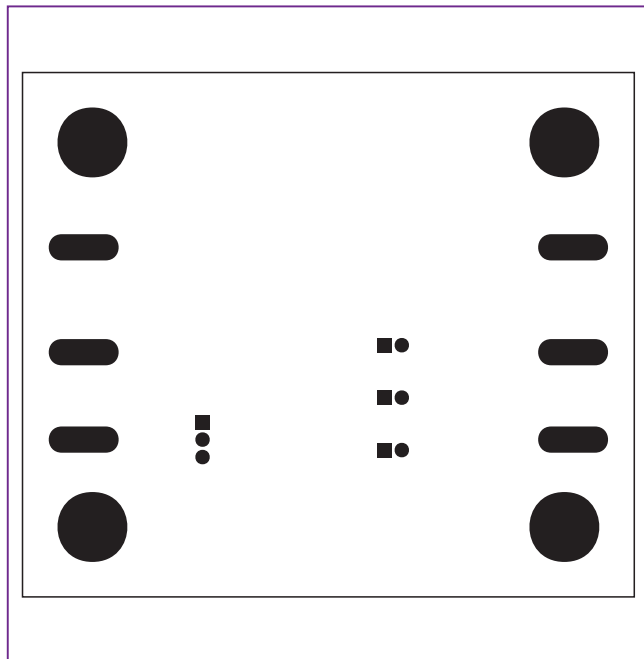

*MAX17651 EV Kit PCB Layout—Bottom Mask*



## Revision History

REVISION NUMBER	REVISION DATE	DESCRIPTION	PAGES CHANGED
0	2/16	Initial release	—
1	7/21	Updated <i>Available Output Current Calculation</i> section and Table 2; added Bill of Materials, Schematic, and PCB layout images	2, 5-8

For pricing, delivery, and ordering information, please contact Maxim Direct at 1-888-629-4642, or visit Maxim Integrated's website at [www.maximintegrated.com](http://www.maximintegrated.com).

*Maxim Integrated cannot assume responsibility for use of any circuitry other than circuitry entirely embodied in a Maxim Integrated product. No circuit patent licenses are implied. Maxim Integrated reserves the right to change the circuitry and specifications without notice at any time.*