

MAX17851 Evaluation Kit Datasheet

Evaluates: MAX17851

General Description

The MAX17851 evaluation kit (EV kit) is used to demonstrate the features and capabilities of the MAX17851 SPI to UART safety monitoring bridge. With communication established, control of the MAX17851 EV kit is executed through the EV kit graphical user interface (GUI) on the host PC. The GUI is Windows XP®, Windows Vista®, Windows® 7-, and Windows 10-compatible and is available through your local Maxim Integrated sales office.

The MAX17851 EV kit design provides a convenient platform for evaluating the features and functions of the IC, in addition to the IC's electrical parameters. The EV kit with vertical communication connectors enables the user to quickly build and evaluate the universal asynchronous receiver transmitter (UART) specially designed to interface with Maxim's battery management data acquisition system.

Benefits and Features

- Provides a Convenient Platform for Evaluating the Features and Functions of the MAX17851
- Versatile GUI Interface for Features Evaluation
- Plug-and-Play Architecture for Rapid System Prototyping
- Proven PCB Layout
- Fully Assembled and Tested

MAX17851 EV Kit Files

FILE	DESCRIPTION
MAX1785X_EV kit_Installer.exe	Software: Graphical User Interface (GUI)
MAX17851_DUAL_SAFEMON_EVKIT_C_MARKETING_SCH.pdf	Schematic File pdf
MAX17851_DUAL_SAFEMON_EVKIT_C_MARKETING_PCB.pdf	PCB Layout File pdf

Ordering Information appears at end of data sheet.

Windows, Windows XP, and Windows Vista are registered trademarks and registered service marks of Microsoft Corporation.

Quick Start (Single UART)

This procedure describes the setup and initialization of a MAX17851 module in a single-UART communication mode. The user may choose to use a different configuration depending on their requirements and testing needs.

Note: The MAX32625PICO# that is included in the MAX17851 EV kit package is not required for evaluation.

Required Hardware

- One MAX17851 EV kit (includes the MAX32620 interface board)
- User-supplied Windows XP-, Windows Vista-, Windows 7-, or Windows 10-compatible PC with a spare USB port

Note: In the following sections, software-related items are in bold. Text in **bold** refers to items directly from the EV kit software. Text in **bold and underlined** refers to items from the Windows operating system.

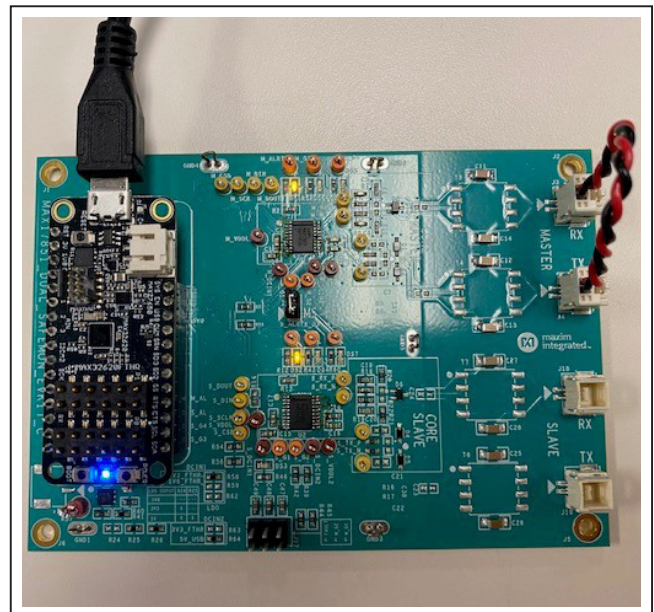

Figure 1. MAX17851 EV kit

Procedure

The MAX17851 EV kit is fully assembled and functionally tested prior to shipment. Follow the steps below to become acquainted with the MAX17851 EV kit and initialize the single-UART EV kit communication.

- 1) Install the MAX17851 EV kit software on your computer by running the MAX1785X_EV kit_Installer.exe.
- 2) Follow the on-screen instructions shown in the pop-up window in [Figure 2](#).

- 3) Click the **Install** button to confirm the installation of the MAX1785X GUI.
- 4) After a successful installation of the MAX1785X GUI, a window is displayed for the installation of the required **MINIQUSB** and **FTHR** drivers. Administrator privileges are required to install the USB device driver on Windows XP, Windows Vista, Windows 7, and Windows 10.
- 5) Click **Next** in the device driver installation wizard window.

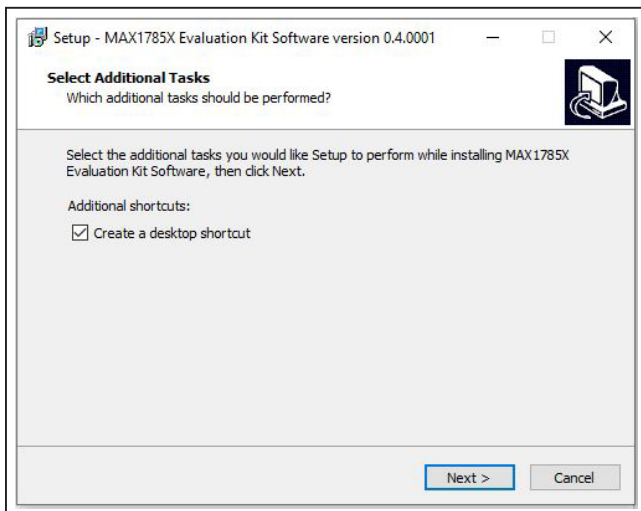

Figure 2. MAX17851 software installation

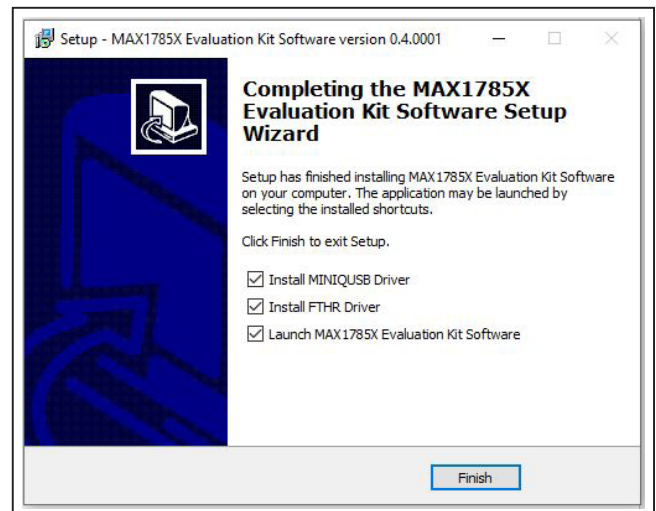

Figure 4. MAX17851 completed software installation

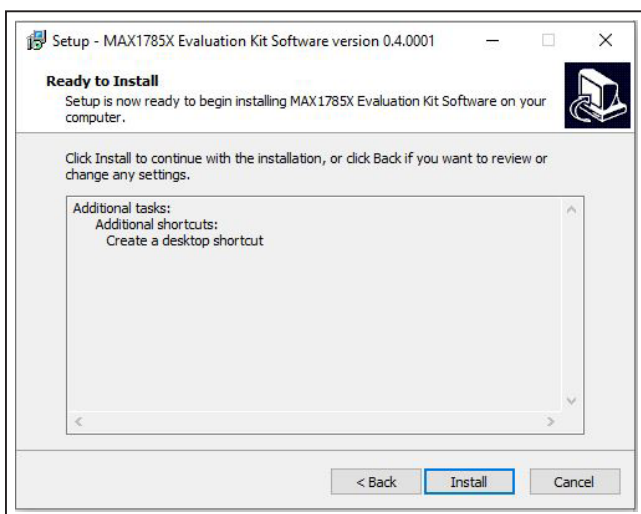

Figure 3. MAX17851 confirm software installation.

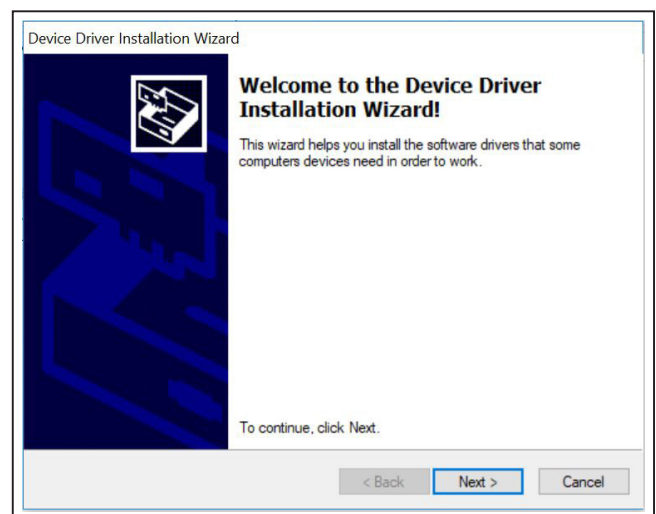

Figure 5. MAX17851 driver installation

- 6) Once the installation of the **MINIUSB** is completed, click **Finish**.
- 7) Click **Next** to confirm the installation of the **FTHR** driver.
- 8) Connect the MAX32620 to the J25 and J26 headers on the MAX17851 EV kit.
- 9) On the MAX17851 EV kit, connect the 2-wire red/black loopback cable from J3 to J4.
- 10) Start the MAX1785X EV KIT software by opening its icon in the Start Programs menu. Select the **MAX17853** target device and click **Confirm**.
- 11) The EV kit GUI software automatically establishes communication with the MAX32620 interface. The status bar at the bottom of the GUI displays **Maxim 32620 BMS USB to serial 00.01.xx and UART Not Initialized** (see [Figure 24](#)). With the MAX32620 detected, the user can proceed to the next step.
- 12) In the **Communication** tab ([Figure 24](#)), select the **MAX17851** radio button.
- 13) Click on the **Single-UART** radio button ([Figure 24](#)).
- 14) Select the **Initialization** tab ([Figure 25](#)).
- 15) Click the **WakeUp** button.

- 16) Verify that the communication is established with the MAX17851. The **Event Log** will read Wakeup successful.
- 17) The EV kit is now ready for further evaluation.

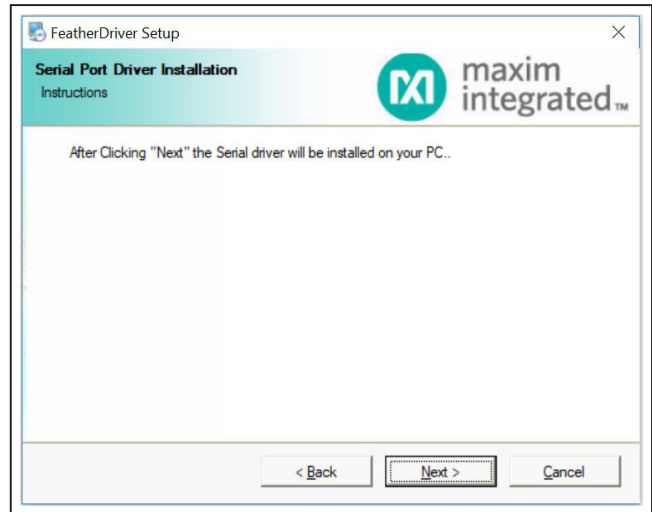

Figure 7. MAX17851 FTHR driver installation

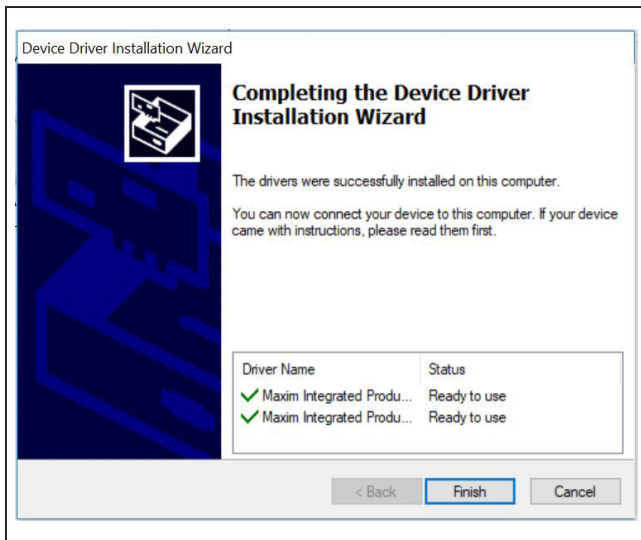

Figure 6. MAX17851 MINIUSB installation complete

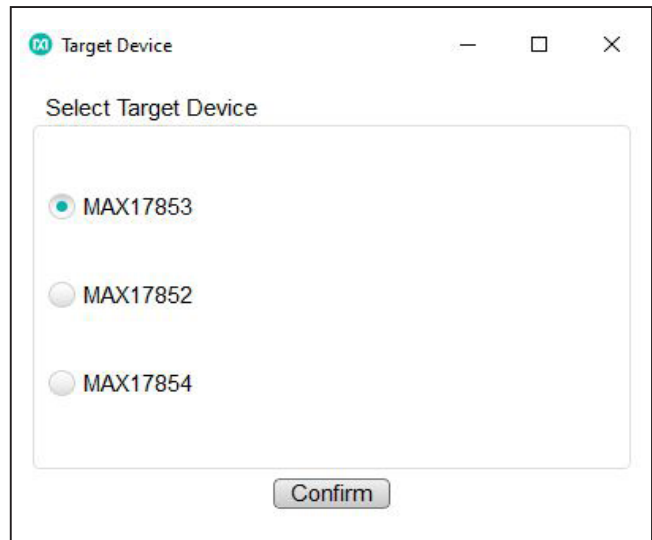

Figure 8. Target device

Evaluation Procedures

This section gives the user step-by-step procedures for functional evaluation of the MAX17851 using the GUI.

Commanded Operation

This procedure details the process for using the GUI to send and receive UART commands using the **Commanded Operation** tab.

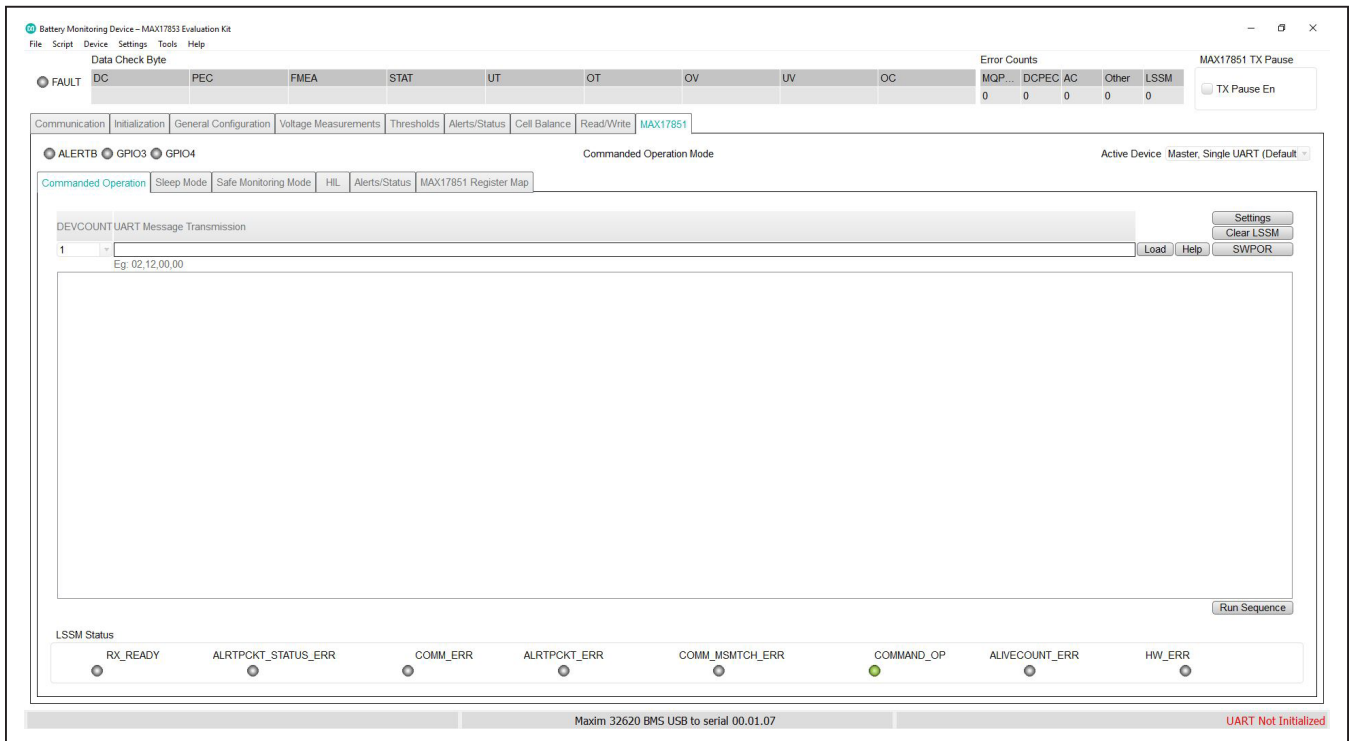

Figure 9. Commanded Operation tab

Procedure:

- 1) Set up hardware and run GUI according to the [Quick Start \(Single UART\)](#) section. **Wakeup Successful** must be displayed in the **Event Log** on the **Initialization** tab ([Figure 25](#)).
- 2) Select the **MAX17851** tab ([Figure 26](#)) and verify that the current mode is **Commanded Operation Mode**.
- 3) Select **1** from the **DEVCOUNT** drop-down menu.
- 4) Write **02,12,00,00** under the **UART Message Transmission** text box. This is a WRITEALL command to register **0x12** with data **0x0000**. Click the **Load** button to log the specified command onto the sequence log.
- 5) Observe that the GUI calculates the required length and PEC for the user.
- 6) Click the **Run Sequence** button to initiate the transmission of the UART commands.
- 7) The received message is displayed in the **Receive Buffer** field.

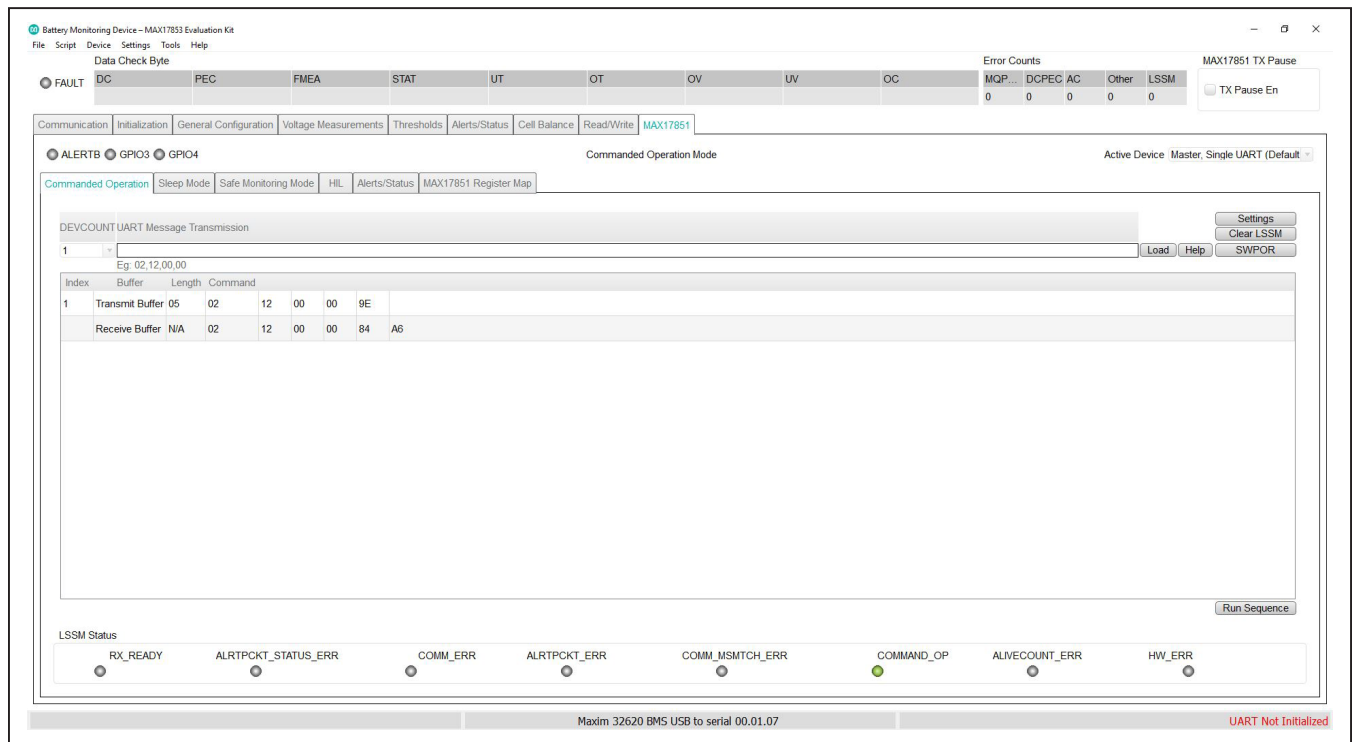

Figure 10. Commanded Operation run sequence

Sleep Mode

The following procedure describes how to use the GUI and EV kit to use the **Sleep Mode** feature of the MAX17851.

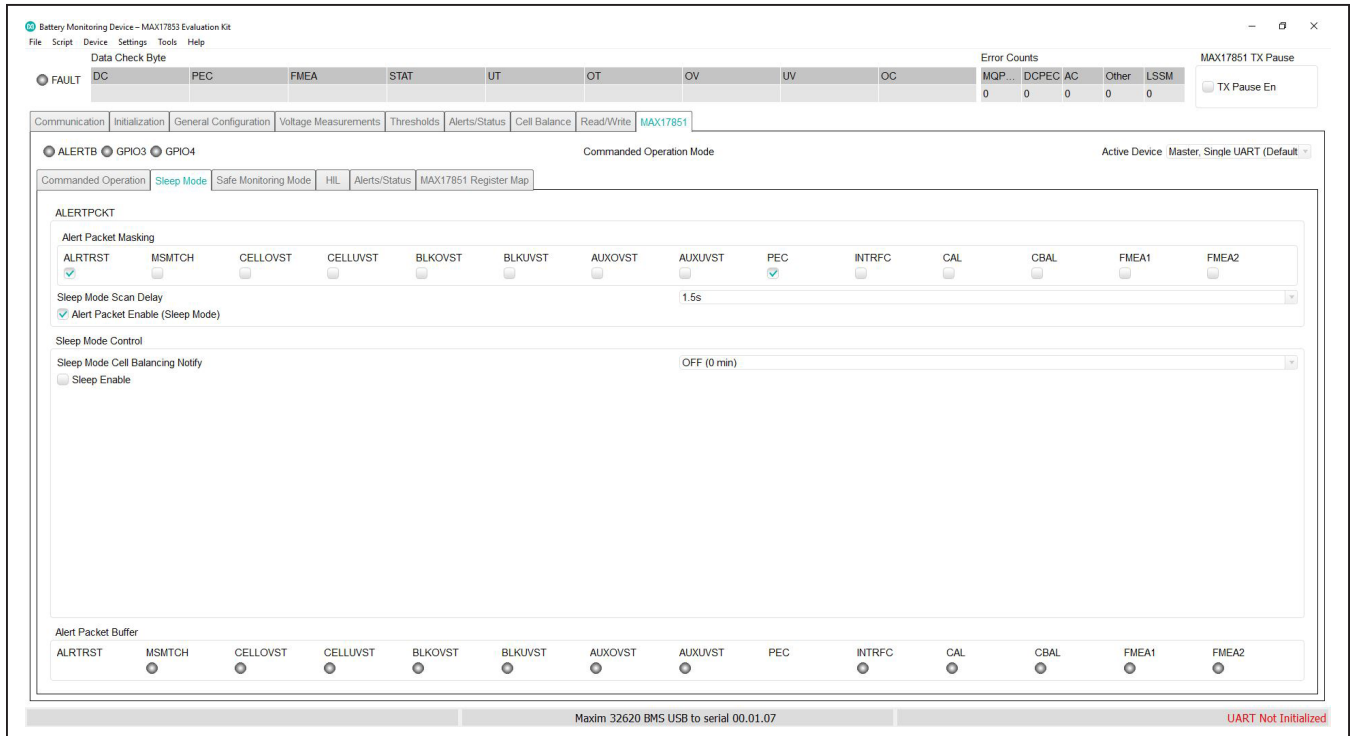

Figure 11. Sleep Mode tab

Procedure:

- 1) Set up hardware and run GUI according to the [Quick Start \(Single UART\)](#) section. **Wakeup Successful** must be displayed in the **Event Log** on the **Initialization** tab (Figure 25).
- 2) Select the **MAX17851** tab (Figure 26) and verify that the current mode is **Commanded Operation Mode**.
- 3) Select the **Alerts/Status** sub-tab (Figure 37) and then open the **Alert Enables** panel (Figure 38) by clicking the **Alert Enables** button. Click the **Set All** button for **OPSTATE ALRTEN** to command the MAX17851 to check when the device has woken up from sleep. Finally, click the **Update All Devices** button at the bottom and close the panel.
- 4) Select the **Sleep Mode** tab (Figure 11) and set the **Sleep Mode Cell Balancing Notify** to 30 min.
- 5) Click on the **Sleep Enable** checkbox and select the **No, Already Configured**. The MAX17851 will enter sleep mode without sending a default configuration to the daisy chain.
- 6) Observe at the top of the **Sleep Mode** tab that the **CBTIMER** increments. The current mode status displays **Sleep Mode**.
- 7) Upon expiration of the **CBTIMER**, select the **Alerts/Status** sub-tab (Figure 37) and observe that **SLP ALRT** is activated.
- 8) Select the **Sleep Mode** tab and observe the status at the top of the **Sleep Mode** tab. The MAX17851 exited **Sleep Mode** and returned to **Commanded Operational Mode**.

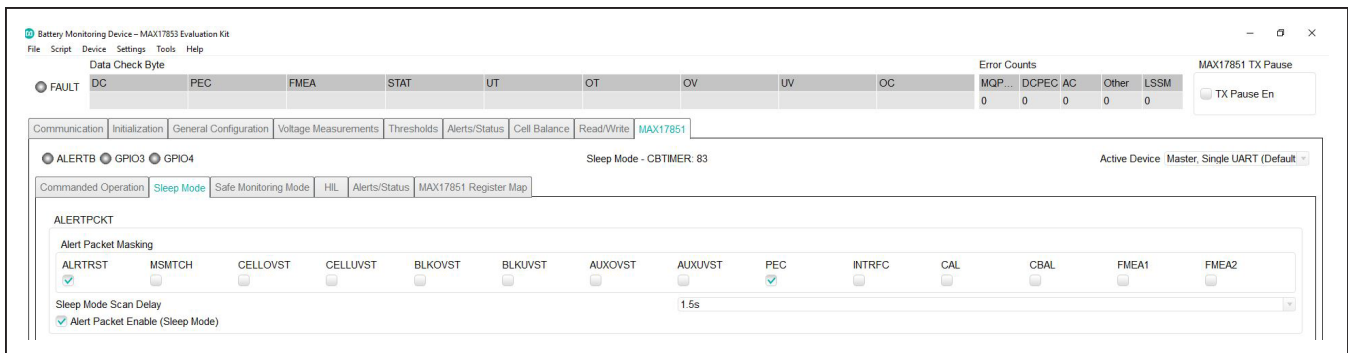

Figure 12. Sleep Mode default configuration

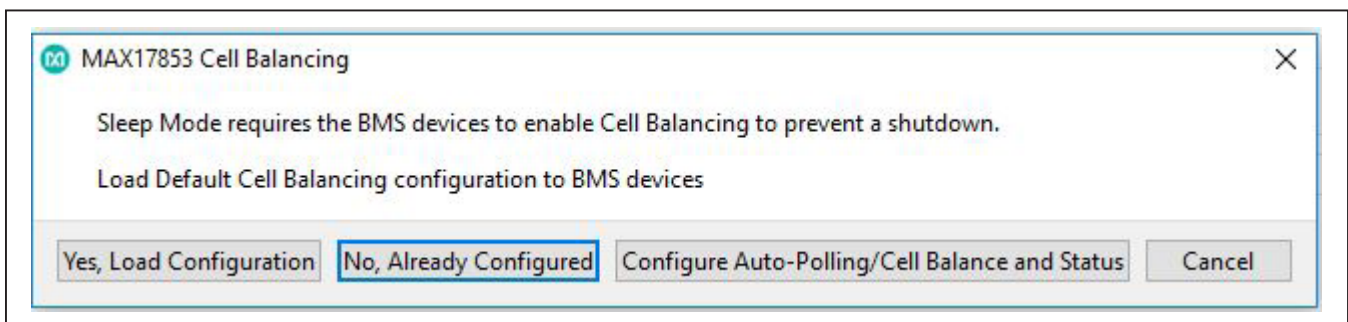

Figure 13. Sleep Mode CBTIMER

Safe Monitoring Mode

This procedure details the process for using the GUI to set up the MAX17851 watchdog and enter the **Safe Monitoring Mode**.

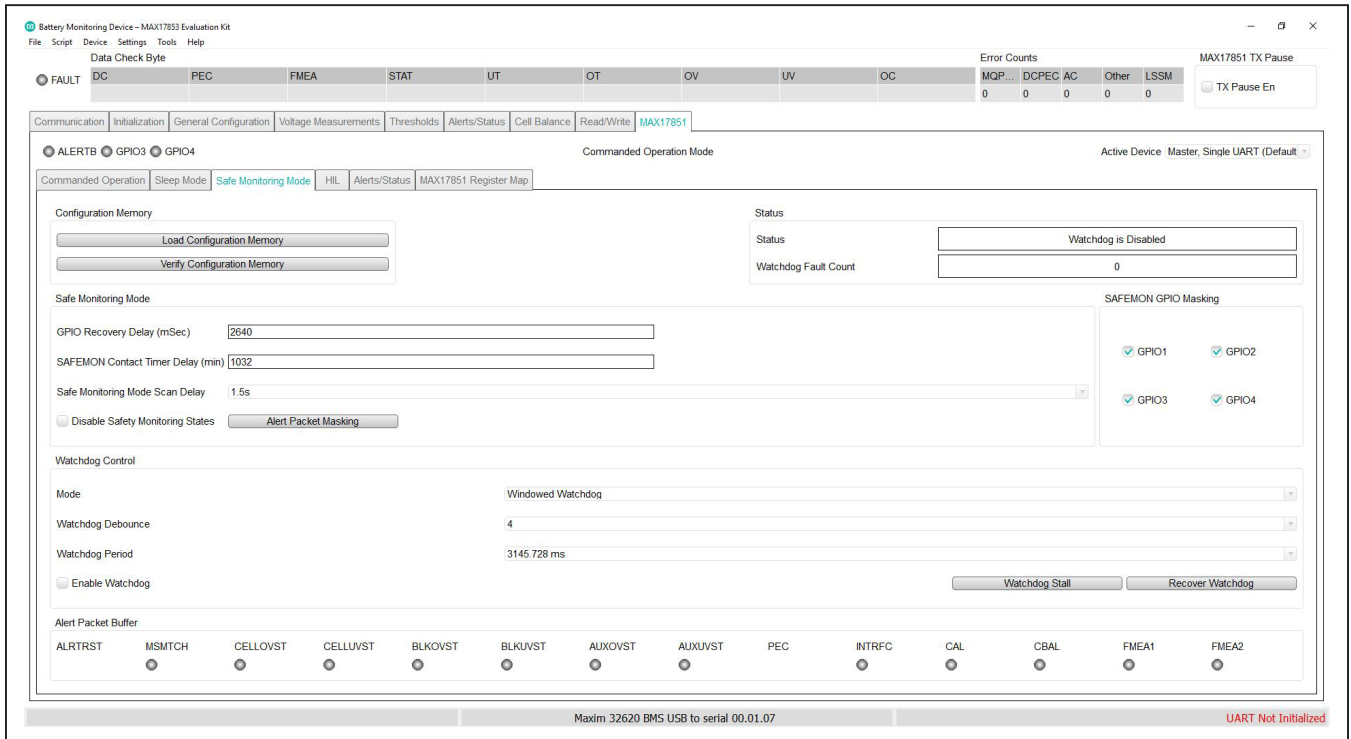

Figure 14. Safety Monitoring Mode tab

Procedure:

- 1) Set up the hardware and run the GUI according to the [Quick Start \(Single UART\)](#) section. **Wakeup Successful** must be displayed in the **Event Log** on the **Initialization** tab ([Figure 25](#)).
- 2) Select the **MAX17851** tab ([Figure 26](#)) and verify that the current mode is **Commanded Operation Mode**.
- 3) Select the **Alerts/Status** sub-tab ([Figure 37](#)) and then open the **Alert Enables** panel ([Figure 38](#)) by clicking the **Alert Enables** button. Click the **Set All** button for **OPSTATE ALRTEN** to command the MAX17851 to check when the device has entered **Safe Monitoring Mode**. Finally, click the **Update All Devices** button at the bottom and close the panel.
- 4) Select the **Safe Monitoring Mode** tab ([Figure 14](#)) and in the **Watchdog Control** group box, set the **Mode** to **Challenge/Response Watchdog**.
- 5) From the **Watchdog Debounce** drop-list, select **16**. This register controls the number of consecutive watchdog violations that must occur before entering **Safe Monitoring Mode**.
- 6) Select the **Watchdog Period** drop-down list and click on **1474.56 ms** to set the watchdog time base.
- 7) Click on the **Enable Watchdog** checkbox and observe at the top of the **Safe Monitoring Mode** tab that the **Status** displays **Watchdog is Enabled**. At this point, the MAX17851 is continuously verifying the MAX32620 operation by communicating via the SPI interface at a fixed interval.
- 8) Use the **Watchdog Stall** button to disable the MAX32620 watchdog and allow the MAX17851 to enter **Safe Monitoring Mode**. Observe that the **Watchdog Fault Count** starts to increment. Once the **Watchdog Fault Count** reaches the **Watchdog Debounce**, the MAX17851 will enter **Safe Monitoring Mode**.
- 9) Observe at the top of the **Safe Monitoring Mode** tab that the current mode status displays **BMS Safe Monitoring Mode**.
- 10) Select the **Alerts/Status** sub-tab and observe that alerts **SAFEMON** and **WD ERR** are activated.
- 11) In the **Safe Monitoring Mode** tab use the **Recover Watchdog** button to exit **Safe Monitoring Mode**. Observe in the **Status** group box that the MAX17851 has exited **BMS Safe Monitoring Mode** and returned to **Commanded Operational Mode**.

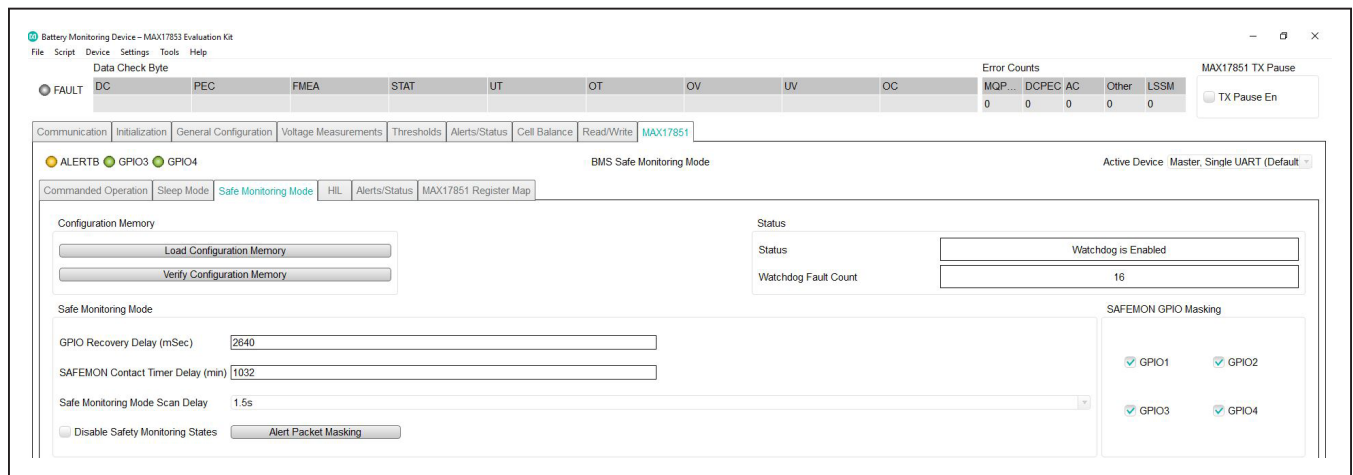

Figure 15. Safety Monitoring Mode status

Safe Monitoring GPIO Operation

The following procedure demonstrates the use of GPIO 1 and 2 in **Safe Monitoring Mode** to provide a signal to open the BMS system HV contactors and prevent hazardous conditions.

Procedure:

- 1) Set up hardware and run GUI according to the [Quick Start \(Single UART\)](#) section. **Wakeup Successful** must be displayed in the **Event Log** on the **Initialization** tab ([Figure 25](#)).
- 2) Select the **MAX17851** tab ([Figure 26](#)) and verify that the current mode is **Commanded Operation Mode**.
- 3) Disconnect the 2-wire red/black loopback cable from J3 and J4.
- 4) Open the **Settings** panel ([Figure 27](#)) by clicking the **Settings** button. In the **GPIO Configuration** group box, set GPIOs 1 and 2 to **SAFEMON Active HI Output**. Click the **Confirm Settings** button at the bottom and close the panel.
- 5) Select the **Alerts/Status** sub-tab ([Figure 37](#)) and then open the **Alert Enables** panel ([Figure 38](#)) by clicking the **Alert Enables** button. Click the **Set All** button for **OPSTATE ALRTEN** to command the MAX17851 to check when the device has asserted GPIO1/2. Finally, click the **Update All Devices** button at the bottom and close the panel.
- 6) Select the **Safe Monitoring Mode** tab ([Figure 14](#)) and in the **Safe Monitoring Mode** group box, set the

- 7) In the **Watchdog Control** group box, set the **Mode** to **Challenge/Response Watchdog**.
- 8) From the **Watchdog Debounce** drop-list, select **1**. This register controls the number of consecutive watchdog violations that must occur before entering **Safe Monitoring Mode**.
- 9) Select the **Watchdog Period** drop-down list and click on **6.144 ms** to set the watchdog time base.
- 10) Click on the **Enable Watchdog** checkbox and observe at the top of the **Safe Monitoring Mode** tab that the **Status** displays **Watchdog is Enabled**. At this point, the MAX17851 is continuously verifying the MAX32620 operation by communicating via the SPI interface at a fixed interval.
- 11) Use the **Watchdog Stall** button to disable the MAX32620 watchdog and allow the MAX17851 to enter **Safe Monitoring Mode**. Observe that the **Watchdog Fault Count** starts to increment. Once the **Watchdog Fault Count** reaches the **Watchdog Debounce**, the MAX17851 will enter **Safe Monitoring Mode**.
- 12) Observe that the current mode status displays **BMS Safe Monitoring Mode**.
- 13) Once the **SAFEMON Contact Timer Delay** exceeds the configured time verify that the **FAULT** alert located at the upper left corner of the GUI is activated.

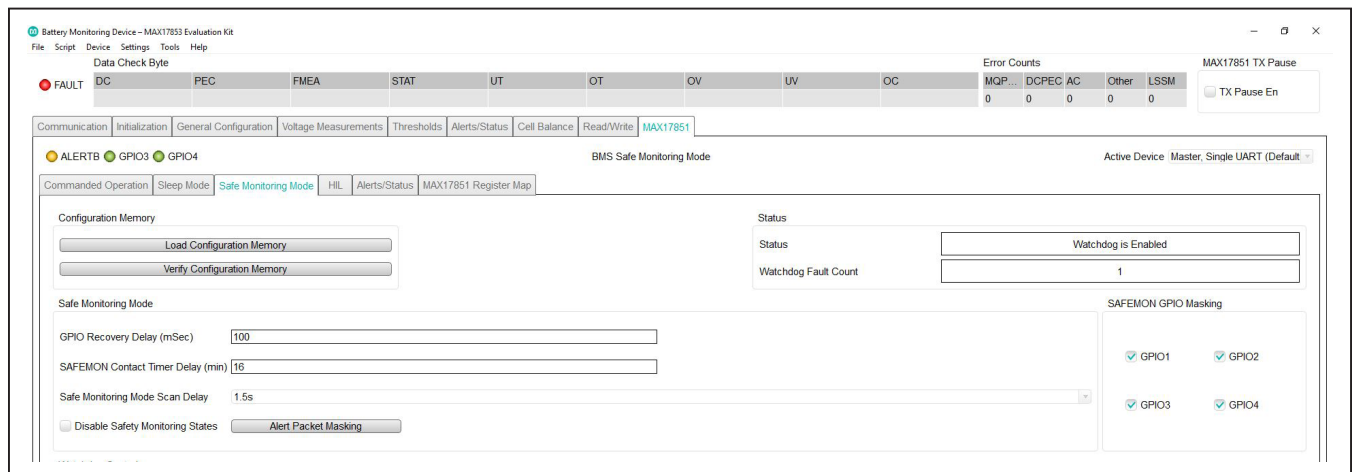

Figure 16. Watchdog Fault Count

- 14) Verify the assertion of the Fault alert (DS3) on the MAX17851 EV kit.
- 15) Select the **Alerts/Status** sub-tab and observe that alert **SM GPIO12** is activated.
- 16) Use the **Watchdog Recover** button to exit **Safe Monitoring Mode**. Observe that the MAX17851 has exited **BMS Safe Monitoring Mode** and returned to **Commanded Operational Mode**.

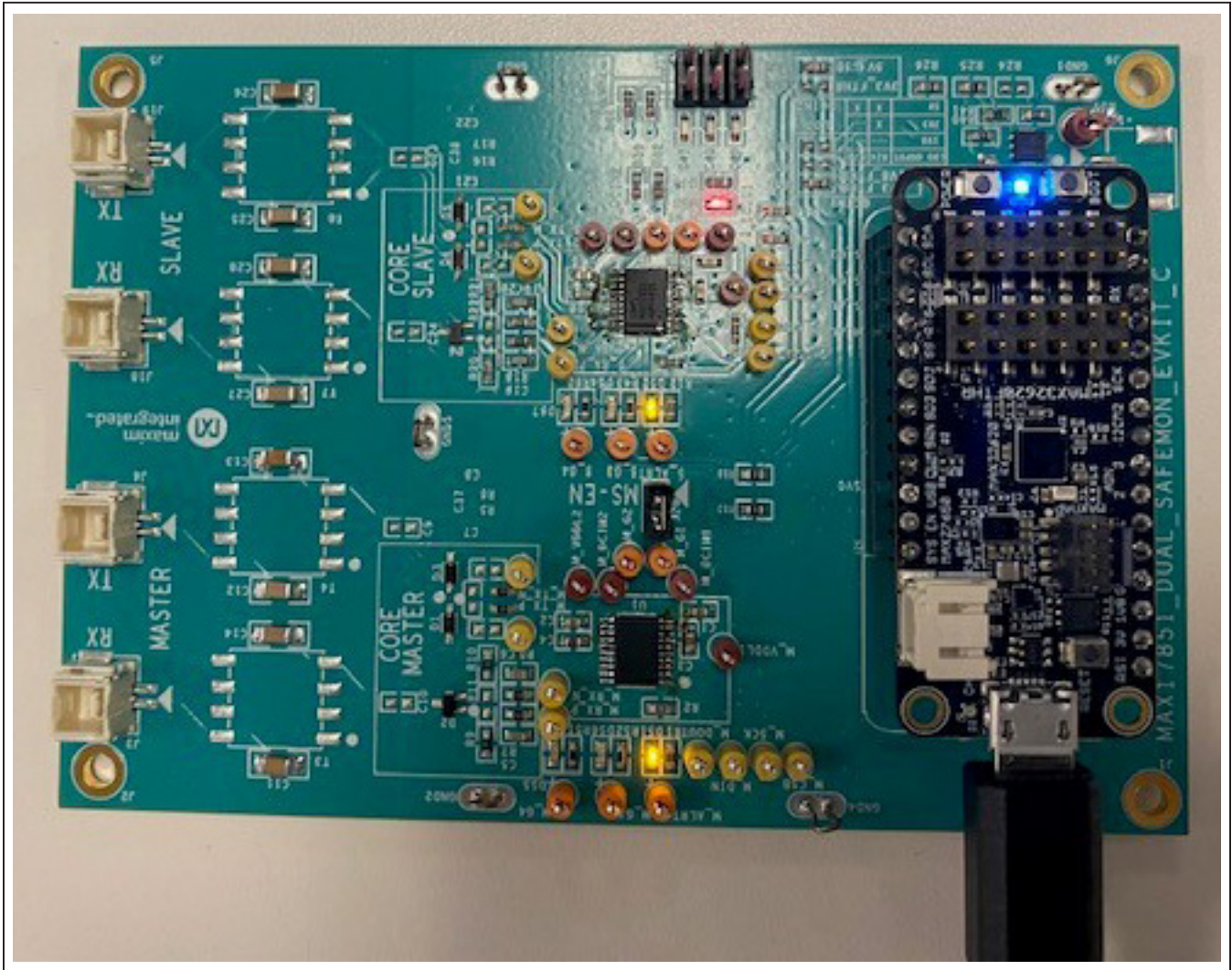

Figure 17. MAX17851 FAULT LED

Configuration Memory

This procedure details a simple process for using the GUI to set up and run the **Configuration Memory** feature of the MAX17851.

Procedure:

- 1) Set up hardware and run GUI according to the [Quick Start \(Single UART\)](#) section. **Wakeup Successful** must be displayed in the **Event Log** on the **Initialization** tab ([Figure 25](#)).
- 2) Select the MAX17851 tab ([Figure 26](#)) and verify that the current mode is **Commanded Operation Mode**.
- 3) Open the **Settings** panel ([Figure 27](#)) by clicking the **Settings** button. Set the **Alert Packet/Keep Alive Timing** drop-down list to **Infinite delay/disabled**. Click the **Confirm Settings** button at the bottom and close the panel.
- 4) Select the **Alerts/Status** sub-tab ([Figure 37](#)) and then open the **Alert Enables** panel ([Figure 38](#)) by clicking the **Alert Enables** button. Click the **Set All** button for **OPSTATE ALRTEN** and **GEN ALRTEN** to command the MAX17851 to check if it has encountered a configuration memory error. Finally, click the **Update All Devices** button at the bottom and close the panel.
- 5) Select the **Safe Monitoring Mode** tab ([Figure 14](#)) and in the **Configuration Memory** group box, click the **Load Configuration Memory** button.
- 6) In the **Configuration Memory** panel, set the two **Register Address (Hex)** of **Configuration Block 0** to **0x65**. In the **Data (Hex)** box write **0x000F**. The contents written to the **Data (Hex)** will be effectively transmitted to the registers added on **Register Address (Hex)** once **Safe Monitoring Mode** is entered. Lastly, click the **Confirm Configuration** button at the bottom and close the panel.
- 7) Back in the **Safe Monitoring Mode** tab, click on the **Verify Configuration Memory** button. This command will verify the contents of the configuration memory and report a **DATAPATH ERR** alert if it encounters any errors.
- 8) Select the **Alerts/Status** sub-tab and observe that alert **DATAPATH ERR** is not activated.
- 9) Connect an oscilloscope to M_TX_P and set it to normal trigger on rising edge.
- 10) In the **Safe Monitoring Mode** tab, click on the **Enable Watchdog** checkbox and verify at the top of the **Safe Monitoring Mode** tab that the **Status** displays **Watchdog is Enabled**.
- 11) Use the **Watchdog Stall** button to disable the MAX32620 watchdog and allow the MAX17851 to enter **Safe Monitoring Mode**.
- 12) Observe that the current mode status displays **BMS Safe Monitoring Mode**.
- 13) Verify with an oscilloscope that the **Configuration Memory** packet was transmitted at the transition to **Safe Monitoring Mode**.
- 14) Use the **Recover Watchdog** button to exit **Safe Monitoring Mode**. Observe that the MAX17851 has exited **BMS Safe Monitoring Mode** and returned to **Commanded Operational Mode**.

Hardware-In-The-Loop (HIL)

This procedure details a simple process for using the GUI to set up and run the **Hardware-In-The-Loop** feature of the MAX17851.

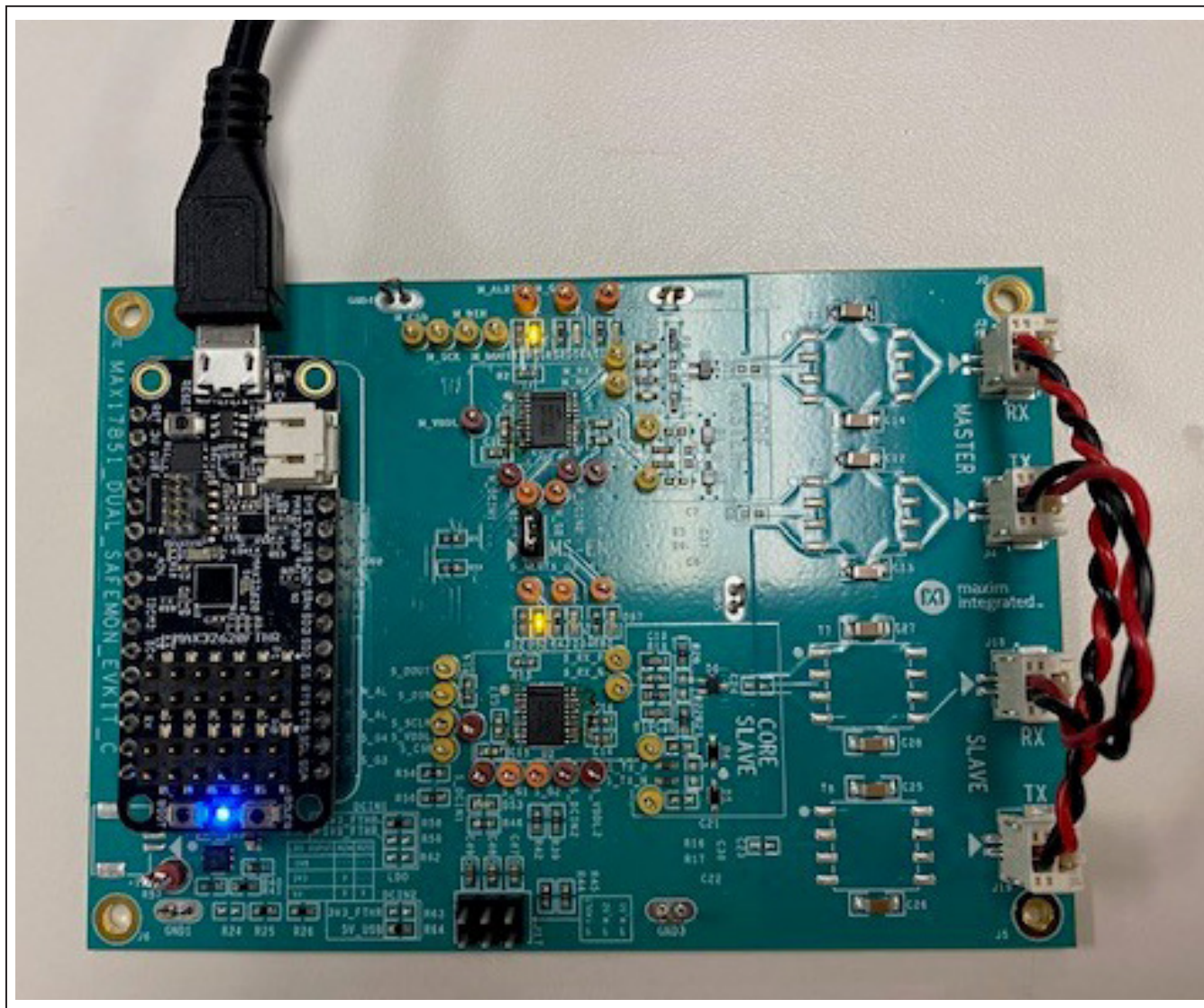

Figure 18. MAX17851 Hardware-In-The-Loop configuration

Procedure:

- 1) Run the GUI according to the [Quick Start \(Single UART\)](#) section.
- 2) On the MAX17851 EV kit, connect one 2-wire red/black loopback cable from J3 to J19.
- 3) Connect one 2-wire red/black loopback cable from J4 to J18.
- 4) Select the **MAX17851** tab ([Figure 26](#)) and verify that the current mode is **Commanded Operation Mode**.
- 5) Select the **HIL** tab ([Figure 19](#)) and set the **DEV-COUNT** drop-down list to **1**. This is the number of simulated devices.
- 6) Click on the **Add UART Command** button and observe the **UART Command Sequence** be populated with an empty sequence. Populate the fields next to **Transmit Buffer** as [Figure 19](#). The UART command **06,03,00,00,58** will be loaded to the Master once the sequence begins.
- 7) Under the **Simulated Command** text box, write the following command: **C0,06,03,FF,25,85,00,94**. Press **Add** to log the specified command onto the simulated sequence log. The simulated UART command will be loaded to the Slave device. Observe that the simulated UART command contains a different register address than the loaded command under the **UART Command Sequence**. This effectively simulates a corrupt register address that causes an LSSM error.
- 8) Select the **Run Sequence** button to initiate the HIL sequence.
- 9) Observe that the **LSSM** LED is on under the **UART Command Sequence**. The data that the Master received is displayed next to the **Receive Buffer** field. At this point, the user can compare the data that was sent to the data that was received.

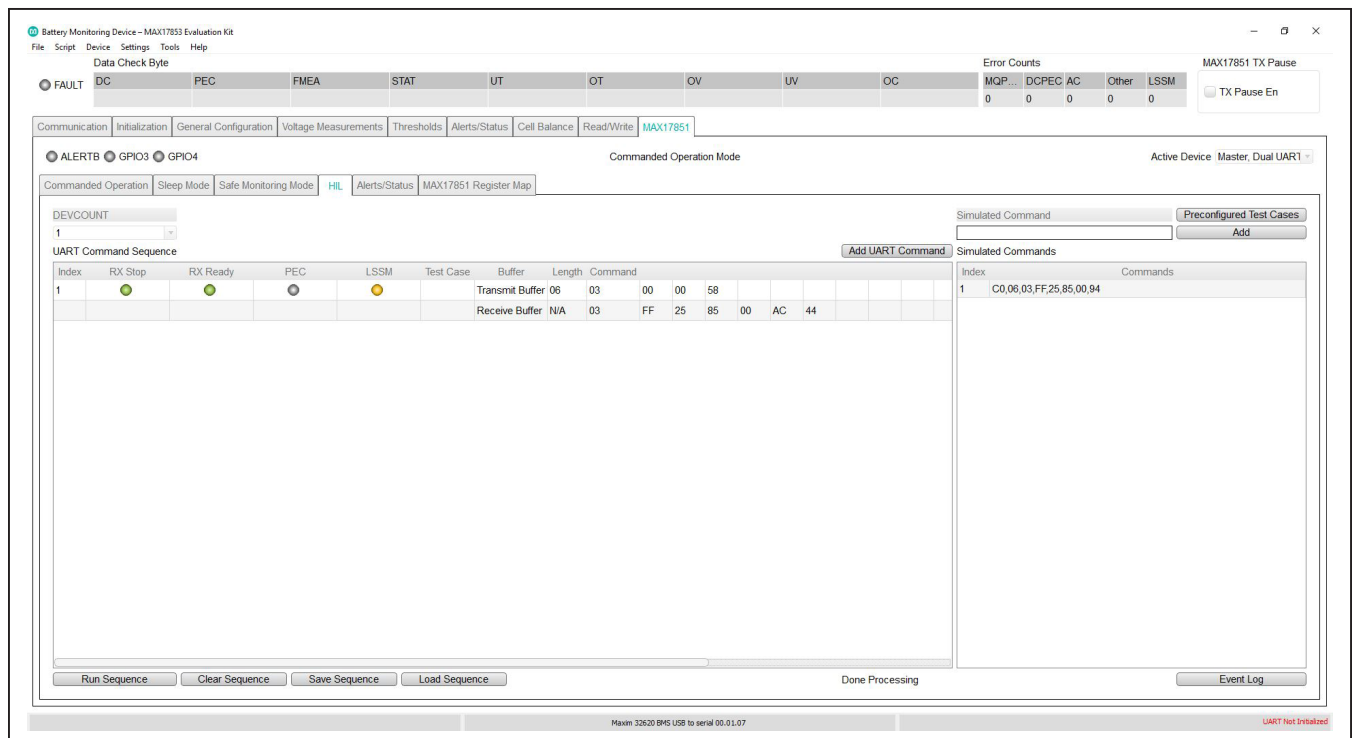

Figure 19. HIL run sequence

- 10) Click on the **Event Log** button located at the bottom right side of the **HIL** tab. In the **HIL Event Log** panel (Figure 20), observe the **LSSM** faults that were simulated.
- 11) Back in the **HIL** tab, click on **Save Sequence** to save the sequence log for future use.
- 12) Once the pop-up window appears, enter the desired file path where the sequence will be saved. After the file path has been entered click **OK** to confirm. The sequence will be saved in a standard .cvs format.

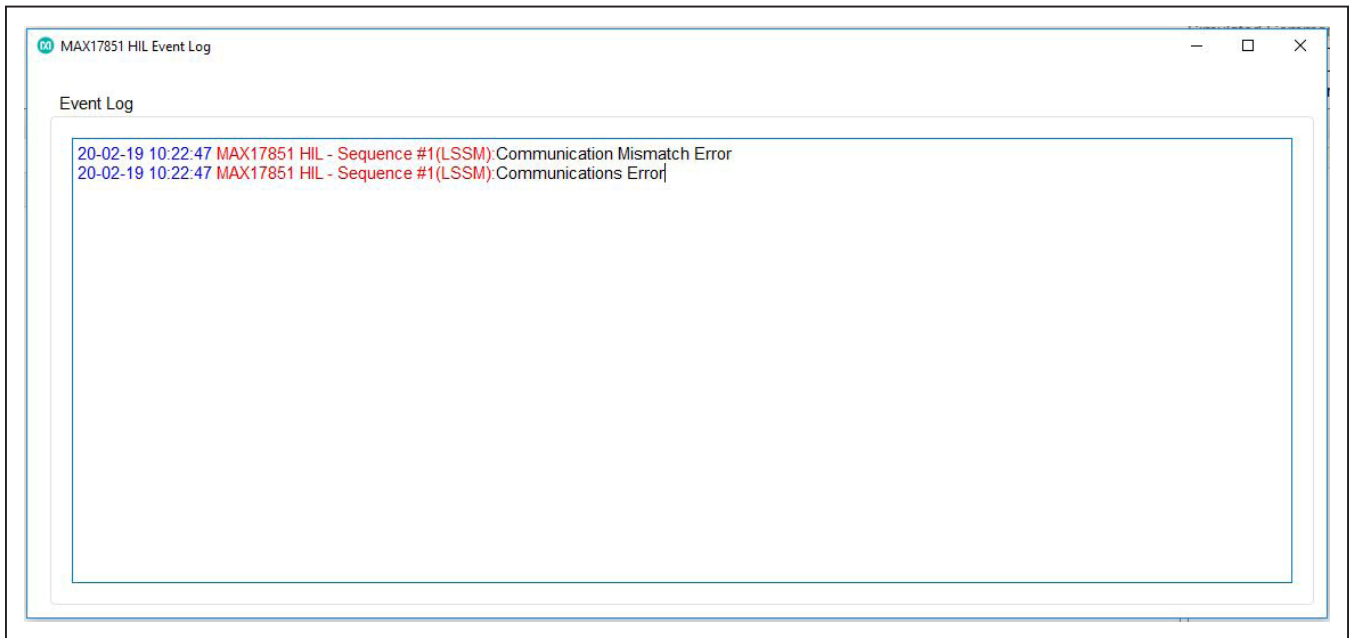

Figure 20. HIL event log

Hardware-In-The-Loop (HIL) Preconfigured Test Cases

This procedure details a simple process for using the GUI to set up and run the Hardware-In-The-Loop Preconfigured Test Cases feature of the MAX17851.

Procedure:

- 1) Run the GUI according to the [Quick Start \(Single UART\)](#) section.
- 2) On the MAX17851 EV kit, connect one 2-wire red/black loopback cable from J3 to J19.
- 3) Connect one 2-wire red/black loopback cable from J4 to J18.
- 4) Select the **MAX17851** tab (Figure 26) and verify that the current mode is **Commanded Operation Mode**.
- 5) Select the **HIL** tab (Figure 19) and set the **DEV-COUNT** drop-down list to **1**. This is the number of simulated devices.
- 6) Click on the **Preconfigured Test Cases** button. In the **HIL Preconfigured Test Cases** panel (Figure 36), select the **Corrupt Register Address** and **Datacheck Error** checkboxes. Press the **Add Selected Cases** button to populate the **UART Command Sequence** and the **Simulated Commands**.
- 7) Observe that the **UART Commanded Sequence** data being loaded to the Master MAX17851 is a valid UART command. Under the **Simulated Commands** observe that the first command has a different register address than the one that will be sent by the Master. The second command has a Data Check byte with a status fault. Both commands will be sent sequentially to the Master once the Slave receives a valid preamble.
- 8) Select the **Run Sequence** button to initiate the HIL sequence.
- 9) Observe that the **LSSM** LED is on in the first UART command under the **UART Command Sequence**. The data that the Master received is displayed next to the **Receive Buffer** field. At this point, the user can compare the data that was sent to the data that was received.
- 10) Click on the **Event Log** button located at the bottom right side of the **HIL** tab. In the **HIL Event Log** panel (Figure 22), observe the **LSSM** and **Data Check** byte faults that were simulated.

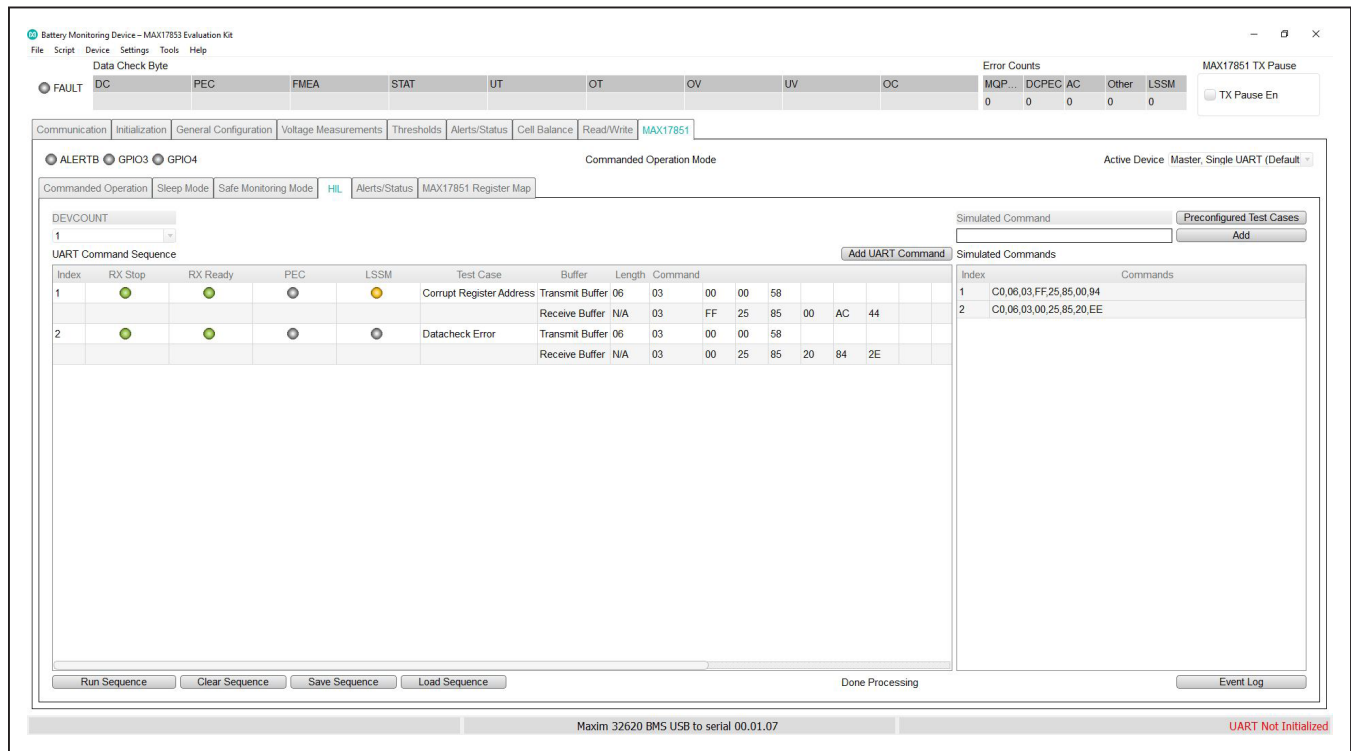

Figure 21. HIL run sequence



Figure 22. HIL event log

Dual UART Operation

This procedure describes the setup and initialization of a MAX17851 module in a dual-UART communication mode.

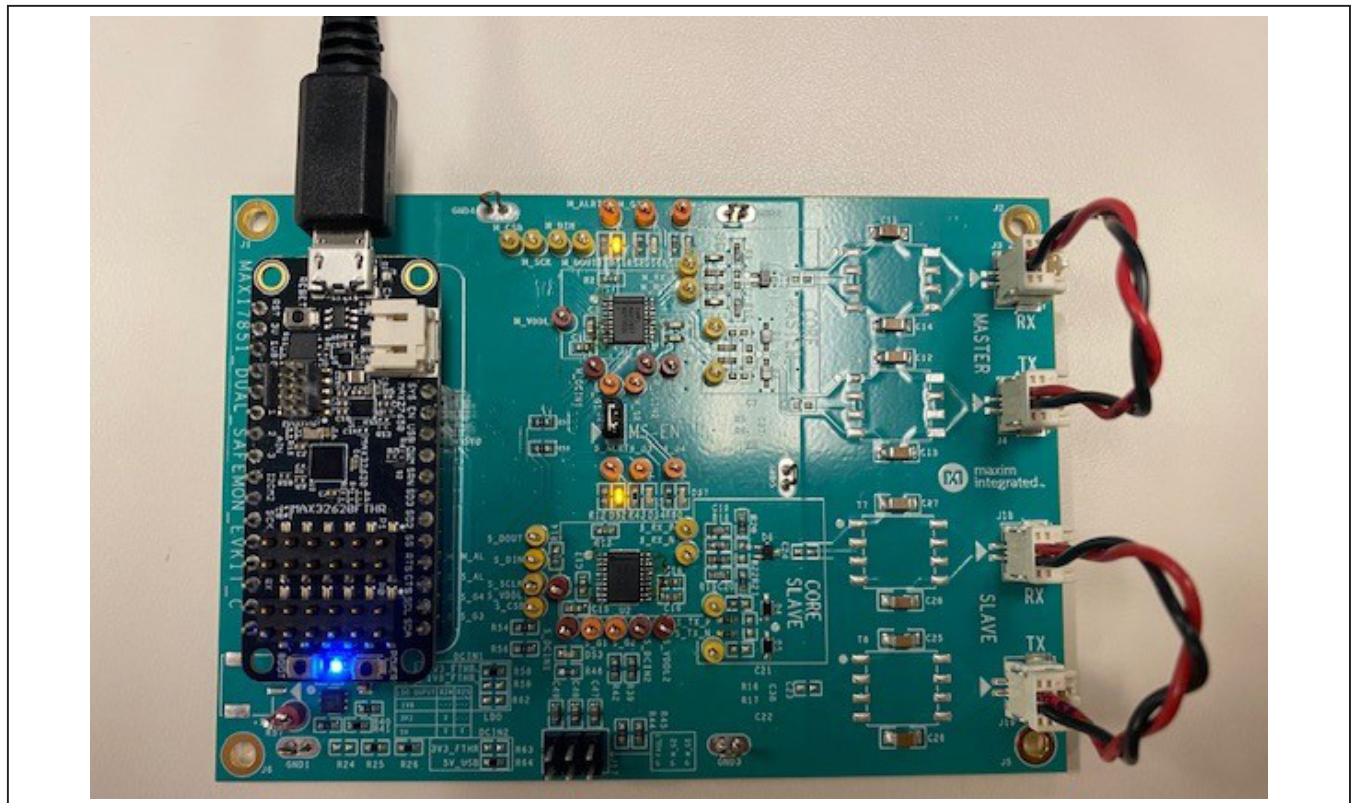

Figure 23. Dual UART configuration

Procedure:

- 1) Connect the MAX32620 to the J25 and J26 headers on the MAX17851 EV kit.
- 2) On the MAX17851 EV kit, connect the 2-wire red/black loopback cable from J3 to J4.
- 3) Connect the 2-wire red/black loopback cable from J18 to J19.
- 4) Start the MAX1785X EV KIT software by opening its icon in the Start Programs menu. The EV kit GUI software automatically establishes communication with the MAX32620 interface. The status bar at the bottom of the GUI displays **Maxim 32620 BMS USB to serial 00.01.xx and UART Not Initialized** (see [Figure 24](#)). With the MAX32620 detected, the user can proceed to the next step.
- 5) In the **Communication** tab ([Figure 24](#)), select the **MAX17851** radio button.
- 6) Click on the **Dual UART Interface** radio button ([Figure 24](#)).
- 7) Select the **Initialization** tab ([Figure 25](#)).
- 8) Click the **Wakeup** button.
- 9) Verify that the communication is established with the MAX17851. The **Event Log** will read Wakeup successful.
- 10) Select the **MAX17851** tab ([Figure 26](#)) and verify that the current mode is **Commanded Operation Mode**.
- 11) Open the **Settings** panel ([Figure 27](#)) by clicking the **Settings** button. Ensure that the **Active Device** drop-down menu displays **Master, Dual UART**. In the **GPIO Configuration** group box, set GPIOs 1 and 2 to **SAFEMON Active HI Output**. Set **GPIO3** to **SAFEMON Active HI Output** and **GPIO4** to **SAFEMON 1-Shot LO Output**. Click the **Confirm Settings** button at the bottom.
- 12) Open the **Settings** panel ([Figure 27](#)) by clicking the **Settings** button. Click on the **Active Device** drop-down menu and select **Slave, Dual UART**. In the **GPIO Configuration** group box, set GPIOs 1 and 2 to **SAFEMON Active HI Output**. Set **GPIO3** to **SAFEMON 1-Shot LO Output** and **GPIO4** to **SAFEMON Slave Input**. Click the **Confirm Settings** button at the bottom and close the panel.
- 13) Back in the **Commanded Operation** tab, click on the **Active Device** drop-down menu located at the upper right corner of the tab and select **Master, Dual UART**.
- 14) Select the **Safe Monitoring Mode** tab ([Figure 30](#)) and in the **Safe Monitoring Mode** group box, set the **SAFEMON Contact Timer Delay (min)** to **16 min**.

The **SAFEMON Contact Timer Delay (min)** will assert GPIO 1 and 2 at the expiration of the timer.
- 15) Set the **GPIO Recovery Delay (mSec)** to **100 ms**. The **GPIO Recovery Delay** will assert GPIO 3 or 4 for the duration of the timer. This provides a reset signal to the system via the GPIOs which reset the microcontroller and/or power supply network.
- 16) In the **Watchdog Control** group box, set the **Mode** to **Challenge/Response Watchdog**.
- 17) From the **Watchdog Debounce** drop-list, select **1**. This register controls the number of consecutive watchdog violations that must occur before entering **Safe Monitoring Mode**.
- 18) Select the **Watchdog Period** drop-down list and click on **6.144 ms** to set the watchdog time base.
- 19) Click on the **Enable Watchdog** checkbox and observe at the top of the **Safe Monitoring Mode** tab that the **Status** displays **Watchdog is Enabled**. At this point, the MAX17851 is continuously verifying the MAX32620 operation by communicating via the SPI interface at a fixed interval.
- 20) On the MAX17851 EV kit, disconnect the 2-wire red/black loopback cable from J3 to J4.
- 21) Use the **Watchdog Stall** button to disable the MAX32620 watchdog and allow the MAX17851 to enter **Safe Monitoring Mode**. Observe that the **Watchdog Fault Count** starts to increment. Once the **Watchdog Fault Count** reaches the **Watchdog Debounce**, the MAX17851 will enter **Safe Monitoring Mode**.
- 22) Following the assertion of GPIO4 of the Slave, a **DOWNHOST** command will trigger and assume control of the BMS Safety Monitoring.
- 23) Verify the assertion of the GPIO3 LED (DS4) of the Slave and the GPIO4 LED (DS5) of the Master on the MAX17851 EV kit.
- 24) Click on the **Active Device** drop-down menu located at the upper-right corner of the tab and select **Slave, Dual UART**.
- 25) Observe that the current state of the Slave device is **BMS Safety Monitoring**. At this point, the Slave device has assumed control of the BMS Safety Monitoring State.
- 26) In the **Commanded Operation** tab use the **SWPOR** button to completely reset the MAX17851 and exit **Safe Monitoring Mode**.
- 27) Click on the **Active Device** drop-down menu located at the upper-right corner of the tab and select **Master, Dual UART**. Click the **SWPOR** button to reset the Master device.

MAX17851 Graphical User Interface

The MAX17851 EV kit is evaluated in conjunction with the MAX1785X evaluation software. The graphical user interface (GUI) provides a friendly environment for reading and writing to all device registers, as well as executing device commands.

Communication Tab

The GUI startup cockpit is designed to guide the user through hardware setup and provides overall startup system information. At startup, the GUI automatically initializes

and establishes communication with the MAX32620 interface board and places the user on the **Communication** tab (see [Figure 24](#)). UART status is shown in the lower-right corner of the cockpit.

The GUI is preset to UART communication with a dual UART interface (see [Figure 24](#)). When selecting the UART configuration, the hardware graphic updates to reflect the proper wiring interface for the selected UART. To enable the **MAX17851** tab, the user must select the **MAX17851** radio button.

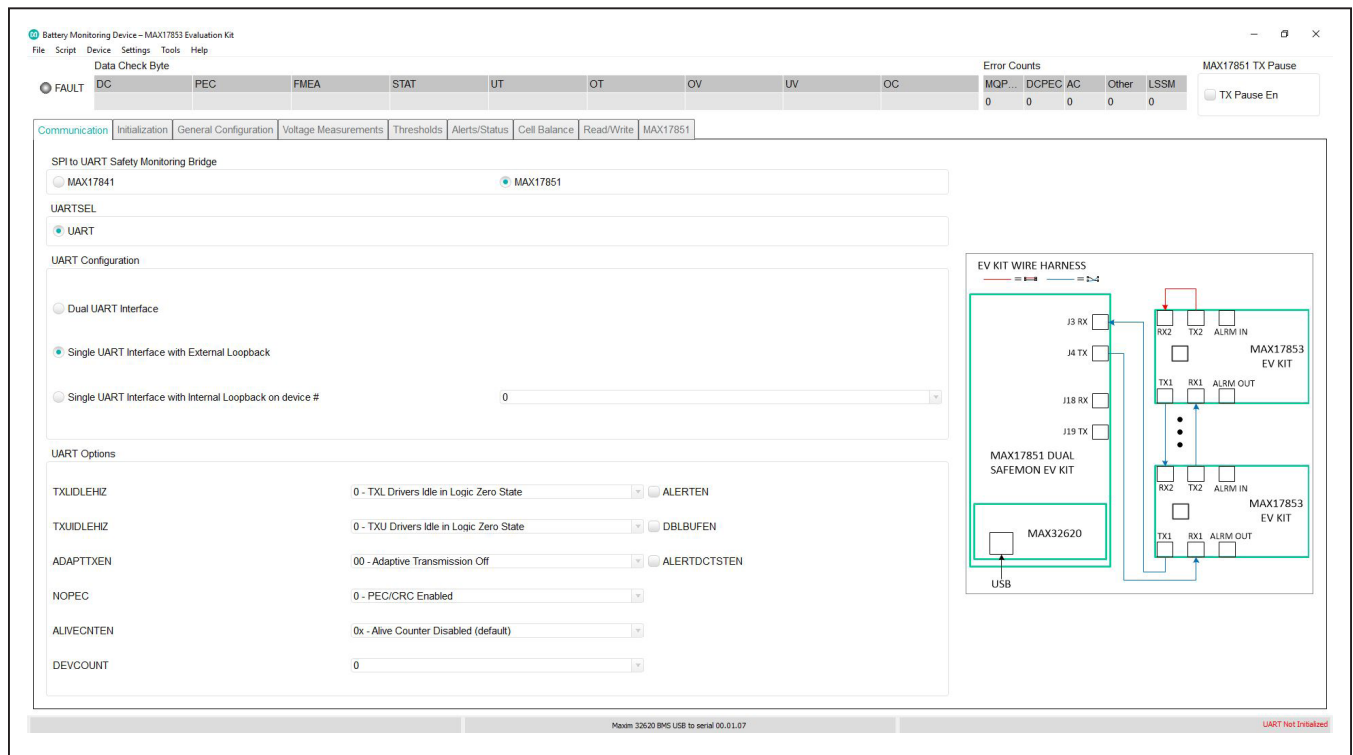

Figure 24. Communication tab

Initialization Tab

The Initialization tab (see Figure 25) is used to initialize the system and assign addresses to each device in the daisy-chain. The correct Single UART Interface or Dual UART Interface radio button must be selected for the hardwired system. Communication will only be established when the wired system aligns with the interface chosen from the UARTCFG group box. With the Dual UART Interface radio button selected, the user has the option of selecting

UPHOST or DOWNHOST. The Wakeup button initiates the communication process, and the Hello All button assigns the device addresses.

Along with establishing communication, the Initialization tab provides a method to log detailed communication events. The event and detailed logs can be enabled or disabled by clicking the checkboxes in the lower-left corner of the GUI.

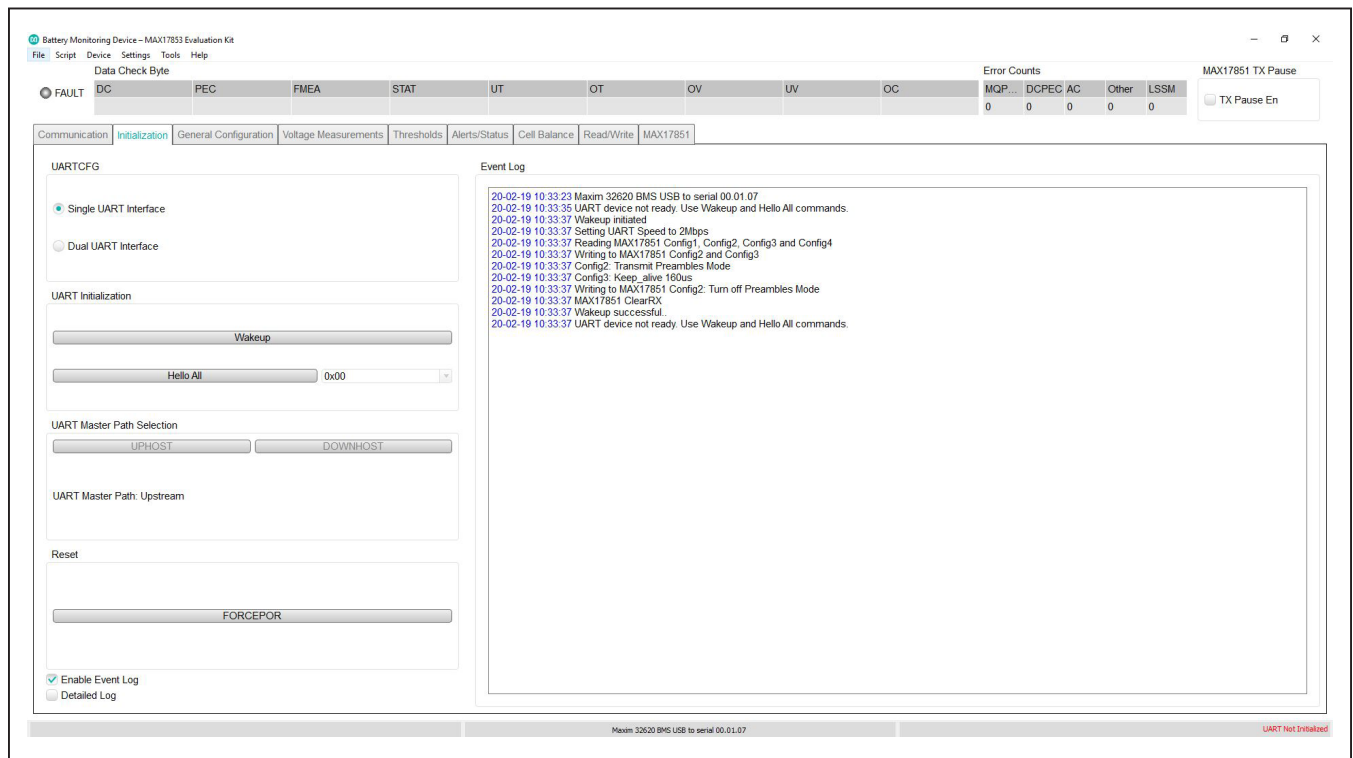

Figure 25. Initialization tab

MAX17851 Tab

The **MAX17851** tab (Figure 26) provides direct access to the registers of the MAX17851. The sub-tabs in the **MAX17851** tab (see Figure 26) offer powerful tools to configure and monitor the current state of the MAX17851. The **Commanded Operation** sub-tab (see Figure 26) is utilized to send UART commands to the daisy chain.

In the **Commanded Operation** sub-tab, the **SWPOR** button on the upper-right side of the GUI, will completely reset the device, emulating a POR condition. The embedded UART communication Lock Step State Machine (LSSM) gets reset by pressing the **Clear LSSM** button. The **Settings** button opens an individual settings panel to manage the configuration of the MAX17851 (see Figure 27). In the **Settings** panel, the user can set control properties of the GPIO and communication features. In addition, the user may configure the MAX17851 Master and Slave separately by changing the **Active Device** in the **Device Selection** drop-down menu.

Note: The user must click the **Confirm Settings** button at the bottom of the panel for the selections to take effect. Selections made in the **Settings** panel are applied to each MAX17851 device in the system.

Information on each of the parameters on the **Settings** panel is available in the MAX17851 IC data sheet.

The current state of **ALERTB** and GPIOs 3 and 4 are displayed on the upper-left side of the GUI. The GPIO status will change its color to green, if the GPIO pins of the MAX17851 are active high. Similarly, the **ALERTB** light displays the state of the alert pin of the MAX17851. The **ALERTB** color turns yellow when the MAX17851 pin is active. The **FAULT** light will activate when GPIO 1 or 2 are active high. The light colors of the GPIOs, **FAULT** and **ALERTB** displayed in the GUI match the light-emitting diodes of the MAX17851 EV kit.

To send UART commands to the BMS daisy chain, load the desired commands under the **UART Message Transmission** text box. Press **Load** to log the specified command onto the sequence log. Pressing **Run Sequence** will run the given commands sequentially. In addition, the user may delete, move up, or move down a selected command by right-clicking the command.

Pressing the **Help** button will open a separate panel (see Figure 28) where the available UART commands, along with the format and an example, will be displayed. The user can visually monitor the current status of the LSSM in the **LSSM Status** group box located at the bottom of the **Commanded Operation** sub-tab.

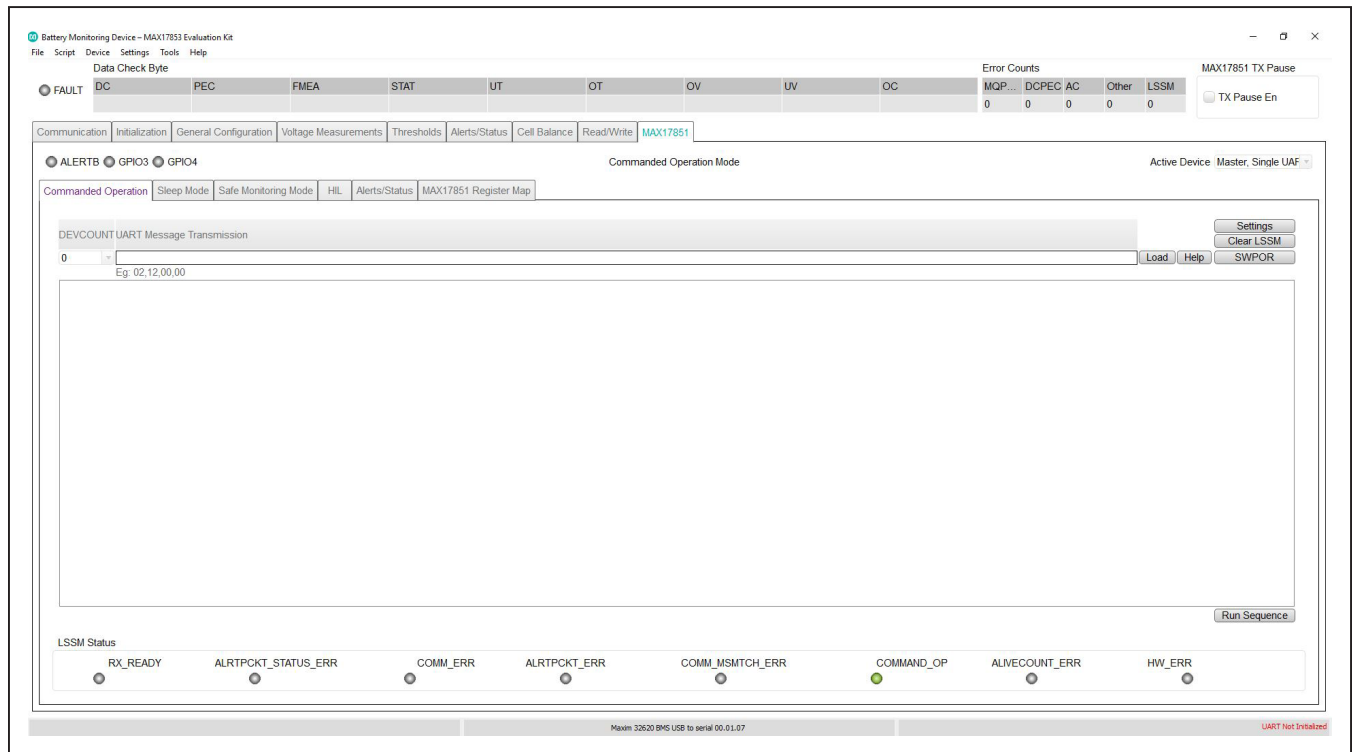

Figure 26. Commanded Operation tab

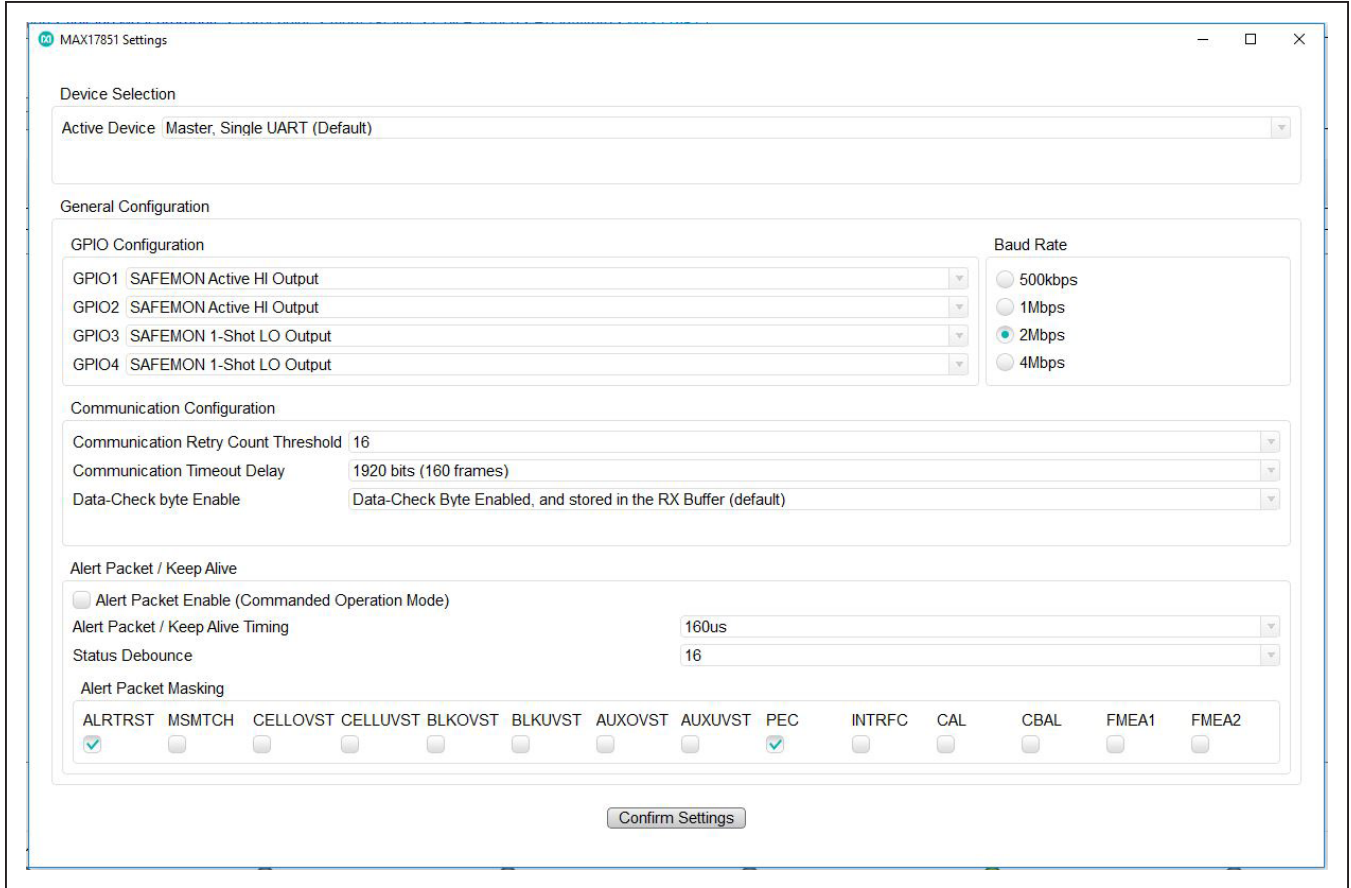

Figure 27. Settings panel

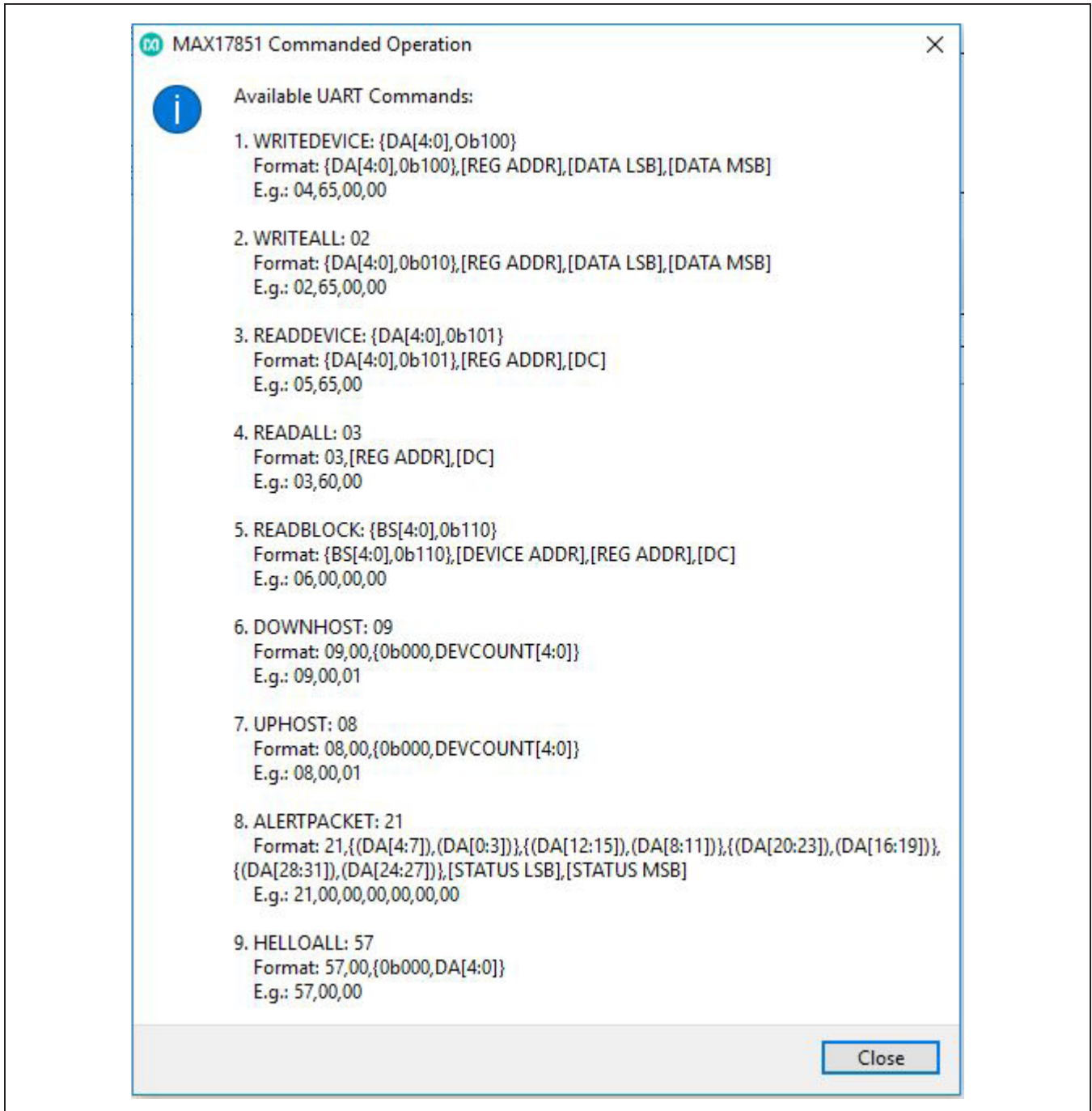

Figure 28. Commanded Operation Help

Sleep Mode Tab

The **Sleep Mode** tab (see [Figure 29](#)) gives the user the facility to manually control the MAX17851 sleep mode feature. The Alert Packet settings for sleep mode are in the **ALERTPKT** group box. The Alert Packet status bits may be masked from assertion of the **ALERTB** by selecting the desired checkbox under the **Alert Packet Masking** group box. To allow the automated generation of Alert Packets during sleep mode, the user must select the **Alert Packet Enable (Sleep Mode)** checkbox. The Alert Packets monitor critical safety battery conditions for immediate wakeup. The frequency at which the Alert Packets are generated is controlled by the **Sleep Mode Scan Delay** drop-down menu. The **Alert Packet Buffer** group box is the user interface for visually monitoring the Alert Packet status.

Sleep Mode is entered by asserting the **Sleep Enable** check box. A pop-up box will appear warning the user that Sleep Mode requires the BMS devices to enable Cell Balancing to prevent a shutdown. The pop-up box provides the user with four different options. The **Yes, Load Configuration** button will load a default Cell Balancing configuration to the BMS devices before entering sleep

mode. Refer to [Table 1](#) for the contents of the default configuration. The **No, Already Configured** button assumes that the user has already configured Cell Balancing in the BMS devices to prevent a shutdown. **Configure Auto-Polling/Cell Balance and Status** opens the **Cell Balancing** tab for the user to modify the Cell Balancing configuration. Lastly, **Cancel** closes the pop-up box.

Once sleep mode is entered, an internal timer controlled by the **Sleep Mode Cell Balancing Notify** will start. The current cell balancing time will be displayed at the top of the **Sleep Mode** tab. The user may select the desired sleep mode duration time in the **Sleep Mode Cell Balancing Notify** drop-down menu. When the Cell Balancing timer exceeds the value programmed, the device will proceed to exit sleep mode.

The **Fault** alert at the top-left-most corner of the GUI, will be activated to notify the user that a wake-up event occurred while returning to the Commanded Operational State. It is important to note that attempting to write to the Configuration Register Space or TX command Register Space while in Sleep Mode will cause the **SPI ERR ALRT** bit to be set in addition to the **GPIO ALERT**.

Table 1. Auto Cell Balancing (Default Configuration)

ADDRESS	NAME	DATA
0x64	MEASUREEN1	0x3FFF
0x65	MEASUREEN2	0x0000
0x5F	POLARITYCTRL	0x0000
0x66	SCANCTRL	0x0028
0x70	BALEXP1	0x03FF
0x71	BALEXP2	0x03FF
0x72	BALEXP3	0x03FF
0x73	BALEXP4	0x03FF
0x74	BALEXP5	0x03FF
0x75	BALEXP6	0x03FF
0x76	BALEXP7	0x03FF

ADDRESS	NAME	DATA
0x77	BALEXP8	0x03FF
0x78	BALEXP9	0x03FF
0x79	BALEXP10	0x03FF
0x7A	BALEXP11	0x03FF
0x7B	BALEXP12	0x03FF
0x7C	BALEXP13	0x03FF
0x7D	BALEXP14	0x03FF
0x6F	BALSWCTRL	0x0000
0x7E	BALAUTOVTHR	0x0001
0x7F	BALDYCTRL	0x0000
0x80	BALCTRL	0x3BF0

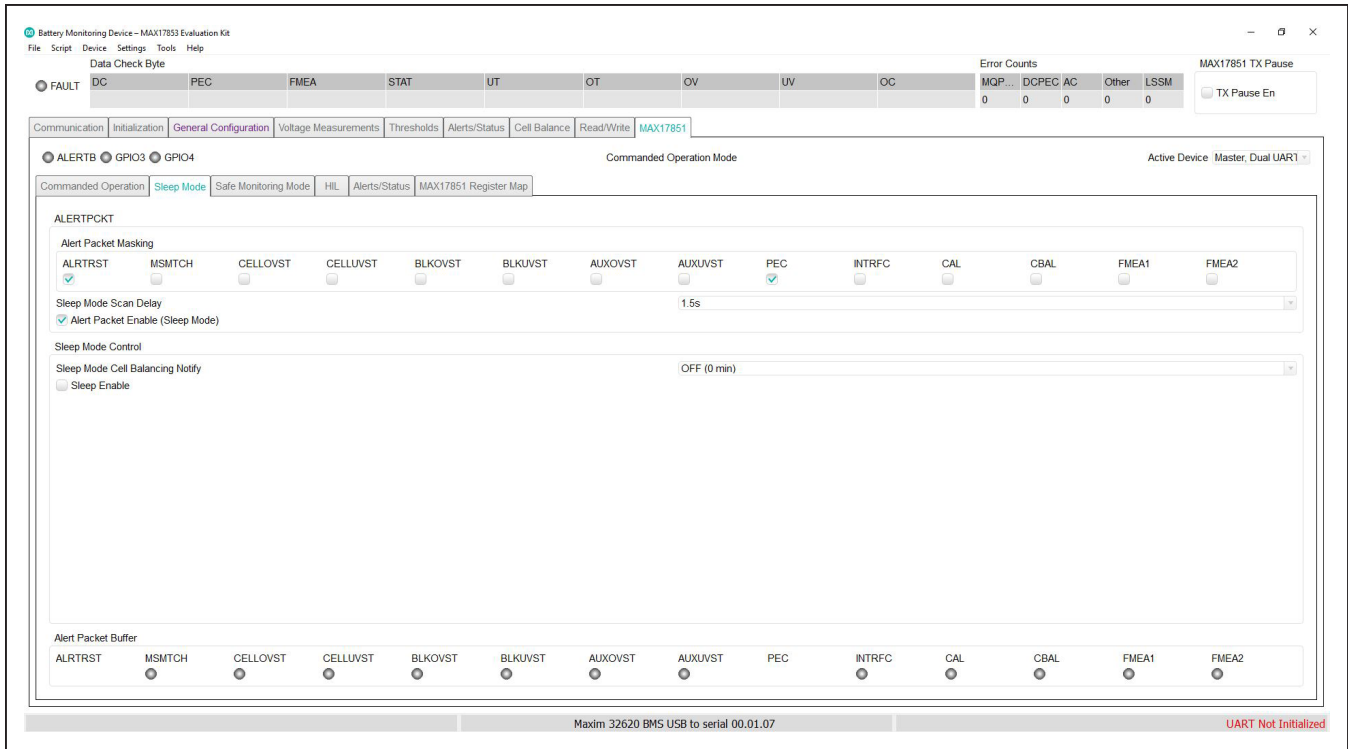

Figure 29. Sleep Mode tab

Safe Monitoring Mode Tab

The **Safe Monitoring Mode** tab (see [Figure 30](#)) grants the user the ability to evaluate the Safe Monitoring Mode feature of the MAX17851. The **Load Configuration Memory** button on the upper-left side of the GUI, opens an individual panel to manage the configuration memory feature of the MAX17851 (see [Figure 31](#)). The configuration memory stores the desired UART commands to be executed in Safe Monitoring mode ensuring all daisy-chain devices are in a known state. The **Verify Configuration Memory** button executes the verify configuration command. Failure of this operation will be indicated by the **DATAPATH ERR** alert.

The configuration memory consists of three queues that are subdivided into seven blocks and a fourth queue that consists of a single data block. The user may select the desired configuration memory queue for modifications in the **Current Queue** drop-down menu. An address value of 0xFF is a null address and will be skipped over and not included. Two consecutive null addresses in the same block signifies the end of that data queue. The **Confirm Configuration** button at the bottom of the panel must be clicked for the selections to take effect.

The user may disable the Safety Monitoring State of the SAFEMON FSM by selecting the **Disable Safety Monitoring States** check box. Located in the **Safe Monitoring Mode** group box is the **GPIO Recovery Delay (mSec)**. This entry allows the microcontroller the opportunity to read a GPIO pin state and recover. Refer to the MAX17851 IC datasheet for further details on the delay equation.

All GPIOs can be configured in the **Settings** panel at the **Commanded Operation** sub-tab. GPIO1 and GPIO2 can be individually configured as consistent output drives for logic signaling to the battery contactor. If a critical threshold is exceeded, GPIO1 and GPIO2 can be asserted to provide signaling to open the BMS system HV contactors and prevent hazardous conditions. **SAFEMON Contact Timer Delay (min)** controls the timer that will result in the assertion of GPIO 1 and 2 at expiration.

In a Master/Single UART configuration, GPIO3 and GPIO4 may be utilized to control the microcontroller recovery. The user must configure GPIO 3 and 4 as **SAFEMON Active HI Output** or **SAFEMON Active LO Output**. GPIO3 will be asserted upon successfully completing the loading of the configuration.

For a Master/Slave configuration, if the Master encounters an unrecoverable daisy-chain error, the slave device can assume control of the BMS safety monitoring. To achieve this functionality, GPIO3 of the Master should be configured as **SAFEMON Active HI Output** and GPIO4 of the Slave should be configured as **SAFEMON Slave Input**. Only in this configuration will the slave issue a **DOWNHOST** command and become the primary BMS safe monitoring device. In addition, GPIO4 of the Master and GPIO3 of the Slave can be configured as **SAFEMON 1-Shot HI Output** or **SAFEMON 1-Shot LO Output** to provide a 100ms 1-shot pulse for a system recovery condition to an unresponsive microcontroller.

The **SAFEMON GPIO Masking** group box gives the user the ability to mask the output of all GPIOs pin drive during the safety measure states of the SAFEMON FSM. This provides flexibility within the application to select any critical system.

Once the MAX17851 enters Safe Monitoring Mode, it will automatically generate and transmit alert packet commands. This allows for continued monitoring of the BMS daisy chain. The timing of the Alert Packet Generation is controlled by the **Safe Monitoring Mode Scan Delay** drop-down menu.

To enter Safe Monitoring Mode, the user must enable the watchdog. Invalid watchdog responses exceeding the **Watchdog Debounce** set by the user, will result in the device entering Safe Monitoring Mode. Two different methods are available to recover and return to the commanded operation mode. The user can provide a valid watchdog response to watchdog key by pressing the **Recover Watchdog** button. Alternatively, resetting the device by pressing the **SWPOR** button in the **Commanded Operation** sub-tab.

The **Watchdog Control** group box gives the user access to the control and configuration of the MAX17851 watchdog feature. To activate the watchdog, click on the

Enable Watchdog check box. This command will initiate the watchdog feature that verifies the operation of the microcontroller. The interval in which the microcontroller operation is checked is controlled by the **Watchdog Period** drop-down menu. If the microcontroller becomes unresponsive, the **Watchdog Fault Count** will start to increment until it exceeds the **Watchdog Debounce** value that is set by the user. In addition, the user can visually check the current status of the watchdog in the **Status** group box.

The watchdog can be configured in two different modes. The desired mode can be selected in the **Mode** drop-down list. As a default, the MAX17851 watchdog is configured as a **Challenge/Response Watchdog**. In this mode, the watchdog key response gets ignored if it is incorrect. Furthermore, the correct watchdog key response will also be ignored during a closed window.

The **Standard Windowed Watchdog** mode provides a valid watchdog refresh signal after receiving any value written to the watchdog key. The entered value will be ignored by the MAX17851. In this mode, the microcontroller sends watchdog key commands at the rate set in the **Watchdog Period** drop-down list. Failure to write the watchdog key within the set **Watchdog Period** rate, will result in the increment of the **Watchdog Fault Count**.

Note: It is important to mention that programming any of these registers while the watchdog is enabled may cause unexpected operation.

The user may stall the watchdog while in enable to enter **Safe Monitoring Mode** by pressing the **Watchdog Stall** button. This command is intended for system-level debugging.

Clicking on the **Alert Packet Masking** button opens the panel (see [Figure 32](#)) where users can mask the Alert Packet status bits from assertion of the **ALERTB**. The **Alert Packet Buffer** group box is the user interface for visually monitoring the Alert Packet status.

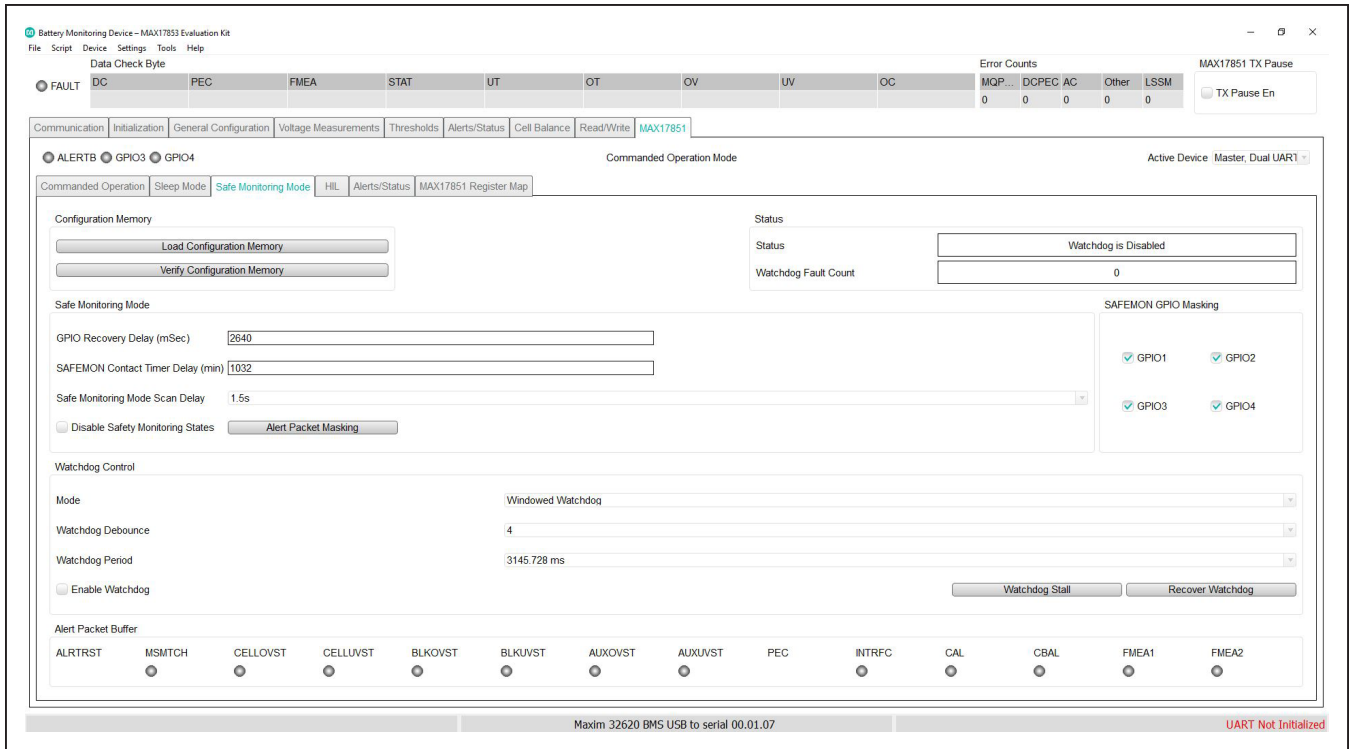

Figure 30. Safe Monitoring Mode tab

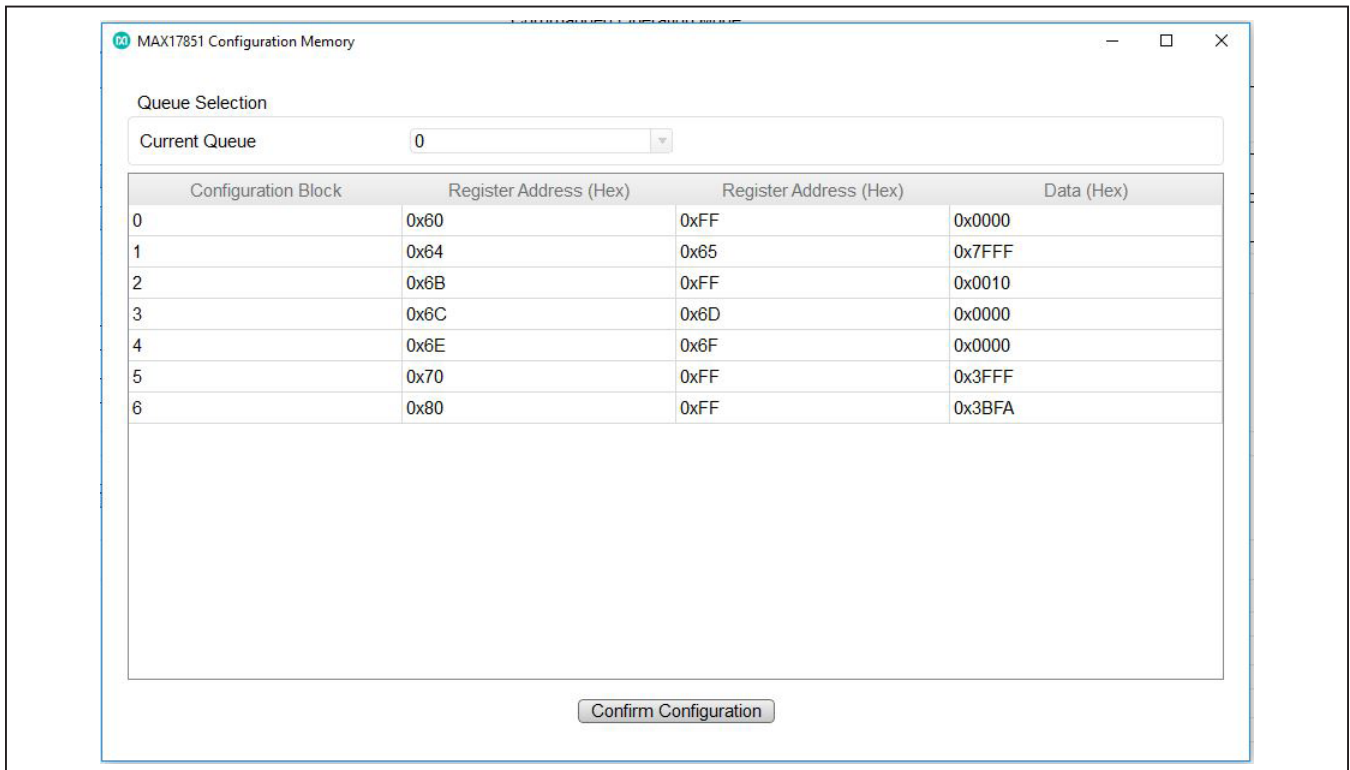

Figure 31. Configuration Memory

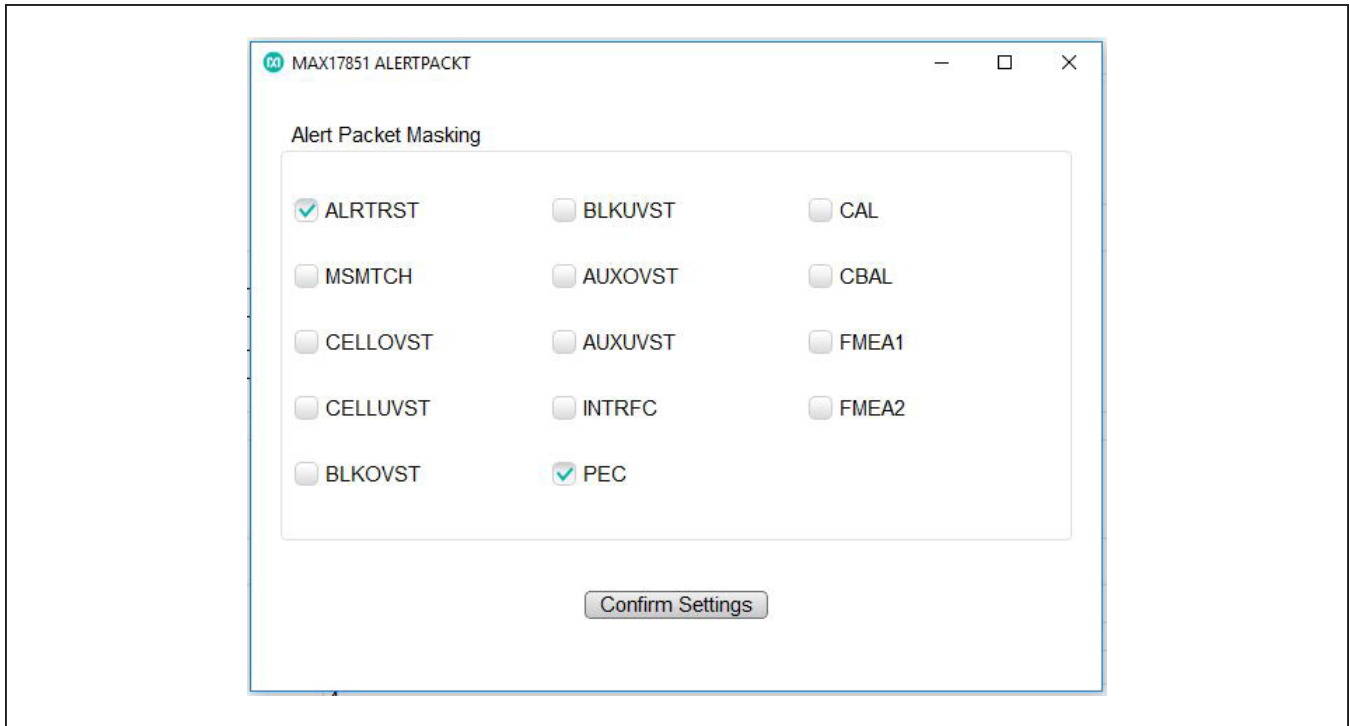

Figure 32. Safe Monitoring Alert Packet Masking

HIL Tab

The **HIL** tab (see [Figure 34](#)) is used to test a multitude of communication failures. It serves as a hardware verification and thus, it is not operational during Safety Monitoring Mode or Sleep Mode. HIL is achieved by utilizing the MAX17851 TX_AUTO feature. The HIL configuration requires that both MAX17851 Master and Slave be populated in the EV kit. The TX/RX lines of the Master are bypassed from the daisy chain and connected to the RX/TX lines of the Slave. In this mode, the UART will automatically increment the current queue then write the transmit buffer load queue upon receipt of a preamble.

The desired number of simulated devices may be selected in the **DEVCOUNT** drop-down menu. Pressing **Add UART Command** populates two row fields in which the user can enter the desired UART command. This UART command will be loaded to the Master. Under **Simulated Command**, the user may load the UART simulated command that will be loaded to the Slave. Press **Add** to log the specified command onto the sequence log. Pressing **Run Sequence** will run the given commands sequentially. The **RX Stop**, **RX Ready**, **PEC**, and **LSSM** LEDs report any faults within the received simulated UART command sent by the Slave. The **Event Log** button opens an individual panel (see [Figure 35](#)) that logs details of any communication fault.

In addition, the user may delete, move up, move down, or run a selected command by right-clicking the command. The **Clear Sequence** button clears the **Receive Buffer** field data and clears any LED fault. The **Save Sequence** button saves the **UART Command Sequence** and **Simulated Commands** in a standard .csv format. A sequence file can be loaded by selecting the **Load Sequence** button and selecting the previously saved sequence .csv file.

Clicking on the **Preconfigured Test Cases** button, opens an individual panel (see [Figure 36](#)) in which the user may select an array of preconfigured test cases that can serve as examples for future evaluation. [Table 2](#) details a brief description of the preconfigured test cases. **Note:** Refer to the MAX17851 Hardware Integration document for detailed explanations of the configuration and implementation of each test case.

Table 2. Preconfigured Test Cases

TEST NAME	UART COMMAND	SIMULATED UART COMMAND	DESCRIPTION
No Preamble	06,03,00,00,58	C0,06,03,00,25,85,00,70	Transmit No Preamble Mode
No Stop	06,03,00,00,58	C0,06,03,00,25,85,00,70	Transmit No Stop Mode
No Message	06,03,00,00,58	C0	Transmit No Message
Corrupt CB	06,03,00,00,58	C0,06,03,00,25,85,FF,65	Check Byte 0xFF
Corrupt Register Address	06,03,00,00,58	C0,06,03,FF,25,85,00,94	Register Address Error 0xFF
Corrupt Data	06,03,00,00,58	C0,06,03,00,FF,FF,00,58	Corrupt Data 0xFF 0xFF
Corrupt PEC	06,03,00,00,58	C0,06,03,00,25,85,00,FF	Corrupted PEC 0xFF
Inserted Message	06,03,00,00,58	C0,08,03,00,25,85,25,85,00,A7	Inserted Message 0x25 0x85
Inserted Byte	06,03,00,00,58	C0,07,03,00,25,85,00,00,88	Inserted Byte 0x00
Deleted Message	06,03,00,00,58	C0,04,03,00,00,58	Deleted Message
Deleted Byte	06,03,00,00,58	C0,06,03,00,25,85,74	Deleted Byte
Manchester Error	06,03,00,00,58	C0,14,15,A5,AA,00,AA,AA,AA,6A,99,AA,AA,AA,AA,54	Manchester Error 0x00
Parity Error	06,03,00,00,58	C0,06,03,00,25,85,00,70	Transmit Odd Parity Mode
Data Check Error	06,03,00,00,58	C0,06,03,00,25,85,20,EE	Check Byte Error 0x20

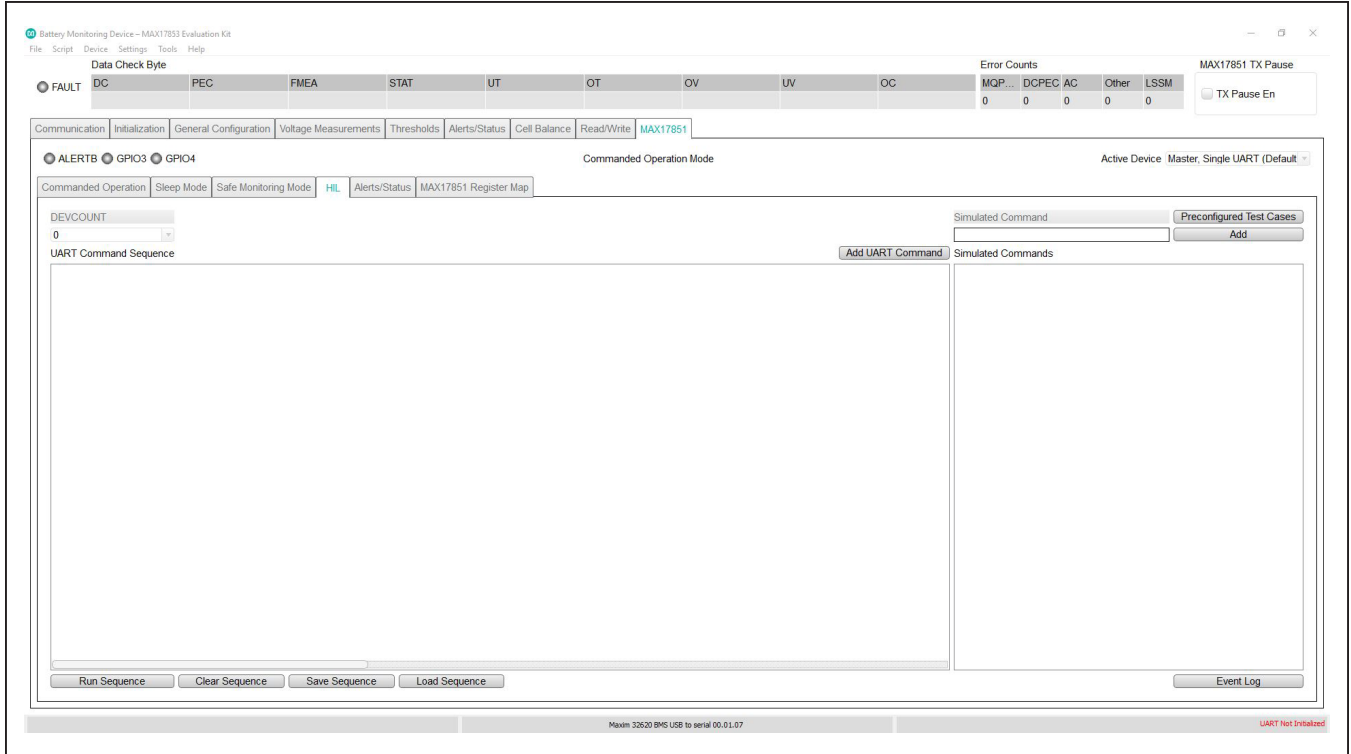

Figure 34. HIL tab

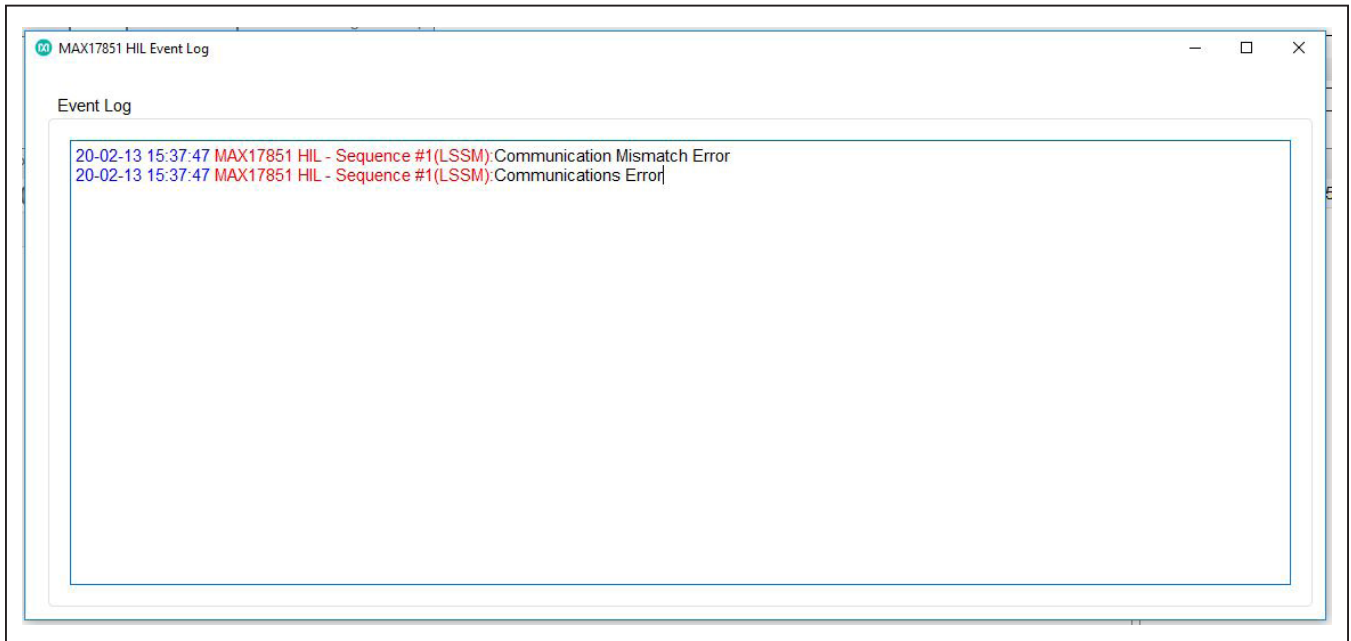

Figure 35. HIL event log

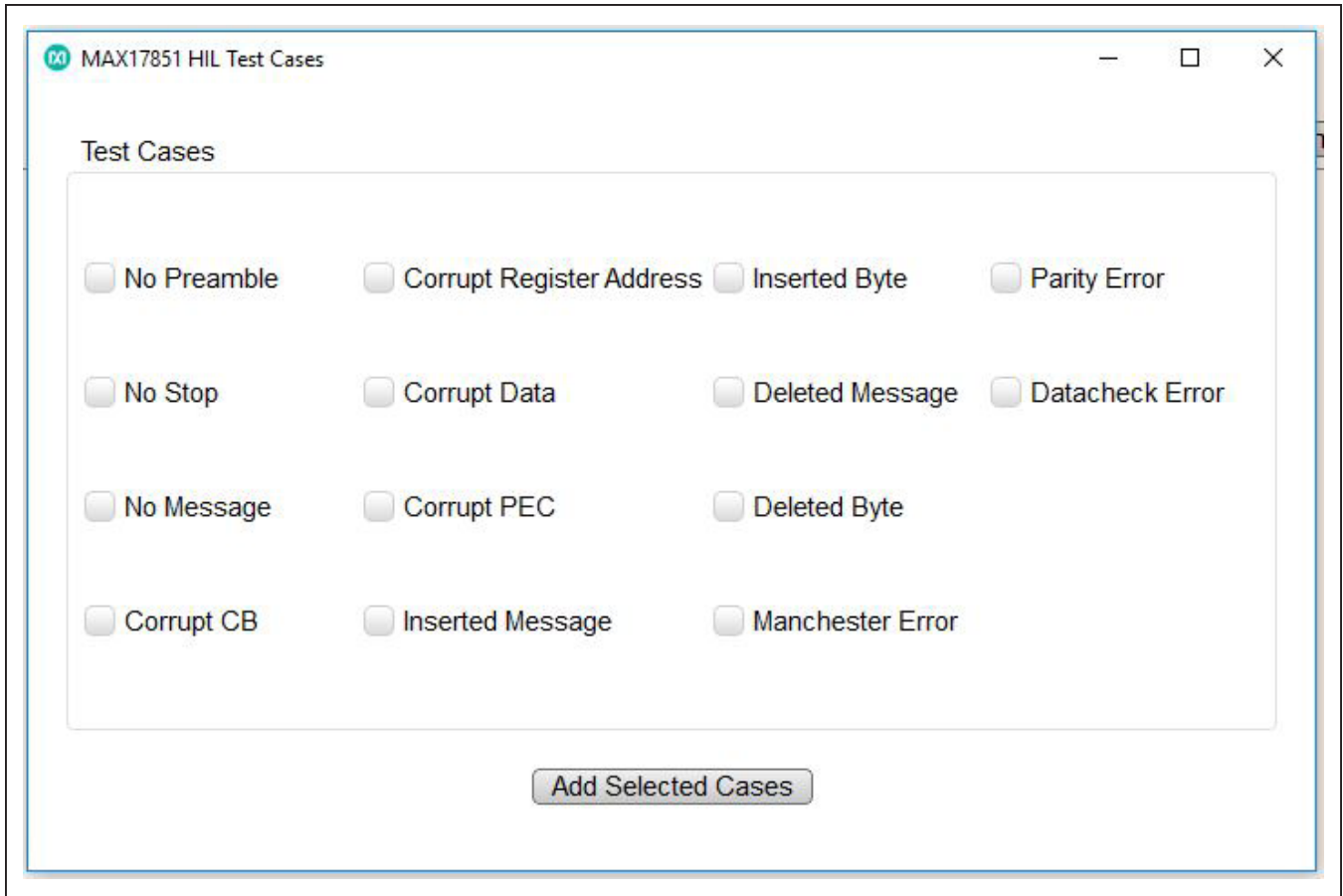

Figure 36. HIL preconfigured test cases

Alerts/Status Tab

The **Alerts/Status** tab (see [Figure 37](#)) is the user interface for visually monitoring all the Alerts in the MAX17851. The user can use the **Clear Device Alerts** or the **Clear All Device Alerts** to clear the faults logged in the system. Furthermore, the faults can be cleared by pressing on the active alert button.

Clicking the **Alert Enables** button in the top-right corner of the **Alerts/Status** tab opens the **Alert Enable** panel (see [Figure 38](#)). In the Alert Enable panel, the user may enable the desired alerts by pressing on the alert checkbox. Press the **Update Active Device** or **Update All Devices** to enable the selected alerts on the MAX17851.

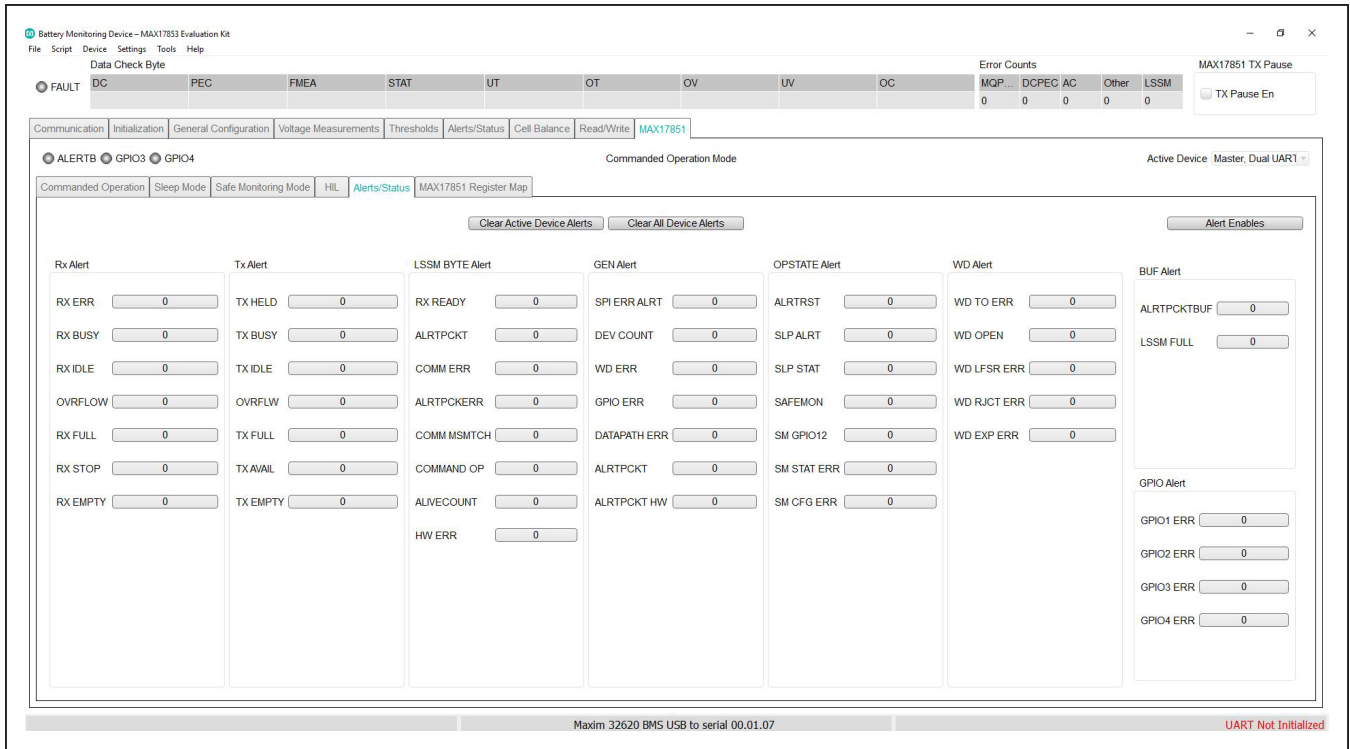

Figure 37. Alerts/Status tab

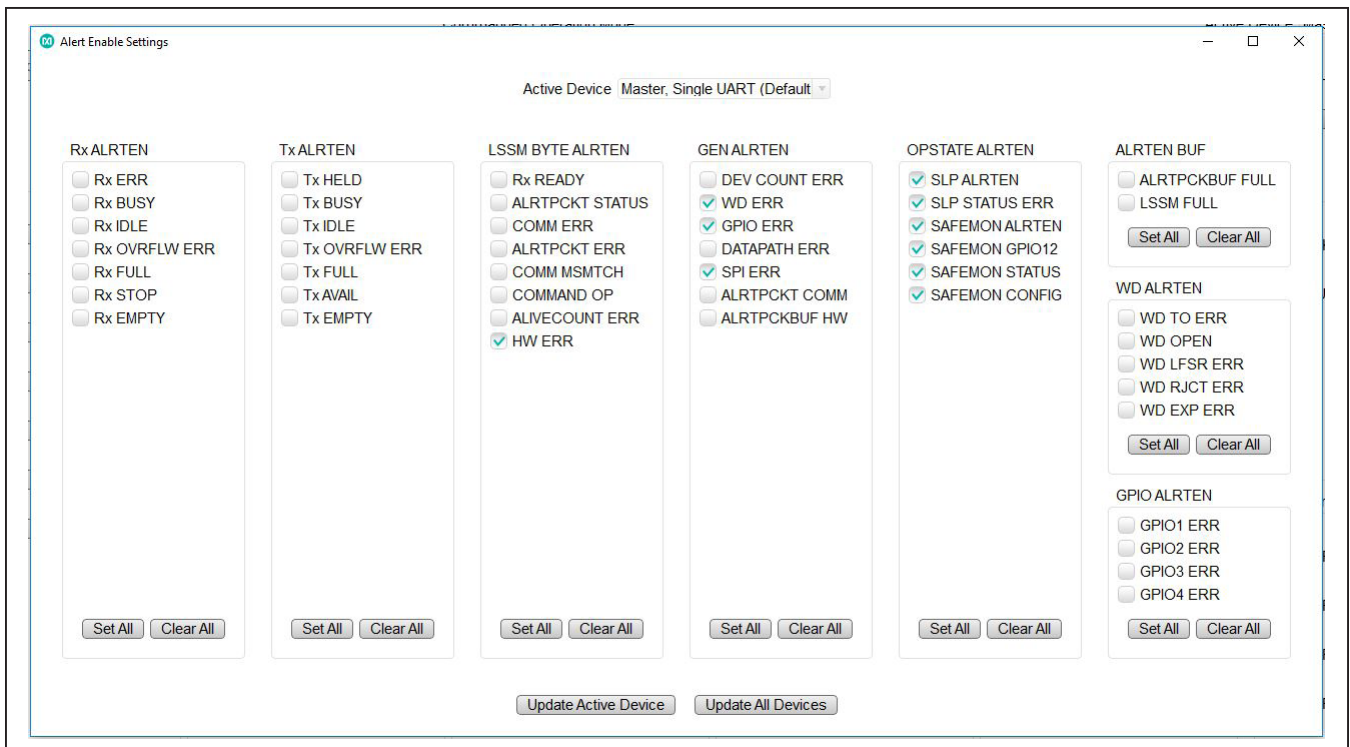

Figure 38. Alert enables

MAX17851 Register Map Tab

The MAX17851 registers can be directly modified using the **MAX17851 Register Map** sub-tab (see [Figure 39](#)). A pulldown arrow to the left of the address number allows the user to identify register content. As an example, [Figure 39](#) shows register 0x33 content and has the **Keep-Alive [3:0]** highlighted. To alter the keep-alive timing,

the user must type the desired hex value of the period directly in the **Update Field** edit box and then click the **Set** button on the right. Selecting a parameter in a register automatically highlights the bit values of the parameter and provides a description of the parameter in the **Field Description** group box.

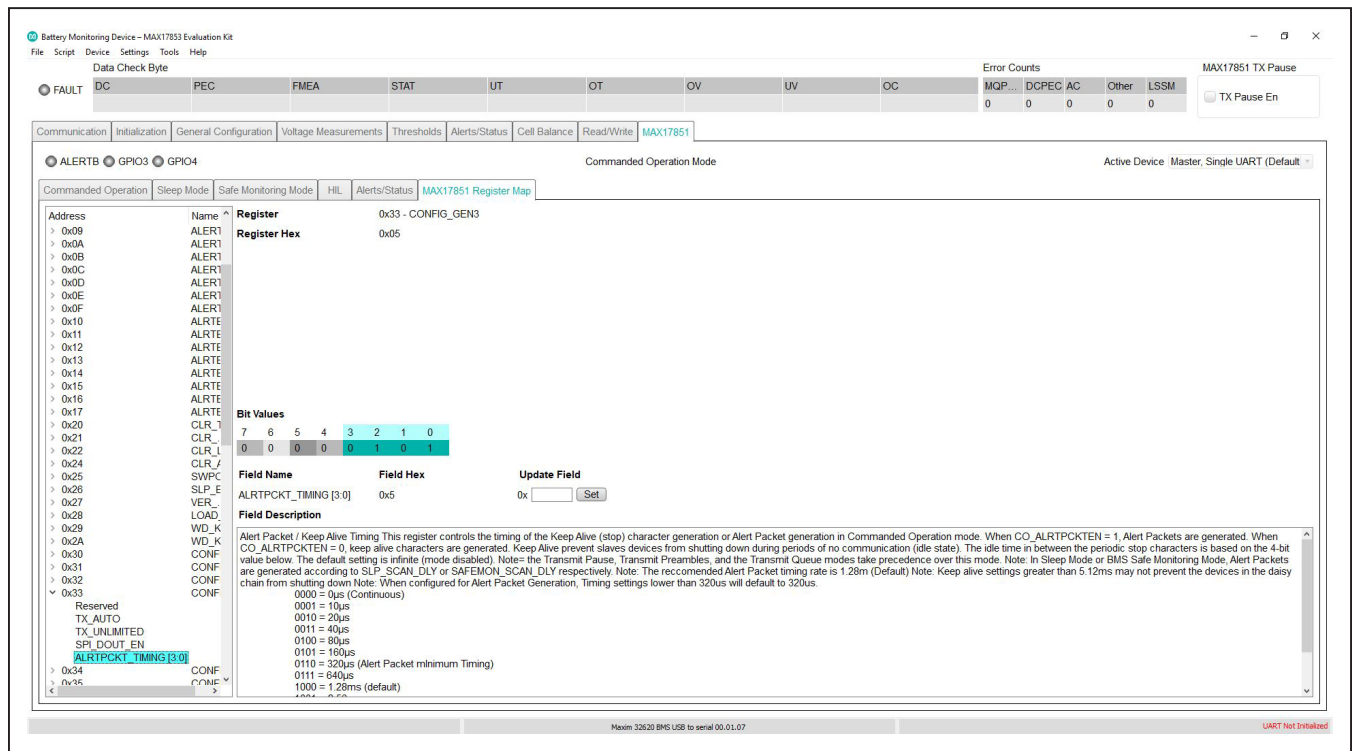

Figure 39. MAX17851 tab (register map panel)

MAX17851 EV Kit Hardware Description

The MAX17851 EV kit PCB is designed with headers, test points, and jumpers, providing convenient access to circuit nets where measurements can be made, and signals monitored.

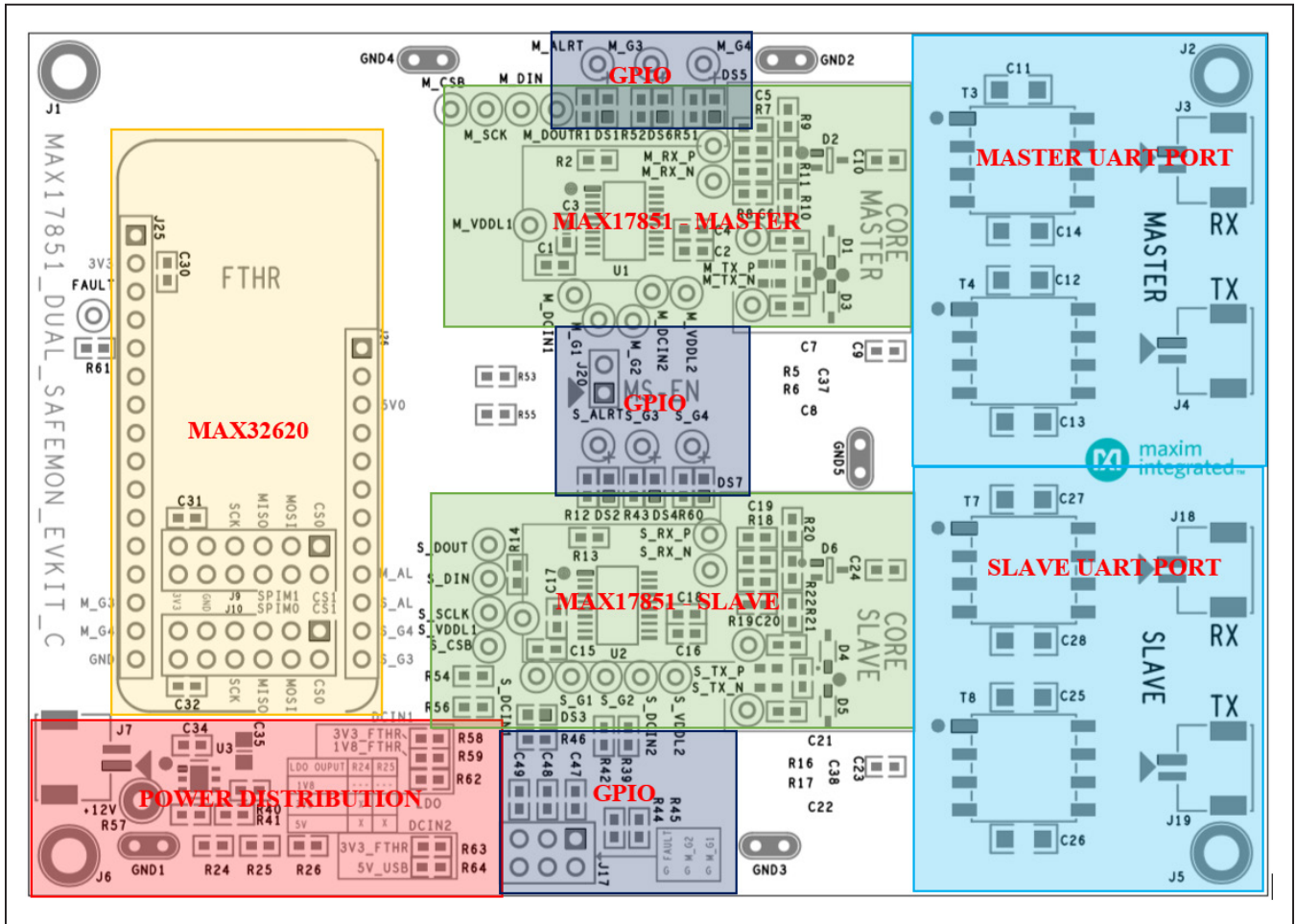

Figure 40. MAX17851 EV Kit PCB

MAX32620 Connector (J25–J26, J9–J10)

To demonstrate the features and capabilities of the Maxim EV kit SPI to UART Safety Monitoring Bridge, it is essential to include the MAX32620. The MAX17851 EV kit contains the MAX17851 base board and the PC USB interface board (MAX32620). The MAX32620 is a rapid development platform designed to help engineers quickly implement battery-optimized solutions. Power and ground for the MAX17851 is derived through the MAX32620 and requires no other power source.

Master/Slave UART Ports

The UART communication ports are identified as the Master port (J3-J4) and the Slave port (J18-J19), on the EV kit PCB (see Figure 42). Each UART port comprises a differential transmitter and a differential receiver. Communication data uses a UART protocol specifically designed for Maxim battery management devices. The UART protocol is designed to minimize power consumption by allowing slave devices to shut down if the data link is idle for a specified period. Each differential pair includes two test points for observing the communication signals. The Master port test points and Slave port test points, are located on the Master and Slave UART port section.

The EV kit UART network and components are designed for the automotive environment and are capable of enduring battery-management-system compliance testing. This includes BCI, ESD and radiated emission. It is critical to note that the MAX17851 EV kit provides the battery-management evaluation system with capacitive isolation on connectors J3, J4, J18 and J19. Footprints for transformer isolation are available for evaluation of different isolation methods.

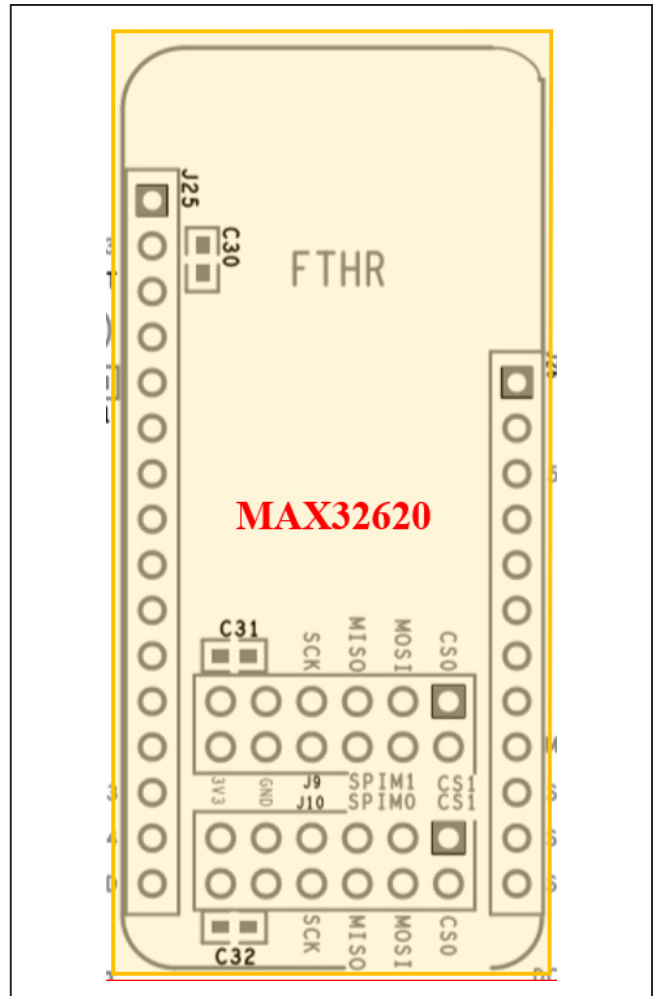

Figure 41. MAX32620 interface connector

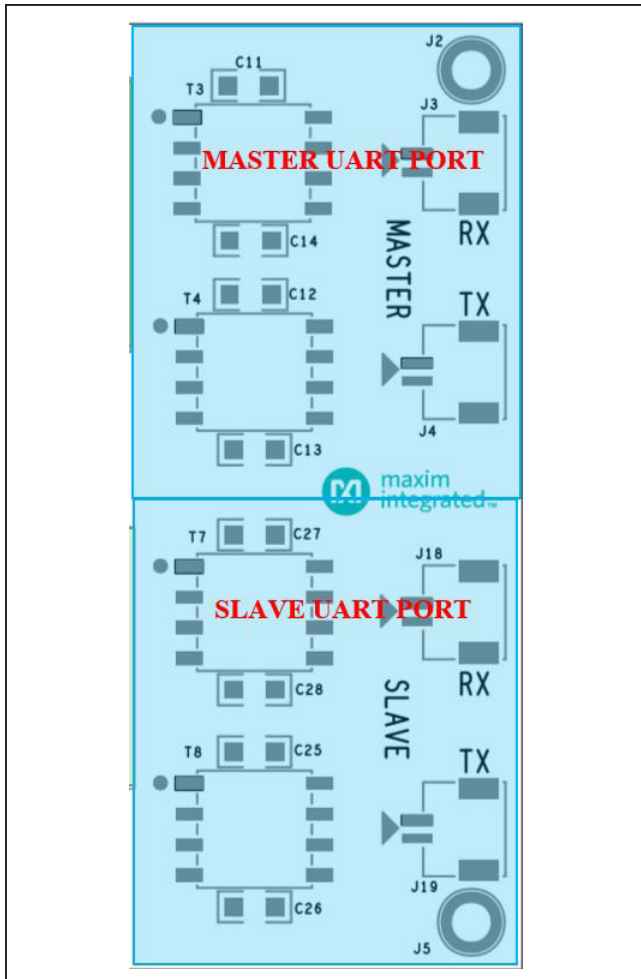

Figure 42. Master/Slave UART ports

Power Distribution

Power is distributed to the MAX17851 EV kit through resistors R58, R59, R62. The chosen resistor selects the power source for DCIN1 and DCIN2 depending on the hardware configuration.

The user has the following options to supply power to the MAX17851 EV kit. Using 3V3_FTNR, supplies 3.3V coming from the MAX32620 EV kit. The 1V8_FTNR, supplies 1.8V from the MAX32620 EV kit. Lastly, the LDO can supply 1.8V, 3.3V, 5V from the on-board LDO.

GPIO Control

GPIO pins may be configured as general purpose I/O, commanded by explicit register writes, but can also be individually configured to provide specific functionality within BMS Safety Monitoring Mode. GPIO3 and GPIO4 in both the Master and Slave, are equipped with LEDs to facilitate debugging. The user can also evaluate the state of the GPIO (1-4) pins by utilizing the test points on the EV kit. It is important to note that GPIO1 and GPIO2 outputs are isolated. This allows for one of the GPIO outputs to fail while the other can still safely assert the Battery Contactor signal.

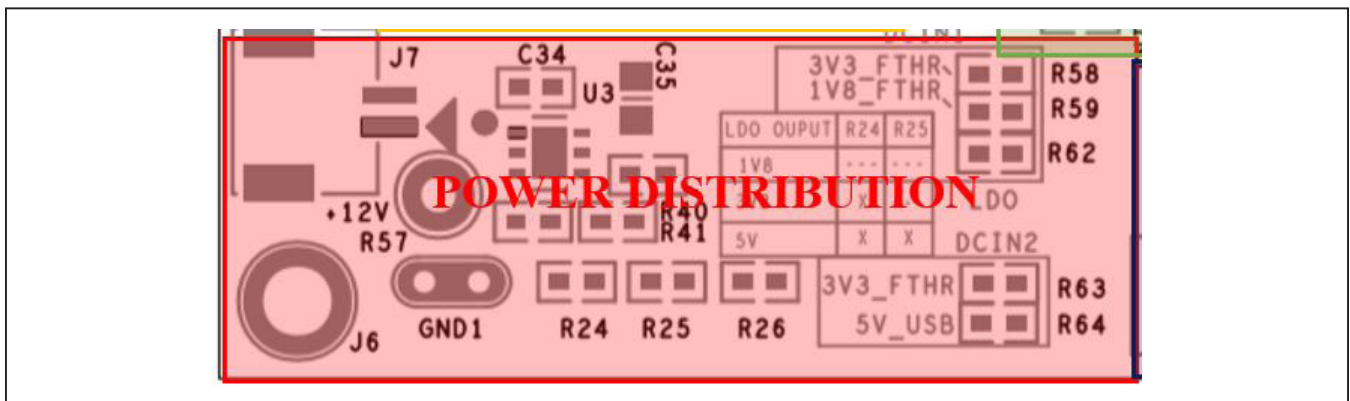

Figure 43. Power distribution (J11, J12, and J21)

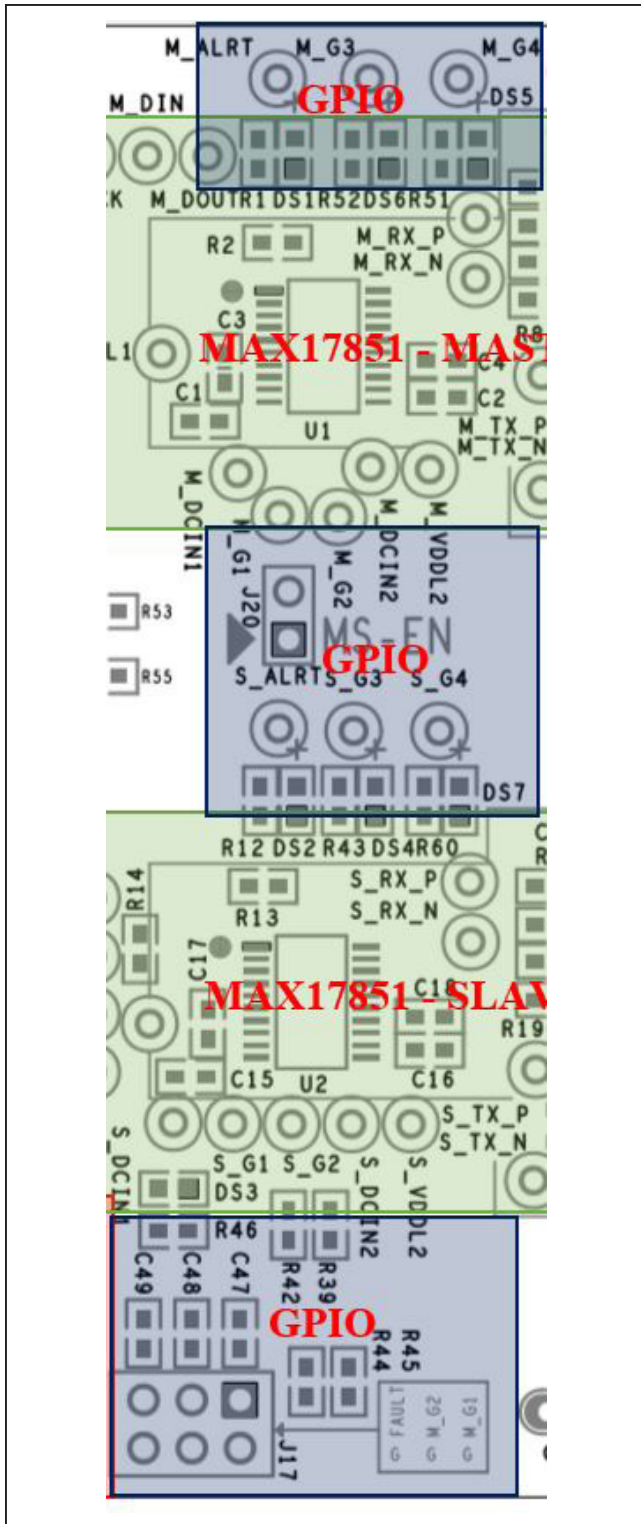

Figure 44. GPIO

MAX17851 IC Pin Headers

For convenience, certain IC pins are terminated to test points for monitoring frequently observed device signals. Examples include CS, DCIN, SCLK, DOUT, DIN, GPIO (1-4), VDDL1, VDDL2, and ALERTB.

The MAX17851 EV kit provides the user with an introduction to the features and functions of the MAX17851 device. Refer to the MAX17851 IC data sheet for detailed explanations of the product features, register set, and modes of operation.

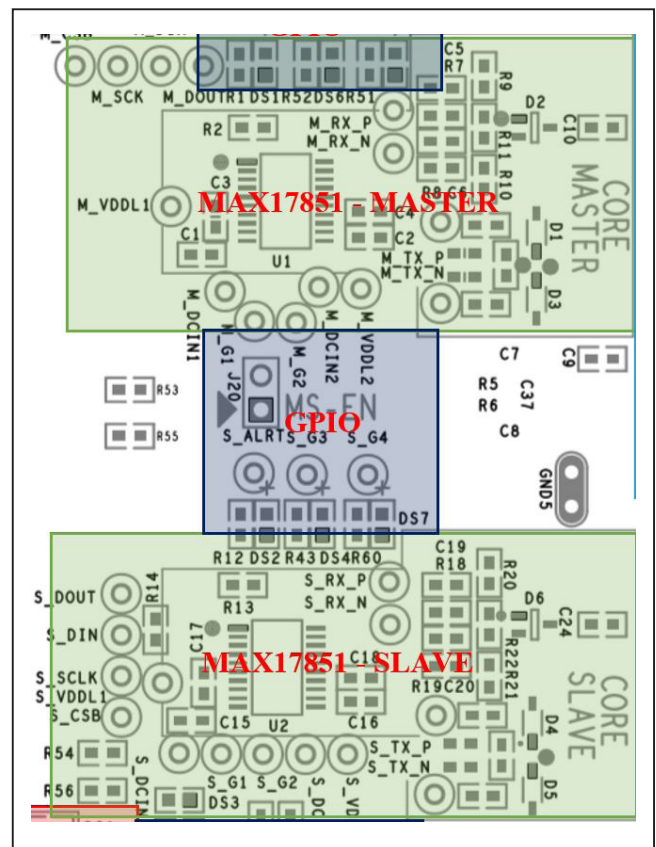

Figure 45. MAX17851 IC pin header

Ordering Information

PART	TYPE
MAX17851EVKIT#	EV kit

#Denotes RoHS compliant.

MAX17851 EV Kit Bill of Materials

ITEM	REF_DES	DNI/DNP	QTY	MFG PART #	MANUFACTURER	VALUE	DESCRIPTION	COMMENTS
1	+12V	-	1	5010	KEystone	N/A	TEST POINT; PIN DIA=0.125IN; TOTAL LENGTH=0.445IN; BOARD HOLE=0.063IN; RED; PHOSPHOR BRONZE WIRE SIL;	
2	BUMPER1-BUMPER6	-	6	SJ-5003(BLACK)	3M ELECTRONIC SOLUTIONS DIVISION	SJ-5003(BLACK)	BUMPER; BLACK-HEMISPHERICAL SHAPE EVKIT EH0231; 0.44D/0.2BH; RESILIENT ELASTOMER POLYURETHANE	
3	C1-C3, C15-C17, C29-C33, C36	-	12	C0603C104J4RAC; X7R0603CTTD104J; GRM188R71C104JA01	KEMET;KOA SPEER ELECTRONICS INC;MURATA	0.1UF	CAP; SMT (0603); 0.1UF; 5%; 16V; X7R; CERAMIC;	
4	C4, C18	-	2	C0603C105K4RAC; GRM188R71C105KA12; C1608X7R1C105K080AC; EMK107B7105KA; CGA3E1X7R1C105K080AC; 0603YC105KAT2A	KEMET;MURATA;TDK; TAIYO YUDEN;TDK;AVX	1UF	CAP; SMT (0603); 1UF; 10%; 16V; X7R; CERAMIC	
5	C5, C6, C19, C20	-	4	GRM39C0G150J50V; GRM1885C1H150JA01	MURATA;MURATA	15PF	CAP; SMT (0603); 15PF; 5%; 50V; C0G; CERAMIC	
6	C11-C14, C25-C28	-	8	C1206C222KFRAC	KEMET	2200PF	CAP; SMT (1206); 2200PF; 10%; 1500V; X7R; CERAMIC	
7	C34	-	1	GCJ188R71H104KA12; GCM188R71H104K; CGA3E2X7R1H104K080AA; CGA3E2X7R1H104K080AD; CL10B104KB8WPN	MURATA;MURATA;TDK; TDK;SAMSUNG	0.1UF	CAP; SMT (0603); 0.1UF; 10%; 50V; X7R; CERAMIC	
8	C35	-	1	C2012X7R1C225K125AB	TDK	2.2UF	CAP; SMT (0805); 2.2UF; 10%; 16V; X7R; CERAMIC	
9	C47-C49	-	3	885012206071; C1608X7R1E104K080AA; C0603C104K3RAC; GRM188R71E104KA01; C1608X7R1E104K; 06033C104KAT2A	WURTH ELECTRONICS INC; TDK;KEMET;MURATA;TDK;AVX	0.1UF	CAP; SMT (0603); 0.1UF; 10%; 25V; X7R; CERAMIC	
10	D1, D3-D5, D7, D8, D10, D11, D31, D32, D38-D41	-	14	PESD5V0U1UA	NEXPERIA	5V	DIODE; TVS; SMT (SOD-323); VRM=5V	
11	D2, D6	-	2	ESDCAN03-2BWY	ST MICROELECTRONICS	ESDCAN03-2BWY	DIODE; TVS; SMT; VBR=26.5V; IPP=3.7A	
12	DS1, DS2	-	2	LY L29K-H1K2-26-Z	OSRAM	LY L29K-H1K2-26-Z	DIODE; LED; LY L29K SERIES; SMARTLED; YELLOW; SMT (1608); VF=1.8V; IF=0.02A	
13	DS3	-	1	LS L29K-G1J2-1-Z	OSRAM	LS L29K-G1J2-1-Z	DIODE; LED; SMART; RED; SMT (0603); PIV=1.8V; IF=0.02A; -40 DEGC TO +100 DEGC	
14	DS4-DS7	-	4	LGL29K-F2J1-24-Z	OSRAM	LGL29K-F2J1-24-Z	DIODE; LED; SMARTLED; GREEN; SMT; PIV=1.7V; IF=0.02A	
15	FAULT	-	1	5002	KEystone	N/A	TEST POINT; PIN DIA=0.1IN; TOTAL LENGTH=0.3IN; BOARD HOLE=0.04IN; WHITE; PHOSPHOR BRONZE WIRE SILVER;	
16	GND1-GND5	-	5	9020 BUSS	WEICO WIRE	MAXIMPAD	EVK KIT PARTS; MAXIM PAD; WIRE; NATURAL; SOLID; WEICO WIRE; SOFT DRAWN BUS TYPE-S; 20AWG	
17	J3, J4, J18, J19	-	4	502584-0270	MOLEX	502584-0270	CONNECTOR; FEMALE; SMT; 502584 SERIES; STRAIGHT; 2PINS	
18	J9, J10	-	2	TSW-106-17-L-D	SAMTEC	TSW-106-17-L-D	CONNECTOR; MALE; THROUGH HOLE; 0.025 IN SQUARE POST HEADER; STRAIGHT; 12PINS; 2X6	
19	J17	-	1	PEC03DAAN	SULLINS ELECTRONICS CORP.	PEC03DAAN	CONNECTOR; MALE; THROUGH HOLE; BREAKAWAY; STRAIGHT THROUGH; 6PINS; -65 DEGC TO +125 DEGC	
20	J20	-	1	3-644456-2	TYCO	3-644456-2	CONNECTOR; HEADER STRIP, TH, STR, 2PINS, 1 ROW	
21	J25	-	1	PPTC161LFBN-RC	SULLINS ELECTRONICS CORP	PPTC161LFBN-RC	CONNECTOR; FEMALE; THROUGH HOLE; 2.54MM CONTACT CENTER; FEMALE HEADER; STRAIGHT; 16PINS	
22	J26	-	1	PPPC121LFBN-RC	SULLINS ELECTRONICS CORP	PPPC121LFBN-RC	CONNECTOR; FEMALE; THROUGH HOLE; HEADER FEMALE; STRAIGHT; 12PINS	
23	M_ALRT, M_G1-M_G4, S_ALRT, S_G1-S_G4	-	10	5003	KEystone	N/A	TEST POINT; PIN DIA=0.1IN; TOTAL LENGTH=0.3IN; BOARD HOLE=0.04IN; ORANGE; PHOSPHOR BRONZE WIRE SILVER PLATE FINISH;	
24	M_CSB, M_DIN, M_DOUT, M_RX_N, M_RX_P, M_SCK, M_TX_N, M_TX_P, S_CSB, S_DIN, S_DOUT, S_RX_N, S_RX_P, S_SCLK, S_TX_N, S_TX_P	-	16	5004	KEystone	N/A	TEST POINT; PIN DIA=0.1IN; TOTAL LENGTH=0.3IN; BOARD HOLE=0.04IN; YELLOW; PHOSPHOR BRONZE WIRE SILVER PLATE FINISH;	
25	M_DCIN1, M_DCIN2, M_VDDL1, M_VDDL2, S_DCIN1, S_DCIN2, S_VDDL1, S_VDDL2	-	8	5000	KEystone	N/A	TEST POINT; PIN DIA=0.1IN; TOTAL LENGTH=0.3IN; BOARD HOLE=0.04IN; RED; PHOSPHOR BRONZE WIRE SILVER PLATE FINISH;	

MAX17851 Evaluation Kit Datasheet

Evaluates: MAX17851

MAX17851 EV Kit Bill of Materials (continued)

ITEM	REF_DES	DNI/DNP	QTY	MFG PART #	MANUFACTURER	VALUE	DESCRIPTION	COMMENTS
26	R1, R12, R23, R46	-	4	RR0816P-102-B-T5; PCF0603R-1K0B	SUSUMU CO LTD; TT ELECTRONICS	1K	RES; SMT (0603); 1K; 0.10%; +/-25PPM/DEGC; 0.0630W	
27	R2, R3, R13, R14	-	4	ERJ-3GEYJ104; CRCW0603100KJN	PANASONIC;VISHAY	100K	RES; SMT (0603); 100K; 5%; +/-200PPM/DEGC; 0.1000W	
28	R5, R6, R16, R17	-	4	CRCW060339R0FK	VISHAY DALE	39	RES; SMT (0603); 39; 1%; +/-100PPM/DEGC; 0.1000W	
29	R7, R8, R18, R19	-	4	CRCW060347R0FK; ERJ-3EKF4700	VISHAY DALE;PANASONIC	470	RES; SMT (0603); 470; 1%; +/-100PPM/DEGC; 0.1000W	
30	R9, R10, R20, R21	-	4	CRCW0603100KFK; RC0603FR-07100KL; RC0603FR-13100KL; ERJ-3EKF1003; AC0603FR-07100KL	VISHAY DALE;YAGEO; YAGEO;PANASONIC	100K	RES; SMT (0603); 100K; 1%; +/-100PPM/DEGC; 0.1000W	
31	R25, R58, R64	-	3	CRCW06030000Z0	VISHAY DALE	0	RES; SMT (0603); 0; JUMPER; JUMPER; 0.1000W	
32	R26	-	1	CRCW060347K0FK	VISHAY DALE	47K	RES; SMT (0603); 47K; 1%; +/-100PPM/DEGC; 0.1000W	
33	R31-R38	-	8	CRCW060322R0FK	VISHAY	22	RES; SMT (0603); 22; 1%; +/-100PPM/DEGC; 0.1000W	
34	R39, R42, R44, R45	-	4	301-10K-RC	XICON	10K	RES; SMT (0603); 10K; 5%; +/-200PPM/DEGC; 0.0630W	
35	R40	-	1	CRCW060356K0FK	VISHAY DALE	56K	RES; SMT (0603); 56K; 1%; +/-100PPM/DEGC; 0.1000W	
36	R41	-	1	CRCW0603120KFK	VISHAY DALE	120K	RES; SMT (0603); 120K; 1%; +/-100PPM/DEGC; 0.1000W	
37	R43, R51, R52, R60	-	4	CRCW060322R0FK; ERJ-3EKF2200	VISHAY DALE;PANASONIC	220	RES; SMT (0603); 220; 1%; +/-100PPM/DEGC; 0.1000W	
38	R47-R50	-	4	CRCW060310K0JN; ERJ-3GEYJ103	VISHAY DALE;PANASONIC	10K	RES; SMT (0603); 10K; 5%; +/-200PPM/DEGC; 0.1000W	
39	R53-R56, R61	-	5	RC1608J000CS; CR0603-J-000ELF; RC0603JR-070RL	SAMSUNG ELECTRONICS; BOURNS;YAGEO PH	0	RES; SMT (0603); 0; 5%; JUMPER; 0.1000W	
40	R57	-	1	CRCW060339K0FK	VISHAY DALE	39K	RES; SMT (0603); 39K; 1%; +/-100PPM/DEGC; 0.1000W	
41	SU2	-	1	S1100-B;SX1100-B; STC02SYAN	KYCON;KYCON;SULLINS ELECTRONICS CORP.	SX1100-B	TEST POINT; JUMPER; STR; TOTAL LENGTH=0.24IN; BLACK; INSULATION=PBT;PHOSPHOR BRONZE CONTACT=GOLD PLATED	
42	U1, U2	-	2	MAX17851	MAXIM	MAX17851	IC; MON; SPI TO UART SAFETY MONITORING BRIDGE; TSSOP20	
43	U3	-	1	MAX15006CATT+	MAXIM	MAX15006CATT+	IC; VREG; ULTRA-LOW QUIESCENT-CURRENT LINEAR REGULATOR; TDFN6-EP 3X3	
44	U4	-	1	SN74LVC1G32DBV	TEXAS INSTRUMENTS	SN74LVC1G32DBV	IC; OR; SINGLE 2-INPUT POSITIVE-OR GATE; SOT23-5	
45	U8, U9	-	2	TPD4E004DRY	TEXAS INSTRUMENTS	TPD4E004DRY	IC; TVS; 4-CHANNEL ESD-PROTECTION ARRAY FOR HIGH- SPEED DATA INTERFACE TRANSIENT VOLTAGE SUPPRESSOR; SON6	
46	PCB	-	1	MAX17851DUALSAFEMON	MAXIM	PCB	PCB;MAX17851DUALSAFEMON	
47	C7, C8, C21, C22	DNP	0	C0603COG500-180JNE; C1608COG1H180J080AA; GRM1885C1H180J	VENKEL LTD.;TDK;MURATA	18PF	CAP; SMT (0603); 18PF; 5%; 50V; COG; CERAMIC	
48	C9, C10, C23, C24	DNP	0	GRM1885C1H102JA01; C1608COG1H102J080AA; GCM1885C1H102JA16	MURATA;TDK;MURATA	1000PF	CAP; SMT (0603); 1000PF; 5%; 50V; COG; CERAMIC	
49	C37, C38	DNP	0	06035C101JAT	AVX	100PF	CAP; SMT (0603); 100PF; 5%; 50V; X7R; CERAMIC	
50	J7	DNP	0	502584-0270	MOLEX	502584-0270	CONNECTOR; FEMALE; SMT; 502584 SERIES; STRAIGHT; 2PINS	
51	R4, R15, R24, R59, R62, R63	DNP	0	RC1608J000CS; CR0603-J-000ELF; RC0603JR-070RL	SAMSUNG ELECTRONICS; BOURNS;YAGEO PH	0	RES; SMT (0603); 0; 5%; JUMPER; 0.1000W	
52	R11, R22	DNP	0	CRCW0603100KFK; RC0603FR-07100KL; RC0603FR-13100KL; ERJ-3EKF1003; AC0603FR-07100KL	VISHAY DALE;YAGEO; YAGEO;PANASONIC	100K	RES; SMT (0603); 100K; 1%; +/-100PPM/DEGC; 0.1000W	
53	T3, T4, T7, T8	DNP	0	CEP99-102	SUMIDA	CEP99-102	TRANSFORMER; 8; 10KHZ; 15 TURN	
TOTAL			171					

MAX17851 EV Kit Schematics (continued)

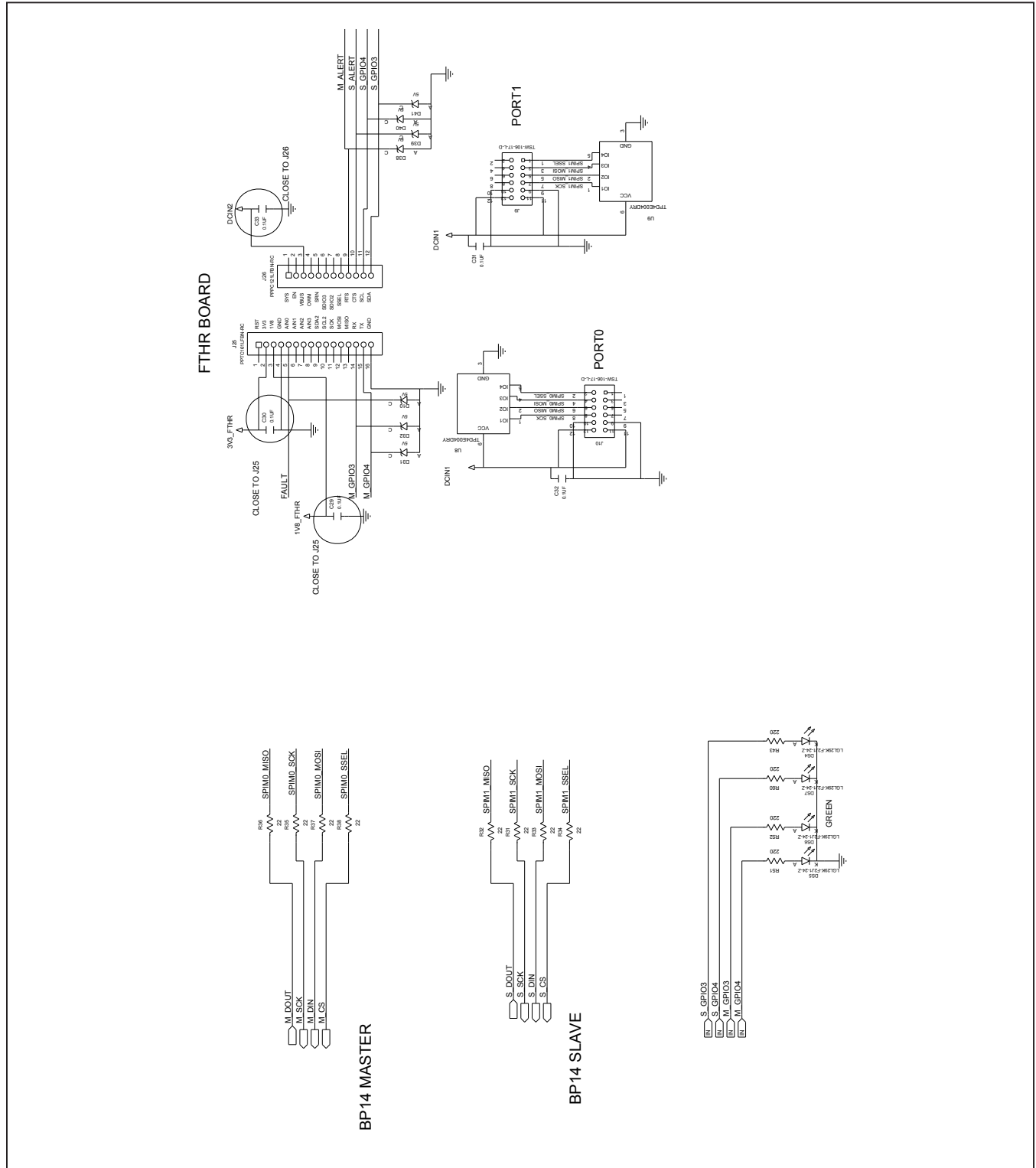

MAX17851 EV Kit PCB Layouts

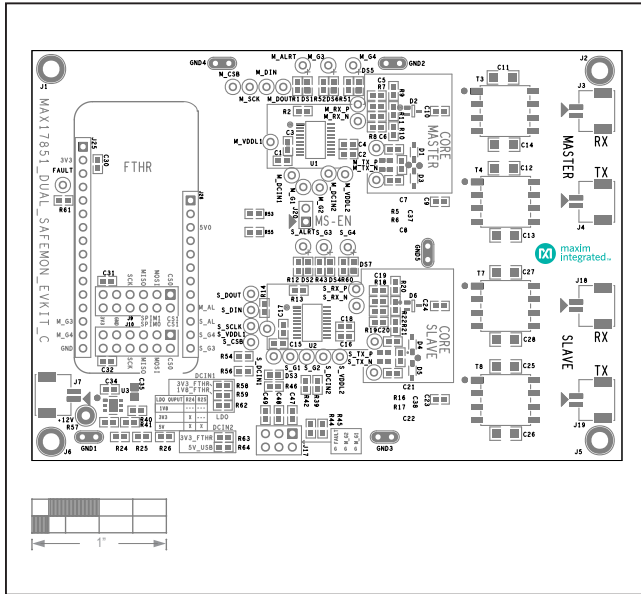

Silk Top

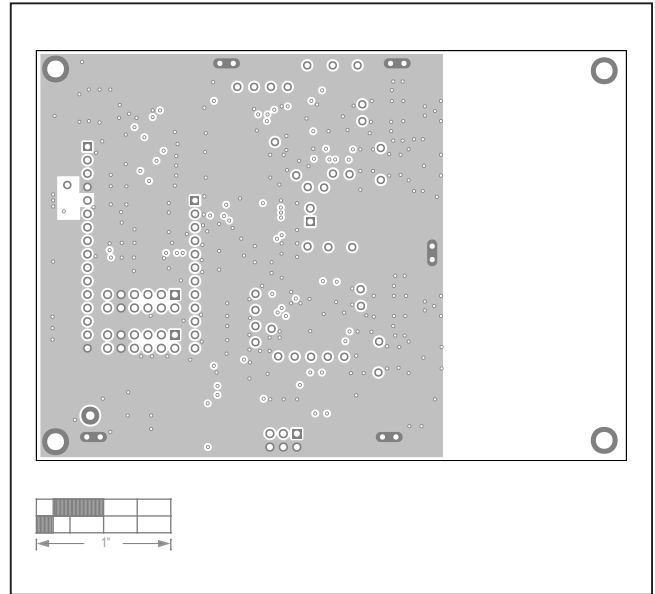

Layer 2

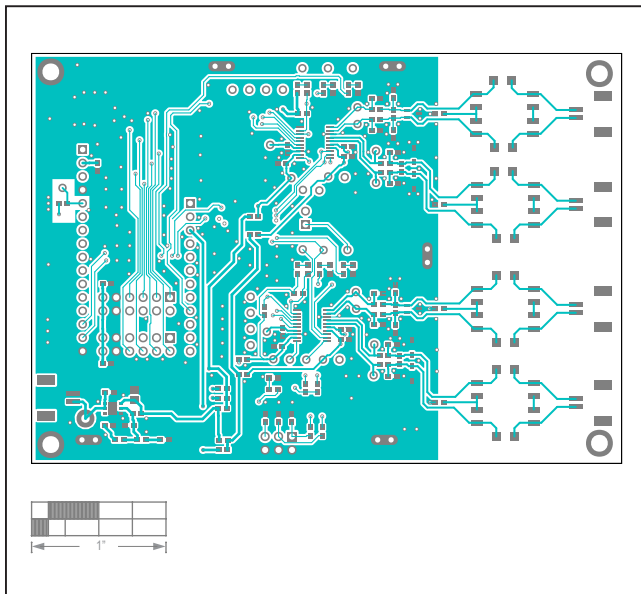

Top

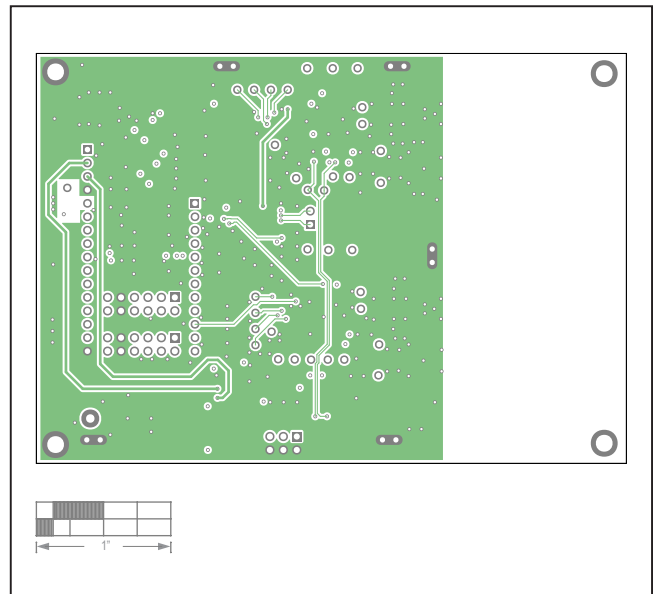

Layer 3

MAX17851 EV Kit PCB Layouts

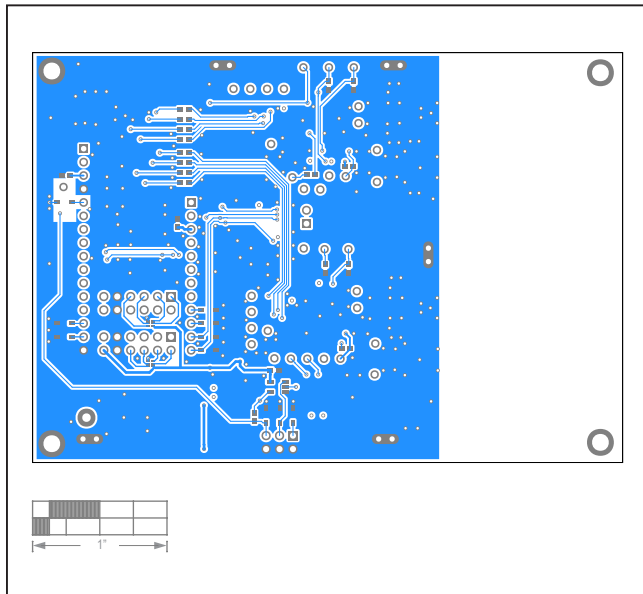

Bottom

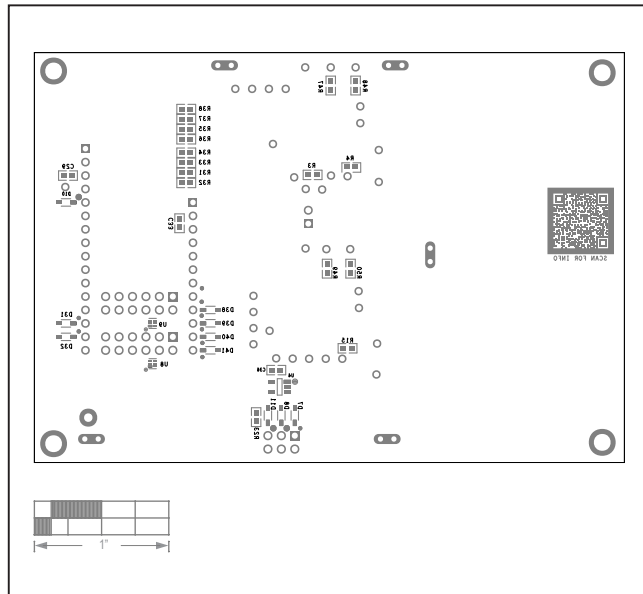

Silk Bottom

Revision History

REVISION NUMBER	REVISION DATE	DESCRIPTION	PAGES CHANGED
0	7/21	Initial release	—

For pricing, delivery, and ordering information, please visit Maxim Integrated's online storefront at <https://www.maximintegrated.com/en/storefront/storefront.html>.

Maxim Integrated cannot assume responsibility for use of any circuitry other than circuitry entirely embodied in a Maxim Integrated product. No circuit patent licenses are implied. Maxim Integrated reserves the right to change the circuitry and specifications without notice at any time.