

General Description

The MAX20038 evaluation kit (EV kit) demonstrates the MAX20038 automotive high-current, high-efficiency step-down DC-DC converter with integrated USB protection and host charger adapter emulation.

The IC features integrated host-charger port-detection circuitry adhering to the USB-IF BC1.2 battery charging specification, Apple® iPod®/iPhone®/iPad® and Samsung® charge-detection termination resistors, and Chinese Telecommunication Industry Standard YD/T 1591-2009.

The IC integrates high side current-sensing and voltage-adjustment circuitry that provides automatic USB voltage adjustment to compensate for voltage drops in captive cables associated with automotive applications.

The high-efficiency, step-down, synchronous, DC-DC converter operates from a voltage up to 28V and is protected from load dump transients up to 40V. The converter is programmable for frequencies from 275kHz to 2.2MHz and can deliver 3A of continuous current at 105°C.

The EV kit is populated with an I²C-enabled MAX20038. The I²C interface allows for flexible configuration, detailed fault diagnostics, and access to the on-chip ADC that reports output voltage and current. The I²C features are easily accessed by using the Maxim command module (MINIUSB) along with the provided example GUI.

The EV kit is configured for 2.2MHz operation, and the included 3m USB cable allows for demonstration of the cable compensation capability of the IC. The high-voltage data switches of the MAX20038 require data line tuning to achieve an optimal eye diagram. The EV kit comes populated with tuning components optimized for use with the supplied cable. Refer to Figure 19 in the MAX20037/MAX20038 IC data sheet for the MAX20038 tuned near-eye diagram.

Apple, iPod, iPhone, and iPad are registered trademarks of Apple Inc.

Samsung is a registered trademark of Samsung Electronics Co., Ltd..

Benefits and Features

- Configurable Charge-Detection Modes
 - USB-IF BC1.2 CDP, DCP
 - Apple 2.4A, 1.0A
 - China YD/T1591-2009 Charging Specification
- Automatic USB Voltage Adjustment by Integrated DC-DC Converter (275kHz to 2.2MHz)
- Proven PCB Layout
- Fully Assembled and Tested

Quick Start

The following procedure demonstrates the MAX20038's voltage-adjustment capability and I²C interface.

Required Equipment

- MAX20038 EV kit
- MINIUSB EV kit and MAX20038 example GUI
- Included 3m USB captive cable
- 2Ω, 20W resistor or electronic load connected to a Type-A USB 2.0 connector (plug)
- 12V, 2A DC power supply or car battery (Supply A)
- 3.3V, 1A DC power supply (Supply B)
- Two digital voltmeters (DVM1, DVM2) or one oscilloscope

[Ordering Information](#) appears at end of data sheet.

Procedure

The EV kit is fully assembled and tested. Follow the steps below to verify board operation:

- 1) Connect Supply A (turned off) between the VBAT and GND test points.
- 2) Connect Supply B (turned off) between the 3V3 header and GND test point.
- 3) Connect USB cable, but leave the load disconnected.
- 4) Connect DVM1 (or oscilloscope channel 1) between the USB_5V and GND test points on the EV kit (this is the output of the buck).
- 5) Connect DVM2 (or oscilloscope channel 2) to VBUS and GND at the far-end of the USB cable (this is the voltage a portable device sees).
- 6) Power on Supply A at 12V with a 2A current limit and Supply B at 3.3V with a 0.2A current limit.
- 7) Both DVM1 and DVM2 should measure approximately 5V.
- 8) Establish I²C communication with the GUI:
 - a) Visit <https://www.maximintegrated.com/en/design/tools/applications/evkit-software/index.mvp?id=1330> to download and install the MAX20038 example GUI and MINIQUSB drivers.
 - b) Using the supplied jumper wires, connect the MINIQ pins labeled SDA, SCL, and GND to the appropriate EV kit headers.
 - c) Connect the MINIQUSB module to a PC through a USB cable.
 - d) Open the MAX20038 example GUI and look at the message bar at the bottom of the GUI to verify that both the MINIQUSB and the EV kit are detected.
- 9) Connect the load to the end of the USB cable.
- 10) With the voltage adjustment disabled (GAIN = 0x0; default setting), measure the voltage:
 - a. The voltage at the buck output (USB_5V) should still be approximately 5V. There is a slight drop due to load regulation and the current through the SENSE resistor, output filter, and PCB trace.
 - b. The voltage at the far end of the USB cable will be noticeably below 5V. The voltage drop is caused by the load current flowing through the cable resistance.
- 11) Using the GAIN drop-down list in the GUI, set the gain to 661mΩ, which is the maximum setting.

- 12) The voltage at the buck output should increase to 6.8V, and the voltage at the end of the USB cable should now be approximately 5V.
- 13) The far-end voltage can be fine-tuned by adjusting the GAIN register to match the specific cable. Once the GAIN register is adjusted correctly, the far-end voltage should maintain 5V regardless of load current.

Optional: Using the On-Chip ADC

- 14) Ensure that the **Read V/I ADC** and **Auto Read** checkboxes are checked.
- 15) Click on the **Int ADC V/I Done** checkbox. **USB_V** and **USB_I** will update with the voltage on SENSEP and the voltage across R_{SENSE} respectively.
 - a. The ADC values updates once for every write of **Int ADC V/I Done**.

Detailed Description

The MAX20038 EV kit comes fully assembled, tested, and installed with a MAX20038ATIA/V+ IC. Stand-alone variants can be used on this EV kit by changing the IC and configuration resistors.

EV Kit Interface

Header J1 includes input and output test points for controlling the IC and evaluating its functionality. [Table 1](#) lists the individual pins and their functions.

Table 1. External Header (J1)

PIN	NAME	DESCRIPTION
1	3V3	EV kit 3.30V (input)
2	SYNC	Buck regulator SYNC (input/output)
3	CDP/DCP	Charge-detection configuration pin (input)
4	HVEN	Active-high IC enable (input)
5	ENBUCK	Active-high DC-DC enable (input)
6	FAULT	Active-low fault indicator (output)
7	INT (ATTACH)	I ² C interrupt (output)
8	SCL	I ² C clock
9	SDA	I ² C data
10	GND	EV kit ground

Table 2. External Switch (SW1)

PIN	POSITION	DESCRIPTION
HVEN	0	Device disabled
	1	Device enabled
ENBUCK	0	Buck output disabled
	1	Buck output enabled
SYNC	0	Skip mode (only if configured as an input)
	1	Forced-PWM mode
CDP_DCP	0	Default to Auto CDP mode
	1	Keep pin low on I ² C variant

Switch SW1 allows the user to switch the value on the HVEN, ENBUCK, SYNC, and CDP/DCP pins. Setting the switch to the ON/1 position ties the connected pin to the 3.3V supply and setting the switch to the OFF/0 position ties the pin to ground. To externally control these pins through the J1 header, set the switch to the OFF/0 position. This leaves the pin connected to the header with a pulldown resistor. [Table 2](#) describes the switch and its functionality.

Connect battery-voltage input between the VBAT and GND test loops and 3.3V to the 3V3 pin on J1. The IC's DC-DC converter output voltage can be measured between the USB_5V and GND test points, or between the ground and VBUS pins of the USB connector. To disable the voltage-adjustment feature, set the GAIN register to zero (default). Setting the HVEN switch to one pulls the HVEN pin to 3V3 and enables the device. SYNC can be pulled to the 3V3 node for forced-PWM operation (when configured as an input), or configured to output the internal oscillator. Pull the ENBUCK pin low to disable DC-DC converter operation. The $\overline{\text{FAULT}}$ output is active low. The charge mode can be configured through I²C, by starting the part with the CDP_DCP pin low. Refer to the MAX20037/MAX20038 IC data sheet for details

PCB Layout Guidelines

A good PCB layout is critical to proper system performance. The loop area of the DC-DC conversion circuitry must be minimized. Place the input capacitor, power inductor, and output capacitor as close to the IC as possible. Shorter traces should be prioritized over wider traces.

A low-impedance ground connection between the input and output capacitors is necessary (route through the ground pour on the exposed pad). Connect the exposed pad to ground. Place multiple vias in the pad to connect to all other ground layers for proper heat dissipation (failure to do this may result in the IC repeatedly reaching thermal shutdown). Do not use separate power and analog grounds; use a single common ground, as high-frequency return currents flow directly under the corresponding traces.

USB traces must be routed as a 90 Ω differential pair with an appropriate keep-out area. Avoid routing USB traces near high-frequency switching nodes, or other sources of noise such as clocks. The length of the routing should be minimized and avoid 90° turns, excessive vias, and RF stubs. LC tuning components are required for the MAX20038. Place components close to the IC, use high-Q wire-wound inductors, and contact the Maxim applications team for support.

Ordering Information

PART	TYPE
MAX20038EVKIT#	EV Kit

#Denotes RoHS compliant.

MAX20038 EV Kit Bill of Materials

REFERENCE	QTY	DESCRIPTION	MANUFACTURER NUMBER	MANUFACTURER
C1	1	Ceramic Capacitor (0805) 2.2nF 100V 10% X6S	GCM216R72A222KA37D	Murata
C2	1	Electrolytic Capacitor (SMD) 47uF 25V 20%	EEE-HC1E470XP	Panasonic
C3	2	Ceramic Capacitor (0402) 0.22uF 35V 10% X7R	CGA2B1X7R1V224KC	TDK
C4	1	Open	---	Open
C5	1	Ceramic Capacitor (1206)10uF 35V 10% X7R	CGA5L1X7R1V106KC	TDK
C6	1	Open	---	Open
C7	1	Ceramic Capacitor (1210) 22uF 25V 10% X7R	GRM32ER71E226KE5L	Murata
C8	1	Ceramic Capacitor (0603) 1uF 16V 10% X7R	CGA3E1X7R1C105K080AC	TDK
C9	1	Ceramic Capacitor (0402) 1uF 10V 10% X7S	GCM155C71A105KE38D	Murata
C10-11	2	Ceramic Capacitor (0402) 6pF 50V C0G	GCM1555C1H6R0CA16D	Murata
C12, C20	2	Ceramic Capacitor (0402) 0.1uF 50V 10% X7R	CGA2B3X7R1H104K050BB	TDK
C13-14	2	Ceramic Capacitor (0402) 2pF 50V C0G	GCM1555C1H2R0CA16D	Murata
C15	1	Ceramic Capacitor (0603) 2.2uF 16V 10% X7S	CGA3E1X7S1C225KC	TDK
C16	1	Ceramic Capacitor (0402) 100pF 50V 5% C0G	CGA2B2C0G1H101J050BA	TDK
C17, C21-C23	4	Open	---	Open
C18	1	Open	---	Open
D1	1	Open	---	Open
D2	1	Schottky Diode (SMB) 3A 60V	B360B-13-F	Diodes Inc
GND, GND1, USB_5V, VBAT	4	Test Point	5024	Keystone
J1	1	1x10 .100" Gold Header	5-146858-1	TE Connectivity
J2	1	USB A Receptacle	KUSBX-SMT-AS1N-B30	Kycon
J3	1	USB A Plug	KUSBX-SMT2AP5S-B	Kycon
L1	1	Ferrite Bead (1206)	74279221601	Würth
L2	1	Ferrite Bead (1806)	BLM41P600S	Murata
L3, L4	2	Inductor, 15nH, 0402	LQW15AN15N8ZD	Murata
L6, L7	2	Inductor, 4.7nH, 0402	LQW15AN4N7B8ZD	Murata
L5	1	Inductor, 1.5uH, 8.5A Isat	XEL4030-152MEB	Coilcraft
R1	1	Resistor (1206) .033Ω 1%, 1W, 75ppm	ERJ-MP2MF33MU	Panasonic
R2, R8-14	8	Resistor (0402) 100k Ohm 1%	CRCW0402100KFKED	Vishay Dale
R3-4, R7, R15-16	5	Open	---	Open
R17	1	Resistor (0402) 0 Ohm	RK73Z1ETTP	KOA Speer
SW1	1	1.27mm Pitch DIP Switch	TDA04H0SB1R	C&K Components
U1	1	5mm x 5mm 28 pin QFN	MAX20038ATIAV+	Maxim Integrated Products, Inc.
---	1	PCB: MAX20038 EVALUATION KIT	MAX20038EVKIT#	Maxim Integrated Products, Inc.
---	3	Jumper Wire (pack contains 100 total)	920-0140-01	SchmartBoard
---	1	3m USB Type A plug to receptacle extension cable	52108	C2G (Cables to Go)

MAX20038 EV Kit Schematic

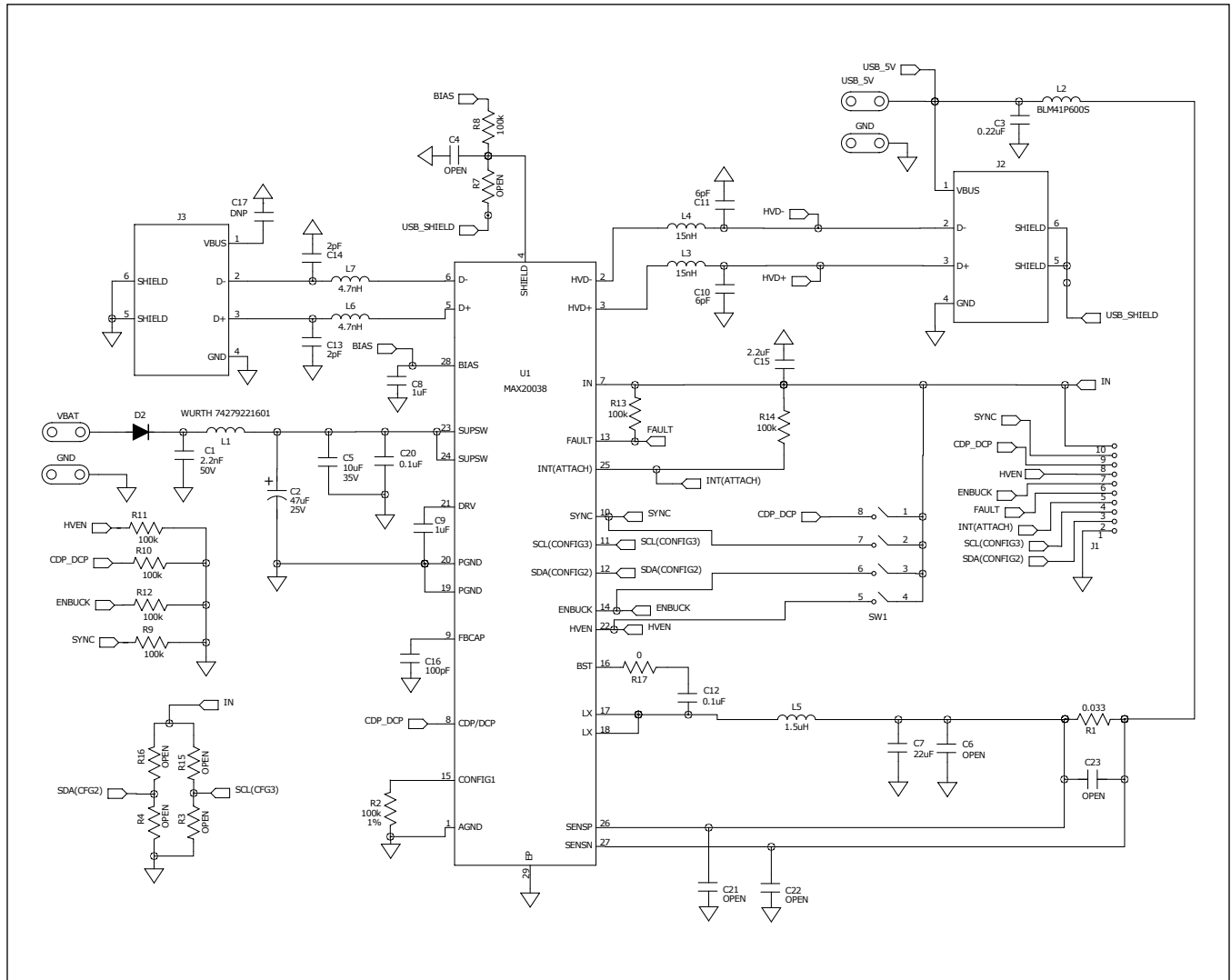

MAX20038 EV Kit PCB Layouts

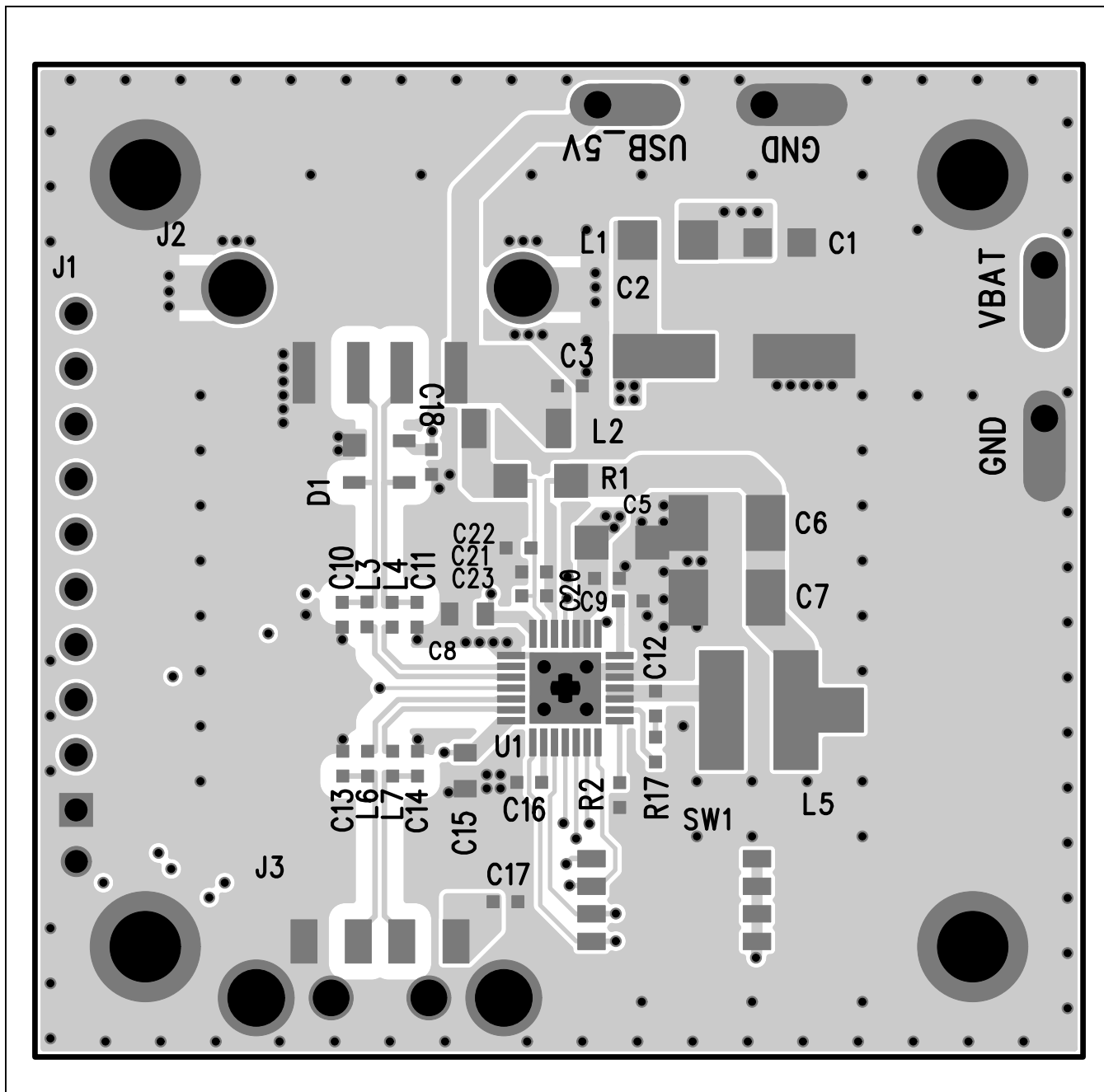

MAX20038 EV Kit PCB Layout—Top Layer

MAX20038 EV Kit PCB Layouts (continued)

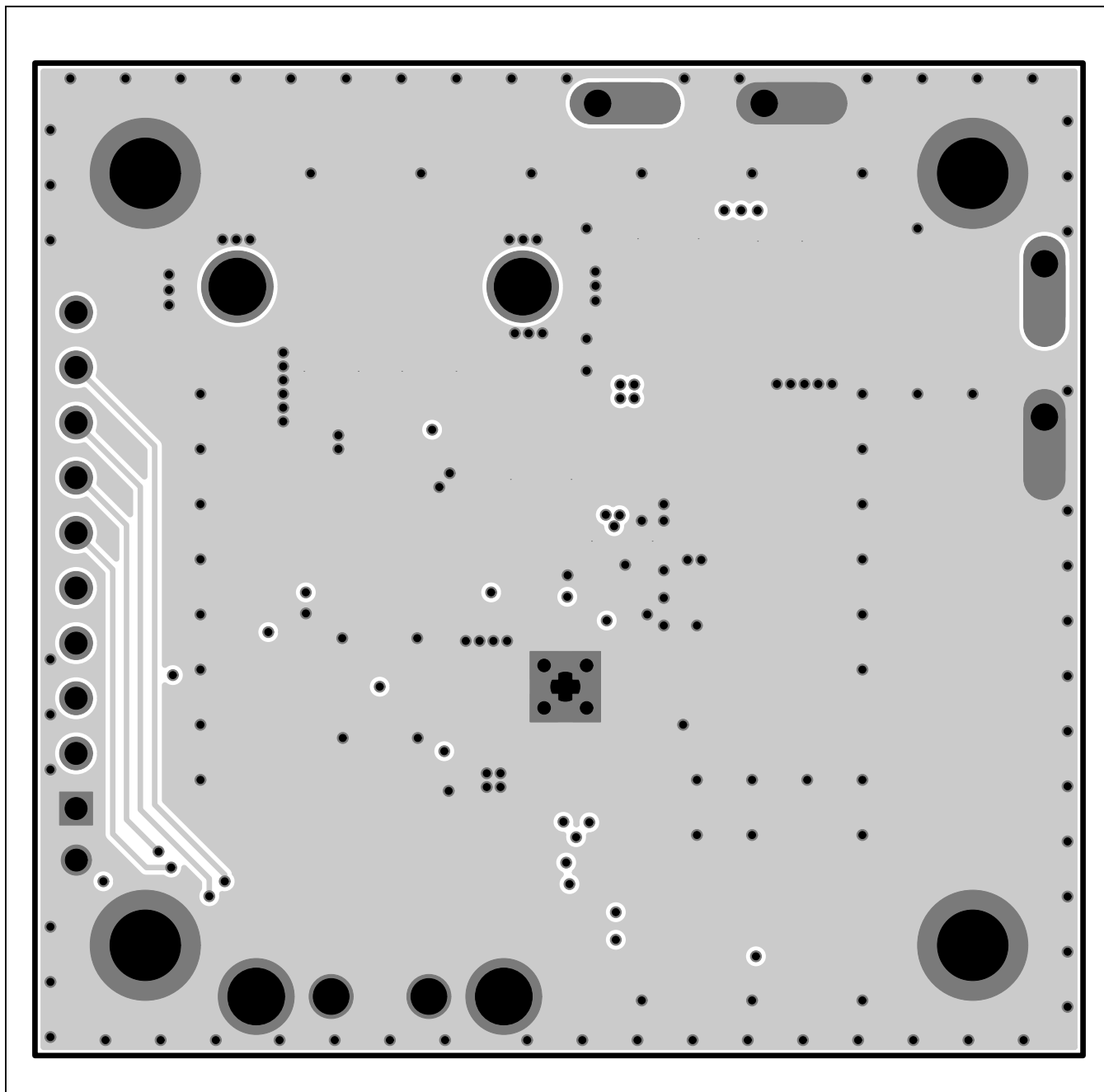

MAX20038 EV Kit PCB Layout—Layer 2

MAX20038 EV Kit PCB Layouts (continued)

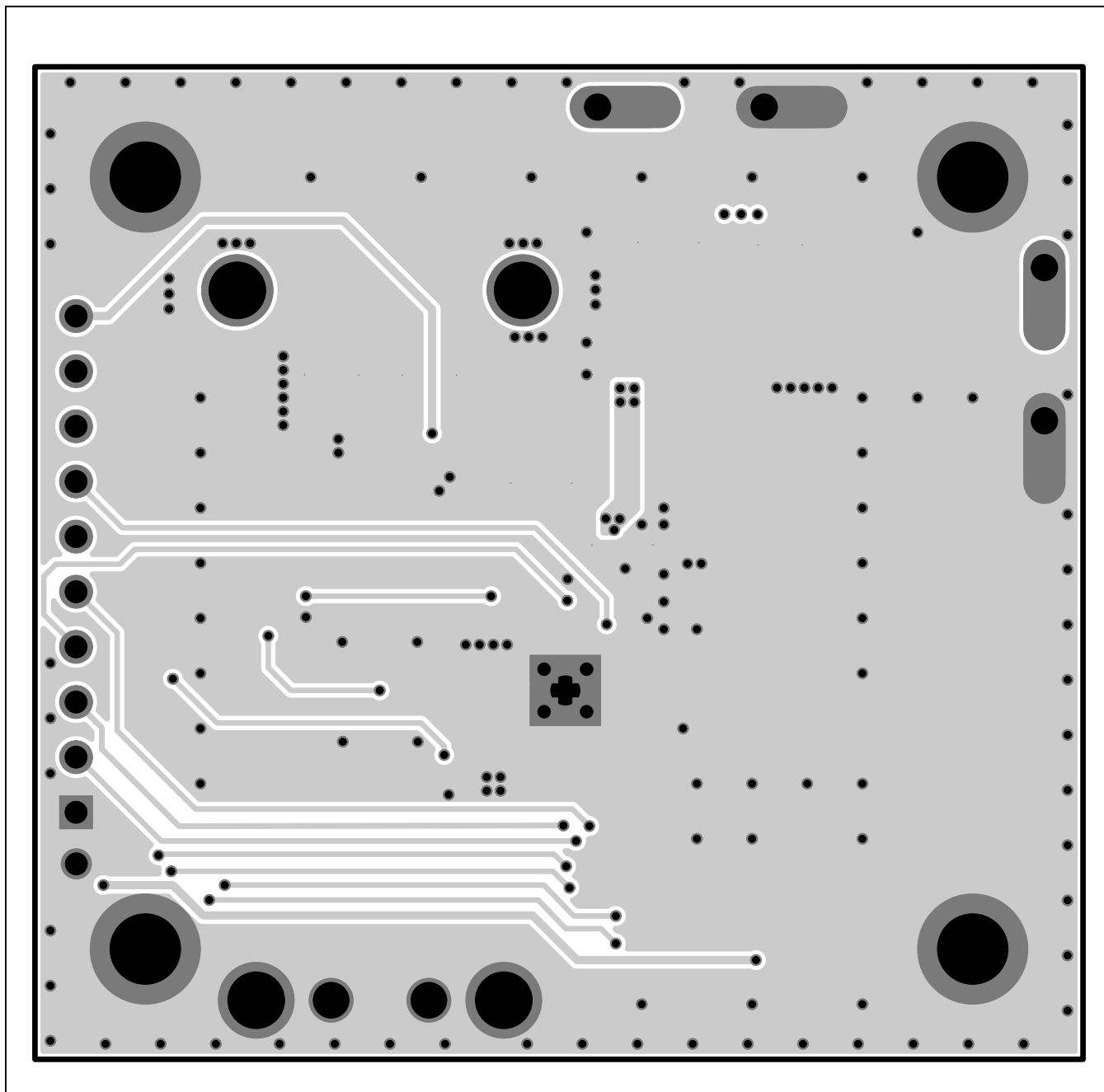

MAX20038 EV Kit PCB Layout—Layer 3

MAX20038 EV Kit PCB Layouts (continued)

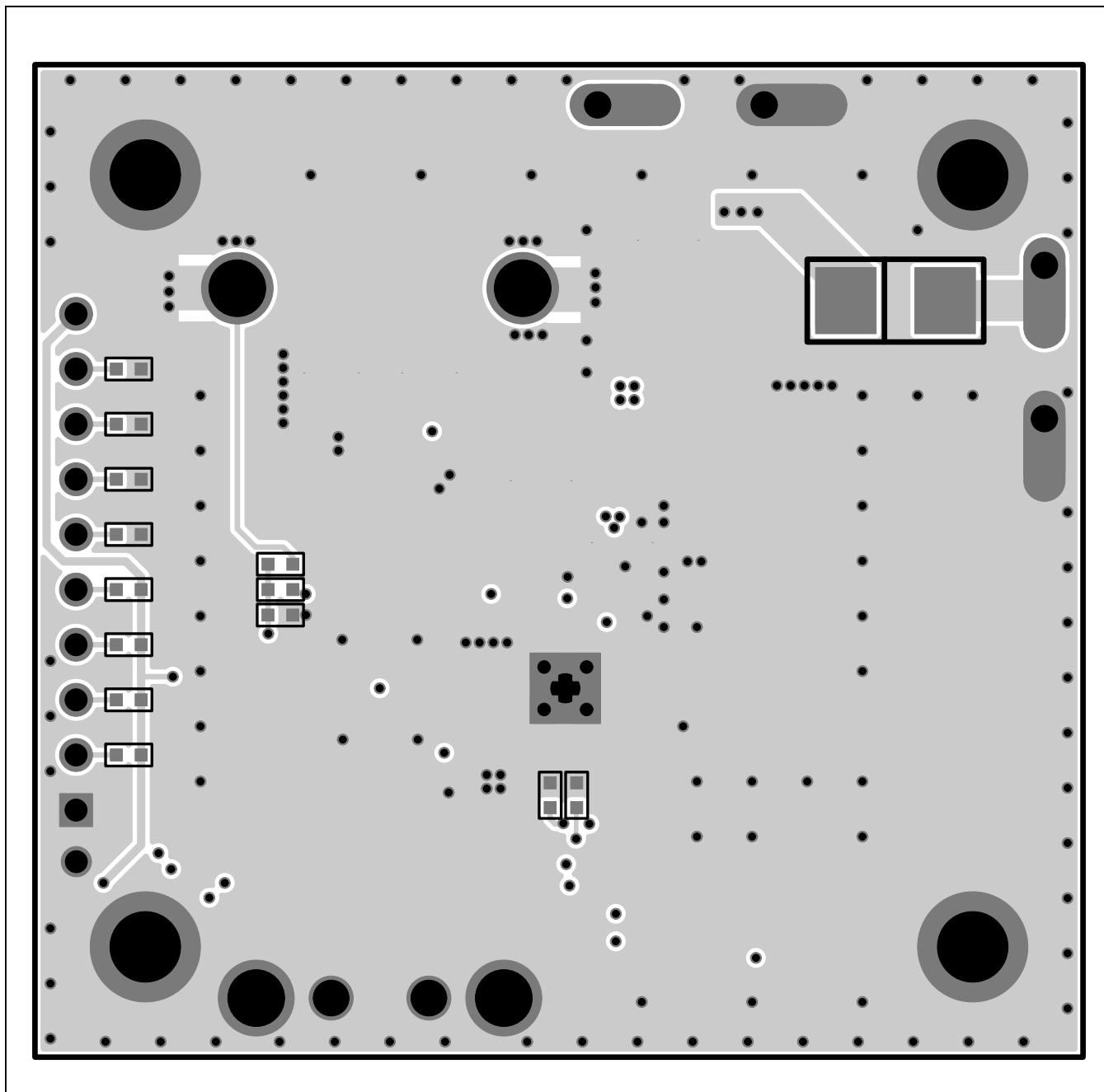

MAX20038 EV Kit PCB Layout—Bottom Layer

MAX20038 EV Kit PCB Layouts (continued)

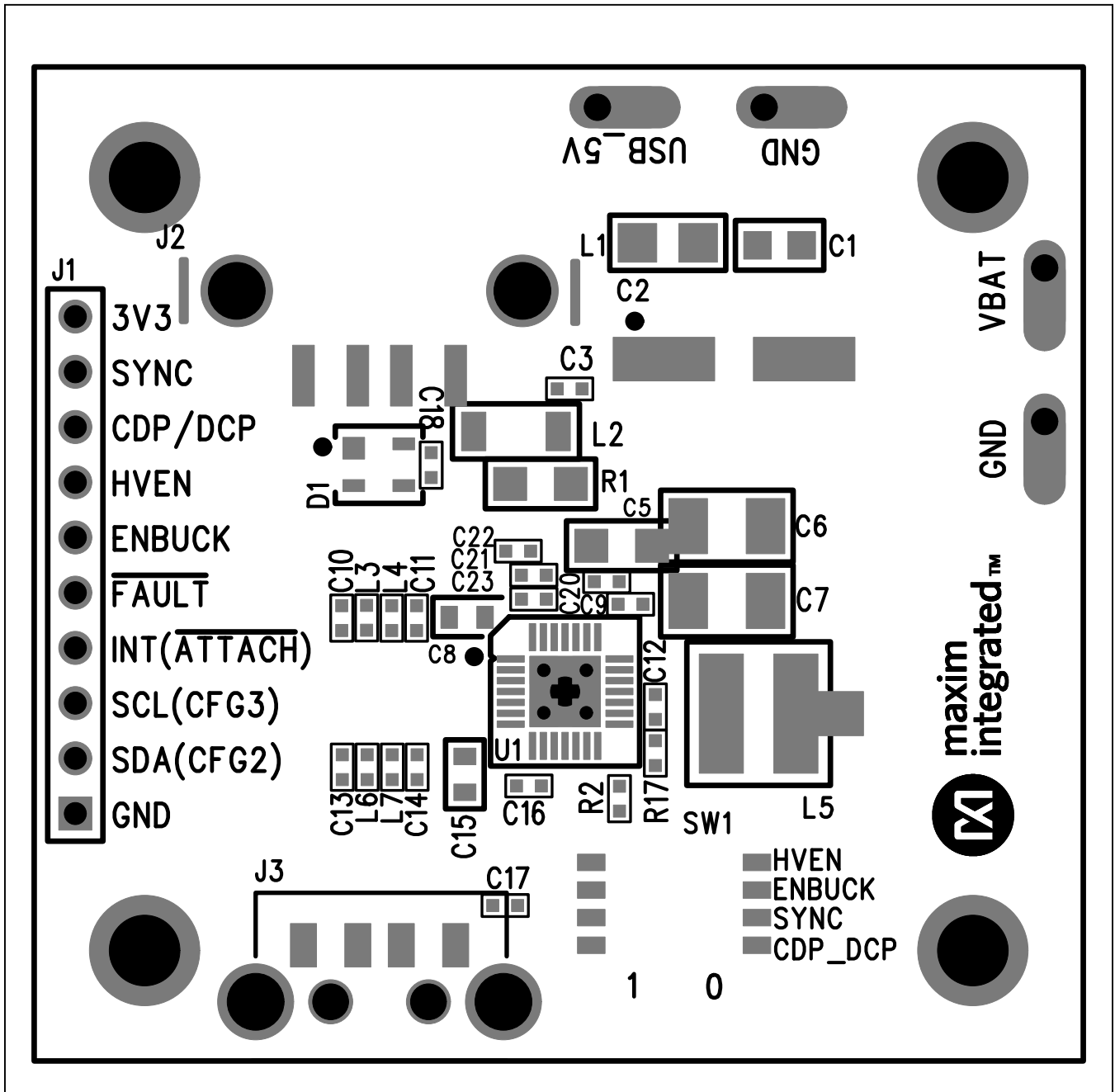

MAX20038 EV Kit PCB Layout—Top Silkscreen

MAX20038 EV Kit PCB Layouts (continued)

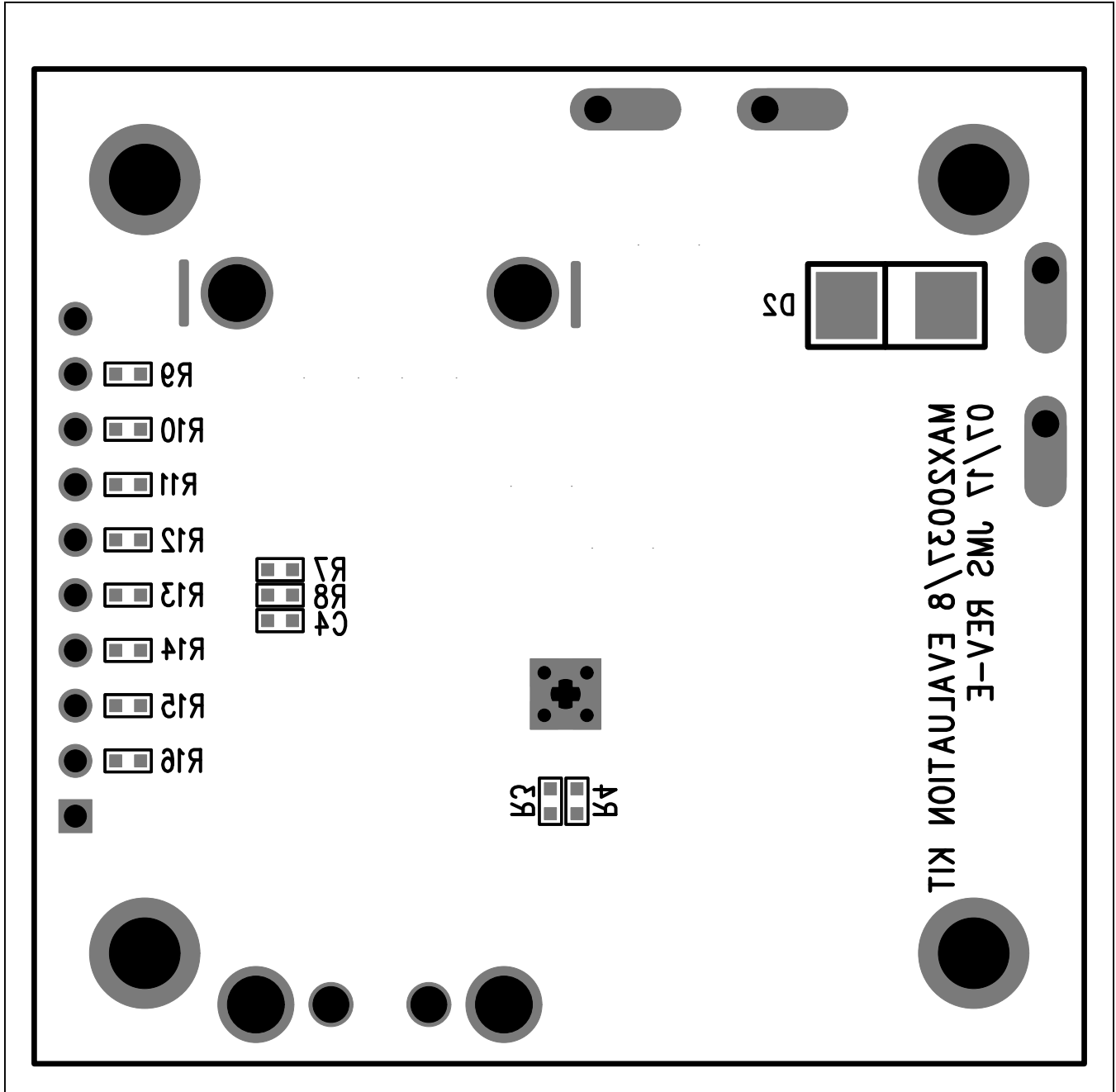

MAX20038 EV Kit PCB Layout—Bottom Silkscreen

Revision History

REVISION NUMBER	REVISION DATE	DESCRIPTION	PAGES CHANGED
0	3/18	Initial release	—

For pricing, delivery, and ordering information, please contact Maxim Direct at 1-888-629-4642, or visit Maxim Integrated's website at www.maximintegrated.com.

Maxim Integrated cannot assume responsibility for use of any circuitry other than circuitry entirely embodied in a Maxim Integrated product. No circuit patent licenses are implied. Maxim Integrated reserves the right to change the circuitry and specifications without notice at any time.