

MAX20796 Discrete Inductor Evaluation Kit

Evaluates: MAX20796 and MAX20766

General Description

The MAX20796 Discrete Inductor evaluation kit (EV kit) provides a proven design to evaluate the MAX20796 fully-integrated, two-phase switching regulator. The MAX20766 can be installed on the EV kit for a three-phase switching regulator operation. The EV kit operates from a 4.5V to 16V input voltage range and supports an output voltage range of 1.8V to 5V. The board uses the MAX20796 on a proven eight-layer PCB design.

Features

- 4.5V to 16V Input Voltage Range
- 1.8V to 5V Output Voltage Range
- Banana Jacks for Input and Output Voltage
- SMB Coaxial Cable Jacks for Output Voltage Measurement and SYNC Clock Input and Output
- Configurable Output Voltage and Compensation Parameters
- Adjustable Current Limit
- PMBus Header for Connection to the MAXPOWERTOOL002# Dongle
- FAULT and PG Outputs
- Enable Input and Enable Debounce Circuit
- Fully Assembled and Tested

[Ordering Information](#) appears at end of data sheet.

Quick Start

Required Equipment

- MAX20796 EV kit assembly
- One 12V DC power supply (PS1) capable of delivering 20A current
- Voltmeters

Procedure

The EV kit is fully assembled and tested. Follow the steps below to verify board operation.

Caution: Do not turn on the power supply until all connections are completed.

- 1) Verify that a shunt is installed across jumpers JP1 and J13.
- 2) Make sure switches S1 and S2 are in the off position.
- 3) Turn on power-supply PS1 and set the supply to 12V, then disable the power supply.
- 4) Connect the positive terminal of power-supply PS1 to the J5 banana jack on the EV kit. Connect the negative terminal of the power supply to the J8 banana jack.
- 5) Enable the power supply.
- 6) Toggle the S1 switch in the On position. The switch should turn GREEN.
- 7) Toggle the S2 switch in the On position. The switch should turn GREEN.
- 8) Verify that the voltage between the V_{OUT} and GND pins at jumper JP2 is 3.3V.
- 9) The EV kit is now ready for additional evaluation.

MAX20796 Discrete Inductor Evaluation Kit

Evaluates: MAX20796 and MAX20766

Detailed Description of Hardware

The MAX20796 Discrete Inductor EV kit provides a proven design to evaluate the MAX20796, fully integrated, highly efficient, two-phase switching regulator. MAX20766 can be installed on the EV kit for a three-phase switching regulator operation. The power input and load can be easily connected using the banana jacks and connectors provided for the input and output. Test points and connectors are provided to monitor and control the device signals. The EV kit operates between input voltage of 4.5V to 16V. The EV kit regulates the output voltage between 1.8V to 5V. The EV kit must always be operated within SOA limit defined in MAX20796 data sheet.

Two and Three-Phase Operation

The schematic is drawn for 3-phase (3PH) operation by default. For 2-phase (2PH) operation, the schematic annotates the changes in the components' values. For 2PH operation, MAX20766 is DNI and two discrete inductors are used.

AUX3P3 Power Supply for the EV Kit

The EV kit AUX3P3 power supply enable input is controlled by switch S1. If S1 is in the off position, the EN pin is forced to GND and the device regulation is disabled. If S1 is in the on position, the EN pin is pulled up

to V_{IN} and the device regulation is enabled. A JP1 jumper is also provided on board to connect or disconnect this power supply from the rest of the board. See [Table 1](#) for JP1 settings.

EN Input for the MAX20796

The device's enable input is controlled by switch S2. If S2 is in the off position, the EN pin is forced to GND and device regulation is disabled. If S2 is in the On position, the EN pin is pulled up to 3.3V and device regulation is enabled. Additionally, a test point (EN) is also provided to drive the EN pin.

LDO Input voltage selection (VLDOIN)

The LDO input range for this device is 2.97V to 16V. This board offers options to choose the LDO input from 3.3V (AUX3P3 supply), V_{IN} , and 3.0V regulated by the EB pin and external NFET. Jumpers J1 and J2 are used for this selection. See [Table 2](#) for J1 and J2 settings.

3.3V Pullup for SCL, SDA and ALERT

Jumper J13 is used to pull up the SCL, SDA, and ALERT pins to 3.3V. See [Table 3](#) for J13 settings.

Table 1. JP1 Jumper Selection

SHUNT POSITION	AUX3P3 POWER SUPPLY TO THE BOARD
Installed*	Connected
Not installed	Not connected

*Default position.

Table 2. J1 and J2 Jumper Selection

JUMPER CONNECTIONS	VLDOIN VOLTAGE
J1 not installed and J2 not installed*	3.0V regulated by the EB pin and external NFET
J1 installed and J2 not installed	V_{IN}
J1 not installed and J2 installed	3.3V powered by the AUX3P3 supply on board

*Default position.

Table 3. J13 Jumper Selection: Pullup for SCL, SDA and ALERT pins

SHUNT POSITION	PULLUP TO 3.3V
Installed*	Enabled
Not installed	Disabled

*Default position.

MAX20796 Discrete Inductor Evaluation Kit

Evaluates: MAX20796 and MAX20766

Bode Plot

A 10Ω resistor is installed between the V_{OUT} sense point and SNSP pin to measure the bode plot. TP3 and TP32 test points are provided on the board on either side of the 10Ω resistor for small signal injection and ability to measure bode plot.

Output Regulation

TP38 and TP40 are provided to measure the V_{OUT} regulation.

Efficiency Measurement

VinEffP and VinEffN are provided to measure V_{IN} during efficiency measurement. Additionally, TP9 and TP10 are provided to measure V_{OUT} during efficiency measurement.

For accurate efficiency measurements, remove R23, disable the 3.3V supply U2 with switch S1, and remove JP1 to supply the AUX3P3 rail from a separate supply.

Pin-Strap Programmability

The EV kit provides an option to configure the part for desired application using PGMx resistor values. Appropriate values of resistors R15-R20 can be used for desired application.

SYNC Feature

The EV kit provides an SMB pin for external SYNC_IN signal so that switching frequency can be set using an external source. The SYNC_IN pin has 50Ω termination on the EV kit. An SMB pin for an external SYNC_OUT signal is present so that the EV kit can act as master for any other MAX20796 device and for setting its switching frequency. The SYNC_OUT signal is disabled by default on the EV kit.

Ordering Information

PART	TYPE
MAX20796DL2EVKIT#	2PH EV kit
MAX20796DL3EVKIT#	3PH EV kit

#Denotes a RoHS-compliant device that may include lead that is exempt under the RoHS requirements.

MAX20796 Discrete Inductor
Evaluation Kit

Evaluates: MAX20796 and MAX20766

MAX20796 Discrete Inductor EV Kit Bill of Materials—2 Phase

ITEM	REF DES	DNI/DNP	QTY	MFG PART #	MANUFACTURER	VALUE	DESCRIPTION
1	ALERT_N, SCL, SDA, TP22-TP30, TP33	-	13	5002	KEYSTONE	N/A	TEST POINT; PIN DIA=0.1IN; TOTAL LENGTH=0.3IN; BOARD HOLE=0.04IN; WHITE; PHOSPHOR BRONZE WIRE SILVER;
2	C1, C11, C93, C94	-	4	GMK105BJ104KV	TAIYO YUDEN	0.1UF	CAPACITOR; SMT (0402); CERAMIC; 0.1UF; 35V; TOL=10%; TG=-55 DEGC TO +85 DEGC; TC=X5R
3	C2, C12	-	2	C0603C104K5RAC; C1608X7R1H104K; ECJ-1VB1H104K; GRM188R71H104KA93; CGJ3E2X7R1H104K080AA; C1608X7R1H104K080AA; CL10B104KB8NNN; CL10B104KB8NFN	KEMET;TDK; PANASONIC; MURATA;TDK;TDK; SAMSUNG ELECTRO-MECHANICS; SAMSUNG ELECTRONICS	0.1UF	CAPACITOR; SMT (0603); CERAMIC CHIP; 0.1UF; 50V;TOL=10%; TG=-55 DEGC TO +125 DEGC; TC=X7R;
4	C3, C4, C13, C14, C95, C96	-	6	C3216X5R1E226M160AB	TDK	22UF	CAPACITOR; SMT (1206); CERAMIC CHIP; 22UF; 25V; OL=20%; MODEL=C SERIES; TG=-55 DEGC TO +85 DEGC; TC=X5R
5	C5, C6, C15, C16, C84, C97, C98	-	7	C3216X5R1E476M160AC	TDK	47UF	CAPACITOR; SMT (1206); CERAMIC CHIP; 47UF; 25V; TOL=20%; MODEL=C SERIES; TG=-55 DEGC TO +85 DEGC; TC=X5R ;
6	C7	-	1	GRM155R71E472KA01	MURATA	4700PF	CAPACITOR; SMT (0402); CERAMIC CHIP; 4700PF; 25V;TOL=10%; TG=-55 DEGC TO +125 DEGC; TC=X7R
7	C8, C17, C25, C89-C92, C100	-	8	CGA2B3X7R1H104K050BB; C1005X7R1H104K050BB; GRM155R71H104KE14; GCM155R71H104KE02; C1005X7R1H104K050BE; UMK105B7104KV-FR; CGA2B3X7R1H104K050BE	TDK;TDK;MURATA; MURATA;TDK; TAIYO YUDEN;TDK	0.1UF	CAPACITOR; SMT (0402); CERAMIC CHIP;0.1UF; 50V; TOL=10%; TG=-55 DEGC TO +125 DEGC; TC=X7R
8	C9, C22, C23	-	3	C1608X5R1E475K080AC; GRM188R61E475KE11	TDK;MURATA	4.7UF	CAPACITOR; SMT (0603); CERAMIC CHIP; 4.7UF; 25V;TOL=10%; TG=-55 DEGC TO +85 DEGC; TC=X5R
9	C18, C24, C29, C30	-	4	GRM155R60J475ME87; GRM153R60J475ME15	MURATA;MURATA	4.7UF	CAPACITOR; SMT (0402); CERAMIC CHIP; 4.7UF; 6.3V;TOL=20%; TG=-55 DEGC TO +85 DEGC; TC=X5R
10	C19	-	1	C0402C103K5RAC; GRM155R71H103KA88; C1005X7R1H103K050BE; CL05B103KB5NNN	KEMET;MURATA;TDK; SAMSUNG ELECTRONIC	0.01UF	CAPACITOR; SMT (0402); CERAMIC CHIP; 0.01UF; 50V;TOL=10%; TG=-55 DEGC TO +125 DEGC; TC=X7R
11	C20, C21, C99	-	3	C0402C105K8PAC; CC0402KRX5R6BB105	KEMET;YAGEO	1UF	CAPACITOR; SMT (0402); CERAMIC CHIP; 1UF; 10V;TOL=10%; TG=-55 DEGC TO +85 DEGC; TC=X5R
12	C26, C28, C101	-	3	GRM155R71C224KA12	MURATA	0.22UF	CAPACITOR; SMT (0402); CERAMIC; 0.22UF; 16V; TOL=10%;MODEL=GRM SERIES; TG=-55 DEGC TO +125 DEGC; TC=X7R
13	C33, C45	-	2	C0402C101J5GAC; NMC0402NPO101J; CC0402JRNPO9BN101; GRM1555C1H101JA01; C1005C0G1H101J050BA; CGA2B2C0G1H101J050BA	KEMET; NIC COMPONENTS CORP.; YAGEO PHICOMP; MURATA;TDK;TDK	100PF	CAPACITOR; SMT (0402); CERAMIC CHIP; 100PF; 50V;TOL=5%; TG=-55 DEGC TO +125 DEGC; TC=C0G
14	C36, C37	-	2	16SEP330M	PANASONIC	330UF	CAPACITOR; THROUGH HOLE-RADIAL LEAD; ELECTROLYTIC- OSCON; 330UF; 16V; TOL=20%
15	C38-C41	-	4	20TQC100MYF	PANASONIC	100UF	CAPACITOR; SMT (7343); TANTALUM CHIP; 100UF; 20V;TOL=20%; TG=- 55 DEGC TO +105 DEGC LOW ESR
16	C42	-	1	6TPF330M9L	PANASONIC	330UF	CAPACITOR; SMT (7343); TANTALUM CHIP; 330UF; 6.3V; TOL=20%; MODEL=TPF SERIES; TG=-55 DEGC TO +105 DEGC
17	C48, C51	-	2	GRM155R61A103KA01	MURATA	0.01UF	CAPACITOR; SMT (0402); CERAMIC CHIP; 0.01UF; 10V; TOL=10%;MODEL=GRM SERIES; TG=-55 DEGC TO +85 DEGC; TC=X5R
18	C55, C66, C72, C79, C81	-	5	EMK325ABJ107MM	TAIYO YUDEN	100UF	CAPACITOR; SMT (1210); CERAMIC CHIP; 100UF; 16V;TOL=20%; TG=-55 DEGC TO +85 DEGC; TC=X5R
19	C82, C83	-	2	ANY	ANY	10UF	CAPACITOR; SMT (0603); CERAMIC CHIP; 10UF; 16V; TOL=DEGC O +85 DEGC; TC=X5R; FORMFACTOR
20	C85, C87	-	2	C0603C105K4RAC; GRM188R71C105KA12; C1608X7R1C105K080AC; EMK107B7105KA; GCM188R71C105KA64; CGA3E1X7R1C105K080AC	KEMET;MURATA; TDK;TAIYO YUDEN; MURATA;TDK	1UF	CAPACITOR; SMT (0603); CERAMIC CHIP; 1UF; 16V; TOL=10%;MODEL=GRM SERIES; TG=-55 DEGC TO +125 DEGC; TC=X7R

MAX20796 Discrete Inductor
Evaluation Kit

Evaluates: MAX20796 and MAX20766

MAX20796 Discrete Inductor EV Kit Bill of Materials—2 Phase (continued)

ITEM	REF DES	DNI/DNP	QTY	MFG PART #	MANUFACTURER	VALUE	DESCRIPTION
21	C88	-	1	GRM155R71H332KA01	MURATA	3300PF	CAPACITOR; SMT (0402); CERAMIC CHIP; 3300PF; 50V;TOL=10%; TG=-55 DEGC TO +125 DEGC; TC=X7R
22	C102	-	1	GRM155R61A102KA01	MURATA	1000PF	CAPACITOR; SMT (0402); CERAMIC; 1000PF; 10V;TOL=10%; TG=-55 DEGC TO +85 DEGC; TC=X5R
23	D1, D2	-	2	MBR540T3G	ON SEMICONDUCTOR	MBR540T3	DIODE; SCH; SURFACE MOUNT SCHOTTKY POWER RECTIFIER; SMC; PIV=40V; IF=5A
24	H1-H4	-	4	2212	KEYSTONE	2212; MCH_SO_F_ HEX_6-32X1	STANDOFF; FEMALE-THREADED; HEX; 6-32; 1IN; ALUMINUM
25	H5-H8	-	4	PHILLIPS-FILLISTER_ D4.3MM/6-32X1/4IN	MAXIM	146721	MACHINE SCREW; PHILLIPS; FILLISTER; D4.3MM/6-32; 1/4IN; 18-8 STAINLESS STEEL
26	J1, J2, J13, JP1, JP2	-	5	PREC002SAAN-RC	SULLINS	PREC002SAAN-RC	CONNECTOR; MALE; THROUGH HOLE; HEADER; STRAIGHT; 2PINS
27	J3, J4, J7, J9	-	4	131-3701-266	JOHNSON COMPONENTS	131-3701-266	CONNECTOR; MALE; THROUGH HOLE; SMB JACK VERTICAL PCB MOUNT; STRAIGHT; 5PINS
28	J5, J8	-	2	6095	KEYSTONE	6095	CONNECTOR; FEMALE; PANELMOUNT; NON-INSULATED RECESSED HEAD BANANA JACK; STRAIGHT THROUGH; 1PIN
29	J6	-	1	PJ-102AH	CUI INC.	PJ-102AH	CONNECTOR; FEMALE; THROUGH HOLE; DC POWER JACK; RIGHT ANGLE; 3PINS
30	J10	-	1	TSW-108-07-T-D	SAMTEC	TSW-108-07-T-D	CONNECTOR; MALE; THROUGH HOLE; TSW SERIES;0.0125INCH SQUARE POST HEADER; STRAIGHT; 16PINS
31	J11	-	1	UPS-08-01-01-L-RA	SAMTEC	UPS-08-01-01-L-RA	CONNECTOR; FEMALE; THROUGH HOLE; DUAL LEAF POWER HEADER; RIGHT ANGLE; 8PINS
32	L2, L3	-	2	744309047	WURTH ELECTRONICS INC	470NH	INDUCTOR; SMT; MAGNETICALLY SHIELDED; 470NH; TOL=+/-20%; 47.5A
33	L4	-	1	LPS6235-333MR	COILCRAFT	33UH	INDUCTOR; SMT; MAGNETICALLY SHIELDED; 33UH; TOL=+/-20%; 1.3A
34	Q1	-	1	SQA410EJ-T1_GE3	VISHAY SILICONIX	SQA410EJ-T1_GE3	TRAN; AUTOMOTIVE N-CHANNEL MOSFET; NCH; SC70-6; PD-(13.6W); I-(7.8A); V-(20V)
35	Q2	-	1	2N7002	NXP	2N7002	TRAN; N-CHANNEL TRENCH MOSFET; NCH; SOT-23; PD-(0.83W); I-(0.3A); V-(60V)
36	R1	-	1	CRCW04023R00FK	VISHAY DALE	3	RESISTOR; 0402; 3 OHM; 1%; 100PPM; 0.063W; THICK FILM
37	R3-R5, R7, R10, R52-R59	-	13	CRCW04020000Z0EDHP; RCS04020000Z0	VISHAY DRALORIC; VISHAY DALE	0	RESISTOR; 0402; 0 OHM; 0%; JUMPER; 0.2W; THICK FILM
38	R13	-	1	CRCW040233R0FK	VISHAY DALE	33	RESISTOR; 0402; 33 OHM; 1%; 100PPM; 0.0625W; THICK FILM
39	R14, R26	-	2	CRCW040249R9FKEDHP	VISHAY DRALORIC	49.9	RESISTOR; 0402; 49.9 OHM; 1%; 100PPM; 0.2W; THICK FILM
40	R15	-	1	ERJ-2RKF1400	PANASONIC	140	RESISTOR; 0402; 140 OHM; 1%; 100PPM; 0.1W; THICK FILM
41	R16	-	1	CRCW04023012FK; CRCW040230K1FK	VISHAY DALE; VISHAY DALE	30.1K	RESISTOR; 0402; 30.1K; 1%; 100PPM; 0.0625W; THICK FILM
42	R17	-	1	CRCW040237R4FK; ERJ-2RKF37R4	VISHAY DALE; PANASONIC	37.4	RESISTOR; 0402; 37.4 OHM; 1%; 100PPM; 0.0625W; THICK FILM
43	R18	-	1	ERJ-2RKF1690	PANASONIC	169	RESISTOR; 0402; 169 OHM; 1%; 100PPM; 0.1W; THICK FILM
44	R19	-	1	CRCW0402976RFFK	VISHAY	976	RES; SMT (0402); 976; 1%; +/-100PPM/DEGC; 0.063W
45	R20	-	1	CRCW040245R3FKEDHP	VISHAY	45.3	RES; SMT (0402); 45.3; 1%; +/-100PPM/DEGC; 0.2W
46	R21	-	1	CRCW04021K40FK; RC0402FR-071K4L	VISHAY DALE; YAGEO PHICOMP	1.4K	RESISTOR; 0402; 1.4K OHM;1%; 100PPM; 1/6W; THICK FILM
47	R22	-	1	CR0402-16W-52R3FT; CRCW040252R3FK	VENKEL LTD.; VISHAY DALE	52.3	RESISTOR; 0402; 52.3 OHM;1%; 100PPM; 0.063W; THICK FILM
48	R23	-	1	CRCW04021K00FK; RC0402FR-071K1L; MCR01MZPF1001	VISHAY DALE; YAGEO PHICOMP; ROHM SEMI	1K	RESISTOR; 0402; 1K; 1%;100PPM; 0.0625W; THICK FILM
49	R25, R47	-	2	CRCW040210R0FK; 9C04021A10R0FL	VISHAY DALE; YAGEO	10	RESISTOR; 0402; 10 OHM;1%; 100PPM; 0.0625W; THICK FILM
50	R28	-	1	ERJ-8GEYJ101V	PANASONIC	100	RESISTOR; 1206; 100 OHM; 5%; 200PPM; 0.25W; THICK FILM
51	R30	-	1	ANY	ANY	100	RESISTOR; 0402; 100 OHM; 1%;100PPM; 0.0625W; THICK FILM; FORMFACTOR
52	R31, R34, R36-R40, R44	-	8	CRCW0402100KFK; RC0402FR-07100KL	VISHAY;YAGEO	100K	RESISTOR; 0402; 100K; 1%; 100PPM; 0.0625W; THICK FILM
53	R32, R46	-	2	CRCW0402150RFFK; 9C04021A1500FL	VISHAY DALE; YAGEO	150	RESISTOR; 0402; 150 OHM; 1%; 100PPM; 0.0625W; THICK FILM
54	R33	-	1	CRCW040237K4FK	VISHAY DALE	37.4K	RESISTOR; 0402; 37.4K OHM; 1%; 100PPM; 0.063W; THICK FILM

MAX20796 Discrete Inductor
Evaluation Kit

Evaluates: MAX20796 and MAX20766

MAX20796 Discrete Inductor EV Kit Bill of Materials—2 Phase (continued)

ITEM	REF DES	DNI/DNP	QTY	MFG PART #	MANUFACTURER	VALUE	DESCRIPTION
55	R41, R42	-	2	CRCW04022K00FK; RK73H1ETTP2001F	VISHAY DALE; KOA SPEER	2K	RESISTOR; 0402; 2K; 1%; 100PPM; 0.0625W; THICK FILM
56	R43	-	1	CRCW040210K0FK; RC0402FR-0710KL	VISHAY DALE; YAGEO PHICOMP	10K	RESISTOR; 0402; 10K; 1%; 100PPM; 0.0625W; THICK FILM
57	R45	-	1	CRCW0402221RFK	VISHAY DALE	221	RESISTOR; 0402; 221 OHM; 1%; 100PPM; 0.0625W; THICK FILM
58	R48	-	1	CRCW0402499RFK	VISHAY DALE	499	RESISTOR; 0402; 499 OHM; 1%; 100PPM; 0.0625W; THICK FILM
59	S1, S2	-	2	G12JPCF	NKK SWITCHES	G12JPCF	SWITCH; SPDT; SMT; STRAIGHT; 28V; FULLY ILLUMINATED ULTRA-MINIATURE TOGGLE; RCOIL=0 OHM; RINSULATION=500M OHM; NKK SWITCHES
60	ST1, ST2	-	2	7808	KEYSTONE	7808	TERMINAL; BODY LENGTH=0.67IN; BODY WIDTH=0.47IN; HEIGHT=0.45IN; SCRW; BRASS
61	SW1	-	1	TL3301AF160QJ	E-SWITCH	TL3301AF160QJ	SWITCH; SPST; SMT; STRAIGHT; 250V; 0.05A; TACT SWITCH; RCOIL=0 OHM; RINSULATION=500M OHM;E-SWITCH
62	TP3, TP21, TP32	-	3	5012	KEYSTONE	N/A	TEST POINT; PIN DIA=0.1IN; TOTAL LENGTH=0.445IN; BOARD HOLE=0.063IN;WHITE; PHOSPHOR BRONZE WIRE SILVER PLATE FINISH;
63	TP4, TP8	-	2	5010	N/A	5010	TESTPOINT WITH 1.80MM HOLE DIA, RED, MULTIPURPOSE
64	TP5, TP9, TP15, TP34-TP36, TP38, TP41	-	8	5000	KEYSTONE	N/A	TEST POINT; PIN DIA=0.1IN; TOTAL LENGTH=0.3IN; BOARD HOLE=0.04IN;RED; PHOSPHOR BRONZE WIRE SILVER PLATE FINISH;
65	TP6, TP10, TP37, TP39, TP40	-	5	5001	KEYSTONE	N/A	TEST POINT; PIN DIA=0.1IN; TOTAL LENGTH=0.3IN; BOARD HOLE=0.04IN;BLACK; PHOSPHOR BRONZE WIRE SILVER PLATE FINISH;
66	TP7, TP11-TP14	-	5	5011	KEYSTONE	N/A	TEST POINT; PIN DIA=0.125IN; TOTAL LENGTH=0.445IN; BOARD HOLE=0.063IN; BLACK; PHOSPHOR BRONZE WIRE SILVER PLATE FINISH;
67	TP31	-	1	5126	KEYSTONE	N/A	TEST POINT; PIN DIA=0.125IN; TOTAL LENGTH=0.445IN; BOARD HOLE=0.063IN; GREEN; PHOSPHOR BRONZE WIRE SILVER PLATE FINISH;
68	U1	-	1	MAX20796	MAXIM	MAX20796	EVKIT PART -IC; INTEGRATED; TWO-PHASE; SINGLE SUPPLY; STEP-DOWN SWITCHING REGULATOR; WITH OPTIONAL THERMALLY ENHANCED PACKAGE; FC2QFN35
69	U2	-	1	MAX17501EATB+	MAXIM	MAX17501EATB+	IC; CONV; ULTRA-SMALL; HIGH-EFFICIENCY; SYNCHRONOUS STEP-DOWN DC-DC CONVERTER; TDFN10-EP
70	U3	-	1	NC7WZ38K8X	FAIRCHILD SEMICONDUCTOR	NC7WZ38K8X	IC; NAND; TINY LOGIC UHS DUAL 2-INPUT NAND GATE; OPEN DRAIN OUTPUT; VSSOP8
71	U4	-	1	NC7SZ14M5X	FAIRCHILD SEMICONDUCTOR	NC7SZ14M5X	IC; INV; TINYLOGIC UHS INVERTER WITH SCHMITT TRIGGER INPUT; SOT23-5
72	U5	-	1	NC7WZ02K8X	FAIRCHILD SEMICONDUCTOR	NC7WZ02K8X	IC; NOR; TINYLOGIC UHS DUAL 2-INPUT NOR GATE;US8-8
73	PCB	-	1	MAX20796DL	MAXIM	PCB	PCB:MAX20796DL
74	C10	DNP	0	C1608X5R1E475K080AC; GRM188R61E475KE11	TDK;MURATA	4.7UF	CAPACITOR; SMT (0603); CERAMIC CHIP; 4.7UF; 25V; TOL=10%; TG=-55 DEGC TO +85 DEGC; TC=X5R
75	C27, C34, C43	DNP	0	6TPF330M9L	PANASONIC	330UF	CAPACITOR; SMT (7343); TANTALUM CHIP; 330UF; 6.3V; TOL=20%; MODEL=TPF SERIES; TG=-55 DEGC TO +105 DEGC
76	C31	DNP	0	C0402X5R6R3-105KNP; C1005X5R0J105K050BB; GRM155R60J105KE19; JMK105BJ105KV-F; JMK105BJ105KVHF	VENKEL LTD; TDK;MURATA; TAIYO YUDEN; TAIYO YUDEN	1UF	CAPACITOR; SMT (0402); CERAMIC CHIP; 1UF; 6.3V; TOL=10%; TG=-55 DEGC TO +85 DEGC; TC=X5R;
77	C32	DNP	0	GRM155R71C224KA12	MURATA	0.22UF	CAPACITOR; SMT (0402); CERAMIC; 0.22UF; 16V; TOL=10%; MODEL=GRM SERIES; TG=-55 DEGC TO +125 DEGC; TC=X7R
78	C52, C53, C58, C60, C62, C64, C65, C70, C71, C73, C77, C78, C80	DNP	0	EMK325ABJ107MM	TAIYO YUDEN	100UF	CAPACITOR; SMT (1210); CERAMIC CHIP; 100UF; 16V; TOL=20%; TG=-55 DEGC TO +85 DEGC; TC=X5R
79	L1	DNP	0	744309047	WURTH ELECTRONICS INC	470NH	INDUCTOR; SMT; MAGNETICALLY SHIELDED; 470NH; TOL=+-20%; 47.5A
80	R2, R8, R9, R11, R12, R27, R29	DNP	0	CRCW04020000Z0EDHP; RCS04020000Z0	VISHAY DRALORIC; VISHAY DALE	0	RESISTOR; 0402; 0 OHM; 0%; JUMPER; 0.2W; THICK FILM
81	R49	DNP	0	CRCW04024R70FK	VISHAY DALE	4.7	RESISTOR; 0402, 4.7 OHM, 1%, 100PPM, 0.0625W, THICK FILM
82	R50	DNP	0	CRCW040210R0FK; 9C04021A10R0FL	VISHAY DALE; YAGEO	10	RESISTOR; 0402; 10 OHM; 1%; 100PPM; 0.0625W; THICK FILM
83	U6	DNP	0	MAX20766	MAXIM	MAX20766	EVKIT PART-IC; HPQFN16; MAX20766; PACKAGE OUTLINE: 21-0986
TOTAL			187				

MAX20796 Discrete Inductor
Evaluation Kit

Evaluates: MAX20796 and MAX20766

MAX20796 Discrete Inductor EV Kit Bill of Materials—3 Phase

ITEM	REF DES	DNI/DNP	QTY	MFG PART #	MANUFACTURER	VALUE	DESCRIPTION
1	ALERT_N, SCL, SDA, TP22-TP30, TP33	-	13	5002	KEystone	N/A	TEST POINT; PIN DIA=0.1IN; TOTAL LENGTH=0.3IN; BOARD HOLE=0.04IN; WHITE; PHOSPHOR BRONZE WIRE SILVER;
2	C1, C11, C93, C94	-	4	GMK105BJ104KV	TAIYO YUDEN	0.1UF	CAPACITOR; SMT (0402); CERAMIC; 0.1UF; 35V; TOL=10%; TG=-55 DEGC TO +85 DEGC; TC=X5R
3	C2, C12	-	2	C0603C104K5RAC; C1608X7R1H104K; ECJ-1VB1H104K; GRM188R71H104KA93; CGJ3E2X7R1H104K080AA; C1608X7R1H104K080AA; CL10B104KB8NNN; CL10B104KB8NFN	KEMET;TDK; PANASONIC; MURATA;TDK;TDK; SAMSUNG ELECTRO-MECHANICS; SAMSUNG ELECTRONICS	0.1UF	CAPACITOR; SMT (0603); CERAMIC CHIP; 0.1UF; 50V; TOL=10%; TG=-55 DEGC TO +125 DEGC; TC=X7R;
4	C3, C4, C13, C14, C95, C96	-	6	C3216X5R1E226M160AB	TDK	22UF	CAPACITOR; SMT (1206); CERAMIC CHIP; 22UF; 25V; TOL=20%; MODEL=C SERIES; TG=-55 DEGC TO +85 DEGC; TC=X5R
5	C5, C6, C15, C16, C84, C97, C98	-	7	C3216X5R1E476M160AC	TDK	47UF	CAPACITOR; SMT (1206); CERAMIC CHIP; 47UF; 25V; TOL=20%; MODEL=C SERIES; TG=-55 DEGC TO +85 DEGC; TC=X5R ;
6	C7	-	1	GRM155R71E472KA01	MURATA	4700PF	CAPACITOR; SMT (0402); CERAMIC CHIP; 4700PF; 25V; TOL=10%; TG=-55 DEGC TO +125 DEGC; TC=X7R
7	C8, C17, C25, C89-C92, C100	-	8	CGA2B3X7R1H104K050BB; C1005X7R1H104K050BB; GRM155R71H104KE14; GCM155R71H104KE02; C1005X7R1H104K050BE; UMK105B7104KV-FR; CGA2B3X7R1H104K050BE	TDK;TDK;MURATA; MURATA TDK; TAIYO YUDEN;TDK	0.1UF	CAPACITOR; SMT (0402); CERAMIC CHIP; 0.1UF; 50V; TOL=10%; TG=-55 DEGC TO +125 DEGC; TC=X7R
8	C9, C22, C23	-	3	C1608X5R1E475K080AC; GRM188R61E475KE11	TDK;MURATA	4.7UF	CAPACITOR; SMT (0603); CERAMIC CHIP; 4.7UF; 25V; TOL=10%; TG=-55 DEGC TO +85 DEGC; TC=X5R
9	C18, C24, C29, C30	-	4	GRM155R60J475ME87; GRM153R60J475ME15	MURATA;MURATA	4.7UF	CAPACITOR; SMT (0402); CERAMIC CHIP; 4.7UF; 6.3V; TOL=20%; TG=-55 DEGC TO +85 DEGC; TC=X5R
10	C19	-	1	C0402C103K5RAC; GRM155R71H103KA88; C1005X7R1H103K050BE; CL05B103KB5NNN	KEMET;MURATA;TDK; SAMSUNG ELECTRONIC	0.01UF	CAPACITOR; SMT (0402); CERAMIC CHIP; 0.01UF; 50V; TOL=10%; TG=-55 DEGC TO +125 DEGC; TC=X7R
11	C20, C21, C99	-	3	C0402C105K8PAC; CC0402KRX5R6BB105	KEMET;YAGEO	1UF	CAPACITOR; SMT (0402); CERAMIC CHIP; 1UF; 10V; TOL=10%; TG=-55 DEGC TO +85 DEGC; TC=X5R
12	C26, C28, C101	-	3	GRM155R71C224KA12	MURATA	0.22UF	CAPACITOR; SMT (0402); CERAMIC; 0.22UF; 16V; TOL=10%; MODEL=GRM SERIES; TG=-55 DEGC TO +125 DEGC; TC=X7R
13	C33, C45	-	2	C0402C101J5GAC; NMC0402NPO101J; CC0402JRNPO9BN101; GRM1555C1H101JA01; C1005C0G1H101J050BA; CGA2B2C0G1H101J050BA	KEMET; NIC COMPONENTS CORP.; YAGEO PHICOMP; MURATA;TDK;TDK	100PF	CAPACITOR; SMT (0402); CERAMIC CHIP; 100PF; 50V; TOL=5%; TG=-55 DEGC TO +125 DEGC; TC=C0G
14	C36, C37	-	2	16SEP330M	PANASONIC	330UF	CAPACITOR; THROUGH HOLE-RADIAL LEAD; ELECTROLYTIC-OSCON; 330UF; 16V; TOL=20%
15	C38-C41	-	4	20TQC100MYF	PANASONIC	100UF	CAPACITOR; SMT (7343); TANTALUM CHIP; 100UF; 20V; TOL=20%; TG=-55 DEGC TO +105 DEGC LOW ESR
16	C42	-	1	6TPF330M9L	PANASONIC	330UF	CAPACITOR; SMT (7343); TANTALUM CHIP; 330UF; 6.3V; TOL=20%; MODEL=TPF SERIES; TG=-55 DEGC TO +105 DEGC
17	C48, C51	-	2	GRM155R61A103KA01	MURATA	0.01UF	CAPACITOR; SMT (0402); CERAMIC CHIP; 0.01UF; 10V; TOL=10%; MODEL=GRM SERIES; TG=-55 DEGC TO +85 DEGC; TC=X5R
18	C55, C66, C72, C79, C81	-	5	EMK325ABJ107MM	TAIYO YUDEN	100UF	CAPACITOR; SMT (1210); CERAMIC CHIP; 100UF; 16V; TOL=20%; TG=-55 DEGC TO +85 DEGC; TC=X5R
19	C82, C83	-	2	ANY	ANY	10UF	CAPACITOR; SMT (0603); CERAMIC CHIP; 10UF; 16V; TOL=20%; MODEL=GRM SERIES; TG=-55 DEGC TO +85 DEGC; TC=X5R; FORMFACTOR
20	C85, C87	-	2	C0603C105K4RAC; GRM188R71C105KA12; C1608X7R1C105K080AC; EMK107B7105KA; GCM188R71C105KA64; CGA3E1X7R1C105K080AC	KEMET;MURATA; TDK;TAIYO YUDEN; MURATA;TDK	1UF	CAPACITOR; SMT (0603); CERAMIC CHIP; 1UF; 16V; TOL=10%; MODEL=; TG=-55 DEGC TO +125 DEGC; TC=X7R

MAX20796 Discrete Inductor
Evaluation Kit

Evaluates: MAX20796 and MAX20766

MAX20796 Discrete Inductor EV Kit Bill of Materials—3 Phase (continued)

ITEM	REF DES	DNI/DNP	QTY	MFG PART #	MANUFACTURER	VALUE	DESCRIPTION
21	C88	-	1	GRM155R71H332KA01	MURATA	3300PF	CAPACITOR; SMT (0402); CERAMIC CHIP; 3300PF; 50V; TOL=10%; TG=-55 DEGC TO +125 DEGC; TC=X7R
22	C102	-	1	GRM155R61A102KA01	MURATA	1000PF	CAPACITOR; SMT (0402); CERAMIC; 1000PF; 10V; TOL=10%; TG=-55 DEGC TO +85 DEGC; TC=X5R
23	D1, D2	-	2	MBR5540T3G	ON SEMICONDUCTOR	MBR5540T3	DIODE; SCH; SURFACE MOUNT SCHOTTKY POWER RECTIFIER; SMC; PIV=40V; IF=5A
24	H1-H4	-	4	2212	KEYSTONE	2212; MCH_SO_F_ HEX_6-32X1	STANDOFF; FEMALE-THREADED; HEX; 6-32; 1IN; ALUMINUM
25	H5-H8	-	4	PHILLIPS-FILLISTER_ D4.3MM/6-32X1/4IN	MAXIM	146721	MACHINE SCREW; PHILLIPS; FILLISTER; D4.3MM/6-32; 1/4IN; 18-8 STAINLESS STEEL
26	J1, J2, J13, JP1, JP2	-	5	PREC002SAAN-RC	SULLINS	PREC002SAAN-RC	CONNECTOR; MALE; THROUGH HOLE; HEADER; STRAIGHT; 2PINS
27	J3, J4, J7, J9	-	4	131-3701-266	JOHNSON COMPONENTS	131-3701-266	CONNECTOR; MALE; THROUGH HOLE; SMB JACK VERTICAL PCB MOUNT; STRAIGHT; 5PINS
28	J5, J8	-	2	6095	KEYSTONE	6095	CONNECTOR; FEMALE; PANELMOUNT; NON-INSULATED RECESSED HEAD BANANA JACK; STRAIGHT THROUGH; 1PIN
29	J6	-	1	PJ-102AH	CUI INC.	PJ-102AH	CONNECTOR; FEMALE; THROUGH HOLE; DC POWER JACK; RIGHT ANGLE; 3PINS
30	J10	-	1	TSW-108-07-T-D	SAMTEC	TSW-108-07-T-D	CONNECTOR; MALE; THROUGH HOLE; TSW SERIES; 0.0125INCH SQUARE POST HEADER; STRAIGHT; 16PINS
31	J11	-	1	UPS-08-01-01-L-RA	SAMTEC	UPS-08-01-01-L-RA	CONNECTOR; FEMALE; THROUGH HOLE; DUAL LEAF POWER HEADER; RIGHT ANGLE; 8PINS
32	L1-L3	-	3	744309047	WURTH ELECTRONICS INC	470NH	INDUCTOR; SMT; MAGNETICALLY SHIELDED; 470NH; TOL=+/-20%; 47.5A
33	L4	-	1	LPS6235-333MR	COILCRAFT	33UH	INDUCTOR; SMT; MAGNETICALLY SHIELDED; 33UH; TOL=+/-20%; 1.3A
34	Q1	-	1	SQA410EJ-T1_GE3	VISHAY SILICONIX	SQA410EJ-T1_GE3	TRAN; AUTOMOTIVE N-CHANNEL MOSFET; NCH; SC70-6; PD-(13.6W); I-(7.8A); V-(20V)
35	Q2	-	1	2N7002	NXP	2N7002	TRAN; N-CHANNEL TRENCH MOSFET; NCH; SOT-23; PD-(0.83W); I-(0.3A); V-(60V)
36	R1	-	1	CRCW04023R00FK	VISHAY DALE	3	RESISTOR; 0402; 3 OHM; 1%; 100PPM; 0.063W; THICK FILM
37	R3-R5, R7, R10, R54-R59	-	11	CRCW04020000Z0EDHP; RC504020000Z0	VISHAY DRALORIC; VISHAY DALE	0	RESISTOR; 0402; 0 OHM; 0%; JUMPER; 0.2W; THICK FILM
38	R13	-	1	CRCW040233R0FK	VISHAY DALE	33	RESISTOR; 0402; 33 OHM; 1%; 100PPM; 0.0625W; THICK FILM
39	R14, R26	-	2	CRCW040249R9FKEDHP	VISHAY DRALORIC	49.9	RESISTOR; 0402; 49.9 OHM; 1%; 100PPM; 0.2W; THICK FILM
40	R15	-	1	ERJ-2RKF1400	PANASONIC	140	RESISTOR; 0402; 140 OHM; 1%; 100PPM; 0.1W; THICK FILM
41	R16	-	1	CRCW04023012FK; CRCW040230K1FK	VISHAY DALE; VISHAY DALE	30.1K	RESISTOR; 0402; 30.1K; 1%; 100PPM; 0.0625W; THICK FILM
42	R17	-	1	CRCW040237R4FK; ERJ-2RKF37R4	VISHAY DALE; PANASONIC	37.4	RESISTOR; 0402; 37.4 OHM; 1%; 100PPM; 0.0625W; THICK FILM
43	R18	-	1	ERJ-2RKF1690	PANASONIC	169	RESISTOR; 0402; 169 OHM; 1%; 100PPM; 0.1W; THICK FILM
44	R19	-	1	CRCW0402976RFK	VISHAY	976	RES; SMT (0402); 976; 1%; +/-100PPM/DEGC; 0.063W
45	R20	-	1	CRCW040245R3FKEDHP	VISHAY	45.3	RES; SMT (0402); 45.3; 1%; +/-100PPM/DEGC; 0.2W
46	R21	-	1	CRCW04021K40FK; RC0402FR-071K4L	VISHAY DALE; YAGEO PHICOMP	1.4K	RESISTOR; 0402; 1.4K OHM; 1%; 100PPM; 1/6W; THICK FILM
47	R22	-	1	CR0402-16W-52R3FT; CRCW040252R3FK	VENKEL LTD.; VISHAY DALE	52.3	RESISTOR; 0402; 52.3 OHM; 1%; 100PPM; 0.063W; THICK FILM
48	R23	-	1	CRCW04021K00FK; RC0402FR-071KL; MCR01MZPF1001	VISHAY DALE; YAGEO PHICOMP; ROHM SEMI	1K	RESISTOR; 0402; 1K; 1%; 100PPM; 0.0625W; THICK FILM
49	R25, R47	-	2	CRCW040210R0FK; 9C04021A10R0FL	VISHAY DALE; YAGEO	10	RESISTOR; 0402; 10 OHM; 1%; 100PPM; 0.0625W; THICK FILM
50	R28	-	1	ERJ-8GEYJ101V	PANASONIC	100	RESISTOR; 1206; 100 OHM; 5%; 200PPM; 0.25W; THICK FILM
51	R30	-	1	ANY	ANY	100	RESISTOR; 0402; 100 OHM; 1%; 100PPM; 0.0625W; THICK FILM; FORMFACTOR
52	R31, R34, R36-R40, R44	-	8	CRCW0402100KFK; RC0402FR-07100KL	VISHAY;YAGEO	100K	RESISTOR; 0402; 100K; 1%; 100PPM; 0.0625W; THICK FILM
53	R32, R46	-	2	CRCW0402150RFK; 9C04021A1500FL	VISHAY DALE; YAGEO	150	RESISTOR; 0402; 150 OHM; 1%; 100PPM; 0.0625W; THICK FILM
54	R33	-	1	CRCW040237K4FK	VISHAY DALE	37.4K	RESISTOR; 0402; 37.4K OHM; 1%; 100PPM; 0.063W; THICK FILM

MAX20796 Discrete Inductor
Evaluation Kit

Evaluates: MAX20796 and MAX20766

MAX20796 Discrete Inductor EV Kit Bill of Materials—3 Phase (continued)

ITEM	REF DES	DNI/DNP	QTY	MFG PART #	MANUFACTURER	VALUE	DESCRIPTION
55	R41, R42	-	2	CRCW04022K00FK; RK73H1ETTP2001F	VISHAY DALE; KOA SPEER	2K	RESISTOR; 0402; 2K; 1%; 100PPM; 0.0625W; THICK FILM
56	R43	-	1	CRCW040210K0FK; RC0402FR-0710KL	VISHAY DALE; YAGEO PHICOMP	10K	RESISTOR; 0402; 10K; 1%; 100PPM; 0.0625W; THICK FILM
57	R45	-	1	CRCW0402221RFK	VISHAY DALE	221	RESISTOR; 0402; 221 OHM; 1%; 100PPM; 0.0625W; THICK FILM
58	R48	-	1	CRCW0402499RFK	VISHAY DALE	499	RESISTOR; 0402; 499 OHM; 1%; 100PPM; 0.0625W; THICK FILM
59	R49	-	1	CRCW04024R70FK	VISHAY DALE	4.7	RESISTOR, 0402, 4.7 OHM, 1%, 100PPM, 0.0625W, THICK FILM
60	S1, S2	-	2	G12JPCF	NKK SWITCHES	G12JPCF	SWITCH; SPDT; SMT; STRAIGHT; 28V; FULLY ILLUMINATED ULTRA-MINIATURE TOGGLE; RCOIL=0 OHM; RINSULATION=500M OHM; NKK SWITCHES
61	ST1, ST2	-	2	7808	KEystone	7808	TERMINAL; BODY LENGTH=0.67IN; BODY WIDTH=0.47IN; HEIGHT=0.45IN; SCRW; BRASS
62	SW1	-	1	TL3301AF160QJ	E-SWITCH	TL3301AF160QJ	SWITCH; SPST; SMT; STRAIGHT; 250V; 0.05A; TACT SWITCH; RCOIL=0 OHM; RINSULATION=500M OHM; E-SWITCH
63	TP3, TP21, TP32	-	3	5012	KEystone	N/A	TEST POINT; PIN DIA=0.125IN; TOTAL LENGTH=0.445IN; BOARD HOLE=0.063IN; WHITE; PHOSPHOR BRONZE WIRE SILVER PLATE FINISH;
64	TP4, TP8	-	2	5010	N/A	5010	TESTPOINT WITH 1.80MM HOLE DIA, RED, MULTIPURPOSE
65	TP5, TP9, TP15, TP34-TP36, TP38, TP41	-	8	5000	KEystone	N/A	TEST POINT; PIN DIA=0.1IN; TOTAL LENGTH=0.3IN; BOARD HOLE=0.04IN; RED; PHOSPHOR BRONZE WIRE SILVER PLATE FINISH;
66	TP6, TP10, TP37, TP39, TP40	-	5	5001	KEystone	N/A	TEST POINT; PIN DIA=0.1IN; TOTAL LENGTH=0.3IN; BOARD HOLE=0.04IN; BLACK; PHOSPHOR BRONZE WIRE SILVER PLATE FINISH;
67	TP7, TP11-TP14	-	5	5011	KEystone	N/A	TEST POINT; PIN DIA=0.125IN; TOTAL LENGTH=0.445IN; BOARD HOLE=0.063IN; BLACK; PHOSPHOR BRONZE WIRE SILVER PLATE FINISH;
68	TP31	-	1	5126	KEystone	N/A	TEST POINT; PIN DIA=0.125IN; TOTAL LENGTH=0.445IN; BOARD HOLE=0.063IN; GREEN; PHOSPHOR BRONZE WIRE SILVER PLATE FINISH;
69	U1	-	1	MAX20796	MAXIM	MAX20796	EVKIT PART -IC; INTEGRATED; TWO-PHASE; SINGLE SUPPLY; STEP-DOWN SWITCHING REGULATOR; WITH OPTIONAL THERMALLY ENHANCED PACKAGE; FC2QFN35
70	U2	-	1	MAX17501EATB+	MAXIM	MAX17501EATB+	IC; CONV; ULTRA-SMALL; HIGH-EFFICIENCY; SYNCHRONOUS STEP-DOWN DC-DC CONVERTER; TDFN10-EP
71	U3	-	1	NC7WZ38K8X	FAIRCHILD SEMICONDUCTOR	NC7WZ38K8X	IC; NAND; TINY LOGIC UHS DUAL 2-INPUT NAND GATE; OPEN DRAIN OUTPUT; VSSOP8
72	U4	-	1	NC7SZ14M5X	FAIRCHILD SEMICONDUCTOR	NC7SZ14M5X	IC; INV; TINYLOGIC UHS INVERTER WITH SCHMITT TRIGGER INPUT; SOT23-5
73	U5	-	1	NC7WZ02K8X	FAIRCHILD SEMICONDUCTOR	NC7WZ02K8X	IC; NOR; TINYLOGIC UHS DUAL 2-INPUT NOR GATE; US8-8
74	U6	-	1	MAX20766	MAXIM	MAX20766	EVKIT PART-IC; HPQFN16; MAX20766; PACKAGE OUTLINE: 21-0986
75	PCB	-	1	MAX20796DL	MAXIM	PCB	PCB:MAX20796DL
76	C10	DNP	0	C1608X5R1E475K080AC; GRM188R61E475KE11	TDK;MURATA	4.7UF	CAPACITOR; SMT (0603); CERAMIC CHIP; 4.7UF; 25V; TOL=10%; TG=-55 DEGC TO +85 DEGC; TC=X5R
77	C27, C34, C43	DNP	0	6TPF330M9L	PANASONIC	330UF	CAPACITOR; SMT (7343); TANTALUM CHIP; 330UF; 6.3V; TOL=20%; MODEL=TPF SERIES; TG=-55 DEGC TO +105 DEGC
78	C31	DNP	0	C0402X5R6R3-105KNP; C1005X5R0J105K050BB; GRM155R60J105KE19; JMK105BJ105KV-F; JMK105BJ105KVHF	VENKEL LTD; TDK;MURATA; TAIYO YUDEN; TAIYO YUDEN	1UF	CAPACITOR; SMT (0402); CERAMIC CHIP; 1UF; 6.3V; TOL=10%; TG=-55 DEGC TO +85 DEGC; TC=X5R;
79	C32	DNP	0	GRM155R71C224KA12	MURATA	0.22UF	CAPACITOR; SMT (0402); CERAMIC; 0.22UF; 16V; TOL=10%; MODEL=GRM SERIES; TG=-55 DEGC TO +125 DEGC; TC=X7R
80	C52, C53, C58, C60, C62, C64, C65, C70, C71, C73, C77, C78, C80	DNP	0	EMK325ABJ107MM	TAIYO YUDEN	100UF	CAPACITOR; SMT (1210); CERAMIC CHIP; 100UF; 16V; TOL=20%; TG=-55 DEGC TO +85 DEGC; TC=X5R
81	R2, R8, R9, R11, R12, R27, R29, R52, R53	DNP	0	CRCW04020000Z0EDHP; RC504020000Z0	VISHAY DRALORIC; VISHAY DALE	0	RESISTOR; 0402; 0 OHM; 0%; JUMPER; 0.2W; THICK FILM
82	R50	DNP	0	CRCW040210R0FK; 9C04021A10R0FL	VISHAY DALE;YAGEO	10	RESISTOR; 0402; 10 OHM; 1%; 100PPM; 0.0625W; THICK FILM
TOTAL			188				

MAX20796 Discrete Inductor Evaluation Kit

Evaluates: MAX20796 and MAX20766

MAX20796 Discrete Inductor EV Kit Schematic

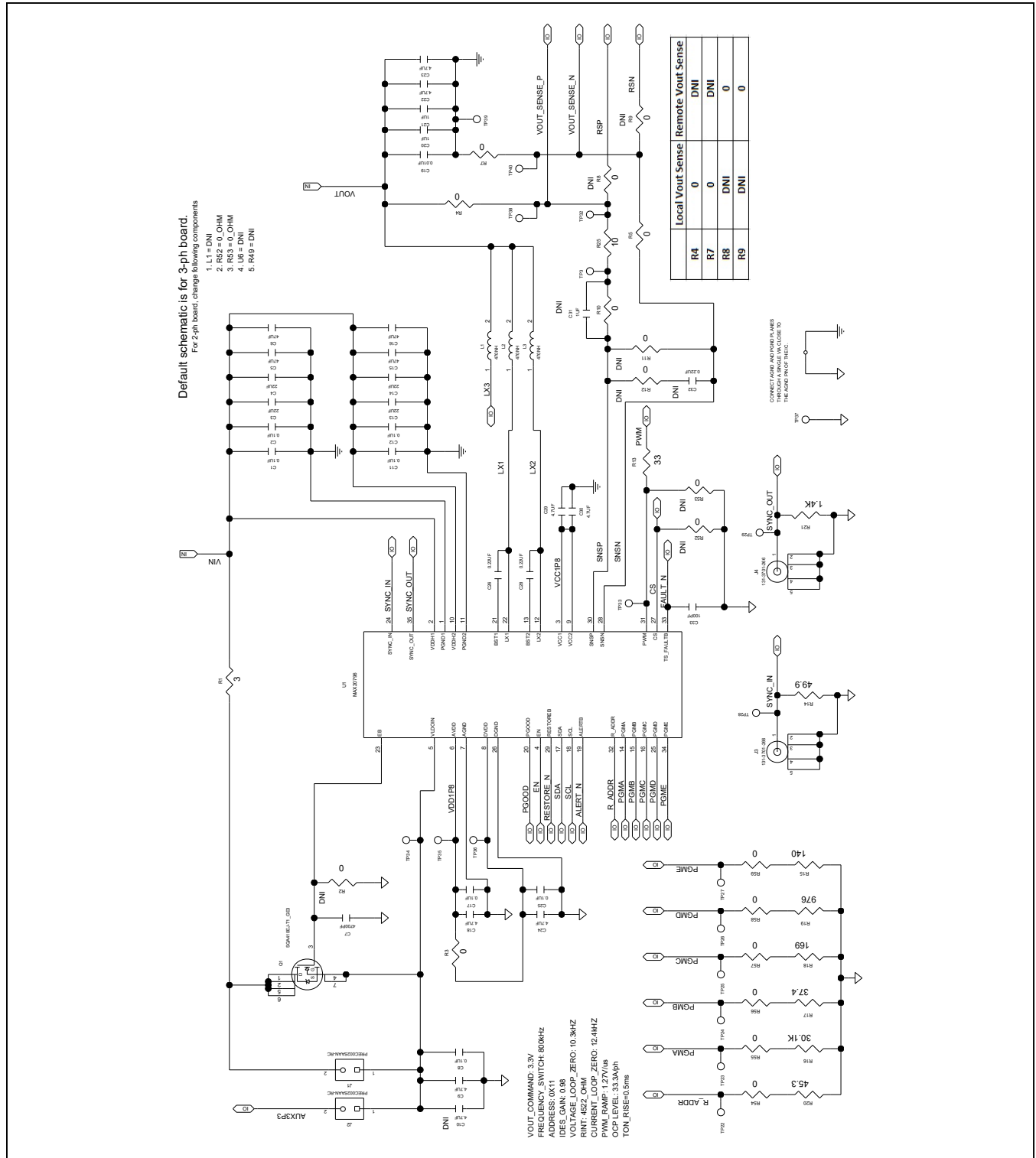

MAX20796 Discrete Inductor EV Kit Schematic (continued)

OPTIONAL EXTERNAL POWER-STAGE

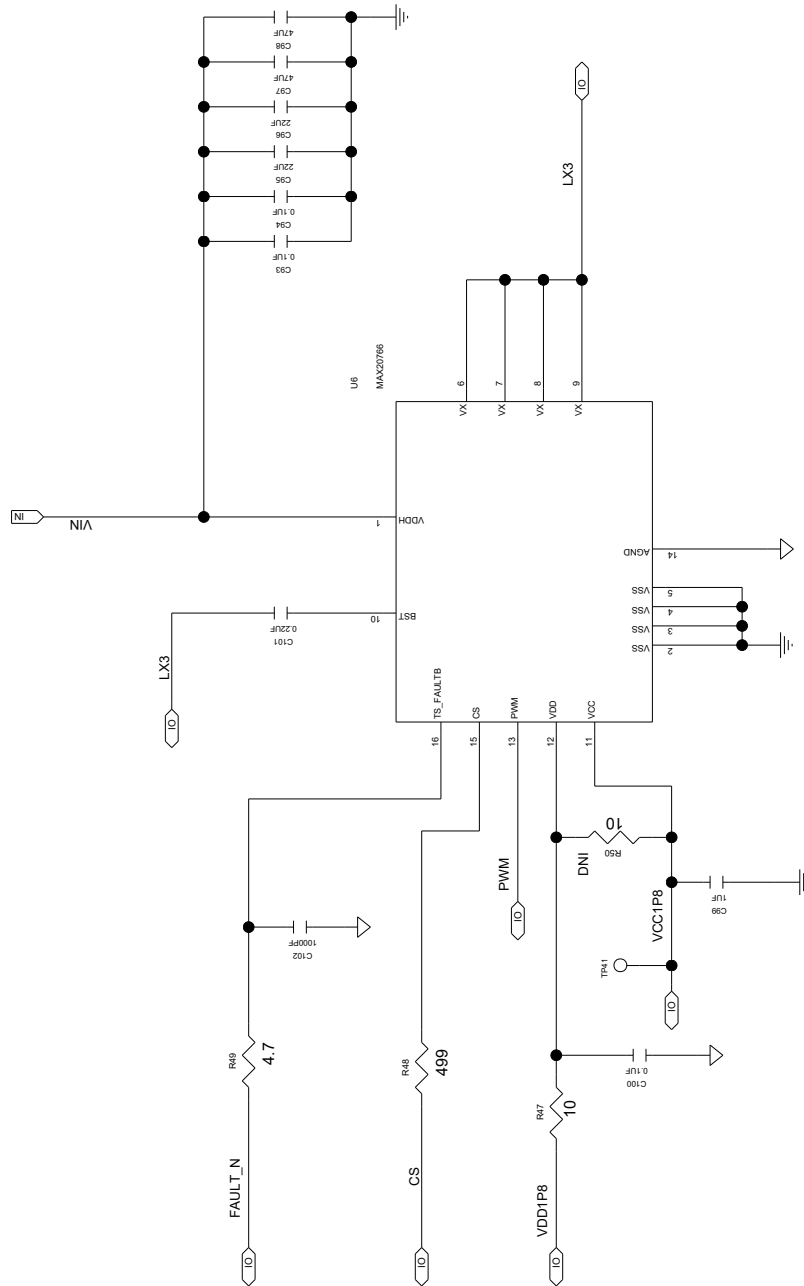

MAX20796 Discrete Inductor EV Kit Schematic (continued)

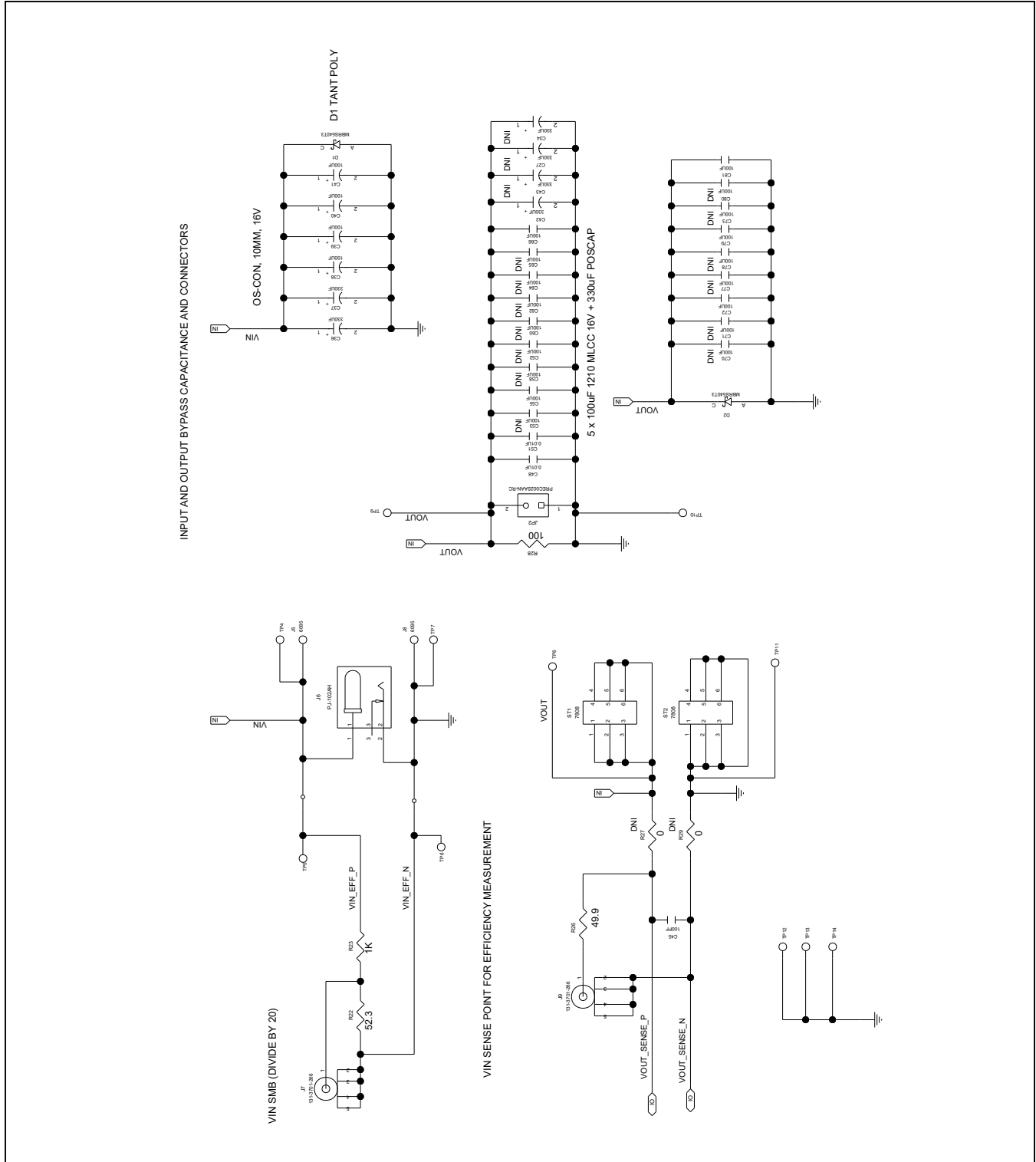

MAX20796 Discrete Inductor EV Kit Schematic (continued)

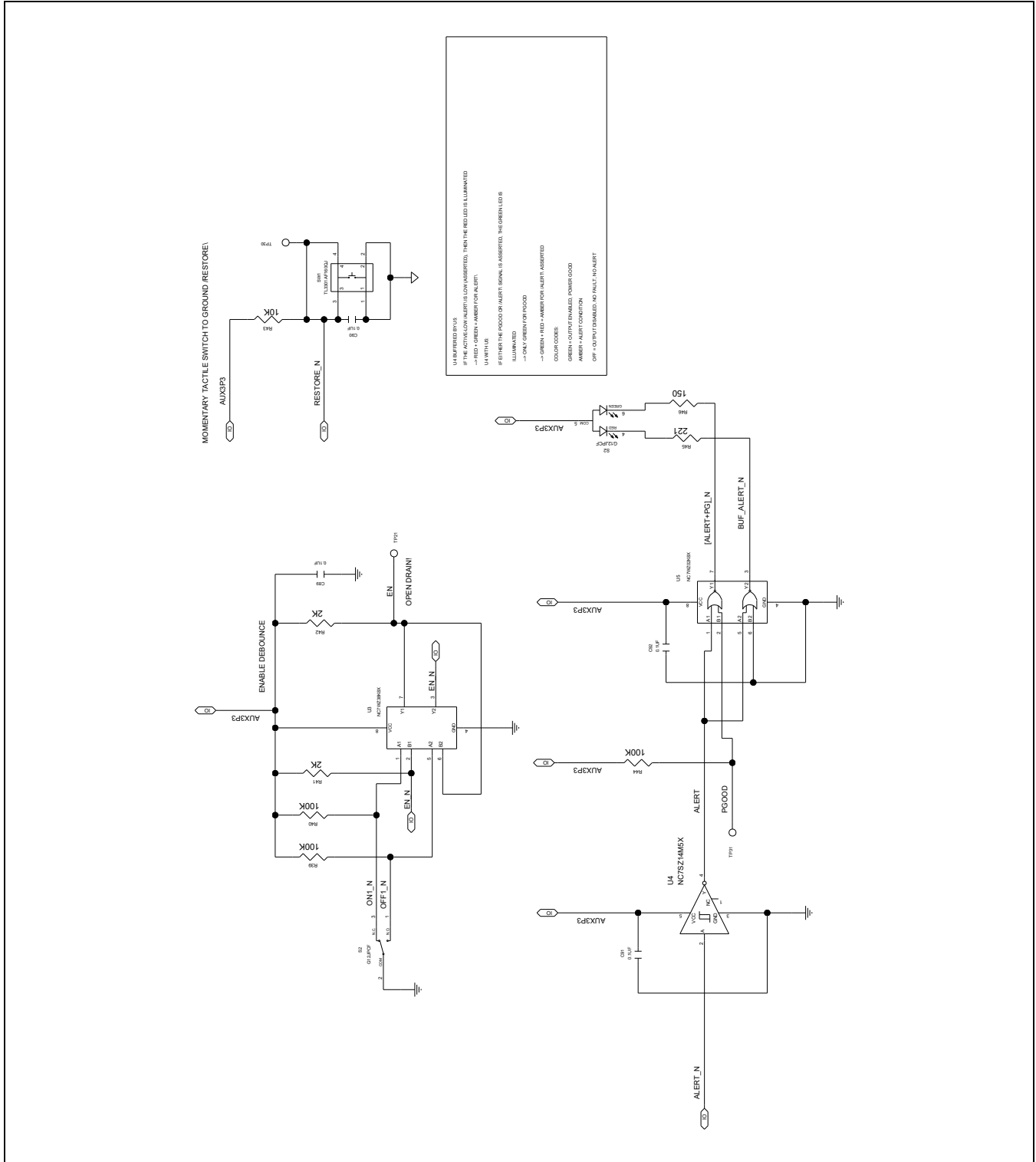

MAX20796 Discrete Inductor EV Kit PCB Layout Diagrams

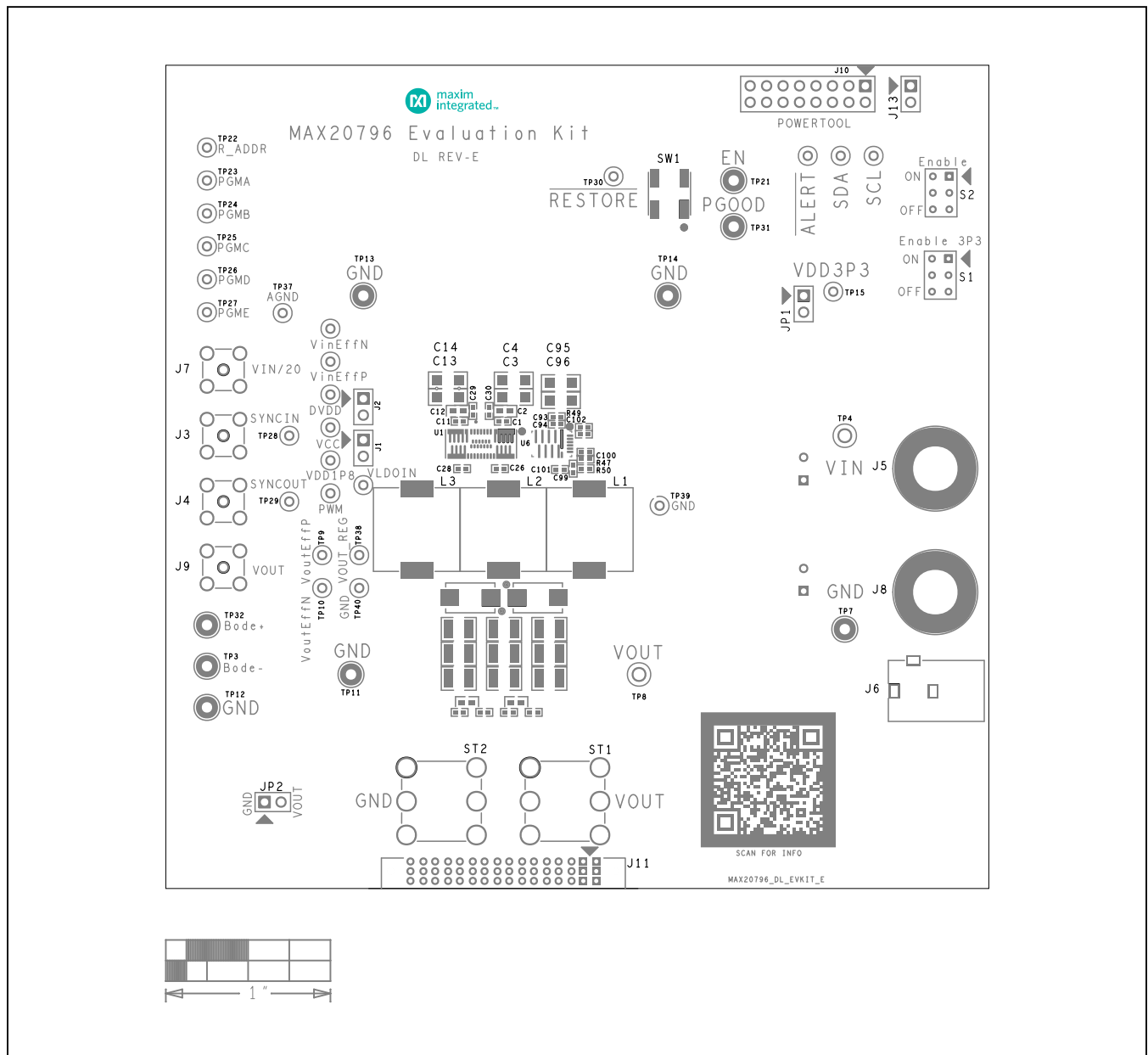

MAX20796 EV Kit PCB Layout—Top Silkscreen

MAX20796 Discrete Inductor EV Kit PCB Layout Diagrams (continued)

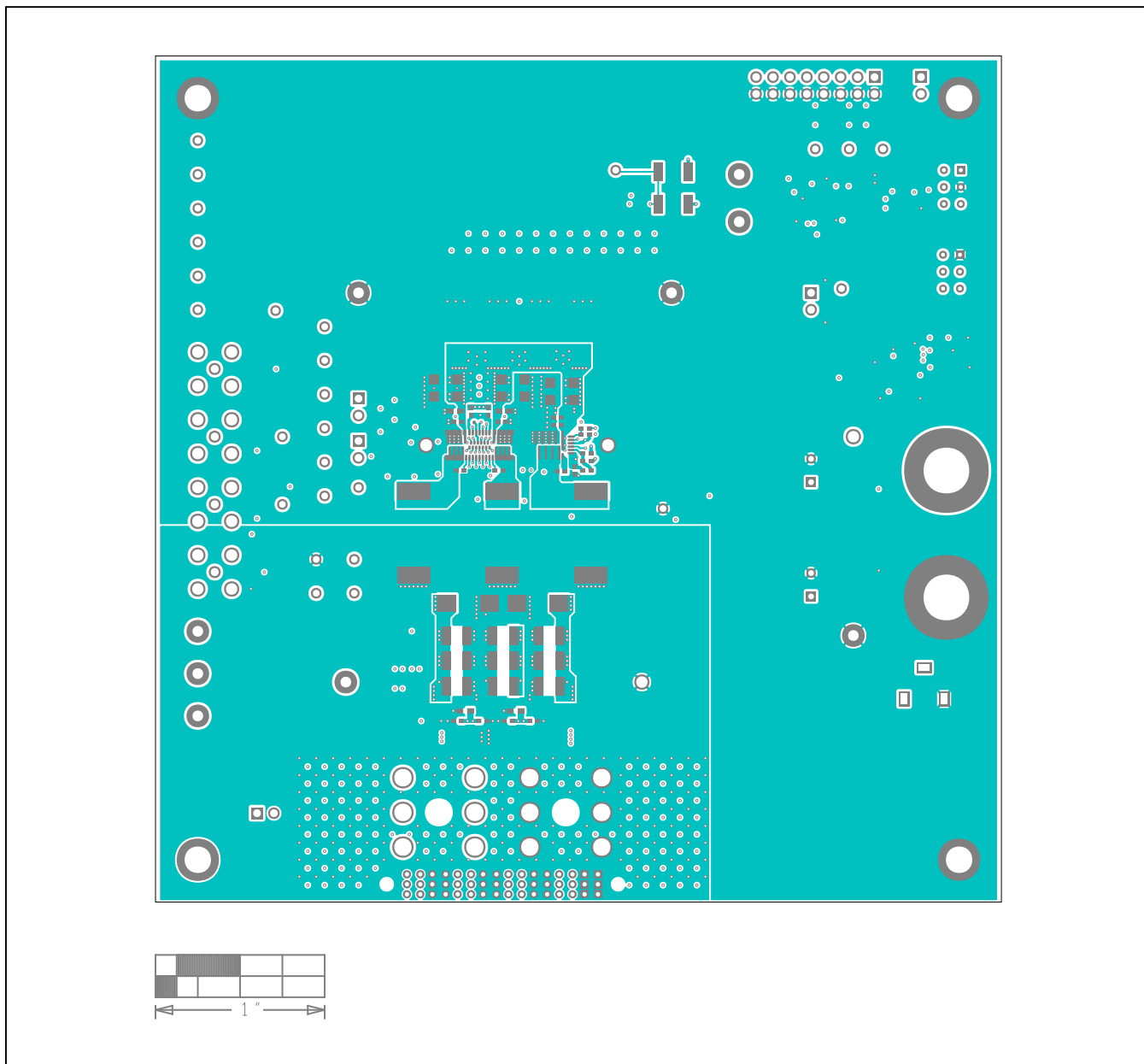

MAX20796 EV Kit PCB Layout—Top

MAX20796 Discrete Inductor EV Kit PCB Layout Diagrams (continued)

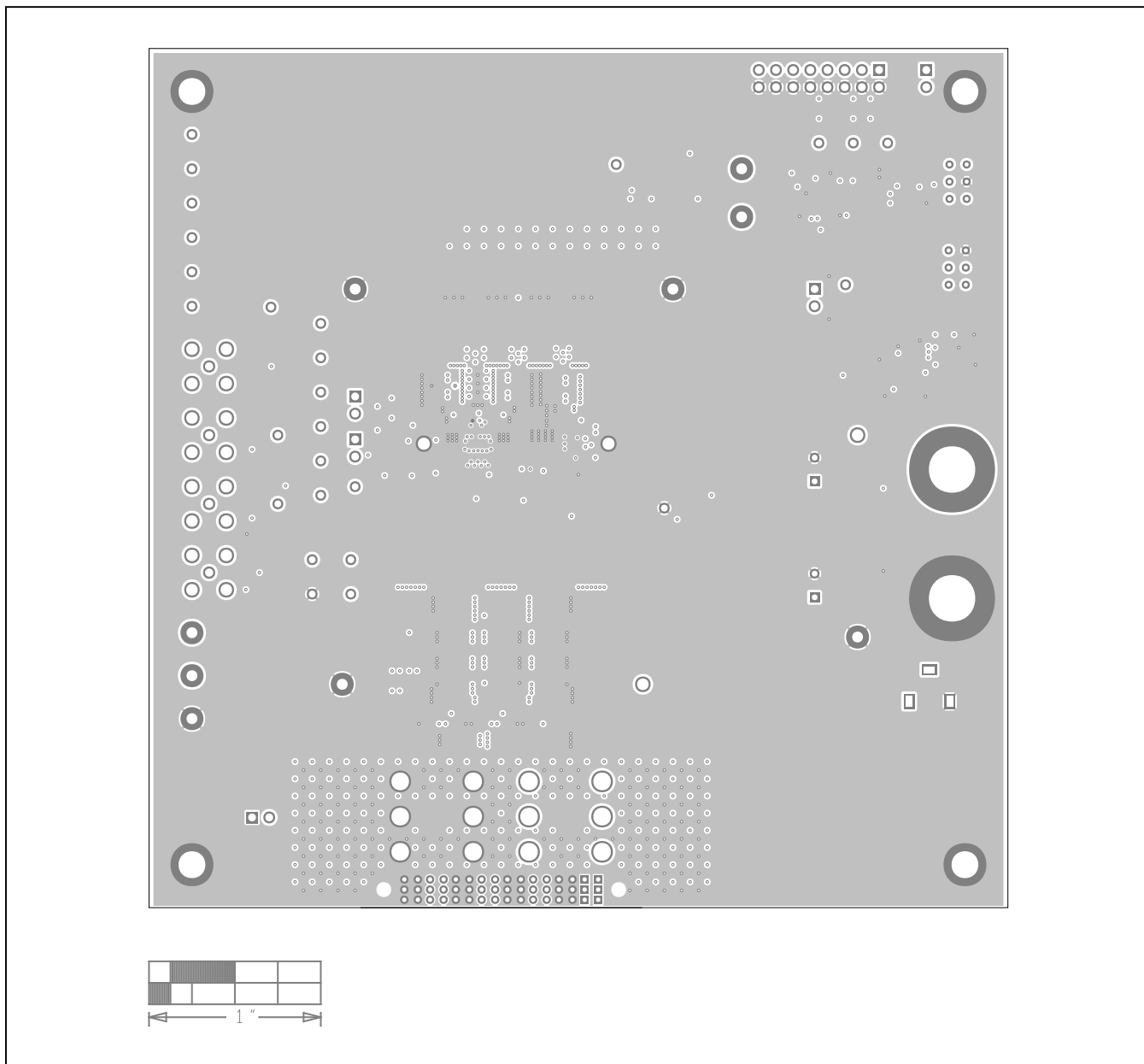

MAX20796 EV Kit PCB Layout—Level 2 GND

MAX20796 Discrete Inductor EV Kit PCB Layout Diagrams (continued)

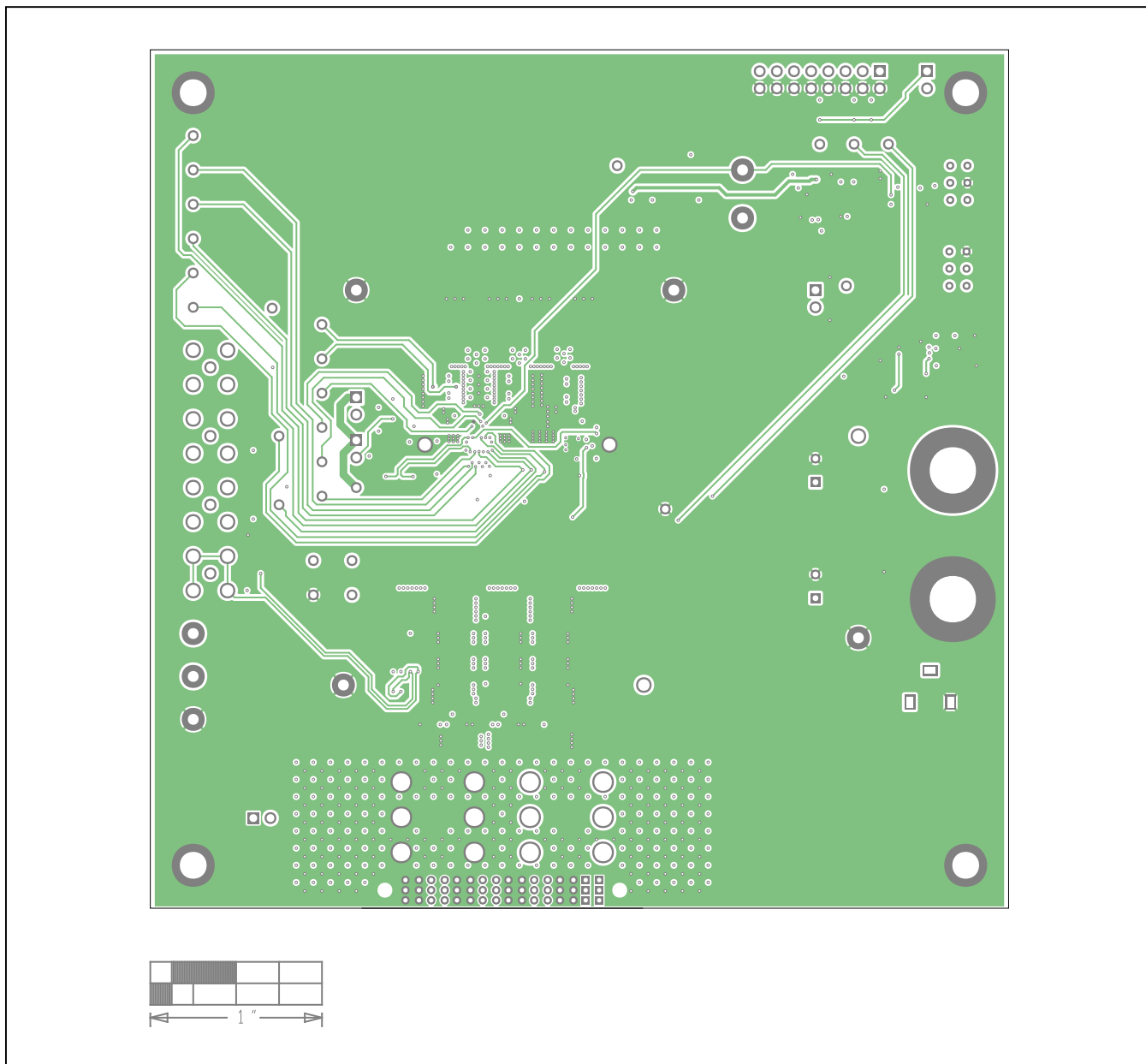

MAX20796 EV Kit PCB Layout—Level 3 SIG

MAX20796 Discrete Inductor EV Kit PCB Layout Diagrams (continued)

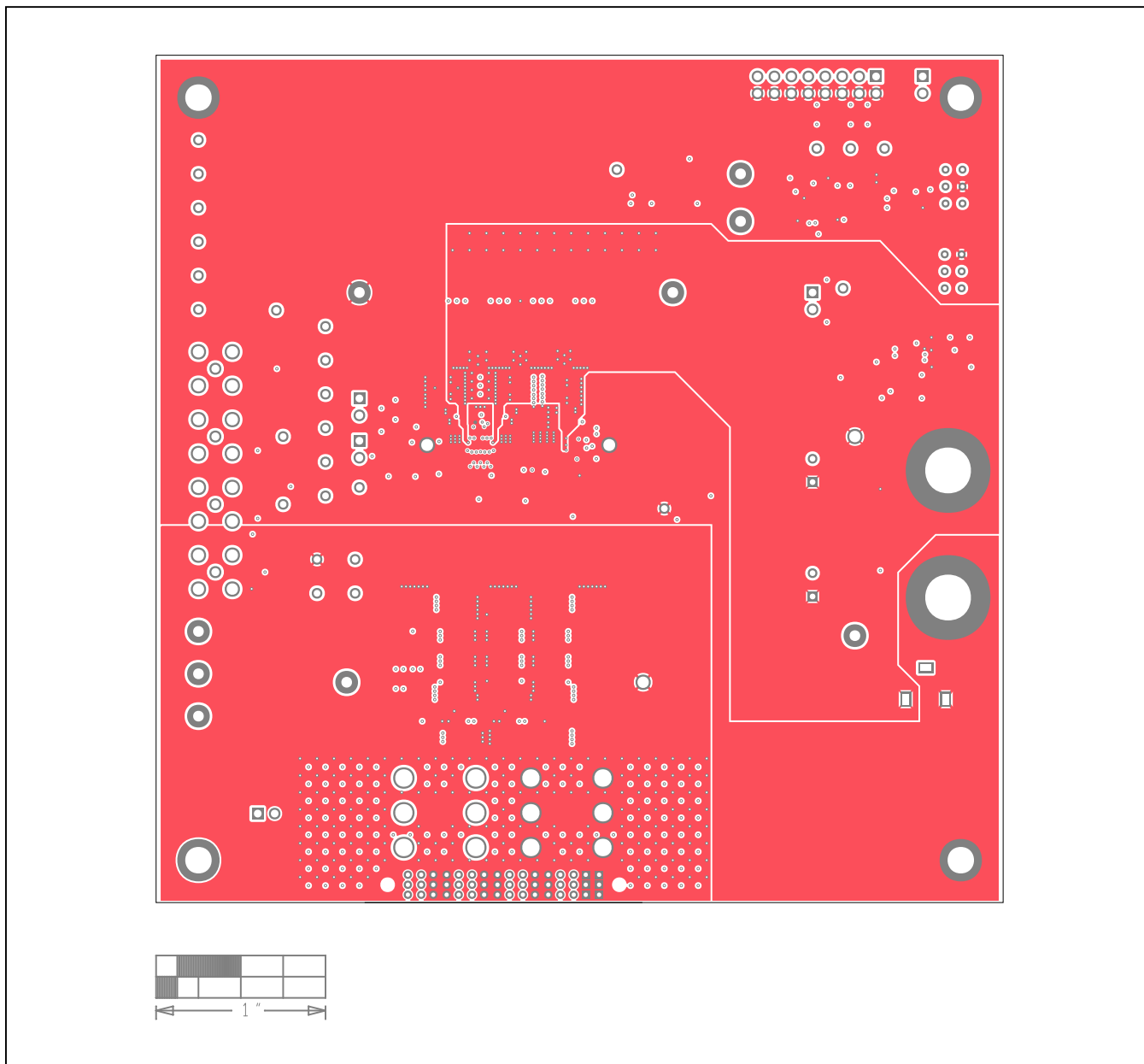

MAX20796 EV Kit PCB Layout—Level 4 PWR

MAX20796 Discrete Inductor EV Kit PCB Layout Diagrams (continued)

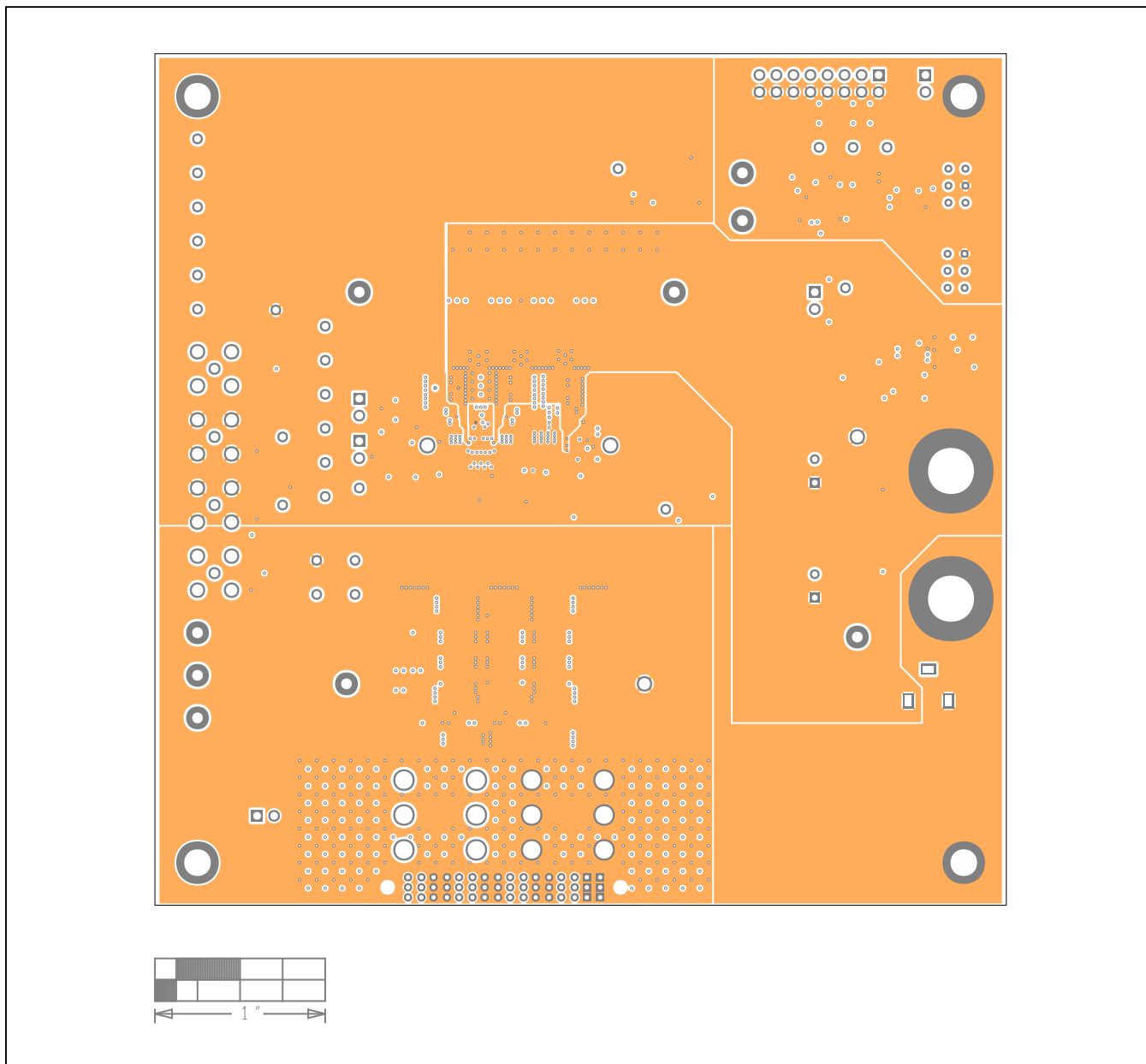

MAX20796 EV Kit PCB Layout—Level 5 PWR

MAX20796 Discrete Inductor EV Kit PCB Layout Diagrams (continued)

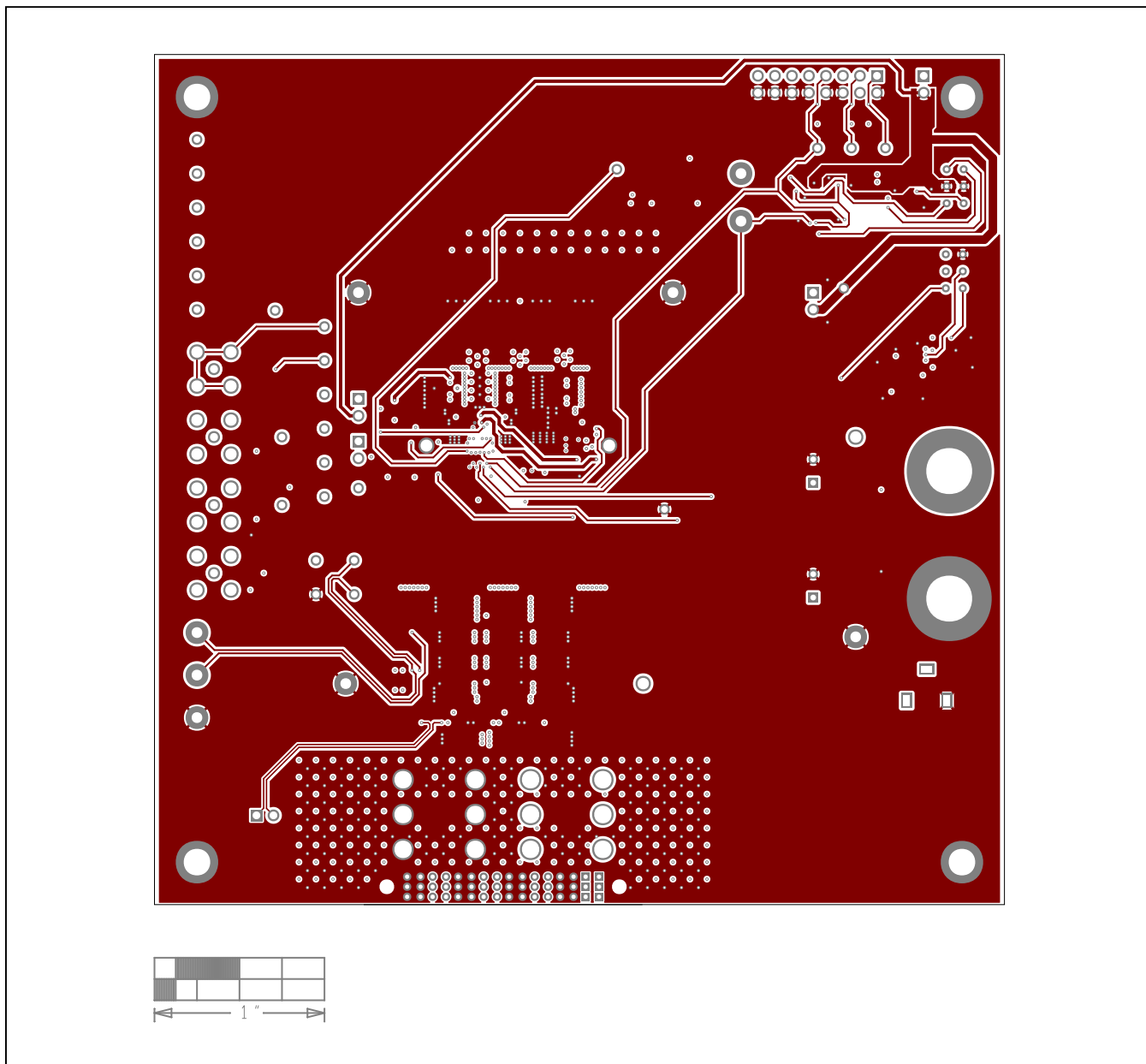

MAX20796 EV Kit PCB Layout—Level 6 SIG

MAX20796 Discrete Inductor EV Kit PCB Layout Diagrams (continued)

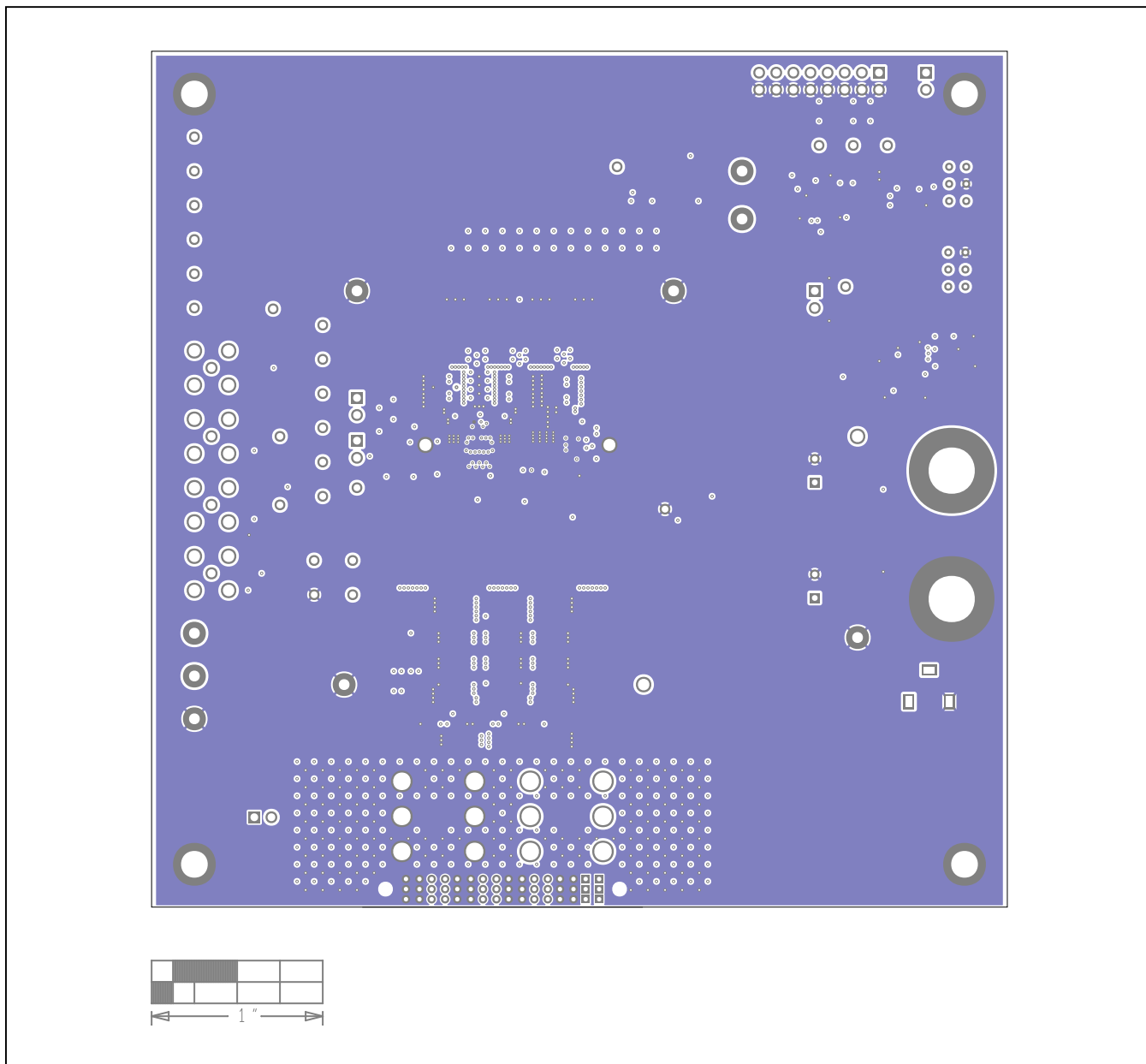

MAX20796 EV Kit PCB Layout—Level 7 GND

MAX20796 Discrete Inductor EV Kit PCB Layout Diagrams (continued)

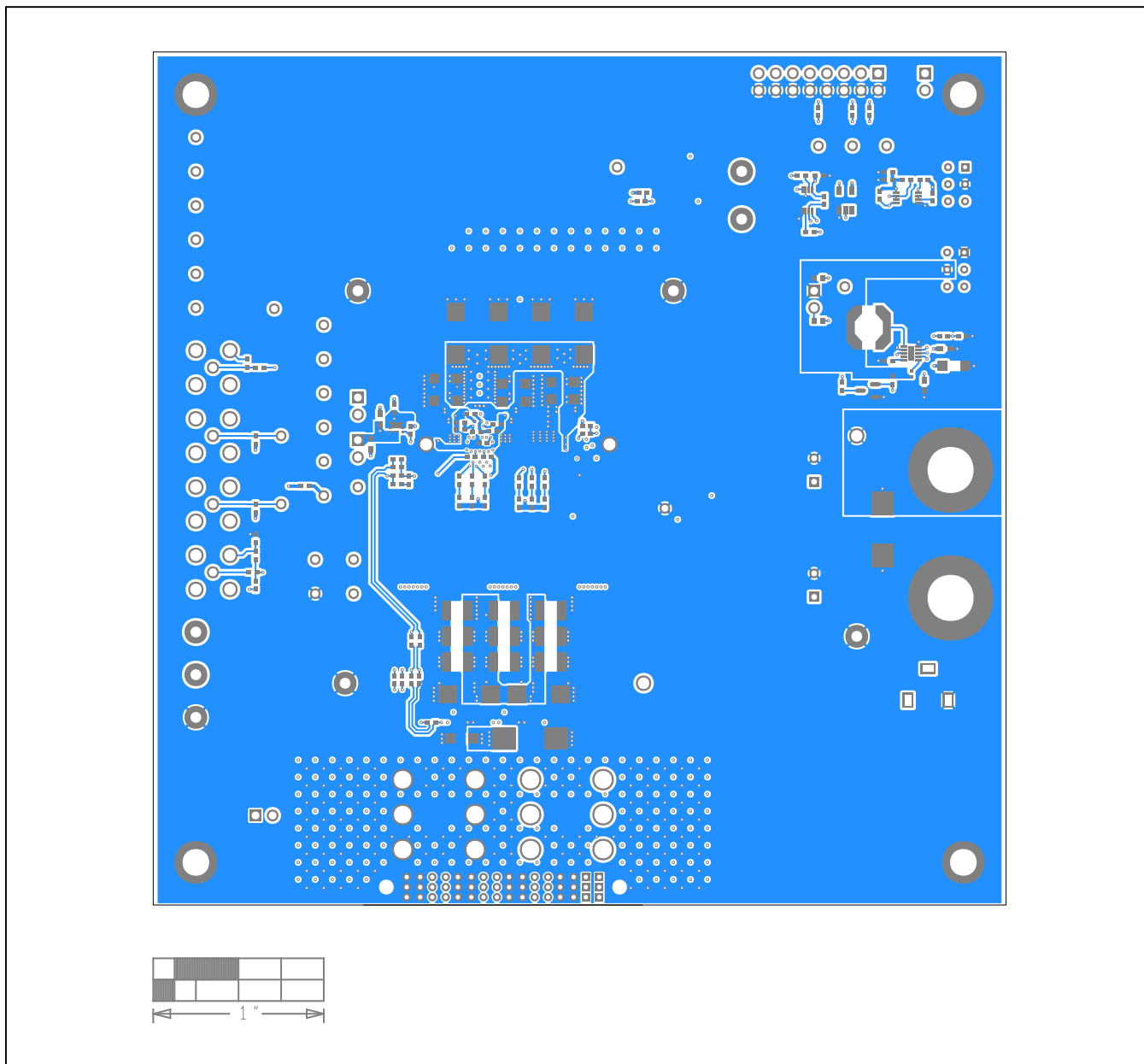

MAX20796 EV Kit PCB Layout—Bottom

MAX20796 Discrete Inductor EV Kit PCB Layout Diagrams (continued)

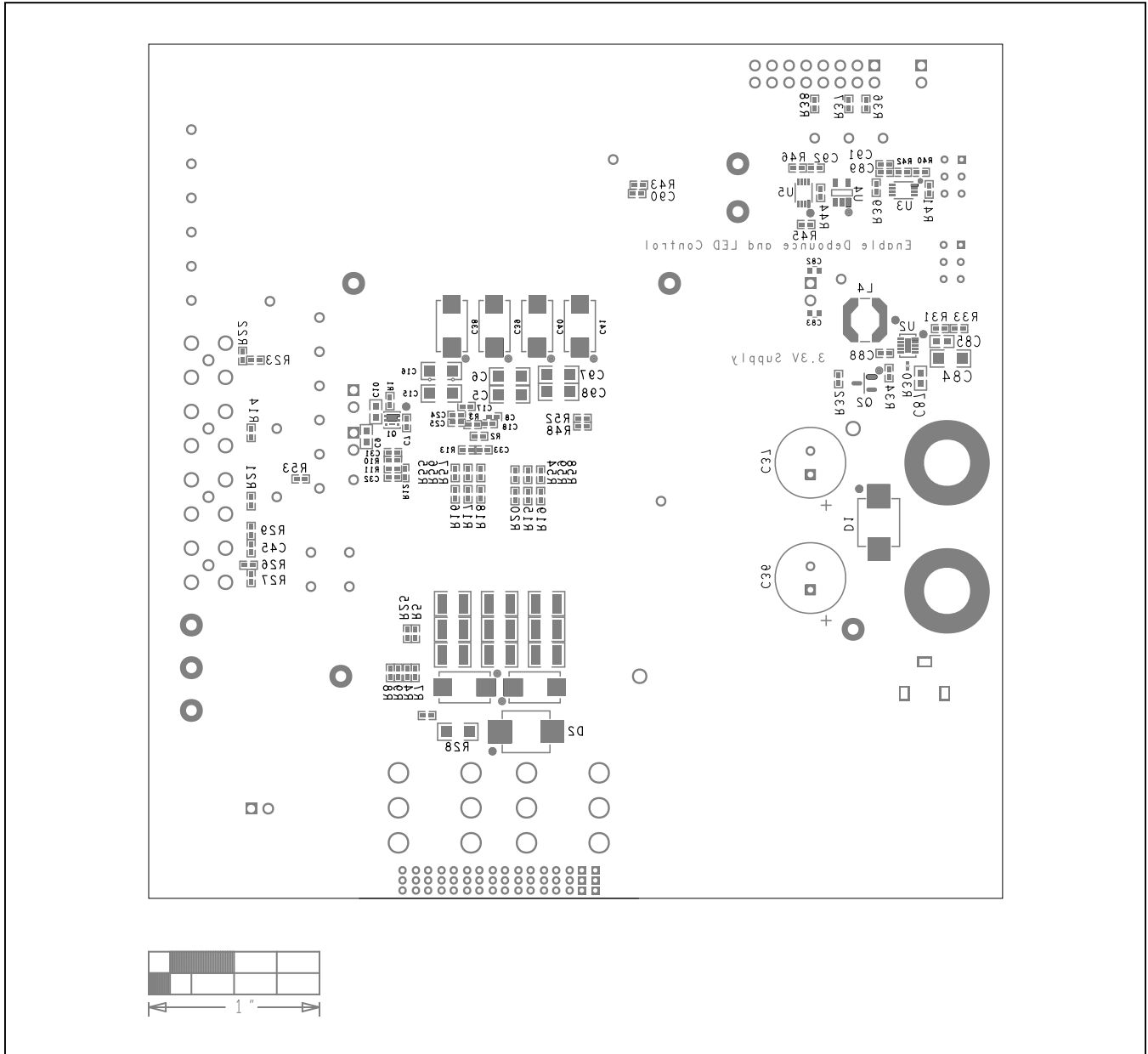

MAX20796 EV Kit PCB Layout—Bottom Silkscreen

Revision History

REVISION NUMBER	REVISION DATE	DESCRIPTION	PAGES CHANGED
0	6/19	Initial release	—
1	4/20	Updated <i>Detailed Description of Hardware (Efficiency Measurement)</i>	3

For information on other Maxim Integrated products, visit Maxim Integrated's website at www.maximintegrated.com.

Maxim Integrated cannot assume responsibility for use of any circuitry other than circuitry entirely embodied in a Maxim Integrated product. No circuit patent licenses are implied. Maxim Integrated reserves the right to change the circuitry and specifications without notice at any time.