



# 3.3GHz to 3.9GHz Wireless Broadband RF Transceiver

MAX2838

## General Description

The MAX2838 direct-conversion, zero-IF, RF transceiver is designed specifically for 3.3GHz to 3.9GHz wireless broadband systems. The MAX2838 completely integrates all circuitry required to implement the RF transceiver function, providing RF-to-baseband receive path, baseband-to-RF transmit path, VCO, frequency synthesizer, and baseband/control interface. The device includes a fast-settling sigma-delta RF synthesizer with smaller than 29Hz frequency steps. The MAX2838 supports 2Tx, 2Rx MIMO applications with a master device providing coherent LO to the slave device. The transceiver IC also integrates circuits for on-chip DC-offset cancellation, I/Q error, and carrier-leakage detection circuits. Only an RF bandpass filter (BPF), TCXO, RF switch, PA, and a small number of passive components are needed to form a complete wireless broadband RF radio solution.

The MAX2838 completely eliminates the need for an external SAW filter by implementing on-chip monolithic filters for both the receiver and transmitter. The baseband filters along with the Rx and Tx signal paths are optimized to meet the stringent noise figure and linearity specifications. The device supports up to 2048-FFT OFDM and implements programmable channel filters for 1.5MHz to 28MHz RF channel bandwidths. The transceiver requires only 2 $\mu$ s Tx-Rx switching time. The IC is available in a small 48-pin thin QFN package measuring only 6mm x 6mm x 0.8mm.

## Applications

802.16-2004/802.16d Fixed WiMAX™  
802.16e MIMO Mobile WiMAX  
WiMAX Pico and Femto Basestations  
NLOS Wireless Broadband Systems

WiMAX is a trademark of the WiMAX Forum.  
SPI is a trademark of Motorola, Inc.

## Ordering Information

PART	TEMP RANGE	PIN-PACKAGE
MAX2838ETM+T	-40°C to +85°C	48 TQFN-EP*

\*EP = Exposed paddle.

+Denotes a lead-free package.

T = Tape and reel.

## Features

- ◆ 3.3GHz to 3.9GHz Wide-Band Operation
- ◆ Master-Slave Modes with Coherent LO for MIMO
- ◆ Complete RF Transceiver, and PA Driver
  - 0dBm Linear OFDM Transmit Power
  - 70dB Tx Spectral Emission Mask
  - 2.8dB Rx Noise Figure
  - Tx/Rx I/Q Error and LO Leakage Detection and Adjustment
  - Automatic Rx DC Offset Correction
  - Monolithic Low-Noise VCO with -39dBc Integrated Phase Noise
  - Programmable Rx I/Q Lowpass Channel Filters
  - Programmable Tx I/Q Lowpass Anti-Aliasing Filter
  - Sigma-Delta Fractional-N PLL with 29Hz Step Size
  - 60dB Tx Gain Control Range with 1dB Step Size, Digitally Controlled
  - 94dB Rx Gain Control Range with 2dB Step Size, Digitally Controlled
  - 60dB Analog RSSI Instantaneous Dynamic Range
  - 4-Wire SPI™ Digital Interface
  - I/Q Analog Baseband Interface
  - Digital Tx/Rx/Shutdown Mode Control
  - Low-Power CLOCKOUT Mode
  - On-Chip Digital Temperature Sensor Readout
- ◆ +2.7V to +3.6V Transceiver Supply
- ◆ Low-Power Shutdown Mode
- ◆ Small 48-Pin Thin QFN Package (6mm x 6mm x 0.8mm)

## Pin Configuration

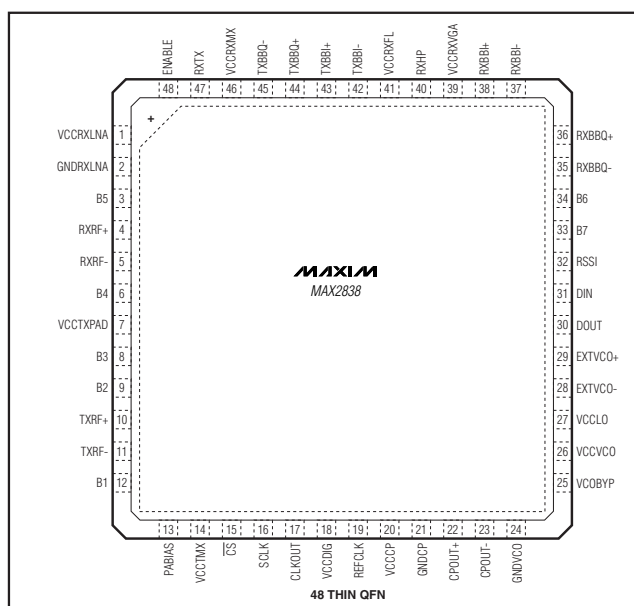

Maxim Integrated Products 1

For pricing, delivery, and ordering information, please contact Maxim Direct at 1-888-629-4642, or visit Maxim's website at [www.maxim-ic.com](http://www.maxim-ic.com).

# 3.3GHz to 3.9GHz Wireless Broadband RF Transceiver

## ABSOLUTE MAXIMUM RATINGS

V <sub>CC_</sub> Pins to GND	-0.3V to +3.6V
RF Inputs: RXRF+, RXRF-, EXTVCO+, EXTVCO- to GND	-0.3V to +3.6V
RF Outputs: TXRF+, TXRF-, EXTVCO+, EXTVCO- to GND	-0.3V to +3.6V
Analog Inputs: TXBBI+, TXBBI-, TXBBQ+, TXBBQ-, REFCLK to GND	-0.3V to +3.6V
Analog Outputs: RXBBI+, RXBBI-, RXBBQ+, RXBBQ-, RSSI, VCOBYP, CPOUT+, CPOUT-, PABIAS to GND	-0.3V to +3.6V
Digital Inputs: ENABLE, RXTX, $\overline{CS}$ , SCLK, DIN, RXHP B1-B7 to GND	-0.3V to +3.6V
Digital Outputs: DOUT, CLKOUT to GND	-0.3V to +3.6V

Short-Circuit Duration	
Analog Outputs: RXBBI+, RXBBI-, RXBBQ+, RSSI, VCOBYP, RXBBQ-, CPOUT+, CPOUT-, PABIAS, TXRF-, TXRF+	10s
Digital Outputs: DOUT, CLKOUT	10s
RF Input Power: RXRF+, RXRF-	+15dBm
RF Output Differential Load VSWR: TXRF+, TXRF-	6:1
Continuous Power Dissipation (T <sub>A</sub> = +70°C) 48-Pin Thin QFN (derate 37mW/°C above +70°C)	> 2.96W
Operating Temperature Range	-40°C to +85°C
Junction Temperature	+150°C
Storage Temperature Range	-65°C to +160°C
Lead Temperature (soldering, 10s)	+300°C

Stresses beyond those listed under "Absolute Maximum Ratings" may cause permanent damage to the device. These are stress ratings only, and functional operation of the device at these or any other conditions beyond those indicated in the operational sections of the specifications is not implied. Exposure to absolute maximum rating conditions for extended periods may affect device reliability.



**CAUTION!** ESD SENSITIVE DEVICE

## DC ELECTRICAL CHARACTERISTICS

(MAX2838 Evaluation Kit, V<sub>CC\_</sub> = 2.7V to 3.6V, T<sub>A</sub> = -40°C to +85°C, ENABLE and RXTX set according to operating mode,  $\overline{CS}$  = high, SCLK = DIN = low, transmitter and receiver in maximum gain, no input signal at RF inputs, all RF inputs and outputs terminated into 50Ω, receiver baseband outputs are open. 90mV<sub>RMS</sub> differential I and Q signals (1MHz) applied to I and Q baseband inputs of transmitter in transmit mode, all registers set to recommended settings and corresponding test mode, unless otherwise noted. Typical values are at V<sub>CC</sub> = 2.8V, f<sub>LO</sub> = 3.6GHz, and T<sub>A</sub> = +25°C, unless otherwise noted.) (Note 1)

PARAMETERS	CONDITIONS		MIN	TYP	MAX	UNITS
Supply Voltage	V <sub>CC_</sub>		2.7	2.8	3.6	V
Supply Current	Shutdown mode	T <sub>A</sub> = +25°C		12		μA
	Standby mode, see Tables 1 and 2	Single configuration		35	52	mA
		MIMO master configuration		44		
		MIMO slave configuration		11		
	Rx mode, see Tables 1 and 2	Single configuration		103	133	
		MIMO master configuration		112		
		MIMO slave configuration		80		
	Tx mode, see Tables 1 and 2	Single configuration		152	186	
		MIMO master configuration		160		
		MIMO slave configuration		128		
	Rx calibration mode, see Tables 1 and 2	Single configuration		142	182	
		MIMO master configuration		151		
		MIMO slave configuration		119		
	Tx calibration mode, see Tables 1 and 2	Single configuration		111	145	
MIMO master configuration			120			
MIMO slave configuration			88			
Rx I/Q Output Common-Mode Voltage	D9:D8 = 00 in A4:A0 = 00100		0.8	1.0	1.2	V
	D9:D8 = 01 in A4:A0 = 00100			1.1		
	D9:D8 = 10 in A4:A0 = 00100			1.2		
	D9:D8 = 11 in A4:A0 = 00100			1.35		

# 3.3GHz to 3.9GHz Wireless Broadband RF Transceiver

## DC ELECTRICAL CHARACTERISTICS (continued)

(MAX2838 Evaluation Kit,  $V_{CC\_}$  = 2.7V to 3.6V,  $T_A$  = -40°C to +85°C, ENABLE and RXTX set according to operating mode,  $\overline{CS}$  = high, SCLK = DIN = low, transmitter and receiver in maximum gain, no input signal at RF inputs, all RF inputs and outputs terminated into 50Ω, receiver baseband outputs are open. 90mV<sub>RMS</sub> differential I and Q signals (1MHz) applied to I and Q baseband inputs of transmitter in transmit mode, all registers set to recommended settings and corresponding test mode, unless otherwise noted. Typical values are at  $V_{CC}$  = 2.8V,  $f_{LO}$  = 3.6GHz, and  $T_A$  = +25°C, unless otherwise noted.) (Note 1)

PARAMETERS	CONDITIONS	MIN	TYP	MAX	UNITS
Tx Baseband Input Common-Mode Voltage Operating Range	DC-coupled	0.5		1.2	V
Tx Baseband Input Bias Current	Source current		8	20	μA
<b>LOGIC INPUTS: ENABLE, RXTX, SCLK, DIN, <math>\overline{CS}</math>, B1:B7, RXHP</b>					
Digital Input Voltage High, $V_{IH}$		$V_{CC} - 0.4$			V
Digital Input Voltage Low, $V_{IL}$				0.4	V
Digital Input Current High, $I_{IH}$		-1		+1	μA
Digital Input Current Low, $I_{IL}$		-1		+1	μA
<b>LOGIC OUTPUTS: DOUT</b>					
Digital Output Voltage High, $V_{OH}$	Sourcing 100μA	$V_{CC} - 0.4$			V
Digital Output Voltage Low, $V_{OL}$	Sinking 100μA			0.4	V

## AC ELECTRICAL CHARACTERISTICS—Rx MODE

(MAX2838 Evaluation Kit,  $V_{CC\_}$  = 2.8V,  $T_A$  = +25°C,  $f_{LO}$  = 3.6GHz,  $f_{RF}$  = 3.601GHz, receiver baseband I/Q outputs at 90mV<sub>RMS</sub>,  $f_{RF}$  = 40MHz,  $\overline{CS}$  = ENABLE = RXTX = high, SCLK = DIN = low, channel bandwidth BW = 7MHz, with power matching for the RF inputs using the typical applications and registers set to default settings and corresponding test mode, unless otherwise noted. Unmodulated single-tone RF input signal is used with specifications that normally apply over the entire operating conditions, unless otherwise indicated. Rx I/Q differential output load impedance = 10kΩ || 8pF.) (Note 1)

PARAMETER	CONDITIONS	MIN	TYP	MAX	UNITS
<b>RECEIVER SECTION: LNA RF INPUT TO BASEBAND I/Q OUTPUTS</b>					
RF Input Frequency Range		3.3		3.9	GHz
Peak-to-Peak Gain Variation over RF Input Frequency Range	Tested at band edges and band center		1.8		dB
RF Input Return Loss	All LNA settings		10		dB
Total Voltage Gain	$T_A$ = -40°C to +85°C	88	98		dB
	Maximum gain, B7:B1 = 0000000			10	
RF Gain Steps	From max RF gain to max RF Gain - 8dB		8		dB
	From max RF gain to max RF gain - 16dB		16		
	From max RF gain to max RF gain - 32dB		32		
Gain Change Settling Time	Any RF or baseband gain change; gain settling to within ±1dB of steady state; RXHP = 1		200		ns
	Any RF or baseband gain change; gain settling to within ±0.1dB of steady state; RXHP = 1		500		
Baseband Gain Range	From maximum baseband gain (B5:B1 = 00000) to minimum baseband gain (B5:B1 = 11111)		62		dB
Baseband Gain Minimum Step Size			2		dB

## 3.3GHz to 3.9GHz Wireless Broadband RF Transceiver

### AC ELECTRICAL CHARACTERISTICS—Rx MODE (continued)

(MAX2838 Evaluation Kit,  $V_{CC-} = 2.8V$ ,  $T_A = +25^{\circ}C$ ,  $f_{LO} = 3.6GHz$ ,  $f_{RF} = 3.601GHz$ , receiver baseband I/Q outputs at  $90mV_{RMS}$ ,  $f_{REF} = 40MHz$ ,  $\overline{CS} = \overline{ENABLE} = \overline{RXTX} = \text{high}$ ,  $\overline{SCLK} = \overline{DIN} = \text{low}$ , channel bandwidth  $BW = 7MHz$ , with power matching for the RF inputs using the typical applications and registers set to default settings and corresponding test mode, unless otherwise noted. Unmodulated single-tone RF input signal is used with specifications that normally apply over the entire operating conditions, unless otherwise indicated. Rx I/Q differential output load impedance =  $10k\Omega \parallel 8pF$ .) (Note 1)

PARAMETER	CONDITIONS	MIN	TYP	MAX	UNITS
DSB Noise Figure	Voltage gain $\geq 65dB$ with max RF gain (B7:B6 = 00)		2.9		dB
	Voltage gain = 50dB with max RF gain - 8dB (B7:B6 = 01)		7.9		
	Voltage gain = 45dB with max RF gain - 16dB (B7:B6 = 10)		13.7		
	Voltage gain = 15dB with max RF gain - 32dB (B7:B6 = 11)		31.4		
In-Band Input P-1dB	Max RF gain (B7:B6 = 00)		-35		dBm
	Max RF gain - 8dB (B7:B6 = 01)		-27		
	Max RF gain - 16dB (B7:B6 = 10)		-19		
	Max RF gain - 32dB (B7:B6 = 11)		-3		
Maximum Output Signal Level	Over passband frequency range; at any gain setting; 1dB compression point, differential output		2.5		$V_{P-P}$
Out-of-Band Input IP3 (Note 2)	Max RF gain (B7:B6 = 00), AGC set for -65dBm wanted signal		-10		dBm
	Max RF gain - 8dB (B7:B6 = 01), AGC set for -55dBm wanted signal		-5		
	Max RF gain - 16dB (B7:B6 = 10), AGC set for -40dBm wanted signal		-4		
	Max RF gain - 32dB (B7:B6 = 11), AGC set for -30dBm wanted signal		+23		
I/Q Phase Error	1MHz baseband output; 1 $\sigma$ variation, $T_A = +25^{\circ}C$		0.15		Degrees
I/Q Gain Imbalance	1MHz baseband output; 1 $\sigma$ variation, $T_A = +25^{\circ}C$		0.05		dB
I/Q Output DC Droop	After completion of default power-on on-chip DC cancellation, 1 $\sigma$ variation		$\pm 1$		V/s
I/Q Static DC Offset	No RF input signal; B7:B1 = 0000000, after completion of default power-on on-chip DC cancellation, 1 $\sigma$ variation		$\pm 1.0$		mV
Loopback Gain (for Receiver I/Q Calibration)	Transmitter I/Q input to receiver I/Q output; transmitter B6:B1 = 000011, receiver B5:B1 = 10011 programmed through SPI	-7.0	-2	+2.5	dB
<b>RECEIVER BASEBAND FILTERS</b>					
Baseband Highpass Filter Corner Frequency	Corner frequency 1		600		kHz
	Corner frequency 2		100		
	Corner frequency 3		30		
	Corner frequency 4		1		
	Corner frequency 5		0.1		

# 3.3GHz to 3.9GHz Wireless Broadband RF Transceiver

**MAX2838**

## AC ELECTRICAL CHARACTERISTICS—Rx MODE (continued)

(MAX2838 Evaluation Kit,  $V_{CC-} = 2.8V$ ,  $T_A = +25^{\circ}C$ ,  $f_{LO} = 3.6GHz$ ,  $f_{RF} = 3.601GHz$ , receiver baseband I/Q outputs at  $90mV_{RMS}$ ,  $f_{REF} = 40MHz$ ,  $\overline{CS} = \overline{ENABLE} = \overline{RXTX} = \text{high}$ ,  $SCLK = \overline{DIN} = \text{low}$ , channel bandwidth  $BW = 7MHz$ , with power matching for the RF inputs using the typical applications and registers set to default settings and corresponding test mode, unless otherwise noted. Unmodulated single-tone RF input signal is used with specifications that normally apply over the entire operating conditions, unless otherwise indicated. Rx I/Q differential output load impedance =  $10k\Omega \parallel 8pF$ .) (Note 1)

PARAMETER	CONDITIONS	MIN	TYP	MAX	UNITS
RF Channel BW Supported by Baseband Filter	A4:A0 = 00010 serial bits D7:D4 = 0000		1.5		MHz
	A4:A0 = 00010 serial bits D7:D4 = 0001		1.75		
	A4:A0 = 00010 serial bits D7:D4 = 0010		3.5		
	A4:A0 = 00010 serial bits D7:D4 = 0011		5.0		
	A4:A0 = 00010 serial bits D7:D4 = 0100		5.5		
	A4:A0 = 00010 serial bits D7:D4 = 0101		6.0		
	A4:A0 = 00010 serial bits D7:D4 = 0110		7.0		
	A4:A0 = 00010 serial bits D7:D4 = 0111		8.0		
	A4:A0 = 00010 serial bits D7:D4 = 1000		9.0		
	A4:A0 = 00010 serial bits D7:D4 = 1001		10.0		
	A4:A0 = 00010 serial bits D7:D4 = 1010		12.0		
	A4:A0 = 00010 serial bits D7:D4 = 1011		14.0		
	A4:A0 = 00010 serial bits D7:D4 = 1100		15.0		
	A4:A0 = 00010 serial bits D7:D4 = 1101		20.0		
	A4:A0 = 00010 serial bits D7:D4 = 1110		24.0		
A4:A0 = 00010 serial bits D7:D4 = 1111		28.0			
Baseband Gain Ripple	0 to 3.2MHz for $BW = 7MHz$		1		dBp-p
Baseband Group Delay Ripple	0 to 3.2MHz for $BW = 7MHz$		65		nsp-p
Baseband Filter Rejection for 7MHz RF Channel BW	At 4.67MHz		7		dB
	At > 10.5MHz		53		
	At > 14MHz		75		
	At > 29.4MHz		75		
<b>RSSI</b>					
RSSI Minimum Output Voltage	$R_{LOAD} \geq 10k\Omega$		0.65		V
RSSI Maximum Output Voltage	$R_{LOAD} \geq 10k\Omega$		2.4		V
RSSI Slope			30		mV/dB
RSSI Output Settling Time	To within 3dB of steady state	+32dB signal step	200		ns
		-32dB signal step	800		

## 3.3GHz to 3.9GHz Wireless Broadband RF Transceiver

### AC ELECTRICAL CHARACTERISTICS—Tx MODE

(MAX2838 Evaluation Kit,  $V_{CC-} = 2.8V$ ,  $T_A = +25^{\circ}C$ ,  $f_{RF} = 3.601GHz$ ,  $f_{LO} = 3.6GHz$ ,  $f_{REF} = 40MHz$ ,  $\overline{CS} = high$ , and  $RXTX = SCLK = DIN = low$ , with power matching for the differential RF pins using the *Typical Operating Circuit*. Lowpass filter is set to 7MHz RF channel BW, 90mV<sub>RMS</sub> sine and cosine signal (or 90mV<sub>RMS</sub> 64QAM 1024-FFT OFDMA FUSC I/Q signals wherever OFDM is mentioned) applied to baseband I/Q inputs of transmitter (differential DC-coupled). Registers set to recommended settings and corresponding test mode, unless otherwise noted.) (Note 1)

PARAMETER	CONDITIONS	MIN	TYP	MAX	UNITS
<b>TRANSMIT SECTION: Tx BASEBAND I/Q INPUTS TO RF OUTPUTS</b>					
RF Output Frequency Range		3.3		3.9	GHz
Peak-to-Peak Gain Variation over RF Band			2.6		dB
Total Voltage Gain	Maximum gain; at unbalanced 50Ω matched output		8		dB
Maximum Output Power over Frequency	OFDM signal conforming to spectral emission mask and -36dB EVM after I/Q imbalance calibration by modem (Note 3)		0		dBm
RF Output Return Loss	All gain settings		7		dB
RF Gain Control Range			60		dB
RF Gain Control Binary Weights	B1		1		dB
	B2		2		
	B3		4		
	B4		8		
	B5		16		
	B6		32		
Unwanted Sideband Suppression	Without calibration by modem, and excludes modem I/Q imbalance; $P_{OUT} = 0dBm$		-40		dBc
Carrier Leakage	Relative to 0dBm output power; without calibration by modem		-40		dBc
Tx I/Q Input Impedance (R    C)	Minimum differential resistance		60		kΩ
	Maximum differential capacitance		0.5		pF
Baseband Frequency Response for 7MHz RF Channel BW	0 to 4.67MHz		-8		dB
	At > 13.23MHz		-45		
Baseband Group Delay Ripple	0 to 4.9MHz (BW = 7MHz)		15		nsp-p

### AC ELECTRICAL CHARACTERISTICS—FREQUENCY SYNTHESIS

(MAX2838 Evaluation Kit,  $V_{CC} = 2.8V$ ,  $T_A = +25^{\circ}C$ ,  $f_{LO} = 3.6GHz$ ,  $f_{REF} = 40MHz$ ,  $\overline{CS} = high$ ,  $SCLK = DIN = low$ , PLL loop bandwidth = 180kHz, charge-pump comparison frequency = 40MHz,  $T_A = +25^{\circ}C$ , unless otherwise noted.) (Note 1)

PARAMETER	CONDITIONS	MIN	TYP	MAX	UNITS
<b>FREQUENCY SYNTHESIZER</b>					
RF Channel Center Frequency		3.3		3.9	GHz
Channel Center Frequency Programming Minimum Step Size			29		Hz
Charge-Pump Comparison Frequency		11	40		MHz
Reference Frequency Range		11	40	80	MHz
Reference Frequency Input Levels	AC-coupled to REFCLK pin	800			mVp-p

# 3.3GHz to 3.9GHz Wireless Broadband RF Transceiver

**MAX2838**

## AC ELECTRICAL CHARACTERISTICS—FREQUENCY SYNTHESIS (continued)

(MAX2838 Evaluation Kit,  $V_{CC} = 2.8V$ ,  $T_A = +25^\circ C$ ,  $f_{LO} = 3.6GHz$ ,  $f_{REF} = 40MHz$ ,  $\overline{CS} = high$ ,  $SCLK = DIN = low$ , PLL loop bandwidth = 180kHz, charge-pump comparison frequency = 40MHz,  $T_A = +25^\circ C$ , unless otherwise noted.) (Note 1)

PARAMETER	CONDITIONS	MIN	TYP	MAX	UNITS
Programmable Reference Divider Values	A4:A0 = 10100, D2:D1 = 00		1		
	A4:A0 = 10100, D2:D1 = 01		2		
Closed-Loop Integrated Phase Noise	Loop BW = 180kHz, integrate phase noise from 200Hz to 5MHz		-39		dBc
Charge-Pump Output Current	On each differential side		0.8		mA
Close-In Spur Level	$f_{OFFSET} = 0$ to 1.8MHz		-45		dBc
	$f_{OFFSET} = 1.8MHz$ to 7MHz		-70		
	$f_{OFFSET} > 7MHz$		-80		
Reference Spur Level	$f_{OFFSET} \geq 40MHz$		-73		dBc
Turnaround LO Frequency Error	Relative to steady state; measured 35 $\mu s$ after Tx-Rx or Rx-Tx switching instant, and 4 $\mu s$ after any receiver gain changes		$\pm 50$		Hz
Temperature Range over which VCO Maintains Lock	Relative to the initial ambient temperature $T_A$ , as long as the final temperature is within operating temperature range		$T_A \pm 40$		$^\circ C$
CLKOUT Frequency Divider Values	A4:A0 = 10100, D6:D5 = 01 (Note 4)		2		
CLKOUT Output Swing	R = 10k $\Omega$ , C = 10pF	Low drive	1.6		V <sub>P-P</sub>
		High drive	2.4		
External VCO Input Power	MIMO slave mode only		-10		dBm
External VCO Output Power	MIMO master mode only		-8		dBm

## AC ELECTRICAL CHARACTERISTICS—MISCELLANEOUS BLOCKS

(MAX2838 Evaluation Kit,  $V_{CC} = 2.8V$ ,  $f_{REF} = 40MHz$ ,  $\overline{CS} = high$ ,  $SCLK = DIN = low$ , and  $T_A = +25^\circ C$ , unless otherwise noted) (Note 1)

PARAMETER	CONDITIONS	MIN	TYP	MAX	UNITS
<b>PA BIAS DAC: CURRENT MODE</b>					
Numbers of bits			6		
Minimum Output Sink Current	D5:D0 = 000000 in A4:A0 = 11100		0		$\mu A$
Maximum Output Sink Current	D5:D0 = 111111 in A4:A0 = 11100		310		$\mu A$
Compliance Voltage Range		0.8			V
Turn-On Time	Excludes programmable delay of 0 to 7 $\mu s$ in steps of 0.5 $\mu s$		200		ns
DNL			1		LSB
<b>PA BIAS DAC: VOLTAGE MODE</b>					
Output High Level	10mA source current		$V_{CC} - 0.2$		V
Output Low Level	10mA sink current		0.1		V
Turn-On Time	Excludes programmable delay of 0 to 7 $\mu s$ in steps of 0.5 $\mu s$		200		ns
<b>ON-CHIP TEMPERATURE SENSOR</b>					
Digital Output Code	Read-out at DOUT pin through SPI A4:A0 = 00111, D4:D0	$T_A = +25^\circ C$	01111		
		$T_A = +85^\circ C$	11001		
		$T_A = -40^\circ C$	00100		
Temperature Step Size			5		$^\circ C$

# 3.3GHz to 3.9GHz Wireless Broadband RF Transceiver

## AC ELECTRICAL CHARACTERISTICS—TIMING

(MAX2838 Evaluation Kit,  $V_{CC} = 2.8V$ ,  $f_{LO} = 3.6GHz$ ,  $f_{REF} = 40MHz$ ,  $\overline{CS} = \text{high}$ ,  $SCLK = DIN = \text{low}$ , PLL loop bandwidth = 180kHz, and  $T_A = +25^\circ C$ , unless otherwise noted.) (Note 1)

PARAMETER	SYMBOL	CONDITIONS	MIN	TYP	MAX	UNITS
<b>SYSTEM TIMING</b>						
Channel Switching Time	Frequency error settles to $\pm 50Hz$	Automatic VCO sub-band selection		2		ms
		Manual VCO sub-band selection		56		$\mu s$
Turnaround Time		Measured from Tx or Rx enable rising edge, signal settling to within 0.5dB of steady state	Rx to Tx	2		$\mu s$
			Tx to Rx	2		
Tx Turn-On Time (from Standby Mode)		Measured from Tx enable rising edge, signal settling to within 0.5dB of steady state		2		$\mu s$
Tx Turn-Off Time (to Standby Mode)		From Tx-enable falling edge		0.1		$\mu s$
Rx Turn-On Time (from Standby Mode)		Measured from Rx enable rising edge, signal settling to within 0.5dB of steady state		2		$\mu s$
Rx Turn-Off Time (to Standby Mode)		From Rx-enable falling edge		0.1		$\mu s$
<b>4-WIRE SERIAL INTERFACE TIMING (See Figure 1)</b>						
SCLK Rising Edge to $\overline{CS}$ Falling Edge Wait Time	$t_{CSO}$			6		ns
Falling Edge of $\overline{CS}$ to Rising Edge of First SCLK Time	$t_{CSS}$			6		ns
DIN to SCLK Setup Time	$t_{DS}$			6		ns
DIN to SCLK Hold Time	$t_{DH}$			6		ns
SCLK Pulse-Width High	$t_{CH}$			6		ns
SCLK Pulse-Width Low	$t_{CL}$			6		ns
Last Rising Edge of SCLK to Rising Edge of $\overline{CS}$ or Clock to Load Enable Setup Time	$t_{CSH}$			6		ns
$\overline{CS}$ High Pulse Width	$t_{CSW}$			20		ns
Time Between Rising Edge of $\overline{CS}$ and the Next Rising Edge of SCLK	$t_{CS1}$			6		ns
Clock Frequency	$f_{CLK}$				45	MHz
Rise Time	$t_R$			$f_{CLK} / 10$		ns
Fall Time	$t_F$			$f_{CLK} / 10$		ns
SCLK Falling Edge to Valid DOUT	$t_D$			12.5		ns

**Note 1:** Min and max limits are guaranteed by test above  $T_A = +25^\circ C$  and are guaranteed by design and characterization at  $T_A = -40^\circ C$ . The power-on register settings are not guaranteed. Recommended register setting must be loaded after  $V_{CC}$  is supplied.

**Note 2:** Two tones at +20MHz and +39MHz offset with -35dBm/tone. Measure IM3 at 1MHz.

**Note 3:** Gain adjusted over max gain and max gain - 3dB.

**Note 4:**  $V_{CC}$  rise time (0V to 2.7V) must be less than 1ms.



# 3.3GHz to 3.9GHz Wireless Broadband RF Transceiver

## Typical Operating Characteristics

( $V_{CC} = 2.8V$ ,  $T_A = +25^\circ C$ ,  $f_{LO} = 3.6GHz$ ,  $f_{REF} = 40MHz$ ,  $\overline{CS} = high$ ,  $RXHP = SCLK = DIN = low$ ,  $RF BW = 7MHz$ , using the MAX2838 Evaluation Kit.)

### RECEIVER

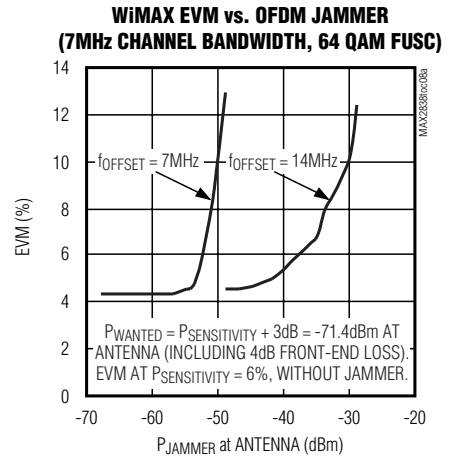
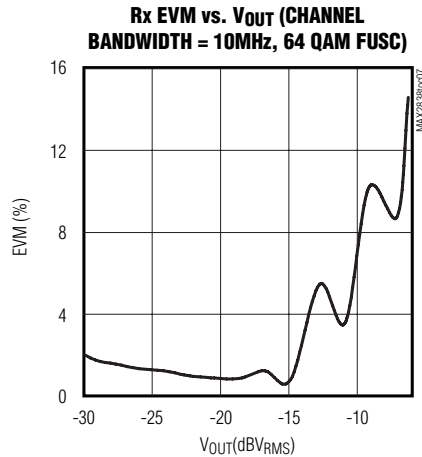
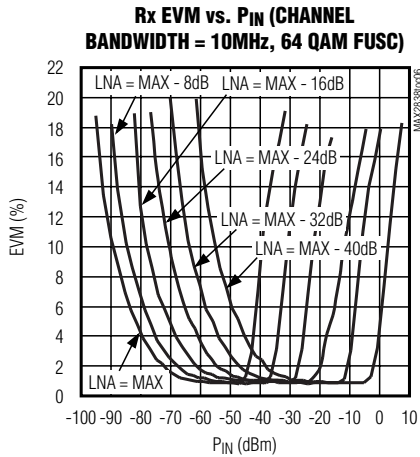
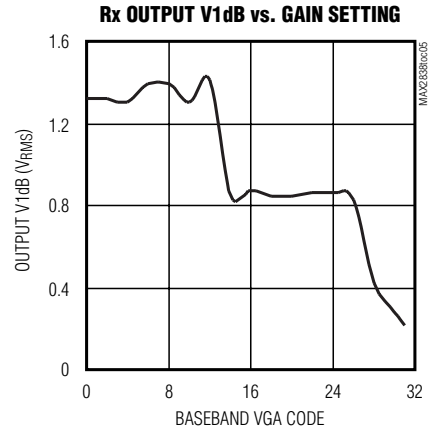
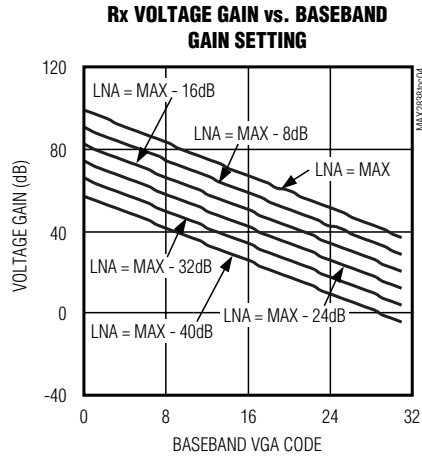
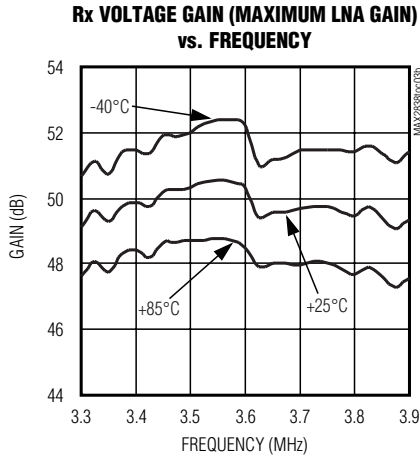
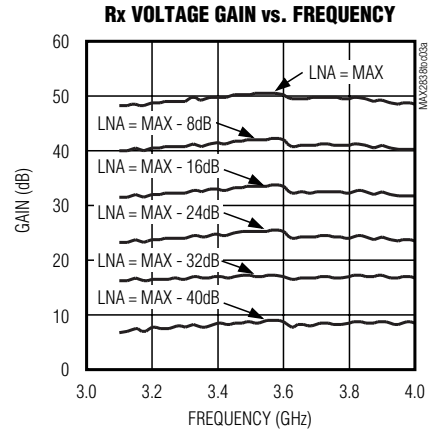
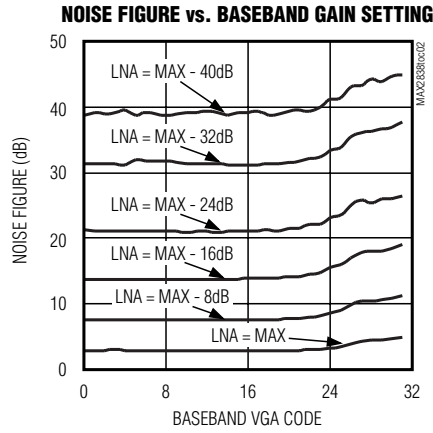
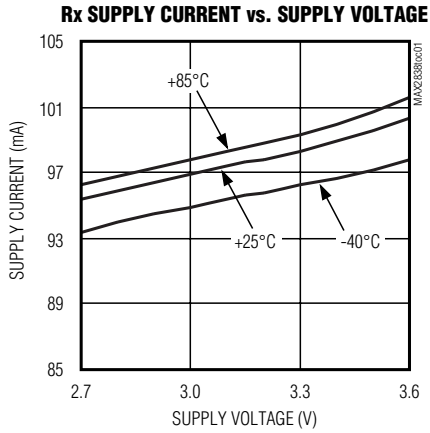

# 3.3GHz to 3.9GHz Wireless Broadband RF Transceiver

## Typical Operating Characteristics (continued)

( $V_{CC} = 2.8V$ ,  $T_A = +25^\circ C$ ,  $f_{LO} = 3.6GHz$ ,  $f_{REF} = 40MHz$ ,  $\overline{CS} = high$ ,  $RXHP = SCLK = DIN = low$ ,  $RF BW = 7MHz$ , using the MAX2838 Evaluation Kit.)

**WiMAX EVM vs. OFDM JAMMER  
(10MHz CHANNEL BANDWIDTH, 64 QAM FUSC)**

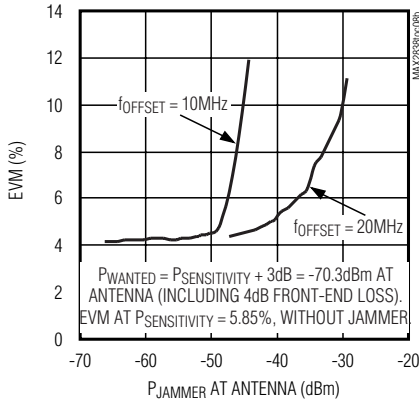

**Rx EMISSION SPECTRUM, LNA INPUT  
(Tx OFF, LNA = MAX)**

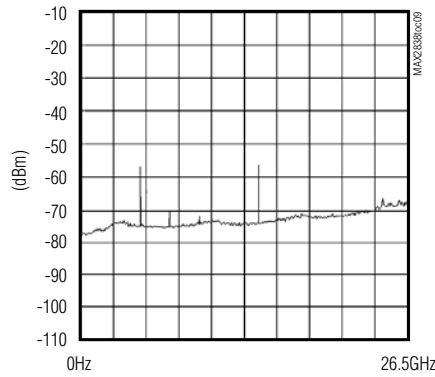

**Rx INPUT DIFFERENTIAL IMPEDANCE  
vs. FREQUENCY**

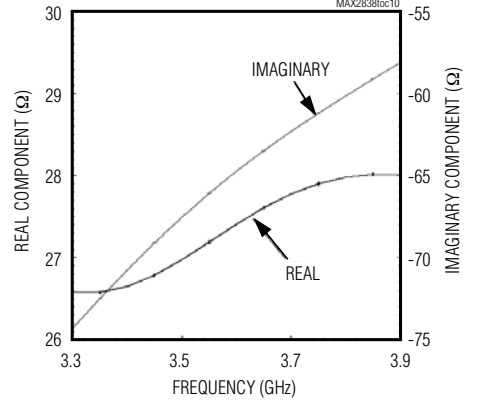

**Rx INPUT RETURN LOSS vs. FREQUENCY  
(LNA = MAX)**

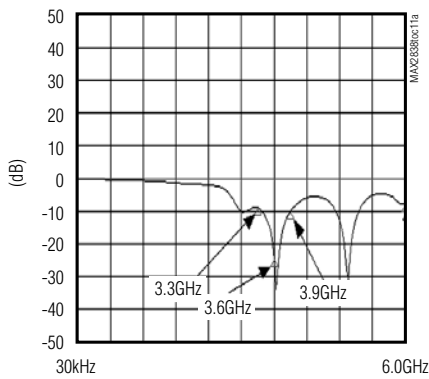

**Rx INPUT RETURN LOSS vs. FREQUENCY  
(LNA = MAX - 32dB)**

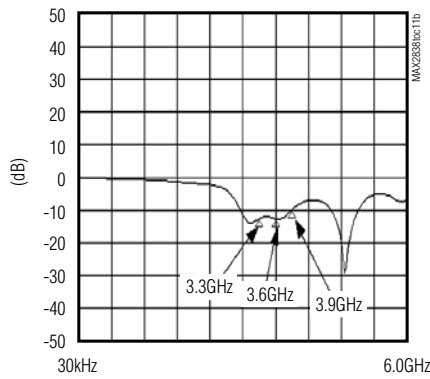

**RSSI VOLTAGE vs. INPUT POWER**

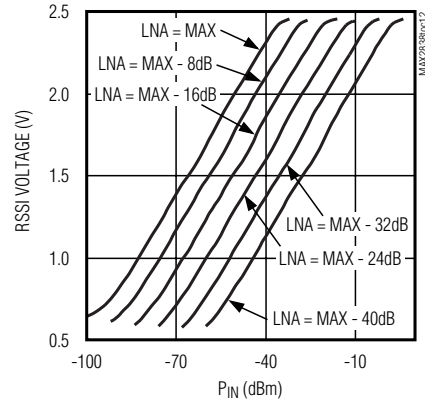

**Rx RSSI STEP RESPONSE  
(+40dB SIGNAL STEP)**

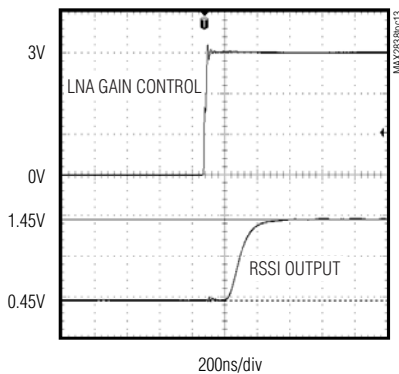

**Rx RSSI STEP RESPONSE  
(-40dB SIGNAL STEP)**

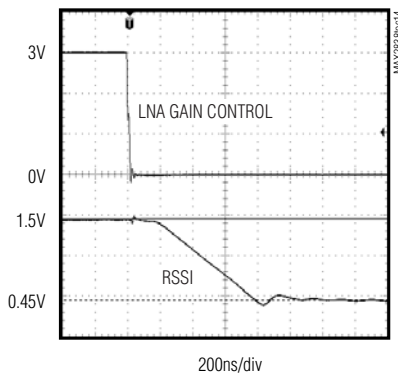

**Rx LPF GROUP DELAY vs. FREQUENCY**

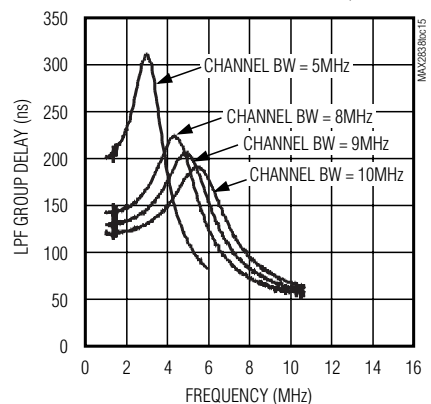

# 3.3GHz to 3.9GHz Wireless Broadband RF Transceiver

MAX2838

## Typical Operating Characteristics (continued)

( $V_{CC} = 2.8V$ ,  $T_A = +25^\circ C$ ,  $f_{LO} = 3.6GHz$ ,  $f_{REF} = 40MHz$ ,  $\overline{CS} = high$ ,  $RXHP = SCLK = DIN = low$ ,  $RF BW = 7MHz$ , using the MAX2838 Evaluation Kit.)

**Rx DC OFFSET SETTLING RESPONSE  
(+8dB BB VGA GAIN STEP)**

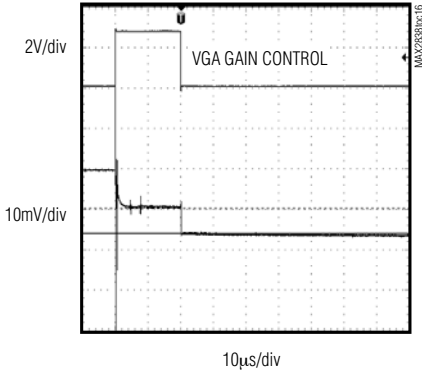

**Rx DC OFFSET SETTLING RESPONSE  
(-8dB BB VGA GAIN STEP)**

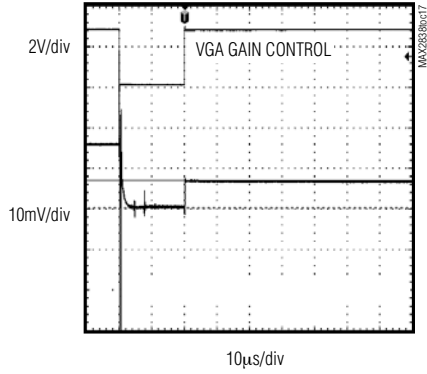

**Rx DC OFFSET SETTLING RESPONSE  
(-16dB BB VGA GAIN STEP)**

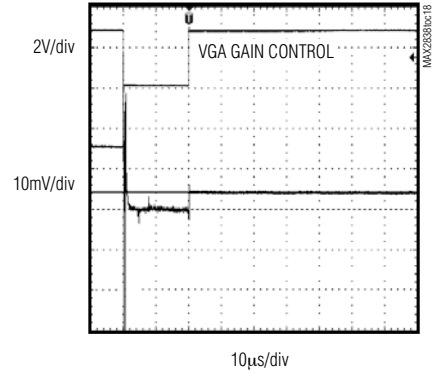

**Rx DC OFFSET SETTLING RESPONSE  
(-32dB BB VGA GAIN STEP)**

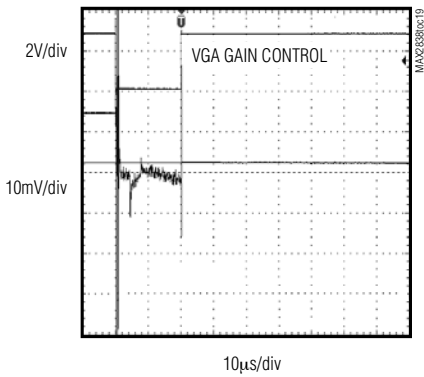

**Rx BBVGA SETTLING RESPONSE  
(+8dB GAIN STEP)**

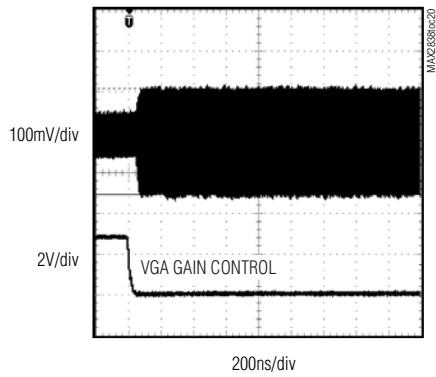

**Rx BBVGA SETTLING RESPONSE  
(-8dB BB VGA GAIN STEP)**

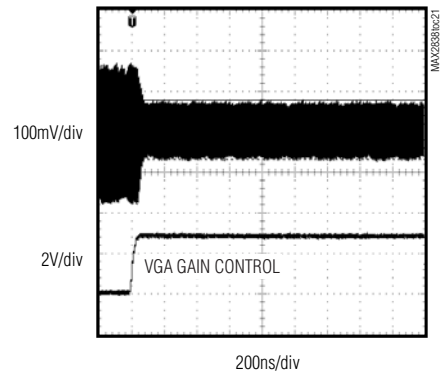

**Rx BBVGA SETTLING RESPONSE  
(-16dB GAIN STEP)**

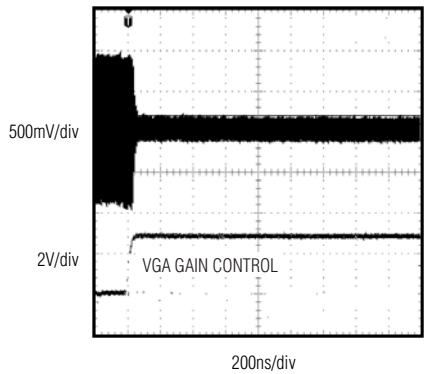

**Rx BBVGA SETTLING RESPONSE  
(-32dB GAIN STEP)**

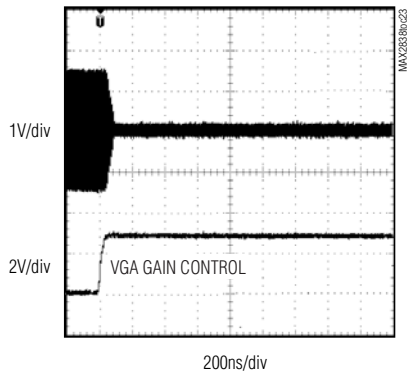

**Rx LNA SETTLING RESPONSE  
(MAX TO MAX - 8dB)**

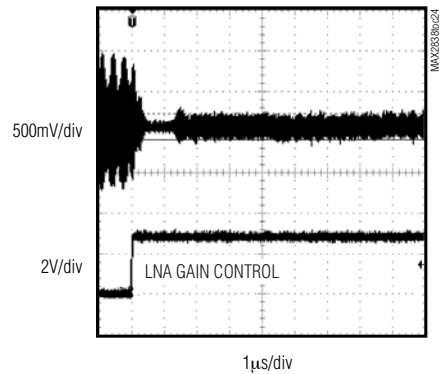

# 3.3GHz to 3.9GHz Wireless Broadband RF Transceiver

## Typical Operating Characteristics (continued)

( $V_{CC} = 2.8V$ ,  $T_A = +25^\circ C$ ,  $f_{LO} = 3.6GHz$ ,  $f_{REF} = 40MHz$ ,  $\overline{CS} = high$ ,  $RXHP = SCLK = DIN = low$ ,  $RF BW = 7MHz$ , using the MAX2838 Evaluation Kit.)

**Rx LNA Settling Response  
(MAX TO MAX - 16dB)**

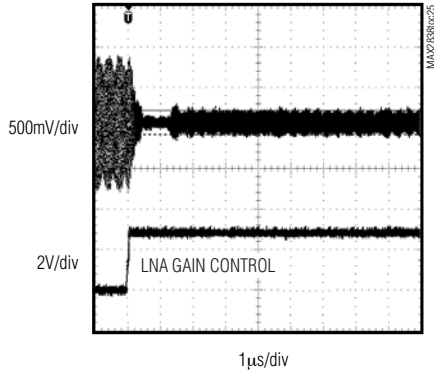

**Rx BB Frequency Response**

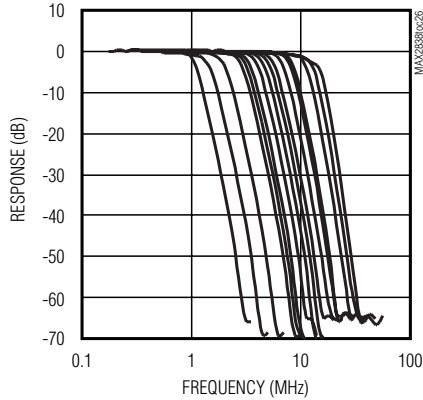

**Rx BB Frequency Response**

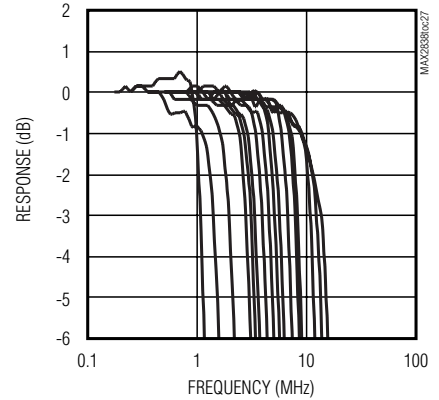

**HISTOGRAM: IQ Gain Imbalance**

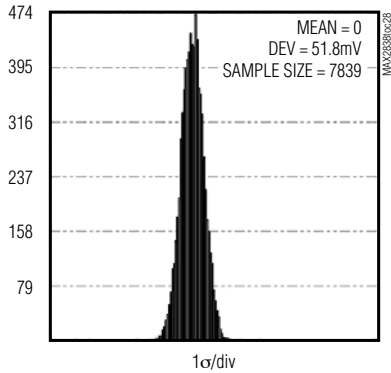

**HISTOGRAM: Rx Phase Imbalance**

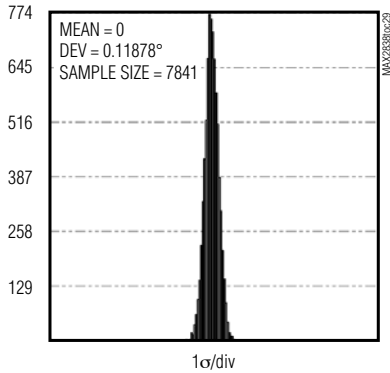

**HISTOGRAM: Rx Static DC Offset**

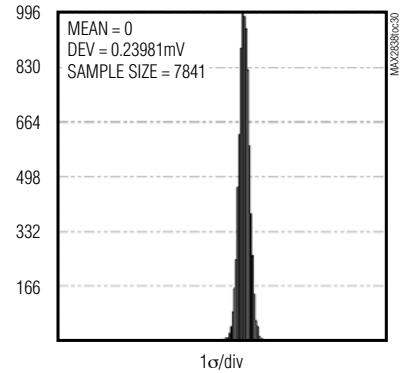

**POWER-ON DC OFFSET CANCELLATION  
WITH INPUT SIGNAL**

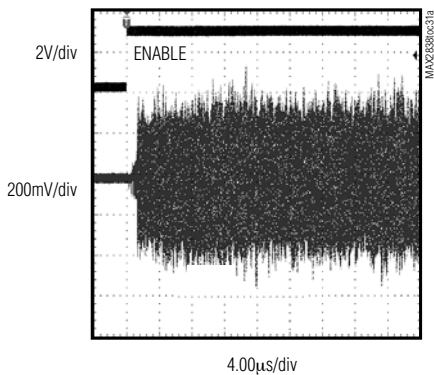

**POWER-ON DC OFFSET CANCELLATION  
WITHOUT INPUT SIGNAL**

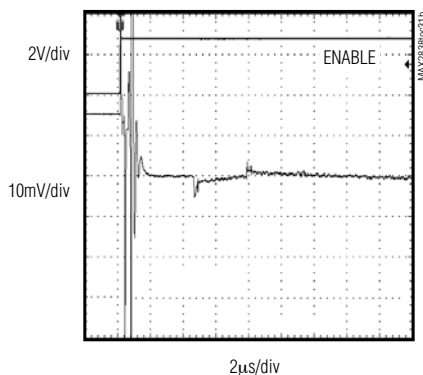

## TRANSMITTER

**Tx Supply Current vs. Supply Voltage**

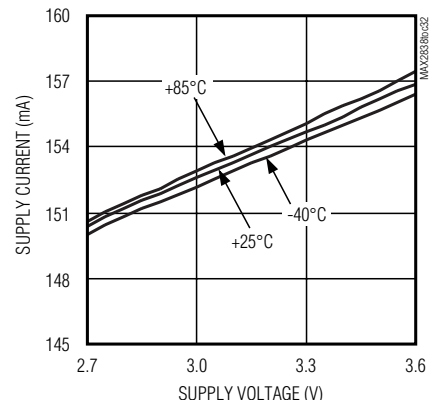

# 3.3GHz to 3.9GHz Wireless Broadband RF Transceiver

## Typical Operating Characteristics (continued)

( $V_{CC} = 2.8V$ ,  $T_A = +25^\circ C$ ,  $f_{LO} = 3.6GHz$ ,  $f_{REF} = 40MHz$ ,  $\overline{CS} = high$ ,  $RXHP = SCLK = DIN = low$ ,  $RF BW = 7MHz$ , using the MAX2838 Evaluation Kit.)

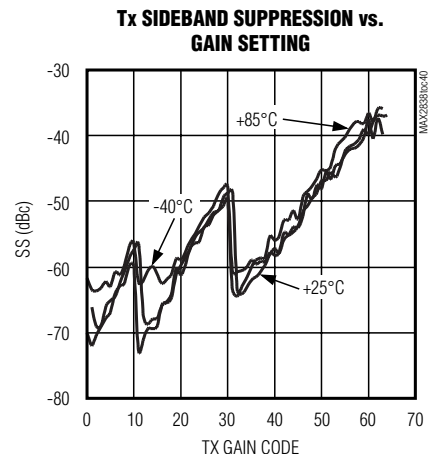
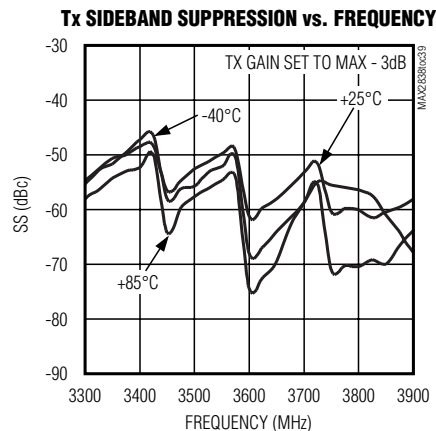
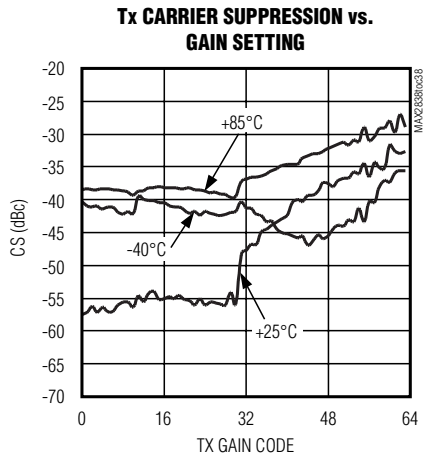
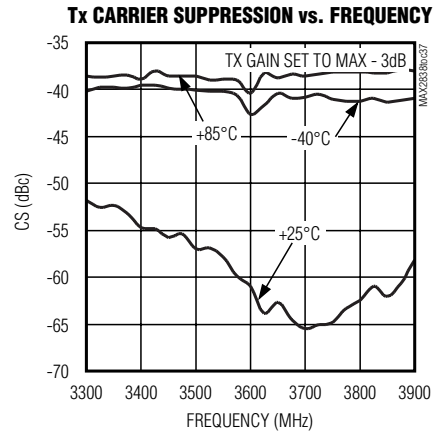
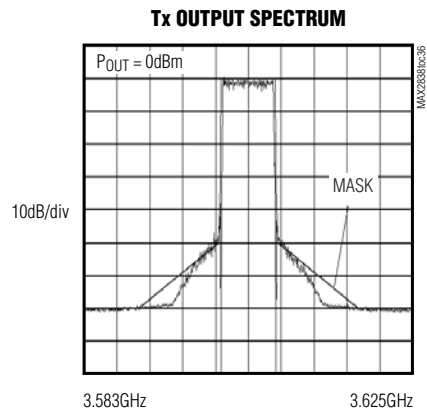
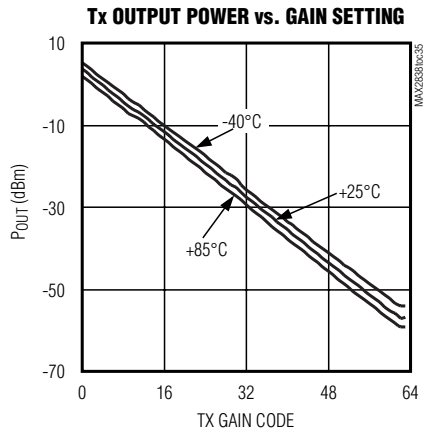
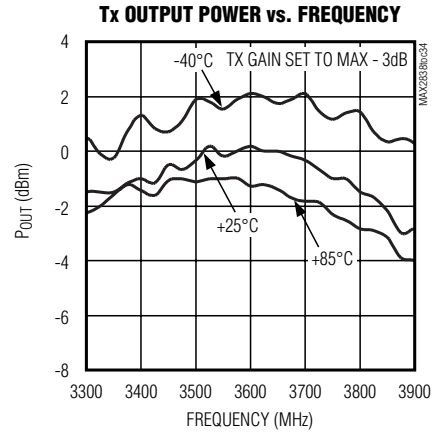
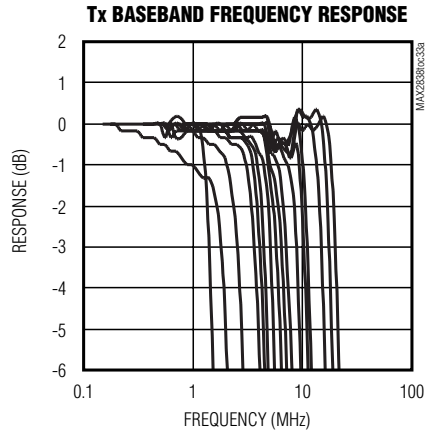
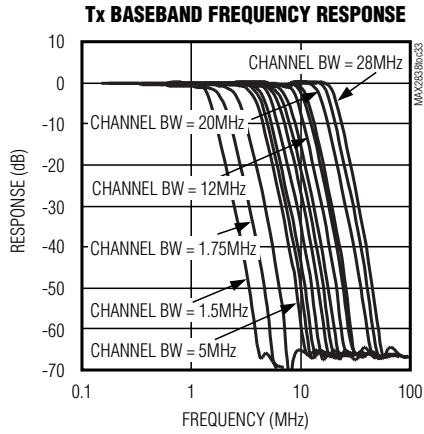

# 3.3GHz to 3.9GHz Wireless Broadband RF Transceiver

## Typical Operating Characteristics (continued)

( $V_{CC} = 2.8V$ ,  $T_A = +25^\circ C$ ,  $f_{LO} = 3.6GHz$ ,  $f_{REF} = 40MHz$ ,  $\overline{CS} = high$ ,  $RXHP = SCLK = DIN = low$ ,  $RF BW = 7MHz$ , using the MAX2838 Evaluation Kit.)

**EVM vs. Tx OUTPUT POWER (64 QAM FUSC, 10MHz CHANNEL BANDWIDTH)**

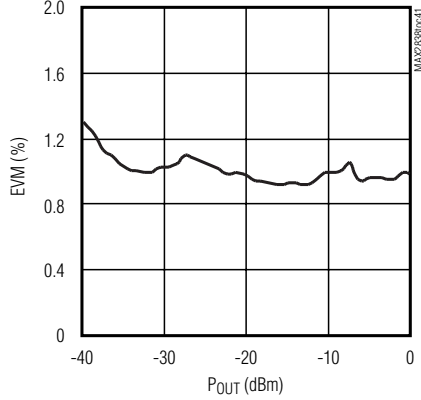

**Tx OUTPUT EMISSION SPECTRUM**

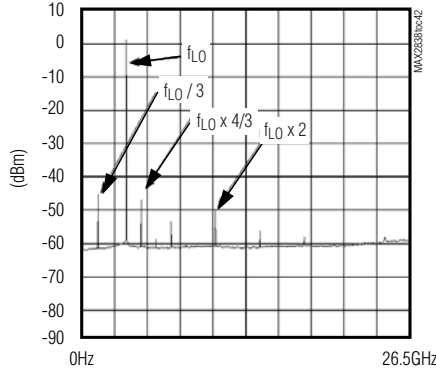

**HISTOGRAM: Tx LO LEAKAGE**

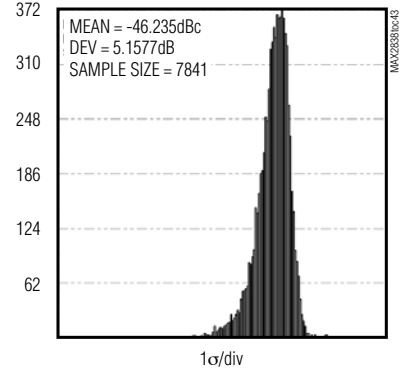

**HISTOGRAM: Tx SIDEBAND SUPPRESSION**

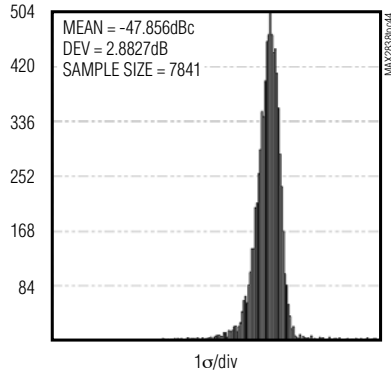

**Tx OUTPUT RETURN LOSS vs. FREQUENCY**

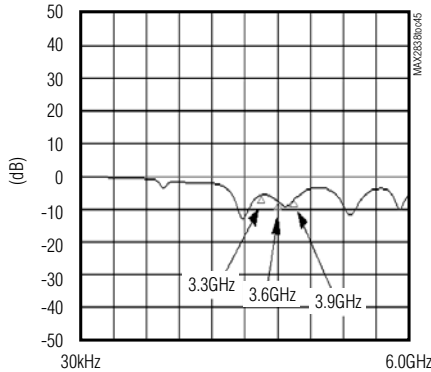

**SYNTHESIZER  
LO FREQUENCY vs.  
DIFFERENTIAL TUNE VOLTAGE**

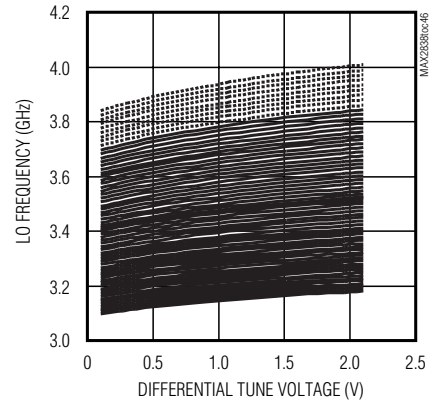

**PHASE NOISE vs. OFFSET FREQUENCY**

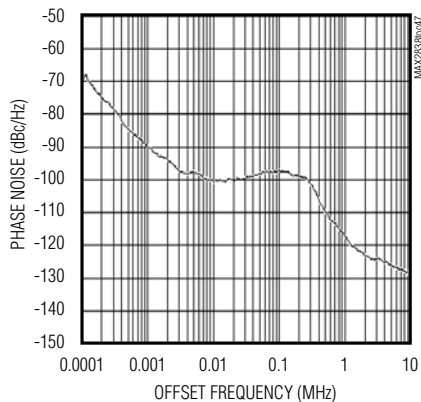

**VCO GAIN vs. DIFFERENTIAL TUNE VOLTAGE**

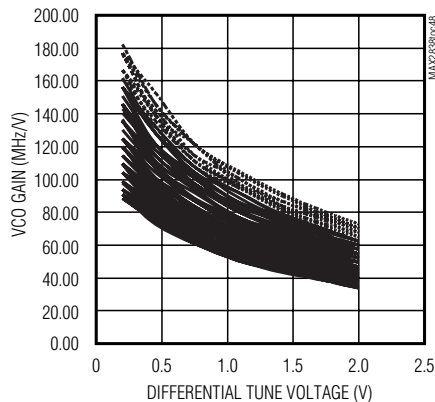

**CHANNEL-SWITCHING FREQUENCY SETTLING  
(3.3GHz TO 3.9GHz, MANUAL VCO SUB-BAND SELECTION)**

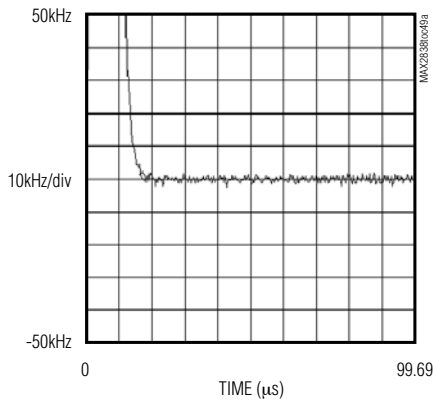

# 3.3GHz to 3.9GHz Wireless Broadband RF Transceiver

MAX2838

## Typical Operating Characteristics (continued)

( $V_{CC} = 2.8V$ ,  $T_A = +25^\circ C$ ,  $f_{LO} = 3.6GHz$ ,  $f_{REF} = 40MHz$ ,  $\overline{CS} = high$ ,  $RXHP = SCLK = DIN = low$ ,  $RF BW = 7MHz$ , using the MAX2838 Evaluation Kit.)

**CHANNEL-SWITCHING FREQUENCY SETTling**  
(3.9GHz TO 3.3GHz, MANUAL VCO SUB-BAND SELECTION)

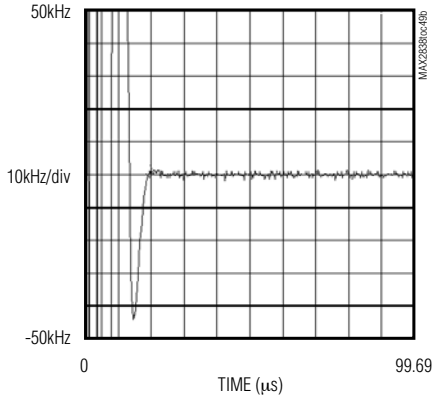

**CHANNEL-SWITCHING FREQUENCY SETTling**  
(3.9GHz TO 3.3GHz, AUTOMATIC VCO SUB-BAND SELECTION)

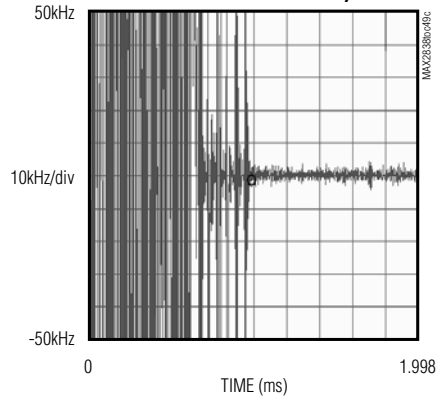

**CHANNEL-SWITCHING FREQUENCY SETTling**  
(3.3GHz TO 3.9GHz, AUTOMATIC VCO SUB-BAND SELECTION)

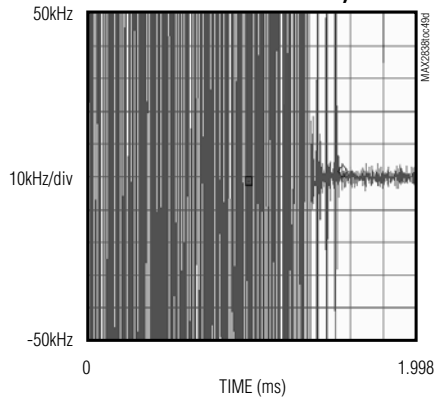

**Rx-TO-Tx TURNAROUND FREQUENCY GLITCH SETTling**

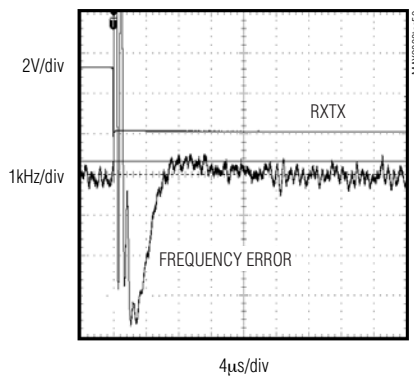

**Tx-TO-Rx TURNAROUND FREQUENCY GLITCH SETTling**

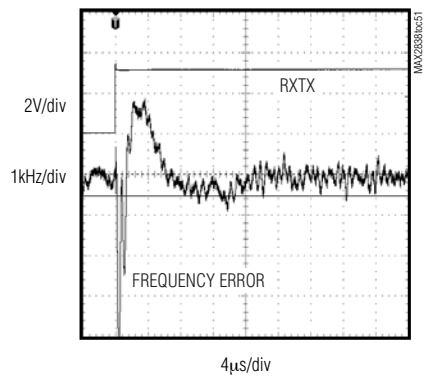

# 3.3GHz to 3.9GHz Wireless Broadband RF Transceiver

## Typical Operating Circuit

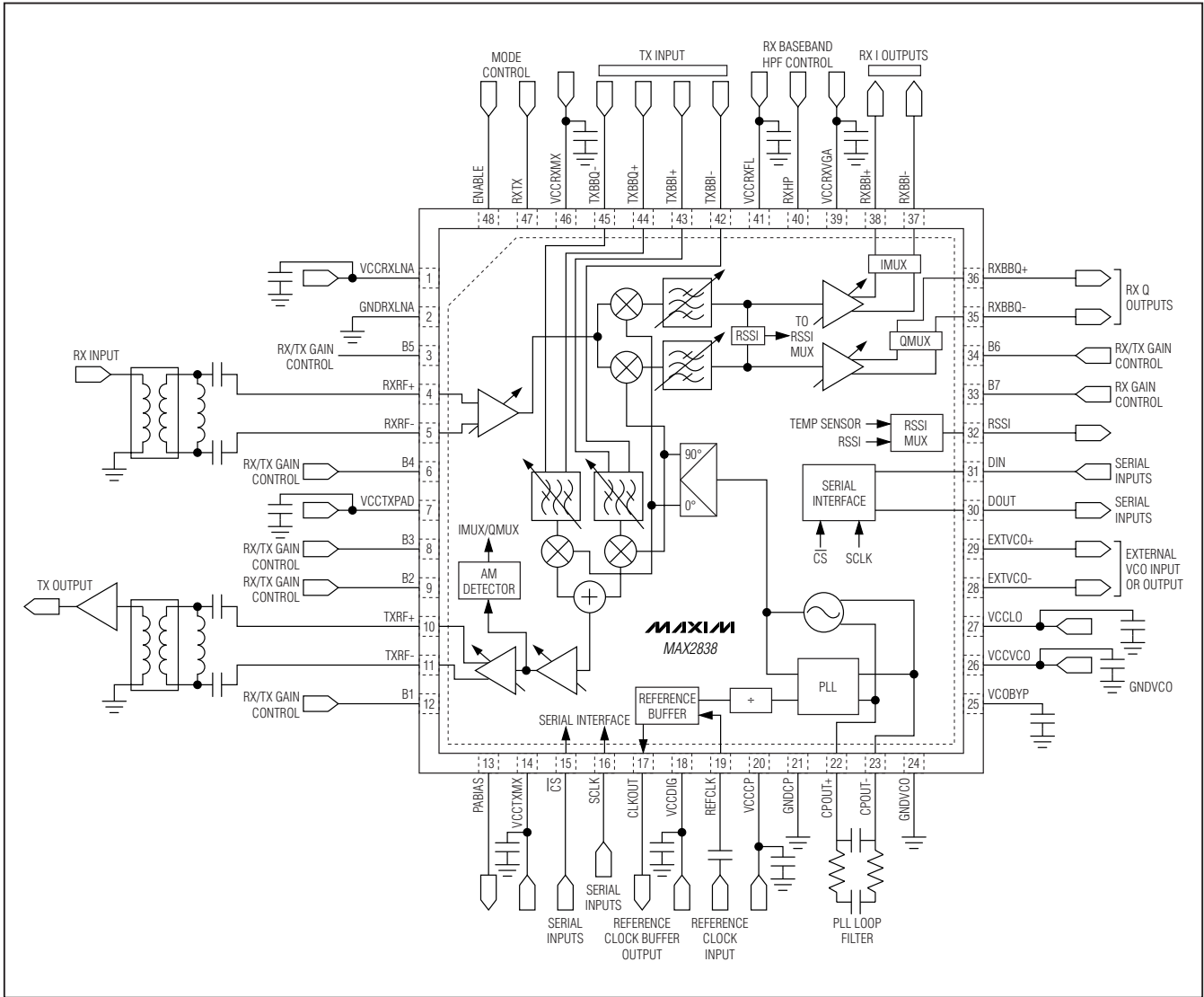



# 3.3GHz to 3.9GHz Wireless Broadband RF Transceiver

## Pin Description

**MAX2838**

PIN	NAME	FUNCTION
1	VCCRXLNA	LNA Supply Voltage. Bypass with a capacitor as close as possible to the pin.
2	GNDRXLNA	LNA Ground
3	B5	Receiver and Transmitter Gain-Control Logic Input Bit 5
4	RXRF+	LNA Differential Inputs. Inputs are internally DC-coupled. Two external series capacitors and one shunt inductor match the inputs to 100Ω differential.
5	RXRF-	
6	B4	Receiver and Transmitter Gain-Control Logic Input Bit 4
7	VCCTXPAD	Supply Voltage for Power-Amplifier Driver. Bypass with a capacitor as close as possible to the pin.
8	B3	Receiver and Transmitter Gain-Control Logic Input Bit 3
9	B2	Receiver and Transmitter Gain-Control Logic Input Bit 2
10	TXRF+	Power-Amplifier Driver Differential Output. Outputs are internally DC-coupled. Two external series capacitors and one shunt inductor match the outputs to 100Ω differential.
11	TXRF-	
12	B1	Receiver and Transmitter Gain-Control Logic Input Bit 1
13	PABIAS	Transmit PA Bias DAC Output
14	VCCTXMX	Transmitter Upconverter Supply Voltage. Bypass with a capacitor as close as possible to the pin.
15	$\overline{CS}$	Chip-Select Logic Input of 4-Wire Serial Interface (See Figure 1)
16	SCLK	Serial-Clock Logic Input of 4-Wire Serial Interface (See Figure 1)
17	CLKOUT	Reference Clock Divided Output
18	VCCDIG	Digital Circuit Supply Voltage. Bypass with a capacitor as close as possible to the pin.
19	REFCLK	Reference Clock Input
20	VCCCP	PLL Charge-Pump Supply Voltage. Bypass with a capacitor as close as possible to the pin.
21	GNDCP	Charge-Pump Circuit Ground
22	CPOUT+	Differential Charge-Pump Output. Connect the frequency synthesizer's loop filter between CPOUT+ and CPOUT- (see the <i>Typical Operating Circuit</i> ).
23	CPOUT-	
24	GNDVCO	VCO Ground
25	VCOBYP	On-Chip VCO Regulator Output Bypass. Bypass with a 1μF capacitor to GND. Do not connect other circuitry to this point.
26	VCCVCO	VCO Supply Voltage. Bypass with a capacitor as close as possible to the pin.
27	VCCLO	LO Generation Supply Voltage. Bypass with a capacitor as close as possible to the pin.
28	EXTVCO-	External VCO Differential Input or Output. Input for slave configuration and output for master configuration. Leave unconnected for single configuration.
29	EXTVCO+	
30	DOUT	Data Logic Output of 4-Wire Serial Interface (See Figure 1)
31	DIN	Data Logic Input of 4-Wire Serial Interface (See Figure 1)
32	RSSI	RSSI or Temperature Sensor Multiplexed Analog Output
33	B7	Receiver Gain-Control Logic Input Bit 7
34	B6	Receiver and Transmitter Gain-Control Logic Input Bit 6
35	RXBBQ-	Receiver Baseband Q-Channel Differential Outputs. In Tx calibration mode, these pins are the LO leakage and sideband detector outputs.
36	RXBBQ+	
37	RXBBI-	Receiver Baseband I-Channel Differential Outputs. In Tx calibration mode, these pins are the LO leakage and sideband detector outputs.
38	RXBBI+	
39	VCCR XVGA	Receiver VGA Supply Voltage. Bypass with a capacitor as close as possible to the pin.

# 3.3GHz to 3.9GHz Wireless Broadband RF Transceiver

## Pin Description (continued)

PIN	NAME	FUNCTION
40	RXHP	Receiver Baseband AC-Coupling Highpass Corner Frequency Control Logic Input. Connect to ground if not being used.
41	VCCRFL	Receiver Baseband Filter Supply Voltage. Bypass with a capacitor as close as possible to the pin.
42	TXBBI-	Transmitter Baseband I-Channel Differential Inputs
43	TXBBI+	
44	TXBBQ+	Transmitter Baseband Q-Channel Differential Inputs
45	TXBBQ-	
46	VCCRXM	Receiver Downconverters Supply Voltage. Bypass with a capacitor as close as possible to the pin.
47	RXTX	Mode Control Logic Input. See Table 1 for operating modes.
48	ENABLE	Mode Control Logic Input. See Table 1 for operating modes.
—	EP	Exposed Paddle. Connect to the ground plane with multiple vias for proper operation and heat dissipation. Do not share with any other pin grounds and bypass capacitors' ground.

**Table 1. Operating Mode for MIMO Master and Single Configuration (Note 5)**

MODE	MODE CONTROL LOGIC INPUTS			CIRCUIT BLOCK STATES				
	SPI REG 16, D1:D0 (Note 6)	ENABLE PIN	RXTX PIN	Rx PATH	Tx PATH	PLL, VCO	CLOCK OUT	CALIBRATION SECTIONS ON
<b>SHUTDOWN</b>	xx	0	0	Off	Off	Off	Off	None
<b>STANDBY (Note 7)</b>	01	0	1	Off	Off	On	On	None
<b>CLOCK OUT</b>	00 (Note 11)	0	1	Off	Off	Off	On	None
<b>Rx</b>	01	1	1	On	Off (Note 8)	On	On	None
<b>Tx</b>	01	1	0	Off	On	On	On	None
<b>Tx CALIBRATION (Note 9)</b>	11	1	0	Off	On (except PA driver)	On	On	AM detector + RX I,Q buffers
<b>Rx CALIBRATION (Note 10)</b>	11	1	1	On (except LNA)	On (except PA driver)	On	On	Loopback

**Note 5:** Set SPI Reg 24 D1:D0 = "00" for single-transceiver mode of operation. Set SPI Reg 16 D4:D3 = "11," Reg 24 D8 = "1," Reg 24 D1:D0 = "01" for MIMO master configuration.

**Note 6:** Unused states of SPI Reg 16, D1:D0 above are not tested, and therefore, should not be used.

**Note 7:** Parts of transceiver may be selectively enabled.

**Note 8:** PA bias DAC may be kept active in these non-transmit mode(s) by SPI programming.

**Note 9:** Set SPI Reg 5 D5 = "1" to mux AM detector output to RXBB pins.

**Note 10:** Set SPI Reg 26 D3 = "1."

**Note 11:** CLKOUT signal is active independent of the states of SPI Reg 16, D1:D0, and is only dependent on the states of ENABLE and RXTX pins. However, to ensure that the rest of the chip is off when the CLKOUT is active in the clock-out mode, set SPI Reg 16, D1:D0 to "00" as shown above.

# 3.3GHz to 3.9GHz Wireless Broadband RF Transceiver

**Table 2.** Operating Mode for MIMO Slave Configuration (Note 12)

MODE	MODE CONTROL LOGIC INPUTS			CIRCUIT BLOCK STATES				
	SPI REG 16, D1:D0 (Note 4)	ENABLE PIN	RXTX PIN	Rx PATH	Tx PATH	PLL, VCO	CLOCK OUT	CALIBRATION SECTIONS ON
<b>SHUTDOWN</b>	xx	0	0	Off	Off	Off	Off	None
<b>STANDBY (Note 7)</b>	01	0	1	Off	Off	Off	On	None
<b>CLOCK OUT</b>	00 (Note 11)	0	1	Off	Off	Off	On	None
<b>Rx</b>	01	1	1	On	Off (Note 8)	Off	On	None
<b>Tx</b>	01	1	0	Off	On	Off	On	None
<b>Tx CALIBRATION (Note 9)</b>	11	1	0	Off	On (except PA driver)	Off	On	AM detector + RX I,Q buffers
<b>Rx CALIBRATION (Note 10)</b>	11	1	1	On (except LNA)	On (except PA driver)	Off	On	Loop-back

**Note 12:** Set SPI Reg 16 D4:3 = "00," Reg 24 D8 = "0," Reg 24 D1:0 = "10" to select the MIMO slave configuration.

## Detailed Description

### Configurations

The MAX2838 can be configured in a) single mode, for non-MIMO or SISO applications, b) MIMO master mode, and c) MIMO slave mode. Options b) and c) are for MIMO applications where a coherent LO is required for all transmitters and all receivers.

### Modes of Operation

The modes of operation for the MAX2838 are clock-out, shutdown, standby, Tx, Rx, Tx calibration, and Rx calibration. See Table 1 for a summary of the modes of operation. The logic input pins—RXTX (pin 47) and ENABLE (pin 48)—control the various modes.

#### Shutdown Mode (Complete IC Power-Down)

All circuit blocks are powered down, except the 4-wire serial bus and its internal programmable registers. Current drain is the minimum possible with the supply voltages applied. If the digital supply voltage is applied at the VCCDIG pin, the registers can be loaded.

#### Standby Mode

PLL, VCO, and LO generation blocks are ON, so that Tx or Rx modes can be quickly enabled from this mode. These and other blocks may be selectively enabled in this mode.

#### Rx Mode

All Rx circuit blocks are powered on and active. Antenna signal is applied; RF is downconverted, filtered, and buffered at Rx BB I & Q outputs.

#### Tx Mode

All Tx circuit blocks are powered on. The external PA is powered on after a programmable delay.

#### Clock-Out Only

Only the clock-out signal is active on the CLKOUT pin. The clock output divider is also functional. The rest of the transceiver is powered down.

#### Rx Calibration

Part of the Rx and Tx circuit blocks except the LNA and PA driver are powered on and active. The transmitter IQ input signal is upconverted to RF and at the output of the Tx gain control (VGA). It is fed to the receiver at the input of the downconverter. Either or both of the two receiver channels can be connected to the transmitter and powered on. The I/Q lowpass filters are not present in the transmitter signal path (they are bypassed).

#### Tx Calibration

All Tx circuit blocks except the PA driver and external PA are powered on and active. The AM detector and receiver I/Q channel buffers are also on, along with multiplexers in receiver side to route this AM detector's signal to each I and Q differential lines.

# 3.3GHz to 3.9GHz Wireless Broadband RF Transceiver

## Programmable Registers and 4-Wire SPI-Interface

## Chip Information

PROCESS: BiCMOS

The MAX2838 includes 32 programmable 16-bit registers. The most significant bit (MSB) is the read/write selection bit. The next 5 bits are register addresses. The 10 least significant bits (LSBs) are register data. Register data is loaded through the 4-wire SPI/MICROWIRE™-compatible serial interface. Data at the DIN pin is shifted in MSB first and is framed by CS. When CS is low, the clock is active, and input data is shifted at the rising edge of the clock. During the read mode, register data selected by address bits is shifted out to the DOUT pin at the falling edges of the clock. At CS rising edge, the 10-bit data bits are latched into the register selected by address bits. See [Figure 1](#).

MICROWIRE is a trademark of National Semiconductor Corp.

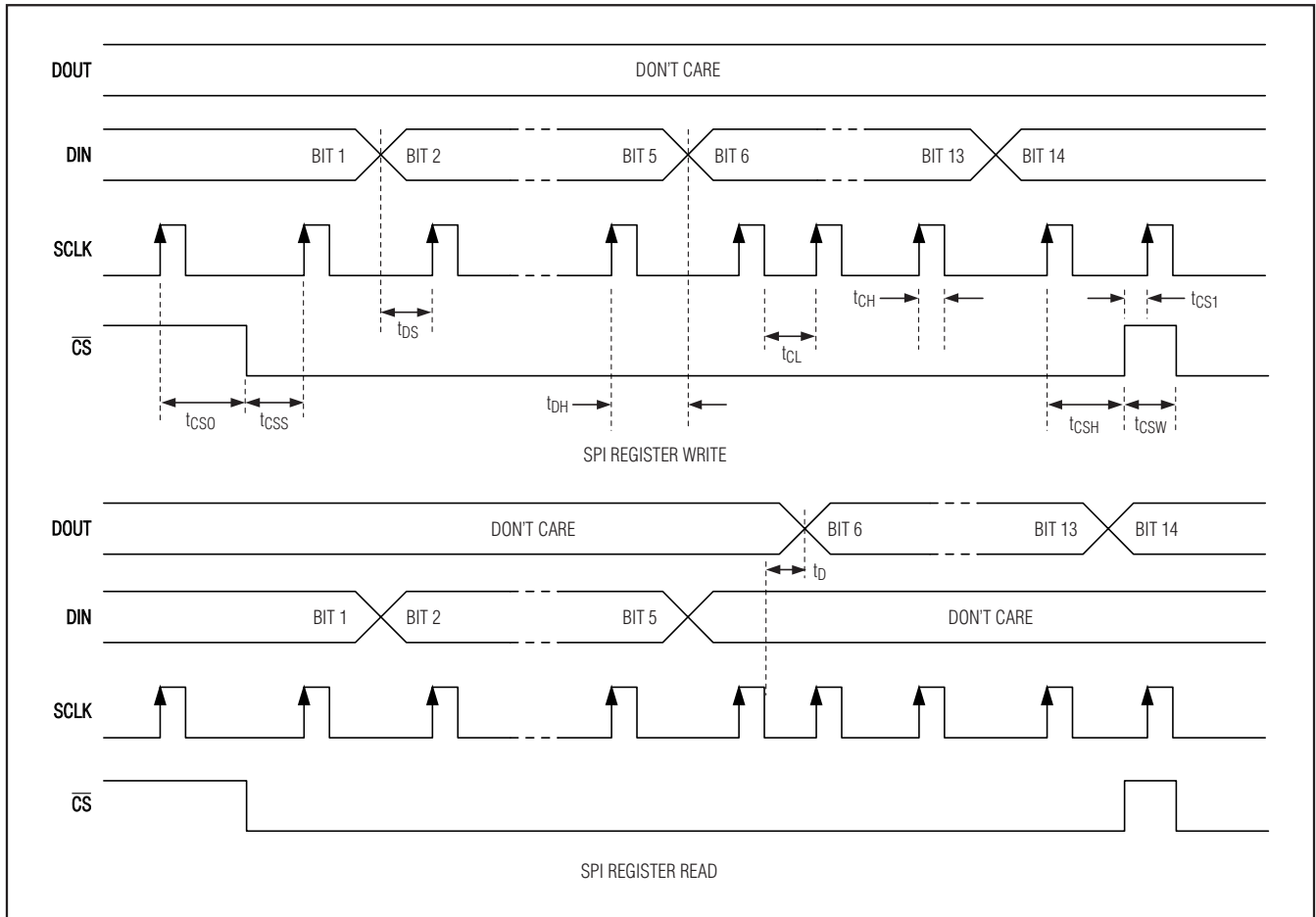

Figure 1. 4-Wire SPI Serial-Interface Timing Diagram

# 3.3GHz to 3.9GHz Wireless Broadband RF Transceiver

## Package Information

For the latest package outline information and land patterns, go to [www.maxim-ic.com/packages](http://www.maxim-ic.com/packages).

PACKAGE TYPE	PACKAGE CODE	DOCUMENT NO.
48 TQFN-EP	T4866+2	<a href="#">21-0141</a>

**MAX2838**

# 3.3GHz to 3.9GHz Wireless Broadband RF Transceiver

## Revision History

REVISION NUMBER	REVISION DATE	DESCRIPTION	PAGES CHANGED
0	10/07	Initial release	—
1	8/08	Removed CLKOUT frequency divide-by-1 ratio in <i>AC Electrical Characteristics—Frequency Synthesis</i> table	7

Maxim cannot assume responsibility for use of any circuitry other than circuitry entirely embodied in a Maxim product. No circuit patent licenses are implied. Maxim reserves the right to change the circuitry and specifications without notice at any time.

22 \_\_\_\_\_ **Maxim Integrated Products, 120 San Gabriel Drive, Sunnyvale, CA 94086 408-737-7600**