

## MAX3523 Evaluation Kit

Evaluates: MAX3523

### General Description

The MAX3523 evaluation kit (EV kit) provides the hardware and software graphical user interface (GUI) necessary to evaluate the MAX3523 low-power DOCSIS 3.1 programmable-gain amplifier. The EV kit includes a MAX3523 installed EV board, as well as a micro-USB cable to communicate with a PC.

### Features

- Easy Evaluation of the MAX3523
- USB-3-Wire Serial Programmable Interface (SPI)
- PC, Laptop, or Tablet with Windows® 7 and 10 Compatible Software
- Proven PCB Layout
- Fully Assembled and Tested

### MAX3523 EV Kit Files

FILE	DESCRIPTION
MAX3523 Programmable Gain Amplifier EV Kit Software	Application program

### Quick Start

#### Required Equipment

- One power supply capable of supplying at least 1000 mA at +5V.
- One RF signal generator capable of delivering at least -10dBm of output power up to 204 MHz frequency.
- One RF spectrum analyzer capable of covering the operating frequency range of the device.
- One Windows PC with USB jack.
- 50Ω SMA cables, quantity = 2
- (Optional) One network analyzer to measure return loss.
- (Optional) One ammeter to measure supply current.
- MAX3523 EV kit GUI installation package: SetupPGA EvKit\_5.X.XXXXXXXXXX.0\_Win7.msi.

[Ordering Information](#) appears at end of data sheet.

Windows is a registered trademark and registered service mark of Microsoft Corporation.

**Procedure**

**Software / Driver preparation**

- 1) EV Kit GUI Installation: double-click SetupPGA\_EvKit\_5.X.XXXXXX.0\_Win7.msi. After successful installation, DeviceStudio5.exe should be created at desktop.
- 2) USB driver installation: connect EV kit micro-USB port to Windows PC USB port. When first connecting the EV kit, Windows will automatically search/install the

USB driver. It could take few minutes. In the rare case that Windows fails to find the driver, please contact Maxim support for assistant.

- 3) Check USB driver installation status: if Windows successfully installs the USB driver, a new device called “Teensy USB Serial” should appear in the Windows Device Manager ([Figure 1](#)).

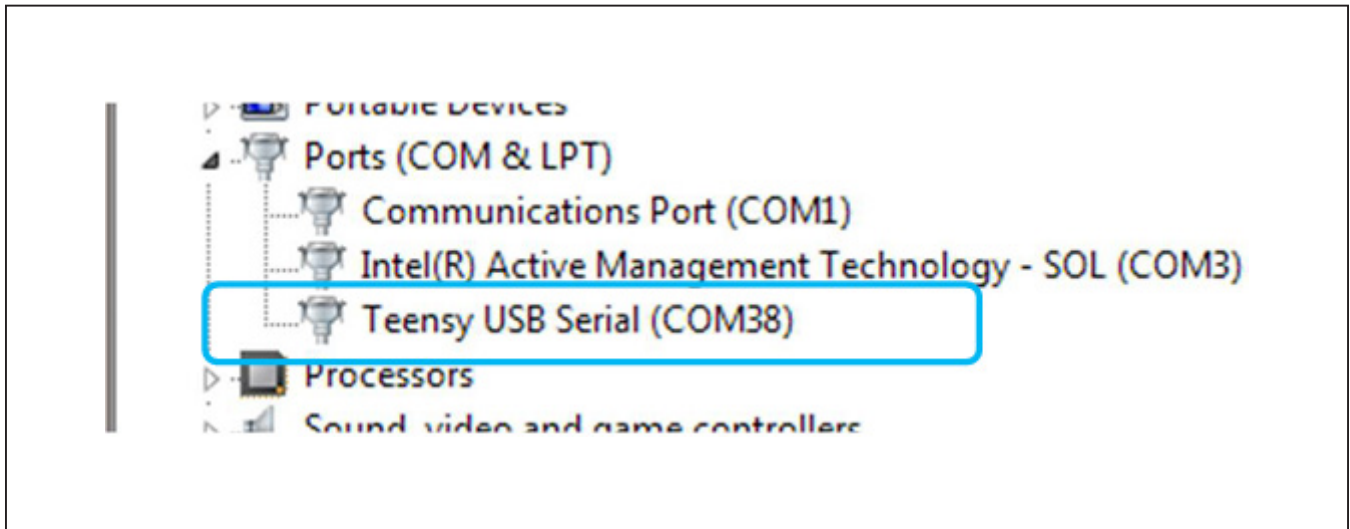

Figure 1. USB Driver Installation Status

- 4) Check GUI/EV Kit communication status: Launch DeviceStudio5.exe, and DeviceStudio will automatically search for the connected MAXIM EV kit. After few seconds, MAX3523 should appear in device list (Figure 2).

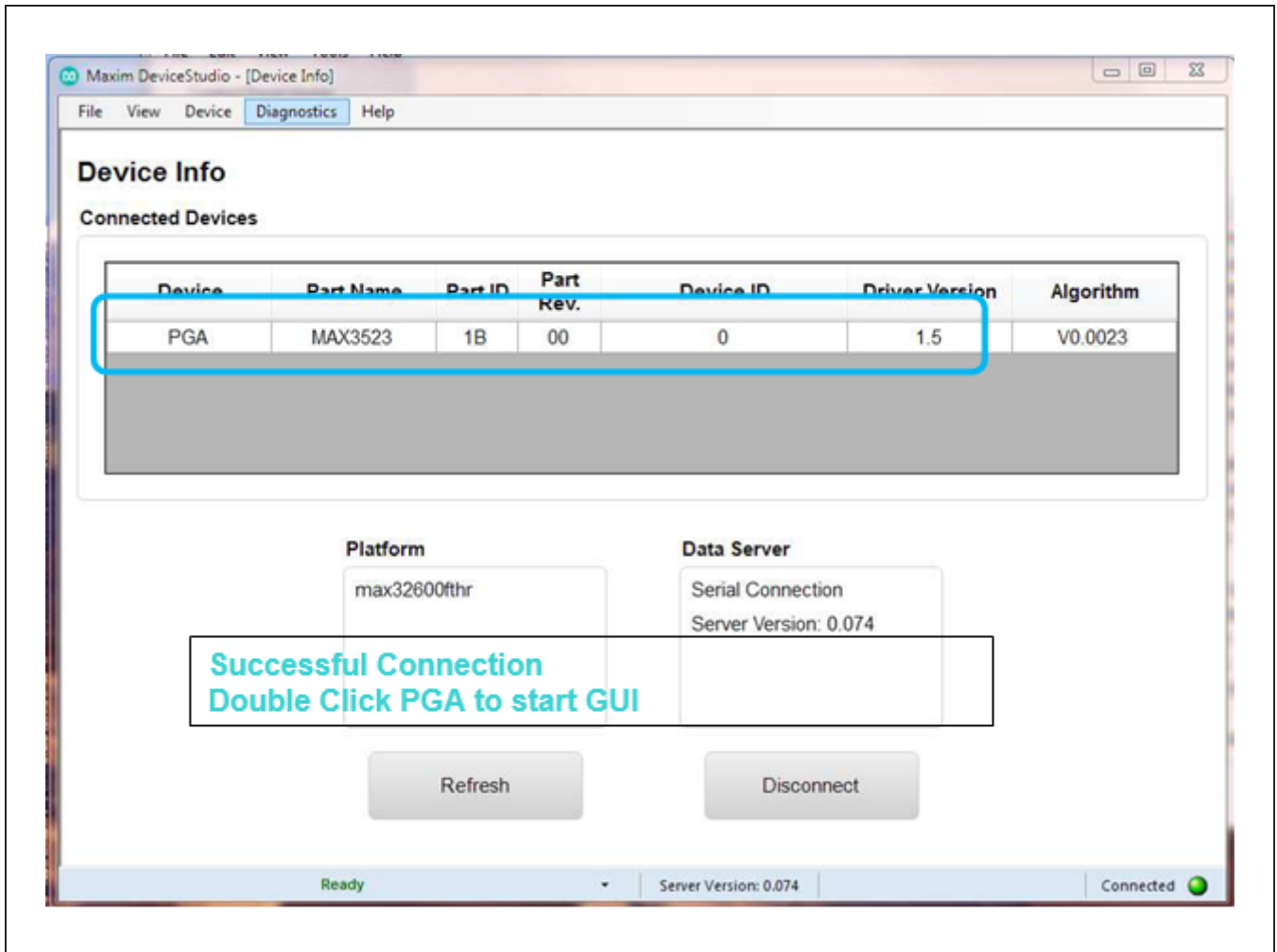

Figure 2. MX3523 EV Kit GUI, Successful Connection

- 5) In rare case DeviceStudio fails to find MAX3523 EV Kit, push the reset button (see [Figure 4](#)), hold for 2 seconds, and release. Then click the Scan button at DeviceStudio (see [Figure 3](#)).

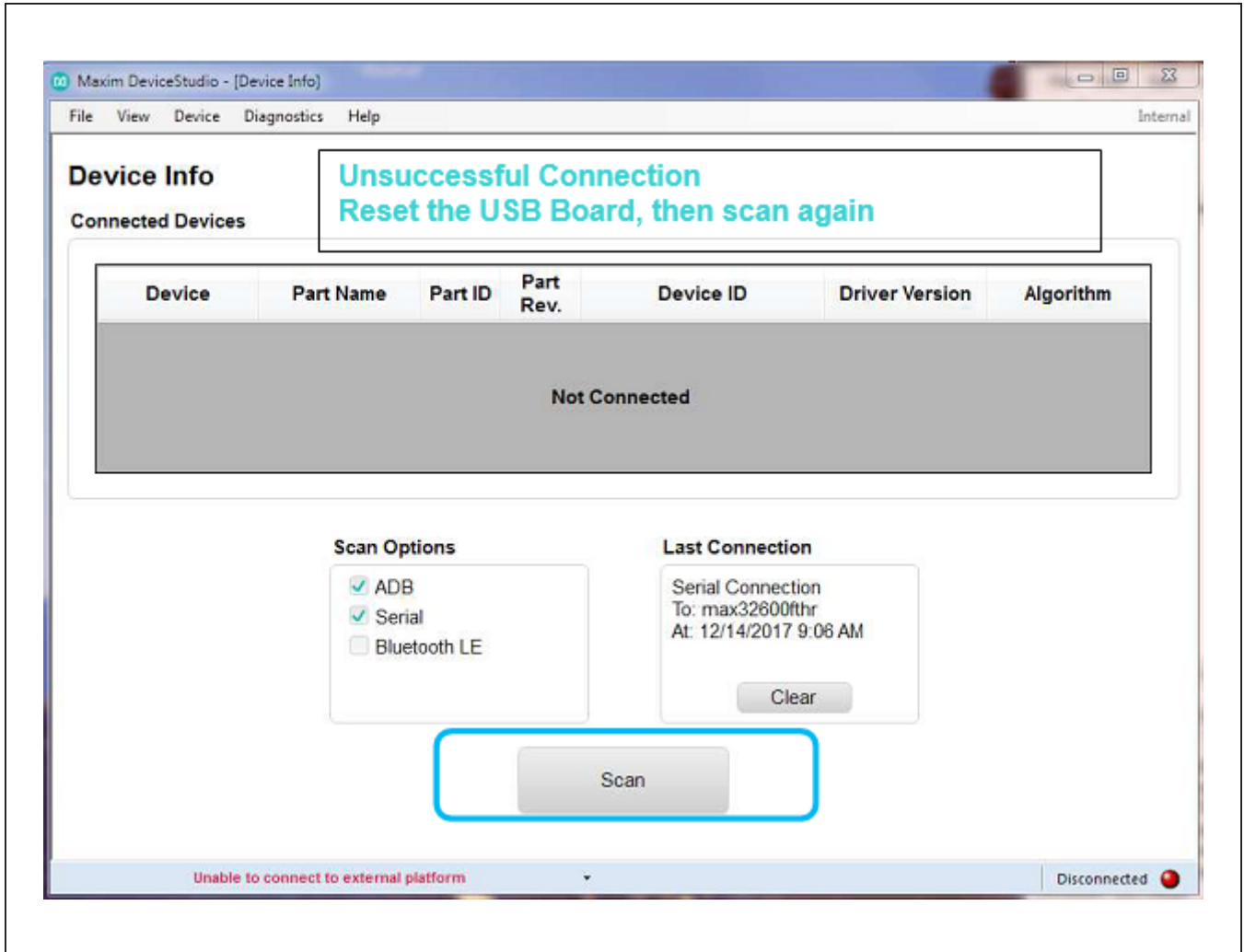

Figure 3. MX3523 EV Kit GUI, Unsuccessful Connection

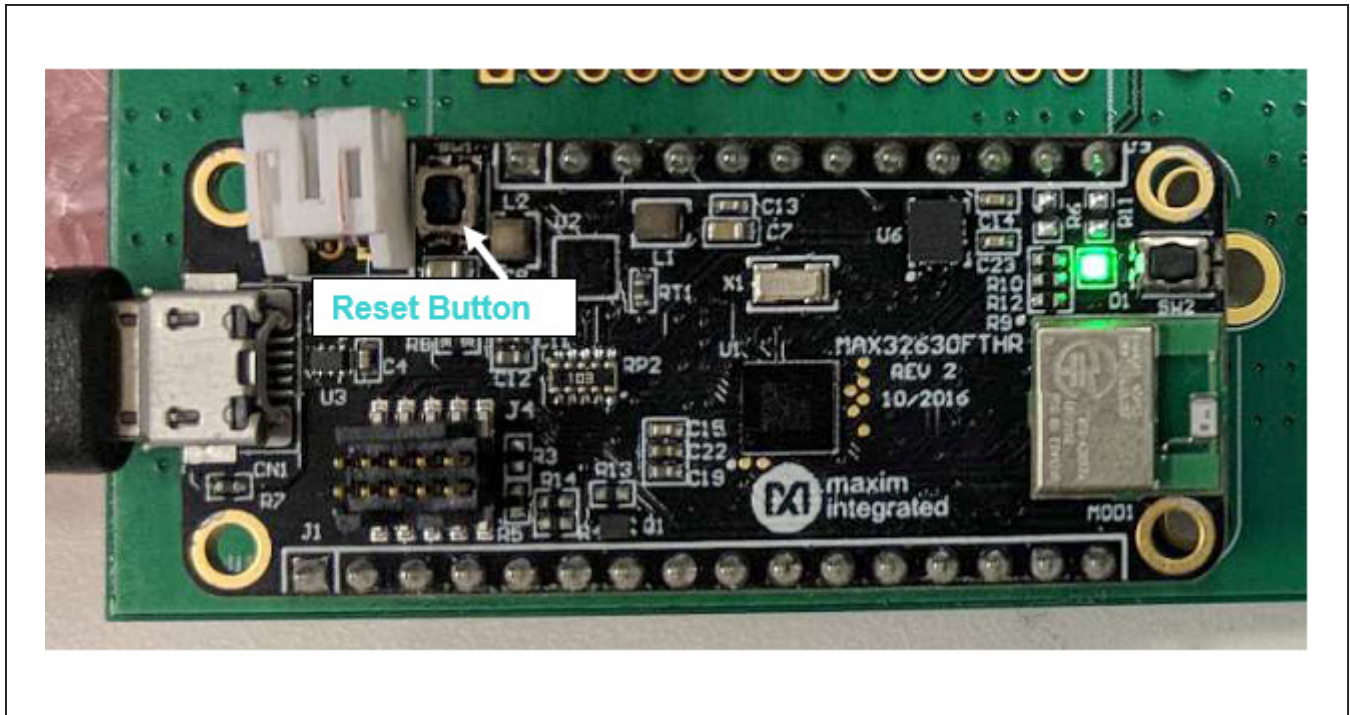

Figure 4. MAX3523 EV Kit USB Communication

#### Setup Procedure:

- 1) With its output disabled, set the DC power supply to +5V. If available, set the power supply's current limit to 1000mA. Connect the power supply to the +5V (through an ammeter if desired) and GND terminals on the EV kit, as shown in [Figure 5](#).
- 2) With its output disabled, set the RF signal generator to 85MHz and a power level of -32.5dBm. Connect the signal generator to the SMA J1 RF IN on the evaluation board, as shown in [Figure 5](#).
- 3) Connect the SMA labeled J2 RFOUT on the evaluation board to a spectrum analyzer and set spectrum analyzer center frequency to 85MHz.
- 4) Connect the EV kit's micro-USB port to the Windows PC USB port.
- 5) Turn on the +5V power supply.
- 6) If the EV kit GUI is currently running, close it and relaunch (DeviceStudio5.exe), after few seconds, the MAX3523 should appear in device list.
- 7) Double-click PGA section at DeviceStudio to launch MAX3523 GUI. ([Figure 2](#))
- 8) MAX3523 GUI should be launched, as shown [Figure 6](#). Click "set Default"
- 9) Toggle the TX\_ENABLE switch at MAX3523 GUI. The MX3523 will be powered-up in default mode (GainCode = 63, PC = 3).
- 10) The supply current from the +5V supply should read approximately 700 mA. Be sure to adjust the power supply to account for any voltage drop across the power supply cable.
- 11) Enable the RF signal generator's output.
- 12) Check the output level on the spectrum analyzer. With -32.5dbm at input, the expected output power level is about 0 dBm, which implies the EV kit board gain is 32.5dB, correct it by adding 4.5dB (board loss, detailed explanation is below), the MAX3523 voltage gain is 37 (32.5 + 4.5)dB.

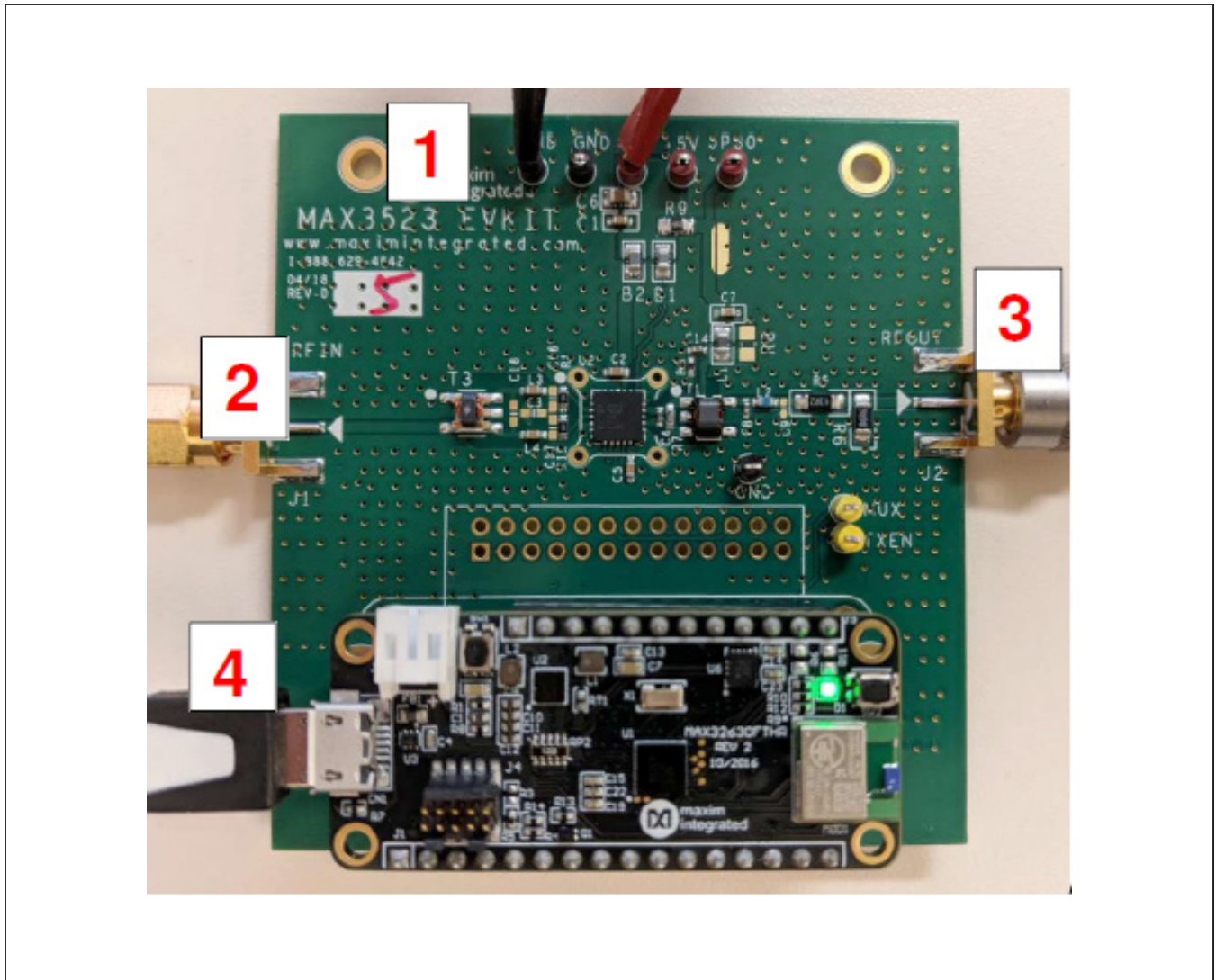

Figure 5. MAX3523 EV Kit Connection



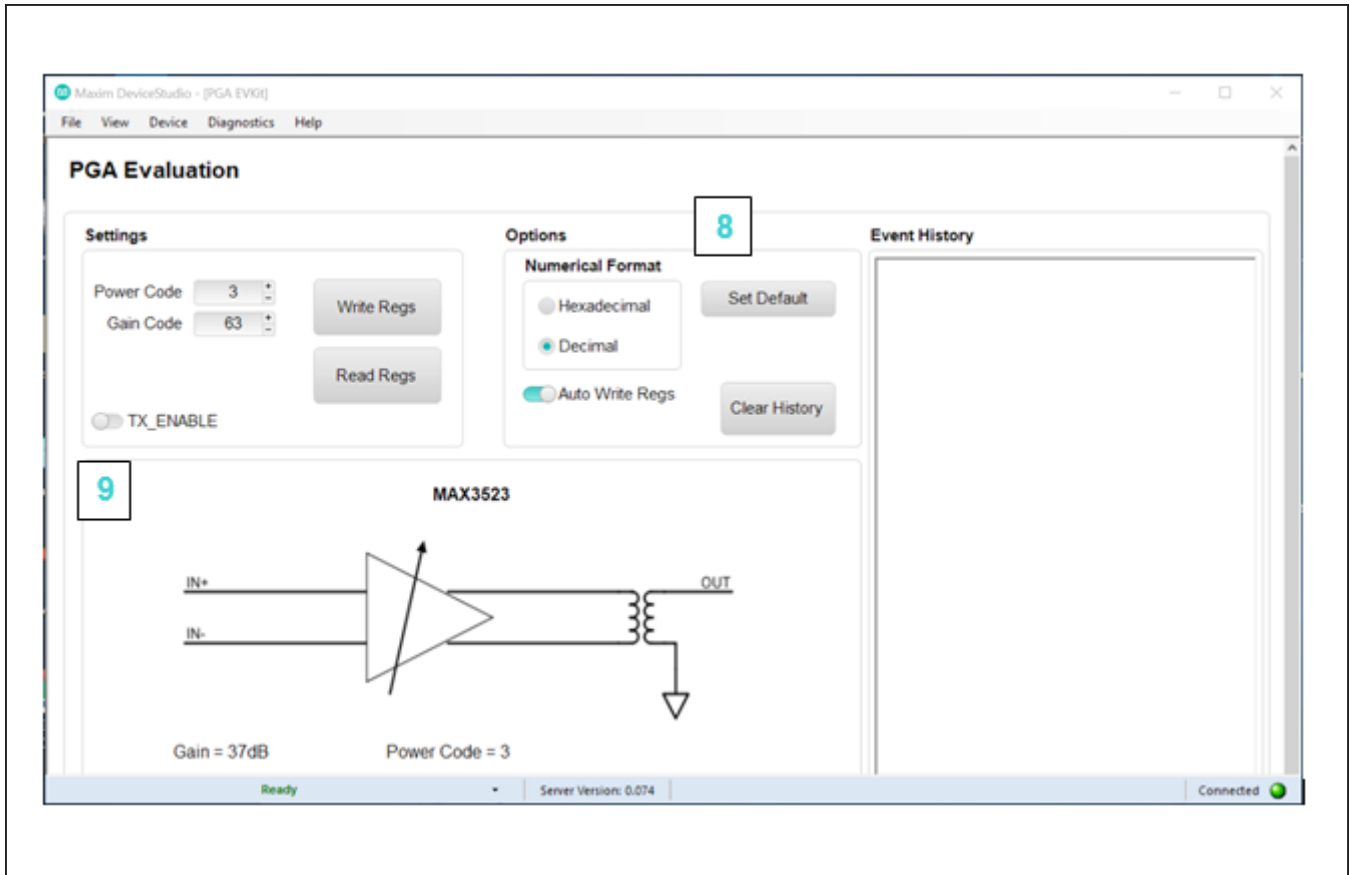

Figure 6. MX3523 EV Kit GUI

**Gain Correction factor explanation**

Input balun T3 transforms the 50Ω test equipment impedance to 100Ω MAX3523 input impedance, with a voltage gain of 3dB.

Output minimum loss pad (R5/R6) transforms the 75Ω output impedance to 50Ω test equipment impedance, with a voltage “Gain” of -7.5dB.

$$\begin{aligned}
 \text{MAX3523 Voltage Gain} &= V_{\text{OUT}} @ \text{ last matching component (C9)} - V_{\text{IN}} @ \text{ MAX3523 In}\pm \\
 &= (\text{SMAOUT- MLP “gain”}) - (\text{SMAIN} + \text{T3 Gain}) \\
 &= (\text{SMAOUT-SMAIN}) - (-7.5) - 3 \\
 &= \text{EVK Gain} + 4.5
 \end{aligned}$$

### Component Suppliers

SUPPLIER	WEBSITE
MURATA	<a href="https://www.murata.com/">https://www.murata.com/</a>
LAIRD	<a href="https://www.lairdtech.com/">https://www.lairdtech.com/</a>

**Note:** Indicate that you are using the MAX3523 when contacting these component suppliers.

### Ordering Information

PART	TYPE
MAX3523EVKIT#	EV Kit

#Denotes RoHS compliant.



## MAX3523 EV Kit Bill of Materials

COMPONENT	DESCRIPTION	VALUE / PART NUMBER	SUPPLIER
	Components in TYP operation Circuit		
B1, B2	FERRITE-BEAD, 600	BLM21AG601SN1D	MURATA
C2, C5, C7	CAPACITOR; SMT (0603)	0.01 uF	
C4	CAPACITOR; SMT (0402)	2.7 pF	
C8	CAPACITOR; SMT (0402)	3.9 pF	
C14	CAPACITOR; SMT (0402)	1000pF	
L1	FERRITE-BEAD, 1K	MI0805J102R-10	LAIRD
L2	INDUCTOR; SMT (0402)	5.1 nH	
R1, R12	RESISTOR; SMT (0603)	100 Ohm	
R3	RESISTOR; (0402) 1%	6.2 Ohm	
R7	RESISTOR; (0603)	95.3 Ohm	
U2	DOCSIS 3.1 PGA	MAX3523	MAXIM
T1	TRANSFORMER, Impedance ratio: 50:75	617PT-2290	MURATA
	Components used only in this EV kit		
R8	Place holder	OPEN	
C3	Place holder	OPEN	
C9	Place holder	OPEN	
C1	CAPACITOR; SMT (0603)	0.01UF	
C6	CAPACITOR; SMT (0805)	10UF	
C16, C17	Place holder	OPEN	
C18	Place holder	OPEN	
J1, J2	SMA	SMA	
JP3, TP3, JP30	Test Point	Red Test Point	
JP4, TP4, TP5	Test Point	Black Test Point	
L3, L4	Place holder, AC coupling Cap	0.01uF	
R2, R4, R13	RESISTOR; 0402	10K	
R5	RESISTOR; 1206 75-50 MLP	43.2	
R6	RESISTOR; 1206 75-50 MLP	86.6	
R9	RESISTOR; 0603	0	
R10	RESISTOR; 0402;	20K	
R11, R14	RESISTOR; 0402;	100K	
T3	TRANSFORMER, Impedance ratio: 50:100	MABA-009250-CT0068	
TP1, TP2, TP8	Test Point	Yellow Test Point	
U1	USB-SPI communication module	MAX32630FTHR	MAXIM



MAX3523 EV Kit PCB Layout Diagrams

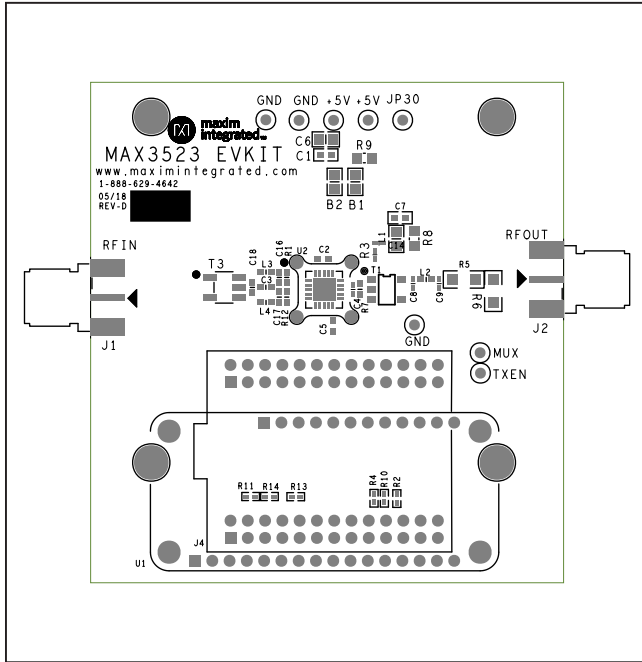

MAX3523 EV Kit—Top Silkscreen

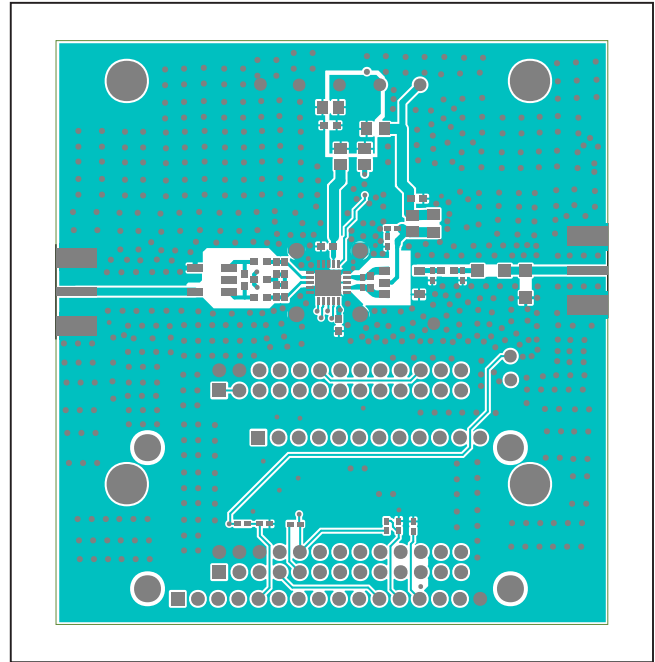

MAX3523 EV Kit—Top

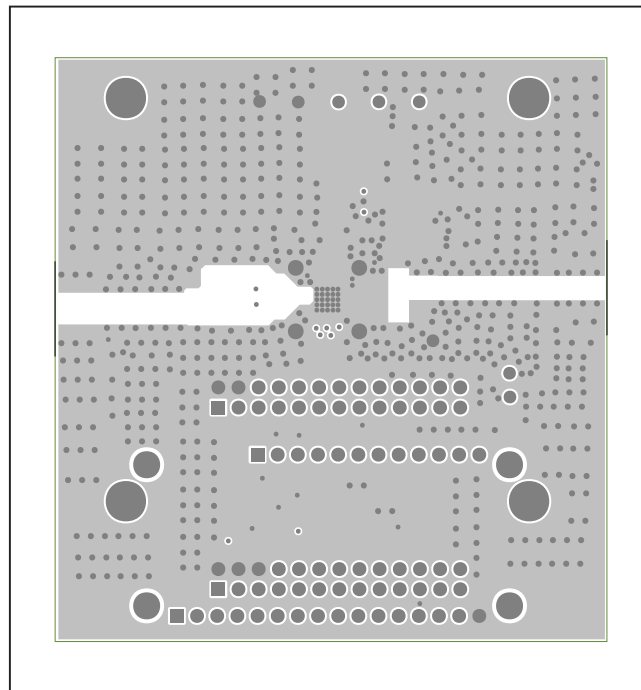

MAX3523 EV Kit—Internal 2

MAX3523 EV Kit PCB Layout Diagrams (continued)

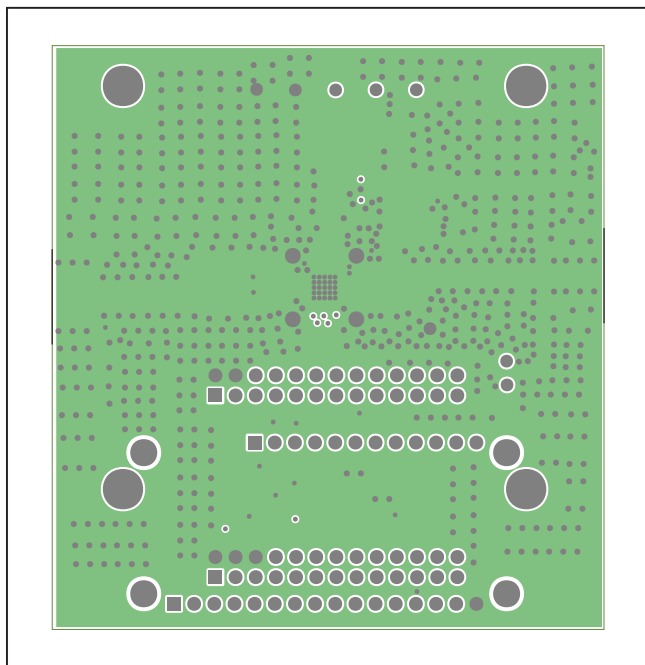

MAX3523 EV Kit—Internal 3

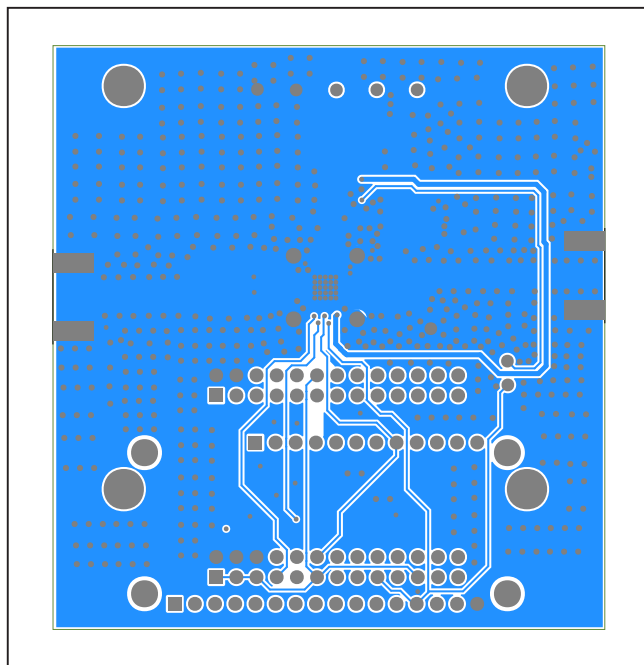

MAX3523 EV Kit—Bottom

## Revision History

REVISION NUMBER	REVISION DATE	DESCRIPTION	PAGES CHANGED
0	10/18	Initial release	—

For pricing, delivery, and ordering information, please visit Maxim Integrated's online storefront at <https://www.maximintegrated.com/en/storefront/storefront.html>.

*Maxim Integrated cannot assume responsibility for use of any circuitry other than circuitry entirely embodied in a Maxim Integrated product. No circuit patent licenses are implied. Maxim Integrated reserves the right to change the circuitry and specifications without notice at any time. The parametric values (min and max limits) shown in the Electrical Characteristics table are guaranteed. Other parametric values quoted in this data sheet are provided for guidance.*