

# MAXIM

## MAX3983 Evaluation Kit

### General Description

The MAX3983 evaluation kit (EV Kit) is an assembled demonstration board that provides electrical evaluation of the MAX3983 Quad Copper Cable Signal Conditioner. The EV Kit also includes a calibration strip for accurate measurements.

### Component List

DESIGNATION	QTY	DESCRIPTION
C1-C32, C35-C44	42	0.01 $\mu$ F $\pm$ 5% ceramic capacitors (0402)
C33	1	33 $\mu$ F tantalum capacitor
C34, C45, C46, C49	4	0.1 $\mu$ F $\pm$ 5% ceramic capacitors (0402)
C47, C48, C50, C51	4	Not Installed
J1-J18	18	SMA connectors, edge mount
JP1, JP2, JP8, JP9, JP12	5	2-pin headers, 0.1in centers
JP3	1	3-pin header, 0.1in centers
JP5	1	3-pin + 1-pin header, 0.1in centers
JP10, JP11	2	Not Installed
L1	1	4.7 $\mu$ H Inductor Coilcraft DS1608C-472
P1	1	4x IB Connector FCI 58369-111120 or 58369-112110
R1-R8	8	4.7k $\Omega$ $\pm$ 5% resistors (0402)
R10 - R18	9	Not Installed
TP1-TP11	11	Test points Digi-Key 5000K-ND
U1	1	MAX3983UGK 68-QFN*
U2	1	OR Gate Fairchild NC7S32P5X SC70
None		MAX3983 evaluation circuit board, rev A
None		MAX3983 data sheet

\*Note: U1 has an exposed pad which requires it to be solder attached to the circuit board to insure proper functionality of the part.

### Features

- ◆ Fully Assembled and Tested
- ◆ Easy Selection of Operating Modes
- ◆ Equipped with a 4X InfiniBand Cable Connector

### Ordering Information

PART	TEMP. RANGE	IC PACKAGE
MAX3983EVKIT	0°C to +85°C	68 QFN

### Component Suppliers

SUPPLIER	PHONE	FAX
AVX	843-448-9411	843-448-1943
Coilcraft	847-639-6400	847-639-1469
Digi-Key	218-681-6674	218-681-3380
Murata	770-436-1300	770-436-3030

**Note:** Please indicate that you are using the MAX3983 when ordering from these suppliers.





### Quick Start

- 1) Connect a +3.3V supply to the 3.3V terminal and ground to the GND terminal.
- 2) Disable system loopback by installing the LOOPBACK shunt at jumper JP9.
- 3) Remove shunts at jumpers JP3 and JP5 to enable TX and RX.
- 4) Install shunt at jumper JP2 to V<sub>CC</sub> to provide +3.3V to the SD pullup resistors.
- 5) Apply 2.5Gbps to 3.2Gbps data to TX\_IN[1:4] (J9 - J16).
- 6) Apply 2.5Gbps to 3.2Gbps data to RX\_IN[1:4] through a 1m to 5m InfiniBand 4X cable assembly.
- 7) Connect data outputs RX\_OUT[1:4] to a 50 ohm-terminated oscilloscope to monitor RX\_IN[1:4] data, and/or connect TX\_OUT[1:4] to a 50 ohm-terminated oscilloscope through a 1m to 15m InfiniBand 4X cable assembly to monitor TX\_IN[1:4] data.
- 8) Adjust TX pre-emphasis with jumpers JP1 and JP12, and adjust RX pre-emphasis with JP8 (see *Jumper Descriptions*).

# MAX3983 Evaluation Kit

## Jumper Descriptions

Evaluates: MAX3983

NAME	TYPE	SHUNT POSITION	DESCRIPTION
TX_PE1 (JP1)	2-pin header	OPEN	Enables most-significant bit of TX pre-emphasis control
		SHUNT (GND)	Disables most-significant bit of TX pre-emphasis control
TX_PE0 (JP12)	2-pin header	OPEN	Enables least-significant bit of TX pre-emphasis control
		SHUNT (GND)	Disables least-significant bit of TX pre-emphasis control
RX_PE (JP8)	2-pin header	OPEN	Sets RX pre-emphasis to 6dB
		SHUNT (GND)	Sets RX pre-emphasis to 3dB
LOOPBACK (JP9)	2-pin header	OPEN	Enables loopback from TX_IN[1:4] to RX_OUT[1:4]
		SHUNT (GND)	Disables loopback
PULLUP (JP2)	2-pin header	OPEN	Allows external voltage (3.0V to 5.5V) applied at V <sub>PULLUP</sub> pin as SD resistor pullup voltage
		SHUNT (V <sub>CC</sub> )	Sets V <sub>CC</sub> as the SD resistor pullup voltage
TX_ENABLE (JP3)	3-pin header	OPEN	Enables the TX section of the MAX3983
		TX_AUTO_EN	Enables auto-detection in the TX section, when EV board is set up in the Auto-Detect configuration. See <i>Auto-Detect Configuration in Detailed Description</i> .
		TX_DISABLE	Disables the TX section of the MAX3983
RX_ENABLE (JP5)	3-pin + 1-pin header	OPEN 	Enables the RX section of the MAX3983
		RX_AUTO_EN 	Enables auto-detection in the RX section when EV board is set up in the Auto-Detect configuration. See <i>Auto-Detect Configuration in Detailed Description</i> .
		RX_DISABLE 	Disables the RX section of the MAX3983
			Sets RX_ENABLE high whenever LOOPBACK or all of RX_SD[1:4] are high when EV board is set up in the Auto-Detect configuration. See <i>Auto-Detect Configuration in Detailed Description</i> .

## Detailed Description

### Auto-Detect Configuration

The MAX3983 Evaluation Kit is shipped with each signal detect (SD) separated. In order for the MAX3983 to automatically detect an incoming signal and enable the corresponding output, these SD outputs need to be connected together.

To configure the board for auto-detection on the RX side, solder four 0Ω 0402 resistors in R14 - R17 and remove R6, R7, and R8. Jumper JP5 then enables RX auto-detect (see *Jumper Descriptions*).

To configure the board for auto-detection on the TX side, solder four 0Ω 0402 resistors in R10 - R13 and remove R2, R3, and R4. Jumper JP3 then enables TX auto-detect (see *Jumper Descriptions*).

### Embedded Stripline

The MAX3983 Evaluation Kit has approximately 2.5 inches of 4mil-wide FR4 stripline on the cable side inputs and outputs. This provides 2dB of loss at 3GHz, which slows the output transition times of the MAX3983 to approximately 60ps.

If slower transition times are desired, the MAX3983 Evaluation Kit provides a connection for 0402 capacitors across the TX outputs. To achieve about 100ps (20%-80%) edges, solder 1.5pF capacitors for C47, C48, C50, and C51.

# MAX3983 Evaluation Kit

Evaluates: MAX3983

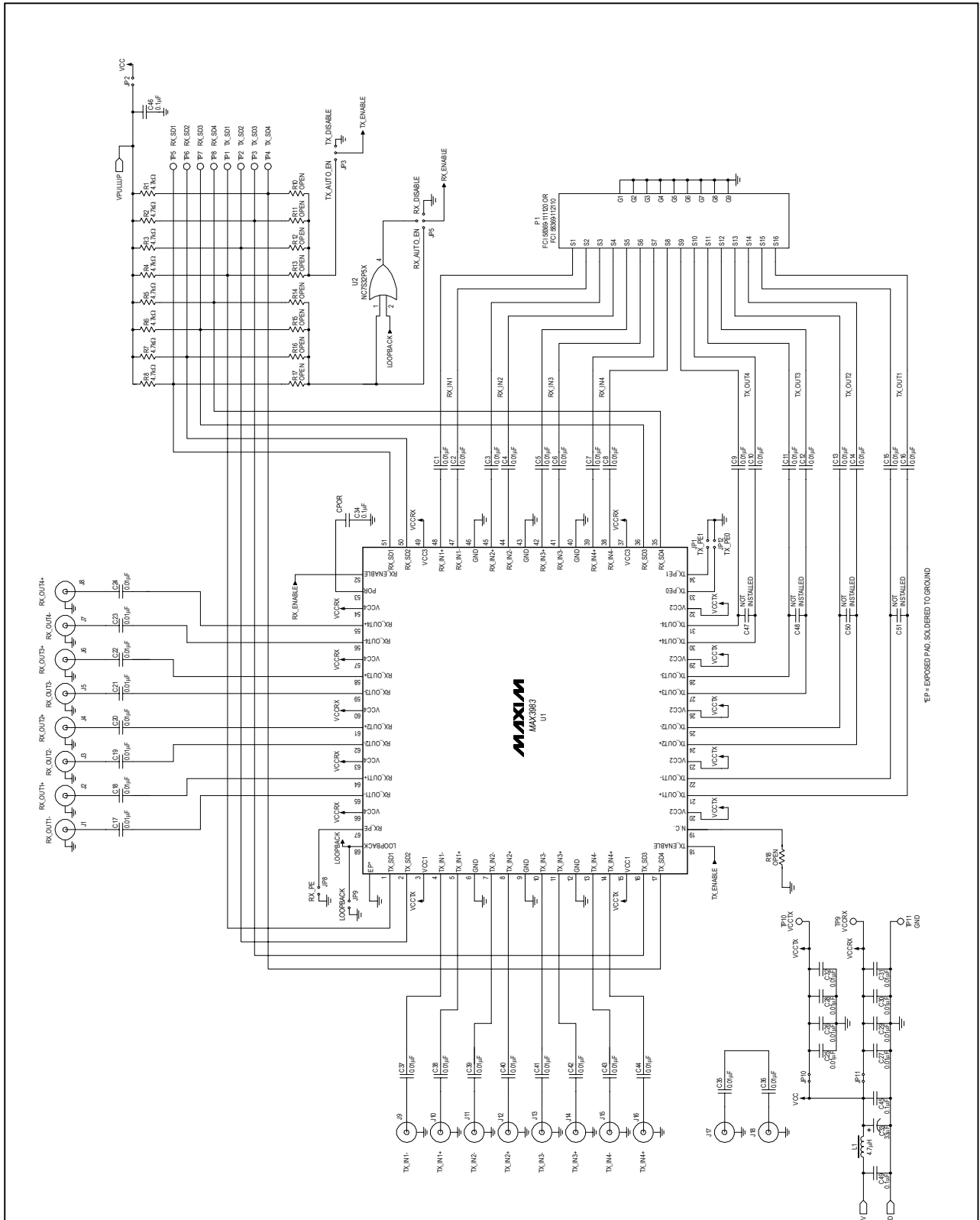

Figure 1. MAX3983 EV Kit Schematic

# MAX3983 Evaluation Kit

Evaluates: MAX3983

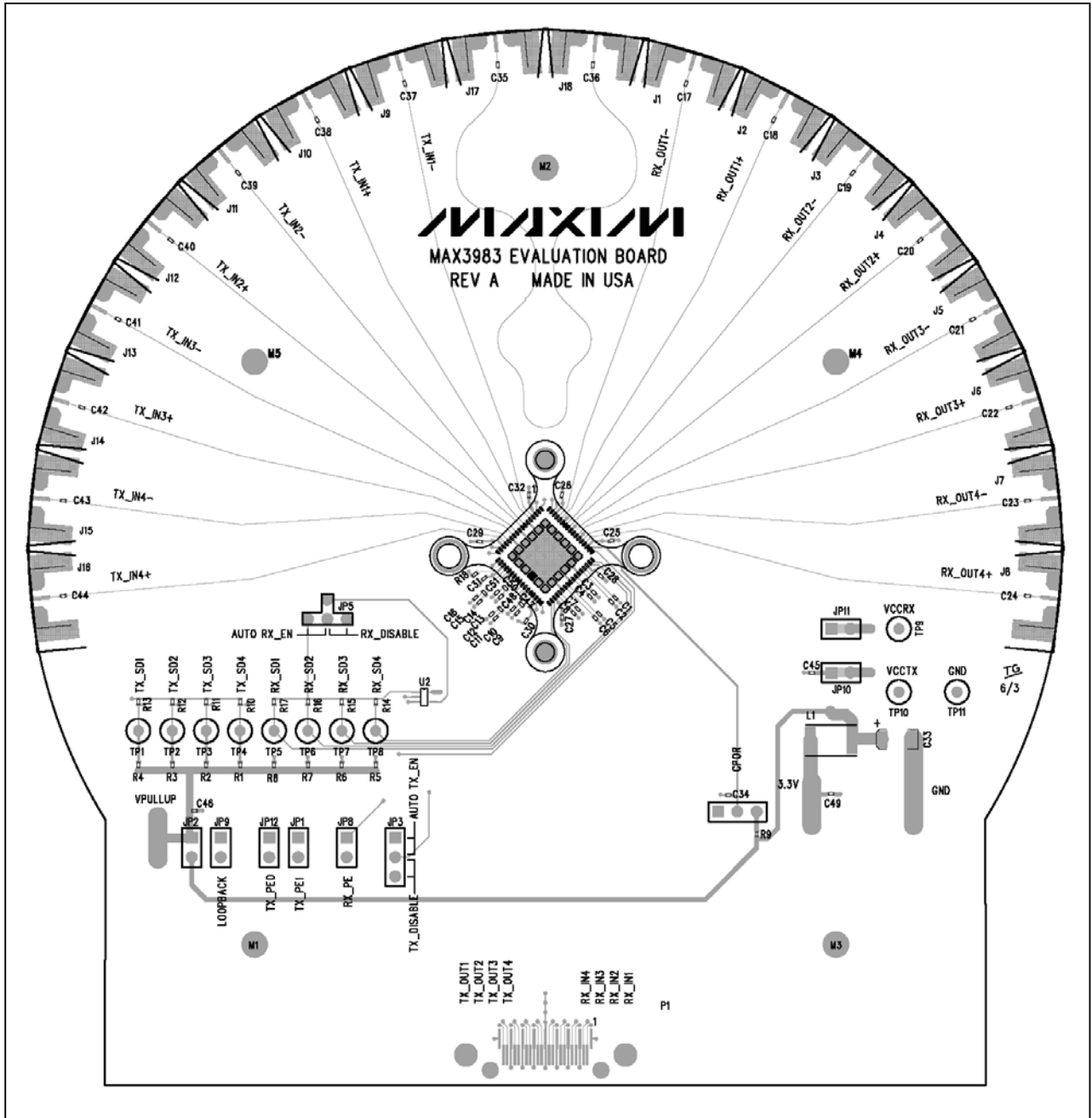

Figure 2. MAX3983 EV Kit Component Placement Guide – Component Side

# MAX3983 Evaluation Kit

Evaluates: MAX3983

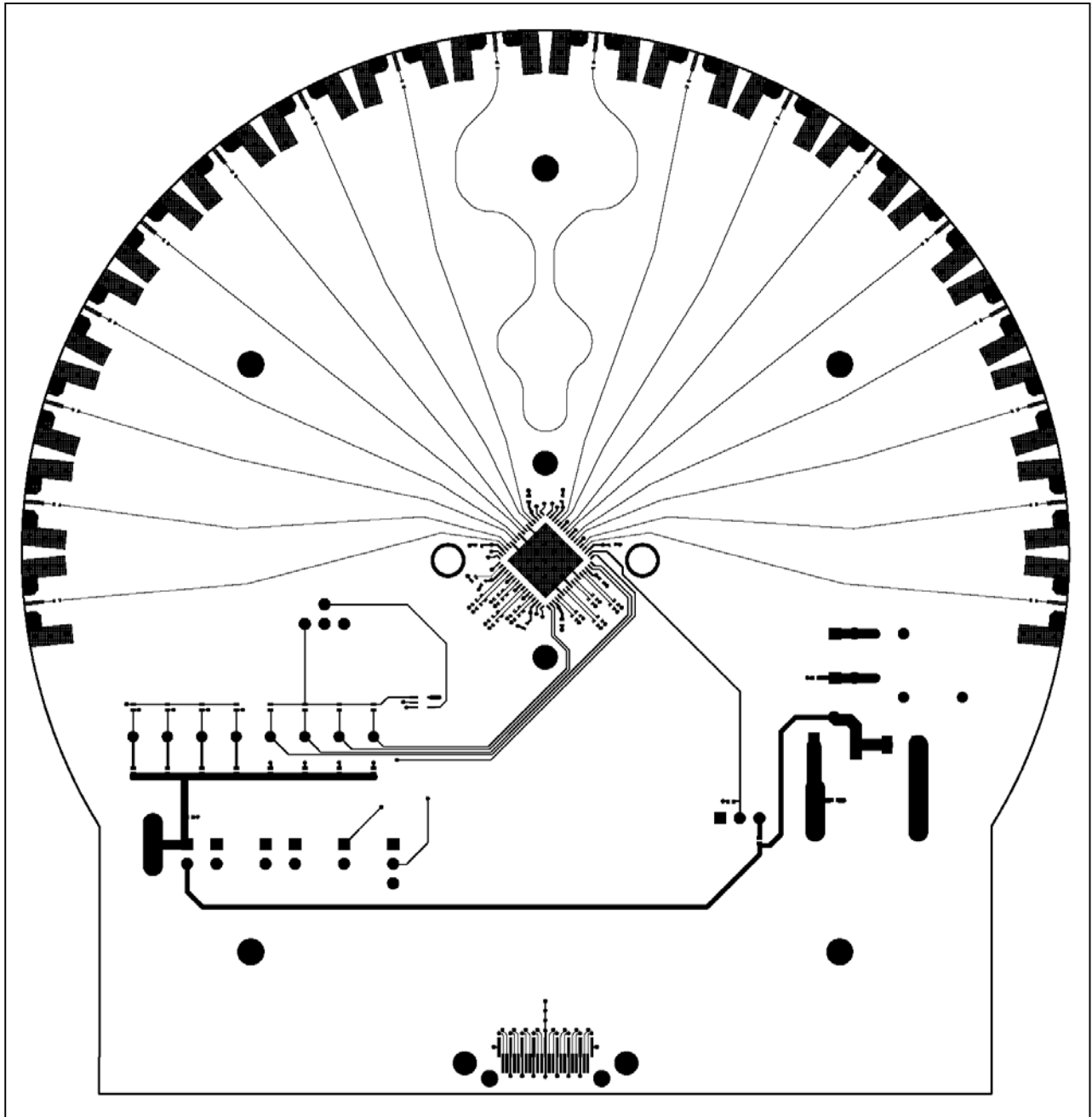

Figure 3. MAX3983 EV Kit PC Board Layout – Component Side (Signal), Layer 1

# MAX3983 Evaluation Kit

Evaluates: MAX3983

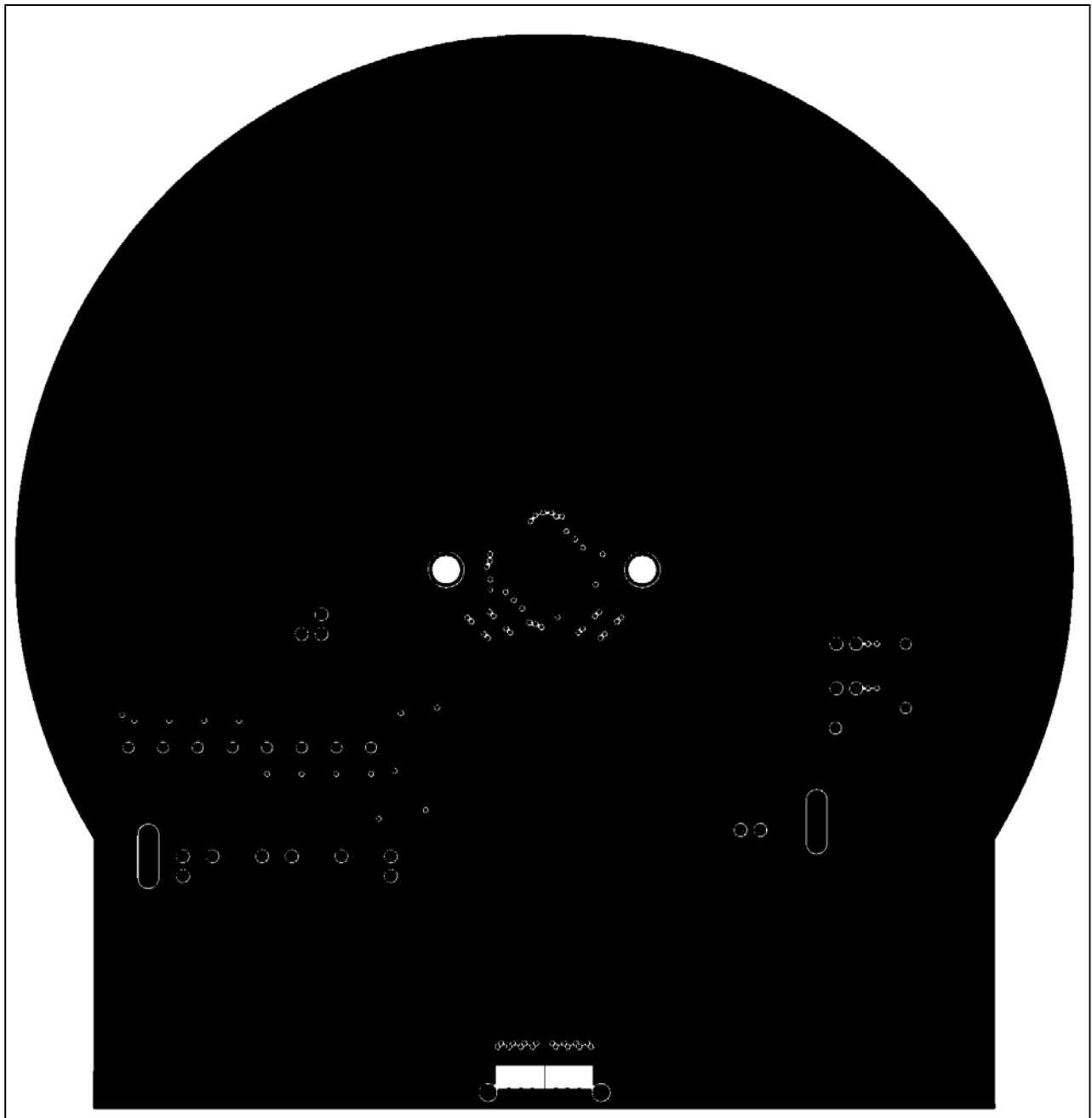

Figure 4. MAX3983 EV Kit PC Board Layout – Ground Plane, Layer 2

# MAX3983 Evaluation Kit

Evaluates: MAX3983

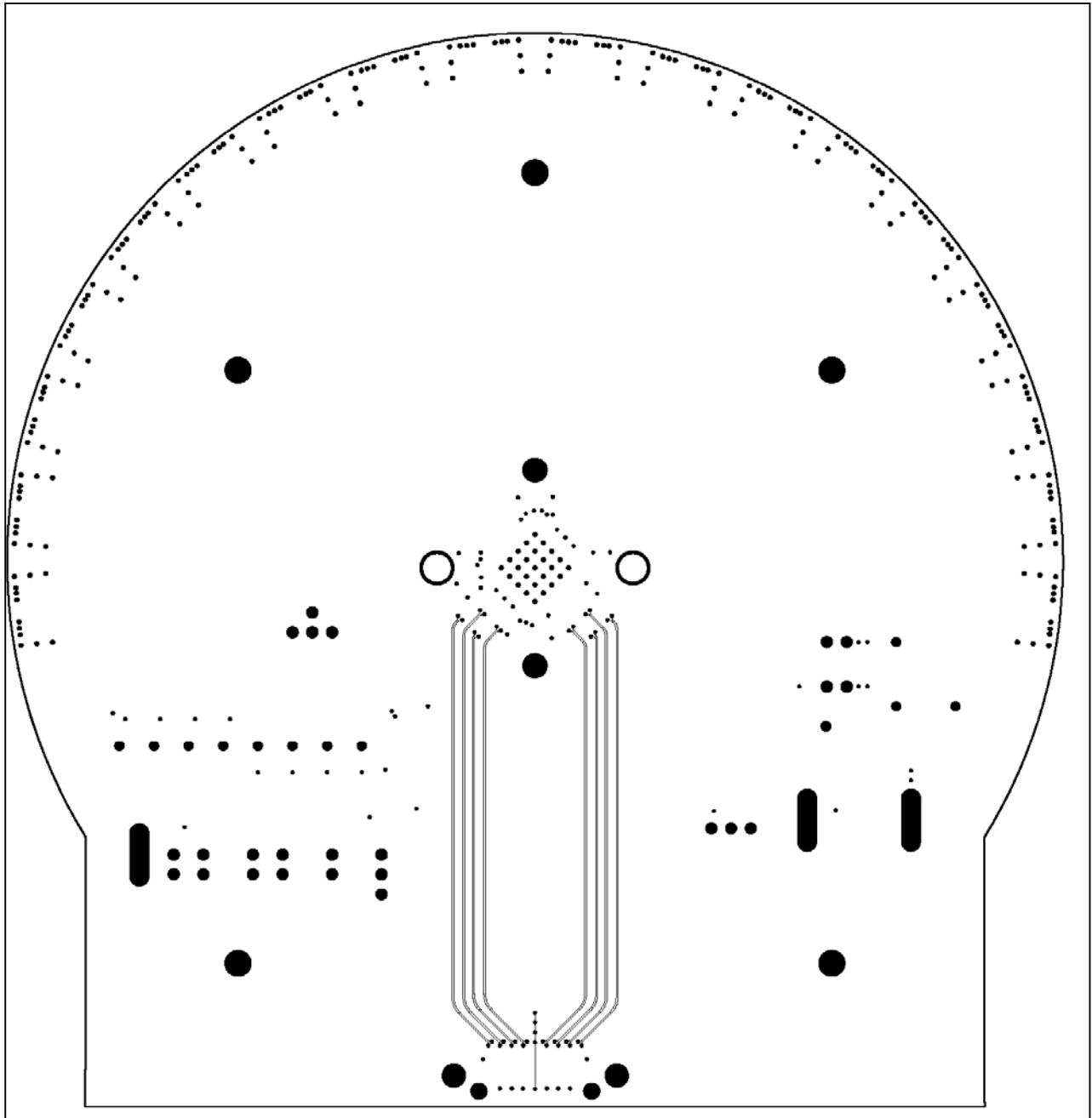

Figure 5. MAX3983 EV Kit PC Board Layout – Signal, Layer 3

# MAX3983 Evaluation Kit

Evaluates: MAX3983

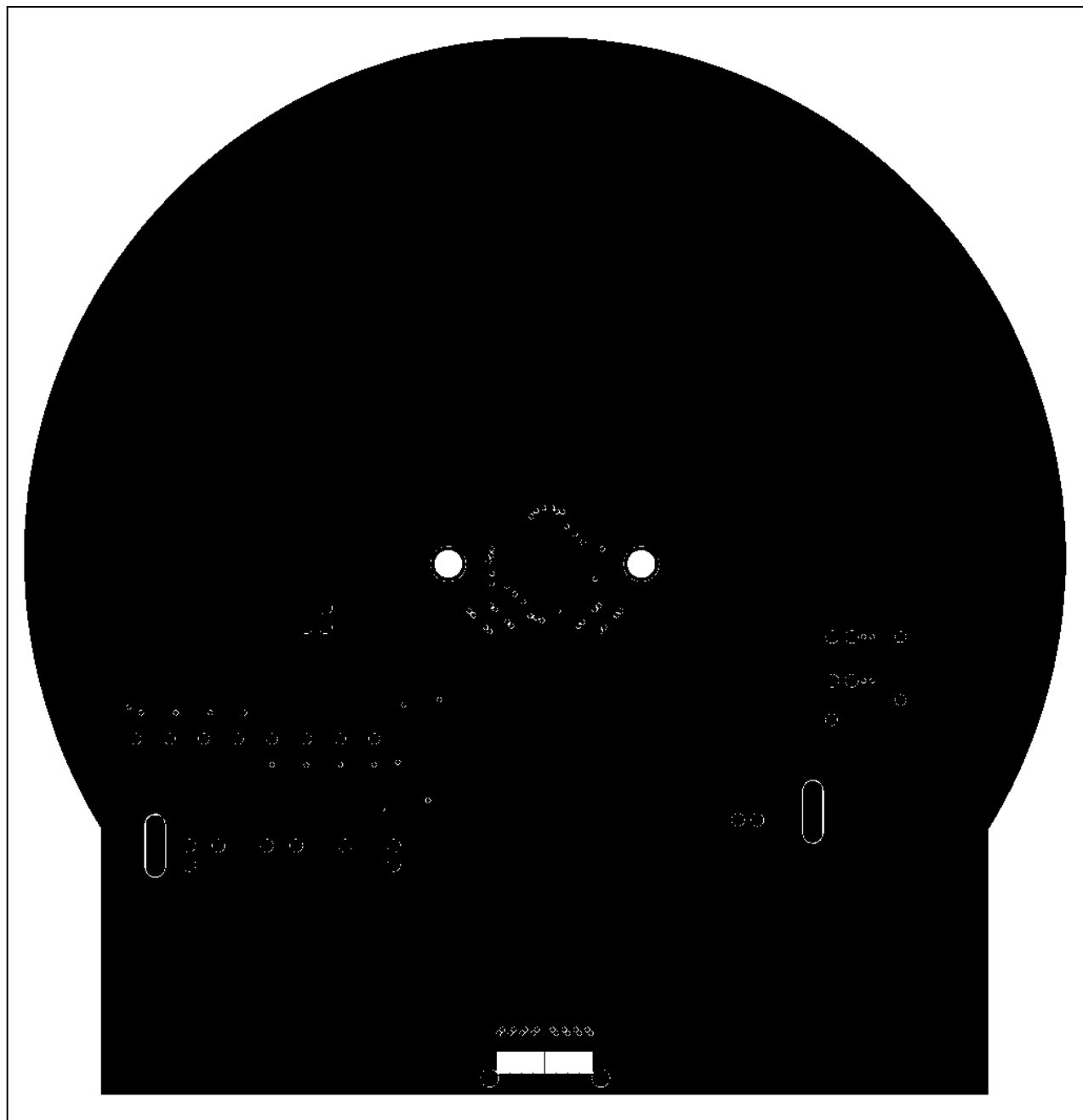

Figure 6. MAX3983 EV Kit PC Board Layout – Ground Plane, Layer 4



# MAX3983 Evaluation Kit

Evaluates: MAX3983

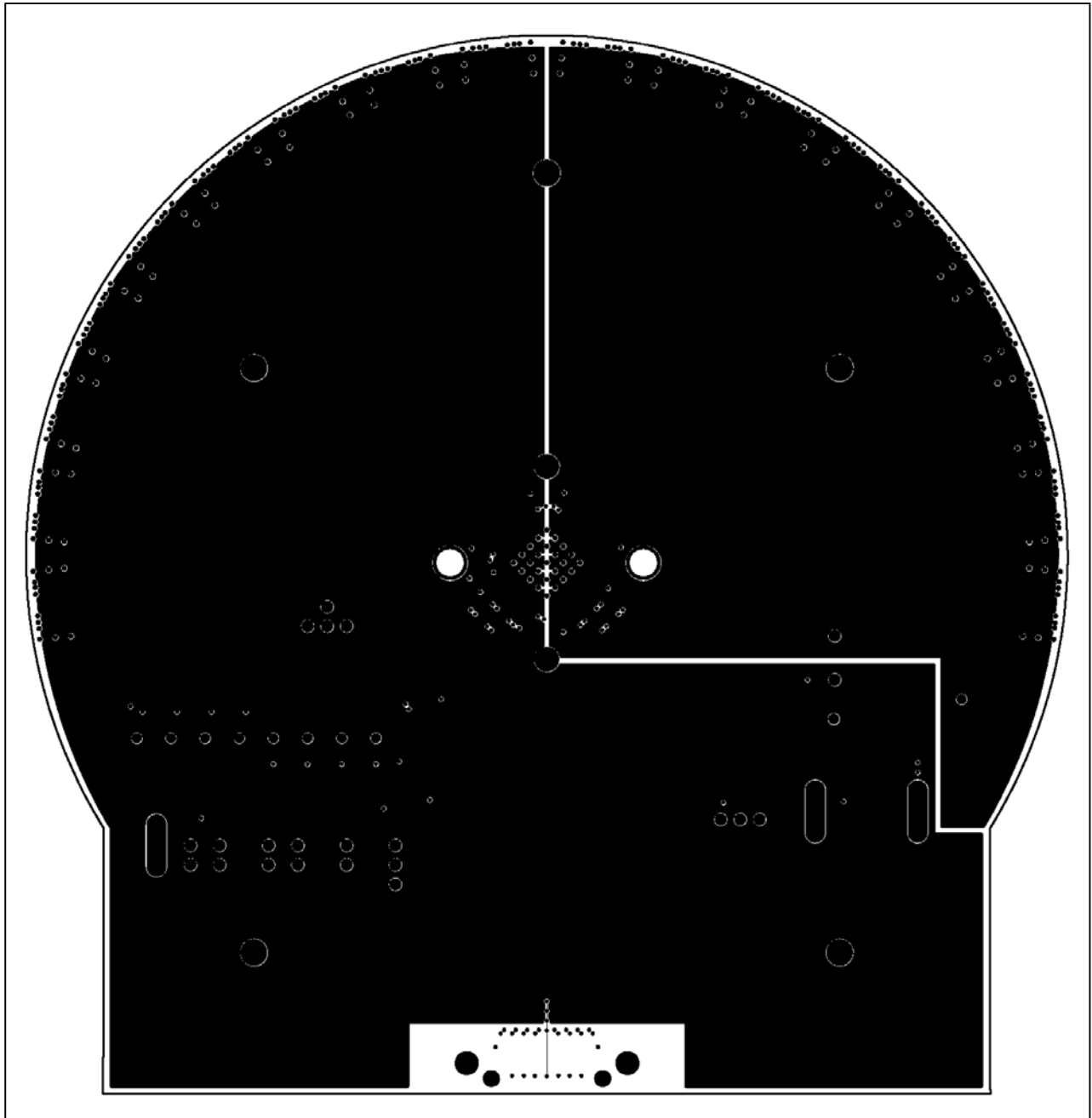

Figure 7. MAX3983 EV Kit PC Board Layout – Power Plane, Layer 5

# MAX3983 Evaluation Kit

Evaluates: MAX3983

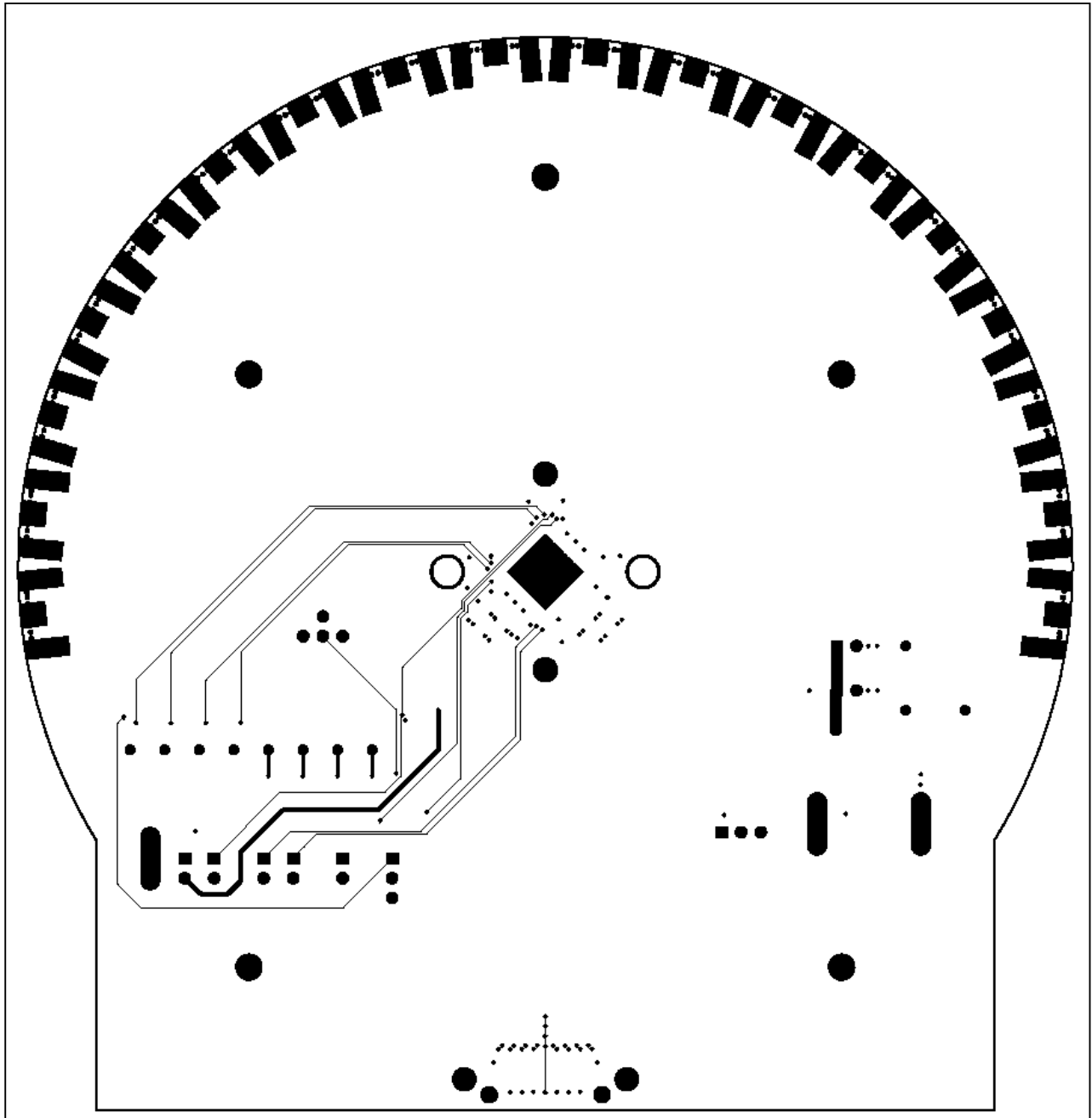

Figure 8. MAX3983 EV Kit PC Board Layout – Bottom (Signal), Layer 6

Maxim makes no warranty, representation or guarantee regarding the suitability of its products for any particular purpose, nor does Maxim assume any liability arising out of the application or use of any product or circuit and specifically disclaims any and all liability, including without limitation consequential or incidental damages. "Typical" parameters can and do vary in different applications. All operation parameters, including "typicals" must be validated for each customer application by customer's technical experts. Maxim products are not designed, intended or authorized for use as components in systems intended for surgical implant into the body, or other applications intended to support or sustain life, or for any other application in which the failure of the Maxim product could create a situation where personal injury or death may occur.

10 \_\_\_\_\_ Maxim Integrated Products, 120 San Gabriel Drive, Sunnyvale, CA 94086 408-737-7600