



MAX5858A Evaluation Kit

General Description

The MAX5858A evaluation kit (EV kit) is a fully assembled and tested circuit board that contains all the components necessary for evaluating the MAX5858A. The MAX5858A is a dual, 10-bit, 300Msps digital-to-analog converter (DAC) with 4x/2x/1x-configurable interpolation filters. The MAX5858A also features a phase-locked-loop (PLL) clock multiplier that generates and distributes all internally synchronized high-speed clock signals required by the input data latches, interpolation filters, and DAC cores. The EV kit requires CMOS-compatible data and clock inputs, and three separate 3V power supplies. The EV kit can also evaluate the MAX5858 (no PLL) and the 8-bit MAX5856A (with PLL).

Features

- ◆ Allows Fast Evaluation and Performance Testing
- ◆ 3V and 2V CMOS Logic-Level-Compatible Inputs
- ◆ Also Evaluates MAX5858/MAX5856A (with IC Replacement)
- ◆ Configurable, Integrated 4x or 2x Interpolation Filters
- ◆ Interleaved Data Mode
- ◆ On-Board Differential to Single-Ended Output Conversion Circuitry
- ◆ SMA Coaxial Connectors for Clock Inputs and DAC Outputs
- ◆ Proven PCB Layout
- ◆ Fully Assembled and Tested

Ordering Information

PART	TYPE
MAX5858AEVKIT	EV Kit

Component List

DESIGNATION	QTY	DESCRIPTION
C1, C2, C9, C10, C15, C16	6	10 μ F \pm 20%, 6.3V tantalum capacitors (1206) Panasonic ECS-T0JY106R AVX TAJA106M006RNJ
C3, C4, C11, C12, C17, C18	6	1 μ F \pm 10%, 10V X5R ceramic capacitors (0603) TDK C1608X5R1A105K
C5, C22, C24, C25, C28	5	0.1 μ F \pm 10%, 25V X7R ceramic capacitors (0603) TDK C1608X7R1E104K
C6, C7, C8, C19	4	0.1 μ F \pm 10%, 6.3V X5R ceramic capacitors (0201) TDK C0603X5R0J104K
C13, C14	2	0.1 μ F \pm 10%, 10V X5R ceramic capacitors (0402) TDK C1005X5R1A104K
C21, C23	2	5pF \pm 0.25pF, 50V C0G ceramic capacitors (0603) TDK C1608C0G1H050C

DESIGNATION	QTY	DESCRIPTION
C29	1	100pF \pm 10%, 50V C0G ceramic capacitor (0603) TDK C1608C0G1H101K
CLK1, CLKIN, CLKOUT, OUTA, OUTB	5	Edge-mount SMA connectors
J1	1	21 x 2-pin header
JU1–JU11	11	2-pin headers
L1, L2, L3	3	91 Ω at 100MHz ferrite beads (1806) Panasonic EXC-ML45A910H
R1, R6	0	Not installed, resistors (0603)
R2, R3, R4, R27	4	1k Ω \pm 5% resistors (0603)
R5, R16, R18–R21, R23	7	49.9 Ω \pm 1% resistors (0603)
R17, R22	2	100 Ω \pm 1% resistors (0603)
R24, R25	2	24.9 Ω \pm 1% resistors (0603)
R26, R29, R30	3	10k Ω \pm 5% resistors (0603)
R28	1	4.12k Ω \pm 1% resistor (0603)
R31	1	1.91k Ω \pm 1% resistor (0805)



MAX5858A Evaluation Kit

Component List (continued)

DESIGNATION	QTY	DESCRIPTION
T1, T3, T5, T6	4	Transformers Mini-Circuits ADTL1-12+
T2, T4	2	Transformers Mini-Circuits ADTT1-1+
U1	1	10-bit DAC (48 TQFP-EP) Maxim MAX5858AECM

DESIGNATION	QTY	DESCRIPTION
U2	1	Quadruple bus buffer gate with three-state outputs (14 TSSOP-PW) Texas Instruments SN74ALVC125PWR
None	11	Shunts (JU1, JU10, JU11 any one pin), (JU2–JU9 pins 1-2)
None	1	PCB: MAX5858A EVALUATION KIT

Component Suppliers

SUPPLIER	PHONE	WEBSITE
AVX Corporation	843-946-0238	www.avxcorp.com
Mini-Circuits	718-934-4500	www.minicircuits.com
Panasonic Corp.	800-344-2112	www.panasonic.com
TDK Corp.	847-803-6100	www.component.tdk.com
Texas Instruments Inc.	972-644-5580	www.ti.com

Note: Indicate that you are using the MAX5858A when contacting these component suppliers.

Quick Start (PLL Disabled)

Note: To evaluate PLL-enabled mode, see the *Quick Start (PLL Enabled)* section.

Recommended Equipment

- MAX5858A EV kit
- DC power supplies:
 - Digital 3V, 500mA
 - Analog 3V, 100mA
 - Clock 3V, 200mA
- Two RF signal generators with low phase noise and low jitter for the clock input (e.g., HP 8662A)
- Data generator (e.g., Sony/Tektronix DG2020A)
- Two variable output PODs (e.g., Sony/Tektronix P3420)
- Spectrum analyzer
- Oscilloscope
- Digital voltmeter

Procedure

The EV kit is a fully assembled and tested surface-mount board. Follow the steps below for board operation.

Caution: Do not turn on power supplies or enable signal generators until all connections are completed (Figure 1).

- 1) Verify that a shunt is not installed on jumper JU1 (the CLKIN SMA connector on the EV kit is not used for evaluating the MAX5858A in PLL disabled mode).
- 2) Verify that a shunt is installed on jumper JU2 (no DC offset at single-ended analog outputs OUTA and OUTB).
- 3) Verify that a shunt is installed on jumper JU3 (IDE disabled).
- 4) Verify that a shunt is installed on jumper JU4 (PLL disabled).
- 5) Verify that a shunt is installed on jumper JU5 ($\overline{\text{REN}}$ enabled, internal reference enabled).
- 6) Verify that shunts are installed on jumpers JU6–JU9 (single-ended output mode).
- 7) Verify that no shunts are installed on jumpers JU10 and JU11. (CLKXP and CLKXN are used for evaluating the MAX5858A in PLL disabled mode).
- 8) Connect the RF OUTPUT of the master HP 8662A (data clock) to the clock input on the back side of

MAX5858A Evaluation Kit

Evaluates: MAX5858A/MAX5858/MAX5856A

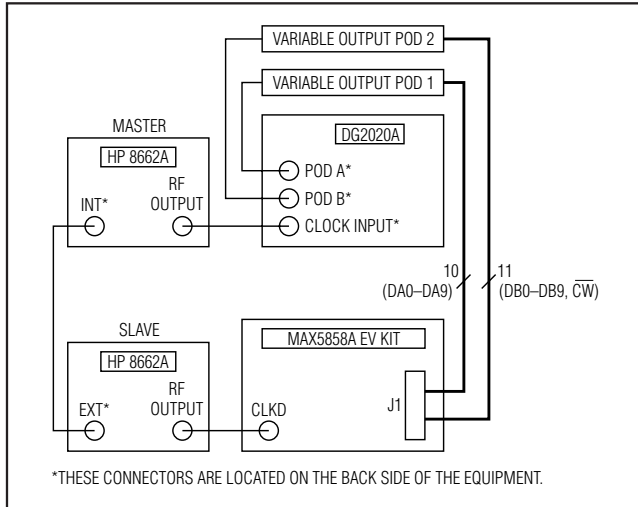

Figure 1. Quick Start Setup for PLL Disabled Mode

the data generator (Sony/Tektronix DG2020A). (See Figure 1 for the equipment setup connections.)

- 9) Connect the RF OUTPUT of slave HP 8662A (EV kit clock) to the CLKD SMA connector on the EV kit.
- 10) Synchronize master HP 8662A to the slave HP 8662A on the back side by connecting the INT of the master to the EXT of the slave generator.
- 11) Verify that the data generator is programmed for CMOS-level outputs, which transition from 0 to 3V.
- 12) Connect data generator POD A to the first variable output POD (1). Connect output channels CH9

through CH0 of variable output POD 1 to the EV kit connector J1, as indicated in Table 1.

- 13) Connect data generator POD B to the second variable output POD (2). Connect output channels CH9 through CH0 of the variable output POD 2 to EV kit connector J1, as indicated in Table 2.
- 14) Connect the spectrum analyzer to the OUTA or the OUTB SMA connector.
- 15) Connect the 3V, 500mA power supply to DVDD. Connect the ground terminal of this supply to DGND.
- 16) Connect the 3V, 100mA power supply to AVDD. Connect the ground terminal of this supply to AGND.
- 17) Connect the 3V, 200mA power supply to PVDD. Connect the ground terminal of this supply to PGND.
- 18) Turn on all three power supplies.
- 19) With a voltmeter, verify that 1.24V is measured at the REFO pad on the EV kit.
- 20) Enable the signal generators and the data generator. Set both HP 8662As for an output amplitude of 2V_{P-P} and identical frequencies (f_{CLK}) of ≤ 165 MHz.
- 21) Adjust the phase of the master HP 8662A RF source, to meet the MAX5858A data timing specifications.
- 22) Use the spectrum analyzer to view the MAX5858A output spectrum, or view the output waveforms using an oscilloscope on the outputs.

Table 1. Connector J1

VARIABLE POD 1	CH9	CH8	CH7	CH6	CH5	CH4	CH3	CH2	CH1	CH0
MAX5858A PIN NAME	DA9/PD	DA8/DACEN	DA7/F2EN	DA6/F1EN	DA5/G3	DA4/G2	DA3/G1	DA2/G0	DA1	DA0
MAX5858A EV KIT	J1-41	J1-39	J1-37	J1-35	J1-33	J1-31	J1-29	J1-27	J1-25	J1-23

Table 2. Connector J1

VARIABLE POD 2	CH11	CH9	CH8	CH7	CH6	CH5	CH4	CH3	CH2	CH1	CH0
MAX5858A PIN NAME	\overline{CW}	DB9	DB8	DB7	DB6	DB5	DB4	DB3	DB2	DB1	DB0
MAX5858A EV KIT	J1-1	J1-21	J1-19	J1-17	J1-15	J1-13	J1-11	J1-9	J1-7	J1-5	J1-3

MAX5858A Evaluation Kit

Detailed Description of Hardware

The MAX5858A EV kit is designed to simplify the evaluation of the MAX5858A 10-bit, dual, 300MSPS DAC with PLL. The board contains all circuitry necessary to evaluate the dynamic performance of this high-speed converter, including circuitry to convert the DAC's differential output into a single-ended output.

The EV kit provides PCB connector pads for power supplies AVDDIN, DVDDIN, and PVDDIN. SMA connectors are included for clock functions CLKIN, CLKOUT, CLKD, and DAC outputs OUTA and OUTB connections. The four-layer PCB is a high-speed design that optimizes the dynamic performance of the DAC by separating the analog and digital circuitry, which implements impedance matching for the differential output signal PCB traces. The PCB traces have been designed for 50Ω impedance.

Power Supplies

The EV kit requires separate analog, digital, and PLL power supplies. Connect a 3V power supply to the AVDDIN PCB pad to power the analog portion of the DAC. Connect the second 3V power supply to the DVDDIN PCB pad to power the digital portion of the DAC. Connect the third 3V power supply to the PVDDIN PCB pad to power the PLL portion of the DAC.

Digital Inputs

The EV kit provides connector J1 for the two 10-bit input data buses. Data bits DA[9:2] of channel A share a dual function for data and control word. The control word is latched by the \overline{CW} bit (J1-1). The control word is latched on the falling edge of \overline{CW} . Refer to the MAX5858A IC data sheet for a detailed description of the control and data word functions. The data word is latched on the rising edge of the CLK output, pin 20 of the MAX5858A.

DAC Output

The EV kit is designed to provide two pairs of analog outputs. The outputs can be configured for either differential or single-ended mode of operation. In single-ended mode and with transformer-coupled output and 50Ω external termination, the MAX5858A delivers a -2dBm output signal. In differential mode, the output amplitude is 1V_{P-P} at both positive and negative DAC outputs. To configure the MAX5858A for differential output operation, remove jumpers JU6–JU9, and measure the outputs at the A+, A-, and B+, B- 2-pin headers. To configure the MAX5858A for single-ended output operation, install shunts on jumpers JU6–JU9, and measure the outputs at the OUTA and OUTB SMA connectors.

Table 3. DAC Output Mode (Jumpers JU6–JU9)

SHUNT POSITION	DAC OUTPUT MODE	ANALOG OUTPUT LOCATIONS
Installed	Single-ended mode	OUTA and OUTB SMA connectors
Not installed	Differential mode	A+, A- and B+, B- 2-pin headers

Table 4. Interleaved Data Mode (Jumper JU3)

SHUNT POSITION	MAX5858A IDE PIN	INTERLEAVED DATA MODE
Not installed	Connected to DVDD with R26	Enabled
Installed	Connected to DGND	Disabled

Table 5. Reference Voltage Option (Jumper JU5)

SHUNT POSITION	MAX5858A \overline{REN} PIN	REFERENCE VOLTAGE OPTION
Not installed	Connected to AVDD with R30	External reference
Installed	Connected to AGND	Internal reference

Table 3 lists the jumper configuration for the DAC output mode selection.

Output DC Offset

The EV kit features an option to add a DC offset to the analog output signals. To add a DC offset, remove jumper JU2 and connect an appropriate DC source across jumper JU2. The DC source has to be able to sink at least 40mA of DC current. The DC offset must be within 0 to 1.25V.

Interleaved Data Mode

The MAX5858A, MAX5858, and MAX5856A feature an interleaved data mode that multiplexes the data inputs of both channels through port A. This feature allows the user to reduce the bit width of the input data bus. In interleaved data mode, channel B data is latched on the falling edge of the clock (CLK), and channel A data is latched on the following rising edge of the clock (CLK). Jumper JU3 sets the interleaved data mode option. Table 4 lists the jumper selection.

MAX5858A Evaluation Kit

Table 6. MAX5856A Data Bits DA7 Through DA0 on the EV Kit

MAX5856A PIN NAME	DA7/PD	DA6/DACEN	DA5/F2EN	DA4/F1EN	DA3/G3	DA2/G2	DA1/G1	DA0/G0	SHORT TO DGND	SHORT TO DGND
MAX5858A EV KIT	J1-41	J1-39	J1-37	J1-35	J1-33	J1-31	J1-29	J1-27	J1-25	J1-23

Table 7. MAX5856A Data Bits DB7 Through DB0 on the EV Kit

MAX5856A PIN NAME	DB7	DB6	DB5	DB4	DB3	DB2	DB1	DB0	SHORT TO DGND	SHORT TO DGND	$\overline{\text{CW}}$
MAX5858A EV KIT	J1-21	J1-19	J1-17	J1-15	J1-13	J1-11	J1-9	J1-7	J1-5	J1-3	J1-1

Table 8. PLL Clock Multiplier (Jumper JU4) for MAX5858A and MAX5856A

SHUNT POSITION	PLEN PIN	PLL CLOCK MULTIPLIER
Not installed	Connected to PVDD with R29	Enabled
Installed	Connected to PGND	Disabled

Table 9. Input Clock Selection

CLOCK MODE	JUMPER SETTINGS
CLKIN mode	MAX5858A or MAX5856A PLL enabled; JU1, JU10, and JU11 installed; JU4 not installed
CLKD mode	MAX5858 or MAX5858A, or MAX5856A PLL disabled; JU1, JU10, and JU11 not installed; JU4 installed

Reference Voltage Options

The EV kit supports both internal and external reference configurations. The internal reference voltage can be accessed at the REFO pad. The EV kit also accepts an external reference voltage at the REFO pad to set the full-scale analog-output signal level. Jumper JU5 selects the reference voltage options for the EV kit. Table 5 lists the jumper selection.

Evaluating the MAX5858

The EV kit also evaluates the pin-compatible MAX5858. Refer to the MAX5858 IC data sheet for more details on the MAX5858 functions. To evaluate the MAX5858, replace U1 with the MAX5858 and install a shunt on jumper JU4.

Evaluating the MAX5856A

The EV kit also evaluates the MAX5856A. Refer to the MAX5856A IC data sheet for more details on the MAX5856A functions. To evaluate the MAX5856A, the following component changes on the EV kit are necessary:

- Replace U1 with the MAX5856A.
- Install a shunt on J1-3 and J1-4.
- Install a shunt on J1-5 and J1-6.
- Install a shunt on J1-23 and J1-24.
- Install a shunt on J1-25 and J1-26.
- See Tables 6 and 7 for the data bits of the MAX5856A, with respect to header J1 on the EV kit.

PLL Clock Multiplier (MAX5858A and MAX5856A only)

The MAX5858A (10 bit) and MAX5856A (8 bit) feature a PLL clock multiplier that generates and distributes all internally synchronized high-speed clock signals required by the input data latches, interpolation filters, and DAC cores. Jumper JU4 sets the PLL clock multiplier options. Table 8 lists the jumper selection.

Clock

The EV kit features two input clock options: a single-ended input clock applied to CLKIN or a differential clock applied to CLKD. When evaluating the MAX5858A or the MAX5856A, CLKIN is used in PLL enabled mode, and CLKD is used in PLL disabled mode. The clock signal applied to the CLKIN SMA input connector has to meet CMOS logic-level requirements. When evaluating the MAX5858, only the CLKD SMA input connector is used. Jumpers JU1, JU4, JU10, and JU11 set the input clock mode for the MAX5858A. Table 9 lists the jumper configurations.

MAX5858A Evaluation Kit

- 7) Verify that shunts are installed on jumpers JU10 and JU11 (CLKXP and CLKXN are not used for evaluating the MAX5858A in PLL enabled mode).
- 8) Connect the TRIG OUTPUT (clock synchronize signal) of the HP 8131A to the clock input on the back side of the data generator (Sony/Tektronix DG2020A). See Figure 2 for the equipment setup connections.
- 9) Connect the OUTPUT signal of the HP 8131A to the CLKIN SMA connector on the EV kit.
- 10) Verify that both the pulse generator and the data generator are programmed for CMOS level outputs, which transition from 0 to 3V.
- 11) Connect data generator POD A to the first variable output POD (1). Connect output channels CH9 through CH0 of the variable output POD 1 to the MAX5858A EV kit connector J1, as indicated in Table 10.
- 12) Connect data generator POD B to the second variable output POD (2). Connect output channels CH9 through CH0 of the variable output POD 2 to the MAX5858A EV kit connector J1, as indicated in Table 11.
- 13) Connect the spectrum analyzer to the OUTA or the OUTB SMA connector.
- 14) Connect the 3V, 500mA power supply to DVDD. Connect the ground terminal of this supply to DGND.
- 15) Connect the 3V, 100mA power supply to AVDD. Connect the ground terminal of this supply to AGND.
- 16) Connect the 3V, 200mA power supply to PVDD. Connect the ground terminal of this supply to PGND.
- 17) Turn on all three power supplies.
- 18) With a voltmeter, verify that 1.24V is measured at the REFO pad on the EV kit.
- 19) Enable the pulse generator and the data generator. For 1x interpolation, set the HP 8131A output for a square wave with a frequency (f_{CLK}) of $\leq 165\text{MHz}$. For 2x interpolation, set the HP 8131A output for a square wave with a frequency (f_{CLK}) of $\leq 150\text{MHz}$. For 4x interpolation, set the HP 8131A output for a square wave with a frequency (f_{CLK}) of $\leq 75\text{MHz}$.
- 20) Adjust the delay between the HP 8131A TRIG OUTPUT and signal OUTPUT to meet the MAX5858A data timing specifications.
- 21) Use the spectrum analyzer to view the MAX5858A output spectrum, or view the output waveforms using an oscilloscope on the outputs.

Evaluates: MAX5858A/MAX5858/MAX5856A

MAX5858A Evaluation Kit

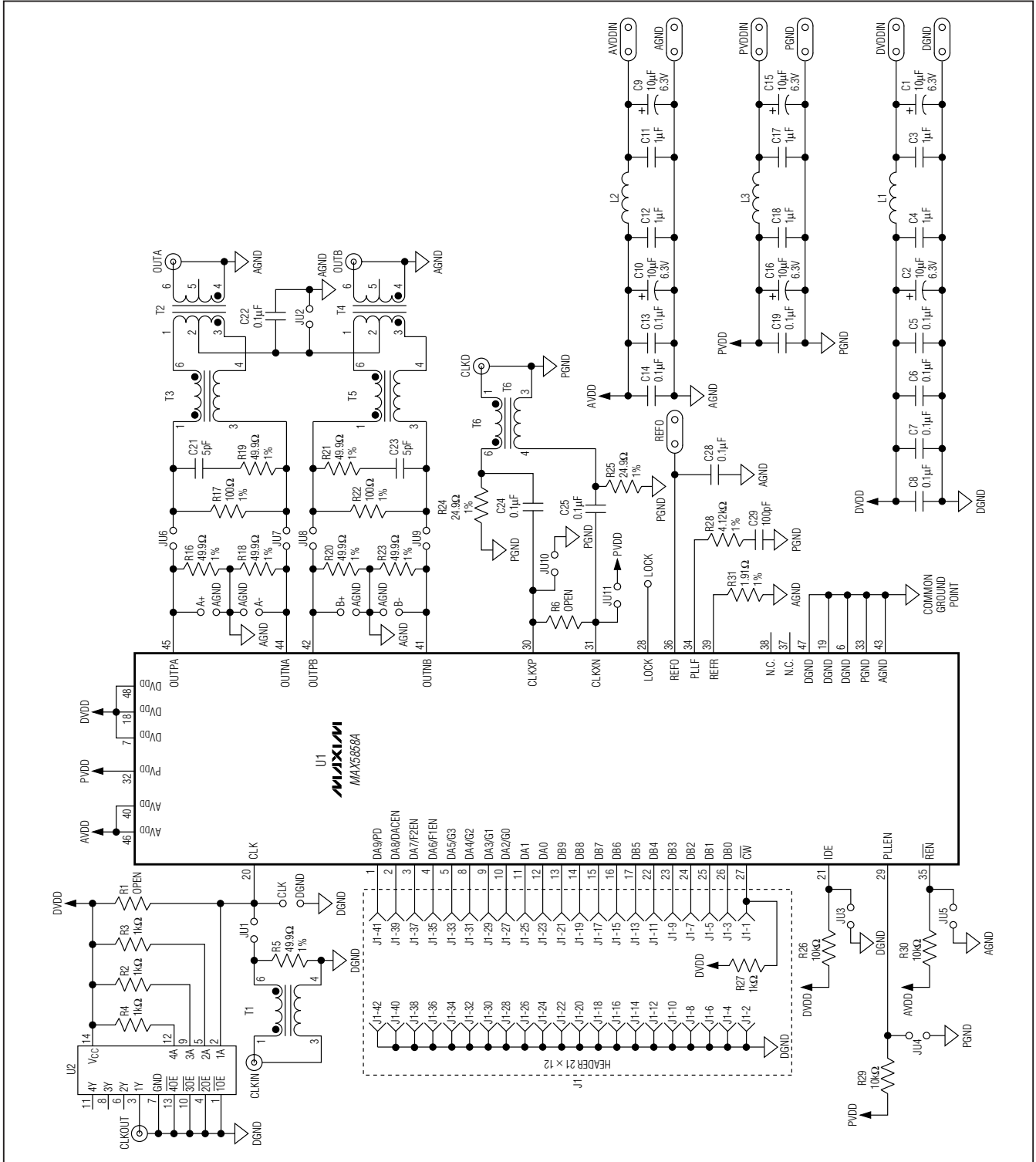

Figure 3. MAX5858A EV Kit Schematic

MAX5858A Evaluation Kit

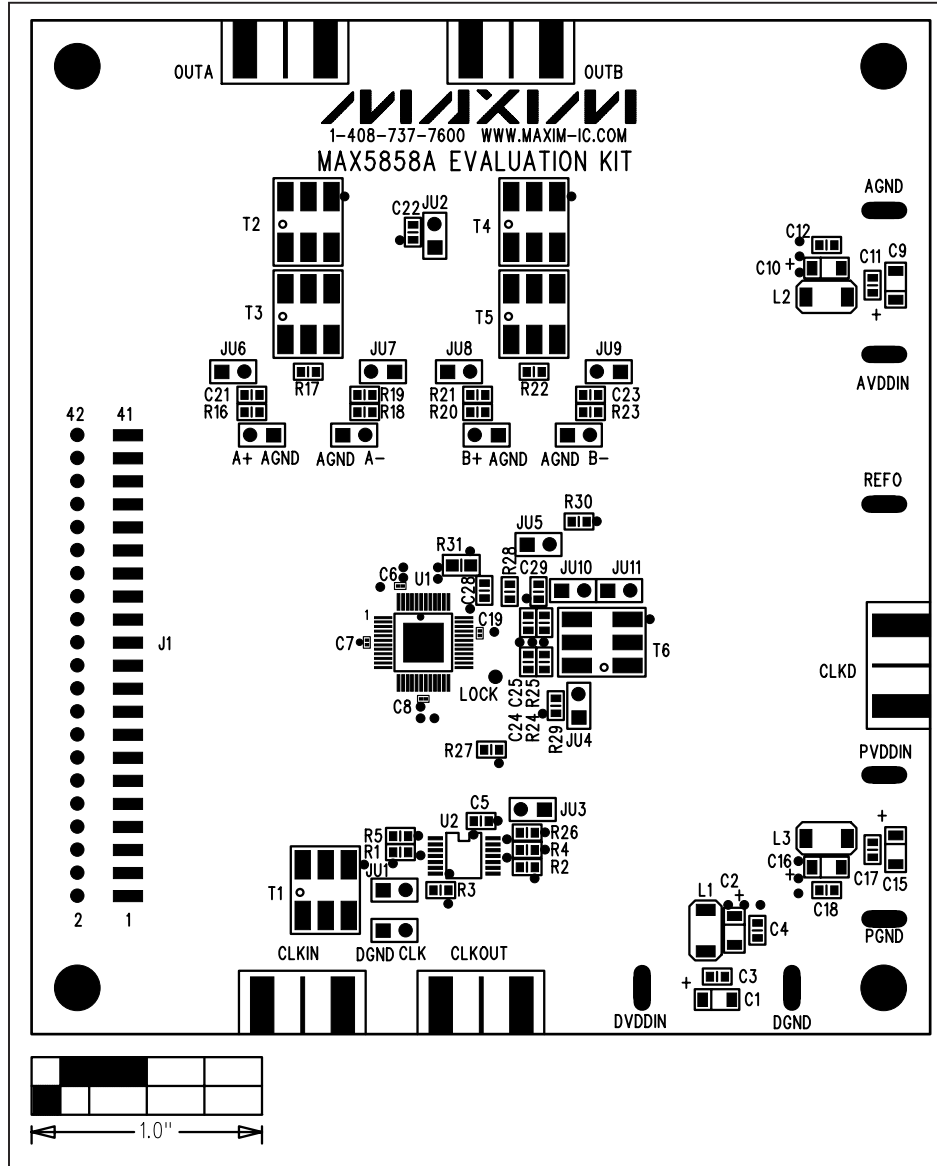

Figure 4. MAX5858A EV Kit Component Placement Guide—Component Side

Evaluates: MAX5858A/MAX5858/MAX5856A

MAX5858A Evaluation Kit

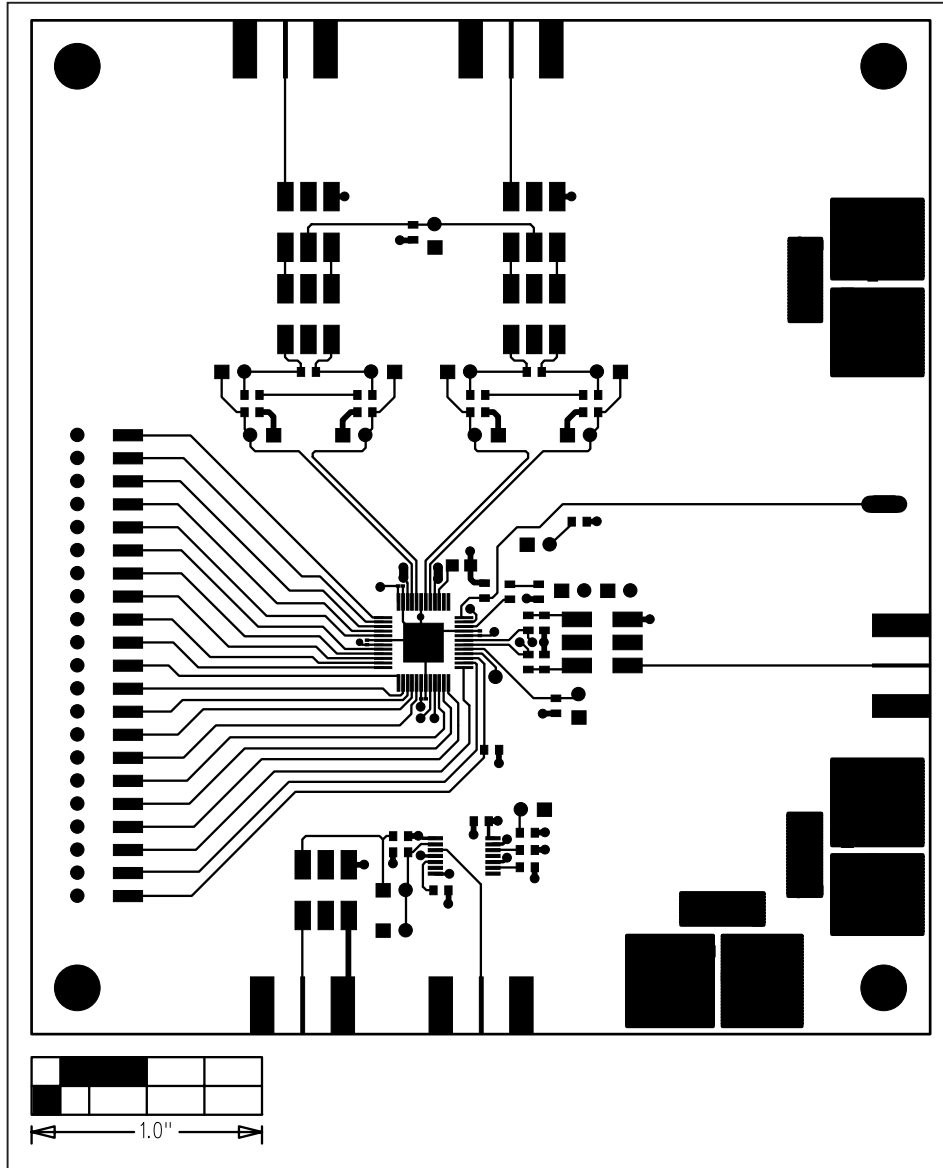

Figure 5. MAX5858A EV Kit PCB Layout—Component Side

MAX5858A Evaluation Kit

Evaluates: MAX5858A/MAX5858/MAX5856A

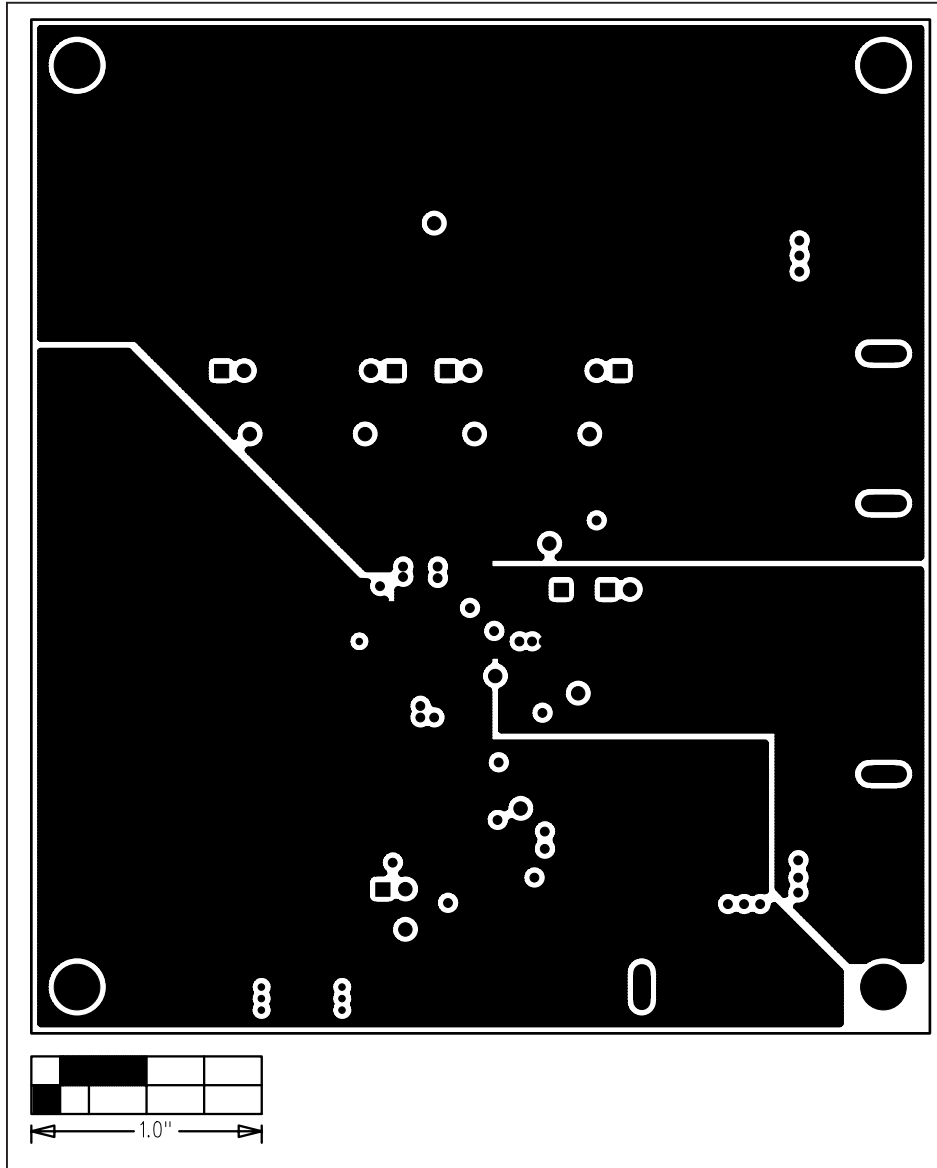

Figure 6. MAX5858A EV Kit PCB Layout (Inner Layer 2)—Ground Planes

MAX5858A Evaluation Kit

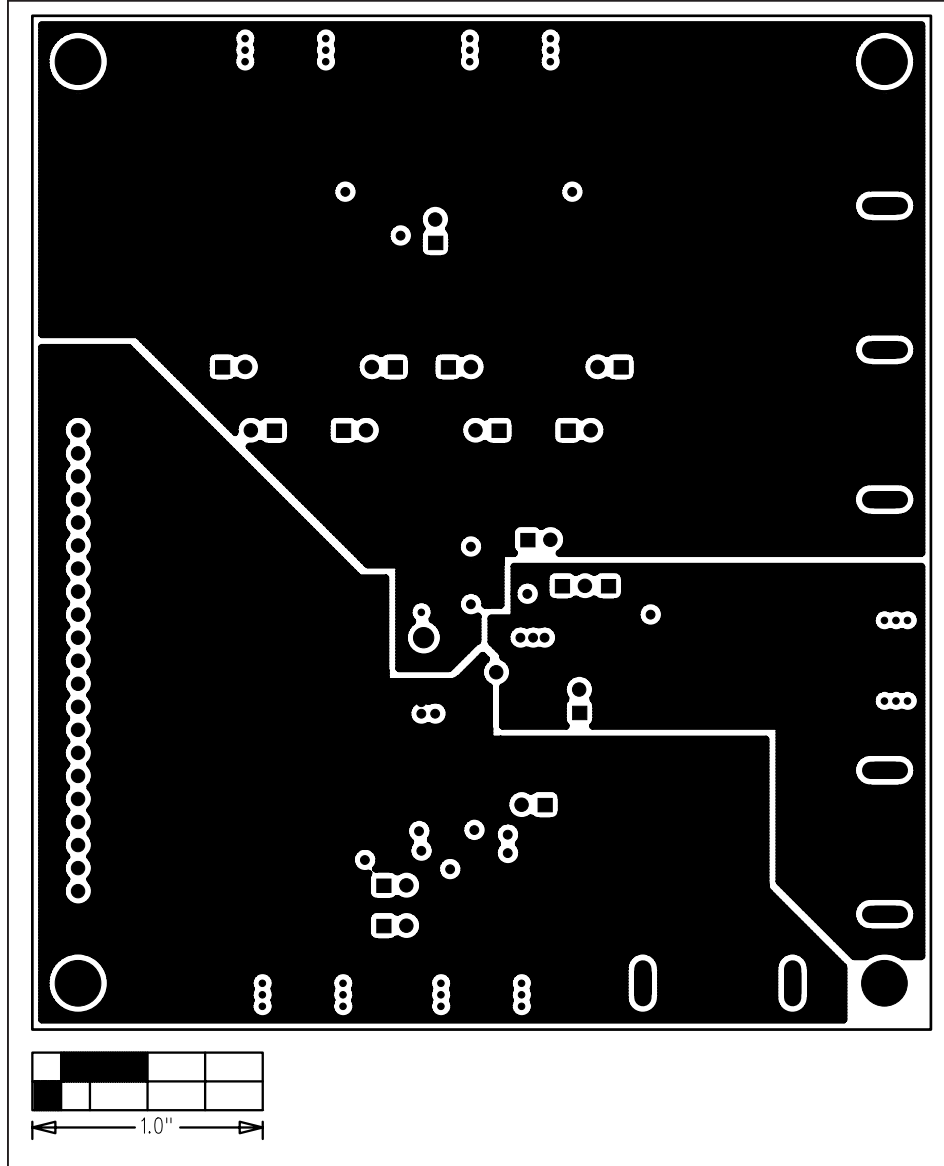

Figure 7. MAX5858A EV Kit PCB Layout (Inner Layer 3)—Power Planes

MAX5858A Evaluation Kit

Evaluates: MAX5858A/MAX5858/MAX5856A

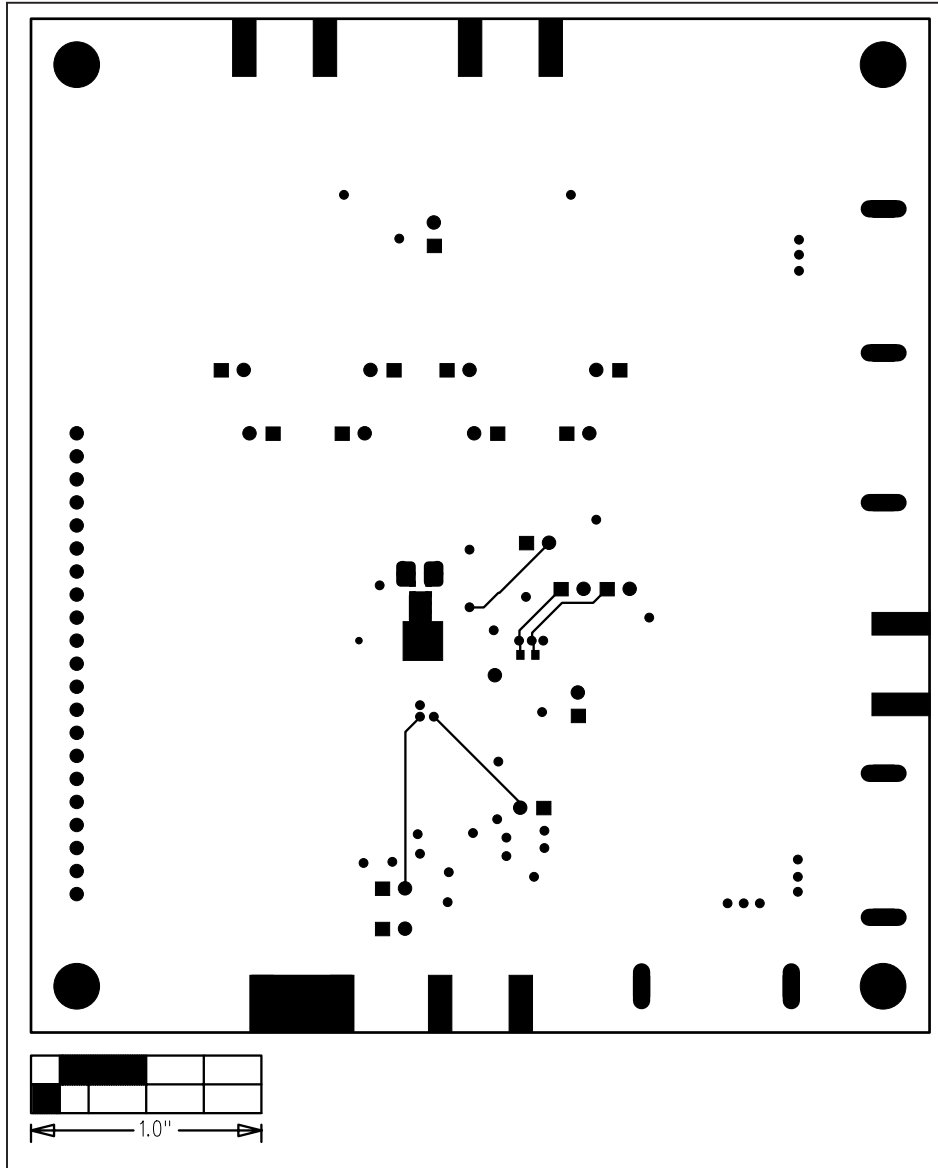

Figure 8. MAX5858A EV Kit PCB Layout—Solder Side

MAX5858A Evaluation Kit

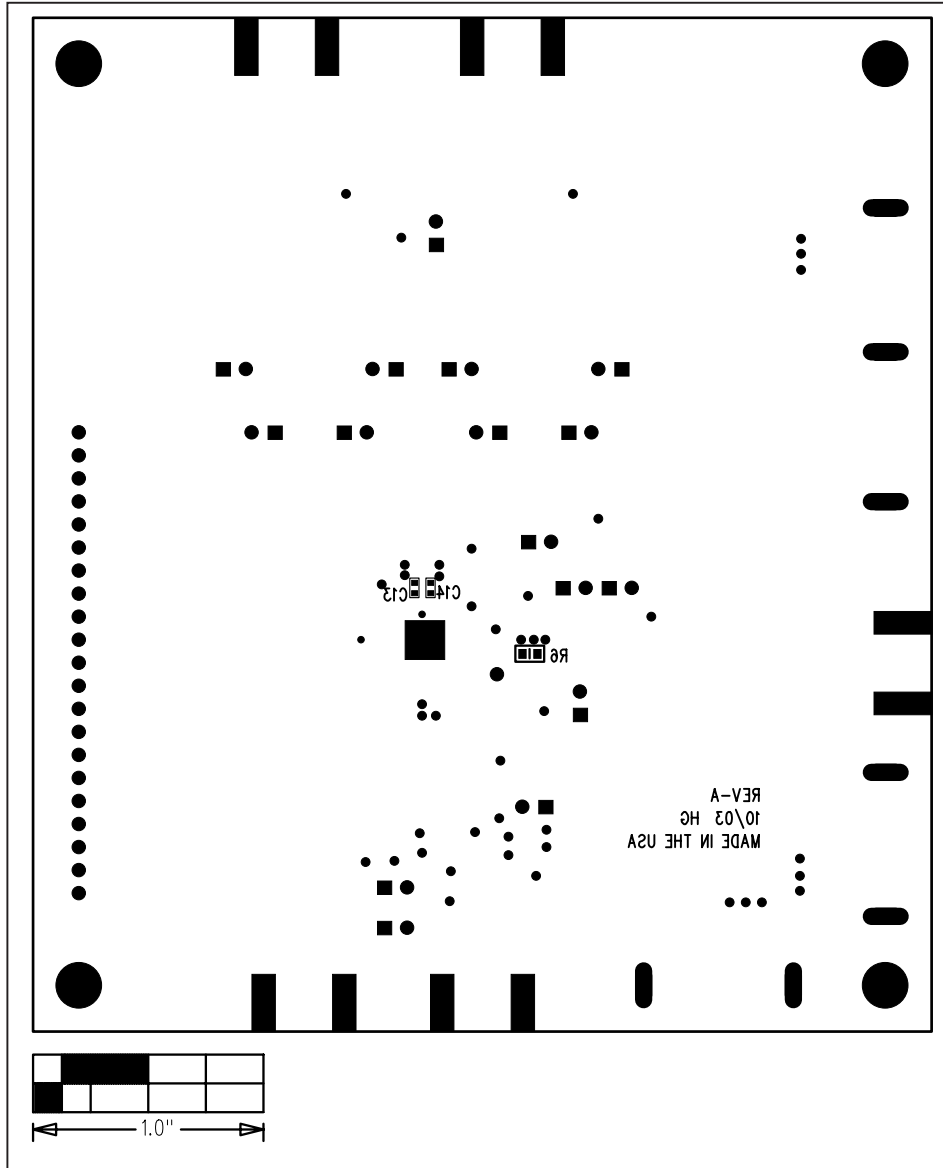

Figure 9. MAX5858A EV Kit Component Placement Guide—Solder Side

MAX5858A Evaluation Kit

Revision History

REVISION NUMBER	REVISION DATE	DESCRIPTION	PAGES CHANGED
0	12/03	Initial release	—
1	2/11	Corrected terminologies for differential and single-ended modes	2, 4, 6
2	5/11	Updated capacitor transformers vendor in <i>Component List</i> and <i>Component</i>	1, 2

Evaluates: MAX5858A/MAX5858/MAX5856A

Maxim cannot assume responsibility for use of any circuitry other than circuitry entirely embodied in a Maxim product. No circuit patent licenses are implied. Maxim reserves the right to change the circuitry and specifications without notice at any time.

Maxim Integrated Products, 120 San Gabriel Drive, Sunnyvale, CA 94086 408-737-7600 _____ 15