

Click [here](#) to ask about the production status of specific part numbers.

## MAX6604 Evaluation Kit

Evaluates: MAX6604

### General Description

The MAX6604 evaluation kit (EV kit) provides a proven design to evaluate the MAX6604 precision temperature monitor for DDR memory modules. The EV kit also includes Windows® 2000/XP- and Windows Vista®-compatible software that provides a simple graphical user interface (GUI) for exercising the features of the MAX6604.

The MAX6604 EV kit PCB comes with a MAX6604ATA+ installed.

### Ordering Information

PART	TYPE
MAX6604EVKIT#	EV Kit

#Denotes RoHS compliant.

### Component List

DESIGNATION	QTY	DESCRIPTION
C1, C5–C9, C17, C18, C37	9	0.1µF ±10%, 16V X7R ceramic capacitors (0603) TDK C1608X7R1C104K
C4	1	0.033µF ±10%, 16V (min) X5R ceramic capacitor (0603) Taiyo Yuden EMK107BJ333KA
C10, C39	2	1µF ±10%, 16V X5R ceramic capacitors (0603) TDK C1608X5R1C105K
C11, C38, C40	3	10µF ±20%, 16V X5R ceramic capacitors (1206) Murata GRM31CR61C106M
C15, C16	2	10pF ±5%, 50V C0G ceramic capacitors (0603) Murata GRM1885C1H100J
C30, C31	2	22pF ±5%, 50V C0G ceramic capacitors (0603) Murata GRM1885C1H220J
H1	1	5-pin header
J1	1	USB type-B right-angle female receptacle
J3	0	Not installed
JU1, JU2, JU3	3	3-pin headers
JU4	1	2-pin header

Windows and Windows Vista are registered trademarks of Microsoft Corp.  
SMBus is a trademark of Intel Corp.

### Features

- Windows 2000/XP- and Windows Vista (32-Bit)-Compatible Software
- USB-PC Connection (Cable Included)
- USB Powered
- Lead(Pb)-Free and RoHS Compliant
- 5-Pin Signal Header
- SMBus™/I2C Interface Terminals
- Proven PCB Layout
- Fully Assembled and Tested

DESIGNATION	QTY	DESCRIPTION
JU5–JU9	0	Not installed, 2-pin headers—shorted (PCB trace)
LED1	1	Red LED (0805)
L1	1	Ferrite bead TDK MMZ1608R301A (0603)
R1, R2	2	27Ω ±5% resistors (0603)
R3	1	1.5kΩ ±5% resistor (0603)
R4	1	470Ω ±5% resistor (0603)
R5	1	2.2kΩ ±5% resistor (0603)
R6	1	10kΩ ±5% resistor (0603)
R7, R8, R9	3	4.7kΩ ±5% resistors (0603)
R10	1	330Ω ±5% resistor (0603)
R19–R23	0	Not installed, resistors—short (PC trace) (0402)
U1	1	Precision temperature monitor (8 TDFN-EP*) Maxim MAX6604ATA+
U2	1	2.5V regulator (5 SC70) Maxim MAX8511EXK25+T (Top Mark: ADV)
U3	1	3.3V regulator (5 SC70) Maxim MAX8511EXK33+T (Top Mark: AEI)

\*EP = Exposed pad.



## Component List (continued)

DESIGNATION	QTY	DESCRIPTION
U4	1	Low-power microcontroller (68 QFN-EP*) Maxim MAXQ2000-RAX+
U5	1	UART-to-USB converter (32 TQFP)
U6	1	93C46 type 3-wire EEPROM 16-bit architecture (8 SO)
Y2	1	16MHz crystal (HCM49) Hong Kong X'tals SSM1600000E18FAF

DESIGNATION	QTY	DESCRIPTION
Y3	0	Not installed
Y4	1	6MHz crystal (HCM49) Hong Kong X'tals SSL6000000E18FAF
—	4	Shunts
—	1	USB high-speed A-to-B cables, 6ft
—	1	PCB: MAX6604 Evaluation Kit+

\*EP = Exposed pad.

## Component Suppliers

SUPPLIER	PHONE	WEBSITE
Hong Kong X'tals Ltd.	852-35112388	www.hongkongcrystal.com
Murata Electronics North America, Inc.	770-436-1300	www.murata-northamerica.com
Taiyo Yuden	800-348-2496	www.t-yuden.com
TDK Corp.	847-803-6100	www.component.tdk.com

**Note:** Indicate that you are using the MAX6604 when contacting these component suppliers.

## MAX6604 EV Kit Files

FILE	DESCRIPTION
MAX6604EVKIT.exe	Application program
FTD2XX.INF	USB device driver file
UNINST.INI	Uninstalls the EV kit software
USB_Driver_Help.PDF	USB driver installation help file

## Quick Start

### Required Equipment

- MAX6604 EV kit (USB cable included)
- A user-supplied Windows 2000/XP- or Windows Vista-compatible PC with a spare USB port

**Note:** In the following sections, software-related items are identified by bolding. Text in **bold** refers to items directly from the EV kit software. Text in **bold and underlined** refers to items from the Windows operating system.

### Procedure

The MAX6604 EV kit is fully assembled and tested. Follow the steps below to verify board operation:

- 1) Visit [www.maximintegrated.com/evkit-software](http://www.maximintegrated.com/evkit-software) to download the latest version of the EV kit software, 6604Rxx.ZIP. Save the EV kit software to a temporary folder and uncompress the ZIP file.
- 2) Install the EV kit software on your computer by running the 6604Rxx.msi program inside the temporary folder. The program files are copied and icons are created in the Windows **Start | Programs** menu.
- 3) Verify that all jumpers (JU1–JU9) are in their default positions, as shown in Table 1.

**Table 1. MAX6604 EV Kit Jumper Descriptions (JU1–JU9)**

JUMPER	SIGNAL	SHUNT POSITION	DESCRIPTION
JU1	A0	1-2	A0 = VDDIO; determines I <sup>2</sup> C device address (see Table 2)
		2-3*	A0 = GND; determines I <sup>2</sup> C device address (see Table 2)
JU2	A1	1-2	A1 = VDDIO; determines I <sup>2</sup> C device address (see Table 2)
		2-3*	A1 = GND; determines I <sup>2</sup> C device address (see Table 2)
JU3	A2	1-2	A2 = VDDIO; determines I <sup>2</sup> C device address (see Table 2)
		2-3*	A2 = GND; determines I <sup>2</sup> C device address (see Table 2)
JU4	EVENT	1-2*	EVENT is pulled up to VDDIO by R9
		Open	EVENT is not pulled up
JU5	SDA	Not installed*	SDA connected to on-board I <sup>2</sup> C bus
		PCB trace cut open	SDA must be connected to an external I <sup>2</sup> C bus
JU6	SCL	Not installed*	SCL connected to on-board I <sup>2</sup> C bus
		PCB trace cut open	SCL must be connected to an external I <sup>2</sup> C bus
JU7	SDA	Not installed*	SDA connected to on-board pullup resistor
		PCB trace cut open	SDA pullup resistor must be provided externally
JU8	SCL	Not installed*	SCL connected to on-board pullup resistor
		PCB trace cut open	SCL pullup resistor must be provided externally
JU9	EVENT	Not installed*	EVENT connected to MINIQUSB GPIO K1
		PCB trace cut open	EVENT not connected to MINIQUSB

\*Default position.

- 4) Connect the USB cable from the PC to the EV kit board. A **New Hardware Found** window pops up when installing the USB driver for the first time. If you do not see a window that is similar to the one described above after 30s, remove the USB cable from the board and reconnect it. Administrator privileges are required to install the USB device driver on Windows.
- 5) Follow the directions of the **Add New Hardware Wizard** to install the USB device driver. Choose the **Search for the best driver for your device** option. Specify the location of the device driver to be **C:\Program Files\MAX6604** (default installation directory) using the **Browse** button. During device driver installation, Windows may show a warning message indicating that the device driver Maxim uses does not contain a digital signature. This is not an error condition and it is safe to proceed with installation. Refer to the **USB\_Driver\_Help.PDF** document included with the software for additional information.
- 6) Start the MAX6604 EV kit software by opening its icon in the **Start | Programs** menu. The EV kit software main window appears, as shown in Figure 1.
- 7) The temperature alarms are active because the threshold temperatures have not been set. The following examples assume room temperature is between +24°C and +25°C. The actual room temperature is displayed in the **0x05 Temperature Register** group box.
- 8) In the **0x04 Critical-Temperature Trip Register** group box, enter the value **27.000** (a value above room temperature) and press the **Write** button. The temperature register should indicate **Critical Temperature OK**.
- 9) In the **0x02 Alarm-Temperature Upper-Boundary Trip Register** group box, enter the value **26.000** (a value above room temperature) and press the **Write** button. The **0x05 Temperature Register** group box should indicate **Alarm Temperature Upper Boundary OK**.
- 10) In the **0x03 Alarm-Temperature Lower-Boundary Trip Register** group box, enter the value **24.000** (a value below room temperature) and press the **Write** button. The **0x05 Temperature Register** group box should indicate **Alarm Temperature Lower Boundary OK**.

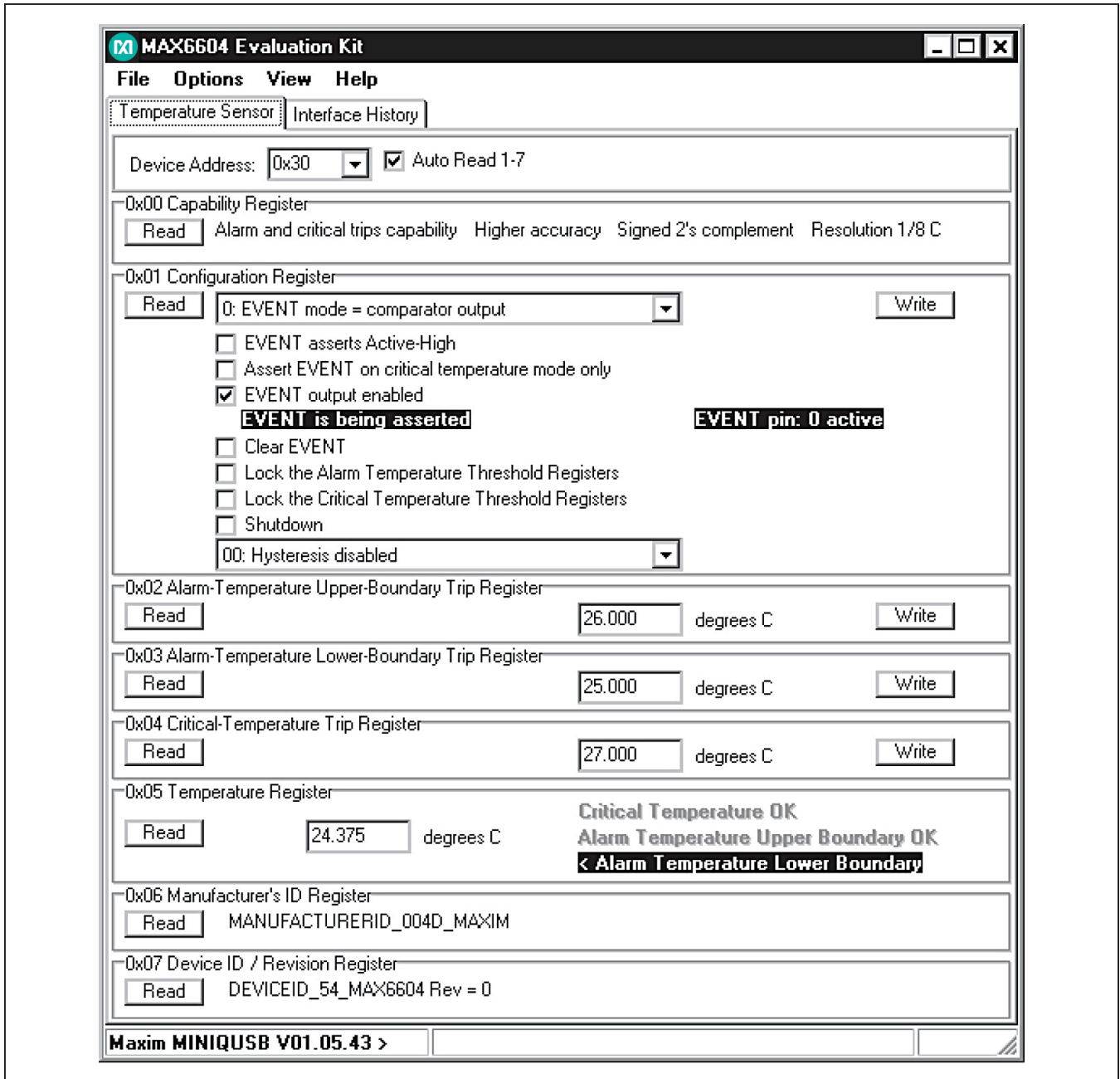

Figure 1. MAX6604 EV Kit Software Main Window (Temperature Sensor Tab)

- 11) In the **0x01 Configuration Register** group box, check the **EVENT output enabled** checkbox and press the **Write** button.
- 12) Apply an external heat source to the MAX6604, sufficient to cross the programmed temperature

thresholds. The alarm is indicated by the INT pin being asserted and by the status indicators in the **0x05 Temperature Register** group box (alarm can also be tested by setting the threshold value below the measured temperature, as shown in Figure 1).

- 13) Return the MAX6604 to room temperature and the alarm condition automatically clears.
- 14) Chill the MAX6604 sufficient to cross the programmed alarm temperature lower-boundary trip threshold. The alarm is indicated by the INT pin being asserted and by the status indicators in the **0x05 Temperature Register group** box.
- 15) Return the MAX6604 to room temperature and the alarm condition automatically clears.

### Detailed Description of Software

The main window of the evaluation software (Figure 1) displays the registers of the MAX6604 temperature sensor. Each register has a **Read** button, and each writeable register has a **Write** button. The status of the EVENT output pin is displayed inside the **0x01 Configuration Register** group box, next to the **EVENT output enabled** checkbox.

### Temperature Sensor Tab

The **Temperature Sensor** tab sheet displays the temperature sensor registers of the MAX6604 (Figure 1). Each register has its own **Read** button, and each writeable register has a **Write** button. The **Auto Read 1-7** checkbox enables periodic polling of all register values. The software determines the **Device Address** when first starting up, by searching all eight possible I2C device addresses. This value must be manually changed if the JU1, JU2, and JU3 address-select jumpers are changed while the program is running.

### Advanced User Interface

A serial interface can be used by advanced users by selecting **Options | Interface (Advanced Users)** from the menu bar. **Note:** The MAX6604 JEDEC read-word and write-word byte order differs from the SMBusReadWord and SMBusWriteWord protocols.

For reading I2C registers, click on the **2-wire interface** tab shown in Figure 2. Press the **Hunt for active listen-**

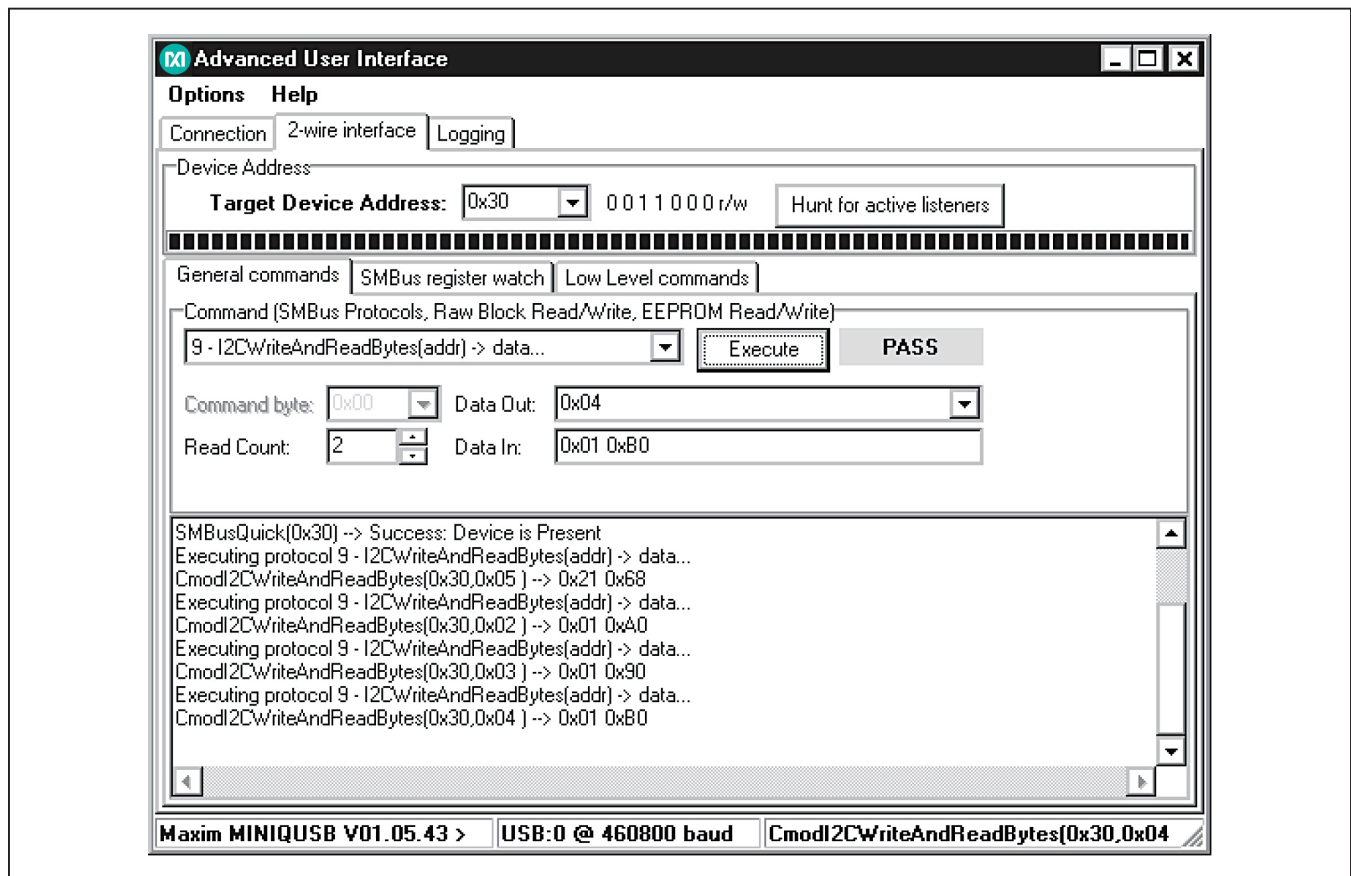

Figure 2. Advanced User Interface Window (2-Wire Interface Tab)

**Table 2. I<sup>2</sup>C Device Address Selection**

SHUNT POSITION (JU3)	A2 PIN	SHUNT POSITION (JU2)	A1 PIN	SHUNT POSITION (JU1)	A0 PIN	DEVICE ADDRESS
2-3*	GND	2-3*	GND	2-3*	GND	0011 000 R/W
2-3	GND	2-3	GND	1-2	VDDIO	0011 001 R/W
2-3	GND	1-2	VDDIO	2-3	GND	0011 010 R/W
2-3	GND	1-2	VDDIO	1-2	VDDIO	0011 011 R/W
1-2	VDDIO	2-3	GND	2-3	GND	0011 100 R/W
1-2	VDDIO	2-3	GND	1-2	VDDIO	0011 101 R/W
1-2	VDDIO	1-2	VDDIO	2-3	GND	0011 110 R/W
1-2	VDDIO	1-2	VDDIO	1-2	VDDIO	0011 111 R/W

\*Default position

ers button to obtain the current MAX6604 slave address in the **Target Device Address:** combo box. In the **General commands** tab, select **9 - I2CWriteAndReadBytes(addr) -> data...** in the **Command (SMBus Protocols, Raw Block Read/Write, EEPROM Read/Write)** drop-down list. Set the **Read Count:** to **2**, enter the desired register into the **Data Out:** combo box, and then press the **Execute** button.

For writing I<sup>2</sup>C registers, click on the **2-wire interface** tab shown in Figure 2. Press the **Hunt for active listeners** button to obtain the current MAX6604 slave address in the **Target Device Address:** combo box. In

the **General commands** tab, select **7 - RawWriteBlock (addr,count,data...)** in the **Command (SMBus Protocols, Raw Block Read/Write, EEPROM Read/Write)** drop-down list. In the **Data Out:** combo box, fill in the register address, the high byte, and the low byte of data; and then press the **Execute** button.

### Detailed Description of Hardware

The MAX6604 EV kit provides a proven layout for the MAX6604. Easy-to-use USB-PC connection is included on the EV kit.

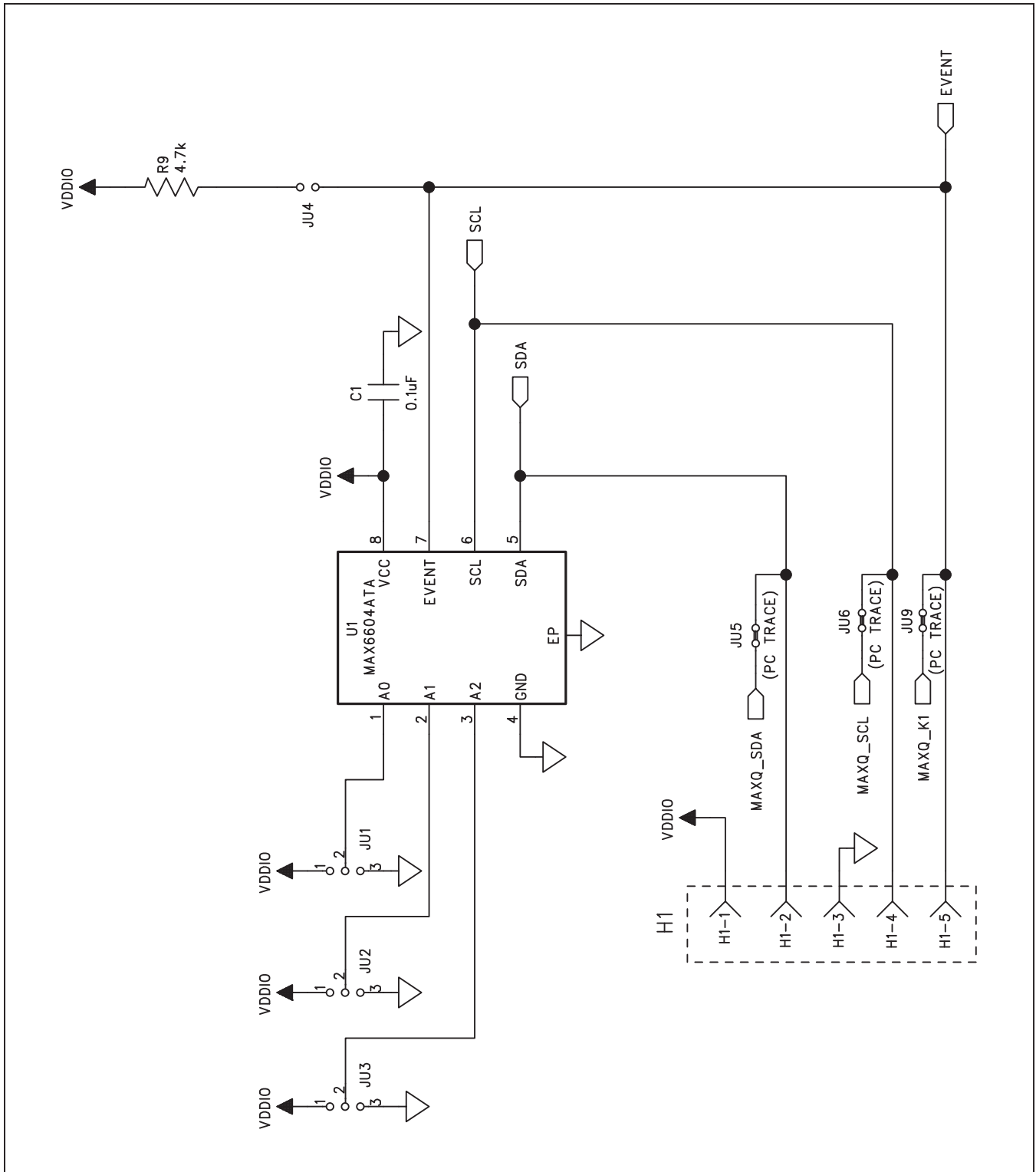

Figure 3a. MAX6604 EV Kit Schematic (Sheet 1 of 2)



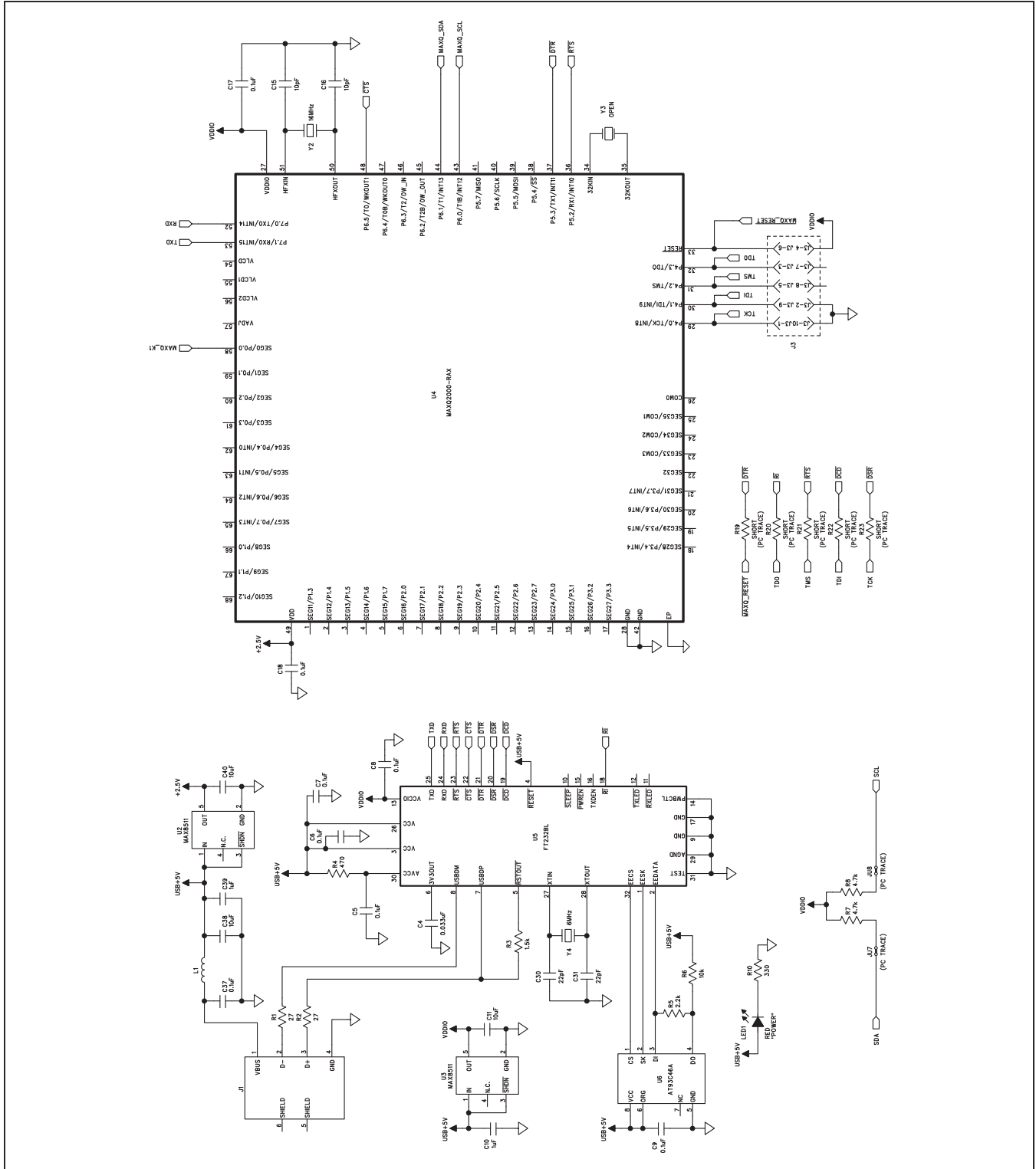

Figure 3b. MAX6604 EV Kit Schematic (Sheet 2 of 2)



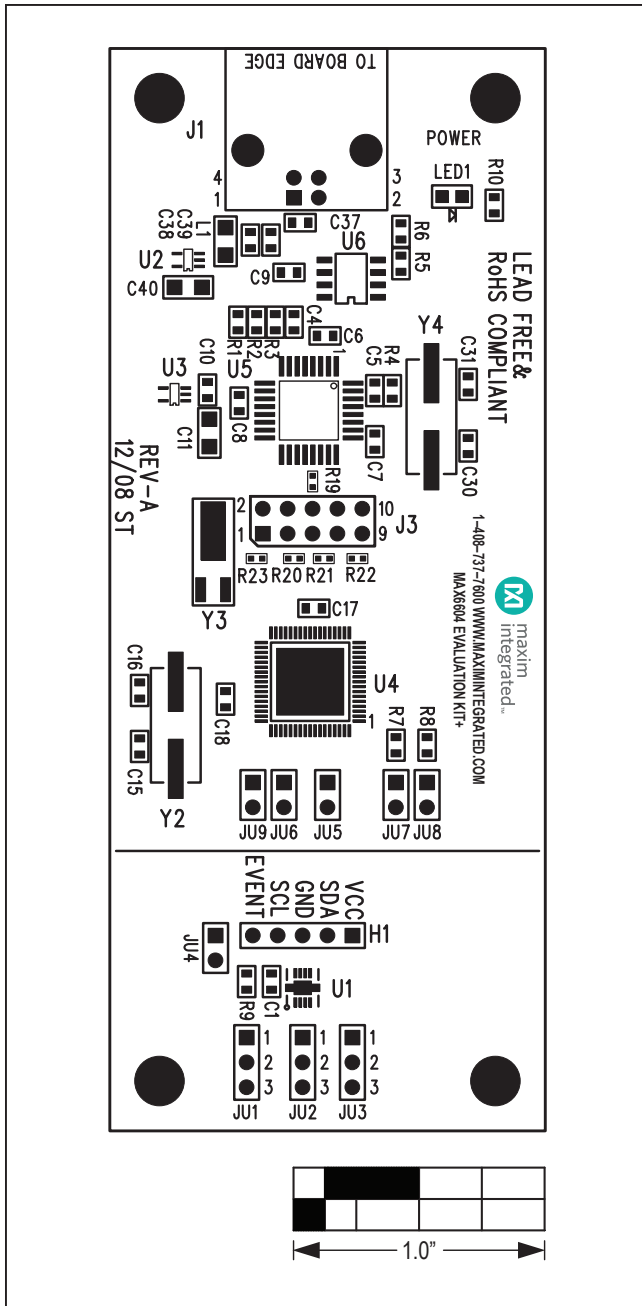

Figure 4. MAX6604 EV Kit Component Placement Guide—Component Side

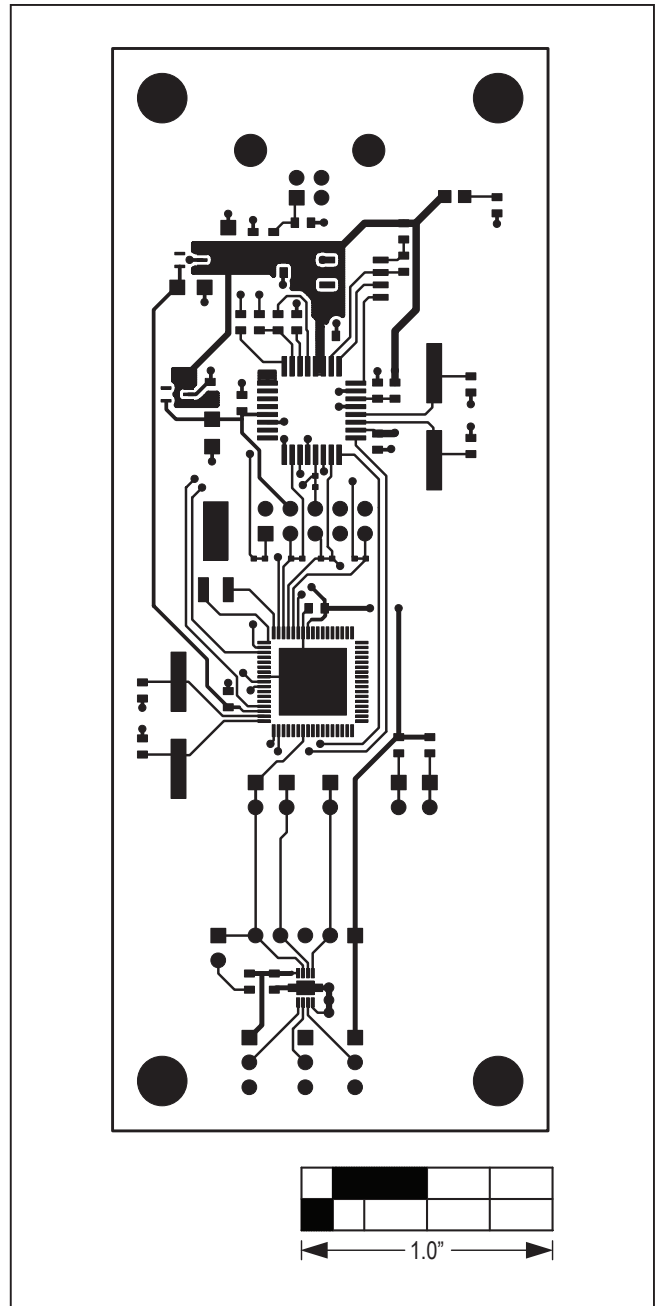

Figure 5. MAX6604 EV Kit PCB Layout—Component Side

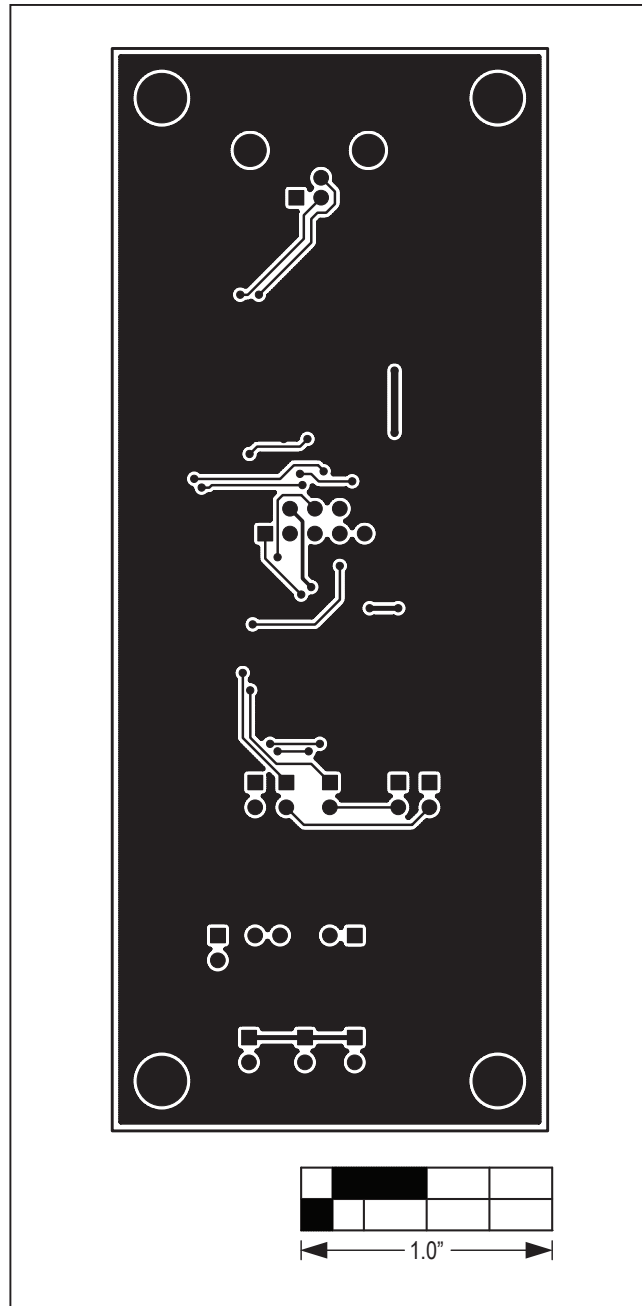

Figure 6. MAX6604 EV Kit PCB Layout—Solder Side

## Revision History

REVISION NUMBER	REVISION DATE	DESCRIPTION	PAGES CHANGED
0	5/09	Initial release	—
1	10/20	Replaced + with # in <i>Ordering Information</i>	1

For pricing, delivery, and ordering information, please visit Maxim Integrated's online storefront at <https://www.maximintegrated.com/en/storefront/storefront.html>.

*Maxim Integrated cannot assume responsibility for use of any circuitry other than circuitry entirely embodied in a Maxim Integrated product. No circuit patent licenses are implied. Maxim Integrated reserves the right to change the circuitry and specifications without notice at any time.*