



MAX6965 Evaluation Kit/ Evaluation System

Evaluate: MAX6965

General Description

The MAX6965 evaluation kit (EV kit) is a fully assembled and tested circuit board that demonstrates the capabilities of the MAX6965 9-output LED driver with intensity control and hot-insertion protection. The MAX6965 EV kit also includes Windows® 98SE/2000/XP-compatible software, which provides a simple graphics user interface (GUI) for using the MAX6965's features.

The MAX6965 evaluation system (EV system) includes a MAX6965 EV kit and a Maxim CMAXQUSB serial-interface board.

The CMAXQUSB board connects to a PC's USB port and allows the transfer of I²C commands to the MAX6965 EV kit.

Component Suppliers

SUPPLIER	PHONE	WEBSITE
TDK	847-803-6100	www.component.tdk.com

Note: Indicate you are using the MAX6965 when contacting the component supplier.

Windows is a registered trademark of Microsoft Corp.

Features

- ◆ 400kHz, 5.5V-Tolerant, 2-Wire Serial Interface
- ◆ 2V to 3.6V Operation
- ◆ High Output Current—Each Port 50mA (max)
- ◆ 7V-Rated, Open-Drain Outputs
- ◆ Proven PC Board Layout
- ◆ Windows 98SE/2000/XP-Compatible Evaluation Software
- ◆ Fully Assembled and Tested
- ◆ EV System Includes USB Connectivity

Ordering Information

PART	TYPE	INTERFACE
MAX6965EVKIT	EV kit	User-supplied I ² C interface
MAX6965EVCMAXQU	EV system	CMAXQUSB board

Note: The MAX6965 EV kit software is included with the MAX6965 EV kit, but is designed for use with the complete EV system. The EV system includes both the Maxim CMAXQUSB board and the EV kit. If the Windows software will not be used, the EV kit board can be purchased without the Maxim CMAXQUSB board.

Component List

MAX6965 EV System

PART	QTY	DESCRIPTION
MAX6965EVKIT	1	MAX6965 EV kit
CMAXQUSB	1	Serial-interface board

MAX6965 EV Kit

DESIGNATION	QTY	DESCRIPTION
C1	1	0.1μF ±15%, 10V X7R ceramic capacitor (0603) TDK C1608X7R1H104K
C2, C3	2	10μF ±15%, 10V X5R ceramic capacitors (0805) TDK C2012X5R1A106M
D1, D2	2	RGB LEDs (2.8mm x 3.2mm)
D3, D4	2	White LEDs (PLCC-2)
J1	1	2 x 10 right-angle female receptacle
JU1–JU4, JU7	5	3-pin headers

MAX6965 EV Kit

DESIGNATION	QTY	DESCRIPTION
JU5	1	5-pin header
JU6	1	2-pin header
R1, R4	2	270Ω ±5% resistors (0603)
R2, R5	2	240Ω ±5% resistors (0603)
R3, R6	2	160Ω ±5% resistors (0603)
R7, R8	2	100kΩ ±5% resistors (0603)
R9, R10	2	180Ω ±5% resistors (0603)
R11, R12	0	Not installed (0603)
R13	1	2kΩ ±5% resistor (0603)
R14, R15	2	10kΩ ±5% resistors (0603)
S1, S2	0	Not installed
U1	1	MAX6965ATE (16-pin TQFN, 3mm x 3mm x 0.8mm)
—	7	Shunts
—	1	MAX6965 EV kit PC board



MAX6965 Evaluation Kit/ Evaluation System

MAX6965 EV Kit Files

FILE	OPERATION
INSTALL.EXE	Installs the EV kit files on your computer
MAX6965.EXE	Application program
FTD2XX.INF	USB device driver file
UNINST.INI	Uninstalls the EV kit software
TROUBLESHOOTING_USB.PDF	USB driver installation help file

Quick Start

Recommended Equipment

- One 7VDC, 1A power supply
- The MAX6965 EV system
 - MAX6965 EV kit
 - Maxim CMAXQUSB board
 - USB cable (included with CMAXQUSB)
- A user-supplied Windows 98SE/2000/XP PC with a spare USB port

Note: In the following section(s), software-related items are identified by bolding. Text in **bold** refers to items directly from the EV kit software. Text in **bold and underline** refers to items from the Windows 98SE/2000/XP operating system.

Procedure

Do not turn on the power supply until all connections are made.

- 1) Visit the Maxim Integrated Products website (www.maxim-ic.com/evkitssoftware) to download the most recent revision of the EV kit software 6965Rxx.ZIP.
- 2) Install the MAX6965 evaluation software on your computer by running the INSTALL.EXE program. The program files are copied and icons are created in the Windows **Start** menu.
- 3) On the CMAXQUSB board, ensure the shunt of JU1 is in the 3.3V position.
- 4) Enable the I²C pullup resistors on the CMAXQUSB board by setting the DIP switches SW1 to the ON position.
- 5) For the MAX6965 EV kit, make sure the shunts of all jumpers are in the following default positions (Table 1).

Table 1. Jumper Default Positions

JUMPER	FUNCTION
JU1: (2-3)	Blink phase 0
JU2: (1-2)	Normal operation
JU3: (1-2)	O7 output drives the white LED D3
JU4: (1-2)	O6 output drives the white LED D4
JU5: (1-2)	I ² C slave address is 0x48
JU6: (Open)	O8 is a normal output
JU7: (2-3)	CMAXQUSB provides the V+ power supply

- 6) Carefully connect the boards by aligning the MAX6965 EV kit's 20-pin connector with the 20-pin connector of the CMAXQUSB board.
- 7) Connect the 7V DC power supply between the MAX6965 EV kit's VDD and GND pads.
- 8) Turn on the 7V DC power.
- 9) Connect the USB cable from the PC to the CMAXQUSB board. A **Building Driver Database** window pops up in addition to a **New Hardware Found** message if this is the first time the EV kit board is connected to the PC. Otherwise, skip to step 11. If you do not see a window that is similar to the one described above after 30 seconds, remove the USB cable from the CMAXQUSB and reconnect it. Administrator privileges are required to install the USB device driver on Windows 2000/XP. Refer to the document TROUBLESHOOTING_USB.PDF included with the software if you have any problems during this step.
- 10) Follow the directions of the **Add New Hardware Wizard** to install the USB device driver. Choose the **Search for the best driver for your device** option. Specify the location of the device driver to be **C:\Program Files\MAX6965** (default installation directory) using the **Browse** button.
- 11) Start the MAX6965 EV kit software by opening its icon in the **Start** menu. The GUI main window appears as shown in Figure 1.
- 12) Switch to tab **LED Config/Status**. Click the **Red**, **Green**, and **Blue** checkboxes at the right of the **Blink Phase 0** labels as shown in Figure 2. Observe the change of D1 and D2 on the EV kit board.

Detailed Description of Software

To start the MAX6965 EV kit software, double-click the MAX6965 EV kit icon that was created during installation. The GUI main window appears as shown in Figure 1. Wait approximately two seconds while the MAX6965 EV kit software connects to the CMAXQUSB board.

MAX6965 Evaluation Kit/ Evaluation System

Evaluate: MAX6965

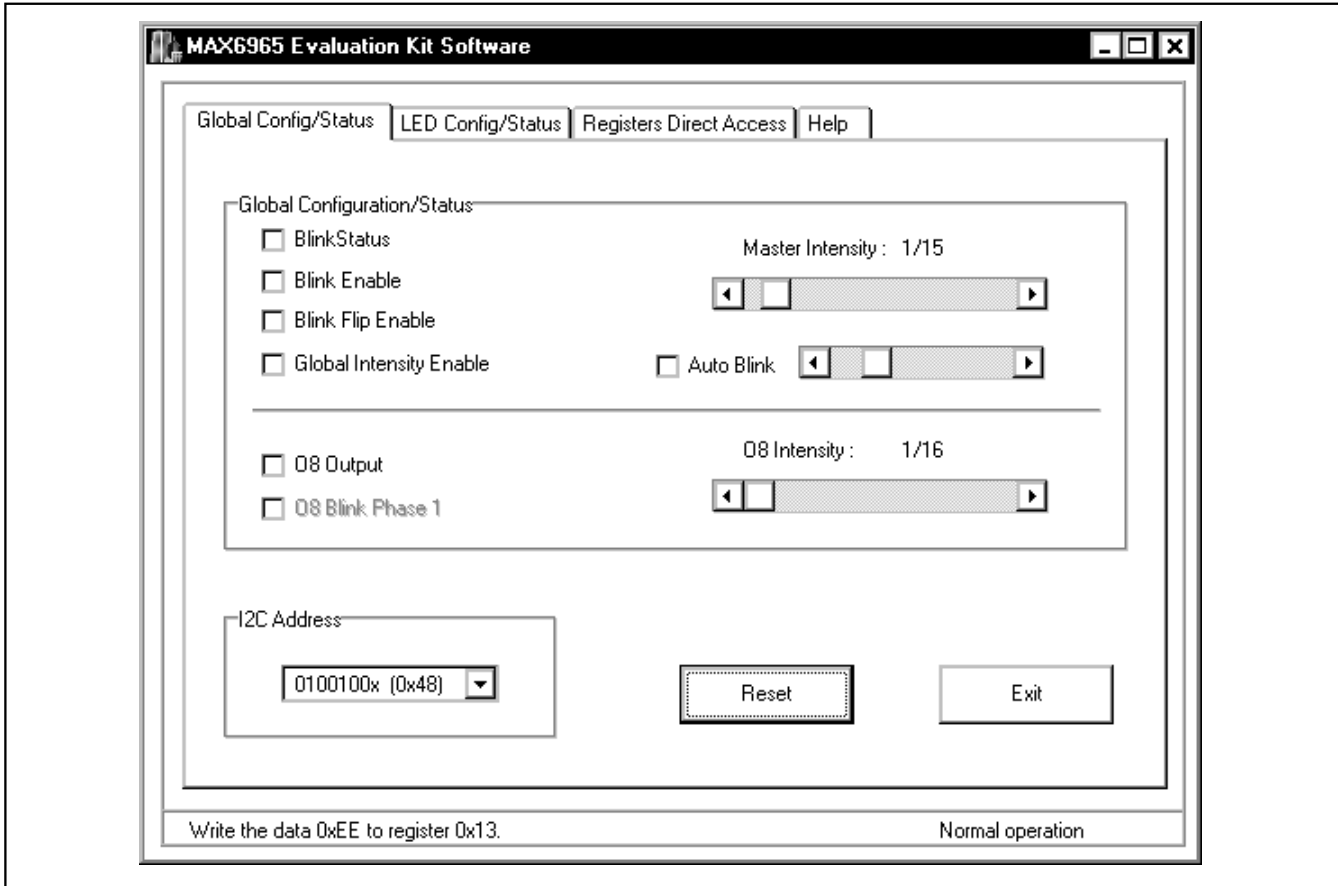

Figure 1. MAX6965 Evaluation Software Main Window (Global Config/Status Tab)

There are four tabs on the MAX6965 EV kit GUI software. They are **Global Config/Status**, **LED Config/Status**, **Registers Direct Access**, and **Help**.

Global Config/Status Tab

The **Global Config/Status** tab shown in Figure 1 contains the **Global Configuration/Status** group box, the **I2C Address** pull-down menu, as well as **Reset** and **Exit** buttons.

The **Global Configuration/Status** group box represents the **Global Configuration/Status** and **Master/O8 Intensity** registers. The **Auto Blink** checkbox is a software-driven feature.

The **I2C Address** pull-down menu autodetects the MAX6965's I2C slave address when the GUI software starts. If multiple devices are connected to the I2C bus, the user can use this pull-down menu to manually change the device's I2C slave address according to the shunt position of JU5 as shown in Table 2.

Table 2. The I2C Address Configuration

JUMPER	SHUNT POSITION	I2C ADDRESS
JU5	1-2*	0100100x (0x48)
	1-3	0100000x (0x40)
	1-4	1100000x (0xC0)
	1-5	1100100x (0xC8)

*Default position.

Press the **Reset** button to reset the MAX6965 EV kit hardware and the GUI software to the default settings. Press the **Exit** button to quit the MAX6965 EV kit GUI software.

MAX6965 Evaluation Kit/ Evaluation System

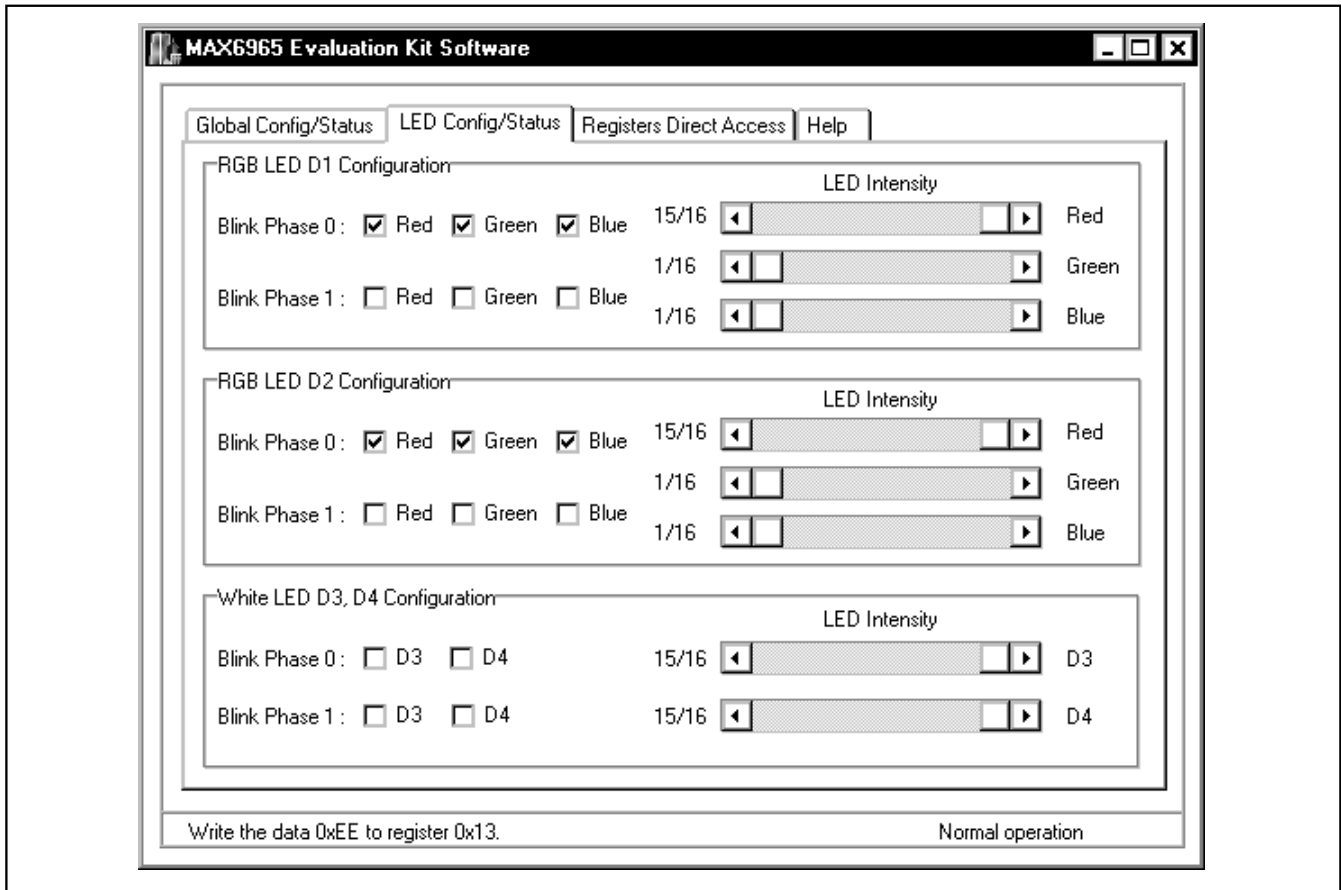

Figure 2. LED Config/Status Tab

LED Config/Status Tab

The **LED Config/Status** tab shown in Figure 2 contains the **RGB LED D1 Configuration**, the **RGB LED D2 Configuration**, and the **White LED D3, D4 Configuration** group boxes. These three group boxes represent the blink phase 0, blink phase 1, and output intensity registers. They directly control LEDs D1, D2, D3, and D4.

MAX6965 Evaluation Kit/ Evaluation System

Registers Direct Access Tab

The **Registers Direct Access** tab, shown in Figure 3, contains all nine of the MAX6965's registers, as well as **Read** and **Write** buttons. Customers can directly access all registers within this tab.

Help Tab

The **Help** tab contains the MAX6965 EV kit software revision and Maxim's website information.

Evaluate: MAX6965

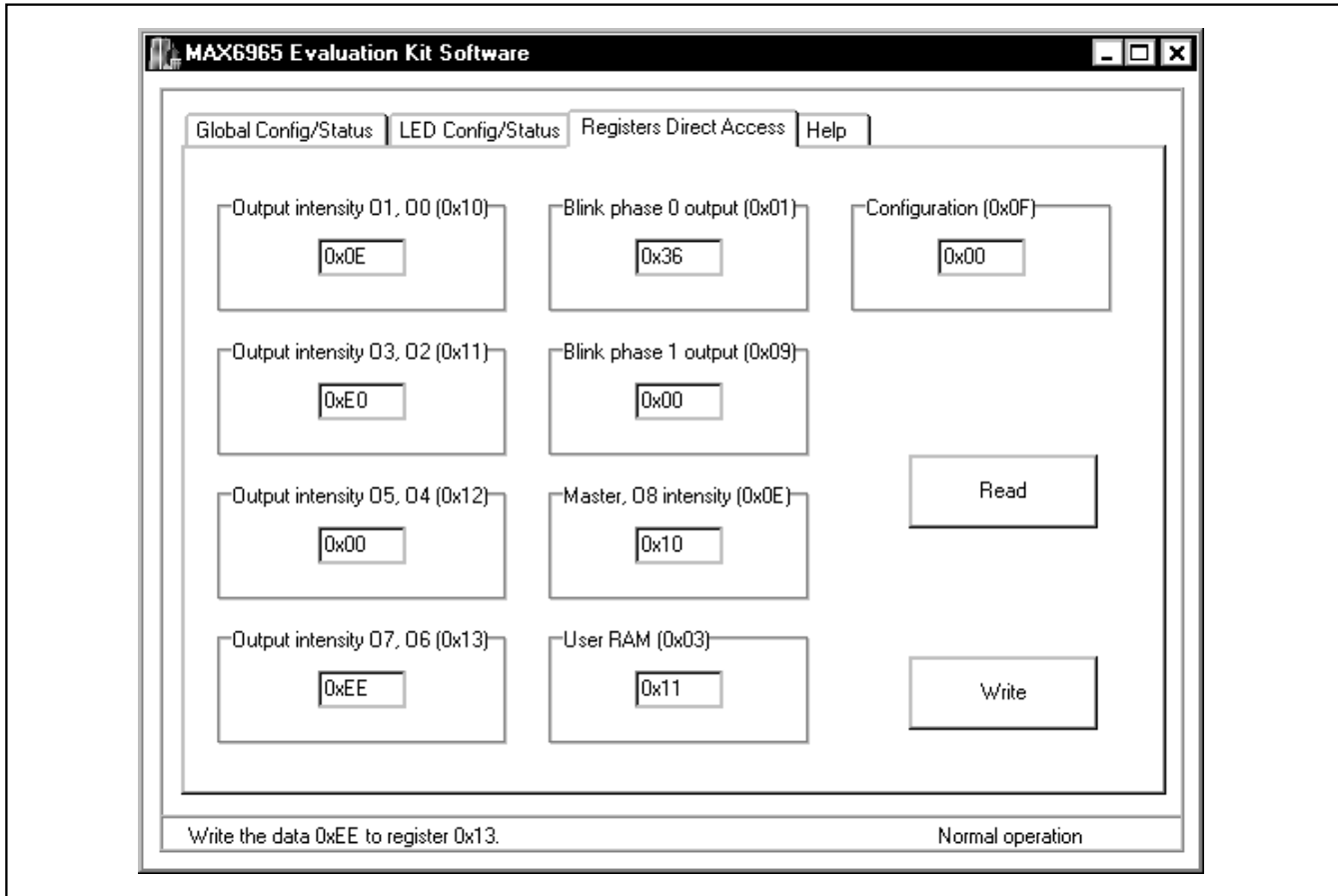

Figure 3. Registers Direct Access Tab

MAX6965 Evaluation Kit/ Evaluation System

Detailed Description of Hardware

The MAX6965 is a 9-output LED driver with intensity control and hot-insertion protection. The MAX6965 EV kit board provides a proven layout for evaluating the MAX6965. The EV kit comes with a MAX6965ATE installed.

Blink Control

Jumper JU1 controls the blink function of the MAX6965 EV kit as shown in Table 3. Make sure the **Blink Enable** checkbox on the **Global Config/Status** tab is checked to enable the blink function.

Table 3. Blink Jumper Configuration

JUMPER	SHUNT POSITION	DESCRIPTION
JU1	1-2	Blink phase 1
	2-3*	Blink phase 0
	Open	Blink phase controlled by BLINK pad

*Default position.

Hardware Reset Control

The hardware reset function is controlled by jumper JU2 as shown in Table 4. Putting the shunt on position 2-3 resets all registers and puts the device in the power-on reset state.

Table 4. \overline{RST} Jumper Configuration

JUMPER	SHUNT POSITION	DESCRIPTION
JU2	1-2*	Normal operation
	2-3	Reset
	Open	Controlled by the \overline{RST} pad

*Default position.

I²C Address Configuration

The shunt position of jumper JU5 determines the I²C slave address of the MAX6965 EV kit. See Table 2 to select the appropriate setting.

Reserved Jumper Settings

Jumpers JU3, JU4, and JU6 are reserved for evaluating the MAX7315 and MAX7316. Leave the shunt on default positions, as shown in Table 5, to evaluate the MAX6965.

Table 5. Jumper JU3, JU4, and JU6 Configuration

JUMPER	SHUNT POSITION	DESCRIPTION
JU3	1-2*	O7 output drives the white LED D3.
	2-3	Evaluates P7 as input (MAX7315/MAX7316)**.
	Open	Use O7 pad to evaluate this I/O pin.
JU4	1-2*	O6 output drives the white LED D4.
	2-3	Evaluates P6 as input (MAX7315/MAX7316)**.
	Open	Use O6 pad to evaluate this I/O pin.
JU6	1-2	INT signal routed to J1**.
	Open*	Use O8 pad to evaluate this I/O pin.

*Default position.

**Hardware support only.

Power Supplies

The power supply for all LEDs must be powered by a user-provided 0 to 7V power supply, which connects to VDD. The MAX6965 can be either powered from the CMAXQUSB or from a user-supplied 2.0V to 3.6V power supply, which connects to VCC, as shown in Table 6.

Table 6. V+ Selection Configuration

JUMPER	SHUNT POSITION	DESCRIPTION
JU7	1-2	User-provided 2.0V to 3.6V power supply (VCC)
	2-3*	Powered by CMAXQUSB

*Default position.

MAX6965 Evaluation Kit/ Evaluation System

Evaluate: MAX6965

User-Supplied I²C Interface

To use the MAX6965 EV kit with a user-supplied I²C interface, install the shunt on jumper JU7's 1-2 position. Connect SDA, SCL and GND lines from the user-supplied I²C interface to the SDA, SCL, and GND pads on the MAX6965 EV kit. Apply a 2.0V to 3.6V power supply to the VCC pad of the MAX6965 EV kit. Depending on the configuration of the user-supplied I²C interface, it may be necessary to install the I²C pullup resistors R11 and R12.

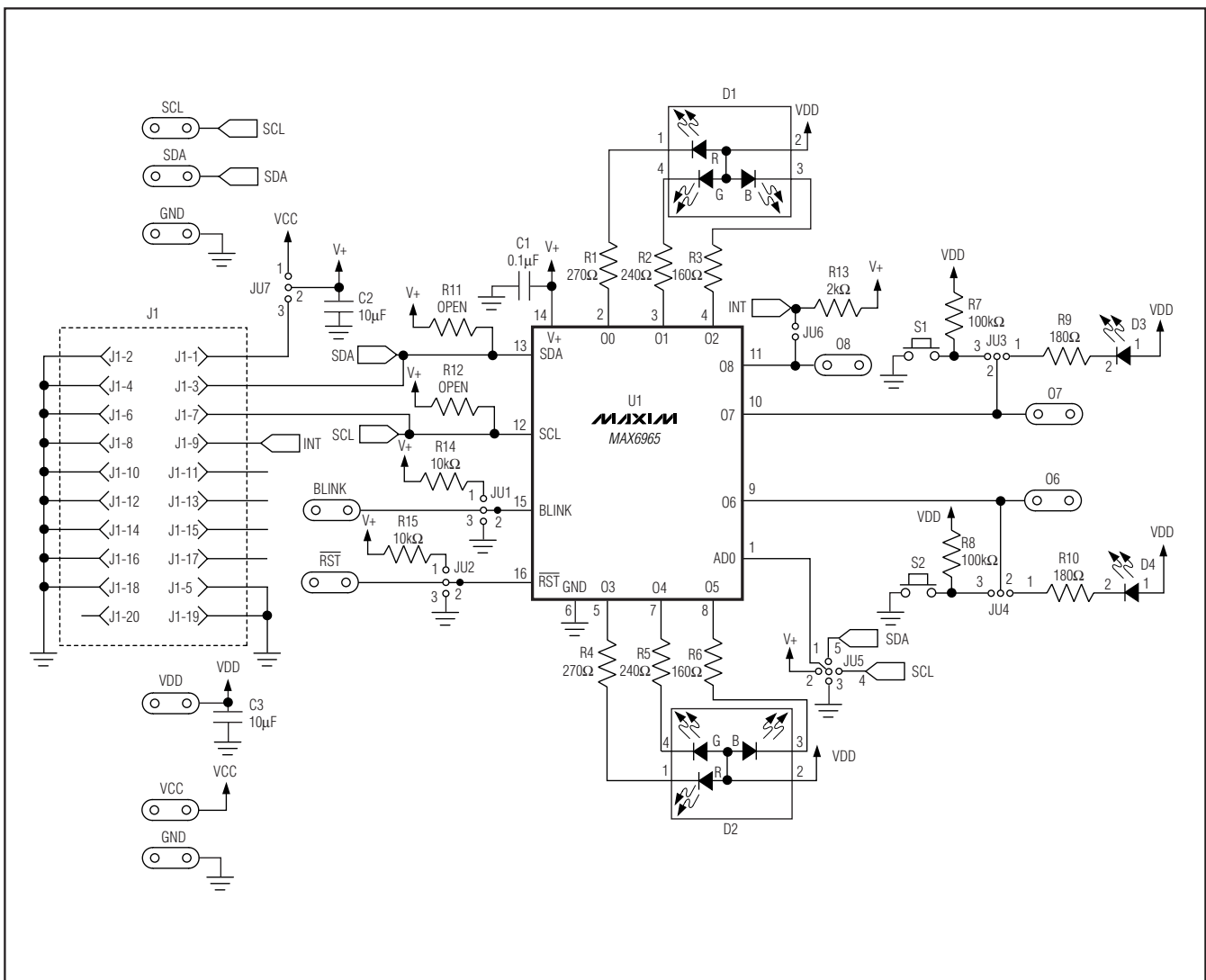

Figure 4. MAX6965 EV Kit Schematic

MAX6965 Evaluation Kit/ Evaluation System

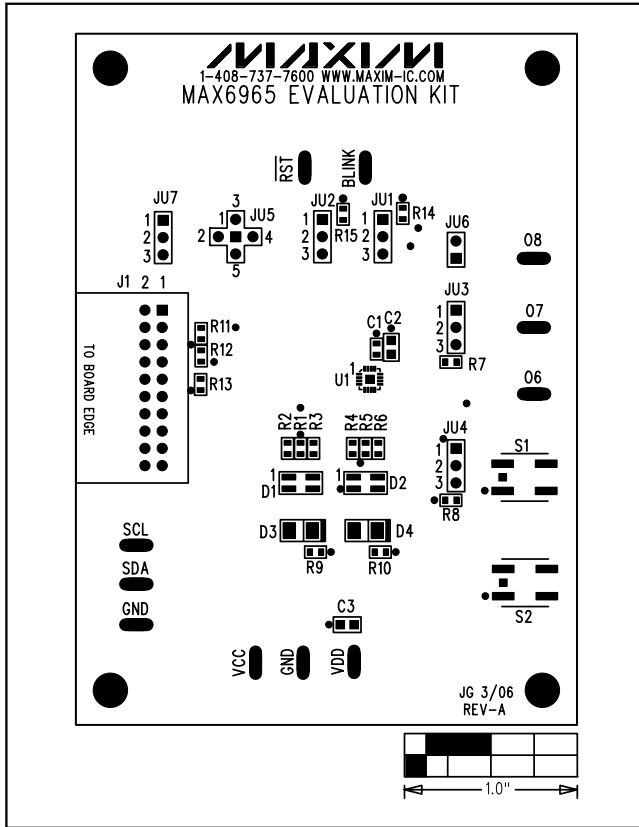

Figure 5. MAX6965 EV Kit Component Placement Guide—Component Side

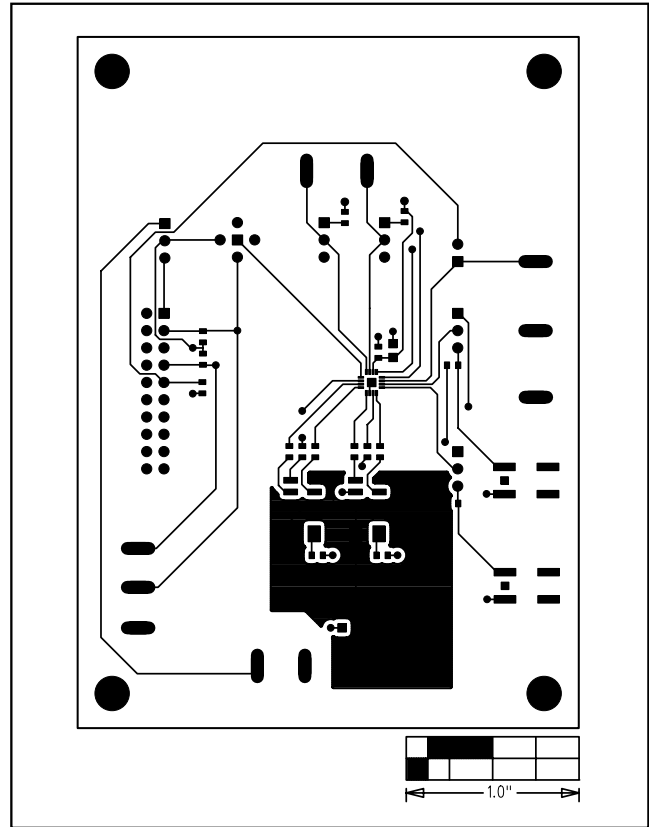

Figure 6. MAX6965 EV Kit PC Board Layout—Component Side

MAX6965 Evaluation Kit/ Evaluation System

Evaluate: MAX6965

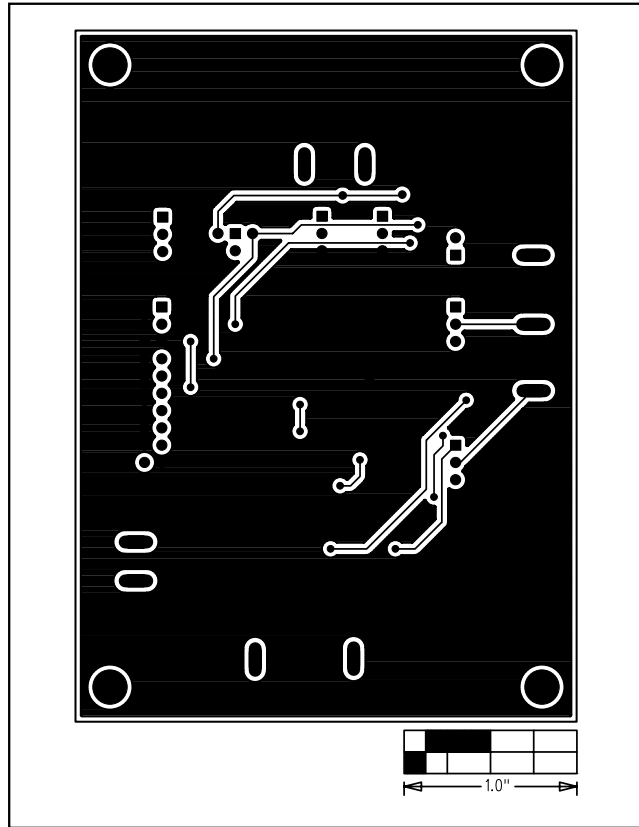

Figure 7. MAX6965 EV Kit PC Board Layout—Solder Side

Maxim cannot assume responsibility for use of any circuitry other than circuitry entirely embodied in a Maxim product. No circuit patent licenses are implied. Maxim reserves the right to change the circuitry and specifications without notice at any time.

Maxim Integrated Products, 120 San Gabriel Drive, Sunnyvale, CA 94086 408-737-7600 _____ 9