

MAX7389/MAX7390

Microcontroller Clock Generator with Watchdog

General Description

The MAX7389/MAX7390 replace ceramic resonators, crystals, and supervisory functions for microcontrollers in 3.3V and 5V applications.

The MAX7389/MAX7390 provide a clock source, reset, and watchdog functions. The watchdog timer is pin programmable and provides watchdog timeout values in the 16ms to 2048ms range. The MAX7389 provides a separate watchdog output that is used as a status indicator or to control safety-critical system elements.

The MAX7390 features a clock-speed select that reduces the output frequency by half. This functionality allows the microcontroller to operate at reduced power and may be used to extend the time available to perform housekeeping tasks, such as writing data to flash during a power failure.

The MAX7389/MAX7390 clock outputs are factory programmed to a frequency in the 1MHz to 16MHz range. Four standard frequencies are available. Other frequencies are available upon request. The maximum operating supply current is 5.5mA with a clock frequency of 12MHz.

Unlike typical crystal and ceramic resonator oscillator circuits, the MAX7389/MAX7390 are resistant to EMI and vibration, and operate reliably at high temperatures. The high-output drive current and absence of high-impedance nodes make the oscillator invulnerable to dirty or humid operating conditions.

The MAX7389/MAX7390 are available in an 8-pin μ MAX[®] package. The MAX7389/MAX7390 standard operating temperature range is from -40°C to +125°C.

Applications

- White Goods
- Appliances and Controls
- Handheld Products
- Portable Equipment
- Microcontroller Systems

μ MAX is a registered trademark of Maxim Integrated Products, Inc.

Pin Configurations

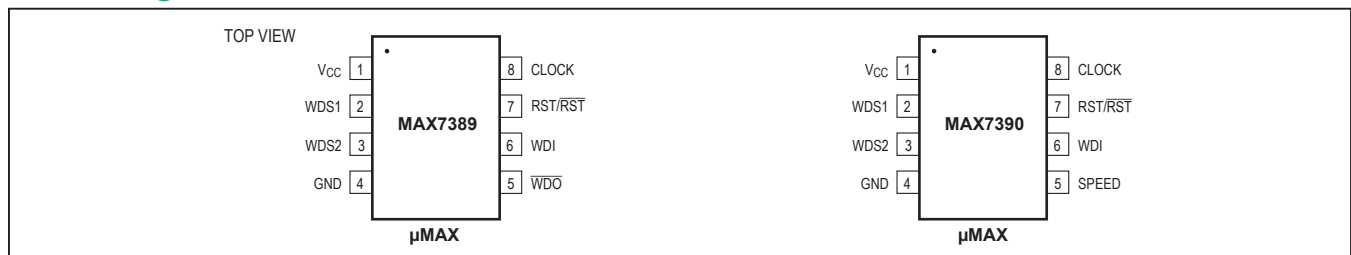

Features

- Robust Microcontroller Clock and Supervisor in a Single Package
- Integrated Reset and Watchdog Functions
- Pin-Programmable Watchdog Timeout
- Speed Select
- +2.7V to +5.5V Operation
- Factory-Trimmed Oscillator
- Reset Valid Down to 1.1V Supply Voltage
- ± 10 mA Clock-Output Drive Current
- $\pm 4\%$ Total Accuracy for -40°C to +125°C
- $\pm 2.75\%$ Total Accuracy for 0°C to +85°C
- 5.5mA Operating Current (12MHz Version)
- -40°C to +125°C Temperature Range
- 8-Pin μ MAX Surface-Mount Package
- 1MHz to 16MHz Factory Preset Frequency

Ordering Information

PART	TEMP RANGE	PIN-PACKAGE
MAX7389 _s rff	-40°C to +125°C	8 μ MAX
MAX7390 _s rff	-40°C to +125°C	8 μ MAX

Note: “s” is a placeholder for the reset output type. Insert the symbol found in Table 3 in the place of “s”. “r” is a placeholder for the power-on reset (POR) voltage. Insert the symbol found in Table 2 in the place of “r.” “ff” is a placeholder for the nominal output frequency. Insert the symbol found in Table 4 in the place of “ff.” For example, MAX7389CMTP describes a device with 4.38V reset level, open-collector RST output, and a clock output frequency of 8MHz.

Typical Application Circuit, Functional Diagram, and Selector Guide appear at end of data sheet.



Absolute Maximum Ratings

V _{CC} to GND	-0.3V to +6.0V	Operating Temperature Range.....	-40°C to +125°C
All Other Pins to GND	-0.3V to (V _{CC} + 0.3V)	Junction Temperature.....	+150°C
CLOCK, RST/ $\overline{\text{RST}}$, $\overline{\text{WDO}}$ Output Current	$\pm 50\text{mA}$	Storage Temperature Range.....	-65°C to +150°C
Continuous Power Dissipation (T _A = +70°C)		Lead Temperature (soldering, 10s)	+300°C
8-Pin μMAX (derate 4.5mW/°C over +70°C).....	362mW		

Stresses beyond those listed under "Absolute Maximum Ratings" may cause permanent damage to the device. These are stress ratings only, and functional operation of the device at these or any other conditions beyond those indicated in the operational sections of the specifications is not implied. Exposure to absolute maximum rating conditions for extended periods may affect device reliability.

Electrical Characteristics

(Typical Application Circuit, V_{CC} = +2.7V to +5.5V, T_A = -40°C to +125°C, 1MHz to 16MHz output frequency range, typical values at V_{CC} = +5.0V, T_A = +25°C, unless otherwise noted.) (Note 1)

PARAMETER	SYMBOL	CONDITIONS	MIN	TYP	MAX	UNITS
POWER REQUIREMENTS						
Operating Supply Voltage	V _{CC}		2.7		5.5	V
Valid RST/ $\overline{\text{RST}}$ Supply Voltage	V _{CCR}	T _A = 0°C to +85°C			1.1	V
		T _A = -40°C to +125°C			1.18	
Operating Supply Current	I _{CC}	f _{CLOCK} = 12MHz			5.5	mA
		f _{CLOCK} = 8MHz			4.5	
TRI-LEVEL ANALOG INPUTS: WDS1, WDS2						
Input-High Voltage Level			V _{CC} - 0.55V			V
Input-Middle Voltage Level			0.9	V _{CC} - 1.1V		V
Input-Low Voltage Level				0.45		V
LOGIC INPUT: WDI						
Input Leakage Current	I _{LEAK}	Input high			0.5	μA
Logic-Input High Voltage	V _{IH}		0.7 x V _{CC}			V
Logic-Input Low Voltage	V _{IL}			0.3 x V _{CC}		V
PUSH-PULL LOGIC OUTPUTS: RST/$\overline{\text{RST}}$						
Output High	V _{OH}	I _{SOURCE} = 1mA	V _{CC} - 1.5			V
Output Low	V _{OL}	I _{SINK} = 3mA		0.05	0.4	V
OPEN-DRAIN LOGIC OUTPUTS: $\overline{\text{RST}}$, PFO, $\overline{\text{WDO}}$						
Output Low	V _{OLO}	I _{SINK} = 3mA		0.05	0.4	V
OUTPUT: CLOCK						
Output High Voltage	V _{OHC}	I _{SOURCE} = 5mA	V _{CC} - 0.3			V
Output Low Voltage	V _{OLC}	I _{SINK} = 5mA		0.3		V
CLOCK Accuracy	f _{CLOCK}	T _A = 0°C to +85°C, V _{CC} = 5.0V	-2.75	+2.75		%
		T _A = -40°C to +125°C, V _{CC} = 5.0V	-4	+4		
Clock Frequency Temperature Coefficient		V _{CC} = 5.0V (Note 2)		140	400	ppm/°C
Clock Frequency Supply Voltage Coefficient		T _A = +25°C (Note 2)		0.67	1	%/V

Electrical Characteristics (continued)

(Typical Application Circuit, $V_{CC} = +2.7V$ to $+5.5V$, $T_A = -40^{\circ}C$ to $+125^{\circ}C$, 1MHz to 16MHz output frequency range, typical values at $V_{CC} = +5.0V$, $T_A = +25^{\circ}C$, unless otherwise noted.) (Note 1)

PARAMETER	SYMBOL	CONDITIONS		MIN	TYP	MAX	UNITS
CLOCK Duty Cycle		(Note 2)		45	50	55	%
CLOCK Output Jitter		Observation for 20s using a 500MHz oscilloscope			310		ps RMS
Output Rise Time	t_R	$C_{LOAD} = 10pF$, 10% to 90% of full scale (Note 2)			2.5	7.0	ns
Output Fall Time	t_F	$C_{LOAD} = 10pF$, 90% to 10% of full scale (Note 2)			2.8	7.5	ns
INTERNAL POWER-ON RESET							
Reset Voltage	V_{TH+}	V_{CC} rising, Table 2	$T_A = +25^{\circ}C$	V_{TH} - 1.5%		V_{TH} + 1.5%	V
			$T_A = -40^{\circ}C$ to $+125^{\circ}C$	V_{TH} - 2.5%		V_{TH} + 2.5%	
	V_{TH-}	V_{CC} falling			0.98 x V_{TH+}		
Reset Timeout Period	t_{RST}	Figures 1, 2		86	135	250	μs
WATCHDOG							
Watchdog Timeout Period (Figure 2)	t_{WDG}	WDS1 = GND, WDS2 = GND		11	16	22	ms
		WDS1 = open, WDS2 = GND		22	32	44	
		WDS1 = V_{CC} , WDS2 = GND		44	64	88	
		WDS1 = GND, WDS2 = open		88	128	177	
		WDS1 = open, WDS2 = open		177	256	354	
		WDS1 = V_{CC} , WDS2 = open		354	512	708	
		WDS1 = GND, WDS2 = V_{CC}		708	1024	1416	
		WDS1 = open, WDS2 = V_{CC}		1416	2048	2832	
		WDS1 = WDS2 = V_{CC} (watchdog disabled)					
POWER FAIL							
Power-Fail Select Threshold	V_{SEL}	PFI input		0.65 x V_{CC}		0.85 x V_{CC}	V
V_{CC} Monitoring Threshold (Internal Threshold)	V_{ITH}	V_{CC} rising		4.06	4.38	4.60	V
Internal Threshold Hysteresis	V_{IHYST}	V_{CC} falling		1.0	2	4.0	% V_{ITH}
PFI Monitoring Threshold (External Threshold)	V_{ETH}	PFI rising		0.9	1.1	1.4	V
External Threshold Hysteresis	V_{EHYST}	PFI falling		1.0	3.5	8.0	% V_{ETH}

Note 1: All parameters are tested at $T_A = +25^{\circ}C$. Specifications over temperature are guaranteed by design.

Note 2: Guaranteed by design. Not production tested.

Typical Operating Characteristics

(Typical Application Circuit, $V_{CC} = +5V$, $f_{CLOCK} = 16MHz$, $T_A = +25^{\circ}C$, unless otherwise noted.)

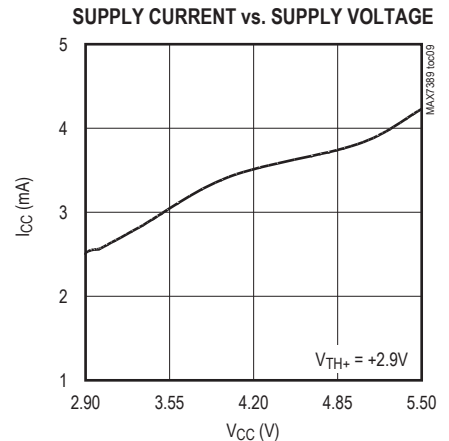
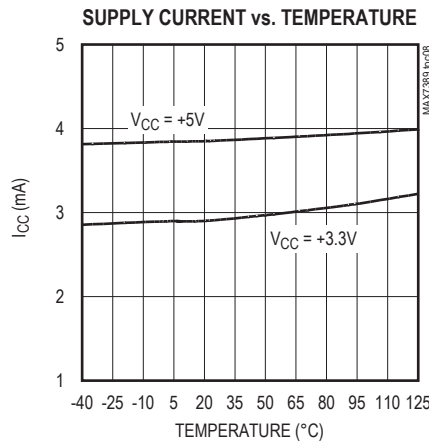
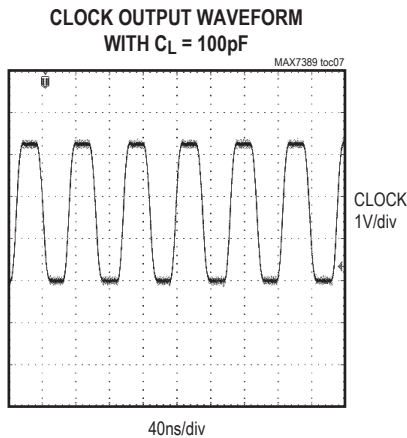
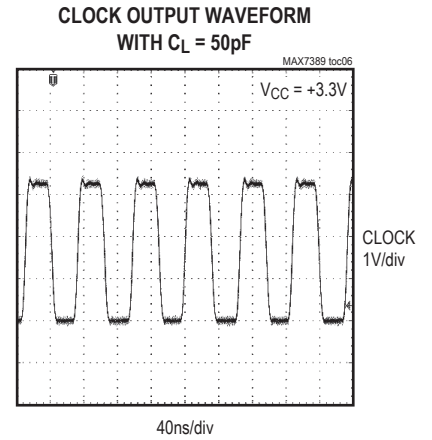
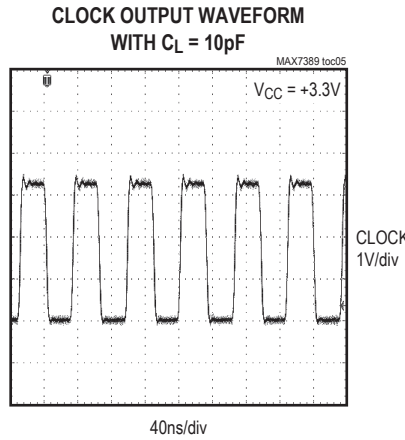
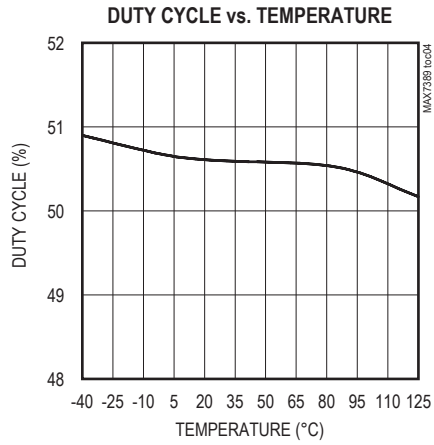
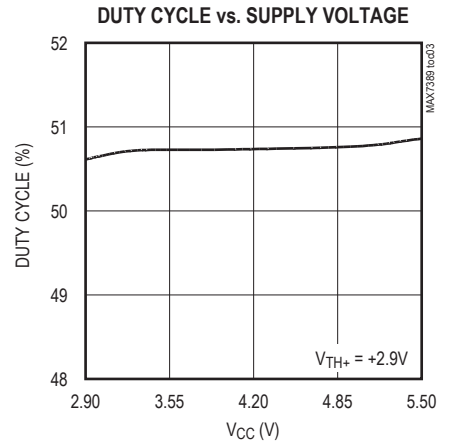
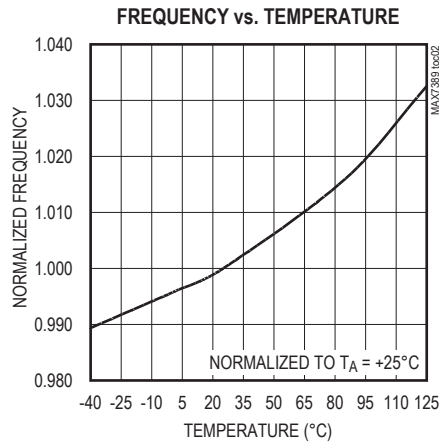
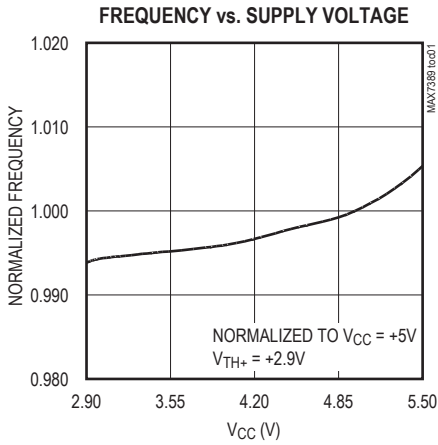

Typical Operating Characteristics (continued)

(Typical Application Circuit, $V_{CC} = +5V$, $f_{CLOCK} = 16MHz$, $T_A = +25^{\circ}C$, unless otherwise noted.)

CLOCK SETTLING TIME FROM START

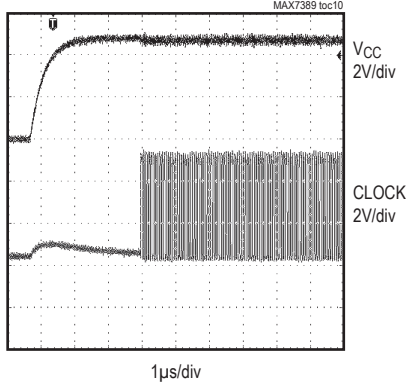

POWER-ON RESET BEHAVIOR

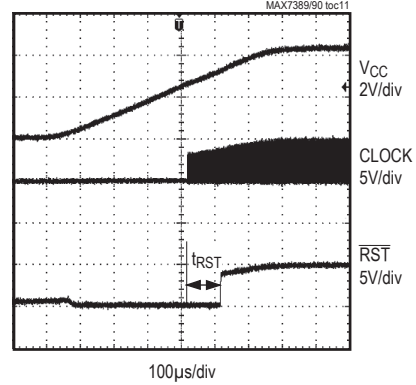

MAXIMUM V_{CC} TRANSIENT DURATION vs. RESET THRESHOLD OVERDRIVE

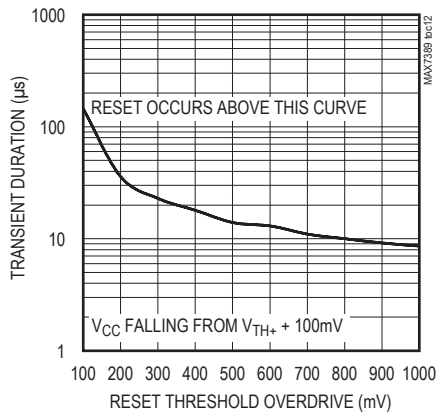

RESPONSE OF \overline{RST} AND \overline{WDO} WDI EXCEEDING t_{WDG}

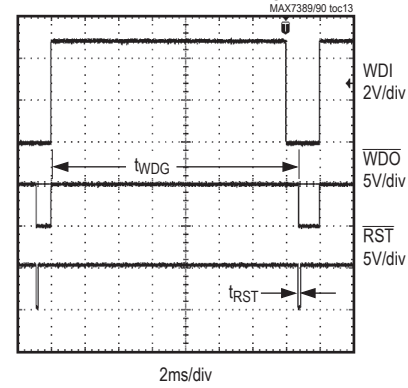

RISING THRESHOLD vs. TEMPERATURE

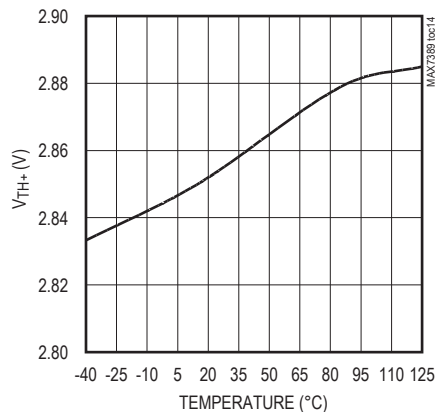

CLOCK RESPONSE TO SPEED SELECT INPUT

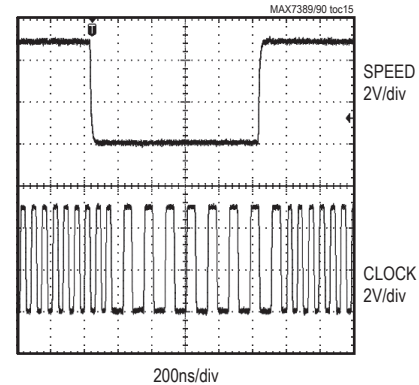

Pin Description

PIN		NAME	FUNCTION
MAX7389	MAX7390		
1	1	V _{CC}	Power Input. Connect V _{CC} to the power supply. Bypass V _{CC} to GND with a 1μF capacitor. Install the bypass capacitor as close to the device as possible.
2	2	WDS1	Watchdog Timeout Select Input 1. Connect WDS1 and WDS2 to V _{CC} , GND, or V _{CC} /2, as shown in Table 1, to set the watchdog timeout period.
3	3	WDS2	Watchdog Timeout Select Input 2. Connect WDS2 and WDS1 to V _{CC} , GND, or V _{CC} /2, as shown in Table 1, to set the watchdog timeout period.
4	4	GND	Ground
5	—	$\overline{\text{WDO}}$	Watchdog Output. Open-drain watchdog output asserts if WDI is not toggled within the watchdog timeout period.
—	5	SPEED	Clock-Speed Select Input. Connect SPEED high for the factory-trimmed clock output frequency. Connect SPEED low to reduce the clock output frequency by half.
6	6	WDI	Watchdog Input. A rising edge on WDI resets watchdog timer. If WDI does not receive a rising edge within the watchdog timeout period (t _{WDG}), RST/ $\overline{\text{RST}}$ asserts. The watchdog timeout period is programmable through WDS1 and WDS2. Connect WDS1 and WDS2 to V _{CC} to disable the watchdog timer.
7	7	RST/ $\overline{\text{RST}}$	Reset Output. Reset output is available in one of three configurations: push-pull RST, push-pull $\overline{\text{RST}}$, or open-drain $\overline{\text{RST}}$. The reset output is asserted if one of the following conditions occurs: whenever V _{CC} is below the reset threshold level; for devices with WDI, reset output asserts when WDI does not receive a rising edge within the watchdog timeout period.
8	8	CLOCK	Clock Output

Detailed Description

The MAX7389/MAX7390 replace ceramic resonators, crystals, and supervisory functions for microcontrollers in 3.3V and 5V applications.

The MAX7389/MAX7390 provide a clock source, reset, and watchdog functions. The watchdog timer is pin programmable and provides watchdog timeout values in the 16ms to 2048ms range. The MAX7389 provides a separate watchdog output that is used as a status indicator or to control safety-critical system elements. The MAX7390 features a clock-speed switch that reduces the output frequency by half. This functionality allows the microcontroller to operate at reduced power and may be used to extend the time available to perform housekeeping tasks, such as writing data to flash during a power failure.

The integrated reset and watchdog functions provide the power-supply monitoring functions necessary to ensure correct microcontroller operation. The reset circuit has built-in power-supply transient immunity and provides both power-on reset and power-fail or brownout reset functionality. Two standard factory-trimmed reset levels

are available. The watchdog timer is programmable to eight individual timeout values and may be disabled for test purposes.

Clock Output (CLOCK)

The push-pull clock output (CLOCK) drives a ground-connected 1kΩ load or a positive supply connected 500Ω load to within 300mV of either supply rail. CLOCK remains stable over the full operating voltage range and does not generate short output cycles during either power-on or power-off. A typical startup characteristic is shown in the *Typical Operating Characteristics* section.

The MAX7390 clock output frequency is reduced by a factor of two by taking SPEED low. This functionality allows the microcontroller to operate at reduced power and may be used to extend the time available to perform housekeeping tasks.

Reset

The reset function drives the microcontroller reset input to prevent operation in the cases of the initial power-on setting, low power-supply voltages, and the failed watchdog

operations. Three reset output versions are available: push-pull RST, push-pull $\overline{\text{RST}}$, and open-drain $\overline{\text{RST}}$. The reset timeout period (t_{RST}) is nominally 135s.

Power-On Reset (POR)

The internal power-on reset (POR) circuit detects the power-supply voltage (V_{CC}) level at startup. The POR circuit starts the oscillator when V_{CC} exceeds the reset rising threshold level ($V_{\text{TH+}}$). The reset output remains asserted from the time V_{CC} crosses the $V_{\text{TH+}}$ and continues to be asserted for the reset timeout period (t_{RST}). Upon completion of the reset timeout, the reset output is released. See Figure 1.

Low-Voltage Lockout

The reset output asserts whenever V_{CC} drops below the reset falling threshold, $V_{\text{TH-}}$. The difference between the reset rising and falling threshold values is $V_{\text{TH+}} - (V_{\text{TH-}})$. The nominal hysteresis value is 2% of the reset rising threshold value. The reset detection circuitry provides filtering to prevent triggering on negative voltage spikes.

See the *Typical Operating Characteristics* for a plot of maximum transient duration without causing a reset pulse vs. reset comparator overdrive.

Figure 1 shows the reset output ($\text{RST}/\overline{\text{RST}}$) behavior during power-up and brownout.

Watchdog

The watchdog function provides microprocessor monitoring by requiring the microprocessor to toggle an output pin to indicate correct operation. The WDI input monitors the port signal and resets the watchdog timer on receipt of a rising edge. If an edge is not received within the required watchdog timeout period, the watchdog circuit initiates a reset cycle and asserts the $\overline{\text{WDO}}$ output (MAX7389 only). The internal watchdog circuits are reset and the watchdog timer restarts at the end of the reset cycle ($\text{RST}/\overline{\text{RST}}$ output releases). The $\overline{\text{WDO}}$ output remains asserted until a valid edge is received on the WDI input, signifying correct microprocessor operation. The $\overline{\text{WDO}}$ output can be used as a status indicator either to the microprocessor or to an external device, such as a fault-indicating LED or sounder.

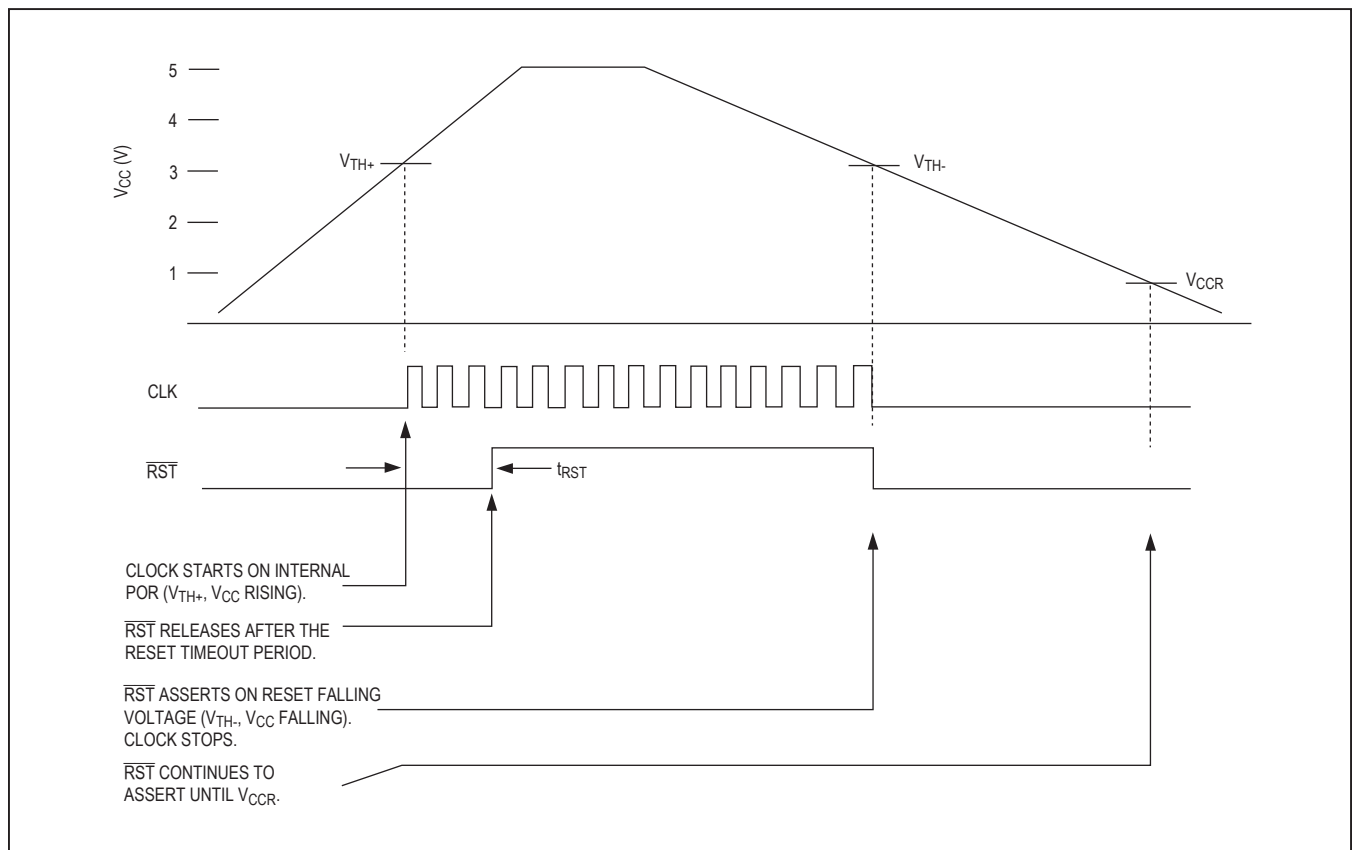

Figure 1. $\text{RST}/\overline{\text{RST}}$ Behavior During Power-Up and Brownout

The \overline{WDO} output is an open-drain output. The power-up condition of the \overline{WDO} output is high (not asserted).

The operation of the watchdog and reset function is illustrated in Figure 2.

The watchdog timeout period is set to one of nine possible values by pin strapping WDS1 and WDS2. Each control input has three possible values assigned by connection to GND, V_{CC} , or $V_{CC}/2$ (see Table 1). One of the assigned values disables the watchdog function and is intended for customer use during test. The watchdog timer is disabled while the $\overline{RST}/\overline{RST}$ output is asserted.

Table 1. Watchdog Timeout Periods

WDS1	WDS2	WATCHDOG TIMEOUT PERIOD (ms)		
		MIN	TYP	MAX
GND	GND	11	16	22
$V_{CC}/2$ = open	GND	22	32	44
V_{CC}	GND	44	64	88
GND	$V_{CC}/2$ = open	88	128	177
$V_{CC}/2$ = open	$V_{CC}/2$ = open	177	256	354
V_{CC}	$V_{CC}/2$ = open	354	512	708
GND	V_{CC}	708	1024	1416
$V_{CC}/2$ = open	V_{CC}	1416	2048	2828
V_{CC}	V_{CC}	Disabled		

Note: WDS1 or WDS2 is pulled internally to $V_{CC}/2$ if left floating.

Applications Information

Interfacing to a Microcontroller Clock Input

The CLOCK output is a push-pull, CMOS logic output, which directly drives any microprocessor (μP) or microcontroller (μC) clock input. There are no impedance-matching issues when using the MAX7389/MAX7390. Operate the MAX7389/MAX7390 and microcontroller (or other clock input device) from the same supply voltage level. Refer to the microcontroller data sheet for clock-input compatibility with external clock signals.

The MAX7389/MAX7390 require no biasing components or load capacitance. When using the MAX7389/MAX7390 to retrofit a crystal oscillator, remove all biasing components from the oscillator input.

Power-Supply Considerations

The MAX7389/MAX7390 operate with power-supply voltages in the 2.7V to 5.5V range. Power-supply decoupling is needed to maintain the power-supply rejection performance of the devices. Bypass V_{CC} to GND with a 0.1 μF surface-mount ceramic capacitor. Mount the bypass capacitor as close to the device as possible. If possible, mount the MAX7389/MAX7390 close to the microcontroller's decoupling capacitor so that additional decoupling is not required.

A larger-value bypass capacitor is recommended if the MAX7389/MAX7390 are to operate with a large capacitive load. Use a bypass capacitor value of at least 1000 times that of the output load capacitance.

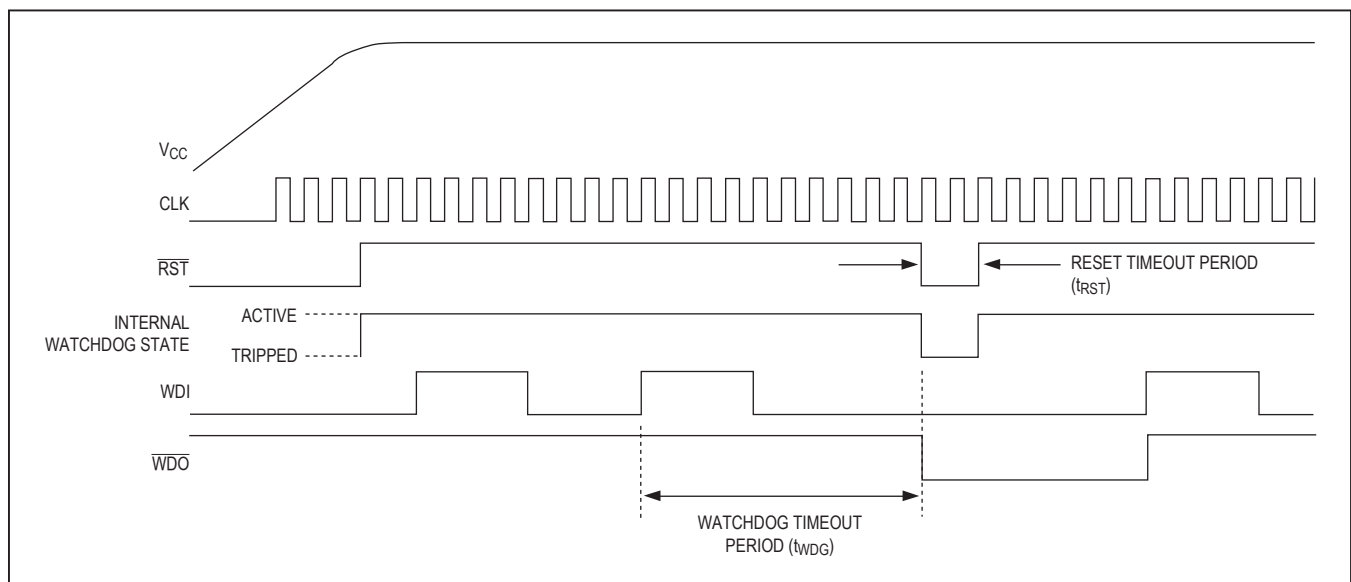

Figure 2. Watchdog Timing Diagram

Output Jitter

The MAX7389/MAX7390s' jitter performance is given in the *Electrical Characteristics* table as a peak-to-peak value obtained by observing the output of the device for 20s with a 500MHz oscilloscope. Jitter measurements are approximately proportional to the period of the output frequency of the device. Thus, a 4MHz part has approximately twice the jitter value of an 8MHz part.

Table 2. POR Voltage

POWER-ON RESET VOLTAGE (V_{TH})	r
4.38	M
3.96	J
3.44	N
3.34	P
3.13	Q
2.89	S
2.82	V
2.5	X

Note: Standard values are shown in bold. Contact factory for other POR voltage.

The jitter performance of all clock sources degrades in the presence of mechanical and electrical interference. The MAX7389/MAX7390 are immune to vibration, shock, and EMI influences and thus provide a considerably more robust clock source than crystal- or ceramic-resonator-based oscillator circuits.

Table 3. Reset Output Type

OUTPUT TYPE	s
Push-pull RST	A
Push-pull \overline{RST}	B
Open drain \overline{RST}	C

Note: Standard values are shown in bold. Contact factory for other output types.

Table 4. Clock Output Frequency

CLOCK FREQUENCY (f_{CLOCK}) (MHz)	ff
4	RD
8	TP
12	VB
16	WB

Note: Contact factory for other frequencies.

Selector Guide

PART	FREQUENCY RANGE (MHz)	RESET FUNCTION	WATCHDOG INPUT (WDI)/ WATCHDOG OUTPUT (WDO)	POWER-FAIL INPUT (PFI)/ POWER-FAIL OUTPUT (PFO)	SPEED	PIN-PACKAGE
MAX7387	1 to 16	Yes	Yes/yes	Yes/yes	—	10 μ MAX
MAX7388	1 to 16	Yes	Yes/no	No/yes	—	8 μ MAX
MAX7389	1 to 16	Yes	Yes/yes	No/no	—	8 μ MAX
MAX7390	1 to 16	Yes	Yes/no	No/no	Yes	8 μ MAX
MAX7391	1 to 16	Yes	No/no	Yes/no	Yes	8 μ MAX

Note: Other versions with different features are available. Refer to the MAX7387/MAX7388 and MAX7391 data sheets.

Functional Diagram

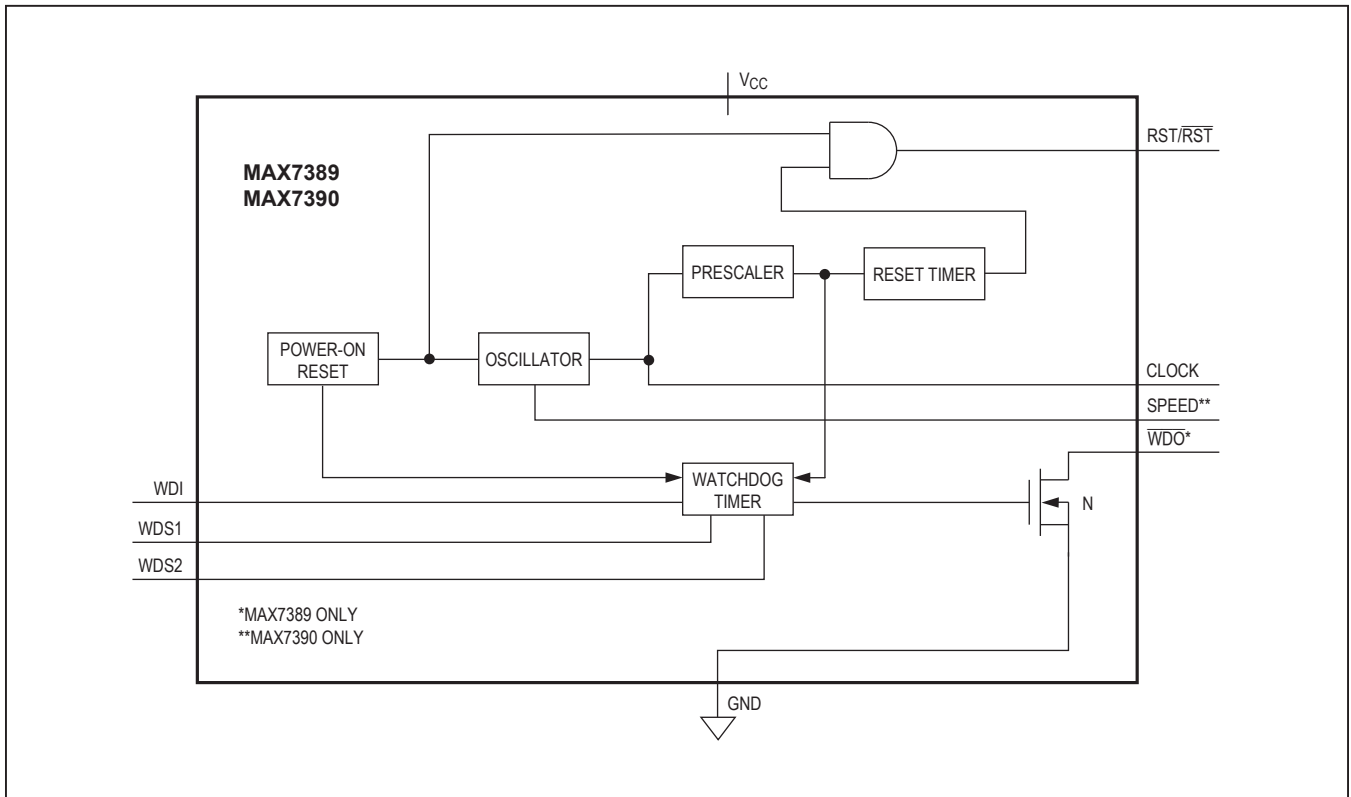

Typical Application Circuit

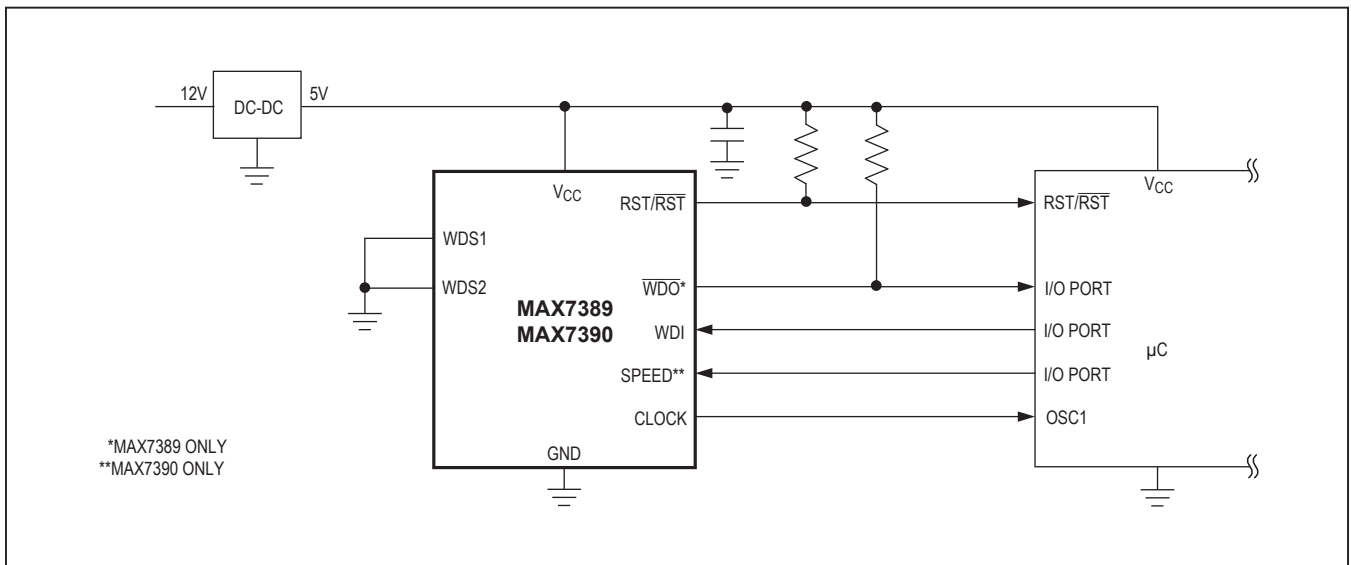

Chip Information

PROCESS: BICMOS

Package Information

For the latest package outline information and land patterns (footprints), go to www.maximintegrated.com/packages. Note that a "+", "#", or "-" in the package code indicates RoHS status only. Package drawings may show a different suffix character, but the drawing pertains to the package regardless of RoHS status.

PACKAGE TYPE	PACKAGE CODE	OUTLINE NO.	LAND PATTERN NO.
8 µmax	U8-1	21-0036	90-0092

Revision History

REVISION NUMBER	REVISION DATE	DESCRIPTION	PAGES CHANGED
2	4/14	No /V OPNs; removed Automotive reference from <i>Applications</i> section	1

For pricing, delivery, and ordering information, please contact Maxim Direct at 1-888-629-4642, or visit Maxim Integrated's website at www.maximintegrated.com.

Maxim Integrated cannot assume responsibility for use of any circuitry other than circuitry entirely embodied in a Maxim Integrated product. No circuit patent licenses are implied. Maxim Integrated reserves the right to change the circuitry and specifications without notice at any time. The parametric values (min and max limits) shown in the Electrical Characteristics table are guaranteed. Other parametric values quoted in this data sheet are provided for guidance.