



MAX8760 Evaluation Kit

Evaluates: MAX8760

General Description

The MAX8760 evaluation kit (EV kit) demonstrates the high-power, dynamically adjustable multiphase notebook CPU application circuit. This DC-DC converter steps down high-voltage batteries and/or AC adapters, generating a precision, low-voltage CPU core V_{CC} rail. The MAX8760 EV kit meets the mobile AMD K8 and K8 Rev F VID code set and CPU transient voltage specifications. The MAX8760 EV kit consists of the MAX8760 dual-phase Quick-PWM™ step-down controller and the MAX6509 temperature sensor.

The MAX8760 EV kit includes active voltage positioning with adjustable gain, reducing power dissipation and bulk output capacitance requirements. Precision slew-rate control provides “just-in-time” arrival at the new DAC setting, minimizing surge currents to and from the battery.

This fully assembled and tested PC board provides a 6-bit digitally adjustable output voltage from a 7V to 24V battery input range. The EV kit operates at 300kHz switching frequency and has superior line- and load-transient response.

Component Suppliers

SUPPLIER	PHONE	WEBSITE
Central Semiconductor	631-435-1110	www.centalsemi.com
NEC/Tokin	510-324-4110	www.nec-tokinamerica.com
Nihon Semiconductor	847-843-7500	www.niec.co.jp
Panasonic	714-373-7939	www.panasonic.com
Sanyo	619-661-6835	www.sanyovideo.com
Taiyo Yuden	800-348-2496	www.t-yuden.com
TDK	847-803-6100	www.component.tdk.com
Vishay/Siliconix	402-564-3131	www.vishay.com

Note: Indicate you are using the MAX8760 when contacting these component suppliers.

DESIGNATION	QTY	DESCRIPTION
C1, C2, C7, C15, C22, C25, C26, C63	0	Not installed (0603)
C5	1	1000pF \pm 10%, 50V C0G ceramic capacitor (0603) TDK 1608X7R1H102K Murata GRM188R71H102K
C6, C21, C23	3	0.22 μ F, 16V X5R ceramic capacitors (0603) Taiyo Yuden LMK107BJ224MA TDK C1608X7R1C224M

Quick-PWM is a trademark of Maxim Integrated Products, Inc.

Features

- ◆ Dual-Phase Quick-PWM EV Kit
- ◆ AMD K8 and K8 Rev F Compatible
- ◆ Active Voltage Positioning with Adjustable Gain, Offset, and Remote Sensing
- ◆ High Speed, Accuracy, and Efficiency
- ◆ Low Bulk Output Capacitor Count
- ◆ Multiphase Fast-Response Quick-PWM Architecture
- ◆ 7V to 24V Input Voltage Range
- ◆ 0.375V to 1.550V Output Voltage Range (6-Bit DAC)
- ◆ 30A Load-Current Capability (15A Each Phase)
- ◆ 300kHz Switching Frequency
- ◆ MAX6509 Temperature Sensor
- ◆ Fully Assembled and Tested

Ordering Information

PART	TEMP RANGE	IC PACKAGE
MAX8760EVKIT	0°C to +70°C	40 Thin QFN (6mm x 6mm)

Component List

DESIGNATION	QTY	DESCRIPTION
C8, C10, C11, C12	4	330 μ F, 2.5V, 9m Ω low-ESR polymer capacitors (D case) Sanyo 2R5TPE330M9 or 330 μ F, 2V, 7m Ω low-ESR specialty polymer capacitors (D case) Panasonic EEFS0D331XR
C16	1	2.2 μ F, 10V X5R ceramic capacitor (0805) Taiyo Yuden LMK212BJ225KG TDK C2012X7R1C225K



For pricing, delivery, and ordering information, please contact Maxim/Dallas Direct! at 1-888-629-4642, or visit Maxim's website at www.maxim-ic.com.

MAX8760 Evaluation Kit

Evaluates: MAX8760

Component List (continued)

DESIGNATION	QTY	DESCRIPTION
C17, C18, C19, C43, C65	5	10 μ F \pm 20%, 25V X5R ceramic capacitors (1210) TDK C3225X7R1E106M AVX 12103D106M Taiyo Yuden TMK325BJ106MM
C24	1	100pF \pm 5%, 50V C0G ceramic capacitor (0603) Murata GRM1885C1H101J
C27	1	1 μ F \pm 20%, 10V X5R ceramic capacitor (0805) Taiyo Yuden LMK212BJ105KG TDK C2012X7R1C105MKT
C28	1	270pF \pm 5%, 50V C0G ceramic capacitor (0603) Murata GRM188R71H271K
C30	1	470pF \pm 10%, 50V X7R ceramic capacitor (0603) Murata GRM188R71H471K
C61	1	0.1 μ F \pm 10%, 50V X7R ceramic capacitor (0603) Murata GRM188R71E104K TDK C1608X7R1E104K
C97, C98, C100, C101	4	10 μ F \pm 20%, 6.3V X5R ceramic capacitors (0805) TDK C2012X5R0J106M Taiyo Yuden AMK212BJ106MG
D1	1	100mA, 30V dual Schottky diode Central Semiconductor CMPSH-3A
D2, D3	2	3A, 30V Schottky diodes Nihon EC31QS03Lo Central Semiconductor CMSH3-40
JUA0–JUA5	6	2-pin headers
JU2	1	3-pin header
JU4	1	4-pin header

DESIGNATION	QTY	DESCRIPTION
L1, L2	2	0.56 μ H, 26A, 1.69m Ω power inductors (10mm x 11.5mm x 4mm) Panasonic ETQP4LR56WFC or 0.56 μ H, 29A, 1.30m Ω power inductors (10mm x 10mm x 4mm) NEC/TOKIN MPC1040LR56
N1, N6	2	n-channel MOSFETs Vishay/Siliconix Si7392DP (Power PAK)
N3, N4, N8, N9	4	n-channel MOSFETs Vishay/Siliconix Si7336ADP (Power PAK)
R1, R8, R11, R17, R20, R25, R62, R63, R70	0	Not installed (short PC trace) (0603)
R2, R9	2	0.001 Ω \pm 1%, 1W resistors (2512) Panasonic ERJM1WTF1M0U
R3, R107	2	100 Ω \pm 5% resistors (0603)
R4, R23	2	2k Ω \pm 1% resistors (0603)
R5, R6, R18, R24	4	1k Ω \pm 1% resistors (0603)
R7	1	30.1k Ω \pm 1% resistor (0603)
R10	1	100k Ω \pm 1% resistor (0603)
R12	1	20k Ω \pm 1% resistor (0603)
R16, R83, R84	3	10 Ω \pm 5% resistors (0603)
R22, R53, R61, R81	0	Not installed (0603)
R54–R59, R95, R96, R97	9	100k Ω \pm 5% resistors (0603)
R60	1	11k Ω \pm 1% resistor (0603)
R82	1	1M Ω \pm 5% resistor (0603)
U1	1	MAX8760ETL (40-pin TQFN)
U4	1	MAX6509HAUK-T (5-pin SOT23)
—	7	Shunts
—	1	MAX8760 PC board

MAX8760 Evaluation Kit

Quick Start

Recommended Equipment

- 7V to 24V, > 100W power supply, battery, or notebook AC adapter
- DC bias power supply, 5V at 1A
- One or more dummy loads capable of sinking 30A total
- Digital multimeter (DMM)
- 100MHz dual-trace oscilloscope

Procedure

Ensure that the circuit is connected correctly to the supplies and dummy load prior to applying any power:

- 1) Verify that the shunts are across JU2 pins 1 and 2 ($\overline{\text{SHDN}}$) and JU4 pins 1 and 3 (TON). The DAC code settings (D5–D0) are set for 1.2000V output through installed jumpers JUA1, JUA2, and JUA3.
- 2) Turn on the battery power before turning on the +5V bias power; otherwise, the output UVLO timer times out and the FAULT latch is set, disabling the regulator until +5V power is cycled or $\overline{\text{SHDN}}$ is toggled.
- 3) Observe the output voltage with the DMM and/or oscilloscope. Look at the LX switching nodes and MOSFET gate-drive signals while varying the load current.

Detailed Description

This 30A multiphase buck-regulator design is optimized for a 300kHz frequency and 1.0V to 1.5V output voltage settings. At $V_{\text{OUT}} = 1.2\text{V}$ and $V_{\text{IN}} = 12\text{V}$, the inductor ripple is approximately 30% (LIR = 0.3). The MAX8760 controller shares the current between its two phases that operate 180° out-of-phase, supplying 15A per phase.

Setting the Output Voltage

On startup, the controller ramps the output to the preset DAC code from the D0–D5 input decoder when $\text{SUS} = \text{GND}$. The output voltage is digitally set by the D0–D5 pins (Table 2). There are two different methods of setting the output voltage:

- 1) Drive the external VID0–VID5 inputs (no jumpers installed). The output voltage can be set by driving VID0–VID5 with open-drain drivers (pullup resistors are included on the board) or 3V/5V CMOS output logic levels.
- 2) Install jumpers JUA0–JUA5: $\text{SUS} = \text{low}$. When JUA0–JUA5 are not installed, the MAX8760's D0–D5 inputs are at logic 1 (connected to VID_VCC). When JUA0–JUA5 are installed, D0–D5 inputs are at logic 0 (connected to GND). The output voltage can be changed during operation by installing and removing jumpers JUA0–JUA5. As shipped, the EV kit is configured with jumpers JUA0–JUA5 set for 1.2000V output (Table 2). Refer to the MAX8760 data sheet for more information.

Table 1. MAX8760 Operating Mode Truth

$\overline{\text{SHDN}}$	$\overline{\text{SKIP}}$	OUTPUT VOLTAGE	OPERATING MODE
GND	X	GND	Low-Power Shutdown Mode. DL_ is forced high, DH_ is forced low, and the PWM controller is disabled. The supply current drops to 1 μA (typ).
VCC	REF	D0–D5	Dual-Phase Pulse-Skipping Operation. When $\overline{\text{SKIP}}$ is set to 2V, the MAX8760 immediately enters dual-phase pulse-skipping operation allowing automatic PWM/PFM switchover under light loads. The VROK upper threshold is blanked.
VCC	GND	D0–D5	Single-Phase Pulse-Skipping Operation. When $\overline{\text{SKIP}}$ is pulled to GND, the MAX8760 immediately enters single-phase pulse-skipping operation allowing automatic PWM/PFM switchover under light loads. The VROK upper threshold is blanked.
VCC	X	GND	Fault Mode. The fault latch has been set either by UVP, OVP, or thermal shutdown. The controller remains in FAULT mode until VCC power is cycled or $\overline{\text{SHDN}}$ is toggled.

MAX8760 Evaluation Kit

Reduced Power Dissipation Voltage Positioning

The MAX8760 EV kit uses voltage positioning to decrease the size of the output capacitor and to reduce power dissipation at heavy loads. Current-sense resistors (R2 and R9 = 1m Ω) are used to sense the inductor current and adjust the output voltage. The current-sense resistors dissipate some power but the net power savings are substantial. This EV kit further improves efficiency by using an internal op-amp gain stage to allow a reduction in the sense-resistor value.

The MAX8760 op amp is configured for a gain of 3 providing a -2mV/A voltage-positioning slope at the output. Remote output and ground sensing eliminates any additional PC board voltage drops.

On startup, the controller ramps the output to the preset DAC code from the D0–D5 input decoder when SUS = GND. The output voltage is digitally set by the D0–D5 pins (Table 2).

Dynamic Output-Voltage Transitions

This EV kit is set to transition the output voltage at 1 LSB per 2 μ s. The transition rate can be altered by changing resistor R7 (30.1k Ω).

During the voltage transition, watch the inductor current by looking across R2 and/or R9 with a differential scope probe or by inserting a current probe in series with the inductor. Observe the low, well-controlled inductor current that accompanies the voltage transition. Slew-rate control during shutdown and startup results in well-controlled currents into and out of the battery (input source).

There are two other methods to create an output-voltage transition. Select D0–D5 (JUA0–JUA5). Then either manually change the JUA0–JUA5 jumpers to a new VID code setting (Table 2), or remove all jumpers and drive the VID0–VID5 PC board test points externally to the desired code settings.

Table 2. MAX8760 Output-Voltage Adjustment Settings (SUS = GND)

D5 JUA5	D4 JUA4	D3 JUA3	D2 JUA2	D1 JUA1	D0 JUA0	V _{OUT} (V)	D5 JUA5	D4 JUA4	D3 JUA3	D2 JUA2	D1 JUA1	D0 JUA0	V _{OUT} (V)
0	0	0	0	0	0	1.5500	1	0	0	0	0	0	0.7625
0	0	0	0	0	1	1.5250	1	0	0	0	0	1	0.7500
0	0	0	0	1	0	1.5000	1	0	0	0	1	0	0.7375
0	0	0	0	1	1	1.4750	1	0	0	0	1	1	0.7250
0	0	0	1	0	0	1.4500	1	0	0	1	0	0	0.7125
0	0	0	1	0	1	1.4250	1	0	0	1	0	1	0.7000
0	0	0	1	1	0	1.4000	1	0	0	1	1	0	0.6875
0	0	0	1	1	1	1.3750	1	0	0	1	1	1	0.6750
0	0	1	0	0	0	1.3500	1	0	1	0	0	0	0.6625
0	0	1	0	0	1	1.3250	1	0	1	0	0	1	0.6500
0	0	1	0	1	0	1.3000	1	0	1	0	1	0	0.6375
0	0	1	0	1	1	1.2750	1	0	1	0	1	1	0.6250
0	0	1	1	0	0	1.2500	1	0	1	1	0	0	0.6125
0	0	1	1	0	1	1.2250	1	0	1	1	0	1	0.6000
0	0	1	1	1	0	1.2000	1	0	1	1	1	0	0.5875

MAX8760 Evaluation Kit

Evaluates: MAX8760

Table 2. MAX8760 Output-Voltage Adjustment Settings (SUS = GND) (continued)

D5 JUA5	D4 JUA4	D3 JUA3	D2 JUA2	D1 JUA1	D0 JUA0	V _{OUT} (V)	D5 JUA5	D4 JUA4	D3 JUA3	D2 JUA2	D1 JUA1	D0 JUA0	V _{OUT} (V)
0	0	1	1	1	1	1.1750	1	0	1	1	1	1	0.5750
0	1	0	0	0	0	1.1500	1	1	0	0	0	0	0.5625
0	1	0	0	0	1	1.1250	1	1	0	0	0	1	0.5500
0	1	0	0	1	0	1.1000	1	1	0	0	1	0	0.5375
0	1	0	0	1	1	1.0750	1	1	0	0	1	1	0.5250
0	1	0	1	0	0	1.0500	1	1	0	1	0	0	0.5125
0	1	0	1	0	1	1.0250	1	1	0	1	0	1	0.5000
0	1	0	1	1	0	1.0000	1	1	0	1	1	0	0.4875
0	1	0	1	1	1	0.9750	1	1	0	1	1	1	0.4750
0	1	1	0	0	0	0.9500	1	1	1	0	0	0	0.4625
0	1	1	0	0	1	0.9250	1	1	1	0	0	1	0.4500
0	1	1	0	1	0	0.9000	1	1	1	0	1	0	0.4375
0	1	1	0	1	1	0.8750	1	1	1	0	1	1	0.4250
0	1	1	1	0	0	0.8500	1	1	1	1	0	0	0.4125
0	1	1	1	0	1	0.8250	1	1	1	1	0	1	0.4000
0	1	1	1	1	0	0.8000	1	1	1	1	1	0	0.3875
0	1	1	1	1	1	0.7750	1	1	1	1	1	1	0.3750

TON Settings

Jumper JU4 selects the MAX8760 switching frequency.

Note: When changing the switching frequency, recalculate the inductor and output capacitor values using the equations in the MAX8760 data sheet.

Table 3. Jumper JU4 Function (TON Setting)

SHUNT POSITION	TON PIN	MAX8760 SWITCHING FREQUENCY (kHz)
1 and 2	Connected to GND	550
1 and 3 (default)	Connected to REF	300
1 and 4	Connected to V _{CC}	200
Not installed	Open	100

MAX8760 Evaluation Kit

Evaluates: MAX8760

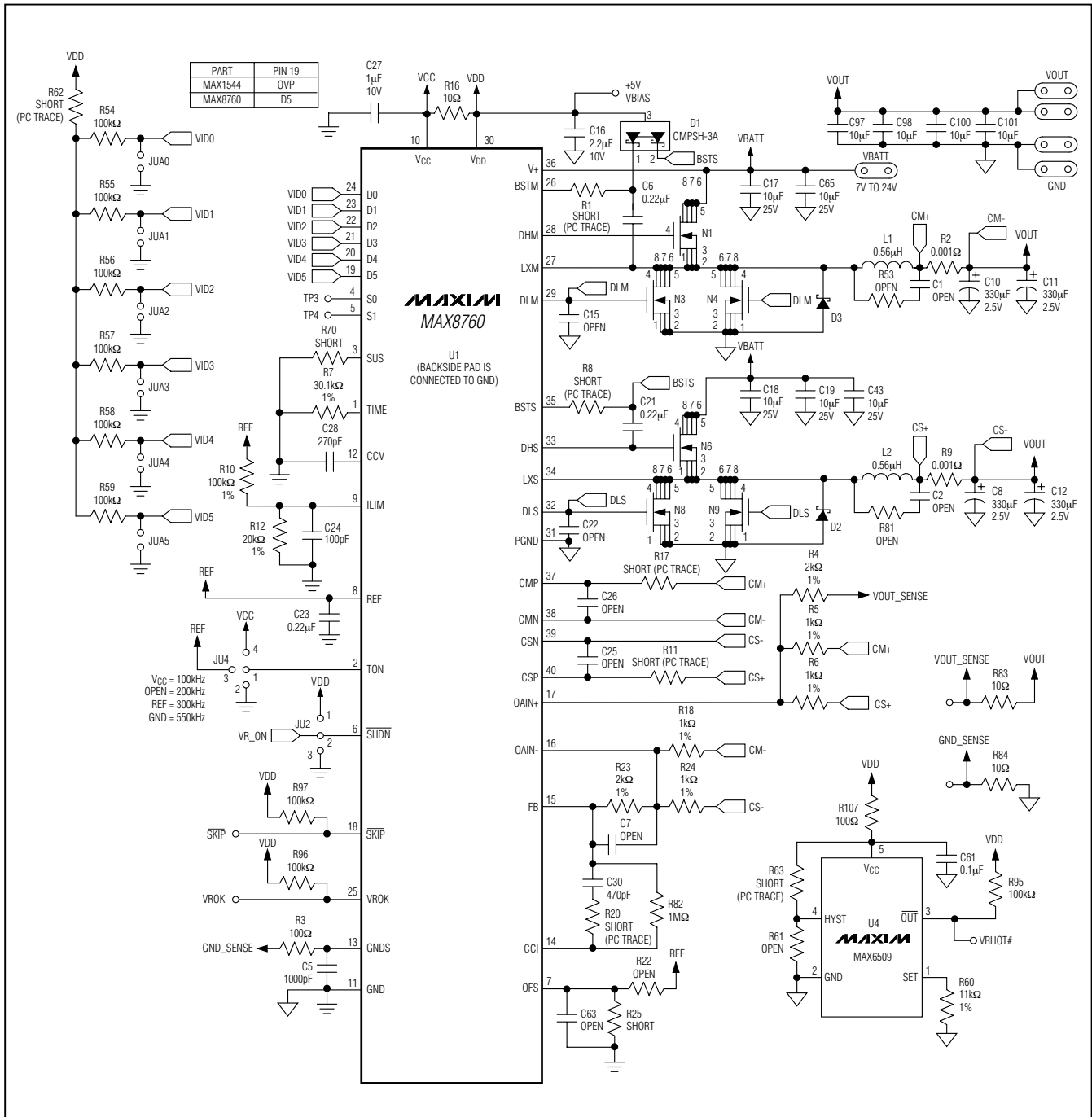

Figure 1. MAX8760 EV Kit Schematic

MAX8760 Evaluation Kit

Evaluates: MAX8760

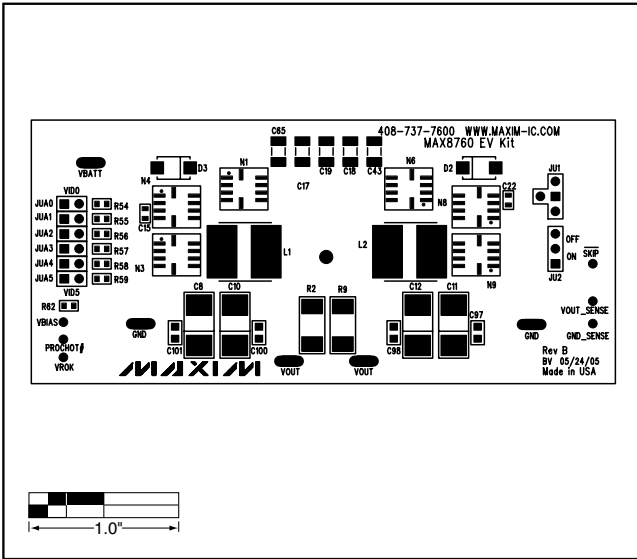

Figure 2. MAX8760 EV Kit Component Placement Guide—Component Side

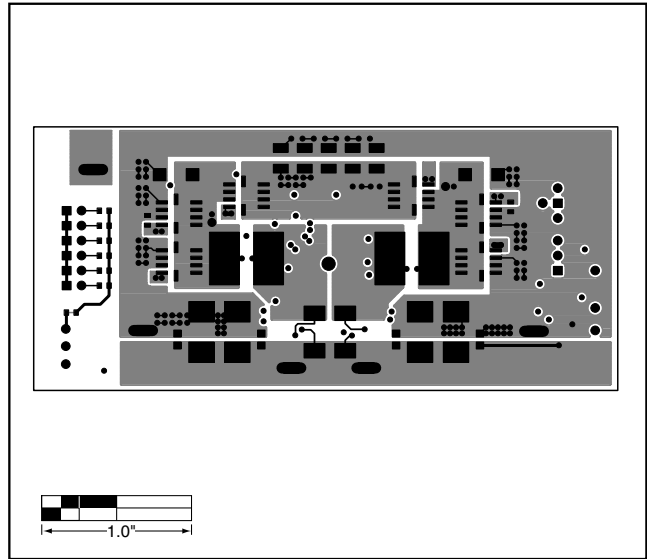

Figure 3. MAX8760 EV Kit PC Board Layout—Component Side

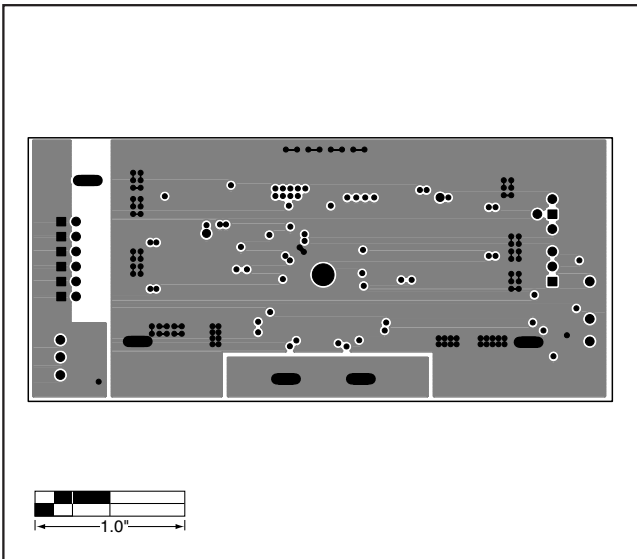

Figure 4. MAX8760 EV Kit PC Board Layout—Internal Layer 2—VOUT/GND Plane

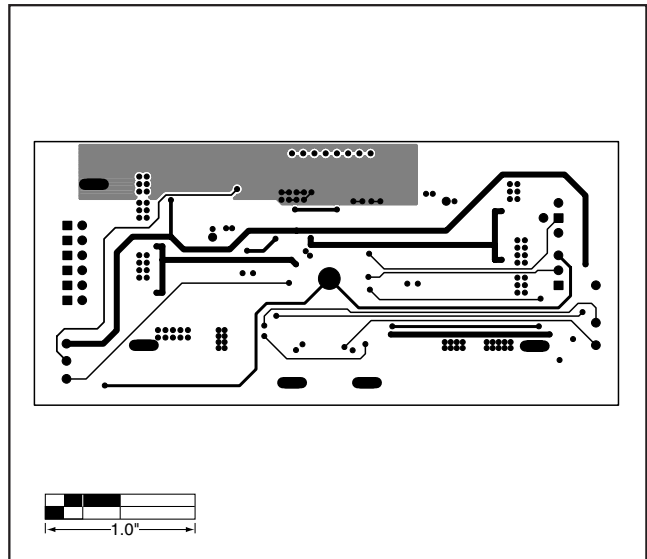

Figure 5. MAX8760 EV Kit PC Board Layout—Internal Layer 3—Signal Layer

MAX8760 Evaluation Kit

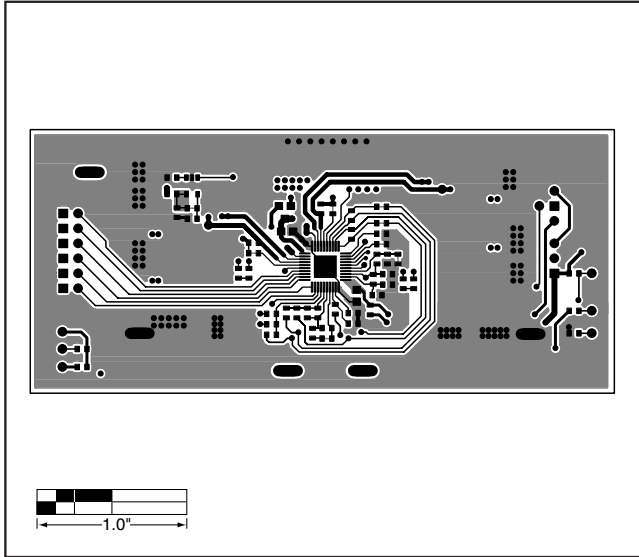

Figure 6. MAX8760 EV Kit PC Board Layout—Solder Side

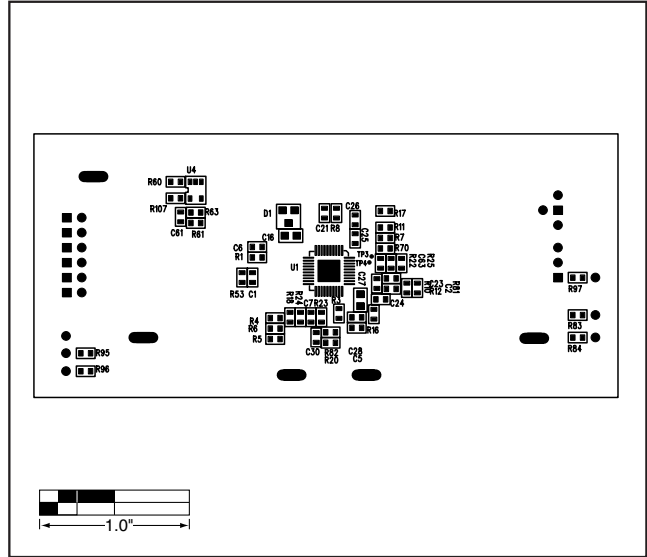

Figure 7. MAX8760 EV Kit Component Placement Guide—Solder Side

Maxim cannot assume responsibility for use of any circuitry other than circuitry entirely embodied in a Maxim product. No circuit patent licenses are implied. Maxim reserves the right to change the circuitry and specifications without notice at any time.