

Keysight B2980 Series
Femto/Picoammeter
Electrometer/High Resistance Meter

User's Guide

Notices

Copyright Notice

© Keysight Technologies 2014-2019

No part of this manual may be reproduced in any form or by any means (including electronic storage and retrieval or translation into a foreign language) without prior agreement and written consent from Keysight Technologies as governed by United States and international copyright laws.

Manual Part Number

B2980-90010

Edition

Edition 1, August 2014
Edition 2, September 2014
Edition 3, February 2015
Edition 4, March 2016
Edition 5, April 2019

Printed in:

Printed in Malaysia

Published by:

Keysight Technologies Japan K.K.
9-1, Takakura-cho, Hachioji-shi, Tokyo
192-0033 Japan

Technology Licenses

The hardware and/or software described in this document are furnished under a license and may be used or copied only in accordance with the terms of such license.

U.S. Government Rights

The Software is “commercial computer software,” as defined by Federal Acquisition Regulation (“FAR”) 2.101. Pursuant to FAR 12.212 and 27.405-3 and Department of Defense FAR Supplement (“DFARS”) 227.7202, the U.S. government acquires commercial computer software under the same terms by which the software is customarily provided to the public. Accordingly, Keysight provides the Software to U.S. government customers under its stan-

dard commercial license, which is embodied in its End User License Agreement (EULA), a copy of which can be found at <http://www.keysight.com/find/sweula>. The license set forth in the EULA represents the exclusive authority by which the U.S. government may use, modify, distribute, or disclose the Software. The EULA and the license set forth therein, does not require or permit, among other things, that Keysight: (1) Furnish technical information related to commercial computer software or commercial computer software documentation that is not customarily provided to the public; or (2) Relinquish to, or otherwise provide, the government rights in excess of these rights customarily provided to the public to use, modify, reproduce, release, perform, display, or disclose commercial computer software or commercial computer software documentation. No additional government requirements beyond those set forth in the EULA shall apply, except to the extent that those terms, rights, or licenses are explicitly required from all providers of commercial computer software pursuant to the FAR and the DFARS and are set forth specifically in writing elsewhere in the EULA. Keysight shall be under no obligation to update, revise or otherwise modify the Software. With respect to any technical data as defined by FAR 2.101, pursuant to FAR 12.211 and 27.404.2 and DFARS 227.7102, the U.S. government acquires no greater than Limited Rights as defined in FAR 27.401 or DFAR 227.7103-5 (c), as applicable in any technical data.

Warranty

THE MATERIAL CONTAINED IN THIS DOCUMENT IS PROVIDED “AS IS,” AND IS SUBJECT TO BEING CHANGED, WITHOUT NOTICE, IN FUTURE EDITIONS. FURTHER, TO THE MAXIMUM EXTENT PERMITTED BY APPLICABLE LAW, KEYSIGHT DISCLAIMS ALL WARRANTIES, EITHER EXPRESS OR IMPLIED, WITH REGARD TO THIS MANUAL AND ANY INFORMATION CONTAINED HEREIN, INCLUDING BUT NOT LIMITED TO THE IMPLIED WARRANTIES OF MERCHANTABILITY AND FIT-

NESS FOR A PARTICULAR PURPOSE. KEYSIGHT SHALL NOT BE LIABLE FOR ERRORS OR FOR INCIDENTAL OR CONSEQUENTIAL DAMAGES IN CONNECTION WITH THE FURNISHING, USE, OR PERFORMANCE OF THIS DOCUMENT OR OF ANY INFORMATION CONTAINED HEREIN. SHOULD KEYSIGHT AND THE USER HAVE A SEPARATE WRITTEN AGREEMENT WITH WARRANTY TERMS COVERING THE MATERIAL IN THIS DOCUMENT THAT CONFLICT WITH THESE TERMS, THE WARRANTY TERMS IN THE SEPARATE AGREEMENT SHALL CONTROL.

Open Software License

A portion of the software in this product is licensed under terms of the General Public License Version 2 (“GPLv2”). The text of the license and source code can be found at:

www.keysight.com/find/GPLV2

Declaration of Conformity

Declarations of Conformity for this product and for other Keysight products may be downloaded from the Web. Go to <http://www.keysight.com/go/conformity>. You can then search by product number to find the latest Declaration of Conformity.

Latest Information

To get the latest firmware/software/electronic manuals/specifications/support information, go to www.keysight.com and type in the product number in the Search field at the top of the page.

COMPLIANCE WITH GERMAN NOISE REQUIREMENTS

This is to declare that this product is in conformance with the German Regulation on Noise Declaration for Machines (Lärmangabe nach der Maschinenlärminformation-Verordnung -3.GSGV Deutschland).

- Herstellerbescheinigung
GERÄUSCHEMISSION
Lpa < 70 dB
am Arbeitsplatz
normaler Betrieb
nach DIN 45635 T. 19
- Manufacturer's Declaration
ACOUSTIC NOISE EMISSION
Lpa < 70 dB
operator position
normal operation
per ISO 7779

South Korean Class A EMC declaration

This equipment is Class A suitable for professional use and is for use in electromagnetic environments outside of the home.

A급 기기

(업무용 방송통신기자재)

이 기기는 업무용(A급) 전자파적합기기로서 판매자 또는 사용자는 이 점을 주의하시기 바라며, 가정외의 지역에서 사용하는 것을 목적으로 합니다.

Safety Summary

The following general safety precautions must be observed during all phases of operation, service, and repair of this instrument. Failure to comply with these precautions or with specific warnings elsewhere in this manual may impair the protections provided by the instrument. In addition, it violates safety standards of design, manufacture, and intended use of the instrument. Keysight Technologies assumes no liability for customer's failure to comply with these requirements.

For the Lithium-ion battery, also see "Safety Precautions for Lithium-ion Battery (Keysight part number B2980-90100)".

Product manuals may be provided on CD-ROM or in printed form. Printed manuals are an option for many products. Manuals may also be available on the Web. Go to www.keysight.com and type the product model number in the Search field at the top of the page.

NOTE

Do not use this instrument in any manner not specified by the manufacturer. The protective features of this instrument may be impaired if it is used in a manner not specified in the operation instructions.

This instrument is an INDOOR USE product.

This instrument complies with INSTALLATION CATEGORY II for mains input and INSTALLATION CATEGORY I for measurement input terminals, and POLLUTION DEGREE 2 defined in IEC 61010-1.

If an instrument is marked CAT I (IEC Measurement Category I), or it is not marked with a measurement category, its measurement terminals must not be connected to line-voltage mains.

WARNING

Hazardous voltage of up to the instrument's maximum voltage may appear at High terminal if Interlock terminal is closed. Open the Interlock terminal when the High terminal is accessible. Voltage applied to the terminals will be limited up to ± 21 V.

Do not work the interlock function intentionally in order to bring the output voltage to the safe level. While the high voltage indicator is lit, the dangerous voltage by the output voltage or the residual charge appears on the measurement terminal.

- *DANGEROUS PROCEDURE WARNINGS*

Warnings, such as WARNING on the previous page, shall be complied. Procedures throughout in this manual prevent you from potentially hazard. Their instructions contained in the warnings must be followed.

- *BEFORE APPLYING POWER*

Verify that all safety precautions are taken. Make all connections to the instrument before applying power. Note the instrument's external markings described under "Safety Symbols".

- *GROUND THE INSTRUMENT*

This is Safety Class I instrument. To minimize shock hazard, the instrument chassis and cabinet must be connected to an electrical ground. The power terminal and the power cable must meet International Electrotechnical Commission (IEC) safety standards.

If the built-in battery is used for operation, connect the instrument chassis to an electrical ground through the earth (ground) terminal on the rear panel, for safety. Use the earthing wire furnished with the B2983A/B2987A.

- *DO NOT OPERATE IN AN EXPLOSIVE ATMOSPHERE*

Do not operate the instrument in the presence of flammable gases or fumes. Operation of any electrical instrument in such an environment constitutes a definite safety hazard.

- *DO NOT REMOVE COVERS*

No operator serviceable parts inside. Refer servicing to qualified personnel. To prevent electrical shock do not remove covers.

- *IN CASE OF DAMAGE*















Instruments that appear damaged or defective should be made inoperative and secured against unintended operation until they can be repaired by qualified service personnel. Return the instrument to a Keysight Technologies sales or service office for services and repair to ensure that safety features are maintained.

- *USE ONLY THE SPECIFIC ACCESSORIES*

Specific accessories satisfy the requirements for specific characteristics for using the instrument. Use the specific accessories, cables, adapters, and so on for safety reasons.

Safety Symbols

The general definitions of safety symbols used on equipment or in manuals are listed below.

-  Direct current.
-  Alternating current.
-  Earth (ground) terminal.
-  Protective conductor terminal. For protection against electrical shock in case of a fault. Used with field wiring terminals to indicate the terminal which must be connected to ground before operating equipment.
-  Frame or chassis terminal. A connection to the frame (chassis) of the equipment which normally includes all exposed metal structures.
-  Grounded terminal which indicates the earth potential.
-  On supply.
-  Off supply.
-  Standby supply. The equipment will be marked with this symbol is not completely disconnected from AC mains when power switch is in the standby position.
-  In position of a bi-stable push switch.
-  Out position of a bi-stable push switch.
-  Hazardous voltage and potential for electrical shock. Do not touch terminals that have this symbol when the equipment is on.
-  Hot surface. Avoid contact. Surfaces are hot and may cause personal injury if touched.
-  Caution, refer to accompanying documentation. The equipment will be marked with this symbol when it is necessary for the user to refer to the instruction manual.

WARNING

The warning sign denotes a hazard. It calls attention to a procedure, practice, condition or the like, which, if not correctly performed or adhered to, could result in injury or death to personal.

CAUTION

The caution sign denotes a hazard. It calls attention to an operating procedure, practice, condition or the like, which, if not correctly performed or adhered to, could result in damage to or destruction of part or all of the equipment.



Read operator's manual. To indicate that the operator's manual or card should be read before continuing the operation.



Rechargeable battery.

CAT I

IEC Measurement Category I



The CE mark shows that the product complies with all applicable European Directives.



UN Transportation Test



The CSA mark is a registered trademark of the Canadian Standards Association.



cURus : UL Recognized for Canadian and US market



The RCM mark is a registered trademark of the Australian Communications Authority. This signifies compliance with the Australian EMC Framework Regulations under the terms of the Radio communications Act.

ICES/NMB-001

This ISM device complies with Canadian ICES-001.

Cet appareil ISM est conforme à la norme NMB-001 du Canada.

ISM GROUP 1 CLASS A

This is the symbol for an Industrial, Scientific and Medical, Group 1 Class A product. (CISPR 11)



Korea's safety and EMC mark



China RoHS - Environmentally Green Product Label



China RoHS - Product with Toxic Substance 40 yr EPUP



China RoHS



The Chinese mark for paper-based packaging materials; Paperboard and Corrugated Fiberboard

CFB



Plastic Material Coding Identification



Four Arrow Recycling Mark, Taiwan



RBRC (Rechargeable Battery Recycling Corporation) Marking. For Canada and USA: Please call 1-800-822-8837 for information on how to recycle this battery.



FCC (Federal Communications Commission) Marking, USA



Three Arrow Recycling Mark: "mobius" logo and chemical symbols for recycling, Japan

Li-ion



PSE (Product Safety Electrical Appliance and Materials) Marking, Japan

Power Supply and Measurement Safety

- Power Supply Safety

This instrument can output high currents and voltages. Make sure that the load or device under test can safely handle the output current and voltage. Also, make sure that the connection leads can safely withstand the expected currents and are insulated for the expected voltages.

The instrument outputs may be connected so as to float relative to earth ground. Isolation or floating voltage ratings are indicated on the instrument, near the output terminal or the Chassis ground terminal. There is the danger of electric shock by touching the floated measurement terminals. Keep in mind it to protect yourself. And it is a reason of using the recommended accessories.

- Voltage/Current Measurement Safety

Multimeters and other instruments capable of measuring high voltages and currents are subject to specific safety concerns because of the circuits to which they may be connected. To safely use these instruments, you need to understand the markings on the instrument near the input terminals, which include the Protection Limits and the IEC Measurement Category.

- Protection Limits

Keysight multimeters and other voltage measurement instruments provide protection circuitry to prevent damage to the instrument and to protect against the danger of electric shock, provided the Protection Limits are not exceeded. To ensure safe operation of the instrument, do not exceed the Protection Limits shown on the input terminals.

- Voltage Source Terminals on Keysight B2985A/B2987A

Keysight B2985A/B2987A can apply DC voltage up to 1050 V between High and Low terminals. Voltage marked between the earth terminal and the Low/Common terminal indicates the floating usage limits.

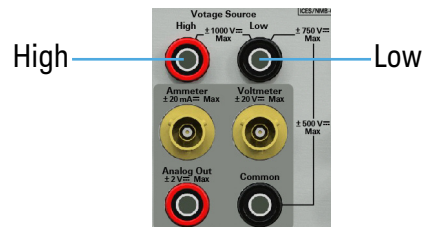



High Voltage Shock Hazard

Keysight B2985A/B2987A can apply dangerous voltages (± 1050 V) at the High/Low terminal. To prevent electric shock hazard, the following safety precautions must be observed during the use of Keysight B2985A/B2987A.

- Use a three-conductor AC power cable to appliance coupler (inlet) and the instrument to an electric ground (safety ground).
- Prepare shielding box which covers interface to a device under test and equipped with interlock circuit that opens when the door is opened.
- Before performing measurement, connect the interlock circuit to the Interlock terminal of this instrument.
- Confirm periodically that the interlock function works normally.
- Before touching the connections of the High/Low terminal, turn the instrument off and discharge any capacitors of the measurement path. If you do not turn the instrument off, complete "all" of the following items, regardless of any instrument's settings.
 - Terminate source output by pressing the On/Off switch, confirm that the On/Off switch turns off.
 - Confirm that the HV (high voltage) status indicator is not lit.
 - Open the shielding box access door (open the Interlock terminal).
 - Discharge any capacitors if the capacitance is connected to this instrument.
- Warn workers in the vicinity of the instrument about hazardous conditions.



Gefahr durch Hochspannung

Von den Geräten Keysight B2985A/B2987A können Spannungen an des High/Low-Anschlusses von bis zu 1050 V ausgehen. Um elektrischem Schlag vorzubeugen, ist bei der Benützung der Geräte Keysight B2985A/B2987A folgendes zu beachten.

- Verwenden Sie ein dreiphasiges AC-Stromkabel für die Gerätesteckvorrichtung (Eingang) und schließen Sie das Instrument an eine Erdung an (Sicherheitserdung).
- Bereiten Sie das Abschirmungsgehäuse vor, dass die Oberfläche eines zu testenden Geräts abdeckt und mit einem Verriegelungsstromkreis ausgestattet ist, der bei geöffneter Tür unterbrochen wird.
- Vor der Messung verbinden Sie den Verriegelungsstromkreis mit dem Interlock-Anschluss dieses Instruments.
- Prüfen Sie in regelmäßigen Abständen, dass die Verriegelungsfunktion ordnungsgemäß funktioniert.
- Bevor Sie die Verbindungen zu des High/Low-Anschlusses berühren, schalten Sie das Instrument aus und entladen alle Kondensatoren des Messwegs. Wenn Sie das Instrument nicht ausschalten, führen Sie, unabhängig von den Instrumenteinstellungen, alle folgenden Schritte durch.
 - Beenden Sie die Messung, indem Sie auf die Taste "On/Off" drücken. Stellen Sie sicher, dass die Statusanzeige "On/Off" nicht leuchtet.
 - Stellen Sie sicher, dass die Anzeige "HV" nicht leuchtet.
 - Öffnen Sie die Tür des Abschirmungsgehäuses (öffnen des Interlock-Anschlusses).
 - Entladen Sie alle Kondensatoren, wenn die Kapazität mit das Instrument verbunden ist.
- Warnen Sie Mitarbeiter in der Umgebung des Instruments vor den Gefahren.



Danger de choc dû à une haute tension

Une tension dangereuse (max. \pm pour; 1050 Vdc) émanant du dispositif Keysight B2985A/B2987A peut être sortie aux la borne High/Low, d'appareil de protection ou de détection. Les précautions suivantes doivent être obserées contre commotion électrique accidentelle.

- Utilisez un câble d'alimentation CA à trois conducteurs vers le coupleur secteur (entrée) et branchez l'instrument sur une mise électrique à la terre (prise de terre de sécurité).
- Préparez le boîtier de protection qui couvre l'interface avec le dispositif à tester et équipez-le d'un circuit de sécurité qui s'ouvre lors de l'ouverture d'une porte.
- Avant de procéder aux mesures, connectez le circuit de sécurité à la borne Interlock de l'instrument.
- Vérifiez régulièrement le bon fonctionnement de la fonction de sécurité.
- Avant de toucher les connexions de la borne High/Low, mettez l'instrument hors tension et déchargez tout condensateur du chemin de mesure. Si vous ne mettez pas l'instrument hors tension, effectuez « toutes » les opérations ci-dessous, quels que soient les paramètres de l'instrument.
 - Terminez les mesures en appuyant sur la touche On/Off ; vérifiez que l'indicateur d'état On/Off est éteint.
 - Vérifiez que le témoin HV est éteint.
 - Ouvrez la trappe d'accès au boîtier de protection (ouvrez la borne Interlock).
 - Déchargez les éventuels condensateurs si la capacité est connectée à l'instrument.
- Informez les personnes travaillant à proximité de l'instrument des conditions.



高電圧感電注意

Keysight B2985A/B2987A の High/Low 端子には、危険電圧が出力されることがあります (最大 ± 1050 Vdc)。感電事故防止のため、必ず以下の事柄を守ってください。

- ・ 3 極電源ケーブルを使用して本器を接地してください。
- ・ ドアを開くことによって開放されるインターロック回路を装備し、被測定デバイスとのインタフェースを覆うことのできるシールド・ボックスを用意してください。
- ・ 測定を開始する前にはインターロック回路を本器の Interlock 端子に接続してください。
- ・ インターロック機能が正常であることを定期的に確認してください。
- ・ High/Low 端子に繋がる接続部に触れる前には、本器の電源を切断してください。また、測定系のキャパシタを放電してください。電源を切らない場合は、以下の事項を全て実施してください。
 - ・ On/Off スイッチを押して On/Off スイッチが消灯したことを確認してください。
 - ・ 高電圧警告インジケータ (HV) が消灯していることを確認してください。
 - ・ シールド・ボックスのドアを開けてください (Interlock 端子を開放してください)。
 - ・ 本器にキャパシタが接続されているならば、キャパシタを放電してください。
- ・ 周囲のほかの作業者に対しても、高電圧危険に対する注意を徹底してください。

Product Stewardship



- Waste Electrical and Electronic Equipment (WEEE) Directive 2002/96/EC

This product complies with the WEEE Directive (2002/96/EC) marking requirements. The affixed label indicates that you must not discard this electrical/ electronic product in domestic household waste.

Product Category: With reference to the equipment types in the WEEE directive Annex 1, this product is classified as a "Monitoring and Control instrumentation" product.

Do not dispose in domestic household waste.

To return unwanted products, contact your local Keysight office or visit the following website for more information.

<http://about.keysight.com/en/companyinfo/environment/>

- Perchlorate Information

Perchlorate Material - special handling may apply. Visit the following website.

<http://www.dtsc.ca.gov/hazardouswaste/perchlorate/>

Equipment's real-time clock battery or coin cell battery may contain perchlorate and may require special handling when recycled or disposed of in California.

In This Manual

This manual describes the front panel operation, installation, and functions of the Keysight Technologies B2980 series. This manual consists of the following chapters.

- **Chapter 1, "Introduction"**
This chapter describes product overview, basic operation, accessories, and options of the Keysight B2980.
- **Chapter 2, "Installation"**
This chapter explains how to install the Keysight B2980.
- **Chapter 3, "How to Perform Measurement"**
This chapter explains how to perform measurement by using the Keysight B2980.
- **Chapter 4, "Front Panel Reference"**
This chapter provides the reference information of the Keysight B2980 front panel keys and graphical user interface.
- **Chapter 5, "Function Details"**
This chapter explains the several functions and initial settings of the Keysight B2980.
- **Chapter 6, "Working with Battery"**
This chapter describes installation, operation, and safety precautions for using Lithium-ion rechargeable battery. This chapter is for the B2983A/B2987A.

NOTE

For the specifications of the B2980 series, see Data Sheet.

To get the latest Data Sheet, go to www.keysight.com/find/b2980a and click “Technical Support” and “Specifications”.

NOTE

The information is subject to change without notice due to the future enhancement.

The actual screen image on the B2980 may be different from the image shown in this manual.

Contents



1. Introduction

Keysight B2980 Series	1-3
Front View	1-4
To Use the Field Pointer	1-10
To Change the Setting in the Field	1-10
To Change the Settings on a Dialog Box	1-11
Summary of Front Panel Operation	1-11
 Rear View	1-20
Software and Drivers	1-24
Productivity Tools	1-25
Accessories	1-26
Furnished Accessories	1-26
Available Accessories	1-26
Options	1-27

2. Installation

	2-2
Inspecting the Shipment	2-4
Checking the Operation of Keysight B2980	2-4
Checking for Errors	2-5
Installing Keysight B2980	2-6
Safety Considerations	2-6
Environment	2-6
Connecting the Power Cord	2-7
Setting the Power Line Frequency	2-9
Setting Date and Time	2-9
Bench Installation	2-9
Rack Installation	2-10

Contents

Maintenance	2-12
Cleaning	2-12
Self-test	2-12
Self-calibration	2-13
Calibration	2-13
 Installing the Interlock Circuit	2-14
Connecting to the Interfaces	2-17
GPIB/USB Interfaces	2-17
LAN Interface	2-19
Communicating Over the LAN	2-21
Using the Graphical Web Interface	2-21
Using Telnet	2-22
Using Sockets	2-22
Using Digital I/O and Trigger In/Out	2-24
3. How to Perform Measurement	
Current Measurement	3-5
Setup Parameters	3-8
Measurement Range	3-9
Aperture Time	3-10
 Common Terminal Connection	3-12
Voltage Measurement	3-14
Setup Parameters	3-17
Guarding	3-19
Resistance Measurement	3-21
Setup Parameters	3-28
Interlock	3-31
 Voltage Source	3-32
Charge Measurement	3-38

Contents

Setup Parameters	3-40
About Charge Measurement	3-41
Temperature and Humidity Measurement	3-42
Measurement Considerations	3-44
Insulating Material	3-44
Leakage Current on Connection Parts	3-44
Humidity and Temperature	3-44
Offset	3-45
Cable Noise	3-45
External Noise	3-46
Dielectric Absorption	3-46
Capacitive Coupling	3-47
Light	3-47

4. Front Panel Reference

Hard Keys and Rotary Knob	4-4
Key Functions for Changing the Settings	4-9
Display and Assist/Function Keys	4-11
Meter View	4-12
Graph View	4-31
Histogram View	4-34
Roll View	4-36
Status Information	4-39
Helper Panel	4-40
System Menu	4-41
Config key group	4-42
Output Connection dialog box	4-44
Sweep dialog box	4-45
Input Connection dialog box	4-45

Contents

Measure Filter dialog box	4-46
Wait Control dialog box	4-46
Function key group	4-48
Math Expression dialog box	4-48
Math Variable dialog box	4-49
Composite Limit Test Setup dialog box	4-49
Limit Test Setup dialog box	4-51
Trace Buffer Setup dialog box	4-52
Trigger key group	4-53
Trigger Configuration dialog box	4-53
Result key group	4-56
Measure Result dialog box	4-56
Limit Test Result dialog box	4-56
Trace Statistical Result dialog box	4-57
File key group	4-58
File Selection dialog box	4-58
Program key group	4-60
I/O key group	4-61
Data Output Format	4-62
Format (Measure) dialog box	4-63
Format (Math/Limit) dialog box	4-63
Format (Trace) dialog box	4-63
LAN Configuration dialog box	4-64
DIO Configuration dialog box	4-64
DIO Read/Write dialog box	4-65
BNC Configuration dialog box	4-66
Display key group	4-67
Display Preference dialog box	4-68
System key group	4-70

Contents

5. Function Details

Measurement Range	5-3
Automatic Ranging Speed	5-4
Setting the Ranging Mode	5-4
Measurement Time	5-5
Aperture Time	5-5
Overhead Time	5-7
To Control Source/Measure Timing (B2985A/B2987A)	5-7
Null, Offset Cancel	5-9
Current Measurement (B2981A/B2983A/B2985A/B2987A) and Charge Measurement (B2985A/B2987A)	5-9
Voltage Measurement (B2985A/B2987A)	5-10
Resistance Measurement (B2985A/B2987A)	5-11
Measurement Filter	5-12
Analog Output	5-14
Voltage Source (B2985A/B2987A)	5-16
Staircase Sweep Output	5-16
List Sweep Output	5-17
Square Waveform Output	5-17
Ranging Mode of Voltage Source	5-18
Output-Off Status	5-18
Current Limiting Resistor	5-19
Triggered Voltage Source	5-19
Interlock Function (B2985A/B2987A)	5-20
Temperature and Humidity Measurements (B2985A/B2987A)	5-21
Temperature Measurement	5-21
Humidity Measurement	5-21
Math Expression	5-22

Contents

Predefined Math Expressions	5-22
Resources Used in the Expressions	5-25
Limit Test	5-28
Trace Buffer	5-31
Program Memory	5-34
Trigger System	5-35
Trigger Source.	5-37
Device Actions.	5-37
Trigger Output.	5-38
Save/Recall Function	5-40
File Access Function (Easy File Access).	5-41
PLC Detection and Setup Functions	5-42
Real-time Noise Monitor	5-43
Setup Integrity Checker	5-45
Introduction.	5-45
Operation	5-46
Performing Noise Check.	5-47
Considering Noise Reduction.	5-49
Execution Examples	5-50
Initial Settings	5-52
6. Working with Battery	
Before Using Battery	6-4
Built-in Charge Level LED	6-5
To Install Battery.	6-5
To Remove Battery	6-5
To Maximize Battery Life.	6-6
Battery Charge Level Indicator.	6-6

Contents

Battery Care	6-6
Supplemental Characteristics	6-7
Charging Battery	6-8
To Use Instrument	6-8
To Use Battery Charger	6-8
Safety Considerations	6-9
For Battery	6-9
For Battery Charger	6-12
Packing and Transportation	6-12
Spent Batteries	6-12

Contents

1 **Introduction**

Introduction

This chapter describes the basic functions and features of Keysight B2980, and consists of the following sections.

- "Keysight B2980 Series"
- "Front View"
- "Rear View"
- "Software and Drivers"
- "Productivity Tools"
- "Accessories"
- "Options"

Keysight B2980 Series

Keysight B2980 series provides the product lineup listed below. Differences between models are summarized in [Table 1-1](#).

- B2981A Femto/Picoammeter
- B2983A Femto/Picoammeter with Battery
Ammeter for ultra low DC current measurement in atto ampere resolution
- B2985A Electrometer/High Resistance Meter
- B2987A Electrometer/High Resistance Meter with Battery

All in one instrument supporting the functions of DC voltage source, voltmeter, ammeter, electrometer, and high resistance meter. This instrument also performs staircase/list sweep voltage output, square wave voltage output, temperature measurement, and humidity measurement.

The B2983A/B2987A has built-in Lithium-ion battery. Using it without connecting to AC power line is effective for realizing low noise measurement.

The B2980 has LCD, front panel keys, and rotary knob for controlling it alone. It also supports several functions, such as limit test, trace buffer, math expressions, and graph plot.

The SCPI (Standard Commands for Programmable Instruments) commands are available for performing automatic measurement using an external computer.

The B2980 is a LAN eXtended Interface Core compliant instrument.

Table 1-1 **Keysight B2980 Series**

Model No.	Battery operation	Measurement function (maximum value)				Voltage source (maximum value)
		Current	Voltage	Charge	Resistance	
B2981A	no	± 21 mA	none	none	none	none
B2983A	yes		± 21 V	± 2.1 μC	1000 PΩ ^a	
B2985A	no					± 1050 V
B2987A	yes					

a. Just reference for the Manual V Control mode

Front View

This section describes the front view of Keysight B2980 series.



- Standby switch

Turns the instrument on or off. During the power is on, the LED below the switch turns green. After booting up normally, the front panel LCD displays the image as shown below. For the B2983A/B2987A, the LED turns orange during the switch is off and the battery charging is in progress.

B2981A/B2983A

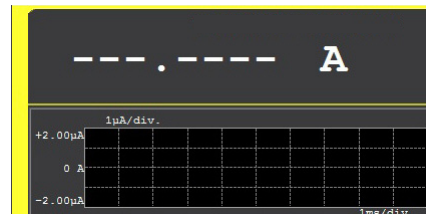

B2985A/B2987A

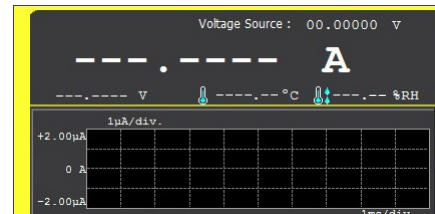

- Single key

Starts a single (one shot) measurement or initiates trigger system. Also triggers the staircase/list sweep output or the square wave output of the B2985A/B2987A. If a repeat measurement is in progress, stops it and starts a single measurement. The measurement result is displayed on the Meter view, Graph view, Histogram view, or Roll view.

Once a single measurement starts, data buffer is cleared and stores the last single measurement result (maximum of 100000 data). It can be listed and displayed on the Measure Result dialog box.

NOTE

If measurement is not performed properly, confirm the trigger setting. The trigger type should be set to AUTO, or the trigger count (Count) should be set properly. See ["Trigger Setup Sub-panel" on page 4-28](#).

- Run/Stop key

Starts a repeat (continuous) measurement. If a repeat measurement is in progress, just stops it. The measurement result is displayed on the Meter view, Histogram view, or Roll view.

Once a repeat measurement starts, data buffer is cleared and stores the last repeat measurement result (maximum of 1000 data). It can be listed and displayed on the Measure Result dialog box.

- USB-A connector

Used to connect a USB memory. After disconnecting the USB memory, wait 10 seconds before connecting it again or new one.

CAUTION

Turning the instrument off while the USB memory is being accessed may damage the device.

- LCD

4.3" color TFT. Displays the instrument setup, measurement result, status information, etc. The status information is displayed near bottom of the display. The following indicators are available.

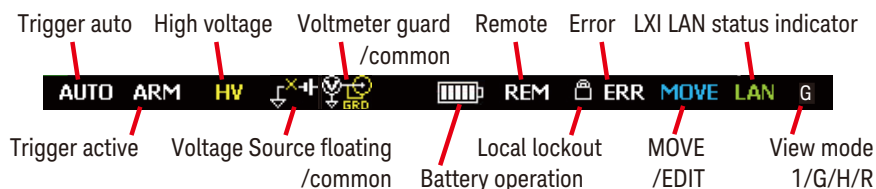

Introduction
Front View

- Function keys

Six function keys are placed below the LCD. They are assigned to the softkeys, SPEED, RANGE, Zoom, Clear, Apps, System Menu, and so on. The softkey assignment depends on the view mode (Meter, Graph, Histogram, or Roll).

- Assist keys

Five assist keys are placed right to the LCD. They are assigned to softkeys which assist you in changing the measurement setup. The softkey assignment depends on the view mode and the setup field in the EDIT (green) status.

- View key

Switches the softkey assignment for the function keys as follows.

- Softkeys available for the present view mode
- Softkeys for selecting the view mode

The following softkeys are available. Press one for selecting the view mode.

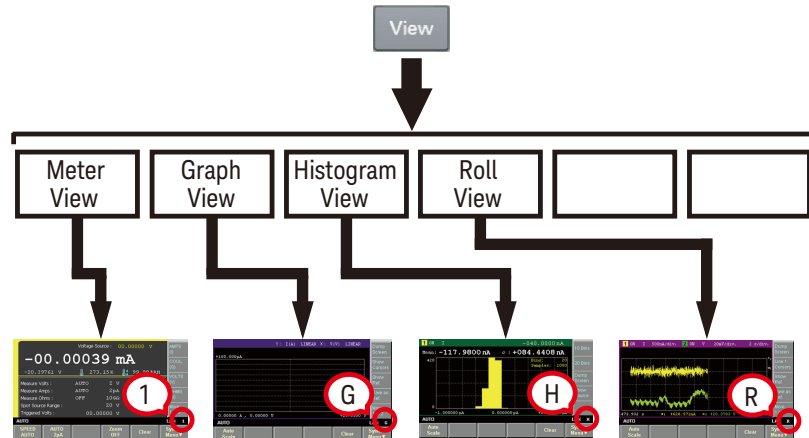

- Cancel / Local key

Cancels the setup operation if the instrument is in the local state.

Returns the instrument to the local state if it is in the remote control state.

- Rotary knob

If the field pointer is in the MOVE (blue) status, turning the knob moves the pointer. Pressing the knob fixes the pointer position and changes the pointer status to EDIT (green). See ["To Use the Field Pointer" on page 1-10](#).

If the field pointer is in the EDIT (green) status, turning the knob changes the value of the setup parameter on the pointer. Pressing the knob fixes the value and changes the pointer status to MOVE (blue).

- Measurement navigation keys

Used to change SPEED and RANGE settings. The following keys are available.

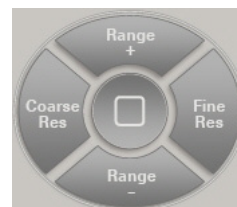

Coarse Res	Coarse resolution. Increases measurement speed (decreases aperture time).
Range +	Changes measurement range up.
[home]	Sets AUTO range and Normal auto aperture.
Range -	Changes measurement range down.
Fine Res	Fine resolution. Decreases measurement speed (increases aperture time).

- Null key

Enables or disables the null (offset cancel) function. For more detail, see "[Null, Offset Cancel](#)" on page 5-9.

- Filter key

If the FILT indicator has turned off, pressing the Filter key opens the Measure Filter dialog box. Pressing OK after setting up the dialog box enables the filter function and turns the FILT indicator on.

If the FILT indicator has turned on, pressing the Filter key disables the function and turns the FILT indicator off.

- Math key

If the MATH indicator has turned off, pressing the Math key opens the Math Expression dialog box. Pressing OK after setting up the dialog box enables the math function and turns the MATH indicator on.

If the MATH indicator has turned on, pressing the Math key disables the function and turns the MATH indicator off.

- Save and Recall keys

Used to save/recall all setup information of the instrument. Five storage areas are available in the built-in non-volatile memory (NVRAM) for this purpose.

Pressing the Save or Recall key opens a message box and displays five function keys used for selecting the storage area. Then pressing a function key saves or recalls the setup information.

The label #n <Empty> is set to the key for the unused storage area. The key for the used storage area has the label #n HH:MM:SS (time). Where, #n is #1, #2, #3, #4, or #5.

NOTE**Save and Recall keys as arrow keys**

The Save key is also assigned to the left arrow key.

The Recall key is also assigned to the right arrow key.

If the field pointer is in the EDIT (green) status on an alpha/numeric value entry field such as Voltage Source and File Name, the keys work to change the field pointer to the digit pointer. With the digit pointer, the keys work to move it.

Note that the keys cannot move the field pointer when it is in the MOVE (blue) status.

- Ammeter On/Off switch

Enables or disables Ammeter. In the On status, the Ammeter triaxial connector's center conductor is connected to Ammeter and the switch turns green. In the Off status, it is connected to Common and the switch light turns off. Pressing the On (green) switch turns it to the Off status even if the instrument is in the remote control state.



- Voltmeter, for B2985A and B2987A

No switch for Voltmeter. The voltmeter is always effective.



- Voltage Source On/Off switch, for B2985A and B2987A

Enables or disables Voltage Source. In the On status, the Voltage Source High terminal is connected to Voltage Source and the switch turns green. In the Off status, the output terminal is opened and the switch light turns off. Pressing the On (green) switch turns it to the Off status even if the instrument is in the remote control state.



The switch turns red if the voltage source is in the high voltage state over ± 21 V.

- Battery charge level indicator, for B2983A and B2987A

Indicates charge level of the built-in Lithium-ion rechargeable battery.

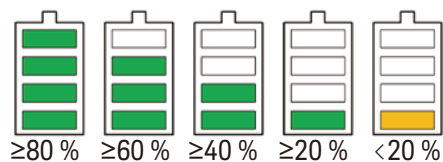

When the instrument power is off and the battery charging is in progress, the LED below the standby switch turns orange.

To Use the Field Pointer

Use the field pointer to specify an entry field in the setup screen. The field pointer can take the following status. Change the status as needed during the setup. The present status can be known by the pointer color and the MOVE/EDIT indicator shown in "LCD" on page 1-5.

- | | |
|--------------------|--|
| MOVE status | The pointer is highlighted in blue. You can move the pointer from field to field by turning the rotary knob. |
| EDIT status | The pointer is highlighted in green. You can change the setting in the field. |

To Change the Setting in the Field

1. If the field pointer is green, press the rotary knob. The pointer status is changed to MOVE (blue).
2. Turn the rotary knob to move the field pointer.
3. Move the pointer on the field to change the setting and press the rotary knob. The pointer status is changed to EDIT (green).
4. Change the setting by turning the knob or pressing an assist key or a navigation key. The value is fixed by pressing the knob or an assist key. Fixing the value or pressing the Cancel/Local key changes the pointer status to MOVE (blue).

In the EDIT status on an alpha/numeric value entry field such as Voltage Source and File Name, the digit pointer is available.

Digit Pointer

When an alpha/numeric value entry field is in the EDIT status (i.e., all digits in the field are highlighted in green), pressing the Save, Recall, Coarse Res, or Fine Res key changes the pointer to the digit pointer, which points only one digit in the field. In this status, the following operations are available.

- Pressing Save, Recall, Coarse Res, or Fine Res key moves the digit pointer.
- Turning the rotary knob or pressing Range + or Range - key changes the value.

Changing the value from 9 to 0 or from 0 to 9 changes the value of the upper digit.

- Turning the rotary knob or pressing the Range +/Range - key on the decimal point moves the decimal point if real time update is OFF. For the real time update, see "Voltage Source Output (B2985A/B2987A)" on page 1-11.

When the digit pointer is available on an alpha numeric value entry field such as File Name and Variable Strings, the helper panel is displayed above the field. The helper panel allows you to enter a character into the specified digit. It is not available for the numeric value entry fields such as Voltage Source and Triggered Voltage Source.

Note that the Save, Recall, Coarse Res, and Fine Res keys cannot move the field pointer when it is in the MOVE (blue) status.

Voltage Source Output (B2985A/B2987A)

If the Voltage Source field is in the EDIT status, turning the rotary knob changes the display value and updates the voltage source output in real time.

However, if the digit pointer is available, the voltage source works as follows. The operation depends on the setting of the real time update.

- Real time update: ON

Turning the rotary knob changes the display value and updates the voltage source output in real time. Cannot move the decimal point using the digit pointer.

- Real time update: OFF

Turning the rotary knob just changes the display value. The value is applied to the voltage source output by pressing the rotary knob.

The setting of the real time update can be changed by using the Immediate Voltage Update by Knob field on the Display Preference dialog box opened by pressing the System Menu > More... (1 of 2) > Display > Pref. function keys.

To Change the Settings on a Dialog Box

1. Set the items on the dialog box in the same way as described in ["To Change the Setting in the Field" on page 1-10](#).
2. To apply the settings, press Apply.
To apply all settings and close the dialog box, press OK.
To cancel the setting change, press the Cancel/Local key instead of Apply.

Summary of Front Panel Operation

Front panel operations are summarized in Tables [1-2](#) to [1-9](#).

For details, see [Chapter 4, "Front Panel Reference."](#)

Table 1-2 Basic Operations

Task	Relevant front panel key
To turn the B2980 on/off	Standby switch
To change the view mode	View key
To enable/disable Ammeter	Ammeter On/Off switch
To start a single (one shot) measurement	Single key
To start a repeat (continuous) measurement	Run/Stop key
To stop repeat measurement	Run/Stop key or Single key
To save the all setup information into the built-in non-volatile memory	Save key
To recall the setup information saved in the built-in non-volatile memory	Recall key
To display the field pointer if it is not shown	Turning the rotary knob
To move the field pointer	Turning the rotary knob
To switch the MOVE/EDIT status on an entry field	Pressing the rotary knob on the entry field
To change the field pointer to the digit pointer This is effective only for an alpha/numeric value entry field in the EDIT status.	Pressing Save , Recall , Coarse Res , or Fine Res key when the alpha/numeric value entry field is in the EDIT status.
To move the digit pointer	Save , Recall , Coarse Res , or Fine Res key
To fix the value on the entry field in the EDIT status	Rotary knob, assist key, or navigation key
To cancel the setup operation	Cancel/Local key
To return to the upper menu of a function key or softkey	Cancel/Local key
To return to the local state from the remote state	Cancel/Local key
To clear measurement buffer	Clear function key
To launch the setup integrity checker	Apps function key > #1 assist key
To launch the data logger	Apps function key > #2 assist key

Task	Relevant front panel key
To launch the sequential measurement for B2985A/B2987A	Apps function key > #3 assist key
To launch the demo slide show	Apps function key > #4 assist key
To open the About B298xA dialog box	Apps function key > #5 assist key

Table 1-3 Measurement Setup

Task	Relevant front panel key
To set measurement speed/aperture time	Coarse Res / [<i>home</i>] / Fine Res key or SPEED function key
To set measurement range	Range + / [<i>home</i>] / Range - key or RANGE function key
To use offset cancel/zero correction	Null key
To set measurement filter	Filter key
	System Menu > Config > Measure > Filter function keys
To set auto ranging speed	System Menu > Config > Measure > Ranging function keys
To set trigger parameters on sub-panel	Show Trigger assist key
To show range setup sub-panel	Hide Noise/Hist./Roll/Trigger assist key Or, Hide VS Func. assist key, for B2985A/B2987A
To select measurement mode for B2985A/B2987A	AMPS (I) / COUL (Q) / VOLTS (V) / OHMS (R) assist key
To set measurement mode applied to Analog Out for B2985A/B2987A	System Menu > Config > Measure > Connection function keys
To select inner shield connection, guard or common, of the Voltmeter input terminal for B2985A/B2987A	System Menu > Config > Measure > Connection function keys
To enable/disable the automatic discharge function for the charge measurement for B2985A/B2987A	System Menu > Config > Measure > Coulomb > Auto Dis. function keys

Introduction
Front View

Task	Relevant front panel key
To select the level of the automatic discharge function for the charge measurement for B2985A/B2987A	System Menu > Config > Measure > Coulomb > Dis. Level function keys
To select resistance calculation mode for the resistance measurement for B2985A/B2987A	System Menu > Config > Measure > Ohms > V Select function keys
To select voltage source control mode for the resistance measurement for B2985A/B2987A	System Menu > Config > Measure > Ohms > V Control function keys
To set the resistance measurement result to absolute format for B2985A/B2987A	System Menu > Config > Measure > Ohms > Absolute function keys
To set the attenuation level for voltage measurement with the Keysight N1413A/N1414A adapter for B2985A/B2987A	System Menu > Config > Measure > Volts > Attn. function keys
To set up the source and measurement wait time for B2985A/B2987A	System Menu > Config > Common > Wait function keys

Table 1-4 Voltage Source Setup, for the B2985A/B2987A

Task	Relevant front panel key
To set DC voltage output level	Source assist key
To enable/disable Voltage Source output	Voltage Source On/Off switch
To start the sweep or square wave output	Single key
To select the Voltage Source Low terminal state, common or floating	System Menu > Config > Source > Connection function keys
To select output-off state	System Menu > Config > Source > Connection function keys
To connect/disconnect the built-in series resistor	System Menu > Config > Source > Connection function keys
To enable/disable real time update	System Menu > Display > Pref. function keys
To set DC voltage output range	Range setup sub-panel on the Meter view
To set square wave source	Show VS Func. assist key
To set staircase sweep source	Show VS Func. assist key
To set list sweep source	Edit assist key for the list sweep Start/Stop/Points field in the EDIT status
To set staircase sweep ranging mode	System Menu > Config > Source > Sweep function keys
To set staircase sweep direction	System Menu > Config > Source > Sweep function keys
To set output voltage after sweep	System Menu > Config > Source > Sweep function keys
To set up the source and measurement wait time	System Menu > Config > Common > Wait function keys
To show/hide source output preview	Show Preview or Hide Preview assist key
To set the level of the source output applied by receiving a trigger	Range setup sub-panel on the Meter view

Table 1-5 Display Setup

Task	Relevant front panel key
To change the color set	System Menu > Display > Color Set function keys
To perform zoom-in/out Meter view	Zoom function key
	System Menu > Display > Zoom function keys
To change the data digits	System Menu > Display > Digits function keys
To enable/disable the display when the instrument is in the remote condition	System Menu > Display > Remote function keys
To show/hide Histogram preview	Show Hist. or Hide Hist. assist key
To show/hide Roll preview	Show Roll or Hide Roll assist key
To show/hide the display of secondary measurement data, temperature data, and/or humidity data, for B2985A/B2987A	System Menu > Display > Pref. function keys

Table 1-6 File Operations

Task	Relevant front panel key
To save a measurement result data to USB memory	System Menu > File > Save > Measure function keys
To save a math result data to USB memory	System Menu > File > Save > Math function keys
To save a limit test result data to USB memory	System Menu > File > Save > Limit Test function keys
To save a trace buffer data to USB memory	System Menu > File > Save > Trace function keys
To save a system setting data to USB memory	System Menu > File > Save > Config function keys
To save a graph screen dump to USB memory	Dump Screen assist key on Graph/Roll/Histogram view
To load a system setting data from USB memory	System Menu > File > Load > Config function keys
To load a license file from USB memory	System Menu > File > Load > License function keys
To load a list sweep data from USB memory	Load assist key for the list sweep Start/Stop/Points field in the EDIT status

Table 1-7 **Miscellaneous Functions**

Task	Relevant front panel key
To see measurement result	System Menu > Result > Measure function keys
To use math expression	Math key
	System Menu > Function > Math function keys
To see math result	System Menu > Result > Measure function keys
To set limit test	System Menu > Function > Limit Test function keys
To see limit test result	System Menu > Result > Limit Test function keys
To set trace buffer	System Menu > Function > Trace function keys
To see trace statistical result	System Menu > Result > Trace function keys
To select program memory	System Menu > Program > Catalog function keys
To control program memory	System Menu > Program > Control function keys
To set trigger parameters on sub-panel	Show Trigger assist key
To set trigger parameters in detail	System Menu > Trigger > Config function keys
To control trigger system	System Menu > Trigger > Initiate/Abort/Immediate function keys

Table 1-8 Interface Setup

Task	Relevant front panel key
To specify measurement data elements	System Menu > I/O > Format > Measure function keys
To specify math and limit test data elements	System Menu > I/O > Format > Math/Limit function keys
To specify trace statistical data elements	System Menu > I/O > Format > Trace function keys
To select data output format	System Menu > I/O > Format > Data Type function keys
To enable/disable byte swap of binary data	System Menu > I/O > Format > Data Swap function keys
To set LAN configuration	System Menu > I/O > LAN > Config function keys
To see status of LAN interface	System Menu > I/O > LAN > Status function keys
To reset all of LAN connections	System Menu > I/O > LAN > Reset function keys
To sets LAN settings to the default settings	System Menu > I/O > LAN > Default function keys
To enable/disable Media Transfer Protocol for easy file access	System Menu > I/O > USB function keys
To see status of USB interface	System Menu > I/O > USB function keys
To set GPIB address	System Menu > I/O > GPIB function keys
To see status of GPIB interface	System Menu > I/O > GPIB function keys
To set configuration of Digital I/O	System Menu > I/O > DIO > Config function keys
To read/write a value set to Digital I/O	System Menu > I/O > DIO > R/W function keys
To set BNC Trigger In/Out	System Menu > I/O > BNC function keys

Table 1-9 System Setup and Operations

Task	Relevant front panel key
To enable/disable power-on automatic detection of power line frequency	System Menu > System > Start-up function keys
To set power line frequency	System Menu > System > PLC function keys
To initialize B2980	System Menu > System > Reset function keys
To return B2980 to the condition when it is shipped from the factory	System Menu > System > Factory Reset function keys
To perform self-calibration	System Menu > System > Cal/Test > Self-Cal function keys
To perform self-test	System Menu > System > Cal/Test > Self-Test function keys
To check errors	System Menu > System > Error > Log function keys
To clear error log	System Menu > System > Error > Clear function keys
To clear time stamp	System Menu > System > Timestamp > Clear function keys
To set automatic clear of time stamp	System Menu > System > Timestamp > Auto CLR function keys
To set start-up operation	System Menu > System > Start-up function keys
To enable/disable beep and sound	System Menu > System > Sound function keys
To select remote control command set	System Menu > System > Language function keys
To check revision information	System Menu > System > Info. > Revision function keys
To set date and time	System Menu > System > Info. > Date/Time function keys
To perform firmware update	System Menu > System > Info. > Update > Firmware function keys
To perform demonstration	System Menu > System > Info. > Demo. function keys
To load a system setting data	System Menu > File > Load > Config function keys
To install license file	System Menu > File > Load > License function keys

Rear View

This section describes the rear view of Keysight B2980 series.

B2981A/B2983A

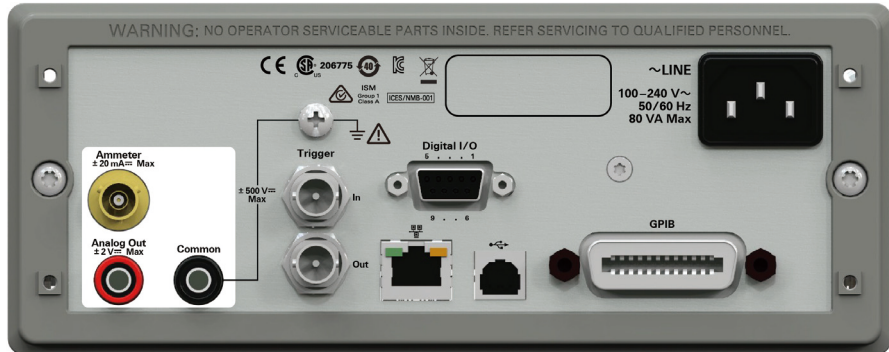

B2985A/B2987A

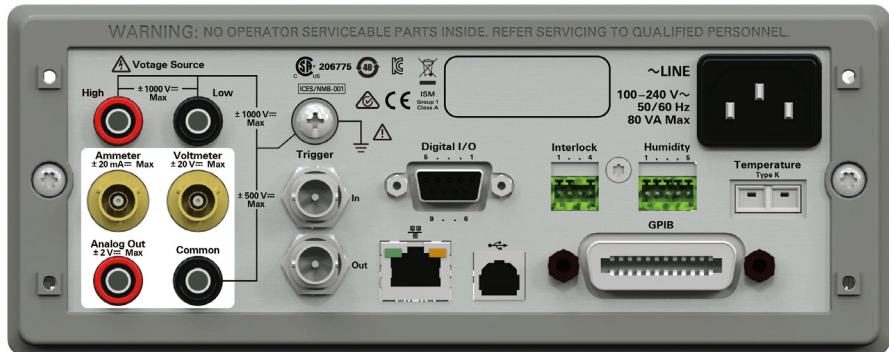

- Ammeter input connector

Triaxial connector for current measurement.

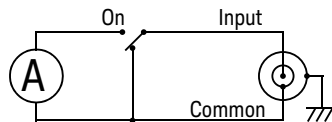

Ammeter ON or OFF can be controlled by the On/Off switch.

For protecting the connector, connect an open cap (furnished) when the ammeter is not used.

- Analog Out terminal

Banana terminal for analog output. Always outputs the voltage proportional to the present measurement result. Maximum output voltage is ± 2 V.

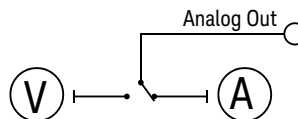

For example, the output voltage is 2 V if the measurement result is the full scale value of the measurement range or 0.2 V if the result is 10 % of the full scale.

- Common terminal

Banana terminal for circuit common. This is the Common for the Ammeter, the Voltmeter, and the Analog Out.

For the grounded measurement, this terminal must be connected to the earth (ground) terminal by using a Banana-to-Lug cable (furnished).

WARNING

If the Common terminal is *not* connected to the earth (ground) terminal (for floating measurement), potentially hazardous voltage of up to ± 500 V may be applied to the Common terminal. To prevent electrical shock, do not touch any of measurement circuit at any time while a floating measurement is in progress. Also use accessories that comply with IEC 61010-2-031. All terminals and the extended conductors must be isolated by using insulation caps, sleeves, etc.

WARNING

Si le terminal commun n'est pas connecté au terminal terrien (borne de terre) (pour des mesures de flotte), une éventuelle tension dangereuse supérieure à ± 500 V peut être appliquée au terminal commun. Afin d'éviter toute décharge électrique, ne touchez aucune mesure de circuit à tout moment lorsque la mesure de flotte est en cours. Utiliser également des accessoires qui sont conformes à la norme IEC 61010-2-031. Toutes les bornes et les conducteurs prolongés doivent être isolés en utilisant des bouchons d'isolation, des manchons, etc.



- Earth (ground) terminal

Terminal connected to earth (ground) through the power cord. This terminal is also connected to the frame (chassis) of this instrument.

For B2983A/B2987A, if the power cord is removed from the instrument and the built-in battery is used for operation, connect the instrument chassis to an electrical ground through this terminal, for safety. Use the earthing wire furnished with the B2983A/B2987A.

CAUTION

Do not apply current to this terminal. Doing so will damage the instrument.

Introduction
Rear View

- Trigger In and Out connectors

Two BNC connectors, one for trigger input, and one for trigger output. Used to perform the operation synchronized with an external equipment. For more information, see ["Using Digital I/O and Trigger In/Out" on page 2-24.](#)

- Digital I/O connector

D-sub 9 pin female connector for general purpose I/O (GPIO). Can be used as an interface to a handler or the likes. For more information, see ["Using Digital I/O and Trigger In/Out" on page 2-24.](#)

- LAN interface connector

Connects to 10/100 Base-T interface. Left LED indicates activity. Right LED indicates link integrity.

- USB-B connector

Connects to USB interface.

- GPIB interface connector

Use Keysight 82357A/B USB/GPIB interface or Keysight 10833A/B/C/D/F/G GPIB cable to connect to an external computer or equipment.

- AC input connector

AC power cord is connected to this receptacle.

- Serial Number

You will need the instrument's *serial number* when using Keysight Technologies telephone assistance program. The serial number label is attached to the bottom of the instrument.



- Voltage Source High and Low terminals, for B2985A and B2987A

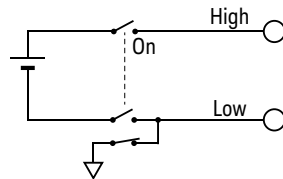

Banana terminals for DC voltage output up to ± 1050 V.

Voltage Source ON or OFF can be controlled by the On/Off switch.

Low terminal state, circuit common or floating, can be set by using the Low

Terminal State field on the Output Connection dialog box opened by pressing the System Menu > Config > Source > Connection function keys.

- Voltmeter input connector, for B2985A and B2987A

Triaxial connector for voltage measurement.

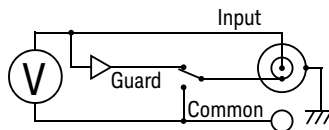

Voltmeter inner shield state, guard or circuit common, can be set by using the Voltage Measure Inner Shield field on the Input Connection dialog box opened by pressing the System Menu > Config > Measure > Connection function keys.

For protecting the connector, connect an open cap (furnished) when the voltmeter is not used.

- Interlock connector, for B2985A and B2987A

Connector for the interlock function. If the interlock terminals are open, the instrument output is limited to ± 21 V. Be sure to connect the terminals to an interlock circuit installed in a test fixture or a connection interface for performing measurements over this limit. If there is no interlock circuit, you need to install it. For details on how to install the interlock circuit, see "[Installing the Interlock Circuit](#)" on page 2-14.

One connector head, Phoenix Contact 1881341 (4 pin) or equivalent, is furnished with the instrument for connecting an interlock circuit.

WARNING

Dangerous voltage of up to the maximum voltage of ± 1050 V may be present between the High and Low terminals of the Voltage Source if the Interlock terminal is closed.

WARNING

Une tension dangereuse supérieure à la tension maximale de ± 1050 V risque d'être présente à la borne du délivreur de haute tension si la borne d'enclenchement est fermée.

- Humidity sensor connector, for B2985A and B2987A

Connector for humidity sensor used for relative humidity measurements.

One connector head, Phoenix Contact 1551354 (5 pin) or equivalent, is furnished with the instrument for connecting a humidity sensor, E+E Elektronik EE07 or equivalent. The humidity sensor and the connection cable are not furnished with the instrument.

- Thermocouple connector, for B2985A and B2987A

Connector for Type K thermocouple used for temperature measurements.

One thermocouple, Keysight N1423A is furnished with the instrument.

Software and Drivers

This section introduces software and drivers available for Keysight B2980.

- Quick IV Measurement Software

PC-based measurement control software. This powerful software makes it easy to quickly setup and perform I/V measurements and to display the measurement data in a table or graph without the need to perform any programming. The software allows you to control up to four B2900 channels over a GPIB or LAN connection, or one B2900 instrument via a USB connection.

System requirements:

- Windows 10 (32bit/64bit), 8 (32bit/64bit), 7 (32bit/64bit)
- Microsoft .NET framework 4.5 or later
- Keysight IO Libraries Suite 17.0 or later

- Graphical Web Interface

Web browser based instrument control panel. It enables you to set up and perform a measurement easily and quickly from a web browser using the built-in web server. This allows you to control one B2980 over a LAN connection.

- IVI-C or IVI-COM drivers

Compatible with Keysight IO Libraries Suite 17.0 or later. Supports Keysight VEE, Microsoft Visual Studio (Visual Basic, Visual C++, Visual C#), National Instruments LabWindows and LabVIEW.

- LabVIEW driver (VI)

National Instruments LabVIEW 7.0 or later. LabView drivers are available at NI.COM.

NOTE

For the latest system requirements, go to www.keysight.com and type in B2980A in the Search field at the top of the page.

Productivity Tools

Table 1-10 lists the productivity tools for Keysight B2980.

Table 1-10 **Productivity Tools**

Model Number	Option Item	Description
N1410A		Starter kit for B2985/B2987 <ul style="list-style-type: none">• Triaxial to alligator clip cable, 200 V, 1.5 m, 1 ea.• High resistance measurement universal adapter, 1 ea.
N1420A		Setup integrity checker for B2980 series, fixed perpetual license
N1422A		High value resistor box for N1299A-301 evaluation kit
N1299A	N1299A-301	Evaluation kit for B2981/83/85/87A <ul style="list-style-type: none">• High value resistor box, 1 ea.• Triaxial to alligator clip cable, 200 V, 1.5 m, 1 ea.• Interlock cable, 4 pin terminal plug to 6 pin circular plug, 1.5 m, 1 ea.• BNC coaxial cable, 1.5 m, 1 ea.• Triaxial (m) to BNC (f) adapter, outer shield open, 1 ea.• Carrying case, 1 ea.• Demonstration guide, 1 ea.

Accessories

Furnished Accessories

Keysight B2980 is furnished with the following accessories.

- Quick Startup Poster, 1 ea.
- Quick Reference, 1 ea.
- Product Reference CD-ROM, 1ea.
- Keysight IO Libraries CD-ROM, 1ea.
- Power cord, 1 ea.
- Earthing wire, 2 m, 1 ea. for B2983A/B2987A
- USB cable, 1 ea.
- Banana to lug cable, 1 ea.
- Triaxial cable, 200 V, 1.5 m, 1 ea.
- Open cap for triaxial connector, 1 ea. for B2981A/B2983A, 2 ea. for B2985A/B2987A
- High voltage test lead set, 1000 V, 1.2 m, 1 ea. for B2985A/B2987A
- Thermocouple, type K, 3.5 m, 1 ea. for B2985A/B2987A
- Interlock connector head, 1 ea. for B2985A/B2987A
- Humidity probe connector head, 1 ea. for B2985A/B2987A

The Product Reference CD-ROM stores user manuals, programming examples, etc.

Available Accessories

For the available accessories for the Keysight B2900 series, see the catalog *Accessories for the Keysight B2900 Precision Instrument Family*.

To get the latest catalog, go to www.keysight.com/find/b2980a and click “Technical Support” and “Catalogs”.

Options

Table 1-11 lists the options for Keysight B2980.

Table 1-11 Options

Model Number	Option Item	Description
B2981A	B2981A-A6J	ANSI Z540 compliant calibration
	B2981A-UK6	Commercial calibration certificate with test data
B2983A	B2983A-A6J	ANSI Z540 compliant calibration
	B2983A-UK6	Commercial calibration certificate with test data
B2985A	B2985A-A6J	ANSI Z540 compliant calibration
	B2985A-UK6	Commercial calibration certificate with test data
B2987A	B2987A-A6J	ANSI Z540 compliant calibration
	B2987A-UK6	Commercial calibration certificate with test data

Introduction
Options

2

Installation

This chapter describes how to install Keysight B2980 and covers the following topics.

- "Inspecting the Shipment"
- "Installing Keysight B2980"
- "Maintenance"
- "Installing the Interlock Circuit"
- "Connecting to the Interfaces"
- "Communicating Over the LAN"
- "Using Digital I/O and Trigger In/Out"

WARNING

For the B2985A/B2987A users

There are potentially hazardous voltages (max. ± 1050 V) present between the High and Low terminals of the Voltage Source. To prevent electrical shock, the following safety precautions must be observed during the use of the instrument.

- **Use a three-conductor AC power cord to connect the cabinet (if used) and the instrument to an electrical ground (safety ground).**
- **If an interlock circuit is not installed in your test fixture or connection interface, you must install and connect the interlock circuit that opens the interlock terminal when the shielding box access door is opened.**
- **If you change the connection interface, test fixture, prober, and such, connect an interlock cable to the one actually used.**
- **Confirm periodically that the interlock function works normally.**
- **Before touching the connections on the High terminal, turn the instrument off and discharge any capacitors. If you do *not* turn the instrument off, complete *all* of the following items, regardless of the instrument settings.**
 - **Press the On/Off switch, and confirm that the switch light turns off.**
 - **Confirm that the On/Off switch does not turn red.**
 - **Open the fixture cover or the shielding box access door (open interlock).**
 - **Discharge any capacitors connected to the terminal.**
- **Warn persons working around the instrument about dangerous conditions.**

WARNING

Pour les utilisateurs B2985A/B2987A

Il y a des tensions potentiellement dangereuses (max. $\pm 1\ 050\text{ V}$) entre les bornes Haute et Basse de la tension de la source. Afin d'éviter toute décharge électrique, les mesures de sécurité suivantes doivent être observées pendant l'utilisation de l'instrument.

- **Utilisez un cordon d'alimentation CA à trois connecteurs pour connecter la cabine (si utilisée) et l'instrument à la mise électrique à la terre (sol de sécurité).**
 - **Si un circuit de sécurité n'est pas installé dans votre test d'installation ou dans votre interface de connexion, vous devez installer et connecter le circuit de sécurité qui ouvre la borne d'enclenchement lorsque la porte d'accès à la protection de la boîte est ouverte.**
 - **Si vous changez l'interface de connexion, un test d'installation, la sonde, ou toute autre élément, connectez un cordon d'enclenchement à celui utilisé actuellement.**
 - **Vérifiez régulièrement que la fonction de verrouillage fonctionne normalement.**
 - **Avant de toucher les connexions sur la borne haute, éteignez l'instrument et déchargez tous les condensateurs. Si vous n'éteignez pas l'appareil, complétez tous les éléments suivants, indépendamment des réglages de l'appareil.**
 - **Appuyez sur le bouton On/Off, et confirmez que le signal lumineux est éteint.**
 - **Vérifiez que le bouton On/Off ne devienne pas rouge.**
 - **Ouvrez le couvercle d'appareil ou la protection du boîtier de la porte d'accès (verrouillage ouvert).**
 - **Déchargez tous les condensateurs connectés au réseau.**
 - **Informez les personnes se trouvant à proximité de l'appareil à propos des conditions dangereuses.**
-

Inspecting the Shipment

Perform the following inspections when Keysight B2980 and accessories arrive at your site.

1. Before unpacking any component, inspect all boxes for any signs of damage that might have occurred during shipment, such as:
 - dents
 - scratches
 - cuts
 - water marks

If you suspect any damage, contact Keysight Technologies.

2. When you open the boxes that contain the B2980 and accessories, check the components against the contents lists attached to the boxes.

If anything is missing, contact Keysight Technologies.

3. Verify the operation of the B2980 as described in "[Checking the Operation of Keysight B2980](#)".

If any problem occurs, contact Keysight Technologies.

Checking the Operation of Keysight B2980

1. Make sure that the standby switch is set to off.
2. Connect the power cord from the B2980's rear panel AC input connector (receptacle) to an AC power outlet at your site.
3. Press the standby switch to turn on the instrument.

The initialization screen will appear on the B2980's front panel display, and the power-on self-test is automatically executed.

If the B2980 is operating normally, the front panel LCD displays the image as shown in [Figure 2-1](#).

Figure 2-1 **Screen Image after Normal Power-on**

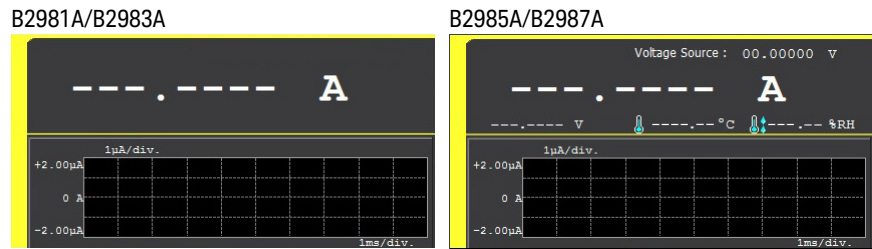

Checking for Errors

Errors can be checked as described below.

1. Press the System Menu > System > Error > Log function keys. This opens the Error Log dialog box.
2. Check the errors displayed on the dialog box.
If no error is detected, “0, No Error” is displayed.
3. Press OK to close the dialog box.

Installing Keysight B2980

This section describes information you must pay attention to when installing Keysight B2980.

- "Safety Considerations"
- "Environment"
- "Connecting the Power Cord"
- "Setting the Power Line Frequency"
- "Setting Date and Time"
- "Bench Installation"
- "Rack Installation"

Safety Considerations

Refer to the Safety Summary page at the beginning of this guide for general safety information. Before installation or operation, check the B2980 and review this guide for safety warnings and instructions. Safety warnings for specific procedures are located at appropriate places throughout this guide.

For the B2983A/B2987A, also see [Chapter 6, "Working with Battery"](#) for the safety precautions to use the built-in lithium-ion rechargeable battery.

Environment

WARNING

Do not operate the instrument in the presence of flammable gasses or fumes.

WARNING

Ne pas utiliser l'appareil en présence de gaz inflammables ou de fumée.

Environmental conditions for the B2980 are described below. The B2980 is designed for use in indoor facilities.

- Temperature range
 - Operating** 0 °C to +45 °C
 - 0 °C to +35 °C for charging battery
 - Storage** -20 °C to +60 °C

- Humidity range
 - Operating** 30 % to 80 %RH, non-condensing
 - Storage** 10 % to 90 %RH, non-condensing
- Altitude
 - Operating** 0 m to 2,000 m (6,561 ft.)
 - Storage** 0 m to 4,600 m (15,092 ft.)
- Power requirement: 100–240 V (± 10 %), 50/60 Hz
- Maximum volt-amps (VA): 80 VA
- Dimensions
 - Without handle and feet: 88 mm (H) \times 213 mm (W) \times 350 mm (D)
 - Bench configuration (with handle and feet): 104 mm (H) \times 261 mm (W) \times 374 mm (D)

Connecting the Power Cord

WARNING

FIRE HAZARD: Use only the power cord supplied with your instrument. Using other types of power cord may cause overheating of the power cord, resulting in fire.

SHOCK HAZARD: The power cord provides the chassis ground through a third conductor. Be sure to connect to a three-conductor type power outlet with the correct pin grounded.







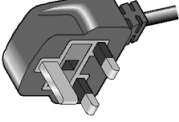

WARNING

Risque d'incendie : utilisez uniquement le cordon d'alimentation fourni avec votre appareil. L'utilisation d'autres types de cordon d'alimentation peut provoquer une surchauffe du cordon d'alimentation et provoquer un incendie.

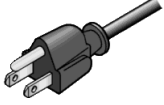
Risques de choc électrique : le cordon d'alimentation fournit la masse par le biais d'un troisième conducteur. Assurez-vous de connecter la prise d'alimentation de type trois conducteurs au boîtier exact mis à terre.

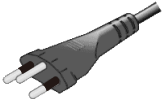
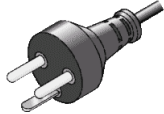
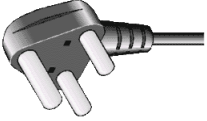
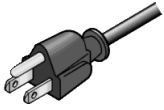
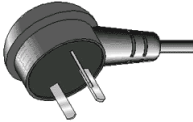
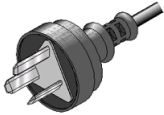
Connect the power cord to the IEC 320 connector on the rear of the instrument. If the wrong power cord was shipped with your instrument, contact Keysight Technologies. The AC input on the back of your instrument is a universal AC input. It accepts nominal line voltages in the range of 100 to 240 VAC.

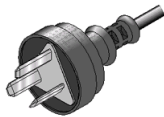
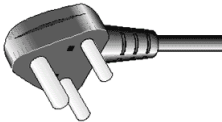
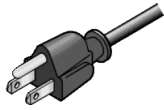
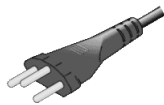
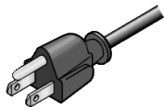
Installation
Installing Keysight B2980

<p>Option 900</p>  <ul style="list-style-type: none"> • Plug: BS 1363/A, 250 V, 10 A • PN: 8120-4420 	<p>Option 901</p>  <ul style="list-style-type: none"> • Plug: AS/NZS 3112, 250 V, 10 A • PN: 8120-4419 	<p>Option 902</p>  <ul style="list-style-type: none"> • Plug: IEC 60277-1, 250 V, 10 A • PN: 8121-1226 	<p>Option 903</p>  <ul style="list-style-type: none"> • Plug: NEMA 5-15P, 125 V, 10 A • PN: 8120-6825
<p>Option 904</p>  <ul style="list-style-type: none"> • Plug: NEMA 6-15P, 250 V, 10 A • PN: 8120-3996 	<p>Option 906</p>  <ul style="list-style-type: none"> • Plug: SEV 1011, 250 V, 10 A • PN: 8120-4416 	<p>Option 912</p>  <ul style="list-style-type: none"> • Plug: SB 107-2-D1, 250 V, 10 A • PN: 8121-1655 	<p>Option 917</p>  <ul style="list-style-type: none"> • Plug: IS 1293 and IS 6538, 250 V, 10 A • PN: 8121-1690
<p>Option 918</p>  <ul style="list-style-type: none"> • Plug: JIS C 8303, 125 V, 12 A • PN: 8121-0743 	<p>Option 919</p>  <ul style="list-style-type: none"> • Plug: Israel SI 32, 250 V, 10 A • PN: 8121-0724 	<p>Option 920</p>  <ul style="list-style-type: none"> • Plug: IRAM 2073, 250 V, 10 A • PN: 8121-0725 	<p>Option 921</p>  <ul style="list-style-type: none"> • Plug: CEI 23-16, 250 V, 10 A • PN: 8121-0722
<p>Option 922</p>  <ul style="list-style-type: none"> • Plug: GB 1002 figure 3, 250 V, 10 A • PN: 8120-8376 	<p>Option 923</p>  <ul style="list-style-type: none"> • Plug: SANS 164-1, 250 V, 10 A • PN: 8121-0564 	<p>Option 927</p>  <ul style="list-style-type: none"> • Plug: NEMA WD-6, 250 V, 10 A • PN: 8120-0674 	<p>Option 930</p>  <ul style="list-style-type: none"> • Plug: NBR 14136, 250 V, 10 A • PN: 8121-1809
<p>Option 931</p>  <ul style="list-style-type: none"> • Plug: CNS 10917-2, 125 V, 10 A • PN: 8121-1635 	<p>Option 932</p>  <ul style="list-style-type: none"> • Plug: CS 0017, 250 V, 10 A • PN: 8121-1638 		

NOTE

The detachable power cord may be used as an emergency disconnecting device. Removing the power cord will disconnect AC input power to the instrument.

Setting the Power Line Frequency

When the instrument is shipped from the factory, the power-on automatic detection of power line frequency is enabled. The boot up screen will show *Power Line Frequency: AUTO*. If the setting is not changed, you do not need to set the power line frequency.

However, you may want to specify the power line frequency by yourself. Then disable the power-on automatic detection, and press the following function keys.

- To specify 50 Hz: System Menu > System > PLC > 50 Hz
- To specify 60 Hz: System Menu > System > PLC > 60 Hz
- To detect and set the frequency: System Menu > System > PLC > Auto Detect

To disable or enable the power-on automatic detection, set OFF or ON to the Power-on PLC Detect field on the System Start-up dialog box opened by pressing System Menu > System > Start-up function keys.

Setting Date and Time

You can set the date and time on the Date and Time dialog box opened by pressing System Menu > System > Info. > Date/Time function keys.

Bench Installation

For easier display viewing and front panel access, you can tilt the front of the instrument by turning the handle. To adjust the handle, grab the handle by the sides and pull outward. Then, rotate the handle to the desired position.



Installation

Installing Keysight B2980

NOTE

When the B2983A/B2987A works with the internal Li-ion battery, if ambient temperature exceeds +45 °C, the instrument will cause emergency shutdown without saving setup information. To avoid this, make a space about 10 cm around the instrument and do not cover the instrument top and side.

Rack Installation

NOTE

Use the Keysight 34190A Rack Mount kit to rack mount Keysight B2980.

NOTE

When the B2983A/B2987A works with the internal Li-ion battery, if ambient temperature exceeds +45 °C, the instrument will cause emergency shutdown without saving setup information. To avoid this, make a space about 2U (approx. 10 cm) above the instrument.

Keysight B2980 can be mounted in a 19-inch EIA rack cabinet. It is designed to fit in two rack-units (2U) of space.

Remove the front and rear rubber bumpers and the handle before rack mounting the B2980.

Removing the Bumper

Stretch a corner of the rubber bumper and slide it off.

Removing the Handle

1. Grab the handle by the sides and pull outward. This will allow you to rotate the handle.
2. Rotate the handle to a vertical position. Then, position the instrument horizontally.

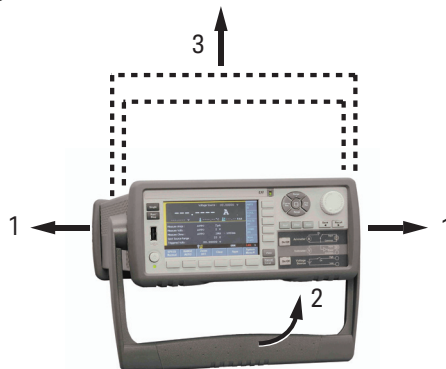

3. Pull outward and then lift the handle upward.

CAUTION

When reattaching the handle, pay attention to its direction. Incorrect attachment may damage the hardware.

Maintenance

Maintenance should be performed periodically to keep Keysight B2980 in good condition. If problems arise, contact Keysight Technologies.

- "Cleaning"
- "Self-test"
- "Self-calibration"
- "Calibration"

Cleaning

WARNING

SHOCK HAZARD: To prevent electric shock, unplug the B2980 before cleaning.

WARNING

Risques de choc électrique : afin d'éviter tout choc électrique, débranchez le B2980 avant d'effectuer le nettoyage.

Use a dry cloth or a cloth slightly dampened with water to clean the external case parts. Do not use detergents or chemical solvents. Do not attempt to clean internally.

Self-test

Keysight B2980 provides the self-test function to check the operation. The self-test is automatically performed when the instrument is turned on. It is recommended to perform the self-test for the following condition or purpose. Before performing the self-test, turn the channel output off and disconnect test leads and cables from the terminals.

- If a channel is in the lock condition due to emergency

In this condition, the Emergency dialog box is displayed on the gray background screen, however this is not shown in the remote state if the remote display is set to OFF. And the ERR indicator turns on and the **On/Off** switch is not effective.

Perform the self-test to unlock the channel. The channel can be used soon if the self-test does not report any problem.

- If you feel that the instrument may be defective

- For preventive maintenance

To perform self-test

The following procedure shows how to perform the self-test.

1. If it is in the remote state, press the **Cancel/Local** key.
2. Press the **On/Off** switch and confirm that the switch turns off.
3. Disconnect test leads and cables from the measurement and output terminals.
4. Press the following function keys.

System Menu > System > Cal/Test > Self-Test

Confirmation dialog box is opened.

5. Press OK. This starts the self-test.

Self-calibration

Keysight B2980 provides the self-calibration function to maintain the measurement performance. If the environmental temperature changes ± 3 °C or more, perform the self-calibration. This is effective for the accurate measurements by minimizing the effect of thermal drift. The self-calibration must be performed after warming-up of 60 minutes. Before performing the self-calibration, turn the voltage source output off and disconnect test leads and cables from the terminals.

To perform self-calibration

The following procedure shows how to perform the self-calibration.

1. If it is in the remote state, press the **Cancel/Local** key.
2. Press the **On/Off** switch and confirm that the switch turns off.
3. Disconnect test leads and cables from the measurement and output terminals.
4. Press the following function keys. Confirmation dialog box is opened.

System Menu > System > Cal/Test > Self-Cal

5. Press OK. This starts the self-calibration.

Calibration

Calibration and adjustments must be performed periodically so that the instruments satisfy the specifications, and keep a good condition. It is recommended to perform the calibration once a year at least. For the calibration and adjustments, contact Keysight Technologies. Trained service personnel will perform the calibration and adjustments.



Installing the Interlock Circuit

This section is applied to Keysight B2985A/B2987A which supports the interlock function. The interlock circuit is a simple electric circuit, as shown in [Figure 2-2](#). The circuit electrically opens when an access door is opened, and closes when the door is closed.

The B2985A/B2987A cannot apply high voltages over ± 21 V when the interlock terminal is open. To apply high voltage, the B2985A/B2987A interlock terminal must be connected to the interlock circuit installed in the measurement environment such as the shielding box. The interlock circuit is important and necessary to prevent electrical shock when the user touches the output terminal.

WARNING

Potentially hazardous voltages of up to ± 1050 V may be present between the High and Low terminals of the Voltage Source when the interlock circuit is closed. To prevent electrical shock, do *not* expose the line.

WARNING

Des tensions potentiellement dangereuses jusqu'à ± 1050 V risquent d'être présentes entre les bornes Haute et Basse de la tension de la source lorsque le circuit de verrouillage est fermé. Afin d'éviter toute décharge électrique, n'exposez pas ces lignes.

Requirements

- LED (Keysight part number 1990-0486 or equivalent), 1 ea.
- Mechanical switch (Keysight N1254A-402 or equivalent), 2 ea.
- Interlock connector head, 4-pin plug, 1 ea., furnished, Phoenix Contact 1881341 (4 pin) or equivalent
- Connection wire, needs enough length from the shielding box to the Interlock connector on the B2985A/B2987A rear panel

Procedure

1. Mount two mechanical switches onto your shielding box, so that the switches close when the access door is closed, and open when the door is opened. See [Figure 2-4](#) for the switch dimensions (typical).
2. Mount an LED onto your shielding box. See [Figure 2-3](#) for the LED dimensions (typical).

The LED is used as a high voltage indicator which is lit when the B2985A/B2987A is in the high voltage output status over ± 21 V.

- Use a wire and connect the two switches in series between the pins 1 and 2 of the Interlock connector head.

To connect the wire to the Interlock connector head, just insert the wire into the appropriate wire hole.

If you inserted the wire into a wrong hole, remove it and retry. You can remove the wire by pushing the associated button (orange) and pulling the wire.

- Use a wire and connect the LED between the pins 3 and 4 of the Interlock connector head.
- Connect the Interlock connector head to the Interlock connector on the B2985A/B2987A rear panel.

Figure 2-2 Interlock Circuit

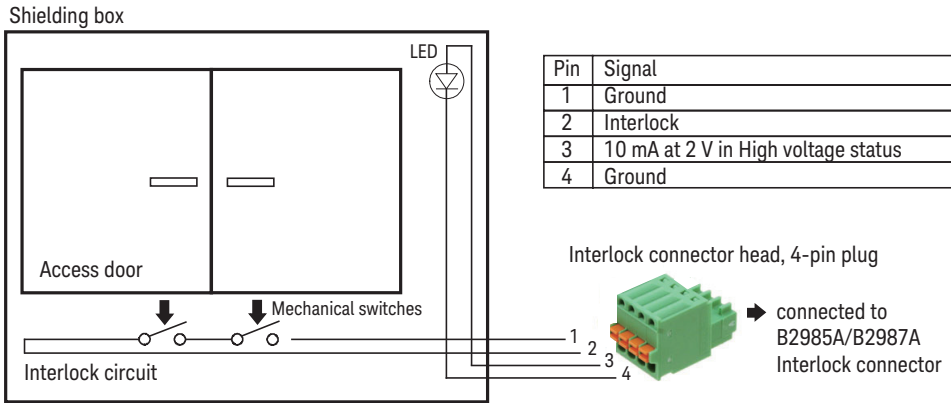
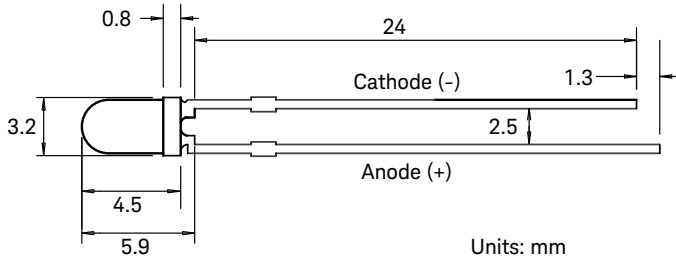

Figure 2-3 Dimensions of the LED (Keysight part number 1990-0486)



Installation
Installing the Interlock Circuit

Figure 2-4

Dimensions of the Interlock Switch (Keysight N1254A-402)

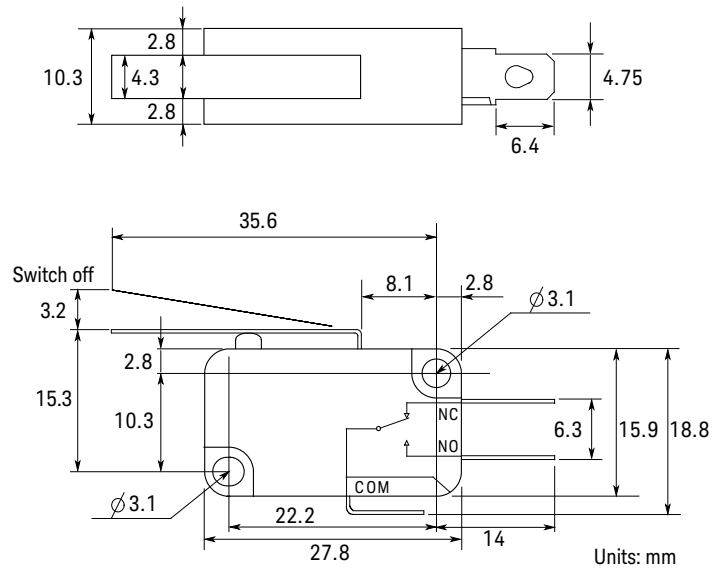

Connecting to the Interfaces

CAUTION

Electrostatic discharges greater than 1 kV near the interface connectors may cause the unit to reset and require operator intervention.

B2980 supports GPIB, LAN, and USB interfaces. All three interfaces are live at power-on. Connect your interface cable to the appropriate interface connector. Information on configuring the interfaces can be found later in this section.

The front panel LAN indicator is lit when the LAN port is connected and configured.

B2980 provides Ethernet connection monitoring. With Ethernet connection monitoring, the instrument's LAN port is continually monitored and automatically reconfigured.

GPIB/USB Interfaces

NOTE

For detailed information about GPIB and USB interface connections, refer to *Connectivity Guide* installed with Keysight IO Libraries.

The following steps will help you quickly get started connecting your instrument to the GPIB (General Purpose Interface Bus). The following figure illustrates a typical GPIB interface system.

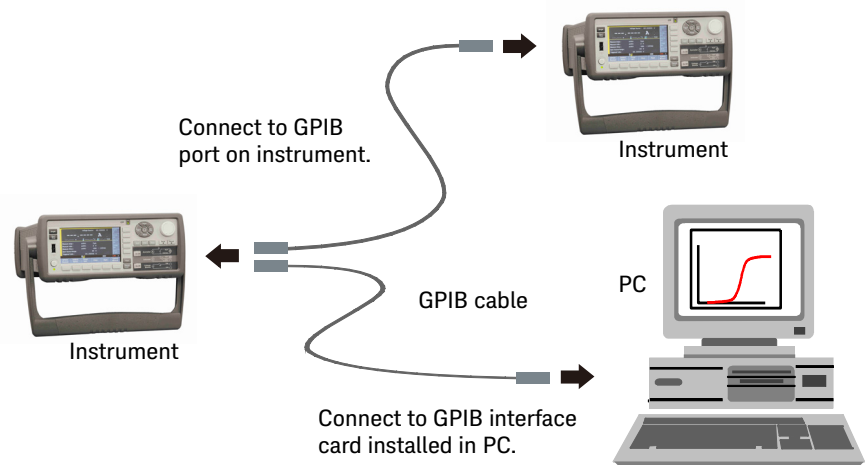

Installation

Connecting to the Interfaces

1. If you have not already done so, install Keysight IO Libraries Suite from the CD shipped with your product.
2. If you do not have a GPIB interface card installed on your computer, turn off your computer and install the GPIB card.
3. Connect your instrument to the GPIB interface card using a GPIB interface cable.
4. Use the Connection Expert utility from Keysight IO Libraries Suite to configure the installed GPIB interface card's parameters.
5. B2980 is shipped with its GPIB address set to 23. To view or change the GPIB address, press the System Menu > I/O > GPIB function keys. The GPIB Configuration dialog box appears.

To change the GPIB address, use the rotary knob or the arrow keys, and press OK to set the value.

6. You can now use the Interactive IO within Connection Expert to communicate with your instrument, or program your instrument using various programming environments.

The following steps will help you quickly get started with connecting your USB-enabled instrument to the USB (Universal Serial Bus). The following figure illustrates a typical USB interface system.

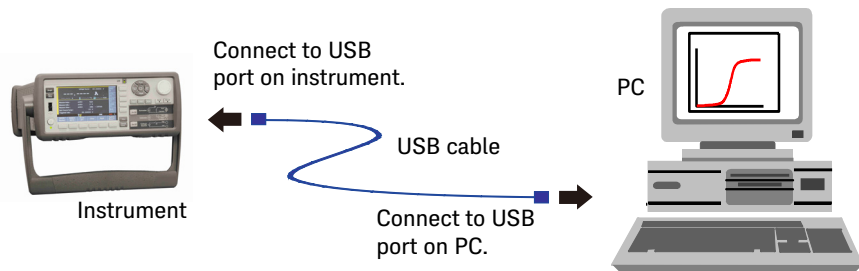

1. If you have not already done so, install Keysight IO Libraries Suite from the CD shipped with your product.
2. Connect the USB device port located on the back of your instrument to the USB port on your computer.
3. With the Connection Expert utility from Keysight IO Libraries Suite running, the computer will automatically recognize the instrument. This may take several seconds. When the instrument is recognized, your computer will display the VISA alias, IDN string, and VISA address.

You can also view the instrument's VISA address from the front panel. Press the System Menu > I/O > USB function keys. The VISA address is shown in the USB Status dialog box.

4. You can now use the Interactive IO within Connection Expert to communicate with your instrument, or program your instrument using various programming environments.

LAN Interface

NOTE

For detailed information about LAN interface connections, refer to *Connectivity Guide* installed with Keysight IO Libraries.

The following steps will help you quickly get started with connecting and configuring your instrument on a local area network.

Connecting to a Site LAN

A site LAN is a local area network in which LAN-enabled instruments and computers are connected to the network via routers, hubs, and/or switches. They are typically large, centrally-managed networks with services such as DHCP and DNS.

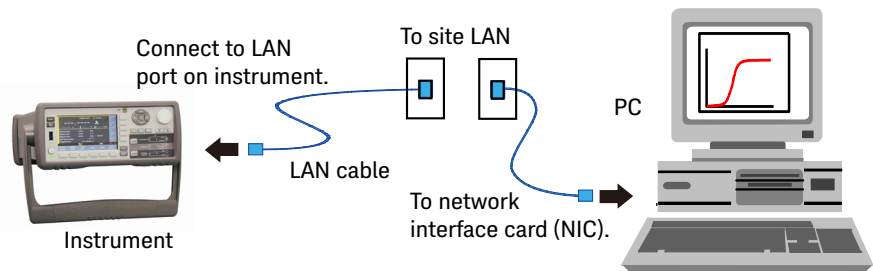

1. If you have not already done so, install Keysight IO Libraries Suite from the CD shipped with your product.
2. Connect the instrument to the site LAN. The factory-shipped instrument LAN settings are configured to automatically obtain an IP address from the network using DHCP (DHCP: Enabled). Note that this may take up to one minute. The DHCP server will register the instrument's hostname with the dynamic DNS server. The hostname as well as the IP address can then be used to communicate with the instrument. The front panel LAN indicator will turn green when the LAN port has been configured successfully, or turn red if the configuration fails.

NOTE

If you need to manually configure any instrument LAN settings, see "[LAN Configuration dialog box](#)" on page 4-64 for information about configuring the LAN settings from the front panel of the instrument.

3. Use the Connection Expert utility from Keysight IO Libraries Suite to add the B2980 and verify the connection. To add the instrument, you can request Connection Expert to discover the instrument. If the instrument cannot be found, add the instrument using the instrument's hostname or IP address.

NOTE

If this does not work, refer to the troubleshooting section in *Connectivity Guide*.

4. You can now use the Interactive IO within Connection Expert to communicate with your instrument, or program your instrument using various programming environments. You can also use the Web browser on your computer to connect to the instrument as described under "[Using the Graphical Web Interface](#)" on page 2-21.

Viewing the Active LAN Status

To view the currently active LAN settings, press the System Menu > I/O > LAN > Status function keys. The LAN status dialog box appears.

Note that the currently active LAN settings for the IP Address, Subnet Mask, and Default Gateway may be different from the settings specified in the LAN Configuration dialog box, depending on the configuration of the network. If the settings are different, it is because the network has automatically assigned its own settings.

Modifying the LAN Settings

As shipped from the factory, B2980's pre-configured settings should work in most LAN environments. If you need to manually configure these settings, press the System Menu > I/O > LAN > Config function keys. The LAN Configuration dialog box appears.

NOTE

B2980 must be rebooted if the host name is changed.

For the LAN setup parameters, see "[LAN Configuration dialog box](#)" on page 4-64.

Communicating Over the LAN

Using the Graphical Web Interface

B2980 has a built-in graphical web interface that lets you control it directly from an Web browser on your computer. Multiple simultaneous connections are allowed, but only from one computer. With additional connections, performance will be reduced. Multiple connections from multiple computers are not allowed.

With the graphical web interface, you can access the front panel control functions including the LAN configuration parameters. This is a convenient way to communicate with the B2980 without using I/O libraries or drivers.

NOTE

The built-in graphical web interface only operates over the LAN interface. It requires Internet Explorer 6+ or Firefox 2+. You will also need the Java Plug-in. This is included in the Java Runtime Environment. Refer to Java's website.

The graphical web interface is enabled when shipped.

The screenshot displays the web interface for the Keysight B2987A Electrometer / High R Meter. The interface includes a navigation bar on the left with options like 'Welcome Page', 'Browser Web Control', 'View & Modify Configuration', 'SXI Event Log', and 'Help with this Page'. The main content area features a 'Welcome to your Web-Enabled B2987A' message and a table of information about the instrument. A photograph of the physical device is shown on the right side of the page.

Information about this Web-Enabled B2987A:	
Instrument:	B2987A
Serial Number:	MYXXXXXXX
Description:	Keysight B2987A Electrometer / High R Meter MYXXXXXXX
DNS Hostname:	A-B2987A-XXXXX
NetBIOS Name:	A-B2987A-XXXXX
mDNS Hostname:	A-B2987A-XXXXX.local
IP Address:	XXX.XXX.XXX.XXX
Instrument Address String:	TCPIP:A-B2987A-XXXXX::hisip0::INSTR TCPIP:A-B2987A-XXXXX::inst0::INSTR

[Turn On Front Panel Identification Indicator](#)

Advanced information about this Web-Enabled B2987A

Use the navigation bar on the left to access your B2987A and related information.

Installation

Communicating Over the LAN

To launch the graphical web interface:

1. Open a Web browser on your computer.
2. Enter the instrument's hostname or IP address into the browser's Address field to launch the graphical web interface. The B2980 home page will appear.
3. Click on the Browser Web Control button in the navigation bar on the left to begin controlling your instrument.
4. For additional help about any page, click "Help with this Page".

If desired, you can control the access to the graphical web interface using password protection. As shipped from the factory, the password is set to *Keysight* or *keysight*. To change the password, click on the View & Modify Configuration button. Refer to the online help for additional information about setting the password.

Using Telnet

The Telnet utility (as well as sockets), is another way to communicate with B2980 without using I/O libraries or drivers. In all cases, you must first establish a LAN connection from your computer to the B2980 as previously described.

In an MS-DOS Command Prompt box, type "telnet *hostname* 5024" where *hostname* is the B2980's hostname or IP address, and 5024 is the instrument's telnet port. You should get a Telnet session box with a title indicating that you are connected to the B2980. Type the SCPI commands at the prompt.

Using Sockets

NOTE

B2980 allows any combination of up to four simultaneous data socket, control socket, or telnet connections to be made.

Keysight instruments are standardized on using port 5025 for SCPI socket services. A data socket on this port can be used to send and receive ASCII/SCPI commands, queries, and query responses. All commands must be terminated with a newline for the message to be parsed. All query responses will also be terminated with a newline.

The socket programming interface also allows control socket connections. The control socket can be used by a client to send device clear and to receive service requests. Unlike the data socket, which uses a fixed port number, the port number for a control socket varies and must be obtained by sending the following SCPI query to the data socket: `SYSTem:COMMunicate:TCPip:CONTRol?`

Once the port number is obtained, a control socket connection can be opened. As with the data socket, all commands to the control socket must be terminated with a newline, and all query responses returned on the control socket will be terminated with a newline.

To send a device clear, send the string “DCL” to the control socket. When the B2980 has finished performing the device clear, it will echo the string “DCL” back to the control socket.

Service requests are enabled for control sockets using the Service Request Enable register. Once service requests have been enabled, the client program listens on the control connection. When SRQ becomes true, the instrument will send the string “SRQ +nn” to the client. The “nn” is the status byte value, which the client can use to determine the source of the service request.

Using Digital I/O and Trigger In/Out

B2980 has a Digital I/O connector, D-sub 9 pin female, for general purpose input/output (GPIO). It can be used for:

- Trigger input
- Trigger output
- Digital signal input/output
- Digital signal input
- Start of Test (SOT) input (for component handlers)
- Busy status output (for component handlers)
- End of Test (EOT) output (for component handlers)

The pin assignment of the Digital I/O connector is shown in [Table 2-1](#). Pins DIO 1 to DIO 7 can be assigned to one of the above functions. To set the DIO functions, press the System Menu > I/O > DIO > Config function keys. For details, see "[DIO Configuration dialog box](#)" on page 4-64.

B2980 also has the Trigger In and the Trigger Out BNC connectors used for the trigger input/output. They are used to perform the operation synchronized with an external equipment. The BNC connectors are useful for making the connection easier than the Digital I/O connector.

- Connect a BNC cable between the Trigger In connector and a trigger output BNC connector on an external equipment to receive a trigger signal from it.
- Connect a BNC cable between the Trigger Out connector and a trigger input BNC connector on the external equipment to send a trigger signal to it.

[Figure 2-5](#) shows the input/output circuits internally connected to each pin of the Digital I/O connector and the Trigger In/Out connector.

Figure 2-5

Internal Circuit of Digital I/O and Trigger In/Out

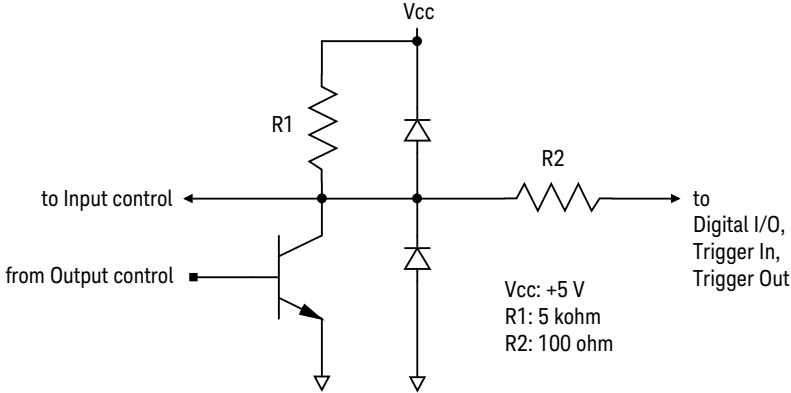

Table 2-1

Digital I/O Pin Assignment

Pin Number	Description
1	DIO 1
2	DIO 2
3	DIO 3
4	DIO 4
5	GND
6	DIO 5
7	DIO 6
8	DIO 7
9	+5 V

Installation
Using Digital I/O and Trigger In/Out

3

How to Perform Measurement

This chapter explains how to perform measurement by using Keysight B2980.

- "Current Measurement"
- "Voltage Measurement"
- "Resistance Measurement"
- "Charge Measurement"
- "Temperature and Humidity Measurement"
- "Measurement Considerations"

WARNING

To avoid electrical shock and instrument damage, turn the instrument off before connecting or disconnecting measurement cable.

To avoid touching the end of the extension cable or the terminal area with the device under test (DUT), cover over the conductors with insulator. Also it is important to protect the terminal area by using the grounded shield cover and such.

To prevent electrical shock and DUT damage, do not connect or disconnect the DUT while the source output is applied.

When you touch the DUT after measurement, devise a countermeasure of residual charge and heat to prevent electrical shock and burn. Use glove and any tool. Also have enough time for discharge and radiation.

WARNING

Pour éviter une décharge électrique et un risque d'endommagement de l'appareil, mettre l'appareil hors tension avant de brancher ou de débrancher le câble de mesure.

Afin d'éviter de toucher l'extrémité du câble d'allongement ou l'aire de la borne avec l'appareil mis sous tension (AST), couvrez les conducteurs avec l'isolant. En outre, il est important de protéger la zone de la borne en utilisant le couvercle d'écran à la mise à terre, ou tout autre élément.

Afin d'éviter toute décharge électrique et dommage MST, ne branchez ou déconnectez pas la sortie MST alors que la source de sortie est appliquée.

Lorsque vous touchez le MST après la mesure, élaborer une contre-mesure de la charge résiduelle et du chauffage afin d'éviter tout choc électrique et toute brûlure. Utilisez des gants et des outils. Prévoyez également du temps pour la décharge et la radiation.

NOTE**Using the built-in battery**

B2983A/B2987A installs a built-in battery. If the power cord is removed from the instrument and the built-in battery is used for operation, connect the instrument chassis to an electrical ground through the earth (ground) terminal on the rear panel, for safety. Use the earthing wire furnished with the B2983A/B2987A.

NOTE**Turning the instrument on or off**

Press the standby switch. When the power is on, the LED below the switch turns green.

For the B2983A/B2987A, the LED turns orange during the switch is off and the battery charging is in progress.

NOTE**Setting the instrument to the local state**

Press the **Cancel/Local** key. The front panel keys are available when the instrument is in the local state.

NOTE**On/Off switches**

The **On/Off** switch shows the following lighting status to indicate the status of Ammeter or Voltage Source (B2985A/B2987A) associated with the switch.

off OFF (disable) status

green ON (enable) status

red High voltage status of Voltage Source, for the B2985A/B2987A

Pressing the **On** (green) switch turns it to the OFF status even if the instrument is in the remote control state.

NOTE**Starting measurement**

Press the **Single** key to start a single (one shot) measurement.

Press the **Run/Stop** key to start a repeat (continuous) measurement.

If a repeat measurement is in progress, pressing the **Single** or **Run/Stop** key stops it.

NOTE**Before changing the connections of DUT**

Set the instrument output off before changing the connections of device under test (DUT). If not, the DUT may be damaged.

To set the B2985A/B2987A Voltage Source output off, press the **On/Off** switch and confirm that the lighting status is off.

NOTE**If the instrument is in the lock condition due to emergency**

In this condition, the Emergency dialog box is displayed on the gray background screen, however this is not shown in the remote state if the remote display is set to OFF. And the ERR indicator turns on and the **On/Off** switch is not effective.

Perform the self-test to unlock the instrument. The instrument can be used soon if the self-test does not report any problem.

NOTE**About measurement accuracy**

- RF electromagnetic field and measurement accuracy

Current, charge, resistance, and voltage measurement accuracy may be affected by RF electromagnetic field of strength over 3 V/m at frequencies 80 MHz to 1 GHz and 1.4 GHz to 20. GHz, and 1 V/m at frequencies 2.0 GHz to 2.7 GHz. The extent of this effect depends upon how the instrument is positioned and shielded.

- Induced RF field noise and measurement accuracy

Current, charge, resistance, and voltage measurement accuracy can be affected by induced RF field noise strengths greater than 3 V_{rms} in the frequency range of 150 kHz to 80 MHz. The extent of this effect depends upon how the instrument is positioned and shielded.

Current Measurement

The B2981A/B2983A/B2985A/B2987A supports the current measurement capability shown in [Table 3-1](#).

Table 3-1

Current Measurement Range, Value, and Resolution

Range value	Measurement value	Display resolution
2 pA	$0 \leq I \leq 2.1 \text{ pA}$	1 aA
20 pA	$0 \leq I \leq 21 \text{ pA}$	10 aA
200 pA	$0 \leq I \leq 210 \text{ pA}$	100 aA
2 nA	$0 \leq I \leq 2.1 \text{ nA}$	1 fA
20 nA	$0 \leq I \leq 21 \text{ nA}$	10 fA
200 nA	$0 \leq I \leq 210 \text{ nA}$	100 fA
2 μA	$0 \leq I \leq 2.1 \text{ }\mu\text{A}$	1 pA
20 μA	$0 \leq I \leq 21 \text{ }\mu\text{A}$	10 pA
200 μA	$0 \leq I \leq 210 \text{ }\mu\text{A}$	100 pA
2 mA	$0 \leq I \leq 2.1 \text{ mA}$	1 nA
20 mA	$0 \leq I \leq 21 \text{ mA}$	10 nA

Requirements

Before turning the instrument on, connect cable, test leads, test fixture, and so on, used for the measurement. See [Figures 3-2](#) and [3-3](#) for connection examples.

The following accessories can be used.

- Triaxial cable, 200 V, 1.5 m
- Triaxial bulkhead connector, if needed
- Banana to lug cable, for connecting Common to chassis ground

Instead of the triaxial cable and the triaxial bulkhead connector, Keysight N1415A Triaxial to alligator clip cable, 200 V, 1.5 m can be used.

NOTE

When turning the instrument on, leave the end of the measurement path open.

Figure 3-1 Simplified Circuit Diagram of Ammeter

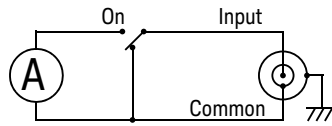

Figure 3-2 Current Measurement Connection, Grounded, Typical

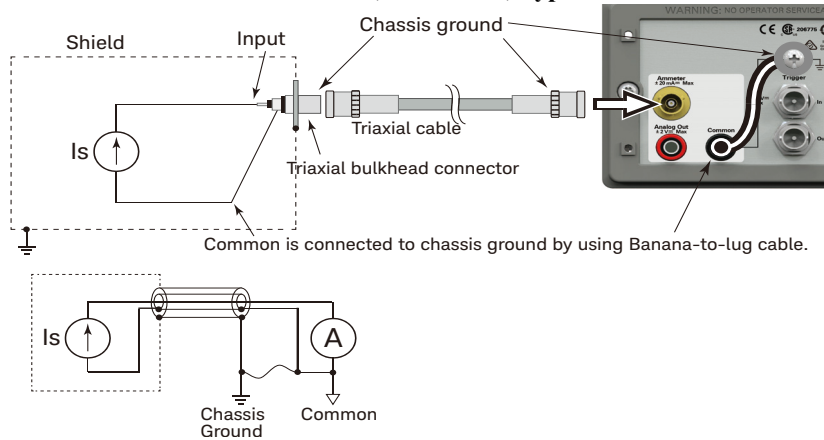
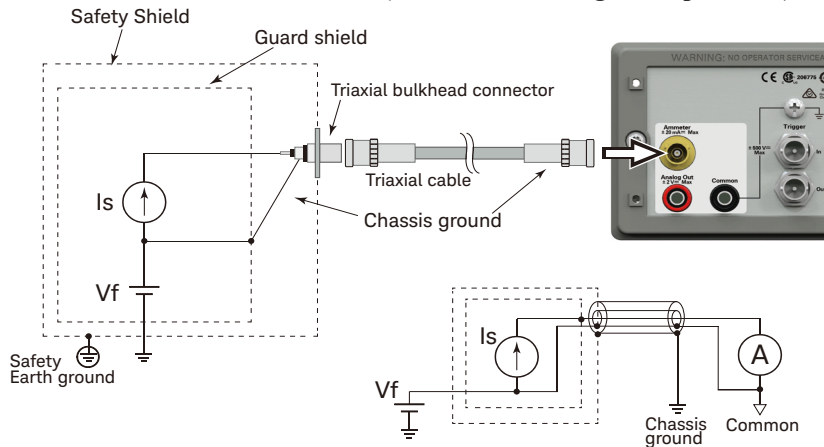

Figure 3-3 Current Measurement Connection (if DUT has a non-ground potential)



NOTE For floating the ammeter, do not connect any cable between Common and chassis ground. See "[Common Terminal Connection](#)" on page 3-12 for more information.

Procedure You can perform the current measurement as follows.

Step 1. Press the **View** key and the Meter View function key to display the Meter view.

For the B2985A/B2987A, also press the **AMPS (I)** assist key to set the current measurement mode.

Step 2. Use the navigation keys or the RANGE function key to set the measurement range you want to use. See "[Measure Amps](#)" on page 3-8 for more information.

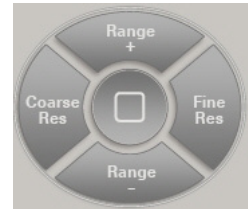

Step 3. Use the navigation keys or the SPEED function key to set the measurement speed (aperture time) you desire. See "[Aperture Time](#)" on page 3-8 for more information.

Step 4. Press the **Filter** key to open the Measure Filter dialog box. And set the measurement filter on the dialog box. See "[Filter](#)" on page 3-8 for more information.

Step 5. Connect measurement current (DUT).

See [Figure 3-2](#) for the typical current measurement.

See [Figure 3-3](#) if DUT has a non-ground potential.

Step 6. Press the Ammeter **On/Off** switch to enable Ammeter. This turns the switch green.

Step 7. Start measurement as follows.

- Press the **Single** key to start a single (one shot) measurement. Current measurement is performed once.
- Press the **Run/Stop** key to start a repeat (continuous) measurement. Current measurement is performed repeatedly. Minimum measurement interval is 10 ms.

Step 8. Press the Ammeter **On/Off** switch to disable Ammeter. This turns off the switch light.

For more precise measurement, use the zero correction or offset cancel. See "[Null, Offset Cancel](#)" on page 5-9.

NOTE

Setup integrity checker

You can easily check the noise level of the measurement path such as cabling and connection by pressing the Apps function key and the **#1** assist key.

For more information and using this function, see "[Applications](#)" on page 4-17.

NOTE**Data logger**

You can easily perform measurements like a sampling measurement by pressing the Apps function key and the #2 assist key.

For more information and using this function, see "[Applications](#)" on page 4-17.

Setup Parameters

This section briefly describes how to set key parameters effective for accurate and reliable current measurement.

Measure Amps

Press the RANGE function key to change the ranging mode, auto or fixed. Where, the softkey label shows the present measurement range setting, AUTO or fixed range value.

Measurement range can be set by using the following navigation keys.

Range + Sets the fixed range mode and changes the range up.

[home] Sets the AUTO range and the Normal auto aperture.

Range - Sets the fixed range mode and changes the range down.

See "[Measurement Range](#)" on page 3-9 for more information.

Aperture Time

Press the SPEED function key to change the aperture mode, auto or manual. Where, the softkey label shows the present aperture time setting.

Aperture time can be set by using the following navigation keys.

Coarse Res Increases measurement speed (decreases aperture time).

[home] Sets the Normal auto aperture and the AUTO range.

Fine Res Decreases measurement speed (increases aperture time).

See "[Aperture Time](#)" on page 3-10 for more information.

Filter

Measurement filter function can be enabled/disabled by using the Filter key.

If the FILT indicator is turned off, pressing the Filter key opens the Measure Filter dialog box. Pressing OK after setting up the dialog box enables the filter function and turns the FILT indicator on.

If the FILT indicator is turned on, pressing the Filter key disables the function and turns the FILT indicator off.

The filter function is used to average measurement result data, calculate moving average, and so on. For the precise and reliable measurement, it is recommended to use the filter function, see "[Measurement Filter](#)" on page 5-12 for more information.

Measurement Range

Measurement range is the factor to determine the coverage of measurable values.

The following ranging modes are available. The mode can be selected by pressing the RANGE function key. Where, the softkey label shows the present measurement range setting, AUTO or fixed range value.

- Automatic ranging mode, AUTO

Instrument automatically selects and uses the range which provides the best resolution for the measurement value.

- Fixed range mode, FIXED

Instrument uses the specified range only.

The measurement range can be set by using the following navigation keys.

Range + Sets the fixed range and changes the range up.

[home] Sets the AUTO range and the Normal auto aperture.

Range - Sets the fixed range and changes the range down.

The measurement range can also be set by using the Measure fields. The ranging mode (left field) and the range value (right field) are set by pressing an assist key available when the relative field is in the EDIT status. Where, the softkey label shows Volts, Amps, Ohms, or Coulomb. For more information, see "[Range Setup Sub-panel](#)" on page 4-23 and "[Measurement Range](#)" on page 5-3.

NOTE**Automatic ranging speed**

The setting speed can be specified by pressing the System Menu > Config > Measure > Ranging function keys. The softkey label shows Normal or Fast.

The instrument performs normal range changing when this softkey label shows Ranging Normal.

The instrument reduces range changing wait time when this softkey label shows Ranging Fast. This setup is effective for performing high speed measurement when the measurement result is stable.

NOTE**Automatic ranging operation**

If the measured value is < 9.5 % of the range value, the instrument changes the range down and performs measurement again. If the measured value is > 105 % of the range value, the instrument changes the range up and performs measurement again.

NOTE**After the mode is changed from AUTO to FIXED**

The instrument keeps the last used range. And the RANGE function key shows its value.

Aperture Time

Aperture time is the observation time required for getting a point of data, and does not include such factors as range change or data compensation, which would be overhead time. For accurate and reliable measurements, the aperture time should be increased.

The following aperture modes are available. The mode can be selected by pressing the SPEED function key. Where, the softkey label shows the present aperture time setting.

- Automatic aperture mode

Instrument automatically selects and sets optimum aperture time for performing accurate and reliable measurements. The instrument provides three types, Quick, Normal, and Stable, for the automatic setup. See [Figure 3-4](#) for image of the automatic aperture operation. Use Stable if measurement data is noisy.

- Manual aperture mode

Instrument uses the specified aperture time. The instrument provides six values, 0.001*PLC, 0.01*PLC, 0.1*PLC, 1.0*PLC, 10.0*PLC, and 100.0*PLC. Where, PLC means power line cycle. And the value is 20 ms for the 50 Hz line frequency operation or 16.667 ms for the 60 Hz operation.

For example, if the softkey label shows 0.001 PLC, the aperture time is set to 20 μ s for the 50 Hz operation or 16.667 μ s for the 60 Hz operation.

NOTE

In the remote state, the instrument accepts the aperture time other than the six values shown above. The setting value is still effective just when the instrument is returned to the local state. Then the softkey label shows the value. However, once the Coarse Res key or the Fine Res key is pressed, only the six values are available in the local state.

Figure 3-4

Image of Automatic Aperture Operation

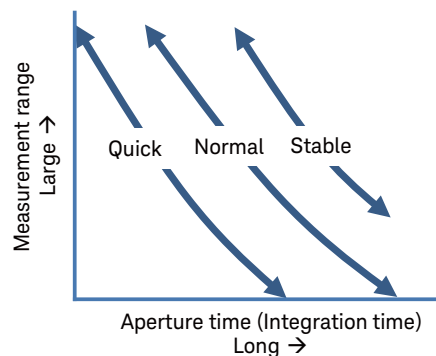

The aperture time can be set by using the following navigation keys.

Coarse Res Coarse resolution. Increases measurement speed (decreases aperture time).

[home] Sets the Normal auto aperture and the AUTO range.

Fine Res Fine resolution. Decreases measurement speed (increases aperture time).

NOTE

After the mode is changed from Automatic to Manual

The instrument keeps the last used aperture time. And the SPEED function key shows its value.

Also see "[Aperture Time](#)" on page 5-5.



Common Terminal Connection

The Common terminal is internally connected to the common of Ammeter, Analog Out, and Voltmeter. This terminal is used as the reference terminal for input/output of them.

For the measurement of the device which has a non-ground potential, the Common terminal must be connected to chassis ground by using a Banana-to-Lug cable (furnished) or equivalent. In this condition, the current/voltage measurement that refers to ground as reference is performed.

For the measurement of the device which has the ground potential, do not connect any cable between Common and chassis ground. to make the Ammeter/Voltmeter floating. This condition makes the potential difference between the input of Ammeter and ground and that may occur an error caused from the leakage current in low-current measurement. You can reduce an error by using guarding technique.

Figure 3-5

Guarding Technique

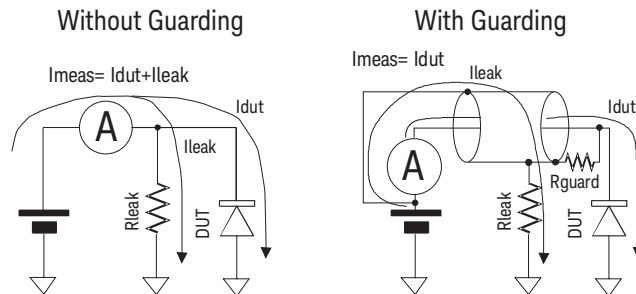

If a dielectric exists between the Input of Ammeter and the other potential, the leakage current flows in accordance with a potential difference and resistance. Guarding technique covers the wire connecting from the Input of Ammeter with a conductor (Guard) that has same potential as Input to cancel the potential difference from the surrounding dielectric so that the leakage current can be reduced. Because the Common and Input of Ammeter have almost same electric potential, connect the guard to the Common. In the case without guarding (left figure), I_{leak} occurs an error. In the case with guarding (right figure), I_{leak} does not flow through the Ammeter and does not effect the measurement. If the potential difference between both ends of R_{guard} is 0, no leakage current flows there.

WARNING

If the Common terminal is *not* connected to chassis ground, voltage of up to ± 500 V can be applied to the Common terminal. To prevent electrical shock, do not touch any of measurement circuit at any time while a floating measurement is in progress. Also use accessories that comply with IEC 61010-2-031. All terminals and the extended conductors must be isolated by using insulation caps, sleeves, etc.

WARNING

Si la borne commune n'est pas connectée à la masse, une tension de jusqu'à ± 500 V peut être appliquée au terminal Commun. Afin d'éviter toute décharge électrique, ne touchez aucune mesure de circuit à tout moment lorsque la mesure de flote est en cours. Utiliser également des accessoires qui sont conformes à la norme IEC 61010-2-031. Toutes les bornes et les conducteurs prolongés doivent être isolés en utilisant des bouchons d'isolation, des manchons, etc.

CAUTION

Do not apply current to the chassis ground. Doing so will damage the instrument.

Voltage Measurement

The B2985A/B2987A supports the voltage measurement capability shown in [Table 3-2](#).

Table 3-2 Voltage Measurement Range, Value, and Resolution

Range value	Measurement value	Display resolution
2 V	$0 \leq V \leq 2.1 \text{ V}$	1 μV
20 V	$0 \leq V \leq 21 \text{ V}$	10 μV

Requirements

Before turning the instrument on, connect cable, test leads, test fixture, and so on, used for the measurement. See [Figures 3-7](#) and [3-8](#) for connection examples.

The following accessories can be used.

- Triaxial cable, 200 V, 1.5 m
- Triaxial bulkhead connector, if needed
- Banana to alligator clip cable, for connecting Common to voltage under test low
- Banana to lug cable, for connecting Common to chassis ground

Instead of the triaxial cable and the triaxial bulkhead connector, Keysight N1415A Triaxial to alligator clip cable, 200 V, 1.5 m can be used.

NOTE

When turning the instrument on, leave the end of the measurement path open.

Figure 3-6

Simplified Circuit Diagram of Voltmeter

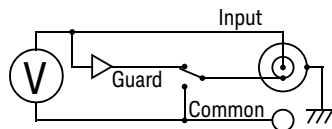

NOTE

Voltmeter connector's inner shield is internally connected to Guard or Common as shown in [Figure 3-6](#). The internal connection must be made properly. It must be connected to Guard for the guarded voltage measurement. And it must be connected to Common for the unguarded voltage measurement. Incorrect setup causes measurement errors. See "[Guarded and Unguarded Connections](#)" on [page 3-17](#) for more information.

Figure 3-7 Guarded Voltage Measurement Connection

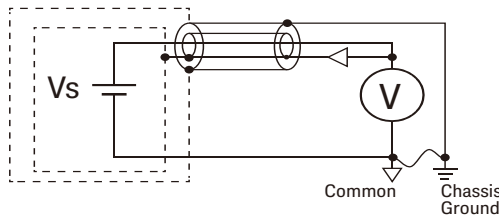
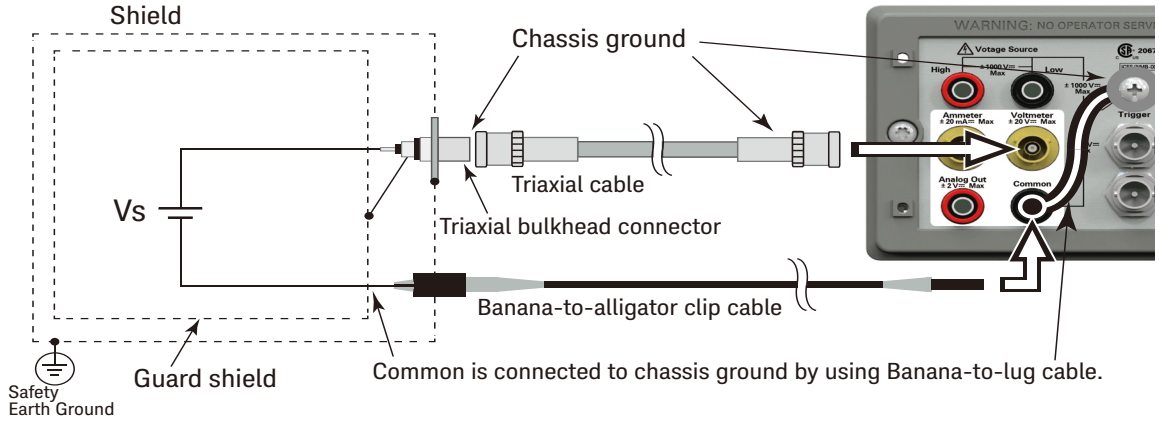
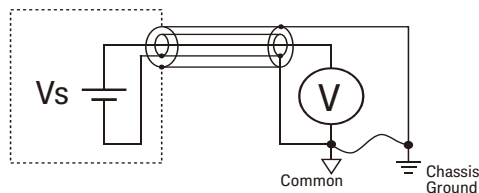
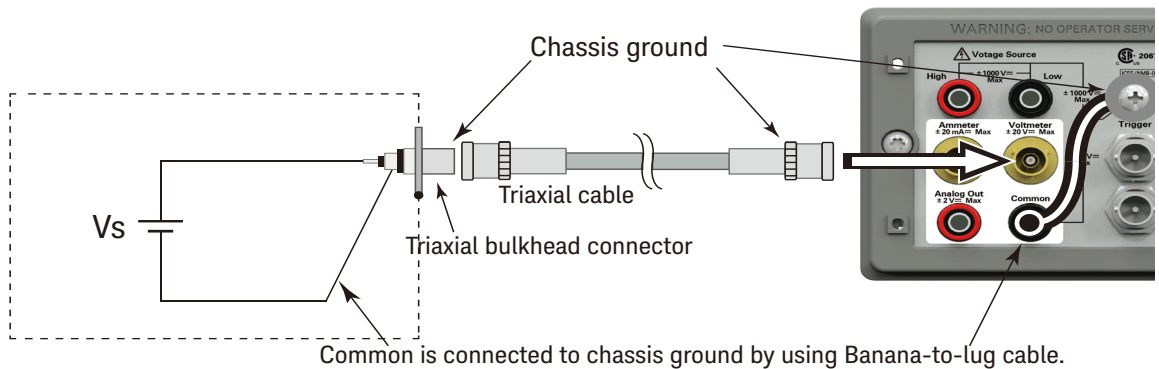

Figure 3-8 Unguarded Voltage Measurement Connection



How to Perform Measurement

Voltage Measurement

Instead of connecting the inner shield (Common) of Voltmeter, a banana to alligator clip cable can be used for connecting Common to low terminal of voltage under test.

NOTE

For floating voltmeter, do not connect any cable between Common and chassis ground. See "[Common Terminal Connection](#)" on page 3-12 for more information.

Procedure

You can perform the voltage measurement as follows.

- Step 1.** Press the **View** key and the Meter View function key to display the Meter view.
- Step 2.** Press the **VOLTS (V)** assist key to set the voltage measurement mode.
- Step 3.** Use the navigation keys or the RANGE function key to set the measurement range you want to use. See "[Measure Volts](#)" on page 3-18 for more information.
- Step 4.** Use the navigation keys or the SPEED function key to set the measurement speed (aperture time) you desire. See "[Aperture Time](#)" on page 3-18 for more information.
- Step 5.** Press the **Filter** key to open the Measure Filter dialog box. And set the measurement filter on the dialog box. See "[Filter](#)" on page 3-18 for more information.
- Step 6.** Connect measurement voltage (DUT).

See [Figure 3-7](#) for the guarded voltage measurement.

See [Figure 3-8](#) for the unguarded voltage measurement.
- Step 7.** Start measurement as follows.
 - Press the **Single** key to start a single (one shot) measurement. Voltage measurement is performed once.
 - Press the **Run/Stop** key to start a repeat (continuous) measurement. Voltage measurement is performed repeatedly. Minimum measurement interval is 10 ms.

For more precise measurement, use the zero correction or offset cancel. See "[Null, Offset Cancel](#)" on page 5-9.

Setup Parameters

This section briefly describes how to set key parameters effective for accurate and reliable voltage measurement.

Guarded and Unguarded Connections

Voltmeter input is a triaxial connector. The center conductor and the outer shield are connected to the voltmeter input and the chassis ground respectively. And the inner shield must be connected to Guard for the guarded voltage measurement or Common for the unguarded voltage measurement.

To make this internal connection, open the Input Connection dialog box by pressing the System Menu > Config > Measure > Connection function keys and set the Voltage Measure Inner Shield field properly. The following values are available.

- | | | |
|--------------|---|---|
| GUARD | Inner shield is connected to Guard. For the guarded voltage measurement connection for performing accurate measurement. Guarded voltmeter indicator turns on. |  |
| CCOM | Inner shield is connected to Common. For the unguarded voltage measurement connection which makes connection easy. Guarded voltmeter indicator turns off. | |

To set the value, use the assist key and/or the rotary knob, and press OK to apply the setting and close the dialog box.

Figure 3-9

Differences between GUARD and CCOM

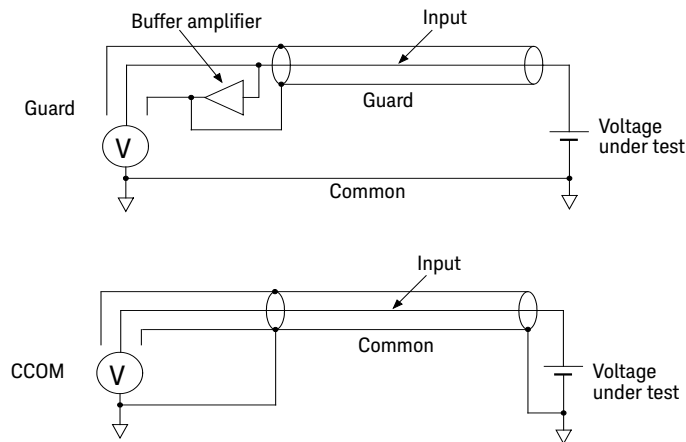

NOTE

The guarded voltage measurement is effective when the guarded voltmeter indicator turns on. In this setup, the same potential voltage appears at the center conductor (Input) and the inner shield through a buffer amplifier ($\times 1$) as shown in [Figure 3-9](#). It is effective for performing voltage measurement accurately.

See ["Guarding" on page 3-19](#) for more information.

Measure Volts

Press the RANGE function key to change the ranging mode, auto or fixed. Where, The softkey label shows the present measurement range setting, AUTO or fixed range value.

Measurement range can be set by using the following navigation keys.

- | | |
|----------------|---|
| Range + | Sets the fixed range mode and changes the range up. |
| [home] | Sets the AUTO range and the Normal auto aperture. |
| Range - | Sets the fixed range mode and changes the range down. |

See ["Measurement Range" on page 3-9](#) for more information.

Aperture Time

Press the SPEED function key to change the aperture mode, auto or manual. Where, the softkey label shows the present aperture time setting.

Aperture time can be set by using the following navigation keys.

- | | |
|-------------------|--|
| Coarse Res | Increases measurement speed (decreases aperture time). |
| [home] | Sets the Normal auto aperture and the AUTO range. |
| Fine Res | Decreases measurement speed (increases aperture time). |

See ["Aperture Time" on page 3-10](#) for more information.

Filter

Measurement filter function can be enabled/disabled by using the Filter key.

If the FILT indicator is turned off, pressing the Filter key opens the Measure Filter dialog box. Pressing OK after setting up the dialog box enables the filter function and turns the FILT indicator on.

If the FILT indicator is turned on, pressing the Filter key disables the function and turns the FILT indicator off.

The filter function is used to average measurement result data, calculate moving average, and so on. For the precise and reliable measurement, it is recommended to use the filter function, see "[Measurement Filter](#)" on page 5-12 for more information.

Guarding

Guarding is effective when a voltage source under test has the high output resistance.

Figure 3-10 shows the theory of guarding. If the guard is not used, the inner shield of triaxial cable has Common potential and the same voltage as the measured voltage is applied between center and inner conductors. The insulation resistance of cable is a finite value, so the voltage divided by the ratio of the output resistance of voltage source under test to the insulation resistance of cable is measured. If the output resistance is too large, an error that cannot be ignored may occur in the measured data.

Also, there is an electrostatic capacitance between the inner shield and the center conductor of triaxial cable, so the measured voltage is settled according to the time constant determined by the electrostatic capacitance and the output resistance. If the output resistance is too large, the settling may require the longer time.

If the guard is used, the buffer amplifier keeps the potential of the inner shield at the same potential as the center conductor of triaxial cable. So, the voltage is not applied between both end of insulation resistance and capacitance of cable, and these affect can be ignored. Therefore, you can make the precise and fast measurement even for the voltage source under test that has the large output resistance.

Figure 3-10

Guarding

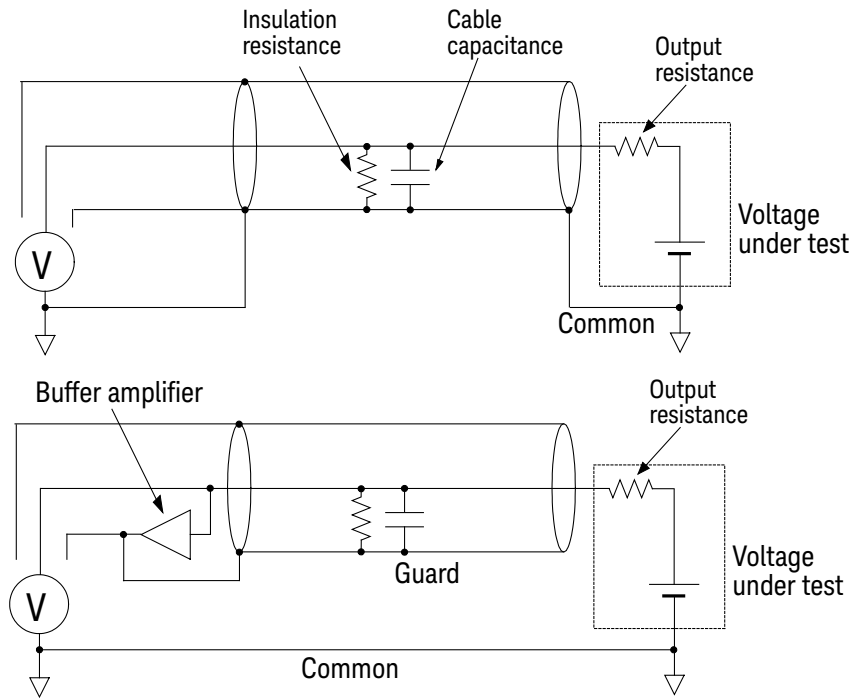

CAUTION

Never connect the Guard terminal to any output, including circuit common, chassis ground, or any other guard terminal. Doing so will damage the instrument.

Resistance Measurement

The B2985A/B2987A supports the resistance measurement up to 1000 P Ω (reference value).

Requirements

Before turning the instrument on, connect cable, test leads, test fixture, and so on, used for the measurement. See Figures 3-12 to 3-15 for connection examples.

The following accessories can be used.

- Triaxial cable, 200 V, 1.5 m
- Triaxial bulkhead connector, if needed
- High voltage test lead, 1000 V, 1.2 m, for High terminal
- Banana to lug cable, for connecting Common to chassis ground
- Banana to banana cable, for connecting Voltage Source High to Common
- Keysight N1414A High resistance measurement universal adapter

Instead of the triaxial cable and the triaxial bulkhead connector, Keysight N1415A Triaxial to alligator clip cable, 200 V, 1.5 m can be used.

NOTE

When turning the instrument on, leave the end of the measurement path open.

The following accessories are also available for high resistance measurement.

- Keysight N1424A/B/C Resistivity Cell
- Keysight N1425A/B Low Noise Test Lead, clip end
- Keysight N1427A/B Low Noise Test Lead, connector end, with bulkhead connectors
- Keysight N1428A Component Test Fixture

To use the accessory, Keysight N1413A adapter is required. See Figure 3-11 for connecting the accessory. Attach and connect the N1413A to the instrument, and connect the accessory to the adapter which provides the connectors suitable for the accessory. Always set the voltage source Low terminal state to FLOATING.

All accessories can be used for the floating device measurement with the control switch PULL position of the N1413A. Note that the N1425A/B and N1427A/B can also be used for the grounded device measurement with the PUSH position.

How to Perform Measurement
Resistance Measurement

Figure 3-11

Connecting Accessory for High Resistance Measurement using N1413A

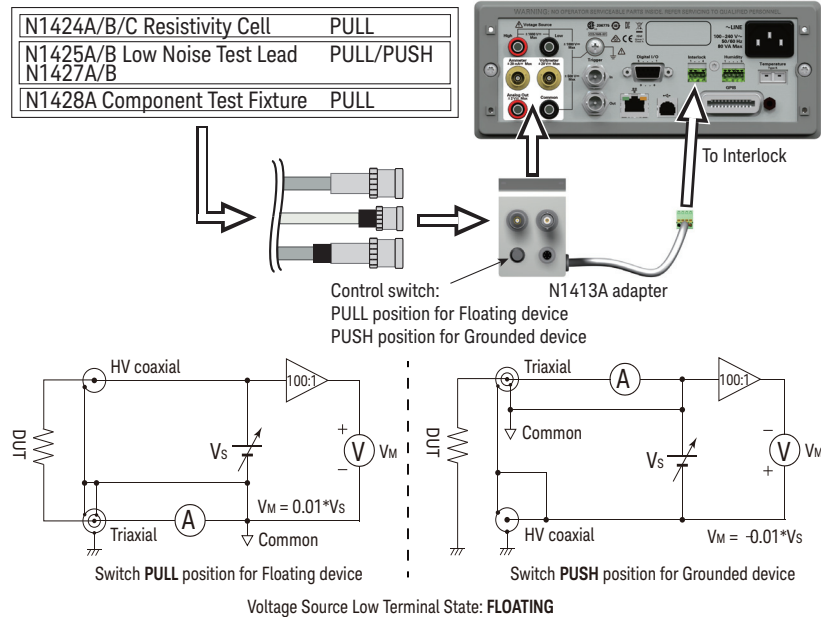

For more information about using the accessories, see *Operation Manual* of each accessory.

NOTE

To apply a voltage over $\pm 21\text{V}$, the Interlock terminal must be connected to an interlock circuit. See "[Interlock](#)" on page 3-31.

WARNING

To attach the N1413A/N1414A adapter, push it to the B2985A/B2987A connectors.
Push the adapter in firmly until it locks in-place ($< 1\text{ mm}$ spacing)

WARNING

Pour fixer l'adaptateur N1413A/N1414A, enfoncez-le dans les connecteurs B2985A/B2987A.
Poussez l'adaptateur fermement jusqu'à ce qu'il se verrouille en position (espace $< 1\text{ mm}$).

NOTE

For using the N1413A/N1414A adapter, set the Low Terminal State to FLOATING. Voltage Source Low is connected to the chassis ground through the adapter.

NOTE

If you use the N1413A/N1414A adapter, you do not need to care about setting of the Voltmeter connector's inner shield. It is opened at the adapter's input.

Figure 3-12

Floating Device Measurement

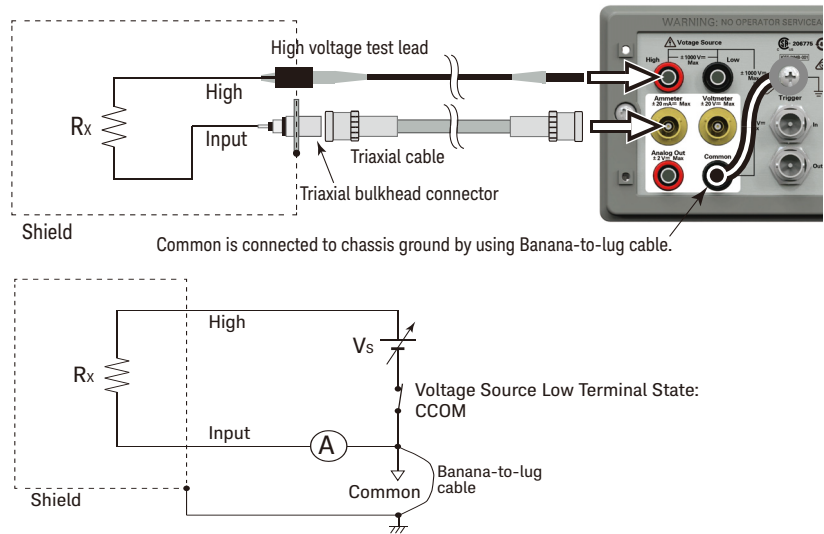

NOTE

Voltage Source Low terminal is internally connected to or disconnected from the circuit common as shown in Figure 3-12. See "[Low Terminal State](#)" on page 3-29 for more information.

Figure 3-13

Floating Device Measurement using N1414A

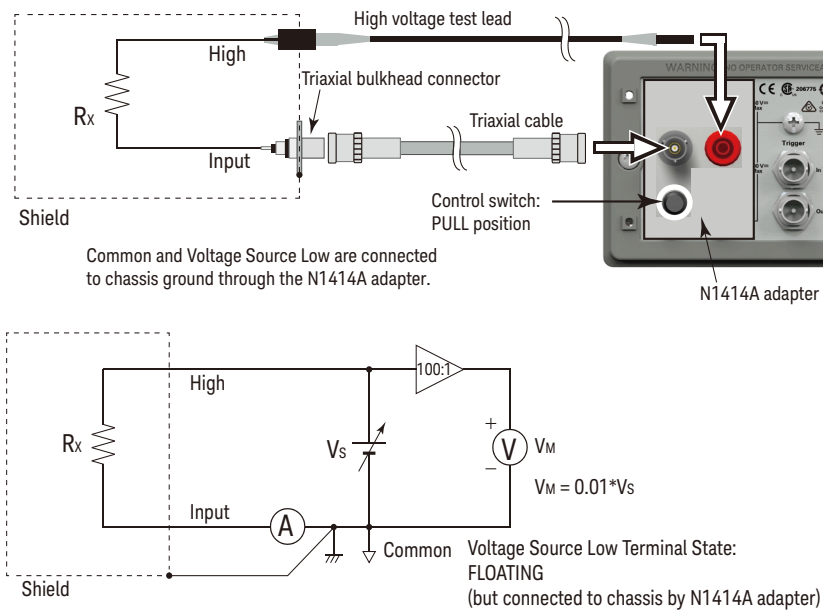

For the floating device measurement, set the N1414A control switch to the PULL position. Also set the voltage source Low terminal state to FLOATING.

Figure 3-14

Grounded Device Measurement

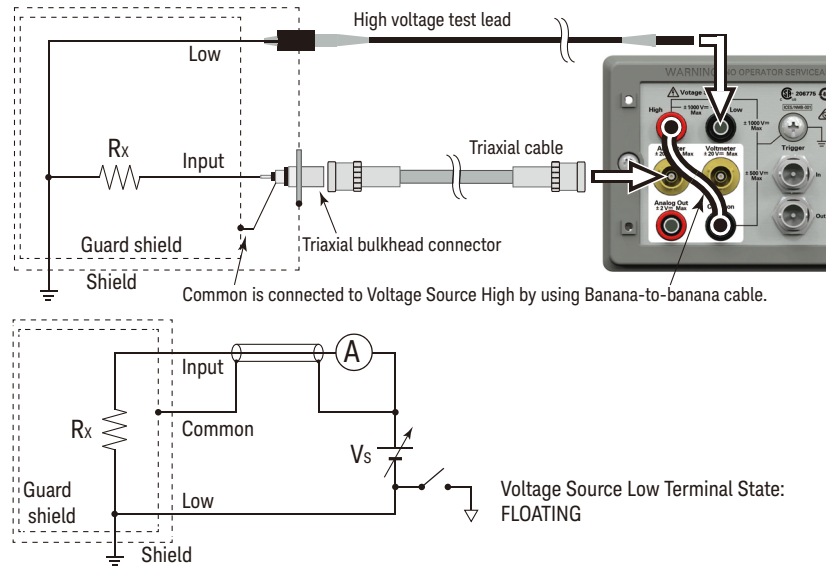

NOTE

The connection shown in [Figure 3-14](#) applies the voltage to the Common terminal from the Voltage Source. The voltage up to ± 500 V can be applied to the Common terminal.

NOTE

Voltage Source Low terminal is internally connected to or disconnected from the circuit common as shown in [Figure 3-14](#). See "[Low Terminal State](#)" on [page 3-29](#) for more information.

How to Perform Measurement Resistance Measurement

Figure 3-15

Grounded Device Measurement using N1414A

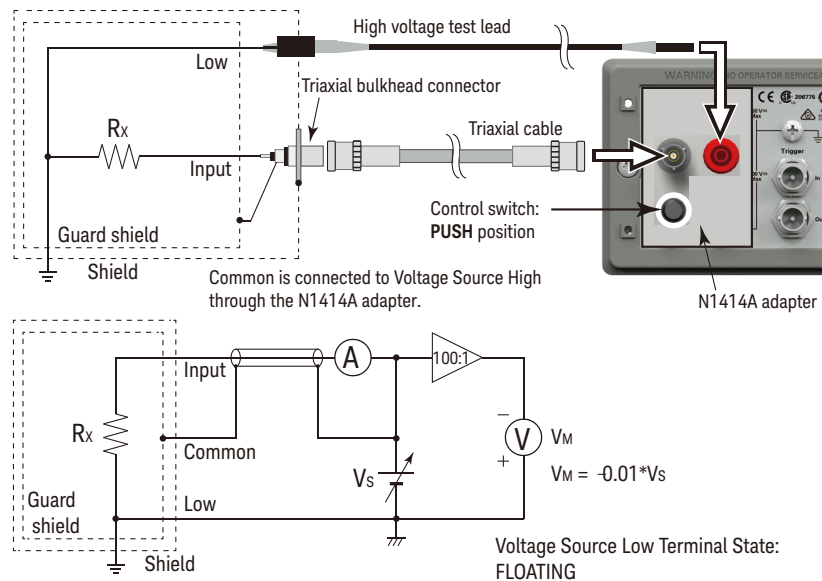

For the grounded device measurement, set the N1414A control switch to the PUSH position. Also set the voltage source Low terminal state to FLOATING.

NOTE

The connection shown in [Figure 3-15](#) applies the voltage to the Common terminal from the Voltage Source. The voltage up to ± 500 V can be applied to the Common terminal.

Procedure

You can perform the resistance measurement as follows.

- Step 1.** Set the resistance calculation mode, Vs/Im or Vm/Im. See "[Resistance Calculation Mode](#)" on page 3-28.
- Step 2.** Press the **View** key and select the Meter View function key to display the Meter view.
- Step 3.** Press the **OHMS (R)** assist key to set the resistance measurement mode.
- Step 4.** Set the current measurement range and the output voltage. See "[V Control Mode](#)" on page 3-28.

If the Auto V Control mode is used, set the resistance range. Use the RANGE function key and the navigation keys to set the range you desire. See "[Measure Ohms](#)" on page 3-29 for more information.

- Step 5.** Use the SPEED function key and the navigation keys to set the measurement speed (aperture time) you desire. See "[Aperture Time](#)" on page 3-30 for more information.
- Step 6.** Press the **Filter** key to open the Measure Filter dialog box. And set the measurement filter on the dialog box. See "[Filter](#)" on page 3-30 for more information.
- Step 7.** Connect resistor (DUT) to measure. See Figures 3-11 to 3-15 for the connection.
- Step 8.** Press the Ammeter **On/Off** switch to enable Ammeter. This turns the switch green.
- Step 9.** Press the Voltage Source **On/Off** switch to enable the voltage output. This turns the switch green. And the voltage source starts output.
- Step 10.** Start measurement as follows.
- Press the **Single** key to start a single (one shot) measurement. Resistance measurement is performed once.
 - Press the **Run/Stop** key to start a repeat (continuous) measurement. Resistance measurement is performed repeatedly. Minimum measurement interval is 10 ms.
- Step 11.** Press the Voltage Source **On/Off** switch to disable the voltage output. This turns off the switch light.
- Step 12.** Press the Ammeter **On/Off** switch to disable Ammeter. This turns off the switch light.

NOTE

To perform the staircase sweep measurement, see "[Staircase Sweep Output Setup](#)" on page 3-34.

To perform the list sweep measurement, see "[List Sweep Output Setup](#)" on page 3-35.

To perform the measurement with the square wave voltage output, see "[Square Wave Output Setup](#)" on page 3-37.

Setup Parameters

This section briefly describes how to set key parameters effective for accurate and reliable resistance measurement.

Resistance Calculation Mode

Resistance measurement value is calculated by the formula, $R=V_s/I_m$ or $R=V_m/I_m$. Where, V_m is measurement voltage, I_m is measurement current, and V_s is output voltage. The mode can be specified by pressing the function keys System Menu > Config > Measure > Ohms > V Select Source or V Select Measure.

Source This mode is effective when this softkey label shows “V Select Source”. Resistance value is calculated by the formula, $R=V_s/I_m$.

Measure This mode is effective when this softkey label shows “V Select Measure”. Resistance value is calculated by the formula, $R=V_m/I_m$. To use this mode, set the voltage measurement range (Measure Volts).

V Control Mode

V Control mode (Auto or Manual) declares the resistance measurement setup parameter. The mode can be specified by pressing the function keys System Menu > Config > Measure > Ohms > V Control Auto or V Control Manual.

Auto This mode is effective when this softkey label shows “V Control Auto”. Set the resistance range (Measure Ohms). The current measurement range and the output voltage used for measurement are automatically set as shown in [Table 3-3](#). See ["Measure Ohms" on page 3-29](#).

Manual This mode is effective when this softkey label shows “V Control Manual”. Set the current measurement range (Measure Amps), the voltage output range (Spot Source Range), and the output voltage (Voltage Source) used for measurement. These setup fields are on the Meter view and in the range setup sub-panel displayed by pressing the **Hide XXX** assist key. To set the output voltage, press the **Source** assist key and set the value into the Voltage Source field by using the rotary knob and/or the assist key. To see these assist keys, you may need to press the **More... 1 of 3** assist key and/or the **More... 2 of 3** assist key.

Low Terminal State

Voltage Source Low terminal is internally connected to or disconnected from the circuit common. To make this internal connection, open the Output Connection dialog box by pressing the System Menu > Config > Source > Connection function keys and set the Low Terminal State field properly.

The following values are available.

CCOM Low terminal is internally connected to the circuit common. Floating indicator turns off.

FLOATING Low terminal is internally disconnected from the circuit common. Floating indicator turns on.



This setting is used when applying voltage to the Common terminal.

To set the value, use the assist key and/or the rotary knob, and press OK to apply the setting and close the dialog box.

See "[Floating Low](#)" on page 3-33 for more information.

CAUTION

Although the Low terminal is set to FLOATING, the High potential and the Low potential must be less than or equal to ± 1050 V for chassis ground. The output voltage is limited to ± 1050 V even if the Voltage Source makes the cascade connection with an external voltage source.

NOTE

When the both Low and Common terminals are in the floating condition, the potential of the Common terminal must be between the Low potential and the High potential. And it must be less than or equal to ± 500 V for chassis ground.

NOTE

When Keysight N1413A or N1414A adapter is used, Voltage Source Low is connected to chassis ground through the adapter. So, set the Low terminal state to FLOATING when using the adapter.

Measure Ohms

Press the RANGE function key to change the ranging mode, auto or fixed. Where, the softkey label shows the present measurement range setting, AUTO or fixed range value.

Measurement range can be set by using the following navigation keys.

Range + Sets the fixed range mode and changes the range up.

[home] Sets the AUTO range and the Normal auto aperture.

Range - Sets the fixed range mode and changes the range down.

See "[Measurement Range](#)" on page 3-9 for more information.

Table 3-3 Resistance Range, Value, and Resolution for Auto V Control

Range value	Current range used for measurement	Output value set to voltage source	Measurement value	Display resolution
1 MΩ	200 μA	20 V	$100 \text{ k}\Omega \leq R $	1 Ω
10 MΩ	20 μA		$1 \text{ M}\Omega \leq R $	10 Ω
100 MΩ	2 μA		$10 \text{ M}\Omega \leq R $	100 Ω
1 GΩ	200 nA		$100 \text{ M}\Omega \leq R $	1 kΩ
10 GΩ	20 nA		$1 \text{ G}\Omega \leq R $	10 kΩ
100 GΩ	2 nA		$10 \text{ G}\Omega \leq R $	100 kΩ
1 TΩ	2 nA	200 V	$100 \text{ G}\Omega \leq R $	1 MΩ
10 TΩ	200 pA		$1 \text{ T}\Omega \leq R $	10 MΩ
100 TΩ	20 pA		$10 \text{ T}\Omega \leq R $	100 MΩ
1 PΩ	2 pA		$100 \text{ T}\Omega \leq R $	1 GΩ

Aperture Time

Press the SPEED function key to change the aperture mode, auto or manual. Where, the softkey label shows the present aperture time setting.

Aperture time can be set by using the following navigation keys.

Coarse Res Increases measurement speed (decreases aperture time).

[home] Sets the Normal auto aperture and the AUTO range.

Fine Res Decreases measurement speed (increases aperture time).

See "[Aperture Time](#)" on page 3-10 for more information.

Filter

Measurement filter function can be enabled/disabled by using the Filter key.

If the FILT indicator is turned off, pressing the Filter key opens the Measure Filter dialog box. Pressing OK after setting up the dialog box enables the filter function and turns the FILT indicator on.

If the FILT indicator is turned on, pressing the Filter key disables the function and turns the FILT indicator off.

The filter function is used to average measurement result data, calculate moving average, and so on. For the precise and reliable measurement, it is recommended to use the filter function, see "[Measurement Filter](#)" on page 5-12 for more information.

Interlock

The interlock function is designed to prevent electrical shock when a user touches the measurement terminals. If the Interlock terminal on the rear panel is open, Voltage Source *cannot* apply a high voltage over ± 21 V.

To remove this restriction for high voltage output, the Interlock terminal must be connected to an interlock circuit installed in a test fixture or a connection interface. If there is no interlock circuit, you need to install it. For more information on the interlock circuit and how to install the interlock circuit, see "[Installing the Interlock Circuit](#)" on page 2-14.

If the interlock circuit is opened during Voltage Source applies a voltage over ± 21 V, the output voltage is set to 0 V immediately and the output relay is opened.

Voltage Source

The B2985A/B2987A supports the voltage source capability shown in [Table 3-4](#).

Table 3-4 Voltage Output Range, Value, Resolution, and Maximum Current

Range value	Voltage output value	Display resolution	Maximum current
20 V	$0 \leq V \leq 21 \text{ V}$	700 μV	$\pm 20 \text{ mA}$
+1000 V	$0 \leq V \leq 1050 \text{ V}$	35 mV	$\pm 1 \text{ mA}$
-1000 V	$-1050 \text{ V} \leq V \leq 0$		

Figure 3-16 Simplified Circuit Diagram of Voltage Source

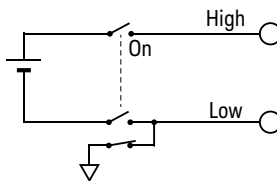

Procedure 1 You can apply DC voltage as follows.

- Step 1.** Press the **View** key and select the Meter View function key to display the Meter view.
- Step 2.** Use the Spot Source Range field to set the output range you want to use. See "[DC Voltage Output Range](#)" on page 3-34 for more information.
- Step 3.** Press the **More... 1 of 3**, **More... 2 of 3**, and **Source** assist keys to move the field pointer onto the Voltage Source field.
- Step 4.** Set the output voltage value to the Voltage Source field. Then use the rotary knob and/or the assist key.
- Step 5.** Press the Voltage Source **On/Off** switch to enable the output. This turns the switch green. And the voltage source starts output.
- Step 6.** Press the Voltage Source **On/Off** switch to disable the output. This turns off the switch light.

Procedure 2 You can apply sweep voltage as follows.

- Step 1.** Press the **View** key and select the Meter View function key to display the Meter view.

Step 2. Perform "**Procedure 1**" to set the output voltage before starting sweep output.

Step 3. Set the voltage sweep output.

See "**Staircase Sweep Output Setup**" on page 3-34 for the staircase sweep output.

See "**List Sweep Output Setup**" on page 3-35 for the list sweep output.

Step 4. Press the Voltage Source **On/Off** switch to enable the output. This turns the switch green. And the voltage source starts output specified by the Voltage Source field.

Step 5. Press the **Single** key. The specified sweep output is performed.

Step 6. Press the Voltage Source **On/Off** switch to disable the output. This turns off the switch light.

Procedure 3 You can apply square wave voltage as follows.

Step 1. Press the **View** key and select the Meter View function key to display the Meter view.

Step 2. Perform "**Procedure 1**" to set the output voltage before starting square wave output.

Step 3. Set the square wave parameters. See "**Square Wave Output Setup**" on page 3-37.

Step 4. Press the Voltage Source **On/Off** switch to enable the output. This turns the switch green. And the voltage source starts output specified by the Voltage Source field.

Step 5. Press the **Single** key. The specified square wave output is performed.

Step 6. Press the Voltage Source **On/Off** switch to disable the output. This turns off the switch light.



Floating Low

With the default setting, Voltage Source Low terminal is connected to the circuit common. However, it can be internally disconnected from the common for making the floating condition.

To specify the low terminal status, perform the following procedure. Setting is not saved. Turning off the instrument sets the status to CCOM. This procedure can be performed only if the voltage source output is Off.

1. Press the System Menu > Config > Source > Connection function keys. This opens the Output Connection dialog box.
2. Set the Low Terminal State on this dialog box. It must be FLOATING for making the floating condition, or CCOM for connecting to the circuit common.

3. Press OK.

For the floating status, the Floating indicator appears on the status information area.



CAUTION

Although the Low terminal is set to FLOATING, the High potential and the Low potential must be less than or equal to ± 1050 V for chassis ground. The output voltage is limited to ± 1050 V even if the Voltage Source makes the cascade connection with an external voltage source.

CAUTION

Do not apply current to the chassis ground. Doing so will damage the instrument.

DC Voltage Output Range

Voltage Source has three output ranges, 20 V range, +1000 V range, and -1000 V range, for applying DC voltage.

To set the output range, press the **20 V**, **+1000 V**, or **-1000 V** assist key available when the Spot Source Range field is in the EDIT status. This field is in the range setup sub-panel on the Meter view.

To display the sub-panel, you may need to press the **More... 1 of 3** assist key and the **Hide Hist.**, **Hide Roll**, or **Hide Trigger** assist key.

Staircase Sweep Output Setup

Voltage Source supports the following staircase sweep output.

- Linear single sweep

Voltage Source applies staircase sweep voltage from start to stop in a step. This sweep is available when VS Function is set to LINEAR SINGLE.

- Linear double sweep

Voltage Source applies staircase sweep voltage from start to stop in a step and from stop to start in the same step. This sweep is available when VS Function is set to LINEAR DOUBLE.

Sweep output is set by the following parameters. They are shown in the source function sub-panel on the Meter view. To display the sub-panel, press the **Show VS Func.** assist key. To see the assist key, you may need to press the **More... 1 of 3** assist key and/or the **More... 2 of 3** assist key.

VS Function LINEAR SINGLE or LINEAR DOUBLE

Start Sweep start voltage, in V

Stop	Sweep stop voltage, in V
Points	Number of sweep steps between Start and Stop
Step	Sweep step voltage, in V

For Point and Step, specify one. Other one is automatically calculated by the formula, $\text{Point} = \frac{|\text{Stop} - \text{Start}|}{|\text{Step}|} + 1$.

To set the parameter value, use the assist key and/or the rotary knob.

To confirm the sweep output shape, press the **Show Preview** assist key.

Additionally the following setup parameters are available. They are shown in the Sweep dialog box opened by pressing the System Menu > Config > Source > Sweep function keys.

Sweep Ranging Ranging mode FIXED or BEST (automatically uses the minimum range which covers the whole sweep output)

Sweep Direction Direction UP (Start to Stop) or DOWN (Stop to Start)

Output after Sweep Output voltage after sweep, START VALUE or END VALUE

To set the parameter value, use the assist key and/or the rotary knob, and press OK to apply the settings and close the dialog box.

List Sweep Output Setup

Voltage Source can apply the voltage specified by the list you define.

To set the list sweep output, display the source function sub-panel on the Meter view by pressing the **Show VS Func.** assist key. To see the assist key, you may need to press the **More... 1 of 3** assist key and/or the **More... 2 of 3** assist key. And set LIST to the VS Function field. The sub-panel shows the following information.

VS Function	LIST
Start	First value set to the list, in V
Stop	Last value set to the list, in V
Points	Number of values set to the list

To perform the list sweep output, a list sweep data is required. The data can be defined or loaded by using the List Sweep dialog box or the Load List Sweep Data dialog box opened by pressing one of the following assist keys displayed by pressing the rotary knob on the Start, Stop, or Points field.

Edit Opens the List Sweep dialog box used to define the list.

Load Opens the Load List Sweep Data dialog box used to load the list sweep data.

List Sweep dialog box.

This dialog box provides the following GUI for defining the list sweep data. After the list is completed, press OK to apply the data and close the dialog box.

(data graph) Displays the shape of the list sweep output

(data list) Lists the data index in the left cell and the output value in the right cell.
When the pointer is in the MOVE status, turning the rotary knob moves the pointer onto the left or right cell. And pressing the knob changes the status to EDIT.
When the right cell is in the EDIT status, the output value can be entered by using the rotary knob.
When the left cell is in the EDIT status, the following assist keys are available for creating and scrolling the list.
Then turning the rotary knob scrolls the list and pressing the knob changes the status to MOVE.

Append Adds a line below. The same output value is entered into the right cell.

Insert Adds a line above. The same output value is entered into the right cell.

Delete Deletes the line.

Scroll -100 Moves the pointer to the maximum 100 points above.

Scroll +100 Moves the pointer to the maximum 100 points below.

Points Number of values set to the list

Max Maximum value

Min Minimum value

Load List Sweep Data dialog box.

This dialog box provides the following GUI for loading a list sweep data from a file stored on a USB memory.

Highlight the file to load by using the line cursor. And press OK to load the data and close the dialog box. The line cursor can be moved by turning the rotary knob.

(data graph)	Displays the shape of the list sweep data selected by the file list
Path	Folder which stores the list sweep data file
(file list)	List of the list sweep data file
Points	Number of values set to the list sweep data
Max	Maximum value in the list sweep data
Min	Minimum value in the list sweep data

The list sweep data must contain the output values only in the following format.

- File extension txt: Values separated by a carriage return or a line feed, for example 0=1=2=1 (where, carriage return is expressed by =)
- File extension csv: Values separated by a comma, for example 0,=1,=2,=1
- File extension prn: Values separated by a space, for example 0 1 2 1

Square Wave Output Setup

Voltage Source supports the square wave output.

Square wave output is set by the following parameters. They are shown in the source function sub-panel on the Meter view. To display the sub-panel, press the **Show VS Func.** assist key. To see the assist key, you may need to press the **More... 1 of 3** assist key and/or the **More... 2 of 3** assist key.

VS Function	ARB SQUARE
Start	Square wave base voltage, in V
Peak	Square wave peak voltage, in V
Delay	Period of base output before peak, in s
Peak Time	Period of peak output, in s
End Time	Period of base output after peak, in s
Count	Number of square wave outputs

To set the parameter value, use the assist key and/or the rotary knob.

To confirm the waveform, press the **Show Preview** assist key.

Charge Measurement

The B2985A/B2987A supports the charge measurement capability shown in [Table 3-5](#). It can be the coulomb meter by using the Ammeter terminal.

Table 3-5 Charge Measurement Range, Value, and Resolution

Range value	Measurement value	Display resolution
2 nC	$0 \leq Q \leq 2.1 \text{ nC}$	1 fC
20 nC	$0 \leq Q \leq 21 \text{ nC}$	10 fC
200 nC	$0 \leq Q \leq 210 \text{ nC}$	100 fC
2 μC	$0 \leq Q \leq 2.1 \mu\text{C}$	1 pC

Requirements

Before turning the instrument on, connect cable, test leads, test fixture, and so on, used for the measurement. See [Figure 3-17](#) for connection examples.

The following accessories can be used.

- Triaxial cable, 200 V, 1.5 m
- Triaxial bulkhead connector, if needed
- Banana to lug cable, for connecting Common to chassis ground

Instead of the triaxial cable and the triaxial bulkhead connector, Keysight N1415A Triaxial to alligator clip cable, 200 V, 1.5 m can be used.

NOTE

When turning the instrument on, leave the end of the measurement path open.

NOTE

For floating the coulomb meter, do not connect any cable between Common and chassis ground. See "[Common Terminal Connection](#)" on page 3-12 for more information.

Figure 3-17

Charge Measurement Connection

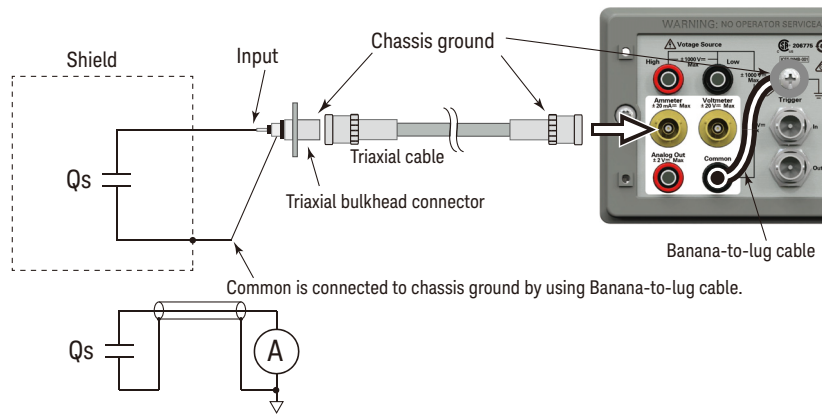

Procedure

You can perform the charge measurement as follows. Also see "[About Charge Measurement](#)" on page 3-41.

- Step 1.** Set the automatic discharge function. See "[Automatic Discharge](#)" on page 3-40.
- Step 2.** Press the **View** key and select the Meter View function key to display the Meter view.
- Step 3.** Press the **COUL. (Q)** assist key to set the charge measurement mode.
- Step 4.** Use the RANGE function key and the navigation keys to set the measurement range you want to use. See "[Measure Coulomb](#)" on page 3-40 for more information.
- Step 5.** Use the SPEED function key and the navigation keys to set the measurement speed (aperture time) you desire. See "[Aperture Time](#)" on page 3-40 for more information.
- Step 6.** Press the **Filter** key to open the Measure Filter dialog box. And set the measurement filter on the dialog box. See "[Filter](#)" on page 3-41 for more information.
- Step 7.** Connect measurement charge (DUT) to the Ammeter input connector. See [Figure 3-17](#) for the connection.
- Step 8.** Press the Ammeter **On/Off** switch to enable the coulomb meter. This turns the switch green.
- Step 9.** Start measurement as follows.
 - Press the **Single** key to start a single (one shot) measurement. Charge measurement is performed once.
 - Press the **Run/Stop** key to start a repeat (continuous) measurement. Charge measurement is performed repeatedly. Minimum measurement interval is 10 ms.

- Step 10.** Press the Ammeter **On/Off** switch to disable the coulomb meter. This turns off the switch light.

For more precise measurement, use the zero correction or offset cancel. See "[Null, Offset Cancel](#)" on page 5-9.

Setup Parameters

This section briefly describes how to set key parameters effective for accurate and reliable charge measurement.

Automatic Discharge

The automatic discharge function is effective for preventing the coulomb meter from range overflow. If this function is enabled, the coulomb meter resets the charge when the charge reaches the specified level. After resetting, the charge measurement restarts.

This function is enabled/disabled by pressing the System Menu > Config > Measure > Coulomb > Auto Dis. function keys. This softkey label shows the present setting ON (enable) or OFF (disable).

The discharge level can be selected from 2 nC, 20 nC, 200 nC, or 2 μ C by pressing the System Menu > Config > Measure > Coulomb > Dis. Level function keys. This softkey label shows the present setting.

Measure Coulomb

Press the RANGE function key to change the ranging mode, auto or fixed. Where, the softkey label shows the present measurement range setting, AUTO or fixed range value.

Measurement range can be set by using the following navigation keys.

- | | |
|----------------|---|
| Range + | Sets the fixed range mode and changes the range up. |
| [home] | Sets the AUTO range and the Normal auto aperture. |
| Range - | Sets the fixed range mode and changes the range down. |

See "[Measurement Range](#)" on page 3-9 for more information.

Aperture Time

Press the SPEED function key to change the aperture mode, auto or manual. Where, the softkey label shows the present aperture time setting.

Aperture time can be set by using the following navigation keys.

Coarse Res Increases measurement speed (decreases aperture time).

[home] Sets the Normal auto aperture and the AUTO range.

Fine Res Decreases measurement speed (increases aperture time).

See "[Aperture Time](#)" on page 3-10 for more information.

Filter

Measurement filter function can be enabled/disabled by using the Filter key.

If the FILT indicator is turned off, pressing the Filter key opens the Measure Filter dialog box. Pressing OK after setting up the dialog box enables the filter function and turns the FILT indicator on.

If the FILT indicator is turned on, pressing the Filter key disables the function and turns the FILT indicator off.

The filter function is used to average measurement result data, calculate moving average, and so on. For the precise and reliable measurement, it is recommended to use the filter function, see "[Measurement Filter](#)" on page 5-12 for more information.

About Charge Measurement

The coulomb meter can measure charges with the wide range from the minimum range 2 nC (resolution: 1 fC) to the maximum range 2 μ C (resolution 1 pC). The input amplifier circuit of the coulomb meter has a capacitor in the feedback loop so that its voltage is proportional to the integral of the input current. The capacitance value is known and accurate. And the capacitance C , charge Q_s , and voltage V are expressed by the following formula.

$$V = \frac{1}{C} \int i dt = \frac{Q_s}{C}$$

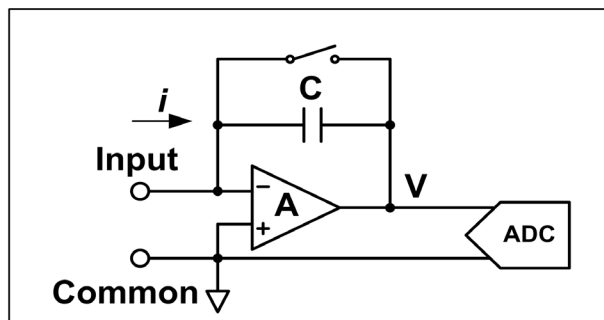

Temperature and Humidity Measurement

The B2985A/B2987A supports temperature and humidity measurement capability.

With the factory default setting, the B2985A/B2987A will measure temperature if a thermocouple is connected properly. Also the B2985A/B2987A will measure humidity if a humidity sensor is connected properly.

Table 3-6

Temperature and Humidity Measurement Range

	Temperature	Humidity
Type-K Thermocouple	-25 °C to 150 °C	NA
Humidity Sensor	-40 °C to 80 °C	0 % to 100 %

Requirements

Before turning the instrument on, connect accessory used for the measurement. See [Figure 3-18](#) for connection.

The following accessories can be used.

- Thermocouple, type K, 3.5 m, Keysight N1423A
- Humidity sensor, E+E Elektronik EE07 or equivalent, and connection cable (E+E Elektronik HA010819 or equivalent)
- Connector head, Phoenix Contact 1551354 (5 pin) or equivalent, for connecting humidity sensor

Preparation for connecting humidity sensor

Connect the connection cable to the connector head. See [Figure 3-18](#) for the connector head pin numbers and the coating colors of cable wire.

To connect the cable to the connector head, just insert the corresponding wire into the appropriate wire hole of the connector head.

If the wire can be removed easily due to a slippery pin of wire tip, cut off the pin and strip the coating of the tip. Then, retry insert.

If you made a wrong connection, remove wire and retry insert. You can remove the wire by pushing the associated button (orange) and pulling the wire.

Figure 3-18

Temperature and Humidity Measurement Connection

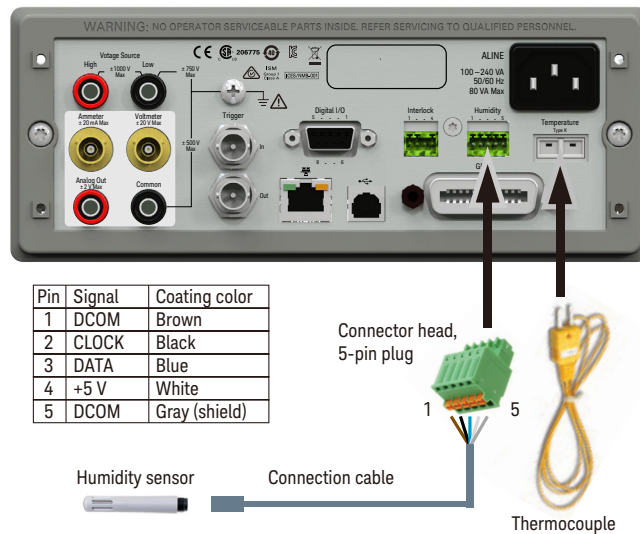

To enable/disable measurement

1. Press the System Menu > Display > Pref. ... function keys.
The Display Preference dialog box appears.
2. Set the Temperature field as follows.
ON: Enables temperature measurement (factory default setting)
OFF: Disables temperature measurement
3. Set the Temperature ON/OFF “at” field as follows.
THERMOCOUPLE: Uses thermocouple for temperature measurement (factory default setting)
HUMIDITY SENSOR: Uses humidity sensor for temperature measurement
4. Set the Humidity field as follows.
ON: Enables humidity measurement (factory default setting)
OFF: Disables humidity measurement

Measurement Considerations

This section describes some considerations for performing accurate and reliable measurements.

- "Insulating Material"
- "Leakage Current on Connection Parts"
- "Humidity and Temperature"
- "Offset"
- "Cable Noise"
- "External Noise"
- "Dielectric Absorption"
- "Capacitive Coupling"
- "Light"

Insulating Material

The need to use high-resistance insulation materials in connection parts, such as cables, adapters, and others, is essential to ensure the reliability of ultra-low current measurements. Poor insulation will allow greater leakage current.

Leakage Current on Connection Parts

Contaminants such as moisture or ionic chemicals can cause electrochemical effects that degrade insulation resistance. In some cases, ionic chemicals create a battery effect that sources offset current. This effect is not stable and will be a major obstacle to obtaining reliable low-current measurements. It is important to keep the surface of insulation material clean.

Humidity and Temperature

Water and water vapor can easily cause electrochemical effects. It is effective to maintain constant low humidity in the measurement environment in order to prevent the occurrence of an electrochemical effect. Temperature changes can create

contaminating condensation that, in turn, can lead to a serious degradation in the insulation performance. You must control the temperature and humidity in the measurement environment appropriately.

Offset

The ideal measurement instrument shows no current flow when nothing is connected to the measurement terminals and no voltage is being applied. However, in a real-world measurement environment, an instrument will have a certain amount of offset current. The offset current can be reduced by using the offset cancel function and so on.

Cable Noise

Cable noise can be caused in two ways: by the triboelectric effect and by the piezoelectric effect. The triboelectric effect is the result of friction caused by motion at the boundary between the conductor and the insulator. The piezoelectric effect is the result of mechanical stress applied to the insulator. Current from both of these effects can negatively influence low current measurements.

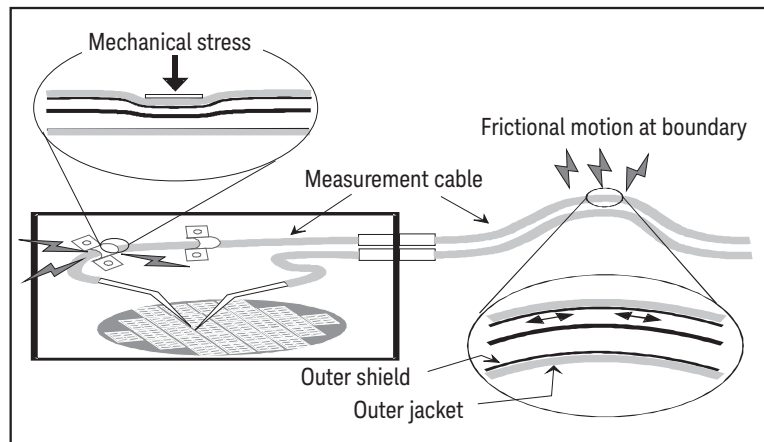

Generally, using the low noise coaxial cable can reduce the noise caused by vibration. Also fixing the cable is effective for preventing it from vibration. Note that applying too much stress to the cable or bending it tightly will have a detrimental effect on the measurements.

External Noise

Power line noise is one of the major sources that can negatively affect low current measurements. Usually, noise current comes from capacitor. Even if it has low capacitance, it causes large noise. So, it is desirable to eradicate the capacitive coupling. Shielding can be a countermeasure for the external noise.

Dielectric Absorption

Change of electric field applied to an insulation material causes the leakage current which needs long convergence time. This is the phenomenon called as the dielectric absorption. The level of current and the length of convergence time depend on the type of insulation material and the amount of electric field change. This undesirable phenomenon can be alleviated by selecting the insulation material of low dielectric absorption and by using the guard technique effective for reducing the electric field change. Current compensation is difficult because the current level changes along with the passage of time. So it is important to wait enough time until the current converges.

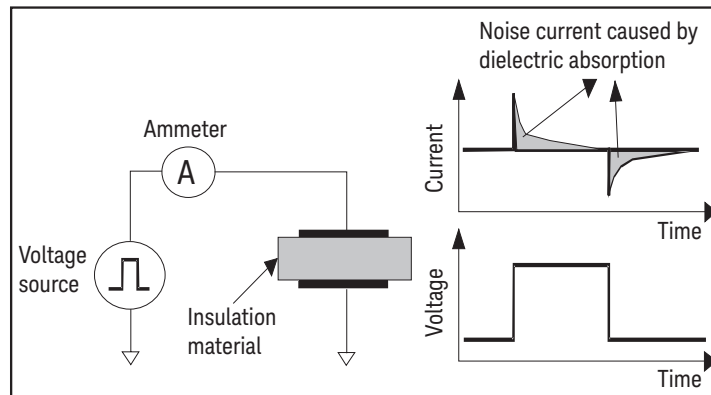

Capacitive Coupling

Capacitive coupling between the different potential will cause the noise current when the applied voltage is changed or when the capacitance is changed.

$$I = C \frac{dV}{dt} + V \frac{dC}{dt}$$

It is important to apply shielding for eliminating the capacitive couple with voltage fluctuation and to prevent vibration for blocking the change of the coupling capacitance.

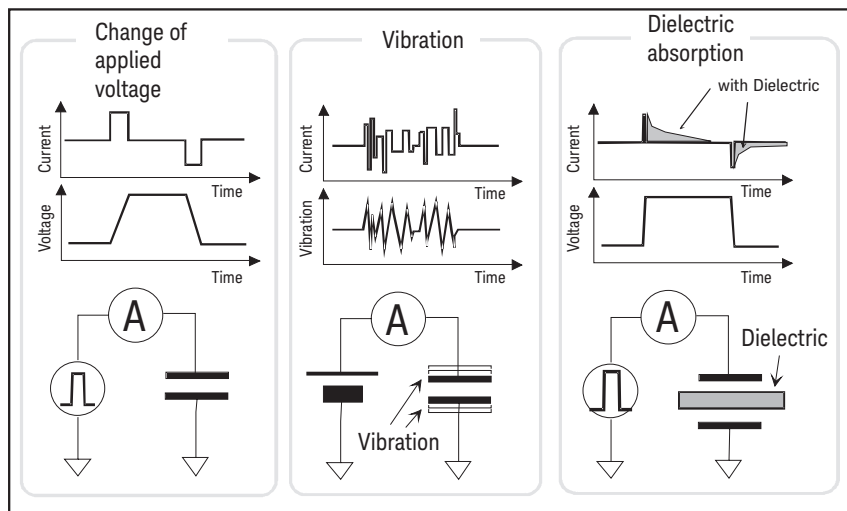

Light

In some devices such as diode and transistor, electron-hole pairs generated by light can create currents which negatively impact low current measurements. Current caused by light is unstable and slow to change. It is important to apply shielding for cutting off the light and to prevent reflection inside the shielding.

How to Perform Measurement
Measurement Considerations

This chapter provides reference information of Keysight B2980 front panel keys and display and covers the following topics:

- "Hard Keys and Rotary Knob"
- "Display and Assist/Function Keys"
- "System Menu"
- "Config key group"
- "Function key group"
- "Trigger key group"
- "Result key group"
- "File key group"
- "Program key group"
- "I/O key group"
- "Display key group"
- "System key group"



Hard Keys and Rotary Knob

Standby switch Turns the instrument on or off. During the power is on, the LED below the switch turns green. For the B2983A/B2987A, the LED turns orange during the switch is off and the battery charging is in progress.

Single Starts a single (one shot) measurement or initiates trigger system. Also triggers the staircase sweep output or square waveform output of B2985A/B2987A. If a repeat measurement is in progress, it stops it and starts a single measurement. The measurement result is displayed on the Meter view, Graph view, Histogram view, or Roll view.

Once a single measurement starts, the data buffer is cleared and stores the last single measurement result (maximum 100000 data). It can be listed and displayed on the Measure Result dialog box.

NOTE If measurement is not performed properly, check the trigger setting. The trigger type must be set to AUTO, or the trigger count (Count) must be set properly. See "[Trigger Setup Sub-panel](#)" on page 4-28.

Run/Stop Starts a repeat (continuous) measurement. If a repeat measurement is in progress, this stops it. The measurement result is displayed on the Meter view, Histogram view, or Roll view.

Once a repeat measurement starts, the data buffer is cleared and stores the last repeat measurement result (maximum 1000 data). It can be listed and displayed on the Measure Result dialog box.

The repeat measurement is performed with the following trigger setup. Settings of "[Trigger Setup Sub-panel](#)" are ignored.

- Acquire trigger (measurement trigger): Initiate
- ARM acquire count: Infinite
- ARM acquire source: AUTO (automatic internal)
- TRIGger acquire count (Measure Count): 100
- TRIGger acquire source (Measure Trigger): AUTO (automatic internal)
- TRIGger acquire timer period (Measure Period): 10 ms (this is automatically extended if the measurement is not completed.)

- Trigger delay (Source Delay=Measure Delay): 0 s
- Trigger output: Disable

Function Keys

Six function keys are placed below the LCD. They are assigned to the softkeys, SPEED, RANGE, Zoom, Clear, Apps, System Menu, and so on. The softkey assignment depends on the view mode (Meter, Graph, Histogram, or Roll).

Assist Keys

Five assist keys are placed right to the LCD. They are assigned to softkeys which assist you in changing the measurement setup. The softkey assignment depends on the view mode and the setup field in the EDIT (green) status.

View

Switches the softkey assignment for the function keys as follows.

- Softkeys available for the present view mode
- Softkeys for selecting the view mode

The following softkeys are available. Press one for selecting the view mode.

Meter View Displays the Meter view.

Graph View Displays the Graph view.

Histogram View Displays the Histogram view.

Roll View Displays the Roll view.

Cancel / Local

Cancels the setup operation if the instrument is in the local status. Returns the instrument to the local status if it is in the remote status.

Measurement navigation keys

Changes the measurement speed (SPEED) and measurement range (RANGE) settings. The following keys are available.

Coarse Res Increases measurement speed (decreases the aperture time). The setting value is displayed on the SPEED function key.
In the auto aperture mode, changes the aperture time in “Stable → Normal → Quick” order.
In the manual aperture mode, changes the aperture time in “100.0 PLC → 10.0 PLC → 1.0 PLC → 0.1 PLC → 0.01 PLC → 0.001 PLC” order.
You can switch the auto/manual aperture mode using the SPEED function key on the Meter view. See ["Meter View" on page 4-12](#).

Range +	<p>Changes the measurement range up, and switches the measurement range mode to FIXED. The setting value is displayed on the RANGE function key.</p> <p>You can switch the AUTO/FIXED range mode using the RANGE function key on the Meter view. See "Meter View" on page 4-12.</p> <p>It is applied to the current measurement on the B2981A/B2983A. It is applied to the latest selected measurement mode (AMPS(I), COUL(Q), VOLTS(V), or OHMS(R)) on the B2985A/B2987A.</p>
[home]	<p>Sets the measurement speed (SPEED) to Normal, and the measurement range (RANGE) to AUTO.</p> <p>It is applied to the all measurement modes (AMPS(I), COUL(Q), VOLTS(V), and OHMS(R)).</p>
Range -	<p>Changes the measurement range down, and switches the measurement range mode to FIXED. The setting value is displayed on the RANGE function key.</p> <p>You can switch the AUTO/FIXED range mode using the RANGE function key on the Meter view. See "Meter View" on page 4-12.</p> <p>It is applied to the current measurement on the B2981A/B2983A. It is applied to the latest selected measurement mode (AMPS(I), COUL(Q), VOLTS(V), or OHMS(R)) on the B2985A/B2987A.</p>
Fine Res	<p>Decreases measurement speed (increases the aperture time). The setting value is displayed on the SPEED function key.</p> <p>In the auto aperture mode, changes the aperture time in “Quick → Normal → Stable” order.</p> <p>In the manual aperture mode, changes the aperture time in “0.001 PLC → 0.01 PLC → 0.1 PLC → 1.0 PLC → 10.0 PLC → 100.0 PLC” order.</p> <p>You can switch the auto/manual aperture mode using the SPEED function key on the Meter view. See "Meter View" on page 4-12.</p>

The Coarse Res, Fine Res, Range +, and Range - keys can be also used for editing the parameter values in the fields. See "[Key Functions for Changing the Settings](#)" on [page 4-9](#).

- Ammeter On/Off** Enables or disables Ammeter Input. In the On status, the Ammeter triaxial connector's center conductor is connected to the ammeter and the switch light turns green. In the Off status, it is connected to the circuit common and the switch light turns off. Pressing the On (green) switch turns it to the Off status even if the instrument is in the remote control state.
- Turn this switch on to perform the current measurement (and the charge and resistance measurements on the B2985A/B2987A).
- The B2985A/B2987A can perform the voltage measurement regardless of this switch setting.
- Voltage Source On/Off (B2985A/B2987A)** Enables or disables Voltage Source Output. In the On status, the Voltage Source High terminal is connected to the voltage source and the switch light turns green. In the Off status, it is opened and the switch light turns off. Pressing the On (green) switch turns it to the Off status even if the instrument is in the remote control state.
- The switch turns red if the voltage source is in the high voltage state (over $\pm 21\text{V}$).
- Rotary knob** If the field pointer is in the MOVE (blue) status, turning the knob moves the pointer. Pressing the knob fixes the pointer position and changes the pointer status to EDIT (green).
- If the field pointer is in the EDIT (green) status, turning the knob changes the value of the setup parameter specified by the pointer. Pressing the knob fixes the value and changes the pointer status to MOVE (blue).
- For the details, see ["Key Functions for Changing the Settings" on page 4-9](#).
- Null** Enables or disables the null (offset cancel) function. See ["Null, Offset Cancel" on page 5-9](#) for more information.
- Filter** If the FILT indicator is turned off, pressing the Filter key opens the Measure Filter dialog box. Pressing OK after setting up the dialog box enables the filter function and turns the FILT indicator on.
- If the FILT indicator is turned on, pressing the Filter key disables the function and turns the FILT indicator off.
- For the Measure Filter dialog box, see ["Measure Filter dialog box" on page 4-46](#).
- Math** If the MATH indicator is turned off, pressing the Math key opens the Math Expression dialog box. Pressing OK after setting up the dialog box enables the math function and turns the MATH indicator on.

Front Panel Reference
Hard Keys and Rotary Knob

If the MATH indicator is turned on, pressing the Math key disables the function and turns the MATH indicator off.

For the Math Expression dialog box, see ["Math Expression dialog box" on page 4-48](#).

**Save/Recall
(Left and right
arrow keys)**

Saves/recalls all setup information of the instrument. Five storage areas are available in the built-in non-volatile memory (NVRAM) for this purpose.

Press the Save or Recall key to display five function keys used for selecting the storage area. Press a function key to save or recall the setup information.

The label <Empty> is set to the key for the unused storage area and the label HH:MM:SS (time) is set to the key for the used area. They are displayed on the key with a destination number (#1 to #5).

NOTE

Save and Recall keys as arrow keys

The Save key is also assigned to the left arrow key. The Recall key is also assigned to the right arrow key. For the details, see ["Key Functions for Changing the Settings" on page 4-9](#).

Key Functions for Changing the Settings

When you change the parameter values on the fields, various keys perform the following functions.

Table 4-1 Key Functions for Changing the Settings

Key Operation	Function	
	In the MOVE Status	In the EDIT status
Turning the rotary knob	Moves the field pointer.	Changes the setting value.
Pressing the rotary knob	Fixes the field to be edited, and changes into the EDIT status.	Fixes the setting value, and changes into the MOVE status.
Pressing the Range + or Range - key	—	<ul style="list-style-type: none"> Changes the setting value. Moves the pointer and selects a character on the helper panel.
Pressing the Coarse Res, Fine Res, Save or Recall key	—	<ul style="list-style-type: none"> Changes to the digit pointer. Moves the digit pointer.
Pressing the Cancel/Local key	—	Cancels the change of the setting before fixing the setting value.

If the assist keys show units for the setting value, press one of them to fix the setting value with the used unit.

If the assist keys show the alternatives for the field setting, press one of them to select and fix the setting.

Changing the Field Setting Using the Field Pointer

1. Turn the rotary knob to move the field pointer to the field to be edited.
2. Press the rotary knob to fix the field to be edited. The field pointer goes in the EDIT status.
3. Turn the rotary knob, or press the Range + or Range - key to change the setting value.
4. Press the rotary knob, or press an assist key to fix the setting value. The field pointer goes in the MOVE status.

If the Voltage Source field is in the EDIT status, turning the rotary knob changes the display value and updates the voltage source output in real time. However, if the digit pointer is available, the voltage source works depending on the setting of real time update. For the real time update, see *Immediate Voltage Update by Knob* in "[Display Preference dialog box](#)" on page 4-68.

Changing the Field Setting Using the Digit Pointer

1. Turn the rotary knob to move the field pointer to the alpha/numeric value entry field to be edited.
2. Press the rotary knob to fix the field to be edited. The field pointer goes in the EDIT status.
3. Press the Coarse Res, Fine Res, Save or Recall key to change the field pointer to the digit pointer.
4. Press the Coarse Res, Fine Res, Save or Recall key to move the digit pointer to a character or digit to be edited.
5. Turn the rotary knob, or press the Range + or Range - key to change the value of the character or digit.

Note that changing the value from 9 to 0 or from 0 to 9 changes the value of the next digit.

6. Press the rotary knob, or press an assist key to fix the setting value. The field pointer goes in the MOVE status.

If the digit pointer is on the decimal point of a numeric value entry field, turning the knob or pressing the Range +/Range - key moves the decimal point if the real time update is OFF. For the real time update, see *Immediate Voltage Update by Knob* in "[Display Preference dialog box](#)" on page 4-68.

For the editing operation of the alphanumeric characters using the helper panel, see "[Helper Panel](#)" on page 4-40.

Display and Assist/Function Keys

Keysight B2980 provides several display modes. The display mode is changed by pressing the View key.

For each display mode, six function keys are available below the display, and five assist keys are available on the right side of the display. They are assigned to several softkeys. The softkey assignment depends on the display mode.

For details of each display mode, assist keys and function keys, see the following sections.

- "Meter View"
- "Graph View"
- "Histogram View"
- "Roll View"
- "Status Information"

The status information is common for all display modes. It is displayed above the bottom softkeys associated with the function keys. This display area is also used to display system messages and error messages.

- "Helper Panel"

The Helper Panel assists to enter alphanumeric characters. This panel appears automatically when the field pointer is in the EDIT (green) status on the field that is required to enter characters.

Meter View

Displays the measurement results, measurement and source settings, and channel status. Most setup parameters can be edited on this display. The upper half displays measurement result(s), and the lower half displays the setup parameters or condensed graph.

B2981A/B2983A

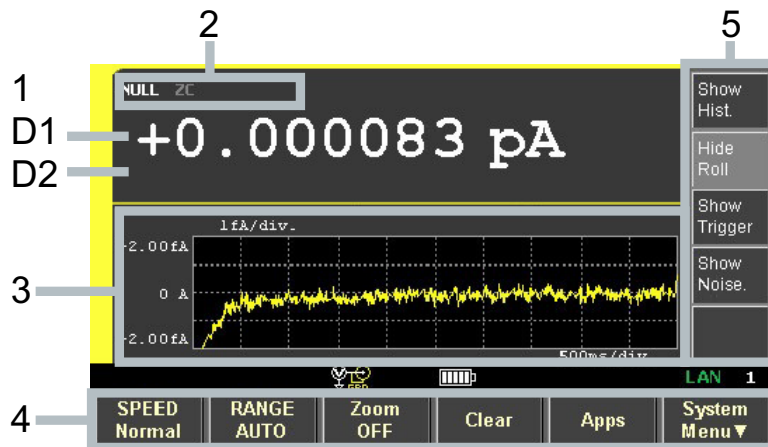

Display area

1. Latest measurement data
 - D1. Measurement data. Turns orange if the data exceeds the Limit value.
 - D2. For the limit test, D2 displays PASS or FAIL.
2. NULL (Offset Cancel), ZC (Zero Correction), FILT (Filter), and MATH (Math) indicators. Examples are shown below.
 - NULL: If the null (offset cancel) function is effective.
 - ZC: If the zero correction function is effective.
 - FILT: If the measurement filter is set.
 - MATH: If the math function is effective.
3. The following sub-panel or condensed graph can be displayed. You can switch them using *Show/Hide XXXX* assist keys.
 - Range setup sub-panel
 - Trigger setup sub-panel

- Condensed histogram

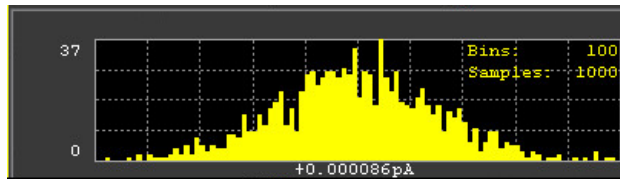

- Condensed roll graph (time-domain graph, standard display)

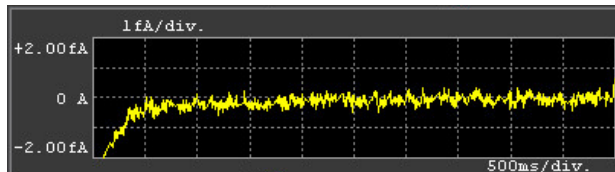

- Real-time noise monitor

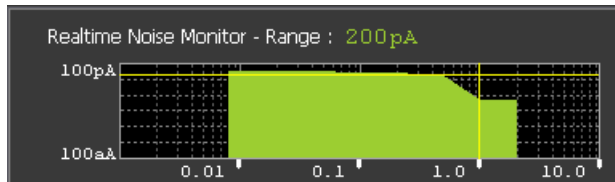

4. Function keys

See ["Function Keys"](#) on page 4-16.

5. Assist keys

See ["Assist Keys"](#) on page 4-20. On the B2981A/B2983A, Assist keys 1 and 3 described in ["Assist Keys"](#) are not displayed.

B2985A/B2987A

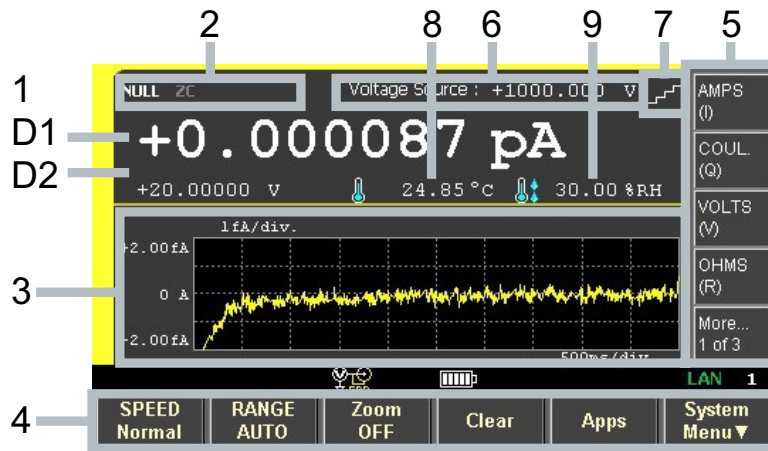

Display area

1. Latest measurement data
 - D1. Primary measurement data. Turns orange if the data exceeds the Limit value.
 - D2. Secondary measurement data. Turns orange if the data exceeds the Limit value.
- For the limit test, D2 displays PASS or FAIL instead of the measurement data.

NOTE

Charge measurement (B2985A/B2987A)

B2985A/B2987A can perform the charge and voltage measurements at the same time, but cannot perform the charge and current or resistance measurements at the same time.

2. NULL (Offset Cancel), ZC (Zero Correction), FILT (Filter), MATH (Math), and OC (Over Current) indicators. Examples are shown below.
 - NULL: If the null (offset cancel) function is effective.
 - ZC: If the zero correction function is effective.
 - FILT: If the measurement filter is set.
 - MATH: If the math function is effective.
 - OC: If over current is detected in the voltage source.
3. The following sub-panel or condensed graph can be displayed.
You can switch them using *Show/Hide XXXX* assist keys.

- Range setup sub-panel
- Source function sub-panel
- Trigger setup sub-panel
- Condensed histogram

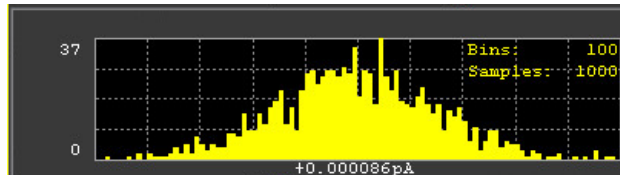

- Condensed roll graph (time-domain graph, standard display)

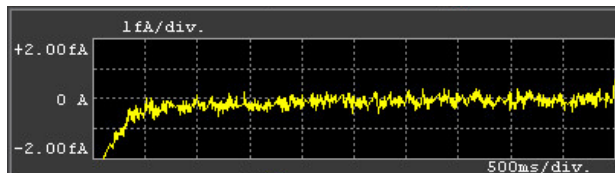

- Real-time noise monitor

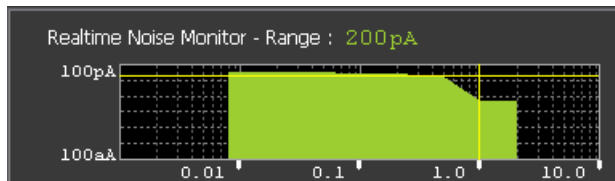

4. Function keys
See "Function Keys" on page 4-16.
5. Assist keys
See "Assist Keys" on page 4-20.
6. Voltage Source: Output voltage of the voltage source
7. Source shape indicator. DC, staircase sweep, list sweep, or square wave. DC does not show the indicator.
8. Temperature measurement data if the thermocouple or humidity sensor is connected. You can change the temperature unit to °C (Celsius), °F (Fahrenheit), or K (Kelvin).
9. Humidity measurement data if the humidity sensor is connected.

Function Keys

SPEED	<p>Sets the setting mode (aperture mode) of the measurement speed to auto or manual. The softkey displays the present setting. If the aperture mode is set to auto, the softkey displays Stable, Normal, or Quick. If the aperture mode is set to manual, the softkey displays 100.0 PLC, 10.0 PLC, 1.0 PLC, 0.1 PLC, 0.01 PLC, or 0.001 PLC. PLC is the number of power line cycles per measurement, and specifies the aperture time. For example, if 1.0 PLC is set, the aperture time is set to 20 ms at 50 Hz power line, or 16.667 ms at 60 Hz power line. Use the measurement navigation keys (Coarse Res and Fine Res) to change the aperture time. For the aperture mode and time, see "Measurement Time" on page 5-5.</p>								
RANGE	<p>Sets the measurement range mode to AUTO or FIXED. If it is set to AUTO, the softkey displays AUTO. If it is set to FIXED, the softkey displays the present range value. It is applied to the current measurement on the B2981A/B2983A. It is applied to the latest selected measurement mode (AMPS(I), COUL(Q), VOLTS(V), or OHMS(R)) on the B2985A/B2987A.</p>								
Zoom	<p>Zooms in/out the Meter view. The softkey displays the present zoom status (ON or OFF).</p>								
Clear	<p>Clears the data buffer. The graph display is also cleared.</p>								
Apps	<p>Launches the following applications. Use the assist keys to select an application.</p> <table><tr><td>#1</td><td>Setup integrity checker. See "Setup integrity checker" on page 4-17.</td></tr><tr><td>#2</td><td>Data logger. See "Data logger" on page 4-18.</td></tr><tr><td>#3</td><td>(B2985A/B2987A) Sequential measurement. See "Sequential measurement" on page 4-19.</td></tr><tr><td>#4</td><td>Demo slide show. See "Demo slide show" on page 4-20.</td></tr></table>	#1	Setup integrity checker. See " Setup integrity checker " on page 4-17.	#2	Data logger. See " Data logger " on page 4-18.	#3	(B2985A/B2987A) Sequential measurement. See " Sequential measurement " on page 4-19.	#4	Demo slide show. See " Demo slide show " on page 4-20.
#1	Setup integrity checker. See " Setup integrity checker " on page 4-17.								
#2	Data logger. See " Data logger " on page 4-18.								
#3	(B2985A/B2987A) Sequential measurement. See " Sequential measurement " on page 4-19.								
#4	Demo slide show. See " Demo slide show " on page 4-20.								

#5 About B298nA, where B298nA is the model number. See "[About B298nA](#)" on page 4-20.

System Menu Assigns the system menu items to the softkeys of the function keys. To cancel the assignment, press the Cancel/Local key. For the system menu, see "[System Menu](#)" on page 4-41.

Applications

This section describes the applications started from the Apps #1 to #5 assist keys described above.

Setup integrity checker

This checks the electric noise in the present measurement environment. For details of this function, see "[Setup Integrity Checker](#)" on page 5-45. The "SIC" (Setup Integrity Checker) license is required to enable this checking function.

If the #1 assist key is pressed, a confirmation dialog box is opened. Press OK to open the Setup Integrity Checker panel, and display the following assist keys and function key.

Assist Keys

Check Starts the noise checking and changes the softkey label to *Abort*.

Abort Aborts the noise checking and changes the softkey label to *Check*.

Export Saves the noise checking result file into the root folder on a USB memory connected to the front panel USB-A connector, with a predetermined file name:

`MECMMDDhhmmss.csv`

Where, *MM* means a month, *DD* means a day, *hh* means a hour, *mm* means a minute, and *ss* means a second.

Function Key

Close Closes the Setup Integrity Checker panel.

The Setup Integrity Checker panel shows the following information in the tabular form.

Date Date and time when the noise check was performed

Range Current measurement range

NPLC PLC value (aperture time)

Ref.	Reference noise level, variation in current when the input switch of the ammeter is Off.
Target	Target noise level, variation in current when the input switch of the ammeter is On.
Ratio	Variance ratio of Target to Ref.

Data logger

This performs a simple sampling measurement with the specified number of the samples and sampling period, and then stores the measurement result into the data buffer.

If the #2 assist key is pressed, the Data Logger dialog box is opened. Set up the following parameters in this dialog box, and then press OK (function key).

Samples Number of samples. You can set a value by using the navigation keys and rotary knob.

Period Sampling period. You can set a value by using the navigation keys and rotary knob.

Press OK to start the sampling measurement. The measurement result is displayed on the Meter view, Histogram view, or Roll view.

Once a sampling measurement starts, the data buffer is cleared and stores the measurement result. It can be listed and displayed on the Measure Result dialog box.

The sampling measurement is performed with the following trace buffer and trigger setups. Settings in the Trace Buffer Setup dialog box and Trigger Setup sub-panel are ignored.

Trace Buffer Setup

- Feed Data: SENSE
- Buffer Control: NEXT
- Buffer Size: A value specified in the *Samples* field

Trigger Setup

- Acquire trigger (measurement trigger): Initiate
- ARM acquire count: 1
- ARM acquire source: AUTO (automatic internal)
- TRIGger acquire count (Measure Count): A value specified in the *Samples* field
- TRIGger acquire source (Measure Trigger): AUTO (automatic internal)

- TRIGger acquire timer period (Measure Period): A value specified in the *Period* field
- Trigger delay (Source Delay=Measure Delay): 0 s
- Trigger output: Disable

To stop a sampling measurement, press the Run/Stop key.

NOTE

High speed measurement such as sampling period 1 ms will drastically slow to draw on the screen.

Sequential measurement

(B2985A/B2987A) The sequential measurement can perform a sequence as shown in [Figure 4-1](#).

Figure 4-1

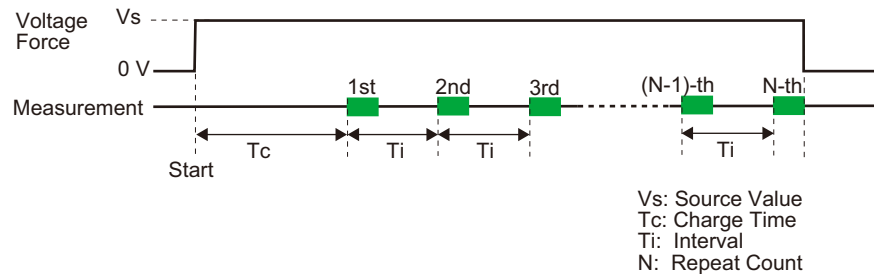
Sequential Measurement

1. Clears the trace buffer.
2. Turns the input/output switches on and then applies the defined **Source Value** voltage.
3. Waits for the defined **Charge Time** while the applied voltage is charging the DUT.
4. After that, repeats measuring the DUT as many times as is defined by the **Repeat Count** with a defined **Interval** time between measurements. The measurement data is displayed on the front display after each measurement, and all measurement data is stored in the trace buffer.
5. After all measurements are completed, turns the applied voltage off (0 V) and turns the input/output switches off.

The sequential measurement is appropriate for measuring time-related characteristics, and can perform a repeating measurement with simple setting. It is useful for volume and sheet resistivity measurements.

WARNING

To prevent electrical shock, discharge the DUT sufficiently before you touch the DUT after measurement.

It is useful to set the output-off state to ZERO for discharging before and after the measurement.

To perform the sequential measurement, do the steps below.

1. Complete the following measurement setup.
 - Measurement type (current/charge/voltage/resistance)
 - Measurement speed (aperture mode and time)
 - Measurement range: FIXED
 - Limit test, if necessary
 - Handler control, if necessary
2. Press the Apps function key on the Meter view, then press the #3 assist key. The Sequential Measurement dialog box opens.
3. Set the following parameters in this dialog box.

Source Value	Forcing voltage.
Charge Time	Wait time after starting the voltage forcing until performing the 1st measurement.
Interval	Interval between measurements.
Repeat Count	Repeat count of measurements.

4. Press OK (function key) to start the sequential measurement.

Demo slide show Starts the slide show to introduce this instrument. To start it, press OK function key. To terminate it, press any front panel key.

About B298nA Displays the Revision dialog box which displays the model number, serial number, firmware revision, CPU FPGA revision, module revision, installed licenses, system uptime, and battery cycle count (B2983A/B2987A) of the B2980.

Assist Keys

Assist keys 1

AMPS (I)	(B2985A/B2987A) Sets the current measurement.
COUL. (Q)	(B2985A/B2987A) Sets the charge measurement.

VOLTS (V)	(B2985A/B2987A) Sets the voltage measurement.
OHMS (R)	(B2985A/B2987A) Sets the resistance measurement. Resistance data is given by $\text{Resistance} = \text{Vmeas} / \text{I meas}$ or $\text{Vout} / \text{I meas}$. Where Vmeas is the voltage measurement data, I meas is the current measurement data and Vout is the output voltage of the voltage source. Select the voltage data (Vmeas or Vout) by using the System Menu > Config > Measure > Ohms > V Select function keys. See " Config key group " on page 4-42.
More...	(B2985A/B2987A) Changes the assist keys to Assist keys 2.

NOTE

Valid assist keys in Zoom ON (B2985A/B2987A)

During the Meter view is zoomed in, you cannot use More... key and Assist keys 2 and 3.

Assist keys 2

Show Hist.	Displays the condensed histogram and changes the softkey label to <i>Hide Hist.</i> .
Hide Hist.	Displays the range setup sub-panel shown in " Range Setup Sub-panel " on page 4-23, and changes the softkey label to <i>Show Hist.</i> .
Show Roll	Displays the condensed roll graph and changes the softkey label to <i>Hide Roll.</i>
Hide Roll	Displays the range setup sub-panel and changes the softkey label to <i>Show Roll.</i>
Show Trigger	Displays the trigger setup sub-panel shown in " Trigger Setup Sub-panel " on page 4-28, and changes the softkey label to <i>Hide Trigger.</i>
Hide Trigger	Displays the range setup sub-panel and changes the softkey label to <i>Show Trigger.</i>
Show Noise.	Displays the real-time noise monitor and changes the softkey label to <i>Hide Noise.</i> . For details of the real-time noise monitor, see " Real-time Noise Monitor " on page 5-43.
Hide Noise.	Displays the range setup sub-panel shown in " Range Setup Sub-panel " on page 4-23, and changes the softkey label to <i>Show Noise.</i> .
More...	(B2985A/B2987A) Changes the assist keys to Assist keys 3.

Assist keys 3

Source (B2985A/B2987A) Displays the field pointer on the Voltage Source field, with the EDIT (green) status.
To change the output voltage value, turn the rotary knob.
To settle the value, press the rotary knob or the unit (V or mV) assist key.

Show Preview (B2985A/B2987A) Displays the preview graph of the voltage source output instead of the measurement value(s) on the upper half display, and changes the softkey label to *Hide Preview*.

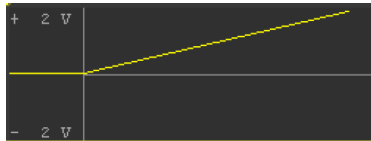

Hide Preview (B2985A/B2987A) Cancels the preview graph, displays the measurement value(s), and changes the softkey label to *Show Preview*.

Show VS Func. (B2985A/B2987A) Displays the source function sub-panel shown in "[Source Function Sub-panel \(B2985A/B2987A\)](#)" on [page 4-25](#), and changes the softkey label to *Hide VS Func.*

Hide VS Func. (B2985A/B2987A) Displays the range setup sub-panel and changes the softkey label to *Show VS Func.*

More... (B2985A/B2987A) Changes the assist keys to Assist keys 1.

Softkey labels *Show XXXX* and *Hide XXXX* are switched by pressing the key.

Range Setup Sub-panel

B2981A/B2983A

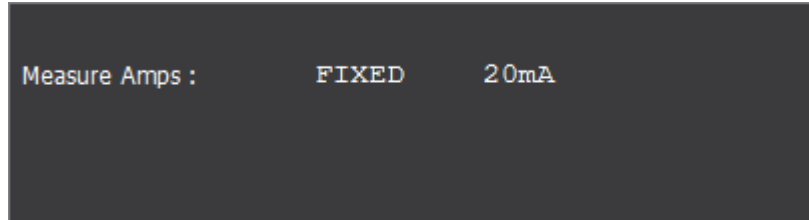

B2985A/B2987A

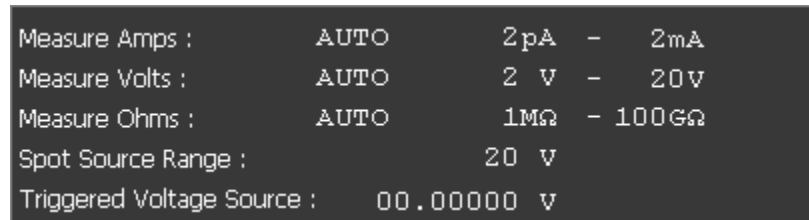

The following setup parameters are available. Use the rotary knob and assist keys to set these fields.

Measure Amps Sets up the current measurement range.
In the left field, select the range mode AUTO or FIXED.
In the right field, set the minimum and maximum range values for the AUTO mode operation, or the range value for the FIXED mode.

Measure Coulomb (B2985A/B2987A) Sets up the charge measurement range.
In the left field, select the range mode AUTO or FIXED.
In the right field, set HIGH or LOW for the AUTO mode operation.

HIGH
(200nC-2μC) Uses the proper range from 200 nC range to 2 μC range automatically.

LOW (2nC-20nC) Uses the proper range from 2 nC range to 20 nC range automatically.

For the FIXED mode, set the range value in the right field.

Measure Volts (B2985A/B2987A) Sets up the voltage measurement range.

Front Panel Reference
Display and Assist/Function Keys

In the left field, select the range mode AUTO or FIXED.

In the right field, set the minimum and maximum range values for the AUTO mode operation, or the range value for the FIXED mode.

Measure Ohms

(B2985A/B2987A) Sets up the resistance measurement range.

In the left field, select the range mode AUTO or FIXED.

In the right field, set the minimum and maximum range values for the AUTO mode operation, or the range value for the FIXED mode.

Spot Source Range

(B2985A/B2987A) Sets the voltage output range to 20 V, +1000 V, or -1000 V.

Triggered Voltage Source

(B2985A/B2987A) Specifies a constant voltage output value by a trigger input. The voltage source changes the output to the specified value by receiving a trigger signal. This is available in the status VS Function OFF and Voltage Source On.

Source Function Sub-panel (B2985A/B2987A)

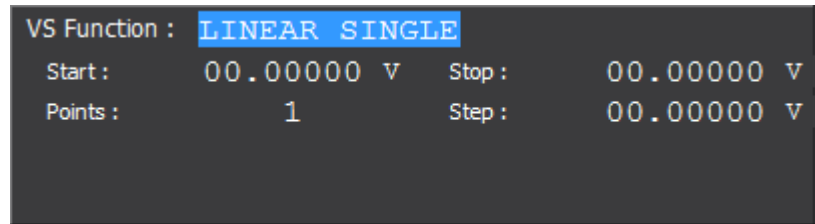

Use this sub-panel to set up the voltage source in the B2985A/B2987A as a sweep source or a square waveform generator.

To select the source function, use the assist keys displayed when the field pointer is in the EDIT (green) status on the VS Function field.

- LINEAR SINGLE: Sweep from start to stop in a linear incremental step
- LINEAR DOUBLE: Sweep from start to stop to start in a linear incremental step
- LIST: Sweep of values defined in the List sweep setup list. See "[List sweep setup](#)".
- ARB SQUARE: Square waveform output
- OFF: The voltage source works as the DC constant voltage source.

The following setup parameters are available for LINEAR SINGLE, LINEAR DOUBLE, or LIST.

Start	Sets the sweep start value.
Stop	Sets the sweep stop value.
Points	Sets the number of sweep steps.
Step	Sets the sweep step value (incremental step value). Not available for the LIST sweep operation.

The following setup parameters are available for ARB SQUARE.

Start	Sets the base voltage of square waveform.
Peak	Sets the peak voltage of square waveform.
Delay	Sets a period of base output before peak.
Peak Time	Sets a period of peak output.
End Time	Sets a period of base output after peak.
Count	Number of waveforms to be generated in one device action.

Use the rotary knob and assist keys to set the parameters. When the field pointer is in the EDIT (green) status on an entry field, the assist keys are changed to the unit keys as shown below.

mV and V for voltage value setting

μs, ms, s and ks for time value setting

For the range mode of the sweep source, see "[Sweep dialog box](#)" on page 4-45. If the range mode for the sweep source is set to BEST, the *Spot Source Range* parameter setting in the range setup sub-panel is not effective. It is effective for the constant source and FIXED range mode of the sweep source.

List sweep setup

When the field pointer is in the EDIT (green) status on the LIST sweep Start/Stop/Points field, the following assist keys are available for setting the list sweep source.

- | | |
|-------------|--|
| Edit | Opens the List Sweep dialog box used to set the list sweep source. |
| Load | Opens the Load List Sweep Data dialog box used to load a list sweep data from a USB memory connected to the front panel USB-A connector. |

- List Sweep dialog box

This dialog box provides the following fields for setting the list sweep source. After the list is completed, press OK to apply the data and close the dialog box.

- | | |
|---------------------|--|
| (data graph) | Displays the shape of the list sweep output |
| (data list) | Lists the data index in the left cell and the output value in the right cell.
When the pointer is in the MOVE status, turning the rotary knob moves the pointer onto the left or right cell. And pressing the knob changes the status to EDIT.
When the right cell is in the EDIT status, the output value can be entered by using the rotary knob.
When the left cell is in the EDIT status, the following assist keys are available for creating and scrolling the list.
Then turning the rotary knob scrolls the list and pressing the knob changes the status to MOVE. |

Append	Adds a line below. The same output value is entered into the right cell.
---------------	--

Insert	Adds a line above. The same output value is entered into the right cell.
---------------	--

Delete	Deletes the line.
Scroll -100	Moves the pointer to the maximum 100 points above.
Scroll +100	Moves the pointer to the maximum 100 points below.

Points	Number of data points
Max	Maximum value
Min	Minimum value

- Load List Sweep Data dialog box

This dialog box provides the following fields for loading a list sweep data from a file stored on a USB memory. Highlight the file to load by using the line cursor. And press OK to load the data and close the dialog box. The line cursor can be moved by turning the rotary knob.

(data graph)	Displays the shape of the list sweep data selected by the file list
Path	Folder into which the list sweep data file is saved
(file list)	List of the list sweep data file
Points	Number of data points
Max	Maximum value
Min	Minimum value

The following data can be loaded as the list sweep data.

- Comma separated value format, file extension csv
For example,
1.0,1.1,1.2,1.3
- Carriage return or line feed separated value format, file extension txt
For example,
1.0
1.1
1.2
1.3
- Space separated value format in a line, file extension prn
For example,
1.0 1.1 1.2 1.3

Trigger Setup Sub-panel

B2981A/B2983A

Trigger :	MANUAL	Measure	
Count :		1	
Delay :		0.000 s	
Period :		10.00 μ s	
Trigger :		AUTO	

B2985A/B2987A

Trigger :	MANUAL	Measure	Source
Count :		1	1
Delay :		0.000 s	0.000 s
Period :		10.00 μ s	10.00 μ s
Trigger :		AUTO	AUTO

The B2980 supports the following trigger types for triggering measurement on the B2981A/B2983A, and for triggering measurement and voltage source output on the B2985A/B2987A. They are effective for easily setting triggers.

The trigger type can be selected by using the assist keys displayed when the field pointer is in the EDIT (green) status on the Trigger field. See [Table 4-2](#) for the trigger types and the setup parameters.

AUTO	Automatic trigger type
SYNC	Synchronize trigger type
TIMER	Timer trigger type
MANUAL	Manual trigger type

The following setup parameters are available for setting the measurement trigger (acquire action) by using the Measure column, and the source output trigger (transient action) by using the Source column.

Count	Trigger count (number of triggers), 1 to 100000 or INF. (infinity). This value is automatically set for the AUTO trigger type. For the other trigger type, set the number of triggers required for each source output and measurement properly. For example, set Source Count = Measure Count = 10 for the sweep measurement with 10 steps.
Delay	Sets the trigger delay time.

- Period** Sets the trigger period.
- Trigger** Selects the trigger source by using the assist key AUTO, BUS, TIMER, INT m , LAN, EXT n , or TIN, where m is the integer 1 or 2, and n is an integer from between 1 and 7 See [Table 4-2](#) for the trigger sources.

When the field pointer is in the EDIT (green) status on the Delay or Period field, the assist keys are changed to the unit keys as shown below.

μ s, ms, s, and ks

Table 4-2 Trigger Types and Setup Parameters

Type	Count	Delay	Period	Trigger
AUTO	set automatically	0 second	N.A.	AUTO
SYNC	entered value	entered value	N.A.	AUTO
TIMER	entered value	entered value	entered value	TIMER
MANUAL	entered value	entered value	entered value	selected value

Trigger=AUTO automatically selects the trigger source best suited for the present operating mode by using internal algorithms.

Trigger=BUS uses the remote interface trigger command such as GET, TRIGger, and *TRG.

Trigger=TIMER uses a signal internally generated every interval set by the *Period* parameter.

Trigger=INT1 or INT2 uses a signal from the internal bus 1 or 2, respectively.

Trigger=LAN uses the LXI trigger.

Trigger=EXT n uses a signal from the DIO pin n which is an output port of the Digital I/O D-sub connector on the rear panel. $n=1$ to 7.

Trigger=TIN uses a signal from the Trigger In connector on the rear panel.

NOTE**Setting trigger parameters in detail**

For details of the trigger system, see [Figure 5-10 on page 36](#).

The Meter view provides the trigger types and parameters effective for easily setting triggers. If you want to set the trigger parameters in detail, select the MANUAL trigger type and use the Trigger Configuration dialog box opened by pressing the System Menu > Trigger > Config function keys. See "[Trigger key group](#)" on [page 4-53](#).

The Meter view does not contain the setup parameters for the arm layer, but contains the setup parameters for the trigger layer. The Meter view setup is given priority over the trigger layer setup on the Trigger Configuration dialog box. Hence, the overlapped parameter values on the dialog box are ignored.

Graph View

Displays the graph for plotting the measurement or math result. The Graph view can plot up to 5000 data.

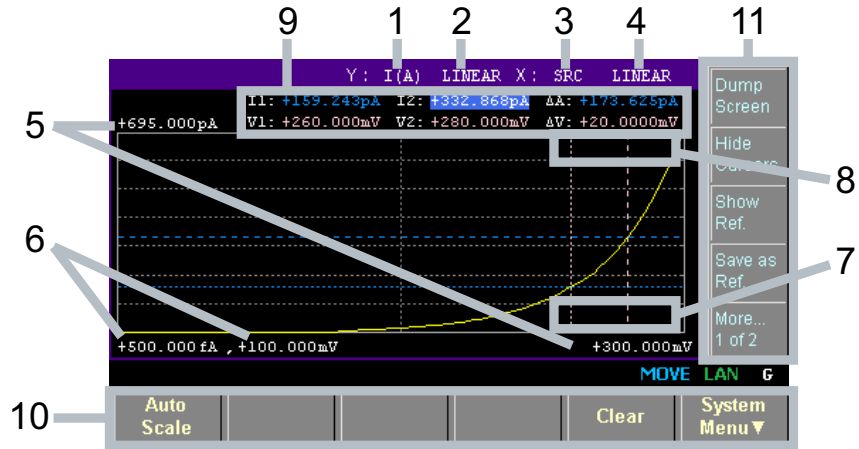

Display area

1. Y-axis data type: I (A), Q (C), V (V), R (Ω), or MATH (see [Table 4-3](#)). Select one using the assist keys.
B2981A/B2983A: I (A) or MATH
B2985A/B2987A: I (A), Q (C), V (V), R (Ω), or MATH
2. Y-axis scale: LINEAR or LOG. Select one using the assist keys.
3. X-axis data type: I (A), Q (C), V (V), R (Ω), MATH, SRC or t (s) (see [Table 4-3](#)). Select one using the assist keys.
B2981A/B2983A: I (A), MATH, or t (s)
B2985A/B2987A: I (A), Q (C), V (V), R (Ω), MATH, SRC, or t (s)
4. X-axis scale: LINEAR or LOG. Select one using the assist keys.
5. Graph maximum value
6. Graph minimum value

7. (B2985A/B2987A) Output voltage value of the voltage source (controlled by the *Show Source* or *Hide Source* assist key). If the Voltage Source On/Off switch is turned on, the output value is displayed in yellow. You can change the output voltage using this field.
8. Y-axis data at the active X-cursor position. ----.---- is displayed for the *no-data* position.
9. Cursor data (controlled by the *Show Cursors* or *Hide Cursors* assist key)
 - First line** Positions and distance (e.g. I1, I2, ΔA) of Y-cursors 1 and 2
 - Second line** Positions and distance (e.g. t1, t2, Δt) of X-cursors 1 and 2
10. Function keys
11. Assist keys

Table 4-3 X and Y Axes Data Types for Graph View

Data type	Assist key	Description
I (A)	AMPS (I)	Current data
Q (C)	COUL. (Q)	Charge data (B2985A/B2987A)
V (V)	VOLTS (V)	Voltage data (B2985A/B2987A)
R (Ω)	OHMS (R)	Resistance data (B2985A/B2987A)
MATH	MATH	Math result data
SRC	SRC	Voltage source output data. Only for the X-axis data. (B2985A/B2987A)
t (s)	TIME (t)	Time data. Only for the X-axis data.

- | | | |
|----------------------|--------------------|---|
| Function keys | Auto Scale | Changes graph scale to fit the trace in the graph automatically. |
| | Clear | Clears the data buffer. The graph display is also cleared. |
| | System Menu | Assigns the system menu items to the softkeys of the function keys. To cancel the assignment, press the Cancel/Local key. For the system menu, see " System Menu " on page 4-41. |
| Assist keys | Dump Screen | Opens the File Selection (Dump Screen) dialog box which is used to save the screen dump as a JPEG file. |

The file can be saved onto a USB memory connected to the front panel USB-A connector. The file is saved with the specified name. If the file extension is not specified, “.jpg” is added automatically.

Show Cursors	Displays the cursors (Y-cursors 1 and 2, X-cursors 1 and 2, and cursor data) and changes the softkey label to <i>Hide Cursors</i> .
Hide Cursors	Hides the cursors and changes the softkey label to <i>Show Cursors</i> .
Show Ref.	Displays the reference line using the saved measurement data as the reference line data, and changes the softkey label to <i>Hide Ref.</i>
Hide Ref.	Hides the reference line, changes the softkey label to <i>Show Ref.</i>
Save as Ref.	Saves the presently-displayed data as the reference line data temporarily.
Show Source	Displays the output voltage value of the voltage source and changes the softkey label to <i>Hide Source</i> .
Hide Source	Hides the output value of the voltage source and changes the softkey label to <i>Show Source</i> .

NOTE**If the number of data exceeds 5000**

If the number of measurement data exceeds 5000, the Graph view and the Roll view plot the following data. Where, n is integer, 1 to 5000.

Number of data is 5001 to 10000: $[2*(n-1)+1]$ th data

Number of data is 10001 to 25000: $[5*(n-1)+1]$ th data

Number of data is 25001 to 50000: $[10*(n-1)+1]$ th data

Number of data is 50001 to 100000: $[20*(n-1)+1]$ th data

Histogram View

Displays the histogram to show the number of occurrences of the measurement data corresponding to the defined range (bin). See [Table 4-4](#) for the X-axis data types.

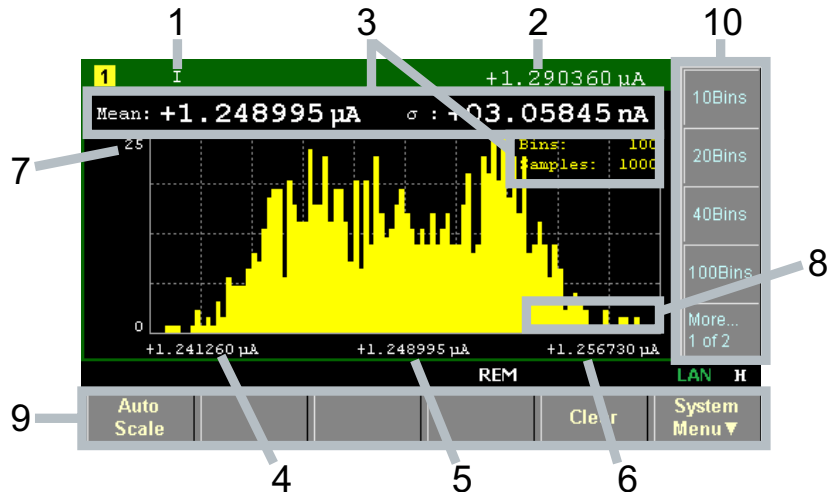

Display area

1. X-axis data type: I, Q, V, or R (see [Table 4-4](#)). Select one using the assist keys.
2. Latest measurement data
3. Statistical data (Mean: mean value, σ : standard deviation, Bins: number of bins, Samples: number of sample data)
4. X-axis value for minimum bin
5. X-axis value for central bin
6. X-axis value for maximum bin
7. Y-axis maximum value. You can set this using the rotary knob.
8. (B2985A/B2987A) Output voltage value of the voltage source (controlled by the *Show Source* or *Hide Source* assist key). If the Voltage Source On/Off switch is turned on, the output value is displayed in yellow. You can change the output voltage using this field.
9. Function keys
10. Assist keys

Table 4-4 X-Axis Data Types for Histogram View

Data type	Assist key	Description
I	AMPS (I)	Current data
Q	COUL. (Q)	Charge data (B2985A/B2987A)
V	VOLTS (V)	Voltage data (B2985A/B2987A)
R	OHMS (Ω)	Resistance data (B2985A/B2987A)

Function keys	Auto Scale	Changes graph scale to automatically fit the trace in the graph.
	Clear	Clears the data buffer. The graph display is also cleared.
	System Menu	Assigns the system menu items to the softkeys of the function keys. To cancel the assignment, press the Cancel/Local key. For the system menu, see " System Menu " on page 4-41.
Assist keys	<i>n</i> Bins	Assigns <i>n</i> bins for the range from the minimum to the maximum measurement values. If the number of bins is changed, the Histogram view reassigns the current result according to the new setting, then displays new result. Where, <i>n</i> is 10, 20, 40, or 100.
	Dump Screen	Opens the File Selection (Dump Screen) dialog box which is used to save the screen dump as a JPEG file. The file can be saved onto a USB memory connected to the front panel USB-A connector. The file is saved with the specified name. If the file extension is not specified, “.jpg” is added automatically.
	Show Source	Displays the output voltage value of the voltage source and changes the softkey label to <i>Hide Source</i> .
	Hide Source	Hides the output voltage value of the voltage source and changes the softkey label to <i>Show Source</i> .

Roll View

Displays the time domain graph for plotting the measurement data. See [Table 4-5](#) for the Y-axis data types. The Roll view can plot up to 5000 data.

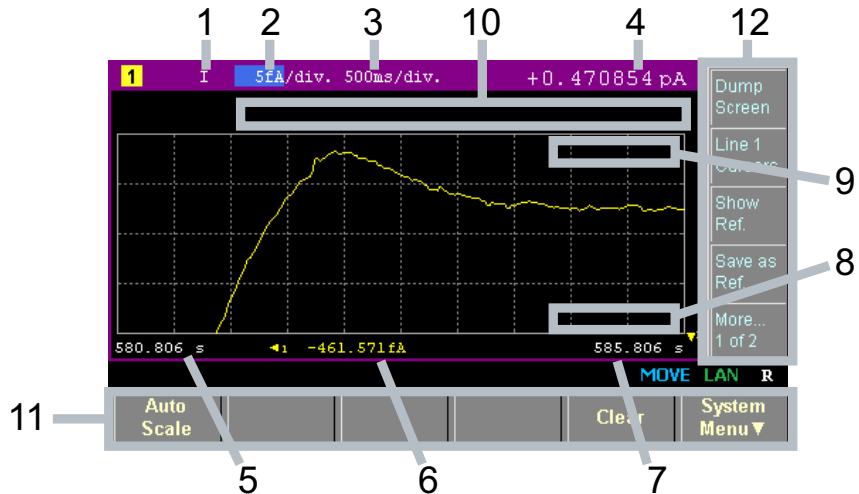

Display area

1. Y-axis data type: I, Q, V, or R. Select one using the assist keys.
2. Y-axis scale per division: A/div., C/div., V/div., or Ω /div..
3. X-axis scale per division: s/div.
4. Latest measurement data
5. X-axis minimum value (minimum timestamp)
6. Y-axis offset values for line 1
7. X-axis maximum value (maximum timestamp)
8. (B2985A/B2987A) Output voltage value of the voltage source (controlled by the *Show Source* or *Hide Source* assist key). If the Voltage Source On/Off switch is turned on, the output value is displayed in yellow. You can change the output voltage using this field.
9. Y-axis data at the active X-cursor position. ----.---- is displayed for the *no-data* position.
10. Cursor data (controlled by the *Line 1 Cursors* or *Hide Cursors* assist key)

First line Positions and distance (e.g. I1, I2, ΔA) of Y-cursors 1 and 2

Second line Positions and distance (e.g. t1, t2, Δt) of X-cursors 1 and 2

11. Function keys

12. Assist keys

Table 4-5 Y-Axis Data Types for Roll View

Data type	Assist key	Description
I	AMPS (I)	Current data
Q	COUL. (Q)	Charge data (B2985A/B2987A)
V	VOLTS (V)	Voltage data (B2985A/B2987A)
R	OHMS (Ω)	Resistance data (B2985A/B2987A)

Function keys

- Auto Scale** Changes graph scale to automatically fit the trace in the graph.
- Clear** Clears the data buffer. The graph display is also cleared.
- System Menu** Assigns the system menu items to the softkeys of the function keys. To cancel the assignment, press the Cancel/Local key. For the system menu, see "[System Menu](#)" on page 4-41.

Assist keys

- Dump Screen** Opens the File Selection (Dump Screen) dialog box which is used to save the screen dump as a JPEG file.

The file can be saved onto a USB memory connected to the front panel USB-A connector. The file is saved with the specified name. If the file extension is not specified, “.jpg” is added automatically.
- Line 1 Cursors** Displays the cursors (Y-cursors 1 and 2, X-cursors 1 and 2, and cursor data) and changes the softkey label to *Hide Cursors*.
- Hide Cursors** Hides the cursors and changes the softkey label to *Line 1 Cursors*.
- Show Ref.** Displays the reference line using the saved measurement data as the reference line data, and changes the softkey label to *Hide Ref.*
- Hide Ref.** Hides the reference line, changes the softkey label to *Show Ref.*

Front Panel Reference
Display and Assist/Function Keys

- | | |
|---------------------|---|
| Save as Ref. | Saves the presently-displayed data as the reference line data temporarily. |
| Show Source | Displays the output voltage value of the voltage source and changes the softkey label to <i>Hide Source</i> . |
| Hide Source | Hides the output voltage value of the voltage source and changes the softkey label to <i>Show Source</i> . |

NOTE

If the number of data exceeds 5000

If the number of measurement data exceeds 5000, the Graph view and the Roll view plot the following data. Where, n is integer, 1 to 5000.

Number of data is 5001 to 10000: $[2*(n-1)+1]$ th data

Number of data is 10001 to 25000: $[5*(n-1)+1]$ th data

Number of data is 25001 to 50000: $[10*(n-1)+1]$ th data





Number of data is 50001 to 100000: $[20*(n-1)+1]$ th data

Status Information

The status information is common for all display modes. It is displayed above the bottom softkeys associated with the function keys.

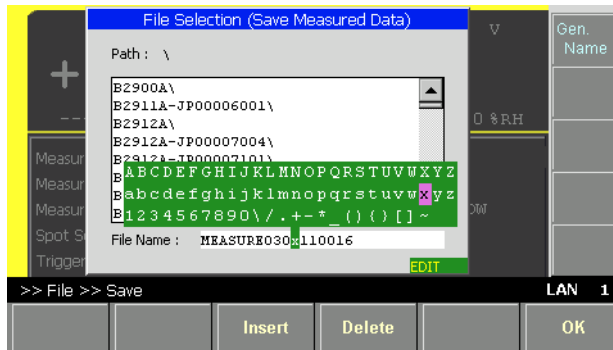

Table 4-6 Status Indicator

Label	Color	Description
AUTO	white	Trigger auto. Automatic trigger is enabled.
ARM	white	Trigger active. Trigger system is active.
HV	yellow	High voltage. Output voltage setting is over ± 21 V.
		The low terminal of the voltage source is disconnected from the circuit common, and is in floating status.
		The inner shield of the Voltmeter input connector (triaxial) is connected to the guard.
		Battery operation indicator (B2983A/B2987A). This indicates the remaining battery level when the instrument is powered by the battery.
REM	white	Remote. Instrument is in the remote state.
		Local lockout. Instrument is in the local lockout (LLO) status.
ERR	white	Error. At least one error is detected.
EDIT	green	Edit mode. The field specified by the pointer can be edited. Not in the move mode.
MOVE	blue	Move mode. The field pointer can be moved. Not in the edit mode.
LAN	green or red	LXI LAN status indicator. Green indicates normal LAN status. Red indicates abnormal condition. Blinking indicates the LAN identification status.
1	white	Display mode: Meter view
G	white	Display mode: Graph view
R	white	Display mode: Roll view
H	white	Display mode: Histogram view

Helper Panel

If the field pointer moves to the field that is required to enter alphanumeric characters such as the *File Name* field, the Helper Panel appears automatically when the field pointer is in the EDIT (green) status.



To enter alphanumeric characters for the field, follow the steps below.

1. Press the Coarse Res, Fine Res, Save or Recall key to move the digitl pointer to a character or digit to be edited in the entry field.
2. Turn the rotary knob or press the Range + or Range - key to move the pointer on the helper panel and select a character.
3. If necessary, press the Insert or Delete function key to insert a new character or delete the character selected in the field.
4. Repeat the steps 1 to 3 until the editing in the field is completed.
5. Press the rotary knob to fix the setting value. The field pointer goes in the MOVE status.

Function keys	Insert	Inserts a character before the presently-selected character in the field.
	Delete	Delete the presently-selected character in the field.
Assist key	Gen. Name	Enters a new entry into the field in the predetermined form such as MEASUREMMDDhhmmss for the file name of the measurement data. Where, <i>MM</i> means a month, <i>DD</i> means a day, <i>hh</i> means an hour, <i>mm</i> means a minute, and <i>ss</i> means a second.

System Menu

Keysight B2980 has the function keys, including the System Menu key, below the front panel display. Press the System Menu key to display the following softkey menu items.

Softkey menu 1	Config	Measurement and voltage source configuration setup. Displays the softkeys for setting several functions of the meter and the voltage source. See " Config key group " on page 4-42.
	Function	Math, limit test, and trace function setup. Displays the softkeys for setting these functions. See " Function key group " on page 4-48.
	Trigger	Trigger configuration and control. Displays the softkeys for setting and controlling the trigger system. See " Trigger key group " on page 4-53.
	Result	Measurement, limit test, and trace result display. Displays the softkeys for displaying these results. See " Result key group " on page 4-56.
	File	File operation. Displays the softkeys for saving and loading a file. See " File key group " on page 4-58.
	More...	Changes the function keys to Softkey menu 2.
Softkey menu 2	Program	Program configuration and control. Displays the softkeys for setting and controlling the program memory. See " Program key group " on page 4-60.
	I/O	I/O setup. Displays the softkeys for setting the I/O interfaces. See " I/O key group " on page 4-61.
	Display	Display setup. Displays the softkeys for setting the display functions. See " Display key group " on page 4-67.
	System	System setup. Displays the softkeys used for several system setups. See " System key group " on page 4-70.
	More...	Changes the function keys to Softkey menu 1.

Config key group

Press the Config key to display the following softkeys for setting several functions of the meter and the voltage source.

Source

(B2985A/B2987A) Displays the following softkeys for setting the voltage source operation.

- Connection** Source operation and connection setup. See "[Output Connection dialog box](#)" on page 4-44.
- Sweep** Sweep source detail setup. See "[Sweep dialog box](#)" on page 4-45.

Measure

Displays the following softkeys for setting the measurement operation.

- Connection** (B2985A/B2987A) Measurement operation and connection setup. See "[Input Connection dialog box](#)" on page 4-45.
- Filter** Digital filter setup for measurement. See "[Measure Filter dialog box](#)" on page 4-46.
- Ranging** Automatic ranging speed setup, Normal or Fast
- Normal** Performs the basic auto-ranging operation. The channel automatically sets the range which provides the best resolution in performing the measurement.
 - Fast** For performing high throughput measurement, reduces observation time to determine measurement range. This setup can be used when the measurement signal noise (superposed from AC power, etc.) is low.

The softkey displays the present Normal/Fast status of this function. Pressing this key switches the status.

- Coulomb** (B2985A/B2987A) Displays the following softkeys for setting the automatic discharge function of the charge measurement.
- Auto Dis.** Automatic discharge function setup, ON or OFF.

		<p>The softkey displays the present ON/OFF status of this function. Pressing this key switches the status.</p>
	Dis. Level	<p>Minimum discharge level, 2 nC, 20 nC, 200 nC, or 2 μC.</p> <p>The softkey displays the present discharge level. Pressing this key switches the level.</p>
Ohms	(B2985A/B2987A)	Displays the following softkeys for setting the resistance measurement operation.
	V Select	<p>Resistance calculation mode setup. Source or Measure.</p> <p>If Source is selected, the resistance is calculated by $R = V_s/I_m$. Where, V_s is the voltage source output value, and I_m is the current measurement value.</p> <p>If Measure is selected, the resistance is calculated by $R = V_m/I_m$. Where, V_m is the voltage measurement value, and I_m is the current measurement value.</p> <p>The softkey displays the present Source/Measure status of this function. Pressing this key switches the status.</p>
	V Control	<p>V Control mode setup. Manual or Auto. For details, see "V Control Mode" on page 3-28.</p> <p>If Manual is set, the resistance measurement is performed with the condition given by the Measure Amps, Spot Source Range, and Voltage Source field settings.</p> <p>If Auto is set, the resistance measurement is performed with the condition automatically derived from the Measure Ohms field setting.</p> <p>The softkey displays the present Manual/Auto status of this function. Pressing this key switches the status.</p>

	Absolute	Absolute value of resistance measurement result. ON or OFF. ON sets the resistance measurement result to absolute format. OFF cancels the absolute format. The softkey displays the present ON/OFF status of this function. Pressing this key switches the status.
Volts	(B2985A/B2987A) Displays the following softkey for setting the voltage measurement operation.	
	Attn.	Attenuation level (coefficient) for the voltage input. 1 or 100 When performing voltage measurement with the Keysight N1413A/N1414A adapter, set this level to 100 in order to return actual voltage value. The softkey displays the present status of this function. Pressing this key switches the status.
Common	(B2985A/B2987A) Displays the following softkey for setting the source and measurement operations commonly.	
	Wait	Source and measurement wait time setup. See " Wait Control dialog box " on page 4-46.

Output Connection dialog box

(B2985A/B2987A) This dialog box provides the following parameters for setting the source operation and connection.

Low Terminal State	Voltage Source Low terminal connection, CCOM (circuit common) or FLOAT (floating)
Output-Off State	Output-off state, HIGH Z (high impedance), NORMAL (normal), or ZERO (0 V) This is the source setup condition after output off. See Table 5-2 on page 5-19.

Resistive Limit State Voltage source output resistor (20 M Ω) connection, ON (serial connection) or OFF (no connection)

Sweep dialog box

(B2985A/B2987A) This dialog box provides the following parameters for setting details of the sweep source operation.

Sweep Ranging Ranging mode used for the sweep source operation, BEST or FIXED. See [Table 4-7 on page 4-45](#).

Sweep Direction Sweep direction, UP (start to stop direction) or DOWN (stop to start direction)

Output after Sweep The value the source channel applies after it completes the sweep output

START VALUE (START): The source channel changes the output to the DC output value just before applying the sweep output start value.

END VALUE (END): The source channel keeps the output value when the sweep output is stopped.

Table 4-7 Ranging Mode used for Sweep Source Operation

	Description
BEST	The sweep source channel automatically uses the minimum range which covers the whole sweep output.
FIXED	The sweep source channel sets the range specified by the range parameter <i>Spot Source Range</i> . See "Range Setup Sub-panel" on page 4-23 .

Input Connection dialog box

(B2985A/B2987A) This dialog box provides the following parameters for setting the measurement operation and connection.

Analog Signal Output Measurement mode that is applied to the analog output function, IM (current), VM (voltage), or QM (charge). See ["Analog Output" on page 5-14](#).

Voltage Measure Inner Shield Inner shield connection of the Voltmeter input connector, CCOM (circuit common) or GUARD (guard). See "[Voltage Measurement](#)" on page 3-14.

Measure Filter dialog box

This dialog box provides the following parameters for setting the measurement filter.

Median Filter (Current)

Median filter, ON or OFF
On the B2985A/B2987A, it is effective for the current and charge measurements.
Set an integer of 0 to 15 for the Rank field if this filter is ON.

Moving Average (All)

Moving average filter, ON or OFF
Set the number of samples (n integer of 1 to 100) to the Count field if this filter is ON.

Note that the Measure Filter dialog box opened by pressing the Filter key on the front panel cannot be used for changing ON/OFF of each filter.

See "[Measurement Filter](#)" on page 5-12 for more information.

Wait Control dialog box

(B2985A/B2987A) This dialog box provides the following parameters for setting the source and measurement wait time, that are available for the Source and Measure columns.

The source wait time is defined as the time the source channel cannot change the output after the start of a DC output.

The measurement wait time is defined as the time the measurement channel cannot start measurement after the start of a DC output.

State Wait time, ON or OFF

Automatic Automatic wait time, ON or OFF

Gain and Offset Parameters for calculating the wait time. See the following formula.

- If State=ON and Automatic=ON:
wait time = $Gain \times \text{initial wait time} + Offset$
- If State=ON and Automatic=OFF:
wait time = $Offset$
- If State=OFF:
wait time = 0

The initial wait time is automatically set by the instrument, and cannot be changed.

Function key group

Press the Function key to display the following softkeys for setting the math, limit test, and trace functions.

Math

Displays the following softkeys for setting the math function.

- Expression** Math function setup. See "[Math Expression dialog box](#)" on page 4-48.
- Variable** Math variable setup. See "[Math Variable dialog box](#)" on page 4-49.

Limit Test

Displays the following softkeys for setting the limit test function.

- Composite** Limit test operation setup. See "[Composite Limit Test Setup dialog box](#)" on page 4-49.
- Limits** Limit test data configuration setup. See "[Limit Test Setup dialog box](#)" on page 4-51.

Trace

Trace function setup. See "[Trace Buffer Setup dialog box](#)" on page 4-52.

Math Expression dialog box

This dialog box provides the following parameters for setting the math function. If the math function is ON, the measurement data can be calculated by using the specified math expression.

- Status** Math function, ON or OFF
- Unit** Unit for the calculation result of the math expression

The available math expressions are listed in the area below the Unit field. Select a math expression for data calculation from this area. To select a math expression, highlight the name in this area.

The data calculation is effective for data measured after the math function is set by this dialog box. The calculation result can be displayed on the dialog box opened by using the Result key group. See "[Result key group](#)" on page 4-56.

Math expressions can be defined by using the SCPI commands while the B2980 is in the remote mode.

For the predefined math expressions, see "[Predefined Math Expressions](#)" on page 5-22.

Note that the Math Expression dialog box opened by pressing the Math key on the front panel does not display the Status field.

Math Variable dialog box

This dialog box provides the following parameters for setting the math variables.

Index	Index number of the math variables
Name	Math variable name
Value	Value for the math variable

When the pointer is in the MOVE status, turning the rotary knob moves the pointer onto the left or right cell. And pressing the knob changes the status to EDIT.

When the Index cell is in the EDIT status, the following assist keys are available for creating and scrolling the list.

Then turning the rotary knob scrolls the list and pressing the knob changes the status to MOVE.

Append	Adds a line below. The same output value is entered into the right cell.
Insert	Adds a line above. The same output value is entered into the right cell.
Delete	Deletes the line.

When the Name cell is in the EDIT status, the variable name can be entered by using the rotary knob.

When the Value cell is in the EDIT status, the variable value can be entered by using the rotary knob.

Composite Limit Test Setup dialog box

This dialog box provides the following parameters for setting the limit test operation.

Limit Test	Limit test function, ON or OFF
Mode	Operation mode, GRADING (GRADE) or SORTING (SORT)

Front Panel Reference
Function key group

	GRADING (GRADE): Grading mode. See Figure 5-7 for the operation.
	SORTING (SORT): Sorting mode. See Figure 5-8 for the operation.
Auto Clear	Automatic clear of the composite limit test result, ON or OFF If this parameter is ON, the composite limit test results and the DIO lines are automatically cleared.
Update	Only for the GRADING mode. Test result output timing, IMMEDIATE (IMM.) or END. See “Immediate?” shown in Figure 5-7 . IMMEDIATE (IMM.): Output after every test (Immediate? Yes) END: Output after the last test (Immediate? No)
Offset Cancel	Offset cancel, ON or OFF If this parameter is ON, the data for the limit test judgement will be as follows. Data for judgement = measurement data - offset value
Offset	Offset value used for the offset cancel, -9.999999E+20 to +9.999999E+20
Pass Pattern	Bit pattern for the limit test <i>pass</i> state. For the GRADING mode.
Fail Pattern	Bit pattern for the limit test <i>fail</i> state. For the SORTING mode.
GPIO Pins	Displays the DIO pins assigned to the bit pattern output. To set the pins, use the :CALC:DIG:BIT command.
/BUSY	DIO pin assigned to the BUSY (busy) signal output
/SOT	DIO pin assigned to the SOT (start of test) signal input
/EOT	DIO pin assigned to the EOT (end of test) signal output

For the DIO pin assignment, see ["Using Digital I/O and Trigger In/Out" on page 2-24](#).

DIO pins assigned to the GPIO Pins, /BUSY, /SOT, or /EOT must be set to the DIGITAL I/O function by using the [DIO Configuration dialog box](#).

NOTE**Values of GPIO Pins, /BUSY, /SOT, and /EOT**

0 to 7 (integer). Numbers 1 to 7 indicate the DIO pins 1 to 7, respectively. 0 indicates that it is not used.

For GPIO Pins, multiple continuous pins are assigned. For example, “1, 2, 3, 4” indicates that the DIO pins 1 to 4 are assigned. Then LSB is DIO pin 1.

Limit Test Setup dialog box

This dialog box provides the following parameters for setting the data configuration of the limit test.

Feed Data	Type of data used for the pass/fail judgement of the limit test, AMPS, COUL., VOLTS, OHMS, or MATH. AMPS: Current measurement data COULS.: Charge measurement data (B2985A/B2987A) VOLTS: Voltage measurement data (B2985A/B2987A) OHMS: Resistance data (B2985A/B2987A) MATH: Calculation result data of math expression
Test Index	Index of limit test, No. 1 to 12. The index numbers 1 to 12 are associated with the bin numbers 1 to 12. See " Limit Test Result dialog box " on page 4-56.
Limit Test	Limit test for data specified by the Feed Data and Test Index parameters, ON or OFF
Function	Test mode, LIMIT is always displayed.
Pass Pattern	Bit pattern for the limit test <i>pass</i> state. For the SORTING mode.
Up Pattern	Bit pattern for the <i>failed-by-exceeding-upper-limit</i> state. Used for the GRADING mode.
Up Limit	Upper limit for the pass/fail judgement. Used for the GRADING mode.
Low Pattern	Bit pattern for the <i>failed-by-exceeding-lower-limit</i> state. Used for the GRADING mode.
Low Limit	Lower limit for the pass/fail judgement. Used for the GRADING mode.

Bit pattern is sent to the DIO pins specified by the GPIO Pins field on the Composite Limit Test Setup dialog box.

Trace Buffer Setup dialog box

This dialog box provides the following parameters for setting the trace function. The data specified by the Feed Data parameter can be stored in the trace buffer if the Buffer Control parameter is NEXT. The maximum data size is specified by the Buffer Size parameter. See [Figure 5-9 on page 33](#) for the trace buffer.

Feed Data	Type of data placed in the trace buffer, SENSE, MATH, or LIMIT SENSE: Measurement result data MATH: Calculation result data of math expression LIMIT: Limit test data The data contains the current measurement data, calculation result data, limit test data, time data, and status data selected by using the Format keys of the I/O key group. See "I/O key group" on page 4-61 . On the B2985A/B2987A, the data contains the charge measurement data, voltage measurement data, resistance measurement data, voltage source output data, temperature data, and humidity data in addition to above.
Buffer Control	Trace buffer control mode, NEVER or NEXT NEVER: Disables the write operation to the trace buffer. NEXT: Enables the write operation until buffer full. Buffer full will change the mode to NEVER.
Buffer Size	Size of the trace buffer, 1 to 100000 data

Trigger key group

Press the Trigger key to display the following softkeys for setting the trigger parameters in detail and controlling the trigger system. See [Figure 5-10 on page 36](#).

- Config** Opens a dialog box. See ["Trigger Configuration dialog box" on page 4-53](#).
- Initiate** Displays the softkeys for selecting the device action to initiate (to go to the arm layer of the trigger system). See [Table 4-8](#).
- Abort** Displays the softkeys for selecting the device action to abort (to return to the idle state of the trigger system). See [Table 4-8](#).
- Immediate** Displays the following softkeys for selecting the arm layer or trigger layer for sending the immediate trigger.

Trigger Selects the trigger layer.

Arm Selects the arm layer.

Selecting the layer displays the softkeys for selecting the device action to send the immediate trigger. See [Table 4-8](#).

Table 4-8

Softkeys to Select Device Action and Channel

Softkey label	Description
ALL	Selects the transient and acquire device actions.
Trans.	Selects the transient (voltage source output, B2985A/B2987A only) device action only.
Acq.	Selects the acquire (measurement) device action only.
Selecting the device action executes Initiate, Abort, or Immediate for the specified device action.	

Trigger Configuration dialog box

This dialog box is used to set the trigger parameters in detail. Note that the overlapped parameter values are ignored and replaced with the settings made on the Meter view. See ["Trigger Setup Sub-panel" on page 4-28](#).

Layer Specifies the layer or device action set by this dialog box.

Front Panel Reference

Trigger key group

	ARM: Arm layer
	TRIGGER: Trigger layer
	ACTION: Device action
	For ACTION, the available parameters are Layer, Action, and Trigger Output.
Action	Specifies the device action type set by this dialog box. TRANS.: (B2985A/B2987A) Transient (voltage source output) device action ACQ.: Acquire (measurement) device action
Count	Count, 1 to 100000 or INF. (infinity), for the action specified by the Layer and Action parameters
Bypass	Bypass, ON or OFF Bypass=ON enables the bypass only for the first passage to the event detector for the action specified by the Layer and Action parameters. Bypass=OFF disables the bypass.
Trigger Source	Event for the action specified by the Layer and Action parameters. AUTO, BUS, TIMER, INT1, INT2, LAN, EXT1, EXT2, EXT3, EXT4, EXT5, EXT6, EXT7, or TIN (Trigger In connector). See Table 4-9 . For using the Trigger In connector, it is necessary to set input trigger polarity. See " BNC Configuration dialog box " on page 4-66 .
Period	Only for the TIMER event. Interval of the TIMER event for the action specified by the Layer and Action parameters, 10 μ s to 100000 s
Trigger Delay	Delay time for the action specified by the Layer and Action parameters, 0 to 100000 s
Trigger Output	Trigger output, ON or OFF Trigger output terminal, an internal bus (INT1, INT2), LAN port (LAN), a digital I/O pin EXT n ($n=1$ to 7), or TOUT (Trigger Out connector)

If this parameter is ON, B2980 sends an output trigger when it changes the trigger state for the action specified by the Layer and Action parameters. See [Figure 5-10 on page 36](#).

For using a digital I/O pin, it is necessary to set function of the pin, output trigger polarity, type, pulse width, and so on. See ["DIO Configuration dialog box" on page 4-64](#) and ["Using Digital I/O and Trigger In/Out" on page 2-24](#).

For using the Trigger Out connector, it is necessary to set output trigger polarity, type, pulse width, and so on. See ["BNC Configuration dialog box" on page 4-66](#).

Table 4-9 Trigger Source

Trigger Source	Description
AUTO	Trigger source best suited for the present operating mode is automatically selected by the internal algorithms.
BUS	Remote interface trigger command such as GET, TRIGger, and *TRG
TIMER	Signal internally generated every interval set by the Period field
INT1 or INT2	Signal from the internal bus 1 or 2
LAN	LXI trigger specified by the :ARM[:ACQ]:TRAN]:SOUR:LAN and :TRIG[:ACQ]:TRAN]:SOUR:LAN commands
EXT n	Signal from the DIO pin n , which is an I/O port of the Digital I/O D-sub connector on the rear panel. $n=1$ to 7
TIN (Trigger In connector)	Trigger signal to the Trigger In connector

Result key group

Press the Result key to display the following softkeys for displaying the measurement, limit test, and trace results.

- Measure** Displays the measurement result. See "[Measure Result dialog box](#)" on page 4-56.
- Limit Test** Displays the limit test result. See "[Limit Test Result dialog box](#)" on page 4-56.
- Trace** Displays the trace result. See "[Trace Statistical Result dialog box](#)" on page 4-57.

Measure Result dialog box

This dialog box is used to display the last single (one shot) measurement result (maximum 100000 data) or the last repeat (continuous) measurement result (maximum 1000 data), stored in the data buffer.

The result data is shown in the index and data table below the Type field. Also, the data is plotted in the graph area above the Points fields.

Type	Type of data to display AMPS: Current measurement data COUL.: Charge measurement data (B2985A/B2987A) VOLTS: Voltage measurement data (B2985A/B2987A) OHMS: Resistance data (B2985A/B2987A) MATH: Calculation result data of math expression TIME: Time data
Points	Number of data points.
Max.	Y-axis maximum value of the graph.
Min.	Y-axis minimum value of the graph.

Limit Test Result dialog box

This dialog box provides the following GUI for displaying the limit test result. The result data is shown in the data list area below the Length field.

Length	Data length
---------------	-------------

The limit test data contains the following information.

(aaaaa) BIN: bb DATA: +c.ccccccE+dd

(aaaaa) Data index aaaaa

BIN: Bin number bb (01 to 12)

The bin numbers 1 to 12 are associated with the index numbers 1 to 12. See "[Limit Test Setup dialog box](#)" on page 4-51.

If the limit test data is out of the bins, 00 is set for the GRADING mode and 15 is set for the SORTING mode.

DATA: Limit test data +c.ccccccE+dd

Trace Statistical Result dialog box

This dialog box provides the following GUI for displaying the trace statistical result. The result data is displayed in the Mean, Std. Dev., Min., and Max. fields.

Feed Type of data to display, SENSE, MATH, or LIMIT

SENSE: Measurement result data

MATH: Calculation result data of math expression

LIMIT: Limit test data

Element Element type of the measurement result data to display. This is available only when the Feed parameter is set to SENSE.

AMPS: Current measurement data

COUL.: (B2985A/B2987A) Charge measurement data

VOLTS: (B2985A/B2987A) Voltage measurement data

OHMS: (B2985A/B2987A) Resistance data

Length Data length

Mean Mean value

Std. Dev. Standard deviation

Min. Minimum value

Max. Maximum value

File key group

Press the File key to display the following softkeys for saving a file on and loading a file from a USB memory connected to the front panel USB-A connector.

Save

Displays the following softkeys for saving a file. Press a softkey to display the File Selection dialog box. See "[File Selection dialog box](#)" on page 4-58.

Measure	Saves a measurement data file.
Math	Saves a math result data file.
Limit Test	Saves a limit test result data file.
Trace	Saves a trace buffer data file.
Config	Saves a system setting data file.

Load

Displays the following softkey for loading a file. Press the softkey to display the File Selection dialog box. See "[File Selection dialog box](#)" on page 4-58.

Config	Loads a system setting data file.
License	Loads a license file.

NOTE

The license file enables the functions secured by license. To get the file, follow instructions described in the Software Entitlement Certificate sheet supplied with a license product.

File Selection dialog box

This dialog box provides the following GUI for saving or loading a file.

Pressing the rotary knob switches the status EDIT and MOVE.

To select a file, change the status to EDIT, and use the rotary knob, assist keys, function keys, and helper panel.

Path	Folder name for saving or loading a file.
File Name	File name to save or load.

The files and folders saved in the specified folder are listed in the area between the Path field and the File Name field. This area can be used for selecting a file by highlighting its name.

For saving a system setting file, if the file extension is not specified, “.sta” is added automatically. For saving the other data file, “.csv” is added automatically.

Program key group

Press the Program key to display the following softkeys for setting and controlling the program memory. For details on the program memory, see "[Program Memory](#)" on page 5-34.

The program memory can be defined by using the SCPI commands while the B2980 is in the remote mode.

Catalog

Displays the Program Catalog dialog box which lists the programs saved in the program memory. This dialog box is also used to specify the memory program to use. To select a memory program, highlight its name in this list.

View

Displays the Program View dialog box which shows the program code of the specified program.

Variable

Displays the Variable dialog box which lists the variables used in the memory programs. Available index is 1 to 100.

Control

Displays the following softkeys for controlling the operation of the program memory.

The current status can be known by an asterisk (*) on the softkey label.

Run	Starts the specified memory program.
Pause	Pauses the execution of the memory program.
Step	Starts the step execution of the specified memory program.
Stop	Stops the execution of the memory program.
Continue	Continues the execution of the memory program presently paused.

I/O key group

Press the I/O key to display the following softkeys for setting the I/O interfaces.

Format

Displays the five softkeys for setting the data output format. See "[Data Output Format](#)" on page 4-62.

LAN

Displays the following softkeys for managing the LAN interface.

- | | |
|-----------------|--|
| Config | Displays the LAN Configuration dialog box used to set the configuration of the LAN interface. See " LAN Configuration dialog box " on page 4-64. |
| Status | Displays the LAN Status dialog box which displays the status of the LAN interface. |
| Reset | Resets all of the LAN connections. |
| Defaults | Sets the LAN settings to the factory default settings. |

Press the Reset softkey or the Defaults softkey to display a confirmation dialog box. Press the OK softkey to confirm the specified action, or press the Cancel/Local key to cancel the action.

USB

Displays the USB Status dialog box.

- | | |
|---------------------------|---|
| Easy File Access | File access function setup, ON (enable) or OFF (disable). When this is set to ON, restart this instrument. When you use this function, connect this instrument to a PC using a USB cable. See " File Access Function (Easy File Access) " on page 5-41. |
| Text display field | Displays the VISA USB connect string. |

Example:

```
USB0::2391::54808::MY12345678::0::INSTR
```

GPIB

Displays the GPIB Configuration dialog box.

- | | |
|---------------------------|--|
| Address | Sets the GPIB address of the B2980. |
| Text display field | Displays the VISA GPIB connect string. |

Example: GPIB0::23::INSTR

DIO

Displays the following softkeys for managing the Digital I/O interface.

- Config** Displays the DIO Configuration dialog box used to set the configuration of the Digital I/O interface. See "[DIO Configuration dialog box](#)" on page 4-64.
- R/W** Displays the DIO Read/Write dialog box used to read or write a value set to the Digital I/O interface. See "[DIO Read/Write dialog box](#)" on page 4-65.

BNC

Displays the BNC Configuration dialog box used to set the configuration of the Trigger In and Trigger Out BNC connectors. See "[BNC Configuration dialog box](#)" on page 4-66.

Data Output Format

Press the Format softkey to display the following softkeys for setting the format and elements of the output data.

- Measure** Displays the Format (Measure) dialog box used to set the elements of the measurement data output. See "[Format \(Measure\) dialog box](#)" on page 4-63.
- Math/Limit** Displays the Format (Math/Limit) dialog box used to set the elements of the math result data output and the limit test result data output. See "[Format \(Math/Limit\) dialog box](#)" on page 4-63.
- Trace** Displays the Format (Trace) dialog box used to set the elements of the trace data output. See "[Format \(Trace\) dialog box](#)" on page 4-63.
- Data Type** Specifies the data output format. The present setting is displayed on the softkey label. Press this key to change the present format.
- | | |
|---------------|--|
| ASCII | ASCII format |
| REAL32 | IEEE-754 single precision format, 4-byte |
| REAL64 | IEEE-754 double precision format, 8-byte |
- Data Swap** Enables or disables the byte swap for the IEEE-754 precision format data output. The present setting is displayed on the softkey label. Press this key to switch the present setting.
- | | |
|------------|--|
| OFF | Disables the byte swap. Normal byte order. |
| ON | Enables the byte swap. Reverse byte order. |

If Data Swap=ON, the byte order is reversed. Byte 1 to byte 4 are sent in the order of byte 4 to byte 1 for the IEEE-754 single precision format, and byte 1 to byte 8 are sent in the order of byte 8 to byte 1 for the IEEE-754 double precision format.

Format (Measure) dialog box

This dialog box provides the following parameters for setting the elements of the measurement data output. For B2981A and B2983A, Current, Time, and Status fields are effective.

Voltage	Voltage data output, ON or OFF
Current (Charge)	Current or charge data output, CURRENT (current data), CHARGE (charge data), or OFF
Resistance	Resistance data output, ON or OFF
Source	Voltage source data output, ON or OFF
Time	Time data output, ON or OFF
Status	Status data output, ON or OFF
Temperature	Temperature data output, ON or OFF
Humidity	Humidity data output, ON or OFF

Format (Math/Limit) dialog box

This dialog box provides the following parameters for setting the elements of the math result data output and the limit test result data output.

Data	Result data output, ON or OFF
Time	Time data output, ON or OFF
Status	Status data output, ON or OFF

Format (Trace) dialog box

This dialog box provides the following parameters for setting the elements of the trace statistical data output.

Data	Trace data. Selects one from the following data elements.	
	MEAN	Mean value
	STD.DEV.	Standard deviation

	MIN.	Minimum value
	MAX.	Maximum value
	PK-PK	Peak to peak value
Timestamp	Timestamp data format. Selects one from the following:	
	ABSOLUTE	Absolute value (ABS.). Returns the incremental value for the first timestamp data.
	DELTA	Delta value (DELTA). Returns the incremental value for the previous timestamp data.

LAN Configuration dialog box

This dialog box provides the following parameters for setting the configuration of the LAN interface.

IP Address Config.	IP address configuration, AUTO or MANUAL AUTO configuration uses the DHCP server.
mDNS	mDNS (multicast DNS) status, ON or OFF
IP Address	IP address of this instrument, used for the MANUAL IP address configuration
Subnet	Subnet mask, used for the MANUAL IP address configuration
Gateway	IP address of gateway, used for the MANUAL IP address configuration
DNS Server Config.	DNS server configuration, AUTO or MANUAL
DNS Server	IP address of DNS server, primary and secondary, used for the MANUAL DNS server configuration
Hostname	Host name of this instrument
WINS Server	IP address of WINS server, primary and secondary

DIO Configuration dialog box

This dialog box provides the following parameters for setting the configuration of the Digital I/O interface.

Pin #	Digital I/O pin number, 1 to 7 This field specifies the pin set by this dialog box.
Function	Function of the specified pin of the Digital I/O interface, DIGITAL I/O (digital signal input/output), DIGITAL IN (digital signal input), TRIGGER OUT (trigger output), or TRIGGER IN (trigger input)
Polarity	Polarity of the input/output function, POSITIVE (POS., positive) or NEGATIVE (NEG., negative)
Output Trigger Type	Type of output trigger, EDGE (edge) or LEVEL (level)
Output Trigger Timing	Timing of the output trigger, AFTER (after action (arm, trigger, and device action)), BEFORE (before action), or BOTH (both)
Output Pulse Width	Pulse width of the output trigger, 10 μ s to 10 ms

For more information about the trigger function, see "[Trigger key group](#)" on page 4-53.

DIO Read/Write dialog box

This dialog box provides the following parameters for reading or writing a value set to the Digital I/O interface.

Format	Format of the value set to the Mask Value field and the Value field, BIN (binary), DEC (decimal), or HEX (hexadecimal)
Mask Value	Mask value which indicates the pattern of the un-used bits of the Digital I/O interface The READ assist key is used to read the mask value presently set to the Digital I/O interface. The WRITE assist key is used to set the specified mask value to the Digital I/O interface.
Value	Value set to the Digital I/O interface The READ assist key is used to read the value presently set to the Digital I/O interface. The WRITE assist key is used to write the specified value to the Digital I/O interface.

BNC Configuration dialog box

This dialog box provides the following parameters for setting the configuration of the Trigger In and Trigger Out BNC connectors.

Input Polarity	Polarity of the input signal to the Trigger In connector, POSITIVE (POS., positive) or NEGATIVE (NEG., negative)
Output Polarity	Polarity of the output signal from the Trigger Out connector, POSITIVE (POS., positive) or NEGATIVE (NEG., negative)
Output Trigger Type	Type of output trigger, EDGE (edge) or LEVEL (level)
Output Trigger Timing	Timing of the output trigger, AFTER (after action (arm, trigger, and device action)), BEFORE (before action), or BOTH (both)
Output Pulse Width	Pulse width of the output trigger, 10 μ s to 10 ms

For more information about the trigger function, see "[Trigger key group](#)" on page 4-53.

Display key group

Press the Display key to display the following softkeys for setting the display functions.

Remote

Enables or disables the front panel display when the B2980 is in the remote mode. The present setting is displayed on the softkey label. Press the key to switch the setting.

- OFF** Disables the front panel display. Effective for fast operation.
- ON** Enables the front panel display.

Color

Specifies the display color set. The present setting is displayed on the softkey label. Press the key to switch the setting.

- Set 1** Sets the color set 1.
- Set 2** Sets the color set 2.

Zoom

Enables or disables the display zoom. The present setting is displayed on the softkey label. Press the key to switch the setting.

- OFF** Disables the zoom. Normal display.
- ON** Enables the zoom. Only the measured data is displayed.
Zoom-in can be cancelled by pressing the Zoom Out assist key.

In the zoom-in state, the Meter view displays the primary and secondary measurement data with a large font without the setup parameters.

Digits

Specifies the data display resolution. The present setting is displayed on the softkey label. Press the key to change the setting.

- 4** Sets 3½ digit resolution.
- 5** Sets 4½ digit resolution.
- 6** Sets 5½ digit resolution.
- 7** Sets 6½ digit resolution.

Pref.

(B2985A/B2987A) Displays the Display Preference dialog box used to set the preference for front panel operation. See ["Display Preference dialog box" on page 4-68](#).

Display Preference dialog box

(B2985A/B2987A) This dialog box provides the following parameter for the front panel operation.

The following setting is saved to the non-volatile memory.

Dual Measure

Result Display Displays or hides the secondary measurement result value on the Meter view, ON or OFF

Immediate Voltage

Update by Knob Selects the channel operation when the voltage source output value is changed by using the digit pointer and the rotary knob (or Range +/Range - key).

ON Real time update ON

Turning the rotary knob changes the display value and updates the voltage source output in real time.

In this status, the decimal point cannot be moved by the digit pointer.

OFF Real time update OFF

Turning the rotary knob just changes the display value. The value is applied to the voltage source output by pressing the rotary knob.

Temperature Displays or hides the temperature measurement data on the Meter view, ON or OFF. To specify the thermometer to be used, set the following parameter to the “at” field.

THERMOCOUPLE (THERMO.): Uses the K-type thermocouple.

HUMIDITY SENSOR (HUMID.): Uses a thermometer in the humidity sensor.

Humidity Displays or hides the humidity measurement data on the Meter view, ON or OFF

**Restore Trigger
Mode on Local**

Stores the trigger mode setting on entering GP-IB remote state.
ON or OFF (default)

ON: Saves the trigger mode setting in the nonvolatile memory on entering GPIB remote state and restores the saved trigger mode setting when returning to GPIB local mode.

OFF: Disables this function.

**Measured Value
Format (Meter
View)**

Selects the display format of measured value to be displayed on Meter view. ENG (default) or EXP

ENG: Displays the measured value in engineering format.

EXP: Displays the measured value in exponential format.

System key group

Press the System key to display the following softkeys used for several system setups.

Error

Displays the following softkeys to view or clear errors.

- | | |
|--------------|---|
| Log | Displays the Error Log dialog box which displays the SCPI errors. |
| Clear | Clears the error buffer immediately. |

Reset

Initializes the B2980.

Press the Reset softkey to display a confirmation dialog box and press one of the following softkeys to perform the initialization.

To cancel the initialization and close a confirmation dialog box, press the Cancel/Local key.

- | | |
|----------------|------------------------------------|
| Display | Initializes the display settings. |
| H/W | Initializes the hardware settings. |
| ALL | Initializes all settings. |

Cal/Test

Displays the following softkeys for performing self-calibration or self-test.

- | | |
|------------------|----------------------------|
| Self-Cal | Performs self-calibration. |
| Self-Test | Performs self-test. |

Press the softkey to display a confirmation dialog box. Press the OK softkey to start self-calibration or self-test, or the Cancel/Local key to cancel.

PLC

Specifies the power line frequency. The present setting is indicated by an asterisk on the softkey label. Press the key to set up the following.

- | | |
|--------------------|--|
| 50 Hz | Specifies the power line frequency 50 Hz. |
| 60 Hz | Specifies the power line frequency 60 Hz. |
| Auto Detect | Checks the AC power line frequency, and then sets the detected frequency (50 Hz or 60 Hz) to the power line frequency. |

Timestamp

Displays the following softkeys to clear timestamp.

- Clear** Clears the timestamp. Press this softkey to display the confirmation dialog box. Press the OK softkey to clear the timestamp, or the Cancel/Local key to cancel.
- Auto CLR** Sets the automatic clear of the timestamp. The present setting is displayed on the softkey label. Press the key to switch the setting.
- OFF** Disables the automatic clear of the timestamp.
 - ON** Enables the automatic clear of the timestamp.

Start-up

Displays the System Start-up dialog box which provides the following setup parameters.

Power-on State Power-on state, RST, #1 (RCL0), #2 (RCL1), #3 (RCL2), #4 (RCL3), or #5 (RCL4)

The power-on state can be selected from the factory default reset condition (RST) and user conditions #1 (RCL0), #2 (RCL1), #3 (RCL2), #4 (RCL3), and #5 (RCL4). The user conditions are defined by the *SAV commands, or the destinations where the system setting was saved by the Save key.

- #1 (RCL0): Destination #1 or *SAV0 command
- #2 (RCL1): Destination #2 or *SAV1 command
- #3 (RCL2): Destination #3 or *SAV2 command
- #4 (RCL3): Destination #4 or *SAV3 command
- #5 (RCL4): Destination #5 or *SAV4 command

Power-on Program Power-on program execution, ON or OFF

If this parameter is ON, the power-on program is automatically executed when the B2980 is turned on.

The power-on program can be defined by using the :PROG:PON:COPY command while the B2980 is in the remote mode.

Power-on PLC Detect

Enables or disable to automatically detect the AC power line frequency when B2980 is turned on, ON (enable) or OFF (disable)

The detected frequency (50 Hz or 60 Hz) is set to the PLC value.

Sound

Enables or disables the beep and sound. The present setting is displayed on the softkey label. Pressing the key switches the setting.

OFF Disables the beep and sound.

ON Enables the beep and sound.

Language

Sets the remote control command set of this instrument.

The Default softkey is available for specifying the default command set, SCPI which supports all B2980 functions.

Info.

Displays the following four softkeys.

Revision Displays the Revision dialog box which displays the model number, serial number, firmware revision, CPU FPGA revision, module revision, installed licenses, system uptime, and battery cycle count (B2983A/B2987A) of the B2980.

Date/Time Displays the Date and Time dialog box which is used to view or set the date and time.

Update Used for firmware update.

Demo. Performs demonstration. Press this softkey to display a confirmation dialog box. Press the OK softkey to start demonstration, or the Cancel/Local key to cancel.

Factory Reset

Clears all user data. Press this softkey to display a confirmation dialog box. Press the OK softkey to clear it, or the Cancel/Local key to cancel.

Function Details

This chapter describes the following functions of Keysight B2980.

- "Measurement Range"
- "Measurement Time"
- "Null, Offset Cancel"
- "Measurement Filter"
- "Analog Output"
- "Voltage Source (B2985A/B2987A)"
- "Interlock Function (B2985A/B2987A)"
- "Temperature and Humidity Measurements (B2985A/B2987A)"
- "Math Expression"
- "Limit Test"
- "Trace Buffer"
- "Program Memory"
- "Trigger System"
- "Save/Recall Function"
- "File Access Function (Easy File Access)"
- "PLC Detection and Setup Functions"
- "Real-time Noise Monitor"
- "Setup Integrity Checker"
- "Initial Settings"

Measurement Range

The following ranging modes are available for performing measurement.

- FIXED (fixed range)

The channel uses the specified range only.

- AUTO (auto range)

The channel automatically uses the range which provides the best resolution for the measurement value. The auto range operation is performed as shown below.

1. Measurement is performed by using the maximum range.
2. If the measured value is $< 9.5\%$ of the range value, the channel changes the range down and performs measurement again.
3. Repeats the step 2.
4. If the measured value is $> 105\%$ of the range value, the channel changes the range up and performs measurement again.
5. Ends the measurement.

The auto-range operation coverage (maximum range and minimum range) can be specified. This reduces the number of range change operations and makes the measurement effective.

For the charge measurement (B2985A/B2987A), the auto-range operation coverage can be set to one of the following values.

HIGH: 200 nC - 2 μ C

LOW: 2 nC - 20 nC

NOTE

After the mode is changed from AUTO to FIXED

The instrument keeps the last used range. And the RANGE function key shows its value.

Automatic Ranging Speed

The following two speeds are available for the measurement auto range mode.

- Normal

Performs the basic auto-ranging operation. The channel automatically sets the range which provides the best resolution in performing the measurement.

- Fast

For performing high throughput measurement, reduces observation time to determine measurement range. This setup can be used when the measurement signal noise (superposed from AC power, etc.) is low.

This mode setting is available in the current, charge, voltage, and resistance measurement modes if the auto range is set.

Setting the Ranging Mode

- To set the ranging mode and the measurement range, see "[Range Setup Sub-panel](#)" on page 4-23.
- To set the automatic ranging speed, see "[Config key group](#)" on page 4-42.

Measurement Time

Measurement time depends on aperture time, measurement range, and other measurement conditions and is expressed by the following formula:

$$\text{Measurement time} = \text{Aperture time} + \text{Overhead time}$$

Aperture time is the time required for measurement, and does not include such factors as range change or data compensation which would be the overhead time.

Aperture Time

Aperture time is analogous to integration time, which can be described by Number of Power Line Cycles (NPLC, number of PLC). It is the period of time that the instrument's analog-to-digital (A/D) converter measures the input signal.

In general, the external noise is superposed to DC measurement signal and it affects a measurement result.

If the noise is ac noise created from the power line, it can be rejected by setting the aperture time to 1PLC. Or, if the noise is not created from the power line, the longer aperture time may be required for noise rejection.

The longer aperture time provides more accurate measurement results but with a tradeoff of measurement throughput. It is required to set the adequate aperture time for your measurement application.

If your application simply calls for a true/false or high/low voltage reading, minor noise will not be a major factor in achieving the desired value, and you can use a very small aperture time to maximize throughput. The shorter you can set aperture time the more the instrument acts like a digitizer.

Aperture time has two setting modes:

- Automatic aperture mode

Instrument automatically selects and sets optimum aperture time for performing accurate and reliable measurements. The instrument provides three types, Quick, Normal, and Stable, for the automatic setup. See [Figure 5-1](#) for image of the automatic aperture operation. Use Stable if measurement data is noisy.

Figure 5-1 Image of Automatic Aperture Operation

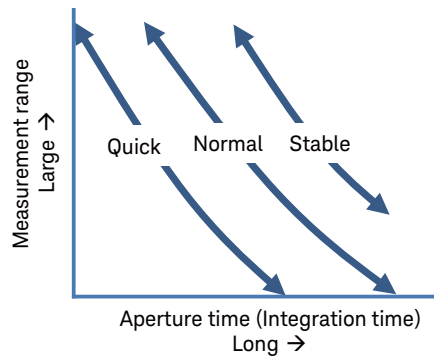

- Manual aperture mode

Instrument uses the specified aperture time. The instrument provides six values, 0.001*PLC, 0.01*PLC, 0.1*PLC, 1.0*PLC, 10.0*PLC, and 100.0*PLC. Where, PLC means power line cycle. And the value is 20 ms for the 50 Hz line frequency operation or 16.667 ms for the 60 Hz operation.

For example, if the softkey label shows 0.001 PLC, the aperture time is set to 20 μ s for the 50 Hz operation or 16.667 μ s for the 60 Hz operation.

NOTE

In the remote state, the instrument accepts the aperture time other than the six values shown above. The setting value is still effective just when the instrument is returned to the local state. Then the softkey label shows the value. However, once the Coarse Res key or the Fine Res key is pressed, only the six values are available in the local state.

NOTE

After the mode is changed from Automatic to Manual

The instrument keeps the last used aperture time. And the SPEED function key shows its value.

You can switch the auto/manual aperture mode using the SPEED function key on the Meter view. See "[Meter View](#)" on page 4-12. Use the measurement navigation keys (Coarse Res and Fine Res) to change the aperture time. See "[Measurement navigation keys](#)" on page 4-5.

Overhead Time

Overhead time is the time required for range change, etc. This time depends on the measurement condition, and cannot be specified. A major element of the overhead time is range change time during measurement (when measurement ranging mode is set to AUTO).

To Control Source/Measure Timing (B2985A/B2987A)

The voltage source output and measurement timing can be controlled by the following parameters. See [Figure 5-2](#). This figure shows an example of sweep output. For a bias output, focus the shape of a sweep step only.

1. Source delay

The source delay time is defined as the time from trigger to start of a voltage source output.

2. Measure delay

The measurement delay time is defined as the time from trigger to start of a measurement.

3. Period

The period is the trigger interval. It can be defined for the TIMER or MANUAL trigger type (trigger source) and for the voltage source output and measurement actions individually.

Figure 5-2 Voltage Source Output and Measurement Timing, Sweep Output Example

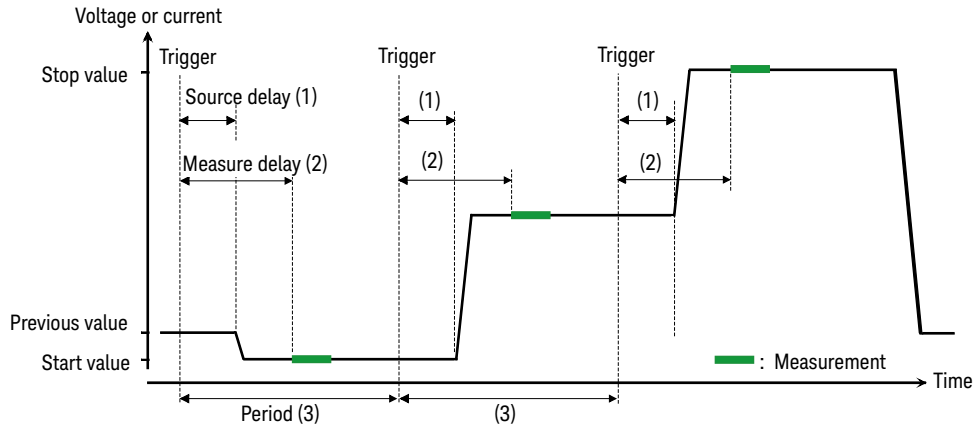

To set the delay time and the period, see ["Trigger Setup Sub-panel"](#) on page 4-28.
For more information about the trigger setup, see ["Trigger key group"](#) on page 4-53.

Null, Offset Cancel

The Null (offset cancel) function displays the measurement result based on setting the measured value under specific condition as reference. The value measured on pressing the Null key is stored as offset value, and then the value that subtracts the offset value from the actual measurement value is displayed as the measurement value. If this function is enabled, the NULL indicator turns on. If the NULL indicator turns off, the actual measurement value is displayed.

If the measurement mode is changed when the NULL indicator turns on, the NULL indicator turns off, even though the null function remains enabled. This state will be kept until the null function for the primary measurement mode is enabled.

The following sections show the usage examples of this function:

Current Measurement (B2981A/B2983A/B2985A/B2987A) and Charge Measurement (B2985A/B2987A)

1. Prepare the reference connection for measurement.

This function is used to reject the offset created from the measurement environment. So, connect the measurement cables to the instrument, and then make the measurement terminals open immediately close to the device under test (DUT).

Or, you can use this function by using the state where DUT is connected as reference state.

2. Turn the Ammeter On.
3. Press the **Run/Stop** key to perform repeat measurement.

If the measured value is not stable, adjust the measurement speed (aperture time) and the measurement filter setting.

4. Confirm that the measurement value is stable, and then press the Null key.

The NULL indicator turns on, and the null function is enabled.

To disable this function, press the Null key during Ammeter On, then the NULL indicator turns off.

Function Details

Null, Offset Cancel

For current measurement and charge measurement, the internal zero correction function can be used. This function cancels the instrument internal offset only. If you use the offset cancel function, the internal zero correction is not necessary.

To use the internal zero correction function, press the Null key when the Ammeter On/Off switch has turned off. Then pressing the Ammeter On/Off switch measures the instrument internal offset at the current measurement range and turns the Ammeter On/Off switch on. The value that subtracts the offset from the actual measurement value is displayed as measurement result. If this function is enabled, the ZC indicator is turned on (white).

The internal zero correction function is not effective for multiple measurement ranges but only for the measurement range when the Null key is pressed. The ZC indicator is turned on (white) during the measurement at this measurement range. If the range change occurs during the measurement, the ZC indicator changes to gray, and the zero correction is not applied.

Voltage Measurement (B2985A/B2987A)

1. Prepare the reference connection for measurement.

This function is used to reject the offset created from the measurement environment. So, connect the measurement cables to the instrument, and then make the measurement terminals open immediately close to the device under test (DUT).

Or, you can use this function by using the state where DUT is connected as reference state.

2. Press the Run/Stop key to perform repeat measurement.

If the measured value is not stable, adjust the measurement speed (aperture time) and the measurement filter setting.

3. Confirm that the measurement value is stable, and then press the Null key.

The NULL indicator turns on, and the null function is enabled.

To disable this function, press the Null key during Ammeter On, then the NULL indicator turns off.

Resistance Measurement (B2985A/B2987A)

If the Null key is pressed when the NULL indicator is turned off, the current resistance measurement value is set as the offset value. Just after that, the resistance measurement is performed once, and the value that subtracted the offset value from the actual measured value is displayed as the measurement result. And also the NULL indicator is turned on.

If the Null key is pressed when the NULL indicator is turned on, the null function is disabled and the NULL indicator is turned off. Just after that, the resistance measurement is performed once, and the actual measurement value is displayed.

Measurement Filter

The following three digital filters are available for reducing noise and performing precision measurement.

- Repeating average filter

This filter calculates a sum of samples in the certain range (number of samples), then divides it by the number of samples.

Assuming that the number of samples is N , the first result is an average of samples from 1st to N -th, and the second result is an average of samples from $(N+1)$ -th to $2N$ -th.

This is always an effective filter.

The number of samples is automatically decided depending on the aperture time.

- Median filter

The median filter is available only for the current measurement.

This filter is used to determine the middle-most sample from a group of samples that are arranged according to size. The group is shifted by discarding the oldest sample and adding the latest sample to calculate the middle-most sample in the new group.

Assuming that the number of samples is N , the first result is a middle-most value in the samples from 1st to N -th, and the second result is a middle-most value in the samples from 2nd to $(N+1)$ -th.

For example, if samples 1, 2, 100, 5, 6, ... is filtered with the range of three samples, the middle-most results are as follow:

1, 2, 100 → 1, 2, 100 → 2
2, 100, 5 → 2, 5, 100 → 5
100, 5, 6 → 5, 6, 100 → 6

The latest N samples are used for the calculation.

To enable this filter, open the Measure Filter dialog box by System Menu > Config > Measure > Filter operations, and set the *Median Filter (Current)* field to ON.

Number of samples (N) is defined as $N = 2 * R + 1$. Where, R is the rank value. Set it to the Rank field in the Measure Filter dialog box. It must be an integer from 0 to 15.

- Moving average filter

This filter calculates a sum of samples in the certain range (number of samples), then divides it by the number of samples. The range is shifted by discarding the oldest sample and adding the latest sample to calculate an average of samples in the new range.

Assuming that the number of samples is N , the first result is an average of samples from 1st to N -th, and the second result is an average of samples from 2nd to $(N+1)$ -th. The latest N samples are used for the calculation.

To enable this filter, open the Measure Filter dialog box by System Menu > Config > Measure > Filter operations, and set the *Moving Average (All)* field to ON.

Set number of samples to the Count field in the Measure Filter dialog box. It must be an integer from 1 to 100.

NOTE**Filter Key and FILT Indicator**

Press the Filter key to open the Measure Filter dialog box. Press OK after setting up the filter parameters in the dialog box to enable the Median and Moving Average filters and to turn the FILT indicator on.

If the FILT indicator is turned on, press the Filter key to disable the function and turn the FILT indicator off.

If the both filters are enabled, the results of the Median filter are inputted to the Moving average filter.

On the Measure Filter dialog box, which is opened by pressing the Filter key, the ON/OFF setting of each filter cannot be changed.

Analog Output

The B2980 has the Analog Out terminal on the rear panel. The Analog Out terminal always outputs a non-inverse voltage within ± 2 V range, proportional to the present measurement result for the full scale value of the measurement range. Since this output is not calibrated, the full scale of this output voltage depends on the measurement mode and the used measurement range. And also, it has maximum 10 % gain error.

The following formula is carried if the Analog Out output voltage (AOut) is 0 V when the input signal level is 0 V.

$$\text{AOut (V)} = \text{Input/Range} \times \text{AOutGain} \times 2$$

Input: Input level

Range: Full scale value of measurement range

AOutGain: Gain for the Analog Out voltage as shown in [Table 5-1](#).

Table 5-1

Output Gain of Analog Out (AOutGain)

Current Meas. Range	Gain (AOutGain)
2 pA	1.02
20 pA	1.02
200 pA	1.04
2 nA	1.02
20 nA	1.04
200 nA	0.94
2 μ A	0.93
20 μ A	1.01
200 μ A	1.03
2 mA	1.01
20 mA	1.03

Voltage Meas. Range (B2985A/B2987A)	Gain (AOutGain)
2 V	1.02
20 V	1.02

Charge Meas. Range (B2985A/B2987A)	Gain (AOutGain)
2 nC	0.93
20 nC	0.94
200 nC	0.93
2 μ C	0.94

NOTE

Use the fixed measurement range when you use the Analog Out terminal.

For example, if the input current is -20 pA when the measurement range is 20 pA , the output voltage at the Analog Out terminal is $-2.04\text{ V} \pm 0.204\text{ V}$.

You can specify the measurement mode that is applied to the analog output function using the Analog Signal Output field in the Input Connection dialog box opened by System Menu > Config > Measure > Connection operations. See ["Input Connection dialog box" on page 4-45](#).

[Figure 5-3](#) shows an example of the connections to a recording device such as chart recorder using the Analog Out terminal.

The output impedance of the Analog Out terminal is $1\text{ k}\Omega$. To minimize the effects of loading, connect a measurement device that the input impedance should be as high as possible. For example, If a device with an input impedance of $10\text{ M}\Omega$ is connected, the error due to loading will be approximately 100 ppm .

Figure 5-3 Connections of Analog Out Terminal

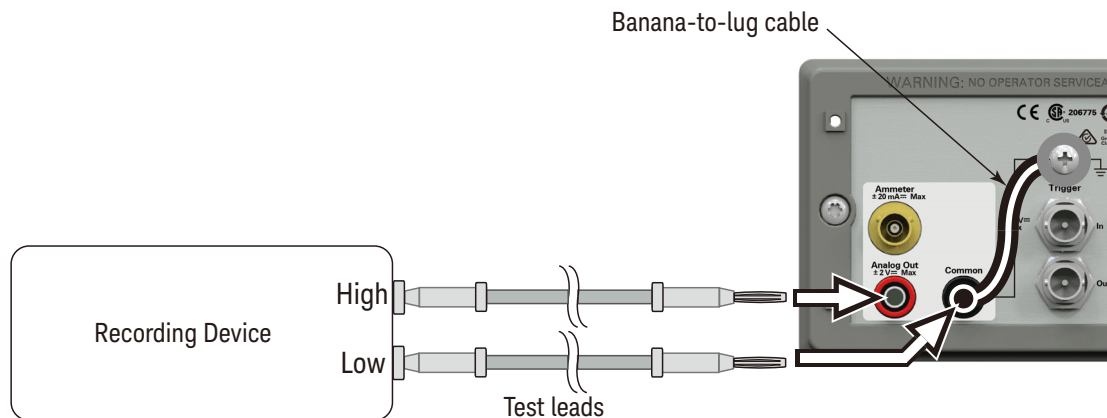

CAUTION

Do not connect the Analog Out terminal to earth while floating the input. It may damage the instrument.

Voltage Source (B2985A/B2987A)

Voltage source on B2985A/B2987A can apply not only a constant voltage but also a staircase voltage, a list sweep voltage, and a square waveform voltage.

Staircase Sweep Output

Voltage source supports two shapes of staircase sweep output, as shown in [Figure 5-4](#). The B2985A/B2987A can perform the measurement for each sweep step while the voltage source performs the sweep output, as shown in [Figures 5-2](#) and [5-4](#).

Figure 5-4

Staircase Sweep Outputs

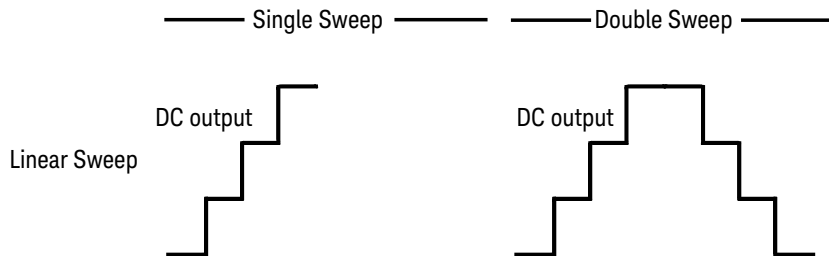

Remember the following points when setting the staircase sweep output.

- To set the staircase sweep source, see "[Source Function Sub-panel \(B2985A/B2987A\)](#)" on [page 4-25](#).
- To set the ranging mode of the sweep source, see "[Sweep dialog box](#)" on [page 4-45](#).
- To set the sweep direction and the output condition after sweep, see "[Sweep dialog box](#)" on [page 4-45](#).

List Sweep Output

The list sweep function is effective for performing an arbitrary waveform output. For example, the voltage source can apply the waveform as shown in [Figure 5-5](#), and the B2985A/B2987A can perform the measurement at each output value. The source output and the measurement can be performed in the minimum interval 100 μ s.

The voltage source output and measurement timing is controlled by the trigger system. And the interval can be set to a constant value if the trigger type is set to TIMER.

To set the trigger system, see ["Trigger Setup Sub-panel" on page 4-28](#). The trigger interval is set by the Period parameter. The number of output values is set by the Count parameter.

To set the voltage source output values, use the List Sweep dialog box. See ["List sweep setup" on page 4-26](#).

[Figure 5-5](#) shows an example setup of the List Sweep dialog box with an image of the output waveform.

To set the voltage output range, use the Spot Source Range field, see ["Range Setup Sub-panel" on page 4-23](#)

Figure 5-5

List Sweep Dialog Box

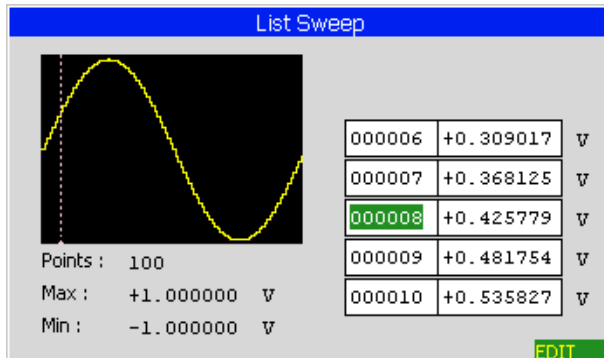

Square Waveform Output

The voltage source can also perform a square waveform output.

To set the square waveform output, see ["Source Function Sub-panel \(B2985A/B2987A\)" on page 4-25](#). [Figure 5-6](#) shows the setup parameters visually.

To set the voltage output range, use the Spot Source Range field, see "[Range Setup Sub-panel](#)" on page 4-23

Figure 5-6

Setup Parameters for Square Waveform

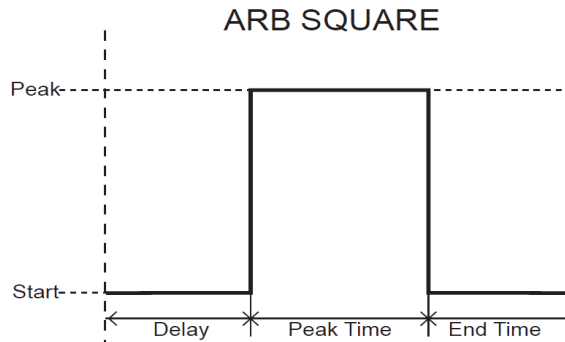

Ranging Mode of Voltage Source

The following two modes are available only when the voltage source is used as a sweep source. In other cases, only FIXED mode is available.

- **FIXED** (fixed range)
The channel uses the specified range only.
- **BEST** (best, only for the sweep source channel)
The channel automatically uses the minimum range which covers the whole sweep output.

Output-Off Status

The output-off status is automatically the condition of the voltage source, immediately after its output is turned off. The status must be specified before enabling the voltage source output. The available conditions are shown in [Table 5-2](#).

To set the output-off status, see "[Output Connection dialog box](#)" on page 4-44.

Table 5-2 **Output-Off State**

Name	Conditions after output-off
HIGH Z, high impedance	<ul style="list-style-type: none"> • Output relay: off (open) • The voltage source setting is not changed. • This status is available only when the 20 V range is used.
NORMAL	<ul style="list-style-type: none"> • Output voltage: 0 V • Output relay: off (open)
ZERO	<ul style="list-style-type: none"> • Output voltage: 0 V in the present voltage range

NOTE

This setting is not applied to the output-off process triggered by the emergency condition such as the interlock open and over temperature protection. In these situations, the output voltage is immediately set to 0 V and the output switch is set to off.

Current Limiting Resistor

The voltage source has internal 20 M Ω current limiting resistor at the output end. Connecting it in series can limit the output current. For example, if the voltage source forces 100 V, this resistor limits maximum 5 μ A output current.

You can control the connection of this resistor using the Resistive Limit State field. See "[Output Connection dialog box](#)" on page 4-44.

Triggered Voltage Source

During the voltage source applies a constant voltage, if a trigger signal is received, it changes the output to the pre-specified value. The value is specified by the Triggered Voltage Source field. See "[Range Setup Sub-panel](#)" on page 4-23.

Interlock Function (B2985A/B2987A)

The interlock function for B2985A/B2987A is designed to prevent electrical shock when a user touches the Voltage Source output terminal. If the interlock terminal is open, maximum output of the voltage source is limited to ± 21 V.

To perform high voltage measurement greater than ± 21 V, connect the interlock terminal to an interlock circuit of a test fixture or a shielding box. The interlock circuit must have one LED and two mechanical switches that are connected together and placed near the shielding box opening doors. For details on installing the interlock circuit, see "[Installing the Interlock Circuit](#)" on page 2-14.

The interlock function works as shown below.

- When the interlock terminal is open, maximum output is limited to ± 21 V.
- When the interlock terminal is shorted, voltage source can apply its maximum output value.
- When the interlock terminal is opened in a high voltage condition greater than ± 21 V, the output voltage is immediately set to 0 V and the output switch is set to off.

WARNING

Open the interlock terminal so that the voltage source cannot apply dangerous voltage when the Voltage Source output terminal is touchable or opened.

WARNING

Ouvrir la borne de verrouillage afin que le délivreur de tension ne puisse pas appliquer de tension dangereuse lorsque la borne source/de mesure est à portée de main ou ouverte.

Temperature and Humidity Measurements (B2985A/B2987A)

B2985A/B2987A can also perform external temperature measurement and relative humidity measurement. Temperature and humidity measurement results are displayed on the Meter view.

Temperature Measurement

The N1423A Type K thermocouple or equivalent can be used for external temperature measurement. The N1423A is furnished with the B2985A/B2987A. Connect the thermocouple to the Temperature Type K connector on the rear panel. Instead of the thermocouple, the thermometer in the humidity sensor can be used for the temperature measurement.

External temperature measurement is controlled (enabled or disabled) by the Temperature field settings in the Display Preference dialog box opened by System Menu > Display > Pref. operations. See ["Display Preference dialog box" on page 4-68](#).

NOTE

Always isolate the thermocouple to prevent measurement from errors. Do not expose it.

Humidity Measurement

Humidity sensor E+E Elektronik EE07 or equivalent can be used for relative humidity measurement. Connect the humidity sensor to the Humidity connector on the rear panel by using a 5-pin connector head furnished with the B2985A/B2987A and connection cable (E+E Elektronik HA010819 or equivalent). See [Figure 3-18 on page 43](#).

Relative humidity measurement is controlled (enabled or disabled) by the Humidity field settings in the Display Preference dialog box opened by System Menu > Display > Pref. operations. See ["Display Preference dialog box" on page 4-68](#).

Math Expression

B2980 provides a math function for performing calculations using the measurement result data. The calculation result can be displayed and used for the limit test and trace statistics.

For the predefined math expressions, see "[Predefined Math Expressions](#)".

To define a math expression, see the Keysight B2980 series *SCPI Command Reference*. Math expressions can be defined by using the :CALC:MATH commands. For resources effective for the expression, see "[Resources Used in the Expressions](#)".

To use the math function, see "[Math Expression dialog box](#)" on page 4-48.

To display the calculation result, see "[Graph View](#)" on page 4-31 and "[Measure Result dialog box](#)" on page 4-56.

Predefined Math Expressions

The following math expressions have already been defined in B2980. The predefined math expressions are not cleared by the power off and on operations.

- Scaling and offset (MXPLUSB)
- Reciprocal scaling and offset (MRECPXPLUSB)
- Ratio calculation (RATIO)
- Percentage calculation (PERCENT)
- Deviation calculation (DEVIATION)
- Percent deviation (PERDIV)
- Logarithmic calculation, base 10 (LOG10)
- Polynomial calculation (POLYNOMINAL)
- Sheet resistivity (SRESISTIVITY)
- Volume resistivity (VRESISTIVITY)
- Power (POWER)
- Offset Compensated Ohms (OFFCOMPOHM)
- Voltage Coefficient (VOLTCOEF)
- Varistor Alpha (VARALPHA)

In the following formula, [c] specifies the channel used for the measurement. However B2980 supports 1 only at this time. For example, the current measurement scalar data is given by CURR1 or CURR.

For the predefined math variables used in the following formula, see "[Resources Used in the Expressions](#)".

MXPLUSB

Adjust scale and offset for the current measurement data using the following formula.

$$\text{MXPLUSB} = M * \text{CURR}[c] + B$$

where, M and B are the predefined math variables.

MRECPXPLUSB

Adjust reciprocal scale and offset for the current measurement data using the following formula.

$$\text{MRECPXPLUSB} = M / \text{CURR}[c] + B$$

where, M and B are the predefined math variables.

RATIO

Calculates ratio between the current measurement data and predefined math variable data TARGET using the following formula.

$$\text{RATIO} = \text{CURR}[c] / \text{TARGET}$$

PERCENT

Calculates the percentage of the current measurement data for the predefined math variable data TARGET using the following formula.

$$\text{PERCENT} = \text{CURR}[c] / \text{TARGET} * 100$$

DEVIATION

Calculates deviation of the current measurement data from the predefined math variable data TARGET using the following formula.

$$\text{DEVIATION} = (\text{CURR}[c] - \text{TARGET}) / \text{TARGET}$$

PERDIV

Calculates percent deviation of the current measurement data from the predefined math variable data TARGET using the following formula.

$$\text{PERDIV} = (\text{CURR}[c] - \text{TARGET}) / \text{TARGET} * 100$$

LOG10

Calculates base 10 logarithm of the current measurement data using the following formula.

$$\text{LOG10} = \text{LOG}(\text{CURR}[c])$$

POLYNOMIAL

Calculates the following polynomial expression.

Function Details
Math Expression

$$\text{POLYNOMINAL} = A2 * \text{CURR}[c] * \text{CURR}[c] + A1 * \text{CURR}[c] + A0$$

where, A2, A1, and A0 are the predefined math variables.

SRESISTIVITY

Calculates sheet resistivity (Ω) from the resistance measurement data using the following formula.

$$\text{SRESISTIVITY} = \text{EPER} / \text{GLEN} * \text{RES}[c]$$

where, EPER (mm) and GLEN (mm) are the predefined math variables.

VRESISTIVITY

Calculates volume resistivity ($\Omega\text{-cm}$) from the resistance measurement data using the following formula.

$$\text{VRESISTIVITY} = \text{EAR} / \text{STH} * \text{RES}[c] / 10$$

where, EAR (mm^2) and STH (mm) are the predefined math variables.

POWER

Calculates power using the following formula.

$$\text{POWER} = \text{VOLT}[c] * \text{CURR}[c]$$

OFFCOMPOHM

Calculates offset compensated ohms (resistance) using the following formula.

$$\text{OFFCOMPOHM} = (\text{VOLT}[c][1] - \text{VOLT}[c][0]) / (\text{CURR}[c][1] - \text{CURR}[c][0])$$

where, VOLT[c][0] and CURR[c][0] are the data measured at a measurement condition, and VOLT[c][1] and CURR[c][1] are the data measured with a different measurement condition.

This function is effective for reducing measurement error in low resistance measurement.

VOLTCOEF

Calculates voltage coefficient using the following formula.

$$\text{VOLTCOEF} = (\text{RES}[c][1] - \text{RES}[c][0]) / (\text{RES}[c][1] * (\text{VOLT}[c][1] - \text{VOLT}[c][0])) * 100 \%$$

where, RES[c][0] and RES[c][1] are the resistance measurement data at the first and second measurement points, respectively, and VOLT[c][0] and VOLT[c][1] are the voltage measurement data at the first and second measurement points, respectively.

The voltage coefficient is known as the ratio of the fractional change for a resistor whose resistance varies with voltage.

VARALPHA

Calculates varistor alpha using the following formula.

$$\text{VARALPHA} = \log(\text{CURR}[c][1] / \text{CURR}[c][0]) / \log(\text{VOLT}[c][1] / \text{VOLT}[c][0])$$

where, $CURR[c][0]$ and $VOLT[c][0]$ are the measurement data at a point on a varistor's non-linear I-V characteristics curve, and $CURR[c][1]$ and $VOLT[c][1]$ are the data at the another point.

Resources Used in the Expressions

The following resources can be used in user-defined math expressions.

- Reserved variables

The variables listed in [Table 5-3](#) are reserved for reading the measurement data of voltage source output.

Scalar variable is used for spot measurement data.

Vector (array) variable is used for sweep measurement data.

- Math operators

The following operators are available.

- Arithmetic operators: +, -, *, /, ^, see [Table 5-4](#)
- Elementary functions: ln, log, sin, cos, tan, exp

The functions log and ln perform the operation after calculating the absolute value. So if a negative value is specified, they do not cause an error but calculate as a positive value. For example, $\log(-10)$ results in $\log(10)=1$.

- Math variables

You can use maximum 32 variables in the math expressions. To use the math variables, see "[Math Variable dialog box](#)" on page 4-49.

The math variables listed in [Table 5-5](#) have already been defined for the predefined math expressions in B2980. The predefined math variables are not cleared by the power off and on operations. At power-on or resetting (by the *RST command or the device clear), 0 is set for all predefined math variables.

Table 5-3 Reserved Variables

Reserved variable ^a		Description
Scalar	Vector	
CURR[<i>c</i>]	CURR[<i>c</i>][<i>i</i>]	Current measurement data
CHAR[<i>c</i>]	CHAR[<i>c</i>][<i>i</i>]	Charge measurement data (B2985A/B2987A)
VOLT[<i>c</i>]	VOLT[<i>c</i>][<i>i</i>]	Voltage measurement data (B2985A/B2987A)
RES[<i>c</i>]	RES[<i>c</i>][<i>i</i>]	Resistance measurement data (B2985A/B2987A)
SOUR[<i>c</i>]	SOUR[<i>c</i>][<i>i</i>]	Voltage source output setting data (B2985A/B2987A)
TIME[<i>c</i>]	TIME[<i>c</i>][<i>i</i>]	Time (timestamp) data
TEMP[<i>c</i>]	TEMP[<i>c</i>][<i>i</i>]	Temperature data (B2985A/B2987A)
HUM[<i>c</i>]	HUM[<i>c</i>][<i>i</i>]	Humidity data (B2985A/B2987A)

a. The numeric suffix [*c*] is effective for specifying the channel. However B2980 supports 1 only at this time. For example, the current measurement scalar data is given by CURR1 or CURR.

Table 5-4 Arithmetic and Unary Operators

Priority of task	Operator	Description
High	()	Parentheses
⋮	+ and -	Unary plus operator and unary minus operator
⋮	^	Exponentiation operator
⋮	* and /	Multiplication operator and division operator
Low	+ and -	Additive operator and subtraction operator

Table 5-5 **Predefined Math Variables**

Name	Description
M	Scale factor
B	Offset
A0	Scale factor for 0 dimension
A1	Scale factor for 1 dimension
A2	Scale factor for 2 dimension
TARGET	Target value for percentage, deviation, or ratio calculation
EPER	Electrode perimeter
GLEN	Electrode gap
EAR	Electrode area
STH	Sample thickness

Limit Test

Limit test is a pass/fail judgment performed for a measurement data or math result data obtained by a channel. It can be performed if both individual limit test and composite limit test are set to ON. Maximum of twelve limit tests can be defined and used for the bins of composite limit test.

Composite limit test supports the following two operation modes.

- Grading mode
Performs limit test for up to 12 test limits (bins) until a failure is detected. See [Figure 5-7](#) for an example flowchart.
- Sorting mode
Performs limit test for up to 12 test limits (bins) until a pass is detected. See [Figure 5-8](#) for an example flowchart.

It also supports the following communication functionality via the Digital I/O connector and can classify test devices using the component handler.

- Receiving the SOT (start of test) strobe pulse
- Transmitting the EOT (end of test) strobe pulse
- Transmitting the BUSY signal
- Transmitting the bit pattern to show a pass/fail judgement result

In the figures, SOT is the start-of-test strobe pulse sent by the component handler connected to B2980 via the Digital I/O connector.

To set the composite limit test, see "[Composite Limit Test Setup dialog box](#)" on [page 4-49](#).

To set the individual limit tests, see "[Limit Test Setup dialog box](#)" on [page 4-51](#).

The composite limit test result Pass or Fail is displayed with the measurement result data on the Meter view. To display the limit test result log, see "[Limit Test Result dialog box](#)" on [page 4-56](#).

NOTE

Limit test for the math result

If the math expression contains a vector operation, the acquire trigger count must be equal to or greater than the maximum number of the vector.

Figure 5-7

Limit Test Flowchart Example for Grading Mode

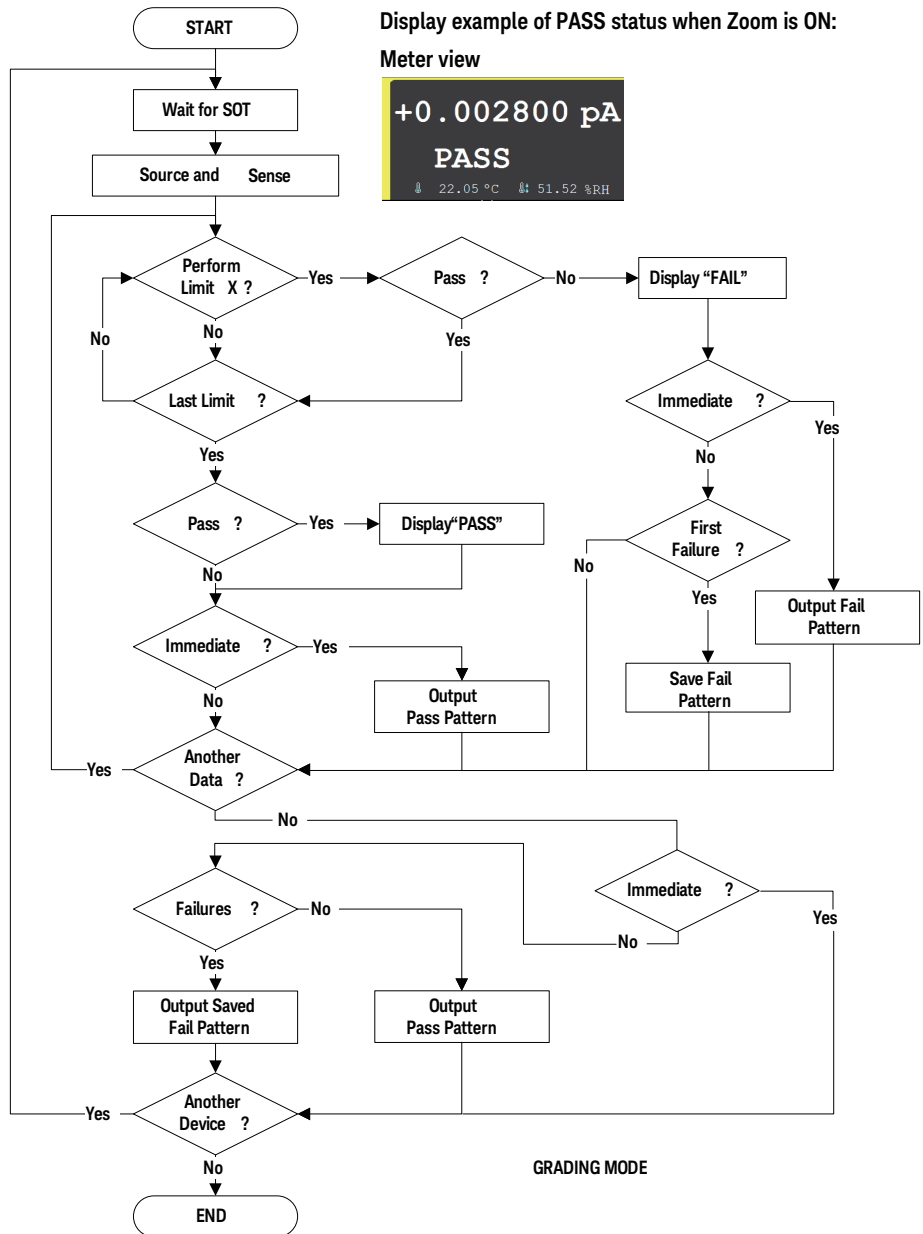
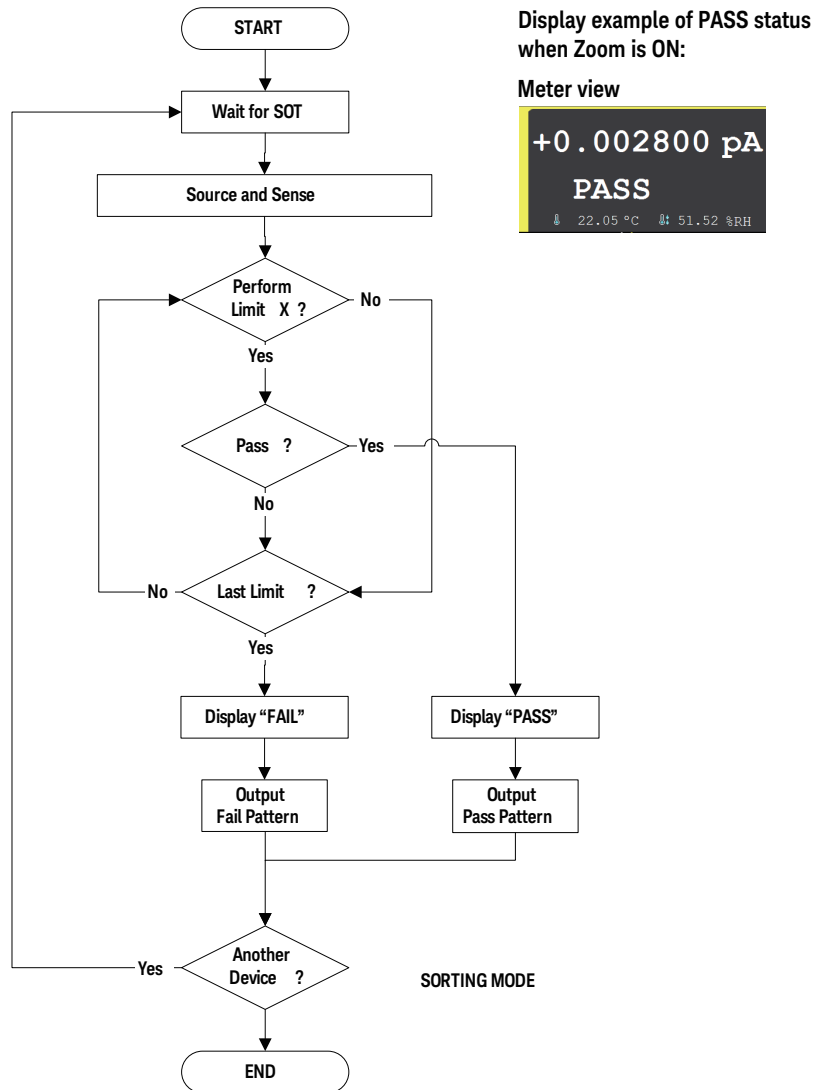

Figure 5-8

Limit Test Flowchart Example for Sorting Mode



Trace Buffer

The trace buffer collects the test result data until a full buffer is detected. The maximum data size is 100,000 blocks. The data flow is shown in [Figure 5-9](#). One data block may contain multiple data, such as current measurement data, charge measurement data, voltage measurement data, resistance measurement data, voltage source output data, calculation result data, limit test data, time data, temperature data, humidity data, and status data. They are selected by using the Format keys of the I/O key group. See "[I/O key group](#)" on [page 4-61](#).

For setting the trace buffer, see "[Trace Buffer Setup dialog box](#)" on [page 4-52](#).

In [Figure 5-9](#), the variables indicate the following data.

- VOLT: Voltage measurement data (B2985A/B2987A)
- CURR: Current measurement data
- CHAR: Charge measurement data (B2985A/B2987A)
- RES: Resistance measurement data (B2985A/B2987A)
- TIME: Time data (timestamp of the measurement start trigger)
- STAT: Status data or limit test status
- SOUR: Voltage source output data (B2985A/B2987A)
- CALC: Math (calculation) result data or limit test data (= raw data - offset data)
- TEMP: Temperature data (B2985A/B2987A)
- HUM: Humidity data (B2985A/B2987A)

If data is stored in the trace buffer, its statistical data can be calculated. Calculable statistical data is as follows.

- MEAN: Mean value
- SDEV: Standard deviation
- MIN: Minimum value
- MAX: Maximum value
- PKPK: Peak to peak value
- BIN: Bin number

Function Details
Trace Buffer

The statistical data (except for PKPK and BIN) of CURR, CHAR, VOLT, or RES data can be displayed on the Trace Statistical Result dialog box. See "[Trace Statistical Result dialog box](#)" on page 4-57 for displaying the data.

Use an external computer to display the data which cannot be displayed on the B2980 screen. The data can be saved in a USB memory connected to the front panel USB-A connector or can be read by using SCPI commands.

NOTE

Do not forget to save or read the data before turning the B2980 off. The trace buffer is cleared by turning the instrument off.

Figure 5-9 Data Flow to Trace Buffer

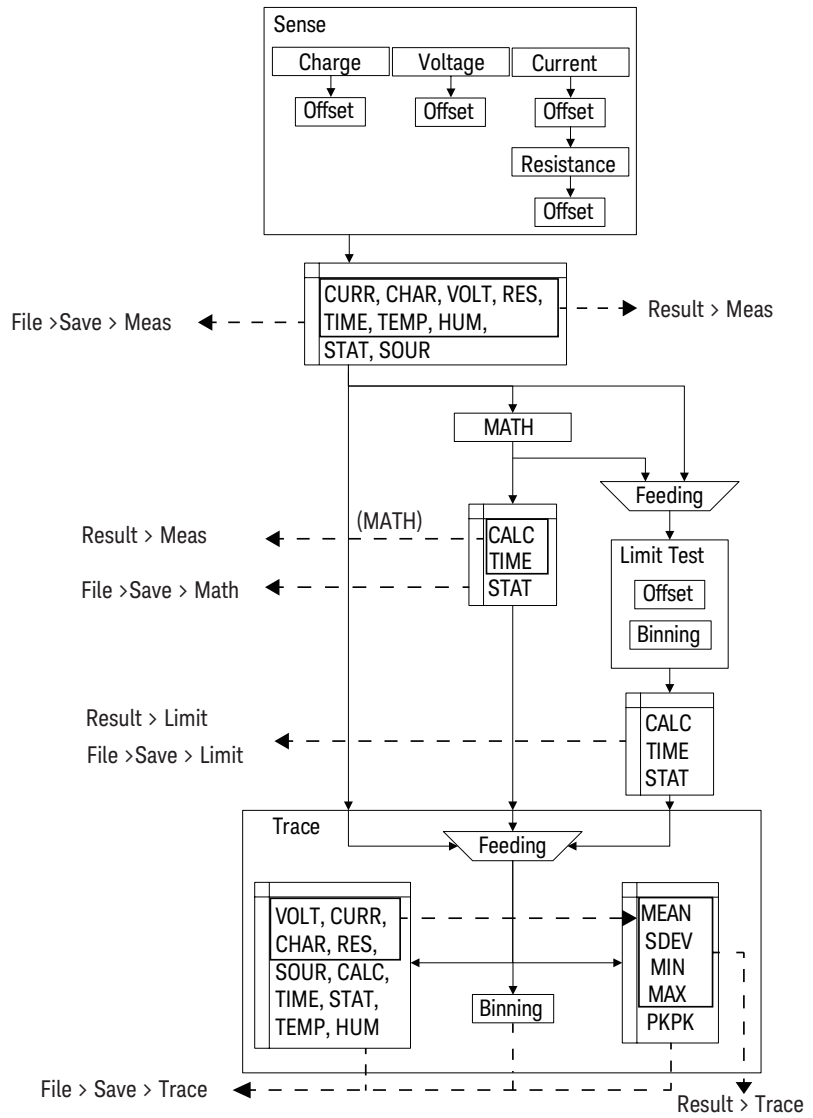

Program Memory

The program memory temporarily stores command strings. The stored program can be executed by using the front panel keys, or automatically when B2980 is turned on. See "[Program key group](#)" on page 4-60 and "[Start-up](#)" on page 4-71. The keys used for controlling the program memory are shown in [Table 5-6](#). This table also shows the status changed by pressing the program control keys.

The program memory can eliminate several processes in the program execution, such as transferring commands, checking command syntax, and converting commands to the internal codes. Thus, using the program memory speeds up program execution. If frequently used command strings are stored in the program memory, interface/computer activity is minimized.

The program memory can be defined by using SCPI commands while B2980 is in the remote mode. See Keysight B2980 series *SCPI Command Reference*.

- Number of programs saved in the memory: 100
- Number of programs used for start-up automatic execution: 1
- Total memory size: 100 KB
- Maximum length for a line: 256 bytes
- Maximum number of characters of program name: 32 with alphabets, numbers, hyphens, and underscores

Table 5-6

Program Control Keys (Function Keys) and Status Changes

Control key	Present execution status		
	Running	Paused	Stopped
Run	Error	to Running	to Running
Pause	to Paused	Paused	Stopped
Step	Error	to Running to Paused	to Running to Paused
Stop	to Stopped	to Stopped	Stopped
Continue	Error	to Running	Error

Trigger System

B2980 supports the ARM-TRIGGER model described in *1999 SCPI Command Reference*. Operation summary of this trigger model is described below. Also see [Figure 5-10](#).

The trigger system can be initiated by pressing the Single key on the front panel.

For the trigger setup parameters, see "[Trigger Setup Sub-panel](#)" on page 4-28 and "[Trigger Configuration dialog box](#)" on page 4-53.

1. Moves to the ARM layer if the trigger system was initiated.
2. Waits for the ARM event which is a signal from the ARM trigger source.
3. Moves to the TRIGGER layer if the ARM event was detected and the ARM delay time elapsed.
4. Waits for the TRIGGER event which is a signal from the TRIGGER trigger source.
5. Executes the device action if the TRIGGER event was detected and the TRIGGER delay time elapsed.
6. Repeats 4 and 5 until the TRIGGER count reaches the specified count. And then moves to the ARM layer.
7. Repeats 2 to 6 until the ARM count reaches the specified count. And then moves to the Idle layer.

This trigger model is applied to two device actions, Transient (voltage source output for B2985A/B2987A) and Acquire (measurement) independently. Two actions can start simultaneously or separately.

NOTE

Run/Stop key

The Run/Stop key sets the operation of the trigger system to AUTO or off.

In the AUTO status, this instrument repeats measurement (Acquire device action) under the predefined trigger conditions. The Transient device action is not performed.

For the predefined trigger conditions, see "[Run/Stop](#)" on page 4-4.

Figure 5-10 B2980 Trigger System

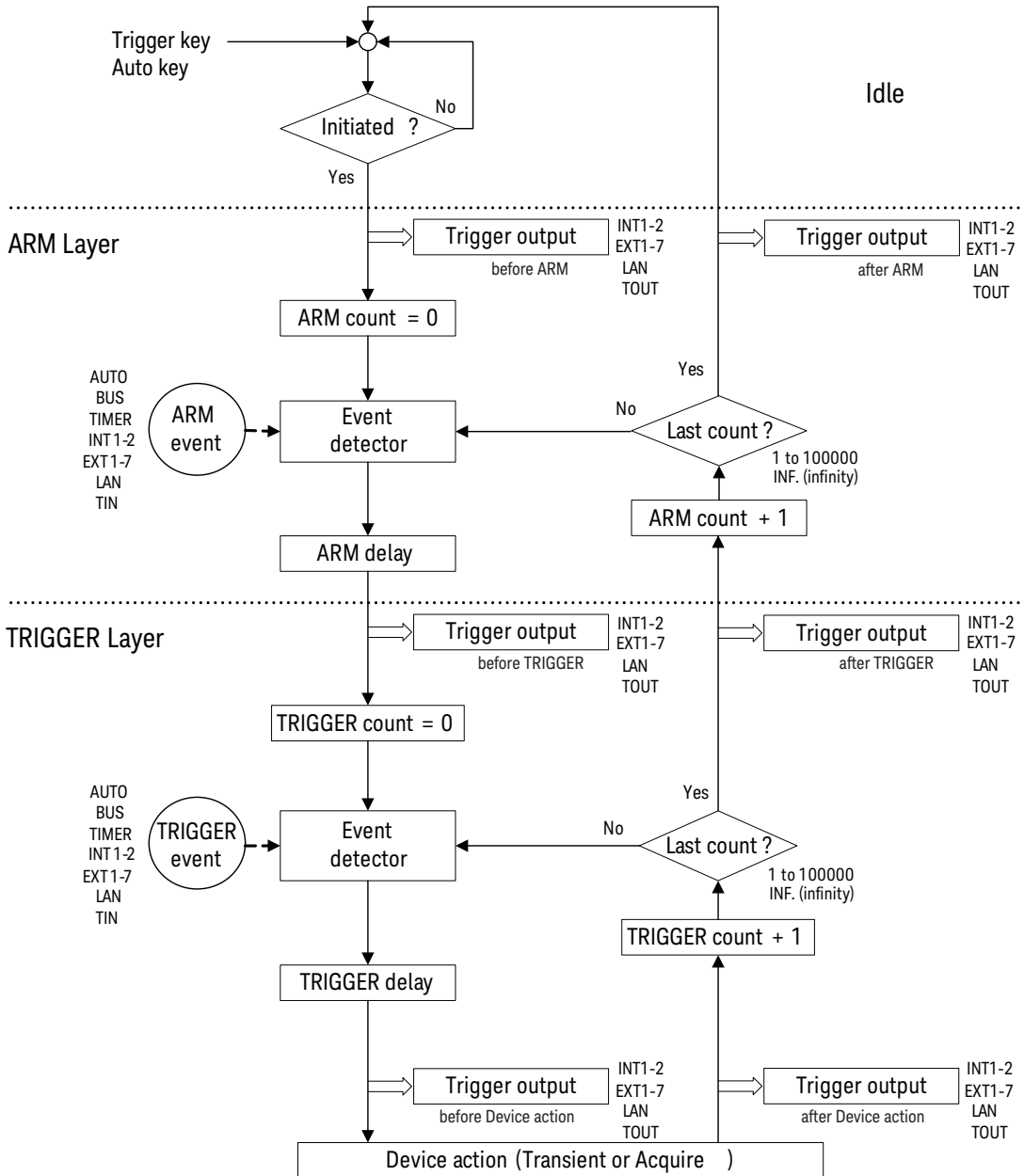

Trigger Source

B2980 supports the following trigger sources. The trigger source must be set to the ARM event and the TRIGGER event individually.

- AUTO (automatic internal, AINT): Trigger source best suited for the present operating mode is automatically selected by the internal algorithms.
- BUS: Remote interface trigger command such as GET, TRIGger, and *TRG
- TIMER (timer, TImer): Signal internally generated every interval set by the Period field
- INT1 or INT2 (internal): Signal from the internal bus 1 or 2
- EXT1, EXT2, EXT3, EXT4, EXT5, EXT6, or EXT7 (external): Signal from the DIO pin n , which is an I/O port of the Digital I/O D-sub connector on the rear panel. $n=1$ to 7
- LAN: LXI trigger
- TIN: Signal from the Trigger Input connector

Device Actions

B2980 supports the following device actions. Also see [Figure 5-11](#).

- Transient device action (voltage source output for B2985A/B2987A)
Voltage source channel starts voltage output for applying one output value if the TRIGGER event was detected and the Source delay time elapsed.
- Acquire device action (measurement)
Measurement channel starts measurement for obtaining one measurement data if the TRIGGER event was detected and the Measure delay time elapsed.

Figure 5-11

Transient and Acquire Device Actions

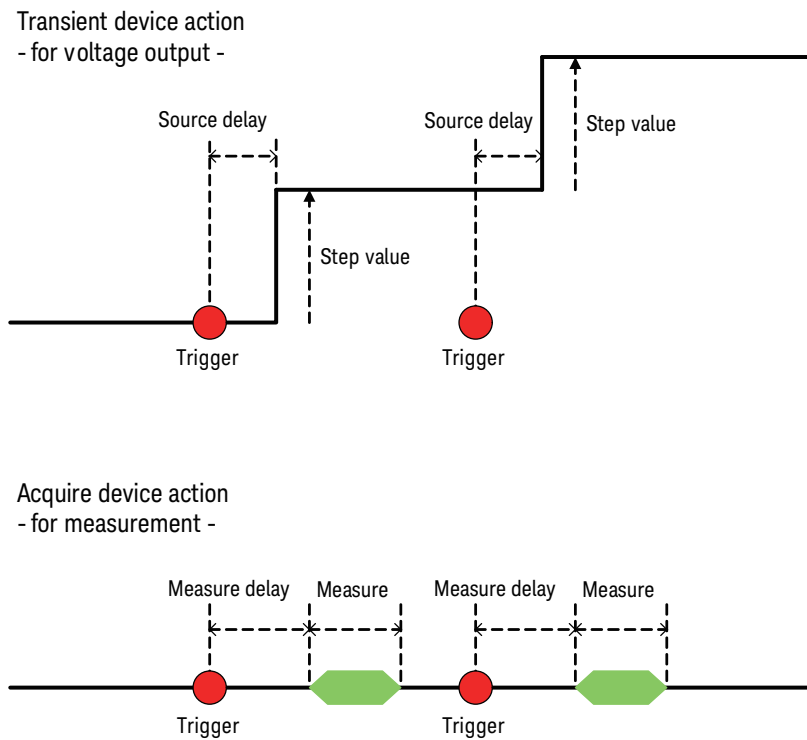

Trigger Output

B2980 can output trigger at the timing of *Trigger output* shown in [Figure 5-10](#). The trigger output terminal can be selected from the following terminals.

- Internal bus, INT1, INT2
- LAN port
- Digital I/O pin, EXT1, EXT2, EXT3, EXT4, EXT5, EXT6, EXT7
- Trigger Output connector, TOUT

The trigger output can be set by using "[Trigger Configuration dialog box](#)" on [page 4-53](#). The trigger output timing and the setup parameters are shown in [Table 5-7](#).

Table 5-7 Trigger Output Timing and Setup Parameters

Trigger output timing	Layer	Action	Trigger Output	Output Trigger Timing
Starting ARM loop	ARM	TRANS. for transient action or ACQ. for acquire action	ON	BEFORE
Ending ARM loop	ARM		ON	AFTER
Starting TRIGGER loop	TRIGGER		ON	BEFORE
Ending TRIGGER loop	TRIGGER		ON	AFTER
Starting Transient device action	ACTION	TRANS.	ON	BEFORE
Ending Transient device action	ACTION	TRANS.	ON	AFTER
Starting Acquire device action	ACTION	ACQ.	ON	BEFORE
Ending Acquire device action	ACTION	ACQ.	ON	AFTER

For using a digital I/O pin, it is necessary to set function of the pin, output trigger polarity, type, pulse width, and the Output Trigger Timing parameter. See "[DIO Configuration dialog box](#)" on page 4-64 and "[Using Digital I/O and Trigger In/Out](#)" on page 2-24.

For using the Trigger Out connector, it is necessary to set output trigger polarity, type, pulse width, and so on. See "[BNC Configuration dialog box](#)" on page 4-66.

Save/Recall Function

This function saves/recalls the B2980's all setup information by using the front panel Save and Recall keys. Five storage areas are available in the built-in non-volatile memory (NVRAM) for this function.

Press the Save or Recall key to display five function keys used for selecting the storage area. Press a function key to save or recall the setup information.

The label <Empty> is set to the key for the unused storage area and the label HH:MM:SS (time) is set to the key for the used area. They are displayed on the key with a destination number (#1 to #5).

NOTE

Automatic Save/Recall function on B2983A/B2987A

Under battery operation on the B2983A/B2987A, if the battery level is less than 5 %, the instrument automatically saves all setup information and user's data to the inside hidden memory location and restores them on next power-on.

File Access Function (Easy File Access)

File access function uses MTP (media transfer protocol) to easily download B2980 files (measurement data, instrument settings, and screen images) to your PC.

To use this function, do the steps below.

1. Set ON to the Easy File Access field on the USB Status dialog box opened by System Menu > IO > USB operations.

Changing the setting needs to reboot the B2980.

2. Connect the B2980 to your PC using the furnished USB cable.

The first time you do this, a driver is installed. On subsequent plug-ins an AutoPlay dialog box will pop up on your PC screen, then you will be able to open the device to access the files that are stored on the B2980 internal memory and the USB memory connected to the B2980. The B2980 will appear as a read/writable drive on your PC's file system, and the internal memory and external USB memory will appear as sub-devices of the drive.

For more details, see `Readme.html` in the root folder in the internal memory.

NOTE

To control the B2980 using a PC, it must be installed with Keysight IO Libraries Suite or equivalent. However, it is not required if you do not do remote control or if you use the file access function in manual operation.

PLC Detection and Setup Functions

B2980 can automatically detect the power line frequency when B2980 is turned on. This is called a Power-on PCL Detection function. The frequency (50 Hz or 60 Hz) detected and set automatically can be checked by the function key displayed by System Menu > System > PLC operations.

You can enable or disable this function using the Power-on PLC Detect field in the System Start-up dialog box.

You can also perform the power line frequency detection as needed, or set 50 Hz or 60 Hz to the PLC value forcibly. Use the function keys displayed by System Menu > System > PLC operations.

Real-time Noise Monitor

This section explains about the Real-time Noise Monitor.

The real-time noise monitor shows current noise under your current environment and condition for the current measurement. Current noise is background measured, and it is shown on the graph in real time.

You can check the following matters using the real-time noise monitor in order to improve your current measurement environment and condition.

- Influence for current measurement by external noise
- Noise reducing effect

After completing the whole current measurement setup, start the real-time noise monitor.

To start the real-time noise monitor, press the Show Noise assist key on the Meter view.

Figure 5-12

Real-time Noise Monitor

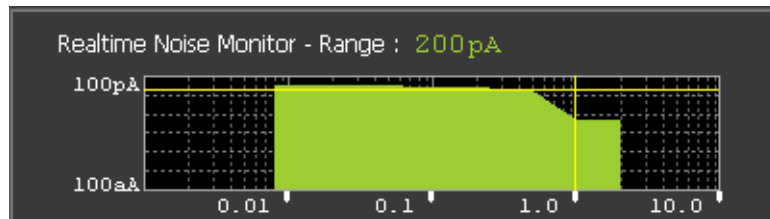

The real-time noise monitor displays the following.

- Present current measurement range
- Y axis: Variance (in A) with logarithmic scaling. (100 aA-100 pA Fixed)
- X axis: Aperture time (in PLC) with logarithmic scaling.
- Horizontal line (yellow): Measured current level
- Vertical line (yellow): Present aperture time setting
- Green area: Current noise level

To close it, press the Hide Noise assist key.

The following figures show examples of the real-time noise monitor.

Figure 5-13

Example 1

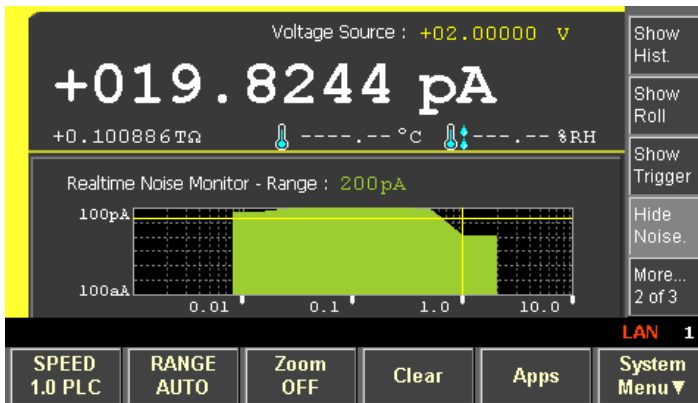

Figure 5-13 shows current noise level when the SPEED (aperture time) of the current measurement is set to 1.0PLC. You can find the following from this graph.

- If the aperture time is less than 1.0PLC, it is not suitable for the current measurement.
- If the aperture time is greater than or equal to 1.0PLC, it reduces current noise level.

Figure 5-14

Example 2

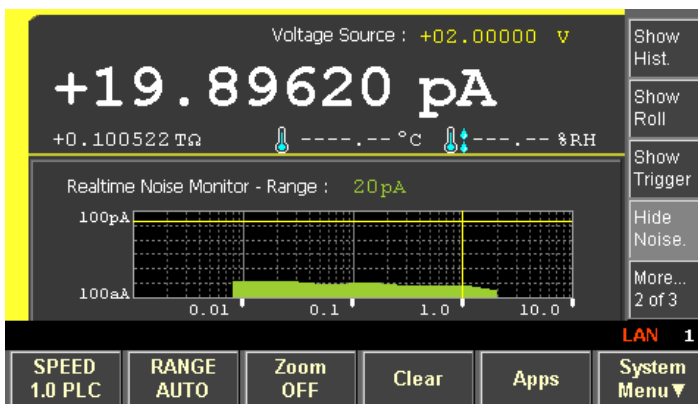

Figure 5-14 shows current noise level when a DUT is connected using shielded wires. You can find that the shielded wires reduce current noise level.

Setup Integrity Checker

This section explains about the Setup Integrity Checker and consists of the following sections:

- [Introduction](#)
- [Operation](#)
- [Performing Noise Check](#)
- [Considering Noise Reduction](#)
- [Execution Examples](#)

NOTE

The "SIC" (Setup Integrity Checker) license is required to enable this noise checking function. See "[File key group](#)" on [page 4-58](#) for the license.

Introduction

The setup integrity checker enables you to confirm the noise level (variation in current) under your measurement environment using your present measurement conditions (aperture time, measurement range, filter setting, and so on)

This function displays the Variance Ratio between the variation in current (Reference), when the input switch of the ammeter is OFF, and the current variation (Target), when the input switch of ammeter is ON, that means the noise level under your measurement environment.

The setup integrity checker is helpful for the efficient countermeasures against noise under your measurement environment. You can perform the noise checks under different measurement connections and compare the results of them to identify where the problem is. This enables you to take efficient countermeasures on your measurement environment and get the noiseless and reliable measurement data.

Operation

Figure 5-15 shows the operation of noise checker.

Figure 5-15

Operation of Noise Checker

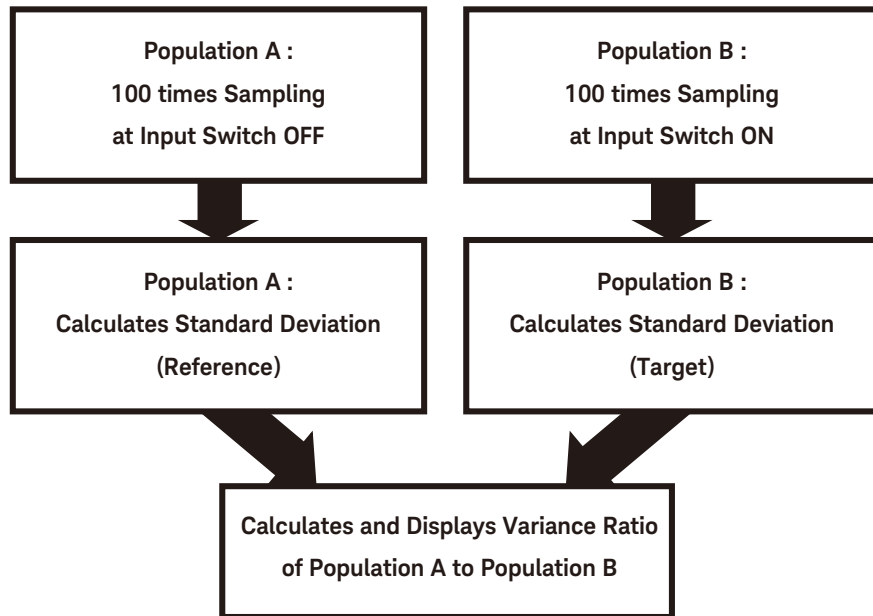

If the one-sided F testing for 95 % reliability is performed on these results and the calculated Variance Ratio is less than 1.4, the population A (Reference), where the input switch is OFF, and the population B (Target), where the input switch is ON, are deemed to be same. That means the noise level of the Target that includes your measurement environment is considered to be the same as that of Reference.

Performing Noise Check

This section explains how to perform the noise check.

Figure 5-16 Noise Checking

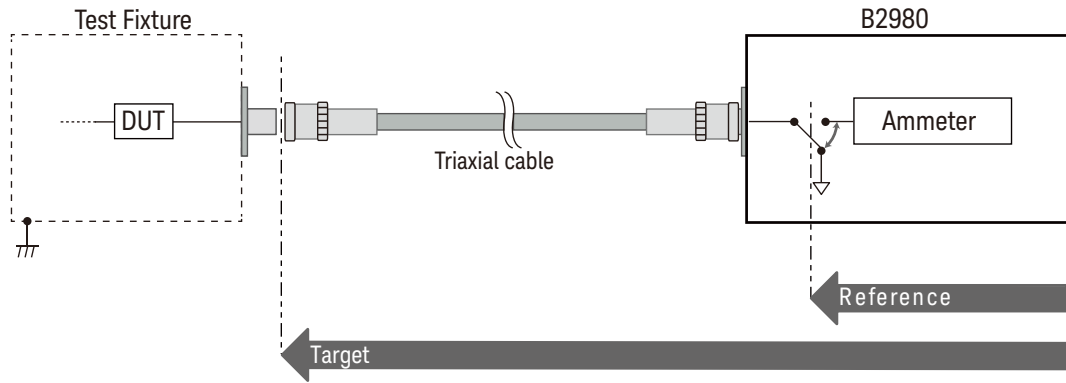

This example confirms if the Triaxial Cable is the noise source.

After completing the whole measurement setup, start the noise checking as follows:

1. Press the Apps function key on the Meter view, then press the #1 assist key. The Confirmation dialog box opens.
2. Connect the triaxial cable to the B2980 Ammeter input connector and make the other side of the cable OPEN.
3. Set the measurement range and PLC (aperture time) to Auto or your desired values.
4. Press OK (function key). The Setup Integrity Checker panel opens.
5. Press the Check assist key to start the following noise checking sequence.
 - a. Making the input switch of the ammeter ON to be under your measurement environment, and waiting for 20 seconds.
 - b. Performing the sampling measurement 100 times at 10 ms intervals, and getting and holding the target noise level (current variation under your measurement environment).
 - c. Setting the input switch of the ammeter to OFF and wait for 20 seconds.
 - d. Performing the sampling measurement 100 times at 10 ms intervals, and getting and holding the reference noise level (current variation inside the instrument).

Function Details
Setup Integrity Checker

- e. Displaying the results on the Setup Integrity Checker panel. Current results are added at the bottom line of the table.
- f. Finishing the checking with the input switch of the ammeter being OFF.

NOTE

The execution time of noise checking depends on the setting of PLC. It takes about 40 seconds at the shortest or may take longer than 6 minutes.

To abort the noise checking, press the Abort assist key.

After finishing the noise checking sequence, the following measurement results are displayed in the Setup Integrity Checker panel.

Date	Date and time when the noise check was performed
Range	Current measurement range
NPLC	PLC value (aperture time)
Reference(σ)	Reference noise level, variation in current when the input switch of the ammeter is OFF.
Target(σ)	Target noise level, variation in current when the input switch of the ammeter is ON.
Variance Ratio	Variance ratio of Target to Reference .

NOTE

Small changes or vibration of measurement environment may affect the noise level. If the measurement data can not be gotten due to these external factors, NaN (not a number) is recorded.

NOTE

The results of noise checking remain after power off. You can refer to old results of noise checking by using the rotary knob.

To delete all results of noise checking, press the System Menu > System > Factory Reset function key.

You can store the measurement results in the USB memory by pressing the Export assist key. The file name is as follows:

SIC<file created date and time>.csv

For example, when the Export assist key is pressed at 12:12:12 December 12, the file name is determined as follows:

SIC1212121212.csv

Considering Noise Reduction

The noise checking in a better measurement environment results in a smaller Variance Ratio value. To make the Variance Ratio smaller, improve your measurement environment or change the measurement condition. For example, changing the measurement cable, suppressing the external noise, considering the surrounding environment such as vibration, changing the aperture time and filter.

The effect by the countermeasure can be evaluated by the change of noise level or variance ratio.

If the measurement cable (Triaxial Cable) has the problem in the example of [Figure 5-16](#), a large noise or variance ratio should be measured when connecting only the measurement cable. In that case, changing the measurement cable, confirming the connectors, preventing the vibration on the measurement cable, or suppressing the external noise may solve the problem.

Or, you can confirm the shielding effect of the test fixture by measuring the noise level with connecting the test fixture. If the noise level or variance ratio does not reduce, the measurement cable or the shielding itself has the problem.

It is recommended to prepare several kinds and lengths of stable and shielded measurement cables that have been measured beforehand. The previously measured data is helpful to evaluate the measurement results of noise checking.

Execution Examples

例 1

Shielding Effect for the 1.5 m Triaxial Cable

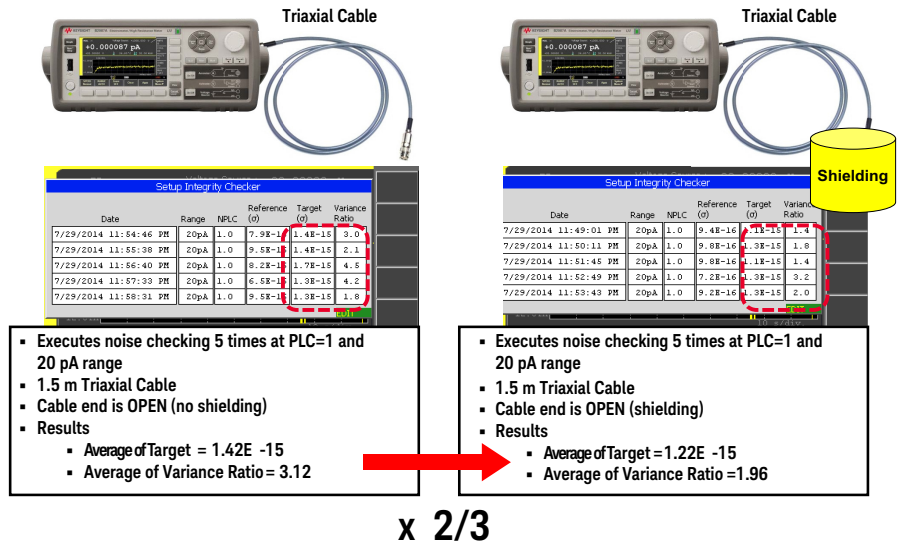

This example compares the case with connecting the Triaxial cable only (the left side in the figure) and the case with connecting the Triaxial cable and the shield case that is connected to the chassis (the right side in the figure, the core wire and inner shield of Triaxial cable are open). In the comparison, the noise checking was performed 5 times and the average of the results is calculated in both cases. The average of Variance Ratio seems to be improved by about 2/3 due to the shielding effect.

例 2

Shielding Effect for the 1.5 m Triax-Alligator Cable

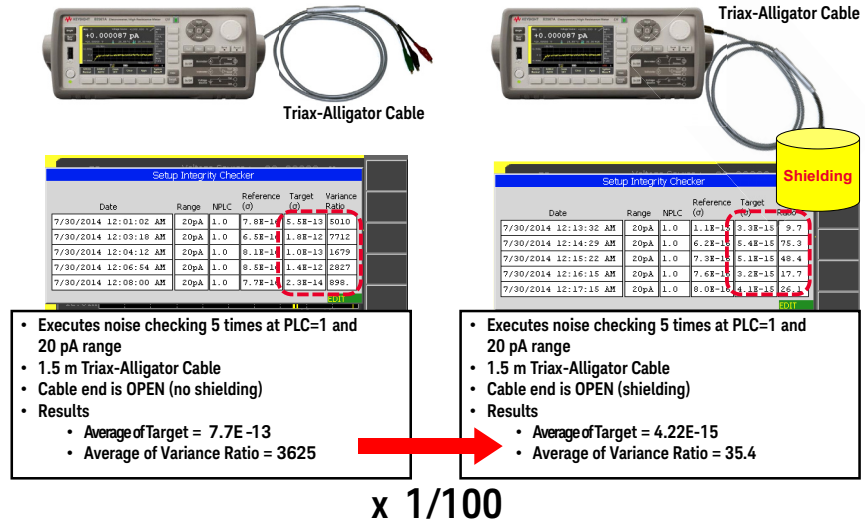

This example compares the case with connecting the Triax-Alligator cable only (the left side in the figure) and the case with connecting the Triax-Alligator cable covered by the shield case that is connected to the chassis (the right side in the figure). In the comparison, the noise checking was performed 5 times and the average of the results is calculated in both cases. The average of Variance Ratio seems to be improved by about 1/100 due to the shielding effect.

Initial Settings

The B2980 is initialized by turning it on or resetting it (by the *RST command or the device clear). Initial settings of the B2980 are shown in this section.

Table 5-8 System Initial Settings

Setup item	Power on	Reset
GPIO function	Digital In	←
GPIO polarity	Negative	←
GPIO output trigger type	Edge	←
GPIO output trigger timing	Both	←
GPIO output trigger pulse width	100 μ s	←
BNC trigger input polarity	Negative	←
BNC trigger output polarity	Negative	←
BNC trigger output type	Edge	←
BNC trigger output timing	Both	←
BNC trigger output pulse width	100 μ s	←
Byte order (measurement data)	Normal (Data Swap: OFF)	←
Data format (measurement data)	ASCII	←
Data format (GPIO data)	ASCII	←
Data format (status register)	ASCII	←
Data elements (measurement data)	All (voltage, current, resistance, voltage source output, time, temperature, humidity, status)	←
Data elements (calculate)	CALC	←
Automatic timestamp reset	ON	←
Mass storage directory	(Root)	←

Setup item	Power on	Reset
Program variables	None	Not changed
Program selection	None	←
Program status	Idle	←
Display digits	7	←
Zoomed display	OFF	Not changed
Display image format	JPG	←
User message enable	Disabled	←
User message	“”	←
Graph view, source control	OFF	Not changed
Graph view, cursor	OFF	Not changed
Graph view, reference line	OFF	Not changed
Graph view, X element (B2985A/B2987A)	SRC	Not changed
Graph view, X element (B2981A/B2983A)	t	Not changed
Graph view, X maximum	20	Not changed
Graph view, X minimum	0	Not changed
Graph view, X spacing	LINEAR	Not changed
Graph view, Y element	I	Not changed
Graph view, Y maximum	1E-4	Not changed
Graph view, Y minimum	0	Not changed
Graph view, Y spacing	LINEAR	Not changed
Histogram view, source control	OFF	Not changed
Histogram view, Y element	I	Not changed
Histogram view, Y maximum	100	Not changed
Roll view, source control	OFF	Not changed

Function Details
Initial Settings

Setup item	Power on	Reset
Roll view, cursor	OFF	Not changed
Roll view, reference line	OFF	Not changed
Roll view, X offset	0	Not changed
Roll view, Y element	I	Not changed
Roll view, Y offset (I)	0	Not changed
Roll view, Y offset (Q)	0	Not changed
Roll view, Y offset (R)	0	Not changed
Roll view, Y offset (V)	0	Not changed
Roll view, Y per division (I)	1E-15	Not changed
Roll view, Y per division (Q)	1E-10	Not changed
Roll view, Y per division (R)	1	Not changed
Roll view, Y per division (V)	1E+10	Not changed
Meter view, sub panel	ROLL	Not changed
View	Meter view	Not changed

Table 5-9 Measurement Instrument/Voltage Source Initial Settings

Setup item	Power on	Reset
Voltage source Low terminal state	CCOM (Circuit common)	Not changed
Current measure input state	OFF	←
Voltage source output state	OFF	←
Voltage source output OFF state	Normal (Output-Off State: NORMAL)	←
Voltage source	0 V	←
Voltage source range	20 V	←
Voltage source mode	Fixed	←

Setup item	Power on	Reset
Voltage sweep points	1	←
Voltage sweep start	0 V	←
Voltage sweep stop	0 V	←
Voltage list points	1	←
Voltage list values	0 V	←
Sweep direction	UP	←
Double sweep	OFF	←
Sweep ranging	BEST	←
Continuous triggered source	ON	←
Measure function	Current and voltage	←
Automatic ranging speed	Normal	←
Aperture mode	Normal	←
Auto aperture	ON	←
Aperture time	0.1 PLC	←
Voltage measure range mode	AUTO	←
Voltage measure range limit	2 V	←
Voltage measure range	2 V	←
Current measure mode	AUTO	←
Current measure range limit	1 μ A	←
Current measure range	100 μ A	←
Charge measure range mode	AUTO	←
Charge measure range limit	2 nC	←
Charge measure range	20 nC	←
Charge measure auto discharge	OFF	←

Function Details
Initial Settings

Setup item	Power on	Reset
Charge measure auto dis. level	2 μ C	←
Resistance measure range mode	AUTO	←
Res. meas. range	1 M Ω	←
Res. meas. range limit (Low)	1 M Ω	←
Res. meas. range limit (High)	1 P Ω	←
Res. meas. V select	Source	←
Res. meas. V control	Manual	←
ARB square voltage start time	100 μ s	←
ARB square voltage start level	0 V	←
ARB square voltage peak time	100 μ s	←
ARB square voltage peak level	0 V	←
ARB square voltage end time	0 s	←
Median filter	OFF	←
Median filter rank	0	←
Moving average filter	OFF	←
Moving average filter count	1	←
Null offset value	0	←
Null function	OFF	←

Table 5-10 Trigger System Initial Settings

Setup item	Power on	Reset
ARM count	1	←
ARM source	AINT	←
ARM timer	100 μ s	←

Setup item	Power on	Reset
ARM delay time	0 s	←
ARM bypass	OFF	←
Trigger count	1	←
Trigger source	AINT	←
Trigger timer	10 μ s	←
Trigger delay time	0 s	←
Trigger bypass	OFF	←
External trigger output	EXT1	←
External trigger output (LAN)	LAN0-7 (all)	←
External trigger output enable	OFF	←

Table 5-11 LXI Trigger Events Initial Settings

Setup item	Power on	Reset
Event domain	0	←
LAN event	“WaitingForAcquireArm1”, “WaitingForTransitionArm1”, “WaitingForAcquireTrigger1”, “WaitingForTransitionTrigger1”, “Measuring1”, “Settling1”	←
Delay time	0	←
Input/output filter string	“ALL:5044”	←
Input/output status	OFF	←
Input detection	RISE	←
Output drive	OFF	←
Output slope	Positive	←
Output source	“”	←

Function Details
Initial Settings

Setup item	Power on	Reset
Output timestamp delta	0	←
Event logging	ON	←
Circular event logging	ON	←
Event log size	100	←

Table 5-12 Calculate Functions Initial Settings

Setup item	Power on	Reset
Composite limit test result transfer timing	IMM	←
Composite limit test result automatic clearance	ON	←
Composite limit test fail bit pattern	All 1	←
Composite limit test pass bit pattern	All 1	←
Composite limit test mode	GRADing	←
DIO pins for bit pattern output	None	←
DIO pin for BUSY signal output	None	←
DIO pin for EOT signal output	None	←
DIO pin for SOT signal input	None	←
Limit test feed source	VOLTage	←
Limit test function	LIM	←
Upper limit	+1	←
Lower limit	- 1	←
Upper bit pattern	All 1	←
Pass bit pattern	All 1	←
Lower bit pattern	All 1	←
Limit test enable	OFF	←

Setup item	Power on	Reset
Math function enable	OFF	←
Math function expression	(M * CURR + B)	←
Math function expression name	“MXPLUSB”	←
Math function catalog	“MXPLUSB”, “MRECPXPLUSB”, “RATIO”, “PERCENT”, “DEVIATION”, “PERDIV”, “LOG10”, “POLUNOMINAL”, “SRESISTIVITY”, “VRESISTIVITY”, “POWER”, “OFFCOMPOHM”, “VOLTCOEF”, “VARALPHA”	←
Math function unit name	“”	←
Math function variable catalog	“EPER“, “GLEN“, “EAR“, “STH“	←
Math function variable value	All 0	Not changed
Offset value for test	0	←
Offset value enable	OFF	←
Trace feed source	SENSe	←
Trace control	NEVer	←
Trace points	100000	←
Trace statistics format	MEAN	←
Trace timestamp format	ABS	←
Trace bin center value	0	←
Trace bin count	10	←
Trace bin Width	0.004	←

Table 5-13 Non-volatile Communication Settings

Function Details
Initial Settings

Setup item	Factory default setting
DHCP	Enabled
IP address	169.254.5.2
Subnet mask	255.255.0.0
Default gateway	0.0.0.0
Obtain DNS server from DHCP	Enabled
DNS server	0.0.0.0
WINS server	0.0.0.0
Hostname	K-B29xxA- <i>nnnnn</i>
Desired hostname	B29xxA: model number
Desired service name	<i>nnnnn</i> : suffix of serial number.
mDNS	Enabled
Use DNS naming service	Enabled
Use NetBIOS naming service	Enabled
Domain name	Not set
GPIB address	23
LXI identify	Disabled
GPIB command interface	Enabled
USB command interface	Enabled
VXI-11 command interface	Enabled
SCPI telnet command interface	Enabled
SCPI socket command interface	Enabled
SCPI HiSLIP command interface	Enabled
Web interface (web server)	Enabled

Setup item	Factory default setting
Command prompt for a Telnet session	B2980A>
Welcome message for a Telnet session	Welcome to Keysight B2980A Series
Easy file access	OFF

Table 5-14 Other Non-volatile Settings

Setup item	Factory default setting
Remote display	Enabled
Display color set	1
Beeper	Enabled
Power-on program	Not set
Line frequency	50 Hz
Power-on PLC detection	Enabled
Voltmeter inner shield connection	GUARD
Dual measure display	Enabled
Temperature unit	°C (Celsius)
Temperature meter	Enabled
Humidity meter	Enabled
Temperature sensor	THERMOCOUPLE
Voltage source output resistor	Disabled
Voltage source realtime update (Immediate voltage update by knob)	Disabled
Measured Value Format (Meter View)	ENG. (Engineering format)

Function Details
Initial Settings

This chapter is applied to Keysight B2983A/B2987A which has the built-in Lithium-ion rechargeable battery.

- "Before Using Battery"
- "Charging Battery"
- "Safety Considerations"

NOTE

Battery supported by the B2983A/B2987A

Use a Lithium-ion battery (Keysight N1418A).

Use the B2983A/B2987A or a battery charger (Keysight N1419A) for charging the battery.

Never use other battery and charger.

Never use a modified or damaged battery and charger.

NOTE

Earthing the B2983A/B2987A

If the power cord is removed from the instrument and the battery is used for operation, connect the instrument chassis to an electrical ground through the earth (ground) terminal on the rear panel, for safety.

Use the earthing wire furnished with the B2983A/B2987A.

NOTE

When you receive the instrument

When the instrument is shipped from the factory, the battery is not installed, and it is not charged enough. So you need to charge the battery before working with the battery.

A fully charged battery will power the instrument for about 7 hours (B2983A) or 5 hours (B2987A), so if you plan to use it for this long, you should fully charge the battery.

NOTE

Automatic shutdown

When the relative battery charge drops about 5 %, the instrument will save all setup information and shut down the power to the measurement circuitry to prevent the battery from discharging to a level that is damaging. If this occurs, charge the battery.

Note that the front panel LCD will still work when this shutdown occurs.

The saved setup information will be recalled when the instrument is turned on again.

Before Using Battery

This section covers the following topics which you need to know before working with the battery.

NOTE

In an environment over +45 °C, the battery will cause the instrument shutdown without saving setup information. To avoid this, make enough space around the instrument and do not cover the instrument top and side.

- "Built-in Charge Level LED"
- "To Install Battery"
- "To Remove Battery"
- "To Maximize Battery Life"
- "Battery Charge Level Indicator"
- "Battery Care"
- "Supplemental Characteristics"

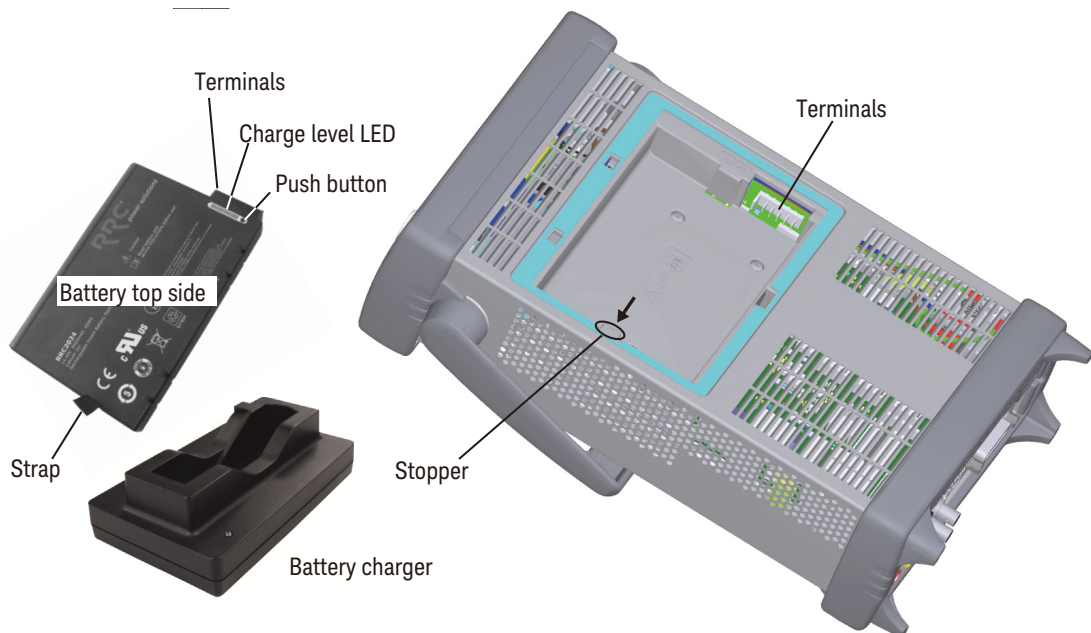

Built-in Charge Level LED

Each lithium ion battery has an LED gauge that displays its charge level. The gauge is active unless the battery is in shutdown mode.

To view the LED gauge, press the Push button on the battery. See image on the previous page.

For more information on the battery, see manual furnished with the battery (Keysight N1418A).

To Install Battery

1. Turn the instrument off and remove the power cord from the instrument.
2. Remove the battery compartment cover.

Push the stopper of the cover and pull off the cover.

3. Insert the battery.

Face the battery top to the roof, contact the battery terminals to the terminals in the compartment properly, and push the battery from the strap side. The battery will be slid into the compartment.

4. Attach the compartment cover.

Set the hook of the cover to the slit of the compartment and push the cover.

To Remove Battery

1. Turn the instrument off and remove the power cord from the instrument.
2. Remove the battery compartment cover.

Push the stopper of the cover and pull off the cover.

3. Remove the battery.

Press the stopper in the compartment and pull off the battery with the strap.

4. Attach the compartment cover.

Set the hook of the cover to the slit of the compartment and push the cover.

To Maximize Battery Life

- If AC power is continuously available, remove the battery and connect the instrument to the AC power line.
- If AC power is not continuously available, use the battery. Check the charge level indicator on the instrument front panel. If it shows low charge level, recharge the battery. See "[Charging Battery](#)" on page 6-8.
- If the instrument is not going to be used for more than a week, remove the battery. Best practice is to store the battery with a charge of 50 % to 80 %. Batteries that remain idle eventually lose their ability to hold a charge.
- Allow a battery to warm to room temperature before charging it. Temperature shock can damage the battery chemistry and in some cases cause a short circuit.
- Store batteries in a cool, dry, and low dust location, away from metal objects and corrosive gases.
- Operate the instrument on battery power in the temperature range 0 °C to +45 °C. Using the battery at lower or higher temperatures can damage it and reduce operating life. Cold temperatures affect battery chemistry, reducing charge capacity, especially below 0 °C.

Battery Charge Level Indicator

The battery charge level indicator is placed on the instrument front panel. It shows the charge level as shown in this figure.

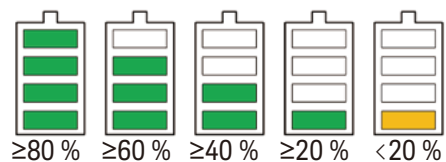

Battery Care

Visually inspect the battery periodically for signs of degradation, such as swelling, cracking of the battery shell, or leakage of fluid. If degradation occurs, replace the battery and dispose of it properly. Operation with a degraded battery could result in damage to the instrument. Also see "[Safety Considerations](#)" on page 6-9.

Supplemental Characteristics

- Charge temperature: 0 °C to +35 °C
- Discharge temperature: -20 °C to +55 °C
- Storage temperature
 - Maximum: -20 °C to +60 °C
 - Recommended: -20 °C to +25 °C
 - Extended storage at > +40 °C can degrade battery performance and life. Do not store batteries longer than 1 month in discharged state. Also do not store batteries longer than 1 year without recharge.
- Operating time: 7 hours (B2983A), 5 hours (B2987A)
- Recharging time to 100 % capacity
 - Operating: 7 hours with 1 A charge current
 - Non-operating: 3.5 hours with 2 A charge current
 - Battery charger: 3 hours with maximum charge current at +25 °C
- Battery life: > 300 cycles with minimum 75 % of initial capacity at +25 °C operating temperature, 4.6 A charge current, and 4.6 A discharge current

Charging Battery

This section describes how to charge the battery.

- ["To Use Instrument"](#)
- ["To Use Battery Charger"](#)

To Use Instrument

To charge a battery (Keysight N1418A) inside the instrument, just connect the instrument to the AC power line by using the power cord.

- When the instrument power is on, the charge level indicator on the front panel shows the present charge level.
- When the instrument power is off and the battery charging is in progress, the LED below the standby switch on the front panel turns orange.

To Use Battery Charger

Connect the battery charger (Keysight N1419A) to the AC power line and charge a battery (Keysight N1418A) as follows.

1. Connect the battery charger mains adapter to the battery charger.
2. Connect the mains adapter to the AC power line by using the power cord.

The LED is going out after the selftest of the battery charger. Then the battery charger is ready for use.

If the red control lamp remains on and no battery is in the charger, the battery charger is defective.

3. Place the battery into the battery charger.

The battery charger makes a battery recognition and initialization.

After that, leave the battery until the green control lamp lights. Green lamp means that the battery is fully charged. Then remove the battery for use.

For more information on the battery charger, see manual furnished with the battery charger (Keysight N1419A).

Safety Considerations

This section describes safety considerations for working with the battery.

- "For Battery"
- "For Battery Charger"
- "Packing and Transportation"
- "Spent Batteries"

For the additional information, see "Safety Precautions for Lithium-ion Battery" furnished with the B2983A and the B2987A. Also see manuals furnished with the battery (Keysight N1418A) and the battery charger (Keysight N1419A).

For Battery

Lithium-ion battery packs may get hot, explode, or ignite and cause serious injury if exposed to abuse conditions. Be sure to follow these safety warnings.

WARNING

Lithium-ion batteries

Must not be exposed to high temperatures (> +60 °C) or fire.

Must be kept away from children.

Must not be short circuited.

Must be replaced only with Keysight qualified Li-ion batteries.

If replaced or charged improperly, there is a danger of explosion.

WARNING

Do not connect the positive terminal and negative terminal of the battery to each other with any metal object (such as wire).

WARNING

Do not carry or store the battery with necklaces, hairpins, or other metal objects.

WARNING

Do not pierce the battery with nails, strike the battery with a hammer, step on the battery, or otherwise subject it to strong impacts or shocks.

WARNING

Do not solder directly onto the battery.

WARNING Do not expose the battery to water or salt water, or allow the battery to get wet.

WARNING Do not disassemble or modify the battery. The battery contains safety and protection devices, which if damaged, may cause the battery to generate heat, explode, or ignite.

WARNING Do not place the battery in direct sunlight, or use or store the battery inside cars in hot weather. Doing so may cause the battery to generate heat, explode, or ignite. Using the battery in this manner may also result in a loss of performance and a shortened life expectancy.

WARNING There is a danger of explosion if the battery is incorrectly replaced. Replace only with the same or equivalent type of battery recommended. Discard used batteries according to manufacturer's instructions.

WARNING If you are charging the batteries internally, even while the instrument is powered off, the instrument may become warm. Allow for proper ventilation.

WARNING Do not discharge the battery using any device except the instrument or the battery charger. When the battery is used in a device other than those specified, it may damage the battery or reduce its life expectancy. If the device causes an abnormal current to flow, it may cause the battery to become hot, explode, or ignite and cause serious injury.

WARNING Les batteries au lithium
Ne doivent pas être exposées à des températures élevées (> +60 °C) ou au feu.
Doit être hors de portée des enfants.
Ne doit pas être court-circuitée.
Doit être remplacée seulement avec la clé certifiée batteries à lithium.
Si elle n'est pas remplacée ou chargée correctement, il existe un danger d'explosion.

WARNING Ne pas brancher la borne positive et négative de la batterie l'une à l'autre avec tout autre objet métallique (câble par exemple).

-
- WARNING** Ne transportez pas ou ne stockez pas la batterie avec des colliers, des pinces à cheveux, ou tout autre objet métallique.
-
- WARNING** Ne pas : percer la batterie avec les ongles, frapper la batterie avec marteau, marcher sur la batterie, ou de tout autre manière l'exposer à des impacts ou à des chocs.
-
- WARNING** Ne pas souder directement sur la batterie.
-
- WARNING** N'exposez pas la batterie à l'eau ou à l'eau salée, ou laissez la batterie trempée.
-
- WARNING** Ne pas démonter ou modifier la batterie. La batterie contient des dispositifs de sécurité et de protection qui, s'ils sont endommagés, risquent de se dégager de la chaleur de la batterie, d'exploser ou de s'enflammer.
-
- WARNING** N'exposez pas la batterie à la lumière directe du soleil, ou n'utilisez ni rangez la batterie à l'intérieur des voitures par temps chaud. A défaut d'une telle précaution, la batterie risque de dégager de la chaleur, d'exploser ou de s'enflammer. Utiliser la batterie de cette manière peut aussi provoquer une perte de performance et une réduction de la durée de vie de ses prestations.
-
- WARNING** Il y a un risque d'explosion si la batterie n'est pas correctement remplacée. Remplacez la batterie uniquement par un modèle identique ou équivalent de batterie recommandée. Se débarrasser des batteries usagées selon les instructions du fabricant.
-
- WARNING** Si vous chargez les piles à l'intérieur, même lorsque l'appareil est hors tension, l'appareil peut devenir chaud. Pour assurer une ventilation correcte.
-
- WARNING** Ne déchargez pas la batterie à l'aide tout l'appareil, à l'exception de l'appareil ou du chargeur de batterie. Lorsque la batterie est utilisée dans un appareil autre que ceux spécifiés, cela peut endommager la batterie ou réduire la durée de vie de ses prestations. Si l'appareil provoque l'apparition d'un courant anormal pour le débit, la batterie peut alors devenir chaude, exploser ou s'enflammer et causer de graves blessures.
-

For Battery Charger

CAUTION

To charge a battery (Keysight N1418A) externally, use the battery charger (Keysight N1419A).

Never use a modified or damaged charger.

Packing and Transportation

Special precautions are required for packing and transporting Lithium-ion batteries. They are defined in IATA DGR. For details, consult your favorite transportation company.

Spent Batteries

Spent batteries must be recycled or disposed of properly according to your country's requirements. Then take action such as attaching insulation tape to the plus and minus terminals or putting a battery into a separate insulation bag.

This information is subject to change without notice.
© Keysight Technologies 2014-2019
Edition 5, April 2019



B2980-90010
www.keysight.com