

Keysight Technologies

Capacitance Leakage Current Measurement Techniques Using the B2985A/87A

B2985A/B2987A Electrometer/High Resistance Meter

Application Note

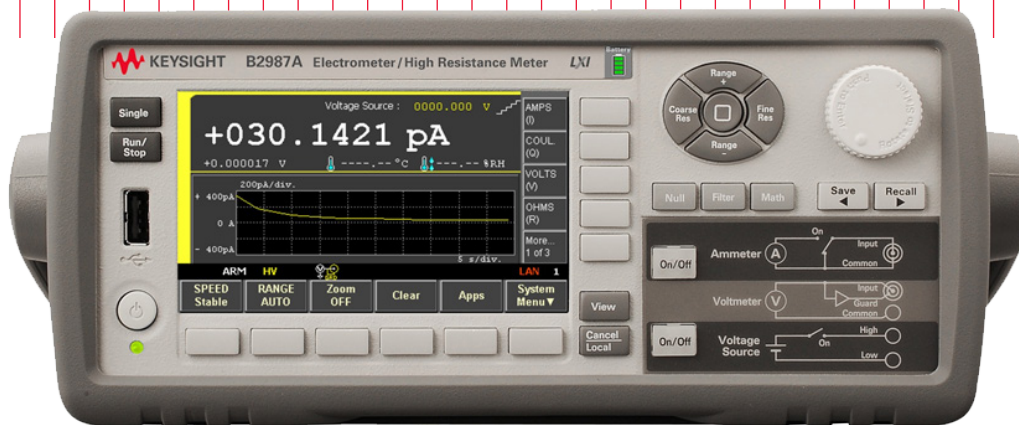

Introduction

Capacitor leakage current (I_L) is an important device parameter that can be alternatively expressed in terms of insulation resistance (R_p). These two parameters are related by the equation $I_L = V_w / R_p$, where V_w is the working voltage specification of the capacitor.

When measuring capacitor leakage current, the capacitor must be fully charged and stable at its test voltage. In addition, any error currents caused by dielectric absorption or dielectric material soakage need to be removed. To eliminate these errors, all capacitor leakage current and insulation resistance measurements require some wait time after applying a test voltage. The required wait time depends on a given capacitor's dielectric absorption characteristics.

There are a number of best practices you should follow when measuring the leakage current of a capacitor to maintain safety and to protect the measurement instruments from damage caused by electric charge stored in the capacitor.

The Keysight B2985A and B2987A Electrometer/High Resistance Meters have a built-in voltage source that can output up to 1000 V, and they also feature unmatched current measurement resolution of 0.01 fA (1E-17 A). They can cover a wide range of capacitor types, and their front panel supports four graphical-based GUI views to facilitate capacitor leakage current measurement. Both instruments are identical except that the B2987A has a rechargeable Li battery that allows it to operate without an AC power supply.

This document covers the following topics.

- Fundamentals of capacitor leakage current measurement.
- Tips for leakage current measurement and maintaining a safe work environment.
- Step by step measurement setup examples using the B2985A/87A.

Capacitor Leakage Current Measurement Basics

Leakage current components and measurement timing

Capacitor leakage current can be measured using a voltage source and an ammeter as shown in Figure 1. The leakage current I_L can be measured as,

$$I_L = V_s/R_p$$

where V_s is the test voltage of the voltage source and R_p is the insulation resistance of the capacitor. V_s is usually set at the rating voltage of the capacitor.

The measured value of capacitor leakage current depends on when the measurement is made after the test voltage is applied. The leakage current characteristics or response after a test voltage is applied depend on the values of the components comprising the capacitor's equivalent circuit. Therefore, understanding a capacitor's equivalent circuit is essential when measuring capacitor leakage current. Figure 2 shows a simplified capacitor equivalent circuit that includes the insulation resistance and dielectric absorption components.

Figure 2(a) shows the three basic elements that affect the capacitor leakage current measurement, and Figure 2(b) shows the corresponding time response image for each of these leakage current components (labeled by number).

The total leakage current flowing in the capacitor shown in Figure 2(a) consists of the following three components:

1. Leakage current flowing through the insulation resistor R_p .
This current depends on the test voltage, and the time response is flat as shown in curve number 1 in Figure 2(b).
2. Current that charges the capacitor C when a test voltage is applied to measure the leakage current.
This current is instantaneous as shown by curve number 2 in Figure 2(b).
3. Dielectric absorption current, which consists of dielectric absorption components R_d and C_d . The R_d and C_d typically generate multiple time constants (i.e. $R_d \times C_d$). The current response of this component after the test voltage is applied as shown in curve number 3 in Figure 2(b). The current magnitude is inversely proportional to the value of R_d , and this leakage current component exponentially decays to zero amperes.

The total leakage current response shown in Figure 2(b) is the sum of these three leakage current components; it converges to the current flowing through the insulation resistance which is shown by curve number 1.

Due to these waveform transients, the leakage current measurement has to be made when the charge current has stabilized into a range that is close to its final value. The dielectric absorption current shown as curve number 3 in Figure 2 depends on the characteristics of the dielectric material used in the capacitor. The absorption current can be ignored for most applications, although it is necessary to understand its behavior to determine the leakage current measurement timing.

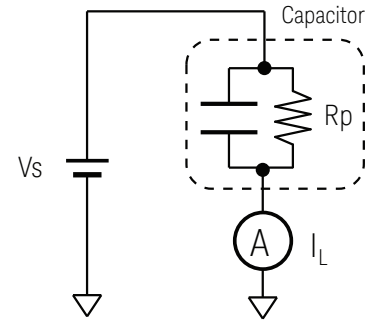
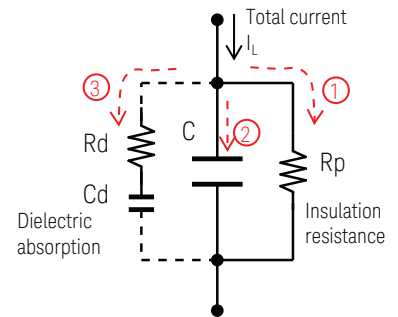
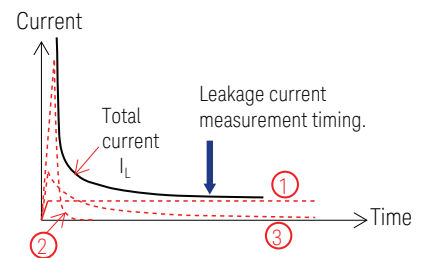

Figure 1. Basic leakage current measurement block diagram for a capacitor.



(a) Equivalent capacitor circuit for leakage current measurement



(b) Response time behavior for the various leakage components.

Figure 2. Equivalent capacitor circuit for leakage current measurement.

Test equipment setup for leakage current measurement

There are two ways to configure test equipment to measure capacitor leakage. Figure 3 shows typical test setup examples for capacitor leakage current measurement. The difference between the two test setups is whether or not the capacitor is floating or grounded (which is explained below).

Floating capacitor

The measurement scheme shown in Figure 3(a) is applicable when the capacitor is floating (i.e. both capacitor terminals are not connected to anything). In this case, one end of the capacitor is connected to the voltage source and the other terminal is connected to the ammeter (which is connected to ground).

Floating/Grounded capacitor

The measurement scheme shown in Figure 3(b) is applicable when one end of the capacitor is connected to ground. In this case, one end of the ammeter is connected in series with the output of the voltage source, and the other end of the ammeter is connected to non-grounded terminal of the capacitor. To implement this configuration, the ammeter must be able to support floating mode operation.

When implementing floating/grounded configuration, there are two issues:

- (1) The test setup is complicated.
- (2) Since the ammeter common is connected on the high side of the voltage source, hazardous high voltage can appear at the ammeter's common terminal (which creates a potential safety issue).

In addition to the above issues, the maximum test voltage is limited by the ammeter's maximum floating voltage.

Note that this configuration can be used for both floating and grounded capacitors.

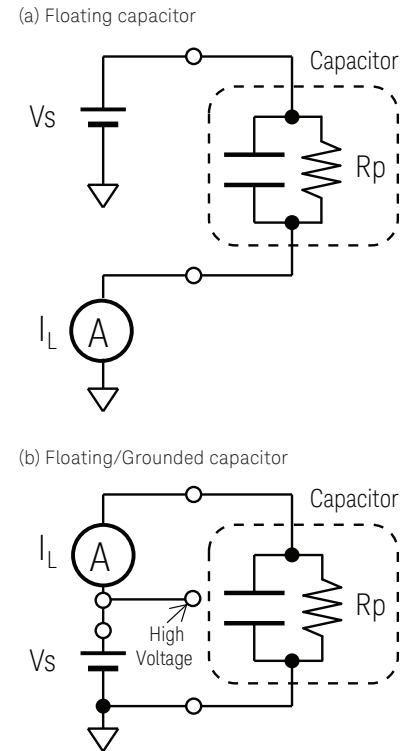

Figure 3. Leakage current test setup examples.

Leakage Current Measurement Tips and Safety

There are two important points to consider when measuring capacitor leakage current:

1. Measurement equipment instability caused by capacitive loading.
2. Potential safety issues from charge stored on the capacitor.

Most commercial precision ammeters use the negative feedback scheme shown in Figure 5. Ammeters employing this design are widely used for capacitor leakage current measurement, but they tend to exhibit unstable behavior when measuring large capacitances.

Measuring large capacitors at high voltages presents significant safety issues since the capacitor can store a significant amount of electrical energy. If the high side of the capacitor is inadvertently shorted to the ground or to the circuit common, the stored electrical energy will discharge quickly. This can be hazardous to the operator and it could also damage the ammeter if the charge current exceeds the maximum current limit of the ammeter's input protection circuitry.

This section offers suggestions to mitigate these issues.

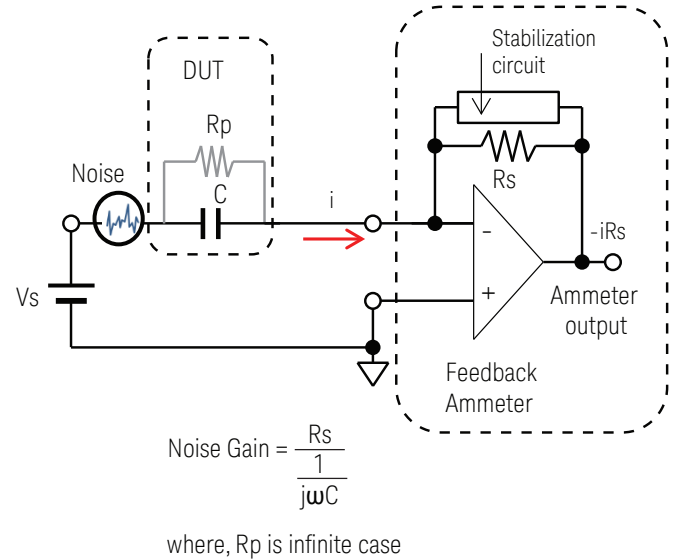

Figure 4. Simplified Noise gain of for a feedback style ammeter.

Series resistor is useful for measuring large capacitance

Most ammeters available today employ feedback circuitry similar to that shown in Figure 4. The current "i" flowing into the ammeter is converted to voltage "-i x Rs" by the feedback loop resistor Rs and the amplifier. This type of ammeter is suitable for capacitor leakage current measurement because it has a low input voltage (almost zero) and low input impedance, which provide a fast measurement response. Usually there is stabilization circuitry in the feedback loop of the amplifier that allows it to operate stably up to some capacitance value. The issue is noise, which is always present and is also amplified (refer to Figure 4). In this example the noise gain can be expressed as the ratio of the feedback resistor Rs to the ammeter impedance (which is equal to "Rs x jωC"). Since the noise increases for larger capacitor values and higher frequencies, at some point the noise exceeds acceptable limits.

For cases where the measurement data has too much noise, inserting a series resistor Rf as shown in Figure 5 can usually reduce this noise to an acceptable level. For high frequencies (where Rf >> 1/ jωC) the gain approaches Rs/Rf, which limits the noise to an acceptable level.

The cut-off frequency can be expressed as $f_c = 1/(2 \times \pi \times C \times R_f)$, and selecting a cut-off frequency of around 10 Hz is a good starting point to select a value for Rf .

Note: It is also necessary to keep the value of Rf << Rp to maintain leakage current measurement accuracy.

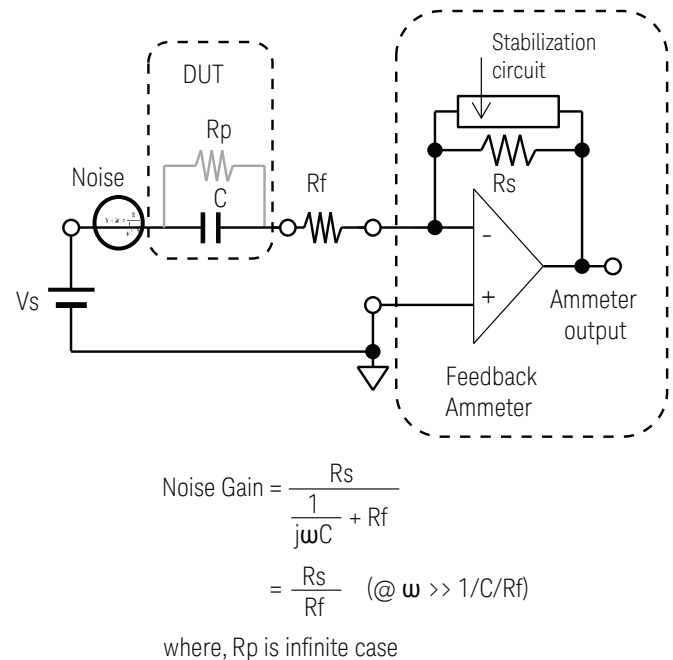

Figure 5. Rf can reduce high frequency noise gain.

Using a series resistor to prevent ammeter damage

Figure 6 illustrates a situation where the capacitor anode side is accidentally shorted during a leakage current measurement.

Consider first the situation where there is no protection resistor R_f , and the anode terminal is accidentally shorted to ground.

In this case the energy stored in a charged capacitor (which is $\frac{1}{2} \times C \times V^2$) is instantaneously applied to the ammeter. For large values of V_s and C the discharge energy may be large enough to damage the ammeter's input circuitry. However, inserting a protection resistor R_f (as shown in Figure 6) limits the maximum discharge current to V_s/R_f , thereby limiting the current flowing into the ammeter to an acceptable level.

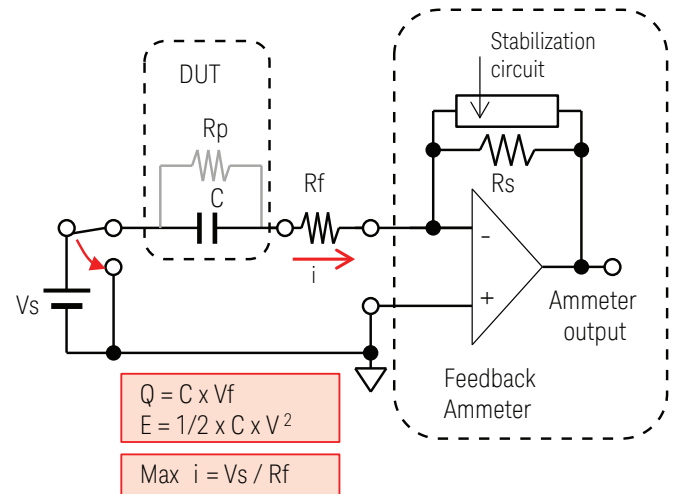

Figure 6. Charged capacitor energy and ammeter protection.

Discharge the capacitor after completion of the leakage current test for safety

A charged capacitor can contain a large amount of stored energy when the test voltage is high and/or the capacitance is large.

It is important to discharge the capacitor before removing it after completion of the leakage current test. After completing the measurement, set the voltage to zero and wait a sufficient time such that the capacitor fully discharges (including dielectric absorption charge).

It is also important to use a test fixture with a safety interlock system to protect the operator from hazardous voltages.

Use PLC averaging to reduce noise and achieve stable leakage current measurements

The following are some additional tips that can help to improve capacitor leakage current measurement results.

1. Use PLC averaging.
As mentioned previously, reducing noise when making capacitor leakage current measurements (especially for large capacitors) is very important. Power line cycle (PLC) averaging can mitigate noise effects since it helps to eliminate power line cycle noise caused by poor static shielding and capacitor vibrations (when the capacitor is large).
2. Use highest allowable current range
In general, higher current ranges are more insensitive to input noise and capacitive loading. In addition, using a higher current range helps to decrease the capacitor charging time after the test voltage is applied. If the instrument also has limited auto-ranging capability, then it is also good practice to set the range limit at the highest possible value.

Capacitor Leakage Current Measurement Example Using the B2985A/87A

Measurement resources of the B2985A/87A

Figure 7 shows a simplified schematic of the B2985A/87A's measurement resources, which consist of one voltage source (Vs), one ammeter and one voltmeter.

By default at boot-up the measurement common (Common) of the ammeter and the voltmeter are connected to the low side of the voltage source (Vs Low). However, a software command allows you to disconnect the Vs low terminal from the circuit common using an internal switch (the Vs low terminal connection switch). This allows the voltage source (Vs) and ammeter/voltmeter resources to be used independently.

The ability to float the measurement common adds flexibility to the instrument and allows it to cover a wider range of applications. For example, you can implement both configurations shown in Figures 3(a) and 3(b) (floating capacitor and grounded capacitor), which provides greater flexibility when making capacitance leakage tests.

Convenient GUI for leakage current measurement

An example of the Meter View with the Roll graph sub-panel is shown in Figure 8. The Roll graph shows past measurement data and displays current data in real time on the X-axis. This view helps with the understanding of the time-based behavior of the leakage current after the test voltage is applied (in this case for a 0.1 μF ceramic capacitor). Since leakage current measurements require some amount of wait time after applying the test voltage, the Roll View is useful to determine the necessary wait time duration.

Figure 9 shows an example of a user-defined sweep measurement displayed using the Graph view. The test sequence displayed in the Graph view is as follows: (1) application of the test voltage, (2) measurement of the leakage current over the specified interval, (3) return of the test voltage to zero volts after the final measurement and (4) the graphical display of the results in real time.

The procedure to set up the sweep and display the results in the Graph View is explained in the next section.

Capacitive load limitation

For ranges of 20 μA and below, the maximum allowed input capacitance of the B2985A/87A is 10 nF or less; for higher ranges it is 1 μF . Although it may be possible to measure leakage on capacitors that exceed these limits, the measurement noise may increase. Inserting a resistor in series with the capacitor may reduce the noise effect (as explained in the previous section).

Note that the example shown in Figure 9 shows a 0.1 μF capacitor without a series resistor. The series resistor is not required and only needs to be used when noise or other measurement issues are causing problems.

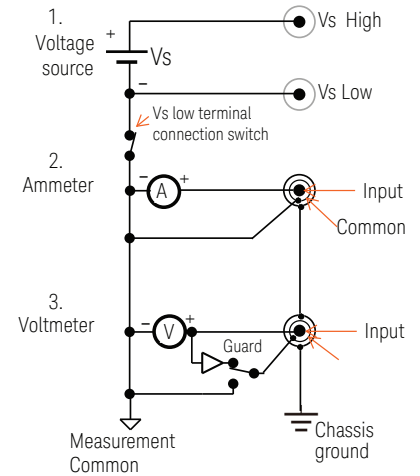

Figure 7. B2985A/87A measurement resources.

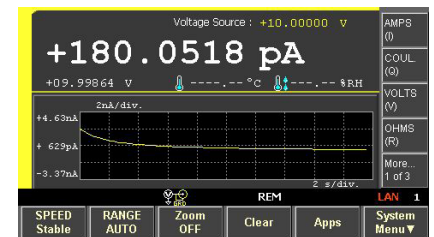

Figure 8. Meter View example with Roll graph (0.1 μF ceramic capacitor).

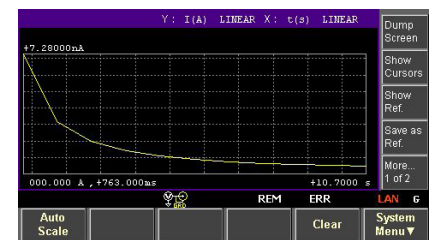

Figure 9. Time sweep leakage current measurement by Graph View.

Convenient accessory for measuring both floating and grounded capacitors

The N1414A High Resistance Measurement Universal Adapter shown in Figure 10 is convenient to have for capacitor leakage test applications. This adapter provides two main benefits:

1. You can switch easily between the floating and the grounded DUT connections shown in Figure 3 with the push of a button, thereby avoiding the need to manually change cable connections. While this adapter simplifies connectivity when making both types of measurements, the maximum test voltage for a grounded DUT connection is limited to 500 V. Note that a safe operating environment is insured by the triaxial connection scheme, which prevents contact with hazardous high voltages that appear on the ammeter common in the grounded capacitor measurement configuration.
2. The sourced voltage can be monitored using the B2985A/87A's voltmeter without changing any connections.

For details about the use of the N1414A, refer to the application brief “N1414A High Resistance Measurement Universal Adapter Simplifies High Resistance Measurement Cabling”, Keysight part number 5992-0474EN “<http://literature.cdn.keysight.com/litweb/pdf/5992-0474EN.pdf>”.



Figure 10. N1414A High Resistance Measurement Universal Adapter.

Capacitor leakage current measurement examples

This section provides step by step instructions on how to setup the B2985A/87A to measure capacitor leakage current. The following two examples are covered.

Example 1:

Interactive voltage setup and leakage current measurements.

Example 2:

Time sweep or sampling measurements for a fixed time period.

This approach is useful to measure leakage current at a specified time after applying the test voltage to the capacitor under test.

In addition to these two measurement examples, some additional capacitor leakage measurement tips (1000 V output and limited auto-range setup) are covered in the last part of this section.

To follow along with these examples, first insert your test device into a test fixture.

Note:

- (1) In this example, a 2400 pF film capacitor is used as the test device and leakage current measurements are performed at 20 V.
- (2) If more than 21 V needs to be applied then the interlock circuit needs to be properly connected.

The B2985A/87A cannot output more than 21 V if there is no interlock connection. Refer to the B2980A Series user guide for proper implementation of the interlock circuit.

Example 1: Interactive voltage application and leakage current measurements.

This first example measures leakage current while interactively changing the test voltage. The leakage current can be monitored in both digitally in the Meter View display and graphically in the Roll view sub-panel (which highlights trends). Note: This measurement uses the AUTO trigger mode to continuously trigger data measurements.

The Roll graph can be displayed in full screen mode in Roll View; it is convenient to check the leakage current behavior to help define the test conditions. By knowing the response of the capacitor after application of the test voltage, the appropriate measurement delay time, measurement range and measurement resolution can be determined.

Follow these steps by referring to the number shown in the corresponding figures.

Step 1-1. Preparation: Meter View with the roll graph

1. Press the **View** [View] key to show the View function key.
2. The View selections are shown in the function keys.
3. Press the [Meter View] function key.

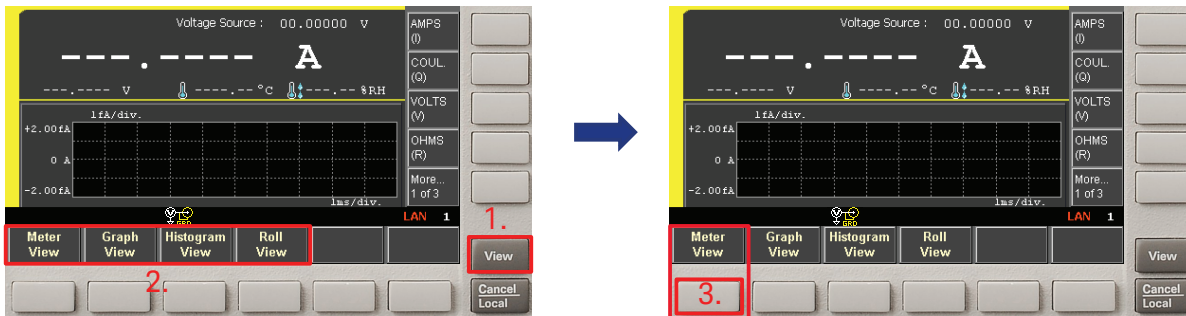

Step 1-2. Preparation: Set 0 V before measurement

1. Make sure the voltage is set to "0 V".
If the voltage is not 0 V, perform the following operations.
2. Change to the [More... 3 of 3] assist keys group by pressing [More ... 1 of 3] assist key.
3. Press the [Source] assist key to move the field pointer onto the Voltage source field.
4. Set "0" V in the Voltage Source field.
5. Then use the  [knob] (press) and/or [V] assist key to save the change.

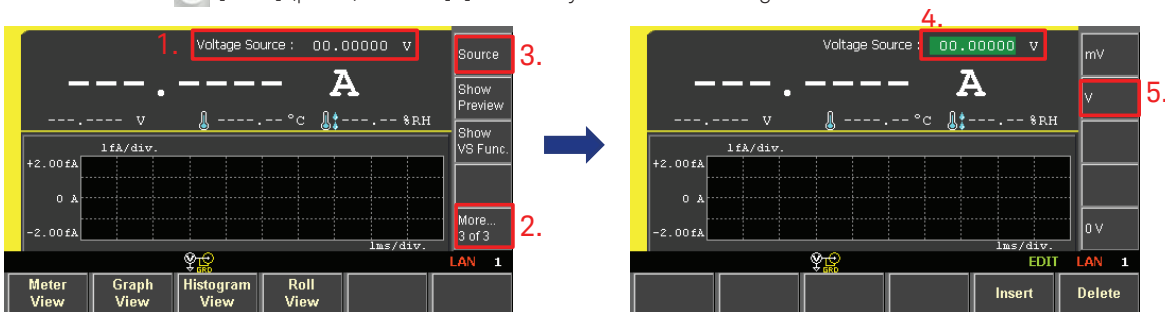

Step 1-3. Turn on the voltage source and the ammeter

1. Press the Voltage Source [On/Off] switch to enable the output.
2. Press the Ammeter [On/Off] switch to enable Ammeter.

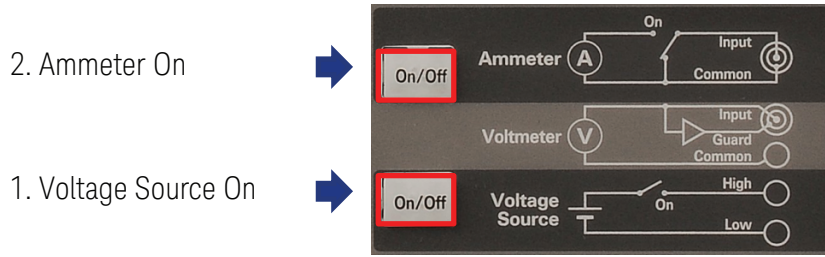

Step 1-4. Make the leakage current measurement

1. Press the **Run/Stop** [Run/Stop] key to start the repeat measurement. The AUTO indicator lights up when making repeat measurements.
2. Current measurements are performed repeatedly and a record of the measurement data is shown in the condensed roll graph.

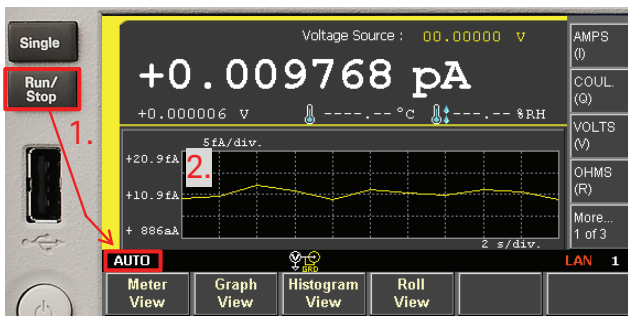

Step 1-5. Monitoring the leakage current after changing the test voltage

1. Move the pointer onto the "Voltage Source" input field by turning the **[Knob]**, then press the **[Knob]** to change the input to "EDIT" mode. Move the voltage digit pointer to the 10 V position by pressing the **Save** [left arrow key].
2. Turn the **[knob]** to the right, and set the voltage source to 20 V. The output changes in real time to the voltage shown in the display.
3. The roll graph shows the changes in the ammeter current after the voltage source has been changed.

The ammeter's roll graph shows the transient currents when the voltage changes to 20 V, which consists of dielectric absorption current and leakage current. A total current of 0.89 pA is shown in the display at about 14 seconds (reading from the graph).

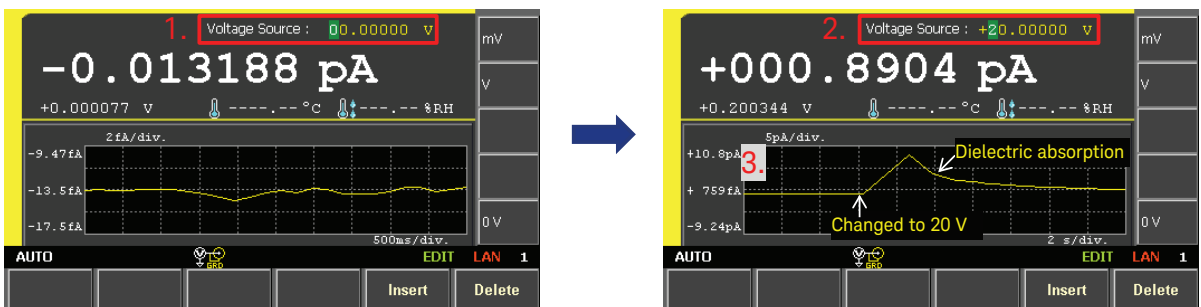



Step 1-6. Apply 0 V after the test

Caution: Set the voltage to zero volts and wait for a while before removing the capacitor!

1. Set the Voltage Source voltage to 0 V after completing the capacitor leakage current test but before removing the capacitor from the test fixture.

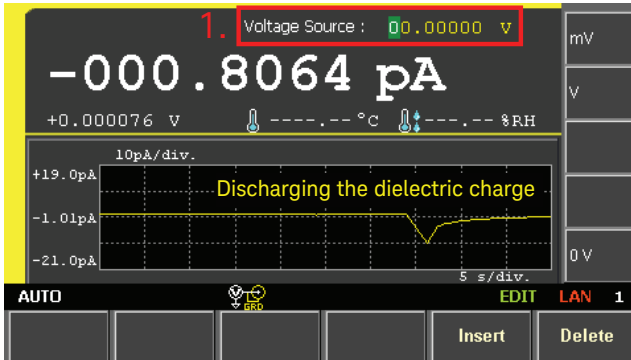
Note that it requires some time for the dielectric charge to dissipate and the capacitor voltage to settle to a safe level when the test voltage is high.



2. Press the  [Run/Stop] key again to stop making repeat measurements. You can tell that the repeat measurements have stopped by checking to see that the "AUTO" indicator is off.

Example 2: Time sweep/sampling measurements over a fixed time span

The second example measures leakage current by performing sampling measurements using the “LINEAR SINGLE” VS function over a fixed time span.

This example outputs 20 V when the [Single] trigger button is pressed, and then measures current every 5 seconds over the time period of 0 to 60 seconds using time sampling. This results in 13 time sampling measurement points.

Note:



The setup used in this example can be downloaded from the following link: www.keysight.com/find/SensitiveMeasurement

To start from the power on state, follow these steps by referring to the number shown in the corresponding figures.

Note:

Example 2 assumes it is being performed after the previous after the previous example 1. To perform example 2 immediately after powering on the B2985A/87A, repeat steps 1-1 to 1-3 from the previous example before proceeding.

Step 2-1. Navigate to the VS Function

1. In the [Meter View], set to [More... 3 of 3] assist key.
2. Press the [Show VS Func.] assist key.
3. Move the pointer on the “VS Function” input field by turning the  [Knob]. Then press the  [Knob] to change the input t to “EDIT” mode.

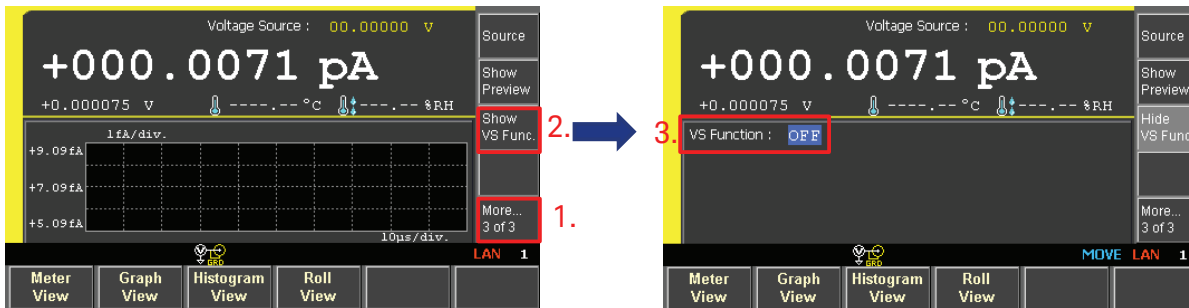





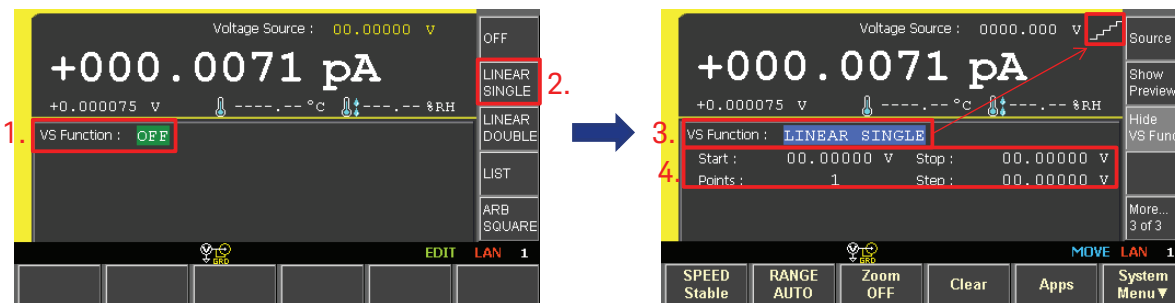

Step 2-2. Set the “LINEAR SINGLE” sweep function for the time sampling measurement

1. The VS Function changes to “EDIT” mode, and the VS Function selections are shown in the assist keys.
2. Press the [LINEAR SINGLE] assist key.
3. The VS Function changes to “LINEAR SINGLE” sweep, and the source shape indicator changes to stair case sweep.
4. The sweep parameter input field is shown.



Step 2-3. Set the test voltage for the time sampling sweep and navigate to trigger mode setup

1. Set both the “Start” and “Stop” voltage to 20 V by using the  [knob].
For each input,
 - a. Move the cursor on each input field by turning the  [Knob]
 - b. Press the  [Knob] to change status to EDIT (green)
 - c. Enter 20 V by using the  [Knob] and  [arrow keys]
 - d. Press the  [Knob] to fix the value
2. Press the [Hide VS Func.] assist key.
3. Press and change the [More... 3/3] assist key to [More... 2 of 3] assist key group.
4. Press the [Show Trigger] assist key.
5. On the “Trigger:” input field, press the  [Knob] to change the input t to “EDIT” mode.
The assist keys are changed to display the Trigger mode selections.
6. Press the [MANUAL] assist key.

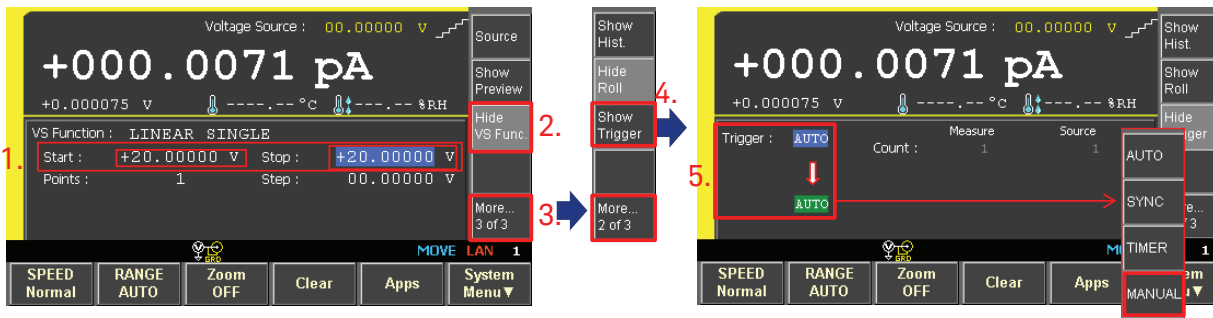

Step 2-4. Setup the trigger for a time sampling sweep

1. The default manual trigger parameters are shown.
2. Set the trigger parameters for [Measure] as follows by using the [Knob].

- Count : 13
- Delay : 2 sec. (Measurement delay time after the trigger)

This delay is required for the first measurement to allow for recovery from transients caused by the change in the bias voltage.

Set the wait time depending on your measurement conditions.

- Period : 5 sec. (Measurement interval)

For each input,

- a. Move the cursor onto each input field by turning the [Knob]
- b. Press the [Knob] to change status to EDIT (green)
- c. Enter each value by using the [Knob] and [arrow keys]
- d. Then, use the [Knob] (press) and/or assist key to apply the value.

3. Note:

The voltage source is independent from the measurement trigger except the first trigger. The source voltage is continuously active while the measurements are being made.

4. Press the [Hide Trigger] assist key.

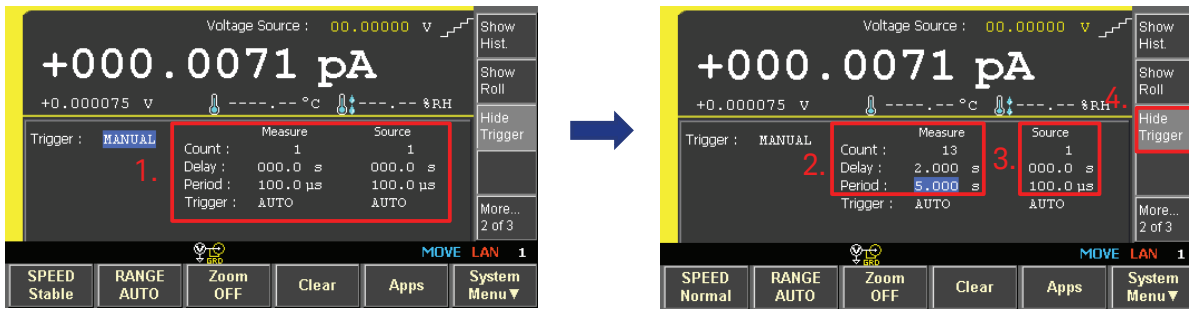

Step 2-5. Initiate the time sampling sweep measurements

The displayed View is the Meter View with the condensed roll graph.

1. Click the [Single] [Single] key.
The linear sweep voltage is output and the time sampling measurements start.
2. Note:

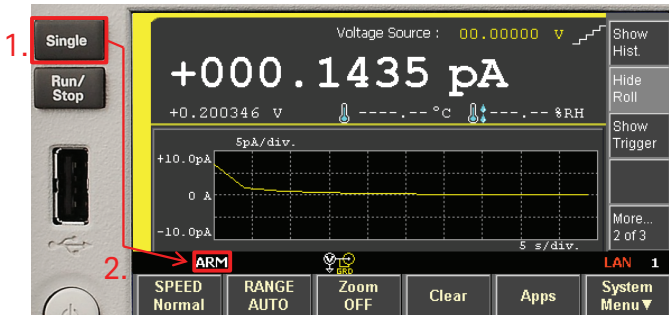

The [ARM] indicator appears while in the sweep measurement. At the end of the sweep measurement, the [ARM] indicator disappears and the output voltage returns to zero volts. The display shows the final leakage current measurement of the time sweep.



Step 2-6. Check the data in the Graph View

Note:



Step 3 is mandatory even if a setup file has been loaded.
 To display the leakage current trend data on the Graph View.

1. Press the  [View] key to show the View function key.
2. Press the [Graph View] function key to show the Graph View.
3. Set axis as follows by using the  [knob].

Y : I (A)

X : t (s)

To set the X axis to time:

- a. Move the cursor on the X : axis parameter input field by turning the  [Knob]
- b. Press the  [Knob] to change status to EDIT (green)

The [TIME (t)] assist key can be found in [More... 2 of 2] assist key group.

4. Press the [TIME (t)] assist key.

The I (A) versus time graph will be specified.

5. Press the [AUTO Scale] function key if the Graph View is open during the measurement.
6. If you need to change the X-axis time scale, move the cursor to X-axis max. field to modify it.

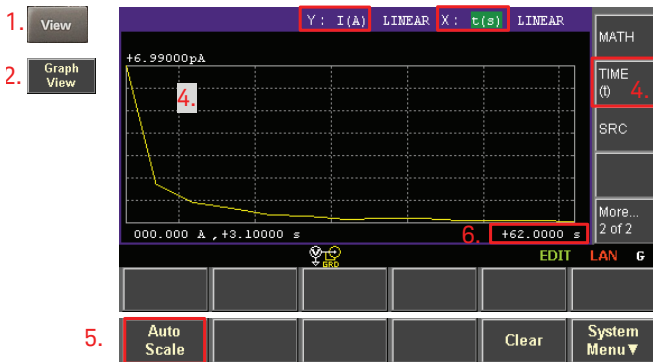

Tips: 1000 V range and limited auto-range setup

Both high voltage sourcing capability and fast current measurement capability are important for capacitance leakage current measurements.

To output more than 21 volts, you need to set the B2985A/87A output voltage range to its maximum value of.

The ammeter switches into the appropriate current range automatically between its maximum range of 20 mA and its minimum range of 2 pA to maintain six digits of resolution. For capacitor leakage current measurements, the ammeter usually does not require the lower current ranges (such as 2 pA and 20 pA). In fact, even the 200 pA range provides 0.0002 pA resolution with very fast response time. For these reasons, it is useful to limit the lowest current range in the auto-ranging setup when performing capacitance leakage current measurements.

This section explains how to set the 1000 V range and how to set the minimum range in the auto-range setting using step by step instructions.

Step T-1. Opening the VS function

1. Press the [More... 1 of 3] assist key until [More... 2 of 3] assist key group shows up.
2. Press the [Hide Roll] assist key.

Note:

Press the [Show VS Func.] in the [More... 3 of 3] assist key group if you are in a different setup.



3. The measurement range setup sub-panel is shown.



Step T-2. Changing to the 1000 V output range

Note:

The voltage range cannot be changed while the voltage source is in its ON status. Before attempting to change the voltage range, turn off the voltage source output.

1. Move the pointer on the "Spot Source Range" input field by turning the  [Knob], then
2. Press the  [Knob] to fix the pointer position and changes the pointer status to EDIT (green).
Spot Source Range selections are shown in the Assist key.
3. Press the [+1000 V] assist key.

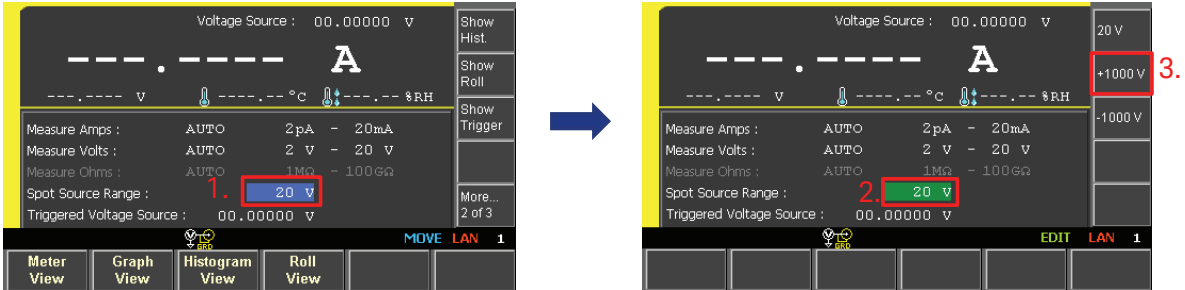

Note:

To output -1000 V, press [-1000 V] assist key.

Step T-3. The high voltage indicator is on when voltages greater than 21 V are present

1. The voltage source is set to +1000 V range.

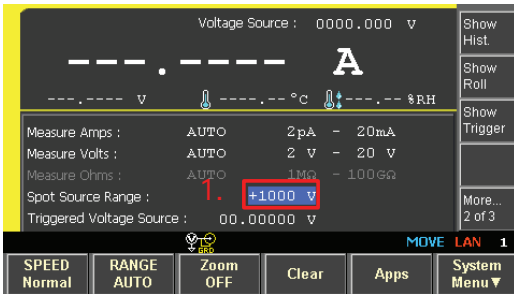

Note:

When the output voltage is more than 21 V, the high voltage indicator [HV] appears in the display and the voltage output [ON/OFF] switch turns to red as shown in the next figure.

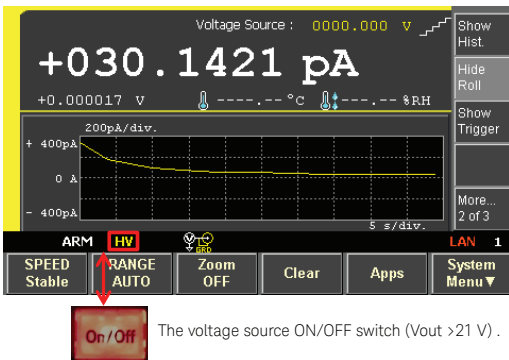



Tips: To change the limited auto-range setup (Example: change to 200 pA range)

Note:

This setup uses the same Measurement range setup sub-panel as in the voltage range setup.

Step T-4. To change the limited auto-range setup

1. Move the pointer on the “2 pA of the Measure Amps” input field by turning the  [Knob], then
2. Press the  [Knob] to fix the pointer position and changes the pointer status to EDIT (green).

Available current range choices are shown in the assist keys.

3. Press the [200 pA] assist key (for example).

Note that this operation is to set the minimum current range to 200 pA in the auto-ranging mode. We can do this because we do not need the 2 pA range (which is typically not fast enough for capacitance leakage current measurements.)

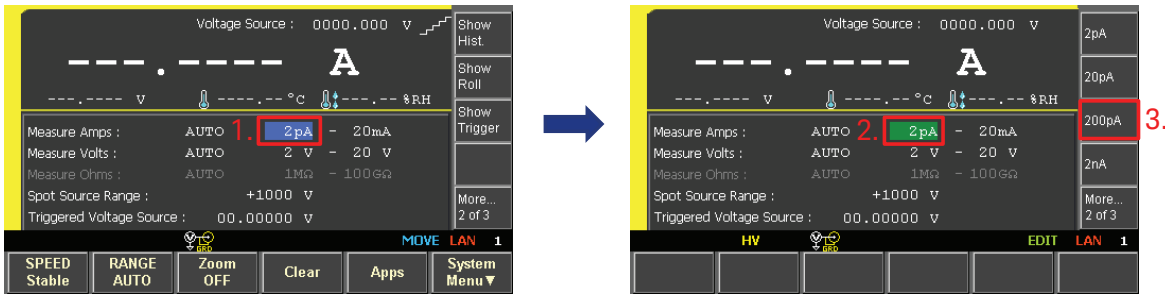

Step T-5. Returning to the Roll graph sub-panel

1. The minimum current range is set to 200 pA range.

Note:

The minimum current range setting depends on the test conditions required for a given capacitor type.

2. Press the [Show Roll] assist key to return to the condensed roll graph in the sub-panel.
3. The Meter View with the condensed roll graph is shown.

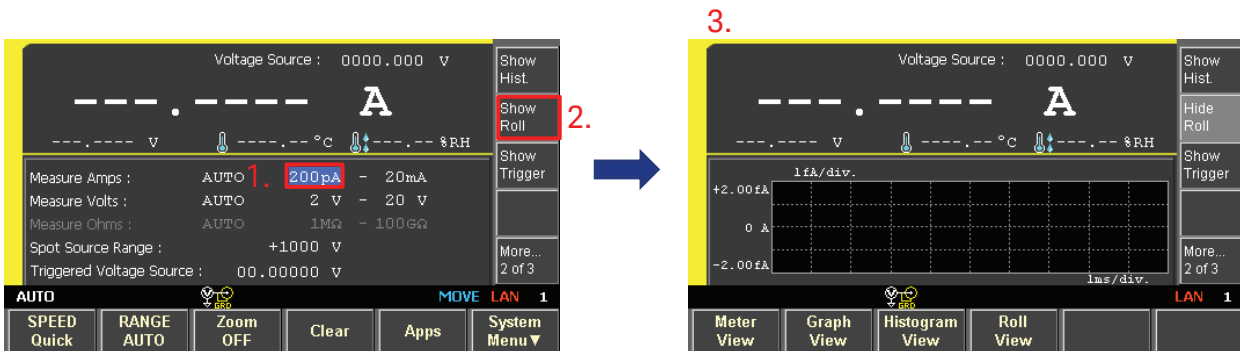

Summary

The Keysight B2985A/87A Electrometer/High Resistance Meter can supply up to 1000 V from its built-in voltage source and it also has unmatched current measurement resolution of 0.01 fA. These capabilities make it suitable for performing leakage current measurements for a wide range of capacitor types (under both the floating and grounded conditions).

The electrometer's Meter View and the Roll graph enable both the time-based behavior and the final value (at a user-specified time) of capacitor leakage current to be measured quickly, easily and safely.

The leakage current behavior over a specified time period can be automatically measured using the B2985A/87A's built in measurement functions and Graph View.

Evolving Since 1939

Our unique combination of hardware, software, services, and people can help you reach your next breakthrough. We are unlocking the future of technology.

From Hewlett-Packard to Agilent to Keysight.

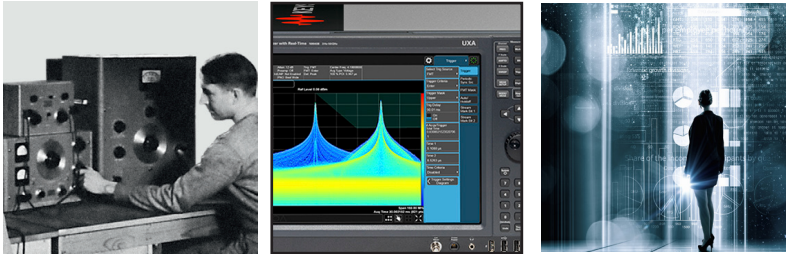

For more information on Keysight Technologies' products, applications or services, please contact your local Keysight office. The complete list is available at: www.keysight.com/find/contactus

Americas

Canada	(877) 894 4414
Brazil	55 11 3351 7010
Mexico	001 800 254 2440
United States	(800) 829 4444

Asia Pacific

Australia	1 800 629 485
China	800 810 0189
Hong Kong	800 938 693
India	1 800 11 2626
Japan	0120 (421) 345
Korea	080 769 0800
Malaysia	1 800 888 848
Singapore	1 800 375 8100
Taiwan	0800 047 866
Other AP Countries	(65) 6375 8100

Europe & Middle East

Austria	0800 001122
Belgium	0800 58580
Finland	0800 523252
France	0805 980333
Germany	0800 6270999
Ireland	1800 832700
Israel	1 809 343051
Italy	800 599100
Luxembourg	+32 800 58580
Netherlands	0800 0233200
Russia	8800 5009286
Spain	800 000154
Sweden	0200 882255
Switzerland	0800 805353
	Opt. 1 (DE)
	Opt. 2 (FR)
	Opt. 3 (IT)
United Kingdom	0800 0260637

For other unlisted countries: www.keysight.com/find/contactus (BP-9-7-17)

DEKRA Certified
ISO 9001 Quality Management System

www.keysight.com/go/quality

Keysight Technologies, Inc.
DEKRA Certified ISO 9001:2015
Quality Management System

This information is subject to change without notice.

© Keysight Technologies, 2018
Published in USA, March 12, 2018
5992-1307EN
www.keysight.com

myKeysight

myKeysight

www.keysight.com/find/mykeysight

A personalized view into the information most relevant to you.

http://www.keysight.com/find/emt_product_registration

Register your products to get up-to-date product information and find warranty information.

KEYSIGHT SERVICES
Accelerate Technology Adoption.
Lower costs.

Keysight Services

www.keysight.com/find/service

Keysight Services can help from acquisition to renewal across your instrument's lifecycle. Our comprehensive service offerings—one-stop calibration, repair, asset management, technology refresh, consulting, training and more—helps you improve product quality and lower costs.

Keysight Assurance Plans

www.keysight.com/find/AssurancePlans

Up to ten years of protection and no budgetary surprises to ensure your instruments are operating to specification, so you can rely on accurate measurements.

Keysight Channel Partners

www.keysight.com/find/channelpartners

Get the best of both worlds: Keysight's measurement expertise and product breadth, combined with channel partner convenience.

