

Keysight Technologies

Using an External Trigger to Measure Current with B2980A Series

B2980A Femto/Picoammeter and Electrometer/High Resistance Meter

Demo Guide



Introduction

The Keysight Technologies, Inc. B2980A Series of Femto/Picoammeters and Electrometers/High Resistance Meters offers not only the best-in-class measurement performance, but also unprecedented measurement features that can maximize your measurement confidence as you expect.

The femto/picoammeters and electrometers both offer 0.01 fA (10^{-17} A) minimum current resolution, which should meet most of your existing and future low-level current measurement needs.

The electrometers feature a 1,000 V voltage sourcing capability that supports up to 10 P Ω (10^{16} Ω) resistance measurements. The electrometers also work with Keysight's well-proven high resistance meter accessories.

The femto/picometer and electrometer/high resistance meter both have battery-powered versions that eliminate AC power-line noise. This low-noise environment allows you to make very sensitive, low-level measurements that were previously impossible.

Unlike conventional picoammeters and electrometers, the B2980A series features a 4.3" color LCD graphical user interface (GUI) enabling various viewing capabilities such as numeric, graph, histogram and roll (trend chart), which allows you to easily capture the transient behavior or to efficiently make a quick statistical analysis without using an external PC.

This demonstration guide highlights the excellent measurement and triggering capabilities of the B2980A series. The methodology involves sending an electronic trigger signal to a B2980A series electrometer and making a current measurement. In this example, the electrometer receives an external trigger signal with specific timing parameters, such as 500 ms measurement delay, while sourcing 1 V across 100 G Ω resistor.

Required Instrument and Accessories

All of the accessories required to perform the demos described in this demonstration guide are provided in a demo kit that is included with Keysight B2987A demo units except for the external trigger source.



Keysight B2987A Electrometer



B2981-61715
Banana to lug cable



16494A-001 Triax cable



N1422A High resistance demo kit



16493B-001 Coaxial cable



U8201-60001
Xtention lead set for straight plugs

Concept

Figure 1 illustrates the connection diagram and basic setup conditions for the demo, which uses a B2985A/87A ammeter to make current measurements whenever it receives an external trigger signal. The B2980A series will measure current using the settings shown below while sourcing voltage across the resistor.

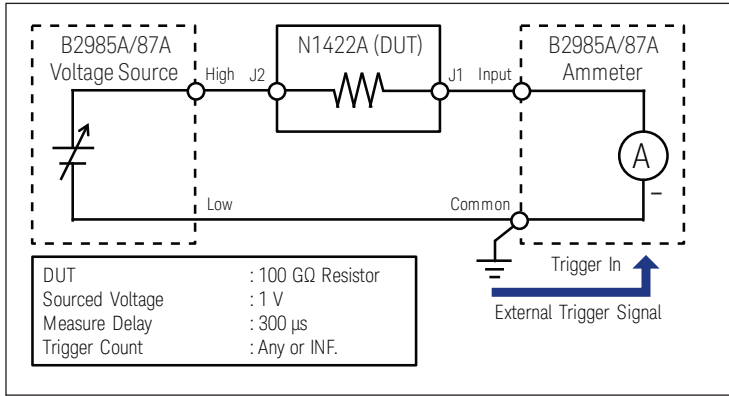

Figure 1. Connection diagram and basic condition

Figure 2 shows the parameters used to define the measurement timing from the instrument's front panel. The specified source value is outputted immediately after pressing Voltage Source . Next, you will need to configure the B2985A/87A ammeter to accept an external trigger and make a current measurement.

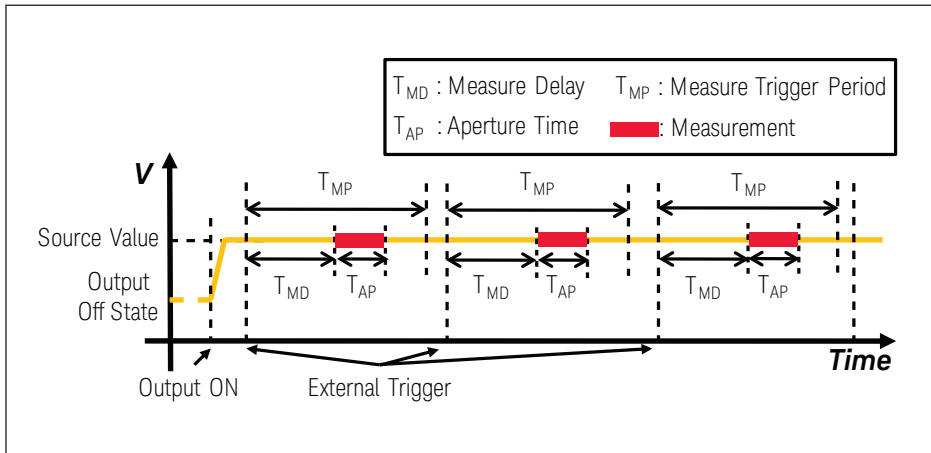

Figure 2. Timing chart for the current measurement

Figure 3 shows the external trigger signal requirements to initiate a current measurement from the ammeter. Positive or negative logic can be used to set the external trigger pulse.

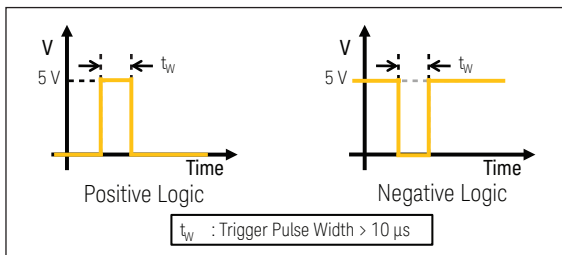
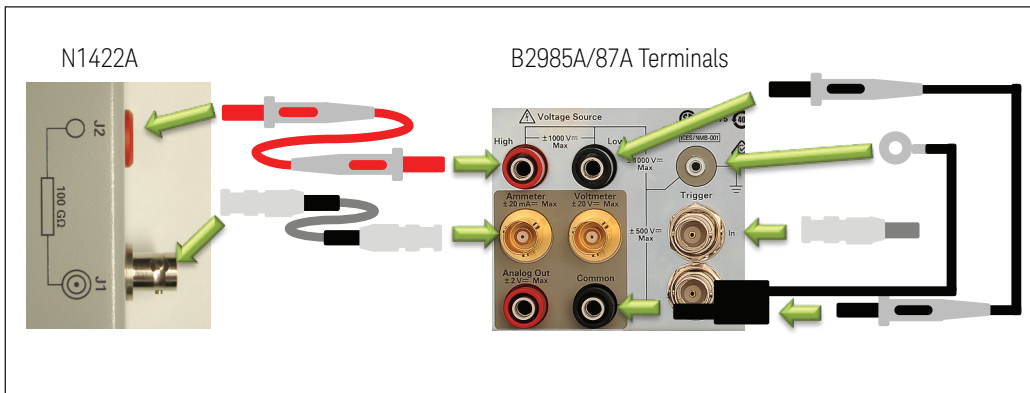

Figure 3. External trigger signal requirements

Setup

Connection

1. Connect the **Common** terminal to the **Earth** terminal of the B2985A/87A with a **banana to screw-lug cable**.
2. Connect the **Voltage Source Low** terminal to the **Common** terminal of the B2985A/87A with a **black banana test lead**.
3. Connect the **Ammeter Input** terminal of the B2985A/87A to the **J1** terminal of the N1422A with a **triaxial cable**.
4. Connect the **Voltage Source High** terminal of the B2985A/87A to the **J2** terminal of the N1422A with a **red banana test lead**.
5. Connect the **trigger source** to the **Trigger In** port of the B2985A/87A with a **BNC cable**.



LAB: Using external trigger signals and a B2980A series ammeter to make a current measurement.

Demonstration

1. Change View mode to Meter View

1) Press **View** repeatedly until the **Meter View** appears on the screen.



2. Confirm the measurement parameter

1) Make sure that the **measurement parameter** is set to **current**. If it is **NOT** set to **current**, take the procedure “2)” to set it to **current**.

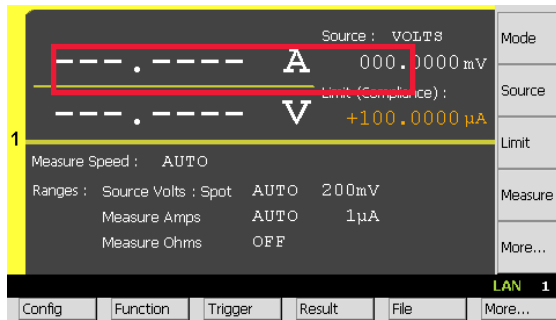

2) (Optional) Press **AMPS (I)** to set the measurement parameter to current.

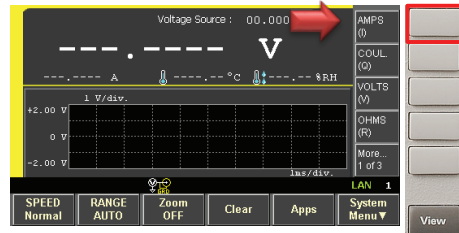

3. Configure the trigger condition

1) Press **More...** and then press **Show Trigger** to show the **Trigger Sub-Panel**.

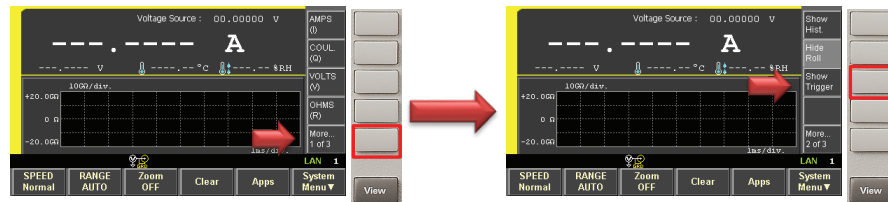

2) Press **Show Trigger** to edit the **Trigger type**, and then select **MANUAL** to set the **Trigger type** to **MANUAL**.

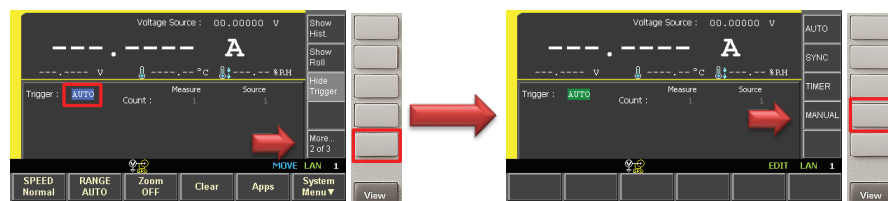



Objective



This demo illustrates the ability of a B2980A series ammeter to respond to an external trigger and make a current measurement.

Procedure

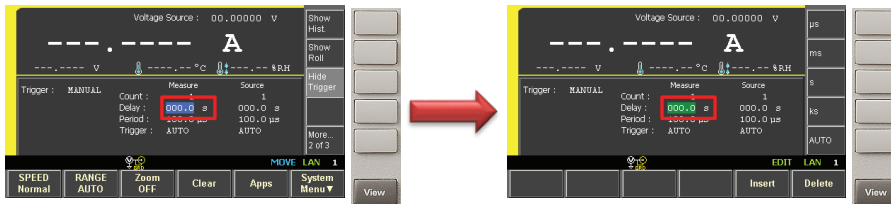

1. Change View mode to Meter View
2. Confirm the measurement parameter
3. Configure the trigger condition
4. (Optional) Configure voltage source condition
5. Initiate the ammeter to wait for an external trigger signal
6. (Optional) Abort the ammeter to stop waiting for an external trigger signal
7. (Optional) If you'd like to change aperture mode
8. (Optional) If you'd like to change measurement range operation

3) Rotate  to select the Measure trigger delay and press  to edit it. Then enter 500 ms to set the Measure trigger delay to 500 ms.



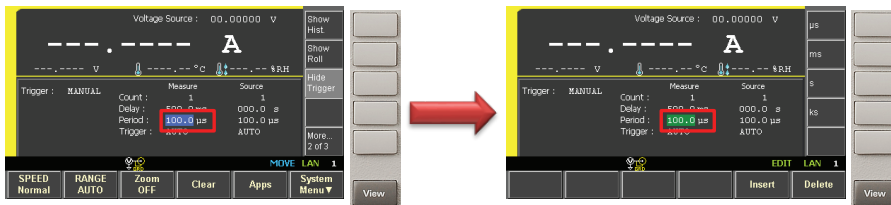



4) Rotate  to select the Measure trigger period and press  to edit it. Then enter 1 s to set the Measure trigger period to 1 s, which should be longer than the sum of the measurement delay time and the aperture time.

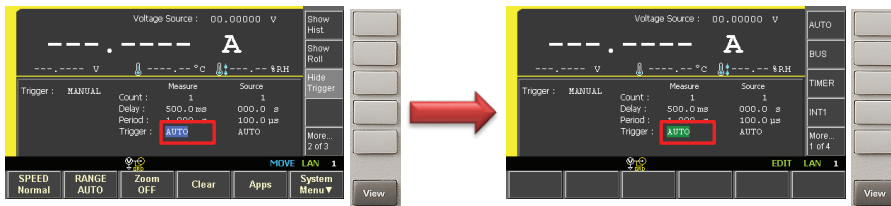



5) Rotate  to select the Measure trigger source and press  to edit it.

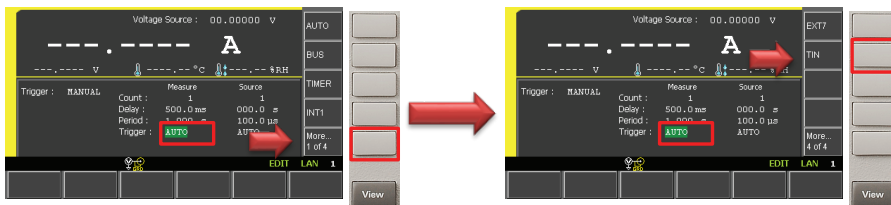

6) Press , ,  to change the keys shown in Assist keys, and then press  to set the Measure trigger source to Trigger In port.

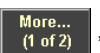

7) Press , , , and then press  to open the BNC Configuration dialogue.

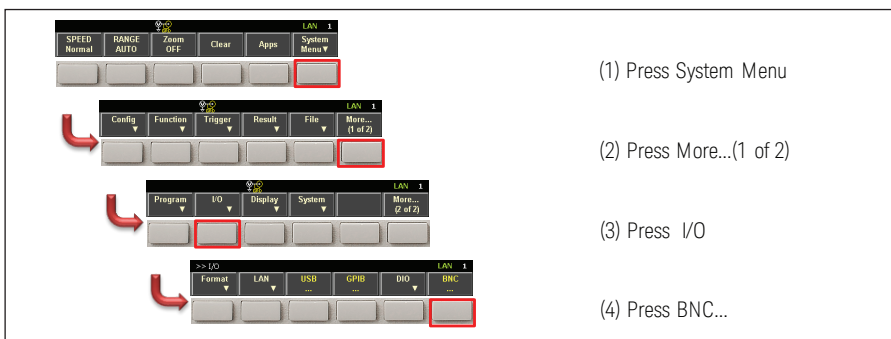



(1) Press System Menu

(2) Press More...(1 of 2)

(3) Press I/O

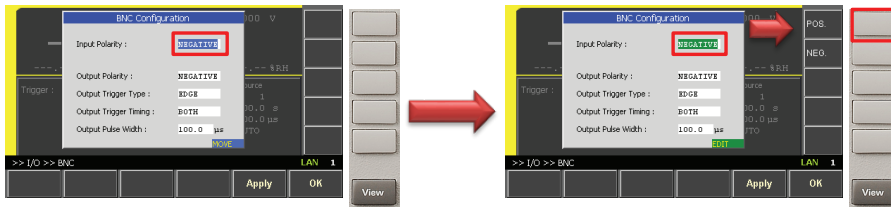

(4) Press BNC...

8) Press  to edit the **Input Polarity**, and then press  to set it to **Positive** polarity.

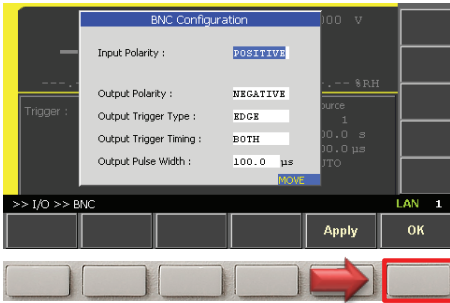

9) Press  to make save your settings.



10) Rotate  to select the **Measure trigger count** and press  to edit it. Then enter the **Number of trigger signals** which will be sent to the instrument as the **Measure trigger count**.

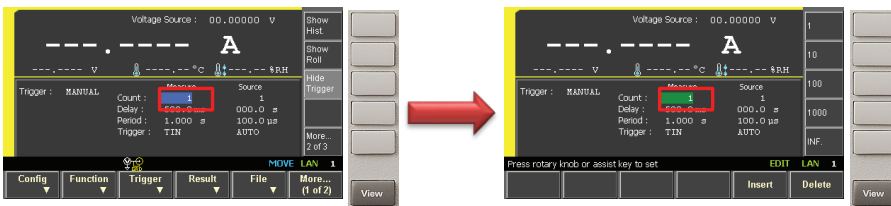

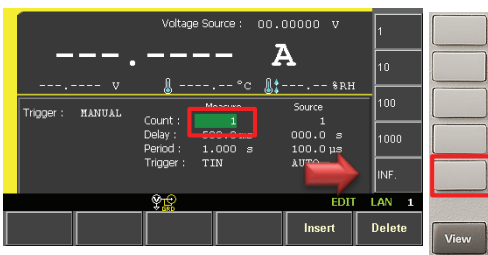

11) Or press  to set it to **INFINITY** if you'd like to continue to measure current until it is aborted.





If you set the trigger count to INFINITY, be sure you abort the process at the end of the test.

4. (Optional) Configure voltage source condition

The B2987A has an internal voltage source. This demo makes use of it to source voltage across the resistor and induce current across it.

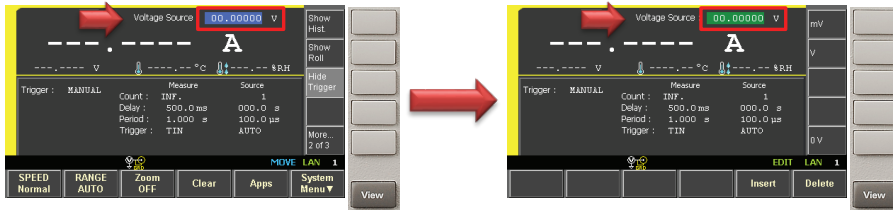
- 1) Rotate  to select the **Voltage source** and press  to edit it.





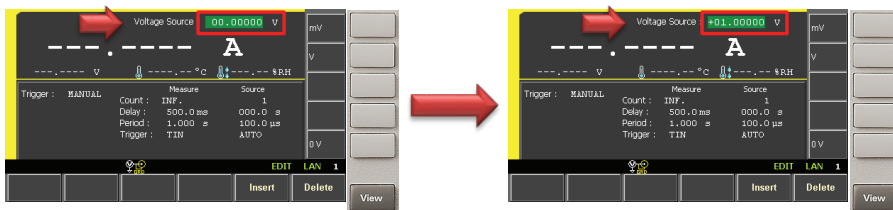

- 2) Then rotate  until the **Voltage Source** value reaches 1 V and press  to fix it.



- 3) Press Voltage Source  to enable Voltage Source.

5. Initiate the ammeter to wait for an external trigger signal

- 1) Press Ammeter  to enable Ammeter
- 2) Press , , , and then press  to make the ammeter ready to receive an external trigger signal.



When the B2980A series ammeter is ready, send the external trigger signal to it and make the current measurement.

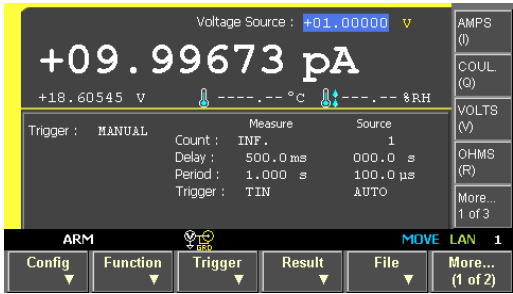

6. (Optional) Abort the ammeter to stop waiting for an external trigger signal

If you set the measure trigger count to INFINITY, or the number of external trigger signals was less than the specified measure trigger count, be sure you abort the process at the end of the test.

- 1) Press **System Menu**, **Trigger**, **Abort**, and then press **Acq.** to make the ammeter stop waiting for an external trigger signal.

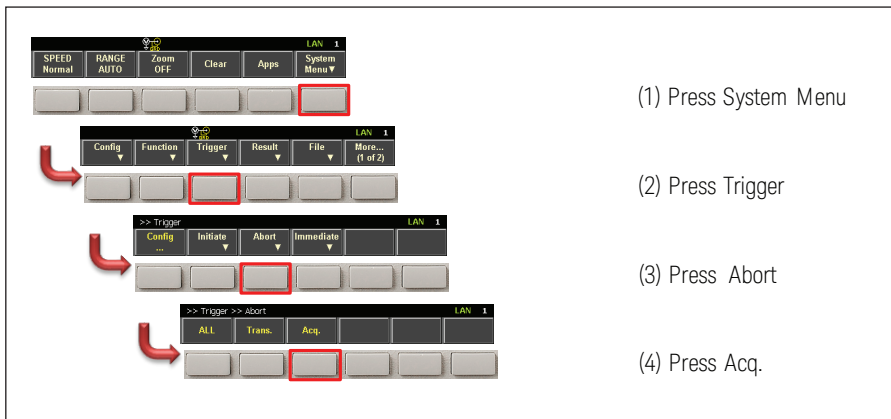

7. (Optional) If you'd like to change the aperture mode

The **automatic aperture mode** is selected in the default setting and **Normal** is selected as the **aperture type**. When the automatic aperture mode is selected, an appropriate aperture time is set automatically by the instrument depending on the current measurement range. If the manual aperture mode is selected, the instrument uses the aperture time specified by the user.

- 1) Press the measurement navigation key  to select **shorter aperture type**.

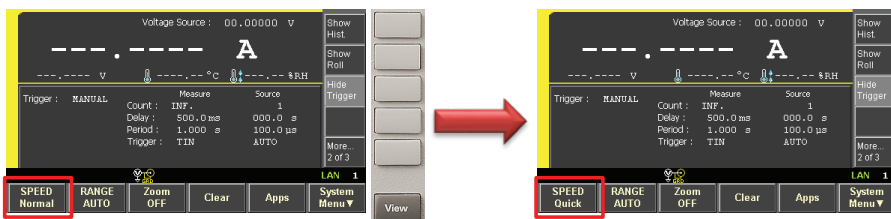

2) Press the measurement navigation key  to select longer aperture type.

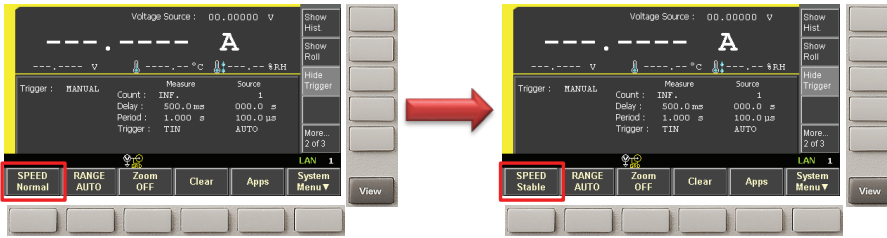

3) For example, if you'd like to select the manual aperture mode, press .

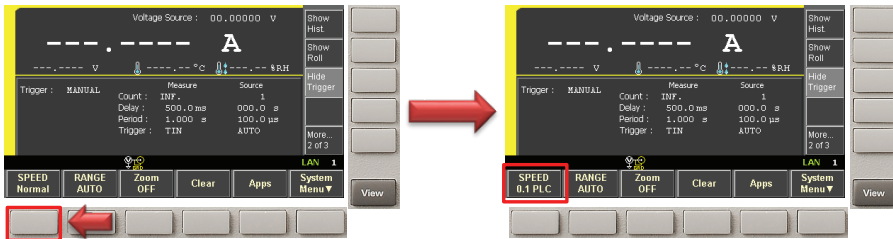

4) If you'd like to set the mode to the automatic aperture mode again, press .

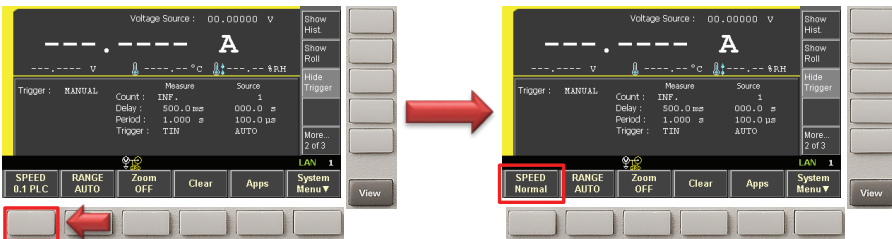

5) If you'd like to set the aperture mode to the default one, press , the center of the measurement navigation key.

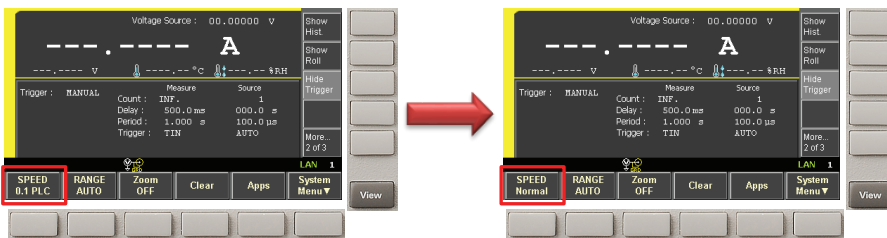

8. (Optional) If you'd like to change the measurement range operation

The **current measurement range operation** is set to **AUTO** in the default settings. When the operation is set to **AUTO**, an appropriate current measurement range is selected automatically by the instrument depending on the current measurement result. If the mode is set to **FIXED**, the current measurement range is fixed to the one specified by the user during the measurement.

1) Press **Hide Trigger** to hide Trigger Parameters.

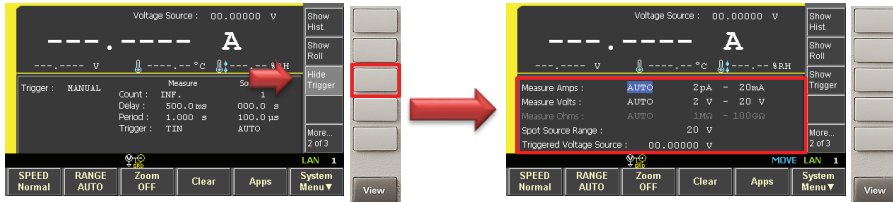

2) Press **RANGE AUTO** to set the current measurement range operation to **FIXED**.

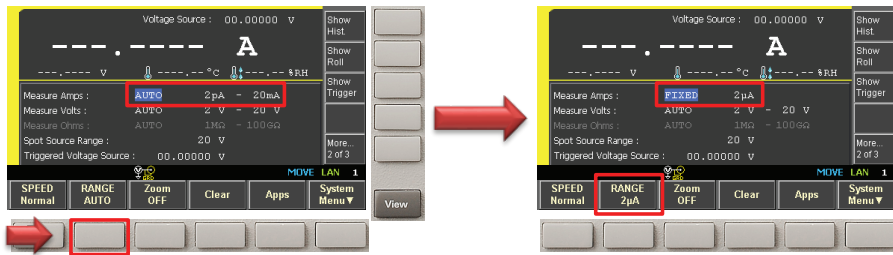

3) Press the measurement navigation key **Range +** to select a larger current measurement range.

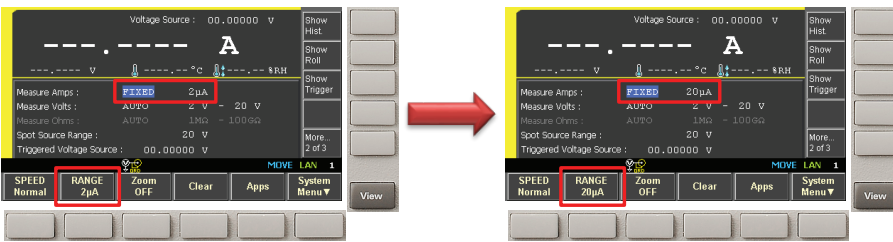

4) Press the measurement navigation key **Range -** to select a smaller current measurement range.

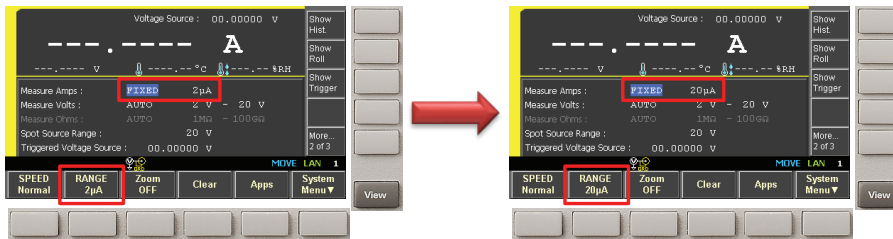

5) If you'd like to set the operation to AUTO again, press **RANGE 2µA**.

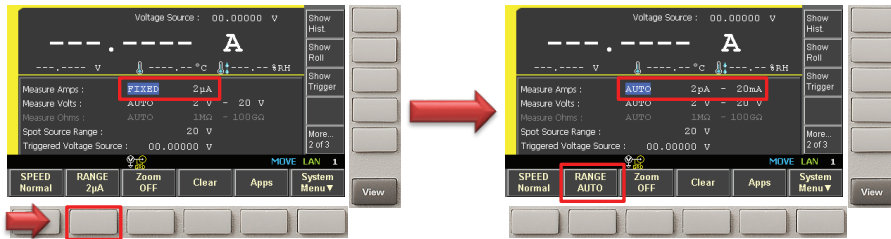

6) If you'd like to reset the measurement range setting to the default one, press , the center of the measurement navigation key.

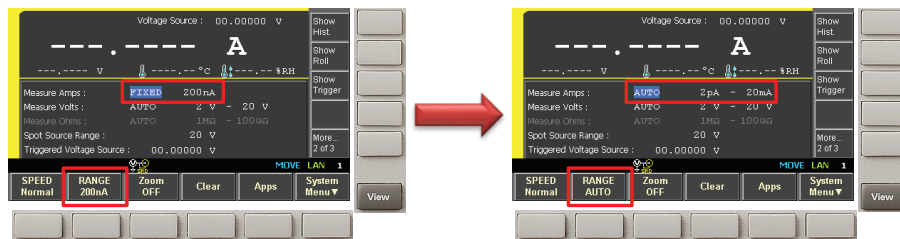

Controlling the B2980A Series using SCPI commands

If you prefer to control the B2980A Series remotely using SCPI remote commands, then the following material explains how to do this.

The series of commands shown in group “A” configure the measurement parameter and trigger condition. Next the series of commands shown in group “B” should be sent to set up the voltage source optionally. Finally, the series of commands shown in group “C” should be sent to initiate the ammeter in the B2980A Series to wait for an external trigger signal.

The series of commands shown in group “D”, “E”, and “F” are optional to abort the ammeter to stop waiting for an external trigger signal, to change the aperture mode, and to change the measurement range operation.

B2985A/87A SCPI command example		
*RST	:INP ON	} C
:DISP:ENAB OFF	:INIT:ACQ (@1)	
:SENS:FUNC "CURR"	:ABOR:ACQ (@1)	D
:TRIG:ACQ:DEL 0.5	:SENS:CURR:APER:AUTO:MODE SHOR	} E
:TRIG:ACQ:TIM 1	:SENS:CURR:APER:AUTO OFF	
:TRIG:ACQ:SOUR TIN	:SENS:CURR:RANG:AUTO OFF	} F
:SYST:TIN:POL POS	:SENS:CURR:RANG 2E -5	
:TRIG:ACQ:COUN 10		
:SOUR:VOLT 1		} B
:OUTP ON		

Conclusion

The Keysight B2980A Series of Femto/Picoammeters and Electrometers/High Resistance Meters offers not only the best-in-class measurement performance, but also unprecedented measurement features that can maximize your measurement confidence. The 0.01 fA (10^{-17} A) minimum current resolution is available for both Femto/Picoammeters and Electrometers/High Resistance Meters and should meet most of your existing and future sensitive current measurement needs.

In addition to its excellent measurement capabilities, the B2980A series can use an external trigger to make current measurements. This ability to synchronize accurately with other instruments expands your test flexibility. You can further improve your measurement fidelity by using a B2980A series battery-powered model to eliminate AC power line noise.

B2900 Precision Instrument Family

The B2900 family contains products that perform both precision sourcing and precision measurement. www.keysight.com/find/b2900a



Evolving Since 1939

Our unique combination of hardware, software, services, and people can help you reach your next breakthrough. We are unlocking the future of technology.

From Hewlett-Packard to Agilent to Keysight.

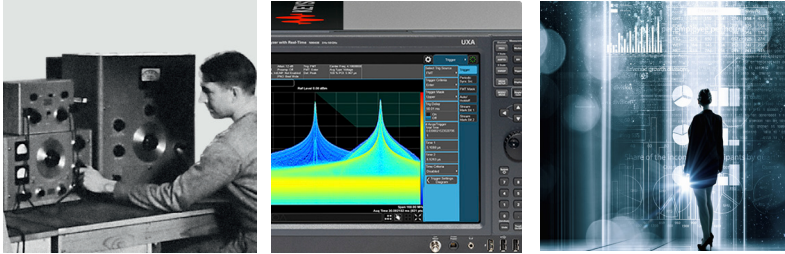

myKeysight

myKeysight

www.keysight.com/find/mykeysight

A personalized view into the information most relevant to you.

http://www.keysight.com/find/emt_product_registration

Register your products to get up-to-date product information and find warranty information.

KEYSIGHT SERVICES

Accelerate Technology Adoption.
Lower costs.

Keysight Services

www.keysight.com/find/service

Keysight Services can help from acquisition to renewal across your instrument's lifecycle. Our comprehensive service offerings—one-stop calibration, repair, asset management, technology refresh, consulting, training and more—helps you improve product quality and lower costs.



Keysight Assurance Plans

www.keysight.com/find/AssurancePlans

Up to ten years of protection and no budgetary surprises to ensure your instruments are operating to specification, so you can rely on accurate measurements.

Keysight Channel Partners

www.keysight.com/find/channelpartners

Get the best of both worlds: Keysight's measurement expertise and product breadth, combined with channel partner convenience.

www.keysight.com/find/b2900a

For more information on Keysight Technologies' products, applications or services, please contact your local Keysight office. The complete list is available at:

www.keysight.com/find/contactus

Americas

Canada	(877) 894 4414
Brazil	55 11 3351 7010
Mexico	001 800 254 2440
United States	(800) 829 4444

Asia Pacific

Australia	1 800 629 485
China	800 810 0189
Hong Kong	800 938 693
India	1 800 11 2626
Japan	0120 (421) 345
Korea	080 769 0800
Malaysia	1 800 888 848
Singapore	1 800 375 8100
Taiwan	0800 047 866
Other AP Countries	(65) 6375 8100

Europe & Middle East

Austria	0800 001122
Belgium	0800 58580
Finland	0800 523252
France	0805 980333
Germany	0800 6270999
Ireland	1800 832700
Israel	1 809 343051
Italy	800 599100
Luxembourg	+32 800 58580
Netherlands	0800 0233200
Russia	8800 5009286
Spain	800 000154
Sweden	0200 882255
Switzerland	0800 805353
	Opt. 1 (DE)
	Opt. 2 (FR)
	Opt. 3 (IT)
United Kingdom	0800 0260637

For other unlisted countries:

www.keysight.com/find/contactus
(BP-9-7-17)



www.keysight.com/go/quality

Keysight Technologies, Inc.
DEKRA Certified ISO 9001:2015
Quality Management System



Unlocking Measurement Insights

This information is subject to change without notice.

© Keysight Technologies, 2017
Published in USA, December 1, 2017
5992-1791EN

www.keysight.com