

# Keysight Technologies

## Wide Range of Resistance

## Measurement Solutions from $\mu\Omega$ to $P\Omega$

Application Note



# Introduction

Resistance measurement is one of the fundamental characterizations of materials, electronic devices, and circuits. Although there are a variety of resistance measurements used throughout the world, we make the most of the convenience of digital multimeters (DMMs).

At first glance, resistance measurement appears to be simple and easy to use, since it is merely a combination of sourcing and measuring voltage or current based on Ohm's law. However, there are in fact a variety of error factors that prevent us from taking an accurate resistance measurement. At the same time, the factors that affect measurement results differ among the measurement resistance range. It is therefore vital to select appropriate instruments according to the characteristics of the device under test (DUT) to acquire reliable measurement results. Keysight Technologies, Inc. offers a variety of resistance measurement solutions that cover resistance from  $\mu\Omega$  to P $\Omega$ , providing you with the best choice to meet your resistance measurement needs.

Figure 1 shows a variety of Keysight resistance measurement solutions according to the measured resistance.

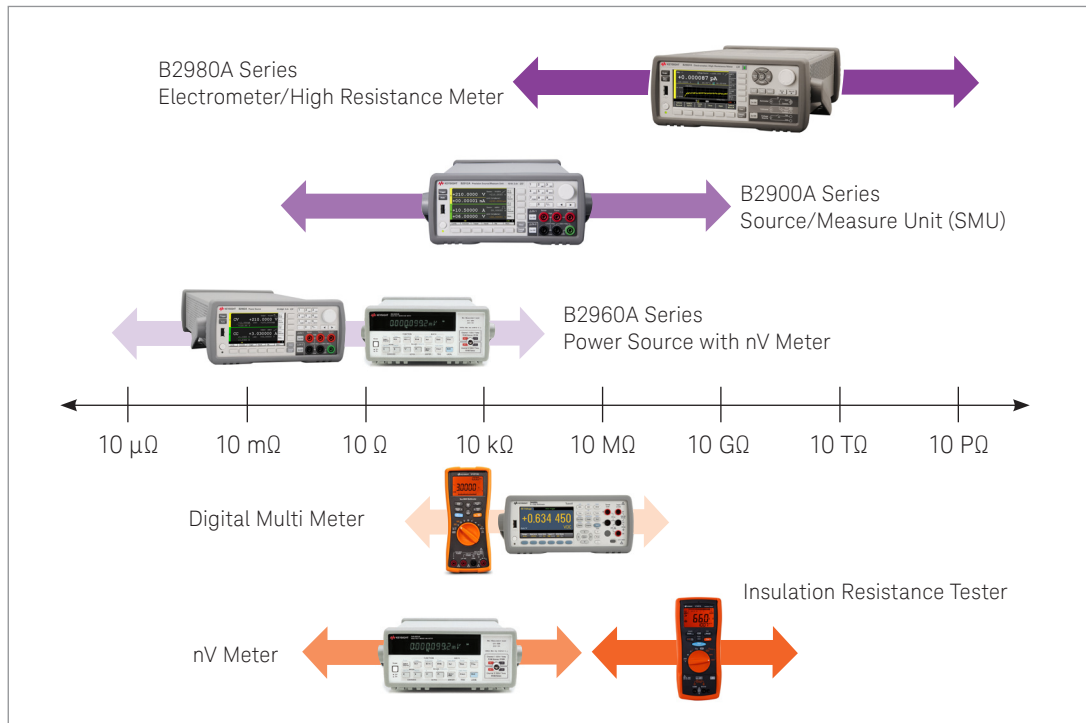

Figure 1 Keysight resistance measurement solutions

## Keysight resistance measurement solutions

### Versatile resistance measurement solutions

Due to their convenience, DMMs are commonly used to make resistance measurements. Keysight offers a wide variety of DMMs such as handhelds and bench-top instruments. This allows you to select a model to suit your measurement requirements and usage environment. Since most DMMs only use an auto resistance measurement mode, the test current is essentially fixed for each range. Handheld DMMs generally only support 2-wire connections, while most bench-top DMMs support 2-wire and 4-wire connections. See the following link for more details.

[www.keysight.com/find/dmm](http://www.keysight.com/find/dmm)



Figure 2. Keysight digital multimeters

Keysight also offers Keysight B2900A precision source/measure units (SMUs) providing a versatile resistance measurement solution which covers currents from 10 fA to 3 A (DC)/10.5 A (pulse) and voltages from 100 nV to 210 V. The SMU combines the capabilities of the current source, voltage source, current meter and voltage meter along with the capability to switch easily between these various functions within a single instrument (see Figure 3).

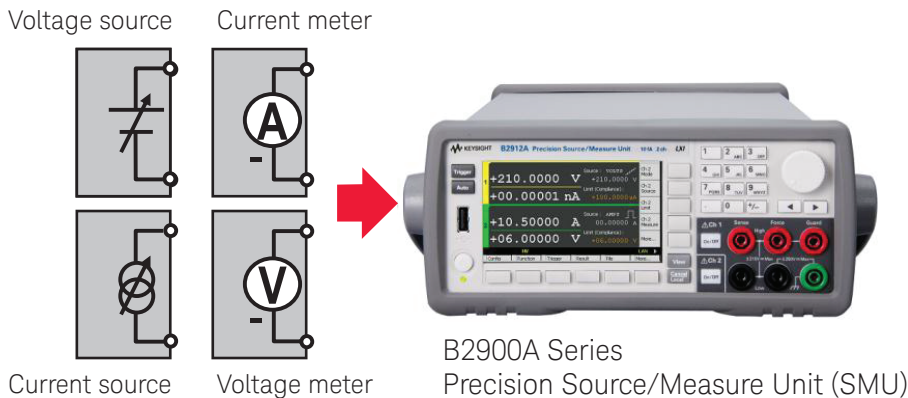

Figure 3. SMU combines four measurement functions into a single instrument

This gives you the ability to evaluate the current-voltage (IV) characteristics including resistance for devices without the need for any additional equipment. As well as the ability to output and measure voltage or current with a high degree of accuracy, SMUs also possess a compliance feature that allows a limit to be placed on the voltage or current output to prevent device damage. See the following link for more details.

[www.keysight.com/find/precisionSMU](http://www.keysight.com/find/precisionSMU)

The following outlines the advantages of using the SMUs for resistance measurements:

- Current and voltage output modes are available
- Compliance feature that allows a limit to be placed on the current or voltage output to prevent device damage
- Pulsed operation mode to prevent device self-heating from distorting the measurement results (in addition to DC operation mode)
- Manual measurement mode providing optional test current settings or voltage settings to suppress self-heating caused by power dissipation (in addition to auto measurement mode)
- 4-wire connections to eliminate cable resistance effects in low resistance measurements (as well as 2-wire connections)
- Resistance compensation function to minimize thermal EMF errors

Figure 4 shows a measurement example using the B2900A Series and 1  $\Omega$  resistor which shows the effect of 4-wire connections. It is essential to use a 4-wire connection in low resistance measurements because the residual lead resistance is comparable to the DUT resistance. A 4-wire measurement, which is available with the B2900A Series as well as most bench-top DMMs, uses one pair of leads to source the current and the other pair of leads to measure voltage. This eliminates cable resistance effects so that only the voltage drop across the DUT is measured. The result when using a 4-wire connection is 1 Ohm, while 2-wire connection it is 1.6 Ohm. The difference, that is 0.6 Ohm, should be the residual lead resistance on the measurement cables. The B2900A Series provides a variety of functions to make it possible to easily make an accurate resistance measurement.

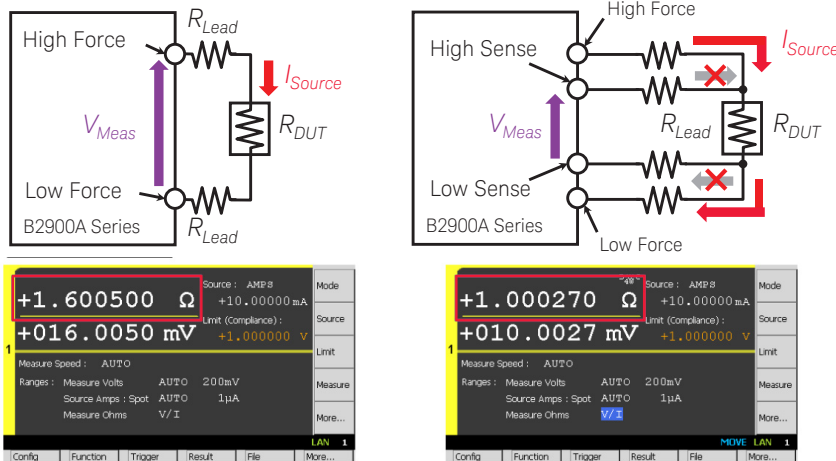

a) Result with 2-wire connection

b) Result with 4-wire connection

Figure 4. The result with 2-wire connection includes the residual lead resistance  $R_{Lead}$

## Low resistance measurement solutions

The Keysight 34420A 7 ½ digit nano volt / micro ohm meter is a high-sensitivity multimeter optimized for performing low-level measurements. It combines low-noise voltage measurements with resistance and temperature functions, setting a new standard in low-level flexibility and performance. It covers a range of resistance measurements from 1 Ohm to 1 M ohm. See the following link for more details. [www.keysight.com/find/34420A](http://www.keysight.com/find/34420A)

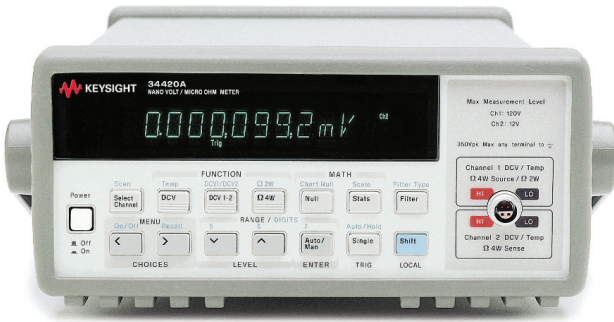

Figure 5. Keysight 34420A 7 ½ digit nano volt/micro ohm meter

Certain types of resistance measurements require a very precise, low level current source to prevent device self-heating or device damage during testing. In general, accuracy improves with the magnitude of the voltage or current being measured. Therefore, for devices with low resistance values it is important to keep the measurement voltage as large as possible. The Keysight B2960A series 6.5 digit low noise power source satisfies these measurement requirements when used in combination with the 34420A.



Figure 6. Keysight B2960A series 6.5 digit low noise power source

The B2960A series is an advanced bipolar power supply/source and can source either voltage or current with 6.5 digits of resolution while also monitoring both voltage and current, allowing it to make a resistance measurement by itself. Since it supports 4-quadrant operations, the output polarities can be either positive or negative. It can therefore source currents from 10 fA to 3 A (DC) or 10.5 A (pulsed), and voltages from 100 nV to 210 V. See the following link for more details. [www.keysight.com/find/precisionSOURCE](http://www.keysight.com/find/precisionSOURCE)

The combination of the B2961A and 34420A provides superior performance for low resistance measurements. In the resistance measurement scheme shown in Figure 7, the 34420A performs the voltage measurement while the B2961A sources a precise current. In this configuration the B2961A acts as the master and makes measurements at programmed intervals while simultaneously sending trigger signals to the 34420A to perform voltage measurements.

The 34420A can also measure resistance without the need for other instruments. The minimum resistance range is 1  $\Omega$  and the maximum output current is 10 mA. However, the B2960A series can flexibly source currents of up to 3 A, thereby realizing measurements with a resolution 300 times higher when compared with the standalone 34420A and with sufficient accuracy. However, it is essential to define appropriate test current as discussed in the section “Power dissipation effects”, because it also increases the power dissipation and self-heating effects.

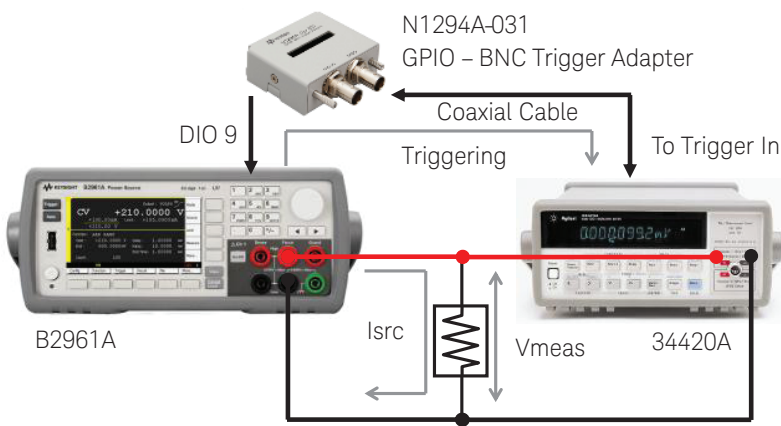

Figure 7. Diagram of the B2961A and 34420A low resistance measurement solution

Figure 8 shows a measurement example using a 10 m $\Omega$  metal foil resistor. The combination of the B2961A and 34420A that uses a 500 mA test current provides excellent stability and accuracy in the measurement, which is not the case for the 34420A standalone.

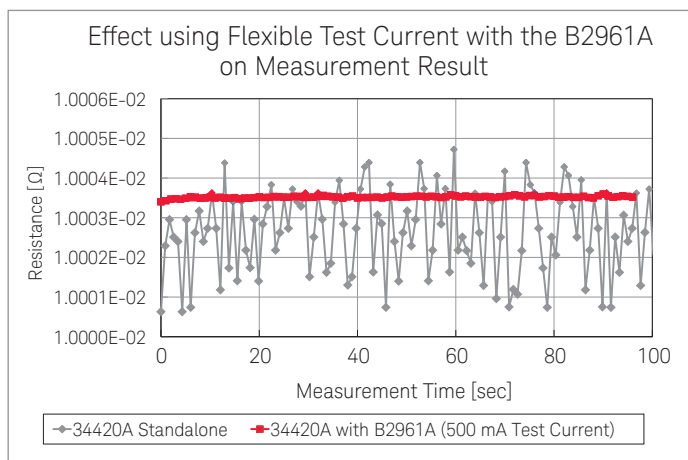

Figure 8. Effect using flexible test current with the B2961A on measurement results

## High resistance measurement solutions

Insulation resistance testing is commonly performed as part of electrical testing in a preventive maintenance program for rotating machines, cables, switches, transformers, and electrical machinery where insulating integrity is necessary. Insulation resistance testing in preventive maintenance programs helps to identify potential electrical issues to reduce unpredictable, premature equipment repairs and replacement costs. This makes the Keysight U1450A/60A series insulation resistance testers the ideal solution. With their vast measurement capabilities, efficient automated report generation and high durability, you can accomplish more in a day's work with the U1450A/60A series. See the following link for more details.

[www.keysight.com/find/insulationtesters](http://www.keysight.com/find/insulationtesters)



Figure 9. Keysight U1450A/60A series insulation resistance tester

The Keysight B2980A series femto/picoammeters and electrometers/high resistance meters not only offer best-in-class measurement performance, but also provide unprecedented features to maximize confidence in your measurements. The femto/picoammeters and electrometers both offer 0.01 fA ( $10^{-17}$  A) minimum current resolution, which meets virtually all existing and future low-level current measurement needs. The electrometers feature a 1,000 V voltage sourcing capability that supports up to 10 P $\Omega$  ( $10^{16}$   $\Omega$ ) resistance measurements. Since both the auto and manual resistance measurement modes are available with the electrometers, you can specify an arbitrary test voltage for high resistance measurements by using the manual resistance measurement mode. See the following link for more details.

[www.keysight.com/find/precisionMEASURE](http://www.keysight.com/find/precisionMEASURE)



Figure 10. Keysight B2980A series femto/picoammeters and electrometers/high resistance meters

The obsolete 4339A/B high-resistance meter was the go-to standard for many years for making resistivity measurements. The B2980A series can be seen as a fitting replacement. Since the B2980A series uses a different measurement method for the ammeter than the 4339A/B, the B2980A series shows a lower measurement noise and higher measurement speed than the 4339A/B, however the maximum capacitive load is limited. It is therefore important to note the capacitive load for materials being tested when replacing the 4339A/B. The N1413A high resistance meter fixture adapter is provided to make it easy to connect the B2980A series to accessories for the 4339A/B such as the 16008B, the 16117B/C, and the 16339A as shown in Figure 11.



Figure 11. The B2980A and 16008B configured to make resistivity measurements

Resistivity measurements are typically made at a specified time after applying a stimulus. This is due to the fact that the resistivity for insulating materials typically does not quickly converge to a stable value, which mandates that any resistivity specification has to state at what time the resistivity measurement should take place. The B2980A series allow you to specify exactly what time to make a measurement after applying stimulus (electrification). The B2980A series' time domain view also allows you to display resistivity changes from the start of the stimulus to the final measurement time as shown in Figure 12. See the following link for more details.  
[www.keysight.com/find/SensitiveMeasurement](http://www.keysight.com/find/SensitiveMeasurement)

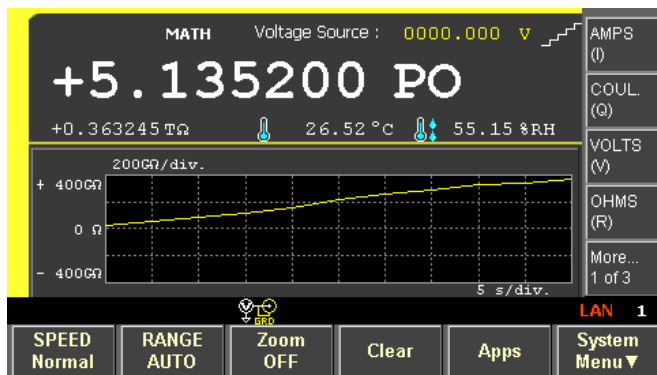

Figure 12. Resistivity measurement example using the B2980A series



## Major error factors in resistance measurements

### Lead resistance

A basic 2-wire connection is the most common configuration used for resistance measurements. In this configuration (shown in Figure 13a) the same pair of test leads is used to source current and measure voltage. This arrangement is suitable for resistance measurements as long as the residual lead resistance is negligible compared to the resistance of the DUT.

However, for very low resistance measurements where the residual lead resistance is comparable to the DUT resistance, a 2-wire measurement will provide erroneous measurement results (see Figure 13b). In this case a 4-wire connection configuration (remote sensing) can be used to eliminate this error. A 4-wire measurement uses one pair of leads to source current and the other pair of leads to measure voltage. This eliminates cable resistance effects so that only the voltage drop across the DUT is measured (see Figure 13c).

Handheld DMMs generally support only 2-wire connections, although most bench-top DMMs, the 34420A and all the SMUs, support 2-wire and 4-wire connections.

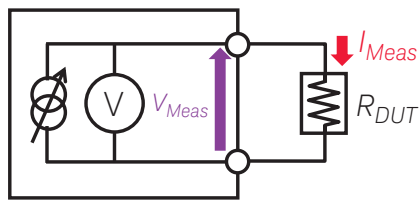

$$R_{Meas} = \frac{V_{Meas}}{I_{Meas}} = R_{DUT}$$

a) 2-wire connection ( $R_{DUT} \gg R_{Lead}$ )

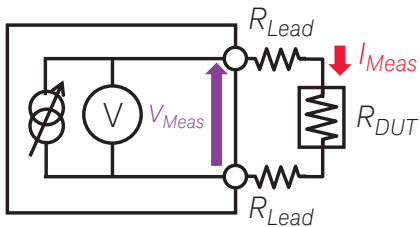

$$R_{Meas} = \frac{V_{Meas}}{I_{Meas}} = R_{DUT} + 2 \times R_{Lead}$$

b) 2-wire connection ( $R_{DUT} \approx R_{Lead}$ )

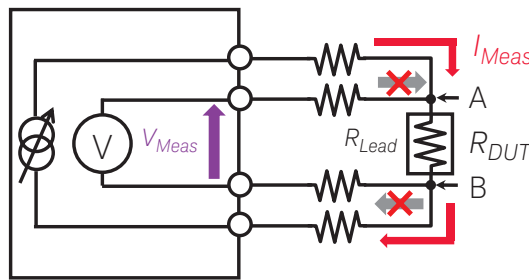

$$R_{Meas} = \frac{V_{Meas}}{I_{Meas}} = R_{DUT}$$

c) 4-wire connection

Figure 13. A 4-wire connection eliminates measurement errors caused by residual lead resistance

### Thermal electromotive force (EMF)

When measuring small resistances, the offset voltages inherent in the instrumentation and the thermal electromotive force (EMF) generated internally in the resistor or when you make circuit connections due to dissimilar metals at different temperatures, can create measurement inaccuracies. The junctions to consider are at the DUT, relay (such as multiplexers), and at the measurement instrument. Each metal-to-metal junction forms a thermocouple, which generates a voltage proportional to the junction temperature. Using all copper connections can minimize errors. An equivalent circuit model of these effects is shown in Figure 14a. Since the voltage drop across the DUT is small when measuring low resistances, the effects of the offset and EMF voltages are not negligible (see Figure 14b). Offset compensation can further minimize thermal EMF errors. Figure 13c illustrates the measurements used in offset compensated measurements. If you enable the offset compensation function, the instrument will automatically make a two point measurement and calculate the true value of the resistance using the following equation.

$$R_{comp} = \frac{V_2 - V_1}{I_2 - I_1}$$

Where,  $V_1$  is the measured voltage when the source is set to  $I_1$  (0 amps or open).  $V_2$  is the measured voltage when the source is set to the test current  $I_2$ . Offset compensation can be used in both 2-wire and 4-wire measurements. Using offset compensation improves measurement accuracy but reduces measurement speed. Some handheld DMMs, the 34420A, the B2900A series, and the B2980A series provide this function.

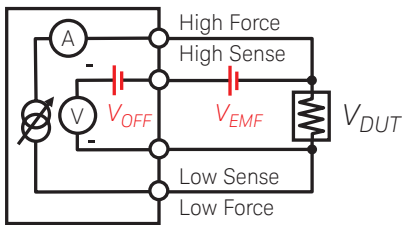

a) Error factor caused by the thermal EMF

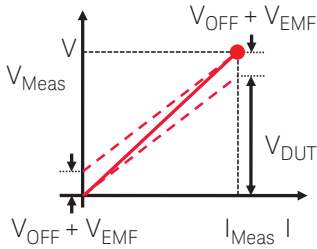

$$R_{Meas} = \frac{V_{Meas}}{I_{Meas}} = \frac{V_{DUT}}{I_{Meas}} + \frac{V_{OFF} + V_{EMF}}{I_{Meas}} = R_{DUT} + R_{Error}$$

b) Measurement without the offset compensation

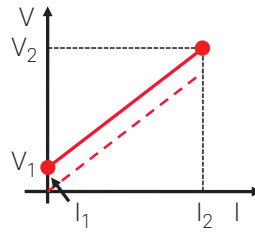

$$R_{Meas} = \frac{V_2 - V_1}{I_2 - I_1} = R_{DUT}$$

c) Effect of the offset compensation

Figure 14. Compensation to eliminate the effects of offset voltages and thermal electromotive forces

Another technique to suppress the effect of thermal EMF is to generate alternating polarity test currents known as the “Delta Method”, “Alternate Method”, or “Forward/Reverse Method”. This is important when measuring small resistances since errors due to offset voltages and EMF can significantly affect measurement accuracy (see Figure 15a). The following equation shows the impact of these errors on a resistance measurement made by sourcing current and measuring voltage:

$$R_{Meas} = \frac{V_{Meas}}{I_{Src}} = \frac{V_{DUT}}{I_{Src}} + \frac{V_{Error}}{I_{Src}} = R_{DUT} + R_{Error}$$

This error can be eliminated by applying both forward and reverse currents ( $I_{Src}$  and  $-I_{Src}$ ) and averaging the two voltage measurement results (see Figure 15b). The following equation shows how to use these two measurement results to calculate the true value of the resistance:

$$R_{Meas} = \frac{V_1 - V_2}{2 \times I_{Src}} = R_{DUT}$$

This can be realized by using the B2960A’s list sweep mode in combination with the 34420A, and a sample program is available at Keysight.com. See the following link for more details.

[www.keysight.com/find/low\\_resistance](http://www.keysight.com/find/low_resistance)

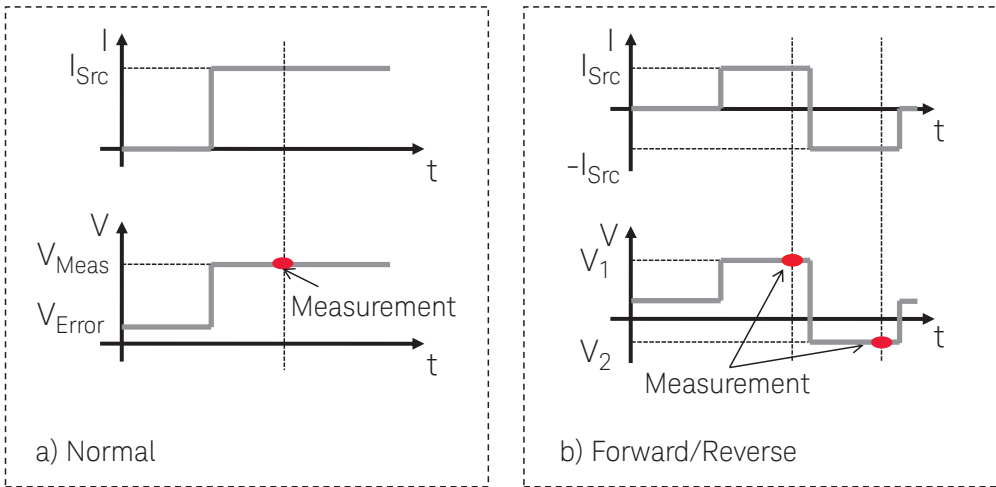

Figure 15. Technique to eliminate the measurement error caused by electro motive forces

## Power dissipation effects

When measuring resistors designed for temperature measurements or other resistive devices that vary in temperature, note that the instrument will dissipate some power in the DUT. The effects of this power dissipation can affect the measurement accuracy. Determining the appropriate test current is important because while a larger test current gives you better measurement resolution, it also increases the power dissipation and self-heating effects.

When you use DMMs, you can select a higher measurement range, one which uses a lower current source thereby reducing self-heating. Some DMMs, such as the 34420A offer a low power setting. Using the low power setting or a higher resistance range requires a DMM with good resolution.

When using the B2900A series or the B2960A series, you can select any test current in manual measurement mode, allowing you to make flexible measurements while maintaining measurement accuracy.

Figure 16 is a measurement example using a  $10\text{ m}\Omega$  metal foil resistor that exhibits a very small EMF. Measurements are made with various test currents using a combination of the B2961A and 34420A. The minimum power dissipation is  $1\text{ mW}$  with a test current of  $10\text{ mA}$ , and the maximum power dissipation is  $90\text{ mW}$  with a  $3\text{ A}$  test current. As Figure 16 shows, the  $10\text{ mA}$  test current result exhibits large fluctuations that prevent accurate characterization, while the other test current values display low enough noise levels to permit device evaluation. However, the test currents of  $1\text{ A}$  and  $3\text{ A}$  generate enough device self-heating to cause the measurement curves to shift over time. It therefore seems that a test current of about  $500\text{ mA}$  is appropriate for this measurement and that it strikes a good balance between measurement resolution and heat effects caused by power dissipation.

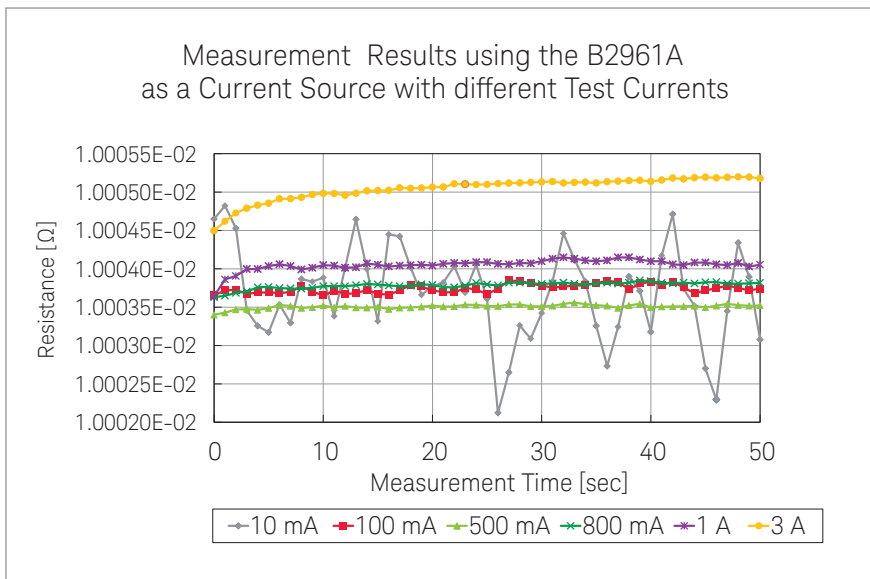

Figure 16. Measurement results using the B2961A as a current source with different test currents

## Output voltage clamping

Resistance measurements on certain types of contacts may require limitations on the voltage applied to the material during a resistance measurement. The voltage used to make the measurement and the open circuit voltage should be taken into consideration. The need for voltage limitation arises from the possibility that oxidation on the contact surfaces may increase the resistance reading. If the voltage is too high, the oxide layer may be punctured resulting in a lower resistance reading.

Although not all DMMs offer built-in voltage clamping circuits, the 34420A provides a programmable level of open circuit clamping. Voltage-limited measurements are available for the 10 and 100 ohm ranges. The open circuit voltage and measurement voltage can be clamped at one of three levels, 20 mV, 100 mV, or 500 mV.

An integral function of the B2900A series and the B2960A series is the capability to limit the measurement voltage. You can set any limit value for the measurement voltage allowing the instrument to operate by controlling the output mode to keep the voltage below the limited value while sourcing the test current.

## Settling time effects

Generally speaking, the measurement path contains some stray impedance, which causes current leakage and dielectric absorption when applying the voltage. This is particularly important if you are measuring resistances above 100 k $\Omega$ , since settling due to RC time constant effects can be quite long. Some precision resistors and multi-function calibrators use large parallel capacitors (1000 pF to 0.1  $\mu$ F) with high resistor values to filter out noise currents injected by their internal circuitry. Non-ideal capacitances in cables and other devices may have much longer settling times than expected through RC time constants, due to dielectric absorption. To wait for these to settle down, it is necessary to wait for an appropriate amount of time before starting the measurements. The required wait time before the measurement also depends on the voltage step. The larger a voltage step becomes, the longer the required wait time.

Modern DMMs are capable of inserting automatic measurement settling delays. These delays are sufficient for resistance measurements with less than 200 pF of a combined cable and device capacitance.

The B2900A series, the B2960A series and the B2980A series are capable of setting the measurement delay time manually in addition to the automatic measurement delay time function, which helps you to set the measurement delay time to optimize the measurement time and accuracy.

## Leakage current

The measurement path contains some stray impedance, which also causes current leakage. Current leakage in cables and test fixtures can cause significant measurement errors, especially when measuring large resistances (more than  $1\text{ G}\Omega$ ) where the measurement current is small (less than a nanoamp). In this case, a guarding technique is required to make an accurate measurement.

Guarding involves surrounding a signal line with an actively driven conductor maintained at the same voltage potential as that of the signal to eliminate current leakage. Good guarding can only be achieved using triaxial connectors and cabling. In a triaxial cable the signal line is surrounded by the guard line (separated by insulating material), which is in-turn surrounded by a grounded shield line (also separated by insulating material). The following illustration in Figure 17 shows a cut-away view of a triaxial cable. Guarding and triaxial connections are commonly used with SMUs and electrometers for high resistance measurements.

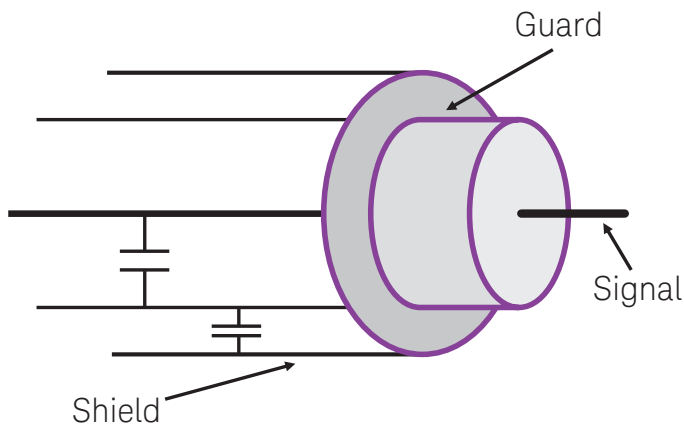

Figure 17. Cut-away view of a triaxial cable, showing parasitic capacitance between shield to guard and guard to signal

## Conclusion

Resistance measurements are one of the fundamental characterizations of materials, electronic devices, and circuits. Keysight Technologies offers a variety of resistance measurement solutions that cover a wide range of resistance from  $\mu\Omega$  to  $P\Omega$ , providing you with the best choice to suit your resistance measurement requirements. It is vital to select the appropriate instruments according to the characteristics of the DUT to acquire reliable measurement results.

## Comparison table: Keysight wide range resistance measurement solutions

### Versatile resistance measurement solutions

Model	Auto Mode					Manual Mode	Max. Reading rate	2 & 4-wire $\Omega$	Auto Offset Compensation	Low Power Setting
	Digits	Range	Min. Resolution	Accuracy						
Handheld DMM	U1231A U1232A U1233A	3 1/2	600 $\Omega$ - 60 M $\Omega$	100 m $\Omega$	0.9%+3 <sup>1</sup>	N/A	N/A	2-Wire $\Omega$ only	N/A	N/A
	U1241B U1242B	4	1 k $\Omega$ - 100 M $\Omega$	100 m $\Omega$	0.3%+3 <sup>1</sup>	N/A	N/A	2-Wire $\Omega$ only	N/A	N/A
	U1251B	4 1/2	500 $\Omega$ - 50 M $\Omega$	10 m $\Omega$	0.08%+5 <sup>1</sup>	N/A	N/A	2-Wire $\Omega$ only	N/A	N/A
	U1252B U1253B	4 1/2	500 $\Omega$ - 500 M $\Omega$	10 m $\Omega$	0.05%+5 <sup>1</sup>	N/A	N/A	2-Wire $\Omega$ only	N/A	N/A
	U1271A	4 1/2	300 $\Omega$ - 100 M $\Omega$	1 m $\Omega$	0.2%+5 <sup>1</sup>	N/A	N/A	2-Wire $\Omega$ only	N/A	N/A
	U1272A U1273A	4 1/2	30 $\Omega$ - 300 M $\Omega$	1 m $\Omega$	0.2%+5 <sup>1</sup>	N/A	N/A	2-Wire $\Omega$ only	■	N/A
	U1273AX	4 1/2	30 $\Omega$ - 300 M $\Omega$	1 m $\Omega$	0.2%+5 <sup>1</sup>	N/A	N/A	2-Wire $\Omega$ only	N/A	N/A
	Bench-top DMM	U3401A	4 1/2	500 $\Omega$ - 50 M $\Omega$	10 m $\Omega$	0.1%+3 <sup>2</sup>	N/A	N/A	2-Wire $\Omega$ only	N/A
U3402A		5 1/2	120 $\Omega$ - 120 M $\Omega$	1 m $\Omega$	0.05%+5 <sup>2</sup>	N/A	N/A	■	N/A	N/A
U3606B		5 1/2	100 $\Omega$ - 100 M $\Omega$	1 m $\Omega$	0.05%+0.005	N/A	26	■	N/A	N/A
34450A		5 1/2	100 $\Omega$ - 100 M $\Omega$	1 m $\Omega$	0.05%+0.005 <sup>3</sup>	N/A	190	■	N/A	N/A
34460A		6 1/2	100 $\Omega$ - 100 M $\Omega$	100 $\mu\Omega$	0.014%+0.001 <sup>3</sup>	N/A	300	■	N/A	N/A
34461A		6 1/2	100 $\Omega$ - 100 M $\Omega$	100 $\mu\Omega$	0.010%+0.001 <sup>3</sup>	N/A	1000	■	N/A	N/A
34465A		6 1/2	100 $\Omega$ - 1 G $\Omega$	100 $\mu\Omega$	0.0040% + 0.0005 <sup>3</sup>	N/A	50000	■	N/A	■
34470A		7 1/2	100 $\Omega$ - 1 G $\Omega$	10 $\mu\Omega$	0.0040% + 0.0005 <sup>3</sup>	N/A	50000	■	N/A	■
SMU	B2901A B2902A	6 1/2	2 $\Omega$ - 200 M $\Omega$	1 $\mu\Omega$	0.06%+0.0175 <sup>3</sup>	■	50000	■	■	N/A <sup>4</sup>
	B2911A B2912A						100000			

1. The accuracy is defined as  $\pm$  (% of reading + counts of Least Significant Digit)
2. The accuracy is defined as  $\pm$  (% of reading + count)
3. The accuracy is defined as  $\pm$  (% of reading + % of range)
4. Manual mode enables you to use smaller test current

## Comparison table: Keysight wide range resistance measurement solutions (continued)

### Low Resistance Measurement Solutions

Model	Auto Mode				Manual Mode	Max. Reading rate	2 & 4-wire $\Omega$	Auto Offset Compensation	Low Power Setting
	Digits	Range	Min. Resolution	Accuracy					
34420A	7 1/2	1 $\Omega$ - 1 M $\Omega$	100 n $\Omega$	0.0060%+0.0002 <sup>3</sup>	N/A	250	■	■	■
34420A with B2961A	7 1/2	1 $\Omega$ - 1 M $\Omega$ <sup>5</sup>	100 n $\Omega$ <sup>5</sup>	0.0060%+0.0002 <sup>5</sup>	■	N/A	■ <sup>5</sup>	■ <sup>5</sup>	■ <sup>5</sup>

### High Resistance Measurement Solutions

Model	Auto Mode				Manual Mode	Max. Reading rate	2 & 4-wire $\Omega$	Auto Offset Compensation	Low Power Setting	
	Digits	Range	Min. Resolution	Accuracy						
Insulation Resistance Tester	U1451A	3 1/2	66 G $\Omega$	1 k $\Omega$	1.5%+5 <sup>1</sup>	N/A	N/A	2-Wire $\Omega$ only	N/A	N/A
	U1452A	3 1/2	260 G $\Omega$	1 k $\Omega$	1.5%+5 <sup>1</sup>	N/A	N/A	2-Wire $\Omega$ only	N/A	N/A
	U1452AT	3 1/2	66 G $\Omega$	1 k $\Omega$	1.5%+5 <sup>1</sup>	N/A	N/A	2-Wire $\Omega$ only	N/A	N/A
	U1453A	3 1/2	260 G $\Omega$	1 k $\Omega$	1.2%+5 <sup>1</sup>	N/A	N/A	2-Wire $\Omega$ only	N/A	N/A
	U1461A	3 1/2	260 G $\Omega$	1 k $\Omega$	1.2%+5 <sup>1</sup>	N/A	N/A	2-Wire $\Omega$ only	N/A	N/A
Electrometer	B2985A B2987A	6 1/2	1 M $\Omega$ - 1 P $\Omega$	1 $\Omega$	0.135%+0.0001 <sup>3</sup>	■	20000	2-Wire $\Omega$ only	■ <sup>6</sup>	N/A <sup>7</sup>

1. The accuracy is defined as  $\pm$  (% of reading + counts of Least Significant Digit)
2. The accuracy is defined as  $\pm$  (% of reading + count)
3. The accuracy is defined as  $\pm$  (% of reading + % of range)
4. Manual mode enables you to use smaller test current
5. Values when the 34420A is used as standalone
6. Offset compensation function is provided as math function
7. Manual mode enables you to use smaller test current



## Evolving Since 1939

Our unique combination of hardware, software, services, and people can help you reach your next breakthrough. We are unlocking the future of technology.

From Hewlett-Packard to Agilent to Keysight.

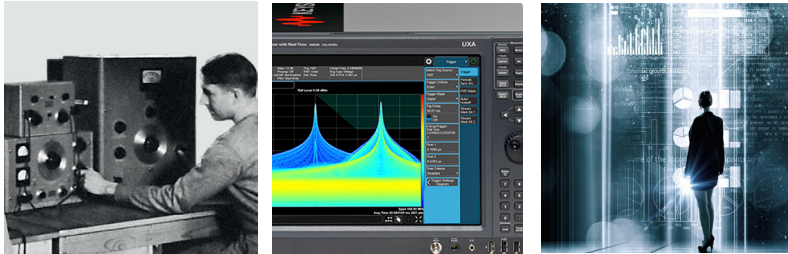

For more information on Keysight Technologies' products, applications or services, please contact your local Keysight office. The complete list is available at: [www.keysight.com/find/contactus](http://www.keysight.com/find/contactus)

### Americas

Canada	(877) 894 4414
Brazil	55 11 3351 7010
Mexico	001 800 254 2440
United States	(800) 829 4444

### Asia Pacific

Australia	1 800 629 485
China	800 810 0189
Hong Kong	800 938 693
India	1 800 11 2626
Japan	0120 (421) 345
Korea	080 769 0800
Malaysia	1 800 888 848
Singapore	1 800 375 8100
Taiwan	0800 047 866
Other AP Countries	(65) 6375 8100

### Europe & Middle East

Austria	0800 001122
Belgium	0800 58580
Finland	0800 523252
France	0805 980333
Germany	0800 6270999
Ireland	1800 832700
Israel	1 809 343051
Italy	800 599100
Luxembourg	+32 800 58580
Netherlands	0800 0233200
Russia	8800 5009286
Spain	800 000154
Sweden	0200 882255
Switzerland	0800 805353
	Opt. 1 (DE)
	Opt. 2 (FR)
	Opt. 3 (IT)
United Kingdom	0800 0260637

For other unlisted countries: [www.keysight.com/find/contactus](http://www.keysight.com/find/contactus) (BP-9-7-17)

**DEKRA Certified**  
ISO 9001 Quality Management System

[www.keysight.com/go/quality](http://www.keysight.com/go/quality)  
Keysight Technologies, Inc.  
DEKRA Certified ISO 9001:2015  
Quality Management System

### myKeysight

#### myKeysight

[www.keysight.com/find/mykeysight](http://www.keysight.com/find/mykeysight)

A personalized view into the information most relevant to you.

[www.keysight.com/find/emt\\_product\\_registration](http://www.keysight.com/find/emt_product_registration)

Register your products to get up-to-date product information and find warranty information.

### KEYSIGHT SERVICES

Accelerate Technology Adoption.  
Lower costs.

#### Keysight Services

[www.keysight.com/find/service](http://www.keysight.com/find/service)

Keysight Services can help from acquisition to renewal across your instrument's lifecycle. Our comprehensive service offerings—one-stop calibration, repair, asset management, technology refresh, consulting, training and more—helps you improve product quality and lower costs.



#### Keysight Assurance Plans

[www.keysight.com/find/AssurancePlans](http://www.keysight.com/find/AssurancePlans)

Up to ten years of protection and no budgetary surprises to ensure your instruments are operating to specification, so you can rely on accurate measurements.

#### Keysight Channel Partners

[www.keysight.com/find/channelpartners](http://www.keysight.com/find/channelpartners)

Get the best of both worlds: Keysight's measurement expertise and product breadth, combined with channel partner convenience.

[www.keysight.com/find/b2900a](http://www.keysight.com/find/b2900a)



Unlocking Measurement Insights

This information is subject to change without notice.  
© Keysight Technologies, 2017  
Published in USA, December 1, 2017  
5992-1212EN  
[www.keysight.com](http://www.keysight.com)