

Keysight Technologies

Evaluating Oscilloscopes to Debug Mixed-Signal Designs

Application Note

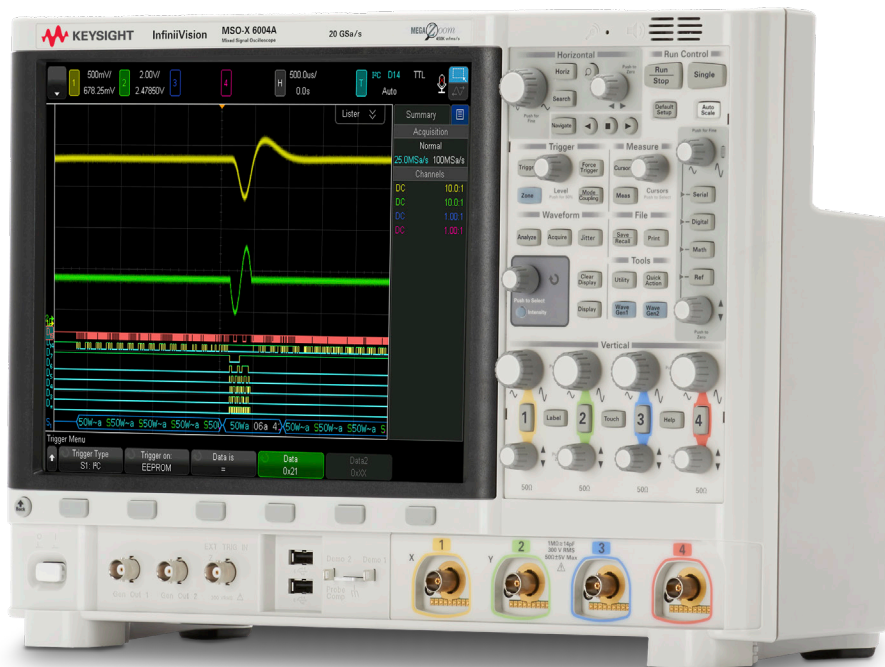

Unlocking Measurement Insights



Introduction

Today's embedded designs based on microcontrollers (MCUs), FPGAs, and digital signal processors (DSPs) often include a combination of analog and digital signal content. Design engineers have traditionally used both oscilloscopes and logic analyzers to test and debug these mixed-signal embedded designs, but a class of measurement tools known as mixed signal oscilloscopes (MSOs) may offer a better way for you to debug your MCU-, FPGA-, and DSP-based designs.

Although MSOs have been on the market for nearly twenty years, most engineers have never used one, and many engineers have misconceptions about their benefits and use model. With more oscilloscope vendors introducing hybrid time-domain instruments that merge time-correlated analog and digital measurement capabilities, it is important that you understand the differences between these instruments and that you are aware of what they can and cannot do.

This paper begins by defining mixed signal oscilloscopes, including an overview of the primary applications where MSOs can be used. This paper discusses the number of channels, bandwidth, and sample rates required to effectively monitor various analog and digital I/O signals in typical MCU/FPGA/DSP-based designs, as well as covers the various types of mixed-signal triggering you should look for in an MSO in order to effectively test and debug embedded designs. Using an example of a mixed-signal embedded design based on a 16-bit-wide instruction-set microcontroller (Microchip PIC18). This paper also provides a typical turn-on and debugging methodology using an MSO to verify proper signal quality.

Table of Contents

Introduction	2
What is a Mixed Signal Oscilloscope (MSO)?	3
Typical MSO Measurement Applications and Required Performance	5
Triggering On Mixed Signals	8
Turning On and Debugging a Real Mixed-Signal Embedded Design	10
Summary	14
Glossary	15
Related Literature	16

What is a Mixed Signal Oscilloscope (MSO)?

An MSO is a hybrid test instrument that synergistically combines all of the measurement capabilities of a digital storage oscilloscope (DSO) (including autoscale, trigger holdoff, infinite-persistence on analog and digital channels, and probe/channel de-skew), with some of the measurement capabilities of a logic analyzer—into a single instrument. With an MSO, you are able to see multiple time-aligned analog and digital waveforms on the same display, as shown on each of the oscilloscopes in Figure 1. Although an MSO may lack many of the advanced digital measurement capabilities and the large number of digital acquisition channels of a full-fledged logic analyzer, MSOs have some unique advantages over both traditional oscilloscopes and logic analyzers for many of today’s embedded design debugging applications.

One of the primary advantages of an MSO is its use model. You use an MSO in much the same way you use an oscilloscope. Design and test engineers often avoid using a logic analyzer—even when one may be required to effectively debug a complex design—because of the time required to learn, or relearn, how to use one. Even if an engineer knows how to use a logic analyzer, setting one up to make particular measurements usually takes much longer than setting up oscilloscope measurements. And finally, the advanced measurement capabilities of a logic analyzer add complexity and are often overkill for many of today’s MCU-, FPGA-, and DSP-based designs.

Oscilloscopes are the most commonly used test instruments in an R&D environment. All embedded hardware design engineers should have a basic operating knowledge of how to use an oscilloscope to make fundamental signal-quality and timing measurements of their mixed-signal embedded designs. However, 2- and 4- channel oscilloscope measurements are often insufficient to monitor and test critical timing interactions between multiple analog and digital signals. This is where an MSO proves useful.

Because an MSO provides “just enough” logic analyzer measurement capability without adding too much complexity, it is often just the right tool for debugging embedded designs. And as previously mentioned, the use-model of an MSO is that of an oscilloscope. In fact, an MSO can simply be thought of as a multi-channel oscilloscope with some channels (analog) providing lots of vertical resolution (typically 8-bits), with several additional channels (logic/digital) providing low-resolution (1 bit) measurements. A highly integrated MSO, as opposed to a loosely tethered two-box, mixed-signal measurement solution, should be user-friendly, provide fast waveform update rates, and operate more like an oscilloscope—not like a logic analyzer.

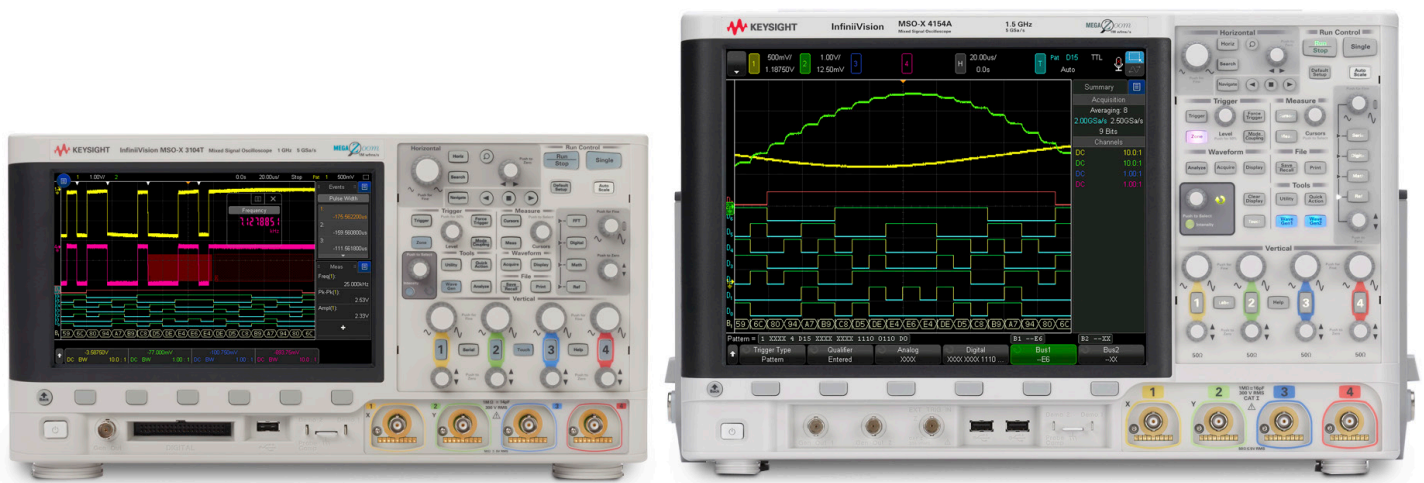

Figure 1. Keysight InfiniiVision X-Series mixed signal oscilloscope (MSO).

What is a Mixed Signal Oscilloscope (MSO)? (Continued)

One important characteristic of all oscilloscopes is waveform update rate, which can directly affect the usability of an instrument. Attempting to operate an oscilloscope that is slow and unresponsive can be frustrating, and sluggish response limits usability. This applies to DSOs as well as MSOs. This means that when oscilloscope vendors port logic acquisition channels into a DSO to create an MSO, waveform update rates should not be sacrificed. Otherwise, the traditional oscilloscope use-model will also be sacrificed. Mixed-signal measurement solutions based on two-box solutions and/or external logic pods linked via an external communication bus such as USB tend to be very unresponsive and difficult to use. MSOs based on a highly integrated hardware architecture will tend to be much more responsive and easier to use.

For more detailed information about the importance of waveform update rates, download the Keysight Technologies, Inc. application note, "Oscilloscope Waveform Update Rate Determines Probability of Capturing Elusive Events" (listed at the end of this document).

Although the first step in evaluating which MSO to purchase may be to compare features and measurement performance in each vendor's printed and online literature (data sheets), the only way to truly evaluate the usability and responsiveness of an instrument is to actually use it yourself.

Typical MSO Measurement Applications and Required Performance

Although MSOs are a great tool for capturing analog and digital signals on mixed-signal devices such as analog-to-digital converters (ADCs) and digital-to-analog converters (DACs), their primary measurement applications involve verifying and debugging MCU/FPGA/DSP-based mixed-signal designs that have embedded address and data buses. Figure 2 shows a block diagram of a typical mixed-signal embedded design with a microcontroller at its core.

Although microcontrollers and DSPs are often thought of as simply digital control and processing devices, most MCUs, FPGAs, and DSPs today are actually mixed-signal devices that often include embedded analog circuitry. Signals that need to be monitored and verified in systems such as this include analog I/O, digital parallel I/O ports, and digital serial communication buses, such as I²C and SPI.

Note that the block diagram shown in Figure 2 does not show any address or data bus signals. This is because most MCUs and DSPs have an internal bus structure that also includes embedded memory (RAM and ROM).

Because today's MSOs typically feature 16 channels of digital acquisition, some engineers mistakenly assume that MSOs are limited to 8-bit processing applications (8 bit data + 8 bit address = 8 to 16 channels). But MSOs are primarily used to monitor analog and digital I/O, which are usually all the signals that are available in MCU- and DSP-based designs. Don't attempt to relate the number of digital channels of acquisition in an MSO to the number of bits of processing in an internal bus-based MCU or DSP, because it's usually irrelevant. Sixteen channels of digital acquisition, along with two to four channels of analog acquisition and triggering, is usually more than enough to monitor and verify specific/dedicated functions of 8-bit, 16-bit, and even 32-bit MCU/DSP-based designs.

Although, monitoring parallel address and data lines in an external bus-based design, such as a computer based on a 32-bit microprocessor, is not the primary measurement application of MSOs.

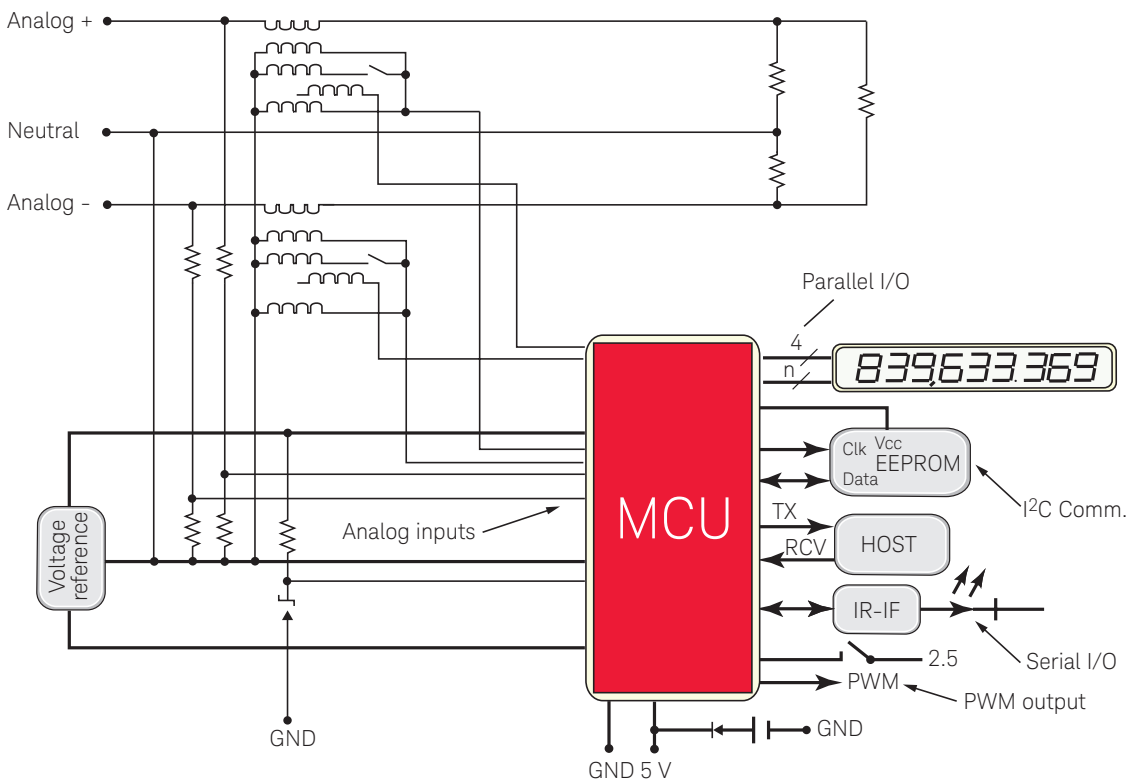

Figure 2. Typical MCU-based embedded design.

Typical MSO Measurement Applications and Required Performance (Continued)

If you need to capture multiple address and data bus signals to verify timing and source-code flow in an external bus-based system, a logic analyzer with state analysis and disassembly may be a better measurement tool for you. And if you also need to time-correlate analog signals and/or analog characteristics of digital signals at the same time, there are two-box solutions (scope + logic analyzer) available from multiple vendors that will import oscilloscope waveforms into the logic analyzer with a time-correlated display. But with this type of higher-performance two-box test solution, you must also accept the more complex use-model of a logic analyzer including slow or single-shot waveform update rates.

But even in 32-bit systems with external memory devices, an MSO with 16 logic-timing channels, along with 2 to 4 analog channels, can often be sufficient to measure critical timing parameters. Figure 3 shows an example of how an MSO was used to verify a high-speed memory device (SDRAM) setup time in a 32-bit system (IBM PowerPC 405GP). Only four digital channels of the MSO were required to qualify the measurement on specific read and write instructions (CS, RAS, CAS, and WE) using the MSO's pattern triggering capabilities. The oscilloscope's analog channels were used to further qualify triggering on an edge of the high-speed clock signal and to perform critical timing measurements on the 100 MHz clock signal (top/yellow trace) relative to a particular data signal (middle/green trace), resulting in a measured setup time of 8 ns on this external memory device. This particular measurement would be impossible to perform with a conventional 2- or 4-channel DSO, and it would be a time-consuming task with a logic analyzer linked to a high-speed oscilloscope.

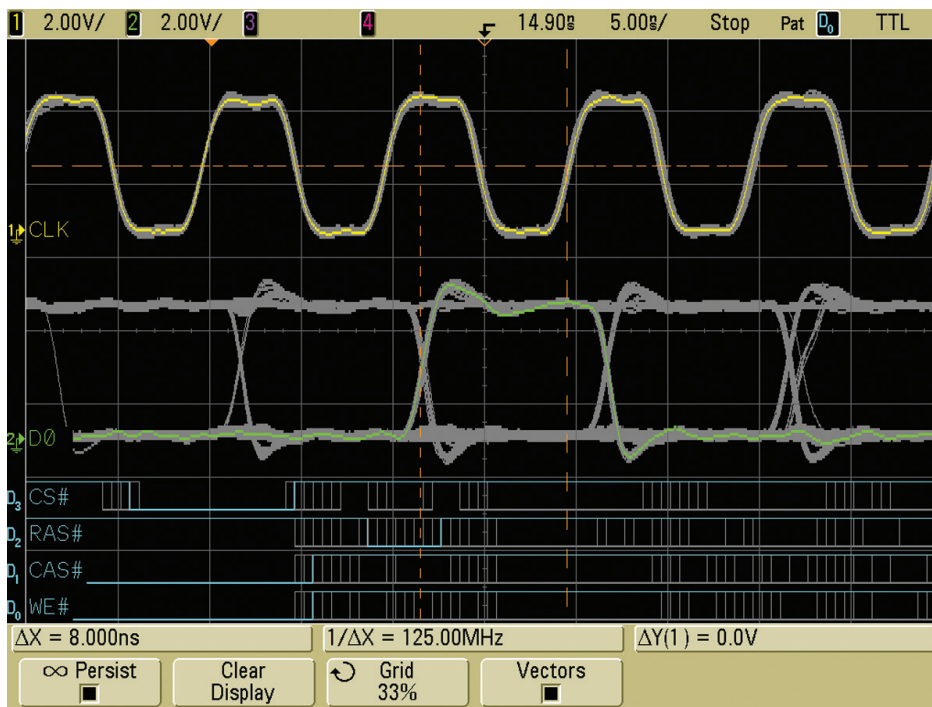

Figure 3. Performing a critical setup time measurement in a 32-bit system using an MSO.

Typical MSO Measurement Applications and Required Performance (Continued)

The analog and digital acquisition performance of the MSO is typically more important than the number of channels for these types of signal integrity measurements in mixed-signal embedded designs. The most fundamental specifications of an oscilloscope's analog acquisition performance are bandwidth and sample rate. For reasonably accurate analog measurements, an oscilloscope's bandwidth should be at least five times the highest clock rate in your system. For instance, if you need to monitor a digital signal with a maximum toggle/clock frequency of 200 MHz with your oscilloscope's analog channels, you need an analog bandwidth of 1 GHz in order for the scope to capture the fifth harmonic with reasonable accuracy. And for real-time/single-shot measurements, the sample rate should be approximately four times higher than the oscilloscope's bandwidth, or faster. For more detailed information about the relationship between bandwidth and sample rate, download Keysight's application note "Choosing an Oscilloscope with the Right Bandwidth for your Application," and application note "Evaluating Oscilloscope Sample Rate vs. Sampling Fidelity: How to make the most Accurate Digital Measurements" (listed at the end of this document).

Unfortunately, some oscilloscope and logic analyzer users do not fully comprehend the required digital acquisition performance of MSOs and logic analyzers. It is important for the digital acquisition performance of an MSO to be commensurate with the oscilloscope's analog acquisition performance. It just doesn't make sense to combine a high-performance oscilloscope with a low-performance logic-timing analyzer. Keysight recommends that an MSO's digital/logic acquisition system provide sample rates that are at least twice the bandwidth of the oscilloscope's analog channels of acquisition. For the example we just discussed where a 1 GHz oscilloscope is required to capture analog characteristic of digital signals with toggle/clock rates of 200 MHz, capturing the same signals on the logic/digital channels of the MSO with reasonable timing accuracy requires a 2 GSa/s sample rate on the digital/logic channels.

When you use logic/digital acquisition channels, measurement resolution is limited to plus or minus one sample period. For example, if you are attempting to capture digital signals with a maximum toggle/clock rate of 200 MHz (period = 5 ns), each high or low pulse can be as narrow as 2.5 ns (assuming a 50% duty cycle). This means that if your MSO's digital acquisition system samples at a maximum rate of 2 GSa/s, then timing measurements on each edge of a pulse can be in error by as much as ± 500 ps producing a worst-case peak-to-peak error of 1 ns for delta-time measurements, which is 40% error on a 2.5 ns pulse. We believe that exceeding 40% timing errors is unacceptable for digital acquisition channels of an MSO or logic analyzer, which is why we recommend that digital channel acquisition sample rates be at least twice the bandwidth of the oscilloscope, or higher.

In addition to bandwidth and sample rate, another critical factor to consider is probing bandwidth, including both analog and digital system probing. Capturing analog or digital signals with significant frequency content in excess of 500 MHz requires active probing on analog channels. Likewise, digital acquisition systems must have probes that can deliver higher frequency signals to the digital system's sampling circuitry in order to reliably capture every pulse within higher frequency pulse trains.

Triggering On Mixed Signals

More channels of acquisition in an MSO (compared to a DSO) means that you now have more triggering possibilities in order to zero-in on specific analog and digital I/O signal interaction. Although an MSO can't even begin to approach the complex triggering capabilities of a high-performance logic analyzer, MSO triggering goes far beyond the limited triggering of a standard 2- or 4-channel oscilloscope.

Most MSOs and mixed-signal measurement solutions on the market today are able to trigger on at least one level of parallel pattern trigger conditions, and some provide up to two levels of pattern sequence triggering with reset conditions. But even when you use relatively simple one-level pattern triggering, you will find big differences in triggering capabilities between various MSOs/ mixed-signal measurement solutions. First of all, it is important that an MSO is able to trigger on a combination of analog and digital inputs. Some loosely tethered mixed-signal measurement solutions are only able to reliably trigger across one side of the acquisition system or the other due to significant signal skew between analog channels and logic channels. In other words, you may only be able to trigger your oscilloscope on a traditional analog trigger condition, or trigger on just a parallel digital condition—not both. MSOs should provide mixed-signal triggering capabilities with precise time-alignment between analog channels and digital channels of triggering. Later in this paper we will show an example where it is necessary to trigger on mixed-signal conditions in order to synchronize the oscilloscope's acquisition on a specific output phase of a DAC controlled by an MCU.

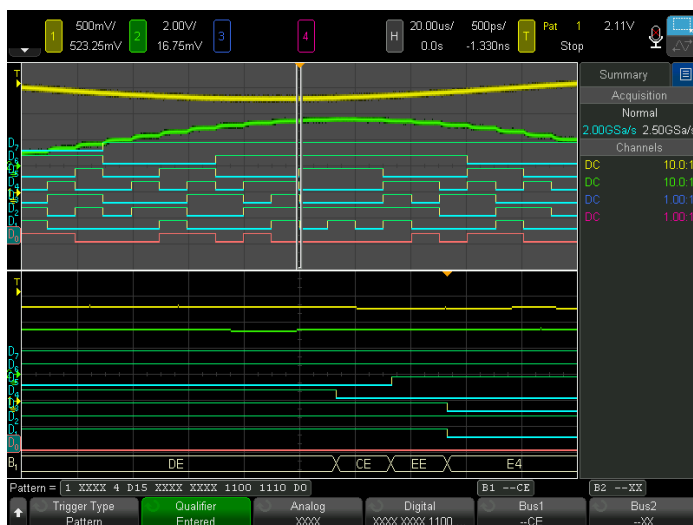

Figure 4. Without minimum time qualification set, the MSO is triggering on an unstable transitional state.

Another important factor to consider in an MSO is whether or not its pattern triggering includes any type of time qualification. In addition to entry and/or exit trigger qualification, pattern trigger conditions should also include a minimum time-qualification condition. An easy way to illustrate this is by triggering on a non-stable transition state, and then showing what tools the oscilloscope provides to avoid it. Figure 4 shows a Keysight 6000 X-Series MSO triggering on pattern CE (1100 1110). By looking at the top portion of the display, which shows a better overall image of the signal, we can see that states CE and EE are transitional, unstable states between DE and E4 on the bus. There is a high likelihood that this is not the condition the user wants to trigger on. The Qualifier menu allows the user to set time thresholds, where the triggered state must exist for longer or shorter than a specific time, or within or outside a range of times.

Minimum time qualification is important in order to avoid triggering on transitional/unstable conditions. When parallel digital signals change states, switching may be nearly simultaneous—but not exactly simultaneous. In addition to limited rising and falling edge speeds when signals are neither high nor low, there may also be slight delays between signals even in the best-designed systems. This means that there will always be transitional/unstable signal conditions in your system when signals are switching. You will probably want your DSO/MSO or logic analyzer to avoid triggering on these unstable conditions if possible.

Oscilloscopes (including MSOs) have the ability to precisely trigger at analog trigger level/threshold crossing points, while logic analyzers typically use sample-based triggering. Sample-based triggering produces a peak-to-peak trigger jitter/ uncertainty of plus or minus one sample period (worst-case peak-to-peak uncertainty = 2 sample periods). By “sample-based triggering,” we mean that the instrument randomly samples the input signal first, and then establishes a trigger reference point based on sampled data. This type of triggering, which produces significant trigger jitter, may be sufficient for some typical logic analyzer measurements, but is unacceptable for either conventional oscilloscope or MSO measurements for viewing repetitive signals.

Triggering On Mixed Signals (Continued)

Figure 5 shows an example of an oscilloscope with a mixed-signal option that generates trigger events based on sampled data. Figure 6 shows an example of a Keysight MSO that utilizes analog hardware comparator triggering across all analog and digital input signals.

In this mixed-signal measurement example, each oscilloscope has been set up to trigger on a specific 8-bit pattern condition of an MCU's digital output port synchronized to a rising edge occurrence on digital-input channel D4 (A4). In order to measure the signal integrity of the D4 (A4) signal, an analog channel of the oscilloscope has been set up to "double probe" this same digital signal. As you can see in Figure 5, the scope that digitally triggers based on sampled data generates approximately 4 ns of peak-to-peak trigger jitter, since its maximum digital/logic-channel sample rate is just 500 MSa/s (± 1 sample period of uncertainty). Notice the 4 ns of peak-to-peak "smear" in the repetitive analog trace (middle/green trace) using this oscilloscope infinite-persistence display mode.

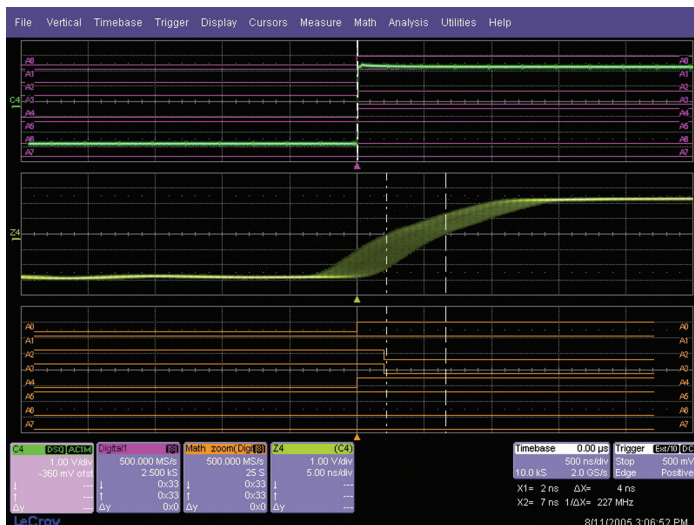

Figure 5. Sample-based pattern triggering generates 4 ns of trigger jitter (LeCroy WaveRunner with MSO option).

Figure 6 shows the same repetitive triggering measurements using a Keysight MSO that generates trigger events based on real-time analog comparator hardware technology—not sample-based triggering. With the oscilloscope set at 5 ns/div, we can observe a very stable analog trace using this scope's infinite-persistence display mode, even though triggering was established across just the digital/logic-channel inputs of the oscilloscope. We can now make much more accurate signal integrity measurements on this repetitive input signal using one of the analog input channels.

The last thing to consider when evaluating various MSOs/mixed signal measurement solutions for your mixed-signal embedded applications is whether or not the oscilloscope is able to trigger on specific address and data transmissions of serial I/O such as I²C and SPI. Serial I/O is very prevalent in today's embedded designs. In the next section of this paper, we will show an example where serial triggering was required to synchronize oscilloscope acquisitions on specific analog output "chirp" signals based on serial input commands in a mixed-signal embedded design.

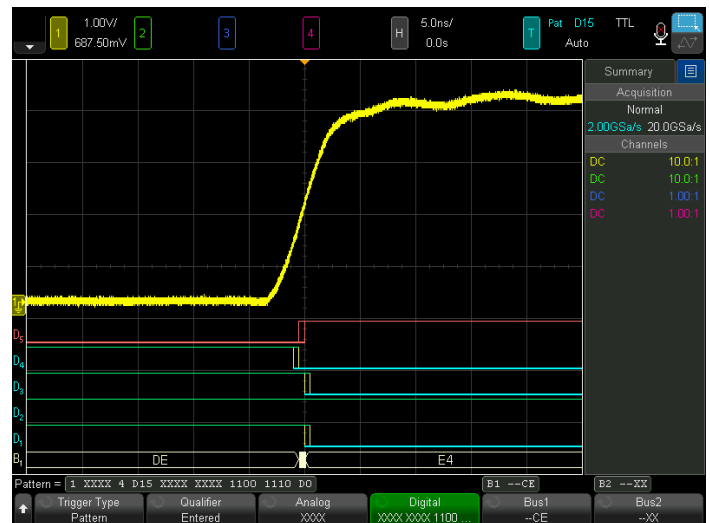

Figure 6. Real-time comparator hardware pattern triggering in a Keysight MSO generates very low trigger jitter.

Turning On and Debugging a Real Mixed-Signal Embedded Design

We will now look at the turn-on and debugging process of a mixed-signal embedded product designed by Solutions-Cubed of Chico, California (USA). Figure 7 shows a block diagram of this product.

At the core of this mixed-signal embedded product is a Microchip PIC18F452-PT microcontroller, which operates on an internal 16-bit instruction set. Since this particular MCU has an internal bus structure and includes an embedded analog-to-digital converter (ADC), this mixed-signal device and its associated external circuitry provides a perfect example of using an MSO to turn-on and debug an embedded mixed-signal design.

The ultimate goal of this design was to generate various length, shape, and amplitude analog “chirp” output signals based on a variety of analog, digital, and serial I/O input conditions. (A “chirp” is an RF pulsed analog output signal consisting of a specific number of cycles often found in aerospace/defense and automotive applications.) The MCU simultaneously monitors the following three inputs to determine the characteristics of the output chirp signal:

1. The status of the system control panel is monitored with one of the MCU’s available parallel digital I/O ports to determine the shape of the output-generated chirp signal (sine, triangular, or square wave).
2. The output level of an acceleration analog input sensor is monitored via one of the MCU’s available ADC inputs to determine the amplitude of the output-generated chirp signal.
3. The status of the serial I²C communication link is monitored with the MCU’s dedicated I²C serial I/O port to determine the number of pulses to be generated in the output chirp. This I²C communication input signal is generated from another intelligent sub-system component from within this embedded design.

Depending on the status of these three analog, digital, and serial inputs, the MCU has been programmed to generate a series of parallel output signals to an external 8 bit DAC to create an analog chirp signal of various amplitudes, shapes, and lengths. The unfiltered stair-step output of the DAC is then fed through an analog low-pass filter to smooth the output signal and reduce noise. In addition, this analog filter induces a predetermined amount of phase shift to the input signal. Finally, the MCU generates a parallel digital output via another available digital I/O port to drive an LCD display that provides the user with system status information.

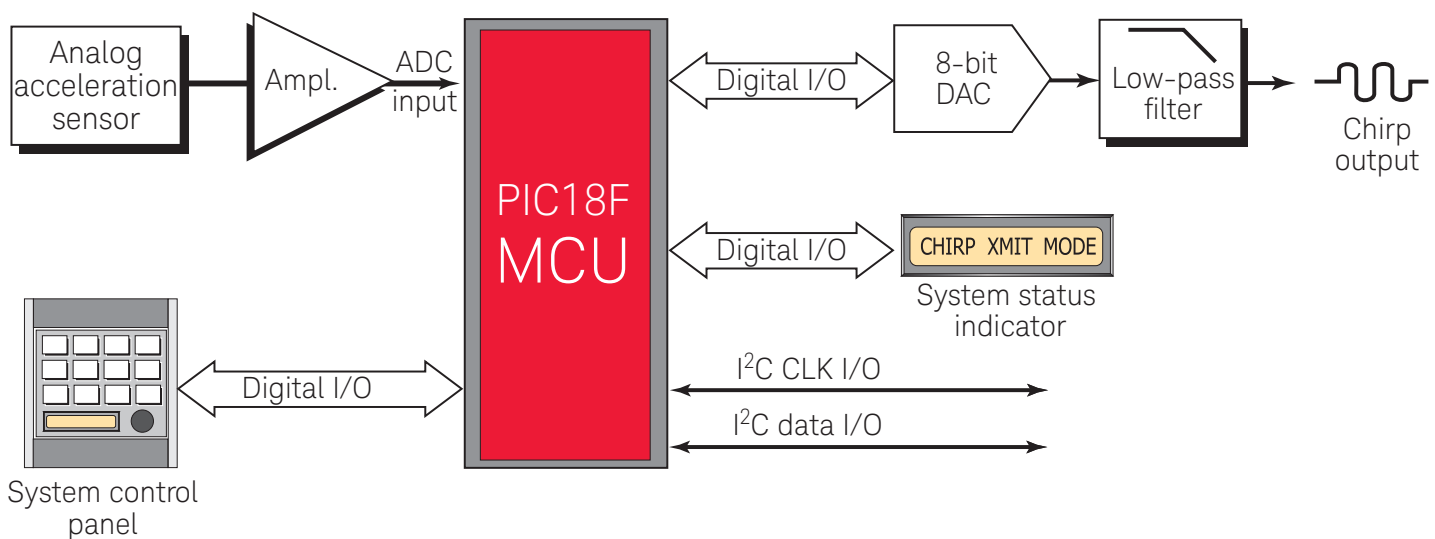

Figure 7. Mixed-signal embedded design that generates analog “chirp” outputs based on analog, digital, and serial I/O.

Turning On and Debugging a Real Mixed-signal Embedded Design (Continued)

The first step in designing/programming the MCU in this design was to configure the MCU's I/O for the appropriate number of analog and digital I/O ports. Note that the embedded designer can trade-off the number of analog I/O for digital I/O ports and vice versa in this particular microcontroller from MicroChip.

Before attempting to code the MCU to monitor various inputs and generate the final specified output signals, the design team decided it might be best to first develop test code to turn on one section/function of the product at a time and verify proper operation and signal integrity before adding interactive complexity. The first section/function turned on and debugged was the external DAC inputs and output and analog filter. In order to verify proper operation of this circuitry and internal firmware, the MCU was coded to generate a continuous/repetitive sine wave of fixed amplitude, regardless of the input signal conditions.

Figure 8 shows a screen image from a Keysight InfiniiVision Series MSO capturing both the continuous digital inputs to the external DAC (output of MCU digital I/O port), and the stair-step output of the DAC and analog filtered output. Since this particular signal was a relatively low-level output signal utilizing just 16 levels of the 8-bit DAC (256 levels max), we can easily view the stair-step output characteristics of this converter on the oscilloscope's display (green trace).

This particular acquisition was set up to trigger when the DAC's output reached its highest output level (center-screen). Triggering at this particular point using conventional oscilloscope triggering would be impossible, since it requires edge transitions. Triggering at this point/phase of the output signal was achieved by establishing a simple one-level pattern trigger condition on the digital input signals that were coincident with the highest output analog level of the external DAC. To trigger at this precise point in the waveform, the designer entered a parallel binary pattern of "1110 0110." Since this MSO employs time-qualified pattern triggering, the oscilloscope always triggered at the beginning of the specified pattern and never triggered on unstable/transitional conditions.

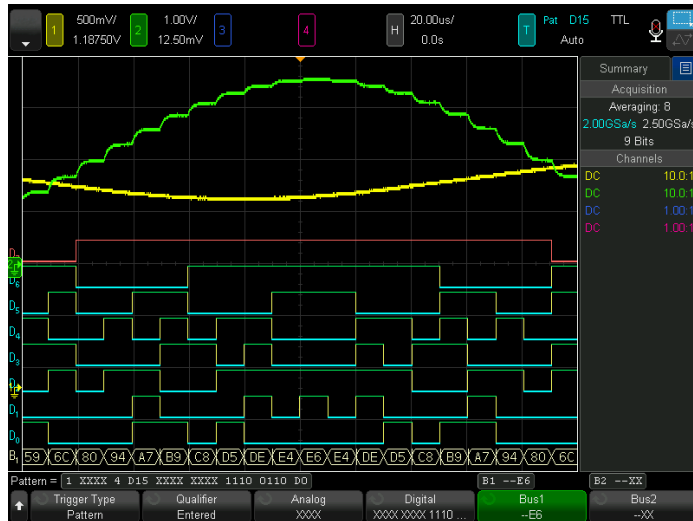

Figure 8. Keysight InfiniiVision Series MSO captures parallel digital input and analog output of MCU-controlled DAC.

Turning On and Debugging a Real Mixed-signal Embedded Design (Continued)

Figure 9 shows a trigger condition of the MSO set to trigger precisely at the DAC's 50% output level point using pattern triggering on the parallel digital input signals in addition to an analog trigger condition. As we mentioned earlier, not all MSOs/mixed-signal measurement solutions permit combinational mixed-signal triggering on both analog and digital conditions. But since there are two analog output conditions at the same level (50% rising level and 50% falling level), triggering coincident with either the rising or falling point required more than just pattern triggering on the 8-bit input pattern. With the addition of qualifying on a "0" level on analog channel 1 (top/yellow trace), the scope was able to trigger at the desired phase using a combination of analog and digital pattern triggering. Note that analog signals are considered "1" when they are above the analog trigger level and "0" when they are below the trigger level.

Also shown in Figure 9 are automatic parametric measurements on the filtered output signal including amplitude, frequency, and phase shift relative to the unfiltered DAC output.

After turning on and verifying proper operation of the external DAC and analog filtering, the next step in this design/turn-on process was to write code to generate a specific number of non-repetitive sine wave pulses (chirps) based on a serial I²C input. Figure 10 shows an overlay (infinite-persistence) of various length chirps using standard oscilloscope edge triggering. Unfortunately, with conventional oscilloscope edge triggering it is impossible to qualify triggering on specific length chirps.

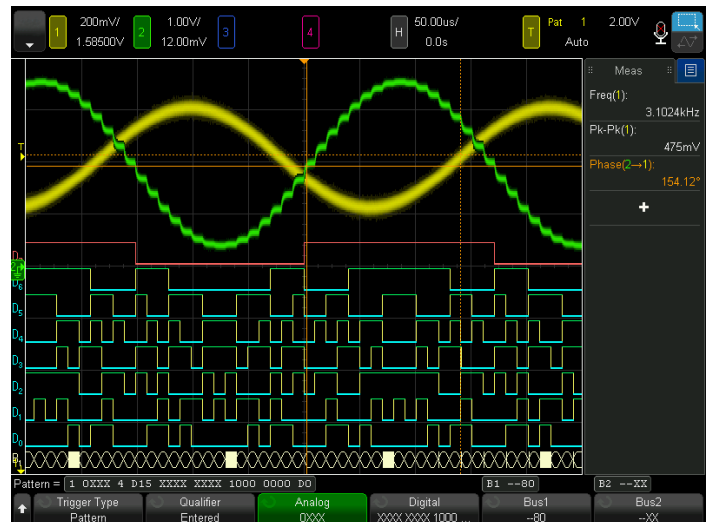

Figure 9. Keysight MSO triggers at the 50% crossing point using a combination of analog AND digital pattern triggering.

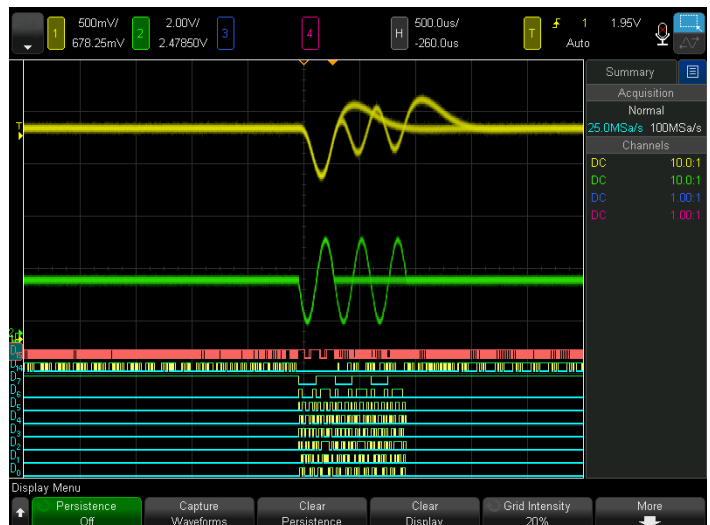

Figure 10. Conventional oscilloscope edge triggering fails to synchronize on specific-length chirps.

Turning On and Debugging a Real Mixed-signal Embedded Design (Continued)

Using the I²C triggering capability, the Keysight MSO can synchronize its acquisitions on specific serial input conditions that instruct the MCU to generate specific length (number of pulses) output chirps.

Figure 11 shows the scope's ability to trigger on a 3-cycle chirp with I²C triggering on address and data serial content. Digital channels D14 and D15 have been defined as the I²C clock and data input triggering signals respectively. Actually, any of the 16 digital or 2 to 4 analog scope channels could have been defined to trigger serially on these two input signals. While monitoring the serial input and analog output signals, D0 through D7 have been set up to monitor the external DAC input (MCU output) signals in a "Bus" overlay display.

The time-correlated I²C serial decode trace is shown at the bottom of the display in Figure 12. The serial decode can also be viewed in a more familiar tabular format shown in the upper half of the display.

Although not shown, another analog channel of the oscilloscope could have been set up to simultaneously probe and acquire the analog input signal from the acceleration sensor that determines the output signal amplitude. In addition, unused MSO digital channels could have been used to monitor and/or further qualify triggering on the digital control panel inputs and/or the LCD output driver signals.

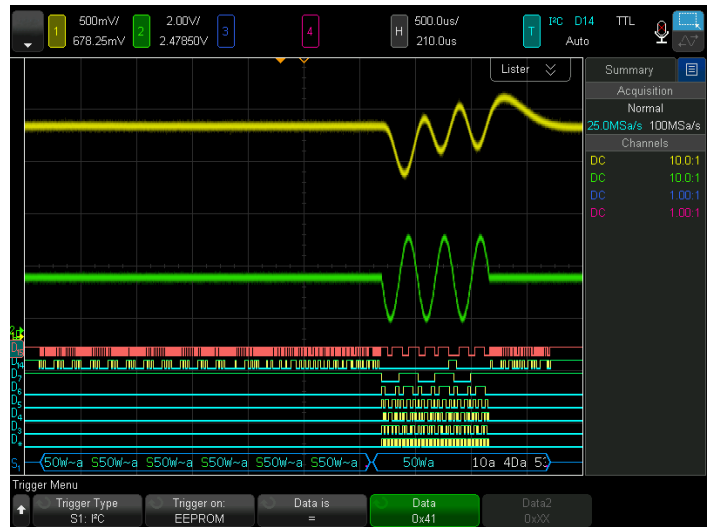

Figure 11. Triggering on a 3-cycle chirp with I²C triggering and decode in a Keysight MSO.

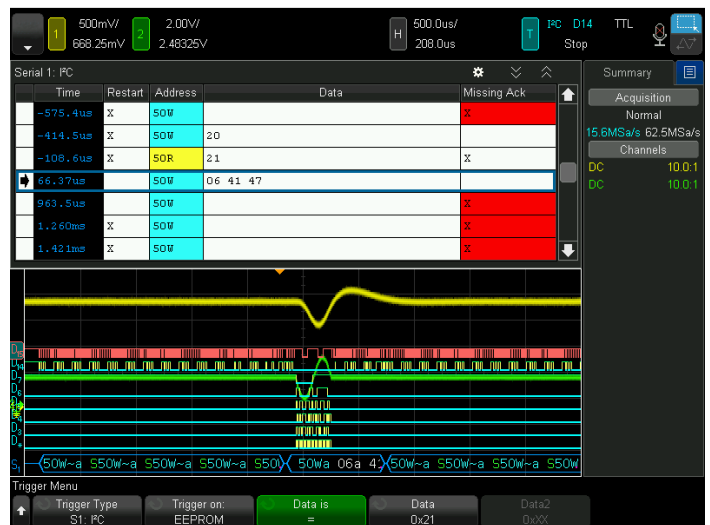

Figure 12. The I²C signal can be viewed time-correlated or in tabular decoded format as shown in the top half of this display.

Summary

Mixed signal oscilloscopes (MSOs) are good tools-of-choice for debugging and verifying proper operation of many of today's MCU-, FPGA-, and DSP-based mixed-signal designs. With time-correlated displays of both analog and digital waveforms in a single integrated instrument, along with powerful mixed-signal triggering across all analog and digital channels, an MSO can often enable designers to more quickly debug their mixed-signal embedded designs using a familiar tool based on an oscilloscope's user-interface/use-model.

With more MSOs and hybrid mixed-signal measurement tools coming on the market today, it is important that you carefully evaluate the measurement capabilities and usability of these instruments before making a purchase decision. You should look for the following seven characteristics:

1. An MSO should operate like a familiar oscilloscope—not like a logic analyzer.
2. An MSO should have all of the measurement capabilities of an oscilloscope without sacrificing features such as autoscale, trigger holdoff, infinite-persistence (on analog and digital channels), and probe/channel de-skew.
3. An MSO should provide fast waveform update rates like an oscilloscope—not slow updates like a logic analyzer.
4. An MSO should have digital/logic-channel acquisition system performance (sample rate and probing bandwidth) commensurate with the performance of the analog acquisition system of the oscilloscope.
5. An MSO should be able to trigger across both analog and digital channels (mixed-signal triggering) with precise time-alignment.
6. An MSO should be able to trigger on patterns based on a minimum qualification time in order to avoid triggering on unstable/transitional digital switching conditions.
7. An MSO should provide both analog and digital triggering that is based on real-time analog comparator technology—not sample-based triggering which produces significant trigger jitter on repetitive analog waveforms.

Glossary

	Description
ADC	Analog-to-digital converter, sometimes referred to as an A-to-D
Analog I/O	Real-time analog input and output signals of a microcontroller (MCU) or digital signal processor (DSP)
Chirp	An RF-pulsed analog signal consisting of a specific number of pulses
DAC	Digital-to-analog converter, sometimes referred to as a D-to-A
Digital I/O	Latched input and output signals of a microcontroller (MCU) or digital signal processor (DSP)
DSO	Digital storage oscilloscope that acquires and displays analog characteristics of input signals using either real-time or equivalent-time sampling techniques
DSP	Digital signal processor
I ² C	Inter-integrated circuit bus, which is a common 2-wire serial bus that utilizes a self-arbitration protocol
MSO	Mixed signal oscilloscope that synergistically combines all of the measurement capabilities of an oscilloscope with some of the measurement capabilities of a logic analyzer and includes a time-correlated display of both analog and digital waveforms
MCU	Microcontroller unit
Qualified pattern triggering	Triggering at a specific location within a digital parallel pattern (usually entry or exit points) and ensuring that an input pattern has stabilized with a minimum time qualification (present for >x time) before generating a trigger event so that the scope or logic analyzer does not trigger on unstable/transitional input switching conditions
RAM	Random access memory
Real-time analog hardware comparator triggering	Precise triggering that occurs before and separate from digital acquisition sampling to insure reliable/stable triggering with minimal trigger uncertainty/jitter
ROM	Read-only memory
Sample-based pattern triggering	Pattern triggering that is based on sampled data that will induce as much as plus or minus one sample period of trigger uncertainty/jitter
SDRAM	Synchronous dynamic random access memory
SPI	Serial protocol interface

Solutions Cubed, LLC

Keysight Technologies would like to thank Solutions Cubed, LLC of Chico, California, for providing the block diagram and measurement example of the mixed-signal MCU-based “chirp” design discussed in this paper. Keysight Technologies has worked closely with Solutions Cubed on various mixed-signal embedded design projects.

Solutions Cubed can provide mixed-signal hardware and software embedded design services/consulting according to your specified requirements. Contact Solutions-Cubed directly:

Solutions Cubed
 256 East 1st Street
 Chico, CA 95928
 USA
 +1 (530) 891-1643
www.solutions-cubed.com

Related Literature

Publication title	Publication number
InfiniiVision Oscilloscope Probes and Accessories - Selection Guide	5968-8153EN
Debugging Serial Bus Systems with a Mixed Signal Oscilloscope - Application Note	5988-5997EN
Evaluating Oscilloscope Vertical Noise Characteristics - Application Note	5989-3020EN
Evaluating Oscilloscope Sample Rates vs. Sampling Fidelity - Application Note	5989-5732EN
Evaluating Oscilloscope Bandwidths for Your Application - Application Note	5989-5733EN
Oscilloscope Waveform Update Rate Determines Ability to Capture Elusive Events - Application Note	5989-7885EN
InfiniiVision 2000 X-Series Oscilloscopes - Data Sheet	5990-6618EN
InfiniiVision 4000 X-Series Oscilloscopes - Data Sheet	5991-1103EN
How to Select Your Next Oscilloscope: 12 Tips on What to Consider Before you Buy - Application Note	5991-2714EN
InfiniiVision 6000 X-Series Oscilloscopes - Data Sheet	5991-4087EN
InfiniiVision 3000T X-Series Oscilloscopes - Data Sheet	5992-0140EN

Product website

For the most up-to-date and complete application and product information, please visit our product website at: <http://www.keysight.com/find/InfiniiVision>

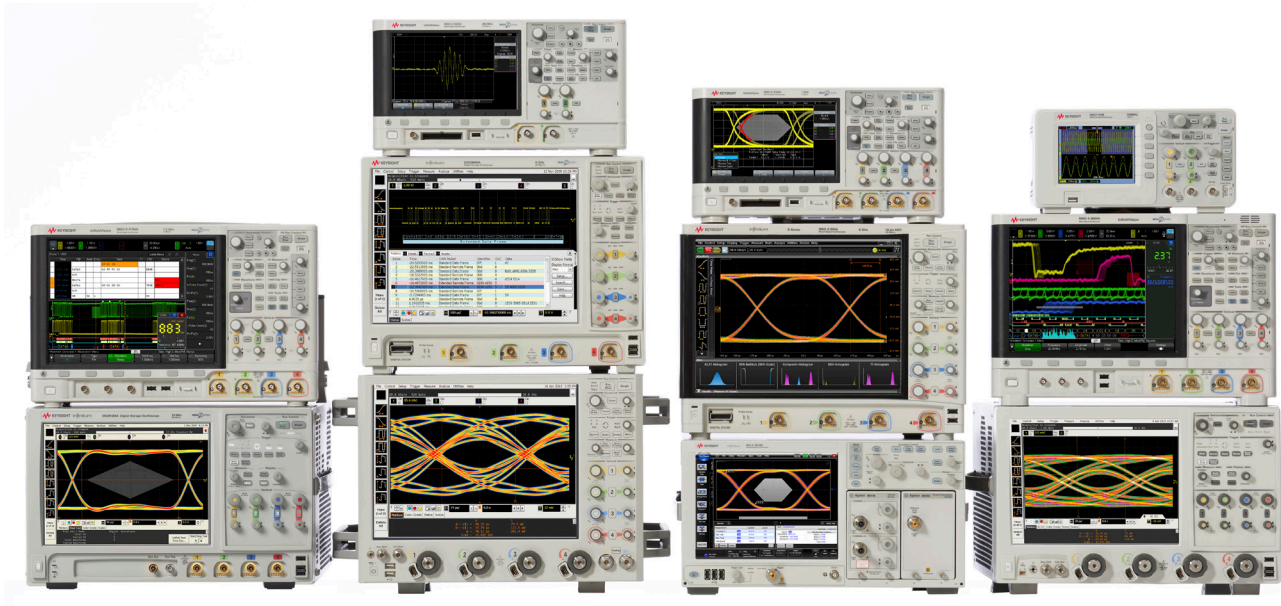

Keysight Oscilloscopes

Multiple form factors from 20 MHz to > 90 GHz | Industry leading specs | Powerful applications



www.axistandard.org

AdvancedTCA® Extensions for Instrumentation and Test (AXIe) is an open standard that extends the AdvancedTCA for general purpose and semiconductor test. Keysight is a founding member of the AXIe consortium. ATCA®, AdvancedTCA®, and the ATCA logo are registered US trademarks of the PCI Industrial Computer Manufacturers Group.



www.lxistandard.org

LAN eXtensions for Instruments puts the power of Ethernet and the Web inside your test systems. Keysight is a founding member of the LXI consortium.



www.pxisa.org

PCI eXtensions for Instrumentation (PXI) modular instrumentation delivers a rugged, PC-based high-performance measurement and automation system.

Evolving Since 1939

Our unique combination of hardware, software, services, and people can help you reach your next breakthrough. We are unlocking the future of technology.

From Hewlett-Packard to Agilent to Keysight.

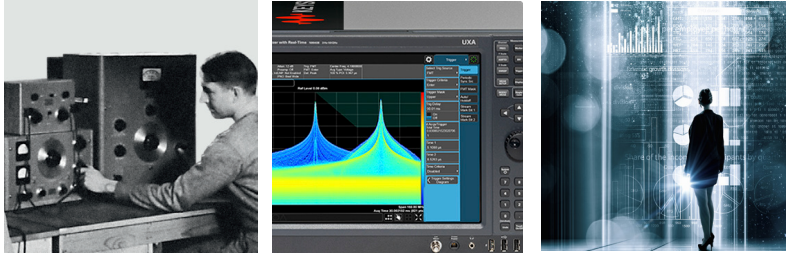

For more information on Keysight Technologies' products, applications or services, please contact your local Keysight office. The complete list is available at: www.keysight.com/find/contactus

Americas

Canada	(877) 894 4414
Brazil	55 11 3351 7010
Mexico	001 800 254 2440
United States	(800) 829 4444

Asia Pacific

Australia	1 800 629 485
China	800 810 0189
Hong Kong	800 938 693
India	1 800 11 2626
Japan	0120 (421) 345
Korea	080 769 0800
Malaysia	1 800 888 848
Singapore	1 800 375 8100
Taiwan	0800 047 866
Other AP Countries	(65) 6375 8100

Europe & Middle East

Austria	0800 001122
Belgium	0800 58580
Finland	0800 523252
France	0805 980333
Germany	0800 6270999
Ireland	1800 832700
Israel	1 809 343051
Italy	800 599100
Luxembourg	+32 800 58580
Netherlands	0800 0233200
Russia	8800 5009286
Spain	800 000154
Sweden	0200 882255
Switzerland	0800 805353
	Opt. 1 (DE)
	Opt. 2 (FR)
	Opt. 3 (IT)
United Kingdom	0800 0260637

For other unlisted countries: www.keysight.com/find/contactus (BP-9-7-17)

DEKRA Certified
ISO 9001 Quality Management System

www.keysight.com/go/quality
Keysight Technologies, Inc.
DEKRA Certified ISO 9001:2015
Quality Management System

myKeysight

myKeysight

www.keysight.com/find/mykeysight

A personalized view into the information most relevant to you.

www.keysight.com/find/emt_product_registration

Register your products to get up-to-date product information and find warranty information.

KEYSIGHT SERVICES

Accelerate Technology Adoption.
Lower costs.

Keysight Services

www.keysight.com/find/service

Keysight Services can help from acquisition to renewal across your instrument's lifecycle. Our comprehensive service offerings—one-stop calibration, repair, asset management, technology refresh, consulting, training and more—helps you improve product quality and lower costs.



Keysight Assurance Plans

www.keysight.com/find/AssurancePlans

Up to ten years of protection and no budgetary surprises to ensure your instruments are operating to specification, so you can rely on accurate measurements.

Keysight Channel Partners

www.keysight.com/find/channelpartners

Get the best of both worlds: Keysight's measurement expertise and product breadth, combined with channel partner convenience.

www.keysight.com/find/InfiniiVision



Unlocking Measurement Insights

This information is subject to change without notice.
© Keysight Technologies, 2017
Published in USA, December 1, 2017
5989-3702EN
www.keysight.com