

58503B
GPS Time and Frequency
Reference Receiver
and
59551A
GPS Measurements
Synchronization Module

Operating and Programming
Guide

This guide describes how to operate the Symmetricom 58503B GPS Time and Frequency Reference Receiver and 59551A GPS Measurements Synchronization Module via the RS-232C port(s). The information in this guide applies to instruments having the number prefix listed below, unless accompanied by a "Manual Updating Changes" package indicating otherwise.

SERIAL PREFIX NUMBER:3805A and above (58503B), 3805A and above (59551A)

Instruments with serial numbers below 3805A may have earlier versions of firmware installed. There are no operator-specific differences in previous versions of firmware.

FIRMWARE REVISION:3805A and above (58503B), 3805A and above (59551A)

Firmware revision can be identified by using a "*IDN?" command sent to the Receiver via RS-232C port. See the section "Connecting a Computer or Modem," in Chapter 2, "Serial Interface Capabilities," of this guide for instructions on connecting a computer or modem to these products.

For assistance, contact:

Symmetricom, Inc.
2300 Orchard Parkway
San Jose, CA 95131-1017

U.S.A. Call Center:
888-367-7966 (from inside U.S.A. only – toll free)
408-428-7907

U.K. Call Center:
+44.7000.111666 (Technical Assistance)
+44.7000.111888 (Sales)
+44.1604.586740

Fax: 408-428-7998

E-mail: ctac@symmetricom.com

Internet: <http://www.symmetricom.com>

Warning Symbols That May Be Used In This Book



Instruction manual symbol; the product will be marked with this symbol when it is necessary for the user to refer to the instruction manual.



Indicates hazardous voltages.



Indicates earth (ground) terminal.



or



Indicates terminal is connected to chassis when such connection is not apparent.



Indicates Alternating current.



Indicates Direct current.

Contents

In This Guide

1 Front and Rear Panels at a Glance

- 58503B Front Panel at a Glance 1-2
- 58503B/Option 001 Front-Panel Display/Keypad at a Glance 1-3
- 58503B Rear Panel at a Glance 1-4
- 59551A Front Panel at a Glance 1-5
- 59551A Rear Panel at a Glance 1-6

2 Serial Interface Capabilities

- Chapter Contents 2-2
- About the RS-232C Serial Port(s) 2-3
 - PORT 1 Rear-Panel RS-232C Serial Port 2-3
 - PORT 2 Front-Panel RS-232C Serial Port (59551A Only) 2-4
- Connecting a Computer or Modem 2-5
 - To Connect the GPS Receiver to a PC or Modem Via the Rear-Panel PORT 1 2-6
 - Connecting to the Personal Computer (PC) 2-6
 - Connecting to a Modem 2-6
- Making Your Own Cables 2-8
- Configuring the RS-232C Port(s) 2-9
 - Making Changes to the Serial Port Settings (If Needed) 2-10
 - Configuring PORT 1 of the 59551A 2-10
 - Configuring PORT 1 of the 58503B and PORT 2 of the 59551A 2-10
 - Determining the Serial Port Settings 2-11
 - Standard 58503B and 59551A 2-11

3 Visual User Interface

- Chapter Contents 3-2
- Using and Reading the Visual User Interface (the Receiver Status Screen) 3-3
 - Tutorial on Using the Status Screen to Interface With the Receiver 3-3
 - Demonstration of Holdover Operation 3-8
- Receiver Status Screen Data 3-11
 - SYNCHRONIZATION Section of the Status Screen 3-12
 - SYNCHRONIZATION Summary Line 3-12
 - SmartClock Mode 3-12

	Reference Outputs	3-13
	ACQUISITION Section of the Status Screen	3-14
	ACQUISITION Line	3-14
	Tracking, Not Tracking	3-14
	Time	3-16
	Position	3-17
	HEALTH MONITOR Section of the Screen	3-18
	The Receiver Status Screen at a Glance	3-19
4	Command Quick Reference	
	Chapter Contents	4-2
	An Introduction to GPS Receiver Commands	4-4
	SCPI Conformance Information	4-4
	Command Syntax Conventions	4-4
	Command Presentation	4-4
	GPS Satellite Acquisition	4-5
	1 PPS Reference Synchronization	4-7
	Operating Status	4-8
	System Time	4-10
	Programmable Pulse Output (59551A Only)	4-11
	Event Time Stamping (59551A Only)	4-12
	Serial Interface Communication	4-13
	Receiver Initialization	4-14
	Receiver Identification/Upgrade	4-15
	Receiver Commands at a Glance	4-17
	Status Reporting System at a Glance	4-18
5	Command Reference	
	Chapter Contents	5-2
	Command Syntax Conventions	5-4
	Description Format	5-5
	Commands and Returns	5-5
	Query-Specific Information	5-6
	Description of Response Formats (ASCII-encoded)	5-6

GPS Satellite Acquisition	5-7
1 PPS Reference Synchronization	5-27
Operating Status	5-39
System Time	5-73
Programmable Pulse Output (HP 59551A Only)	5-83
Event Time Stamping (HP 59551A Only)	5-89
Serial Interface Communication	5-100
Receiver Initialization	5-109
Receiver Identification/Upgrade	5-113

A Error Messages

Introduction	A-2
Reading an Error	A-2
Error Queue	A-3
Error Types	A-4
No Error	A-4
Syntactic Error	A-4
Semantic Error	A-5
Hardware/Firmware Error	A-5
Query Error	A-5
General Error Behavior	A-6
List of Errors	A-7

B Command Syntax and Style

Appendix Contents	B-2
Command Types, Format, and Elements	B-3
Command Types	B-3
Command Formats	B-3
Common Command Format	B-3
SCPI Command and Query Format	B-3
Elements of SCPI Commands	B-4
Common Command Syntax	B-4
Subsystem Command Syntax	B-4
Abbreviated Commands	B-5
Keyword Separator	B-5
Parameter Data Types	B-5
Parameter Separator	B-6
Query Parameters	B-6
Suffixes	B-6
Suffix Elements	B-6
Suffix Multipliers	B-7
Command Terminator	B-7

- Using Multiple Commands B-7
 - Program Messages B-7
 - Program Message Syntax B-7
- Elements of Response Messages B-9
 - Response Messages B-9
 - Response Message Syntax B-9
 - Response Formats B-10

Reference Documentation B-12

C Receiver Firmware Installation

- Downloading New Firmware Using SatStat Program C-2**

D Performance Tests

Introduction D-2

- Operational Verification D-2
- Complete Performance Tests D-2
- Test Record D-2

Equipment Required D-3

Before You Start D-4

Operational Verification D-5

- Introduction D-5
- Power-Up Procedure D-5
- 10 MHz Verification (58503B Only) D-6
- 1 PPS Verification D-6
- IRIG-B Verification (59551A Only) D-7
- Time of Day and PORT 1 RS-232C Serial Interface Verification D-8
- Antenna Power Verification D-9
- Front Panel Display/Keypad Verification (58503B Option 001 Only) D-10
- Time Tagging (Stamping) Verification and Programmable Verification (59551A Only) D-11
- Programmable Pulse Verification (59551A Only) D-13
- Operational Verification Conclusion D-15

In Case of Difficulty D-16

Complete Performance Tests D-17

- Preliminary Test Setup D-18
- Test 1: 10 MHz Frequency Accuracy and 1 PPS Jitter (Locked to GPS) D-19
 - Specifications Tested D-19
 - Procedure D-19
- Test 2: 10 MHz Holdover Aging and 1 PPS Accumulated Time Error (Unlocked) D-22

	Specifications Tested	D-22
	Procedure	D-22
	Test 3: 1 PPS Time Accuracy (Locked)	D-24
	Test 4: 10 MHz Frequency Stability (Time Domain) and Phase Noise (Frequency Domain) Measurements	D-24
	Frequency Stability (Time Domain)	D-24
	Phase Noise (Frequency Domain)	D-24
	58503B Performance Test Record	D-26
	59551A Performance Test Record	D-27
E	58503B Specifications	
	Specifications and Characteristics	E-2
	GPS Receiver Features	E-2
	Other Information	E-5
	Options and Accessories	E-5
F	59551A Specifications	
	Specifications and Characteristics	F-2
	GPS Receiver Features	F-2
	Other Information	F-5
	Options and Accessories	F-5
	Command Index	
	General Index	

Contents

In This Guide

Chapter 1, “**Front and Rear Panels at a Glance**,” provides overview of the Receiver’s indicators, inputs, and outputs.

Chapter 2, “**Serial Interface Capabilities**,” provides RS-232 serial interface port connection and configuration instructions.

Chapter 3, “**Visual User Interface**,” which is subtitled “Using the Receiver Status Screen,” provides information on how to use the Receiver Status screen and the SatStat program. An illustrated foldout of the Receiver Status screen, which is a comprehensive summary of key operation conditions and settings, is provided at the end of this chapter.

Chapter 4, “**Command Quick Reference**,” is a quick reference that summarizes the Receiver commands. The commands are presented or grouped by their functions. A foldout sheet that presents all of the commands on one side (Receiver Commands at a Glance) and illustrates the status reporting system on the other side (Status Reporting System at a Glance) is provided at the end of this chapter.

Chapter 5, “**Command Reference**,” provides a description of each command that can be used to operate the GPS Receiver. The commands are grouped by functions. The functions are grouped and ordered the same as they are in Chapter 4, “Command Quick Reference,” and on the foldout “Receiver Commands at a Glance.” A comprehensive discussion on how you can monitor and control alarm conditions using the status registers is also provided in this chapter.

Appendix A, “**Error Messages**,” lists all error messages the Receiver could generate along with descriptions of possible causes for the errors.

Appendix B, “**Command Syntax and Style**,” provides an overview of the Standard Commands for Programming Instrument (SCPI) syntax and style to help you program the Receiver.

Appendix C, “**Receiver Firmware Installation**,” provides a procedure for downloading new firmware to the GPS Receiver.

Appendix D, “**Performance Tests**,” provides procedures that verify the GPS Receivers operate properly and meet electrical performance specifications. Electrical performance is tested against the specifications listed in Appendix E, “58503B Specifications,” and Appendix F, “59551A Specifications,” in this guide.

In This Guide

Appendix E, “**58503B Specifications**,” lists the product specifications and characteristics.

Appendix F, “**59551A Specifications**,” lists the product specifications and characteristics.

Command Index, lists all of the commands alphabetically and provides page references.

General Index

58503B Front Panel at a Glance

58503B Front Panel at a Glance

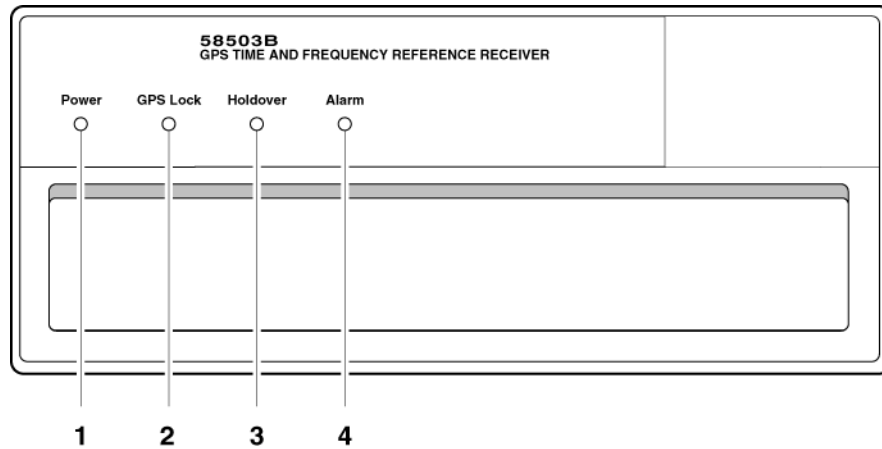

- 1** When the **Power** indicator illuminates, it indicates that the proper input power is supplied to the Receiver.
- 2** When the **GPS Lock** indicator illuminates, it indicates that the Receiver is receiving the GPS signal and is locked on one or more satellite(s).
- 3** When the **Holdover** indicator illuminates, it indicates that the Receiver is NOT locked to the GPS signal. The Receiver is keeping time based on the internal reference oscillator signal. The internal reference oscillator will determine the accuracy of the 1 PPS signal and the 10 MHz reference output.
- 4** When the **Alarm** indicator illuminates, it indicates that the Receiver has detected an internal condition that requires attention.

58503B/Option 001 Front-Panel Display/Keypad at a Glance

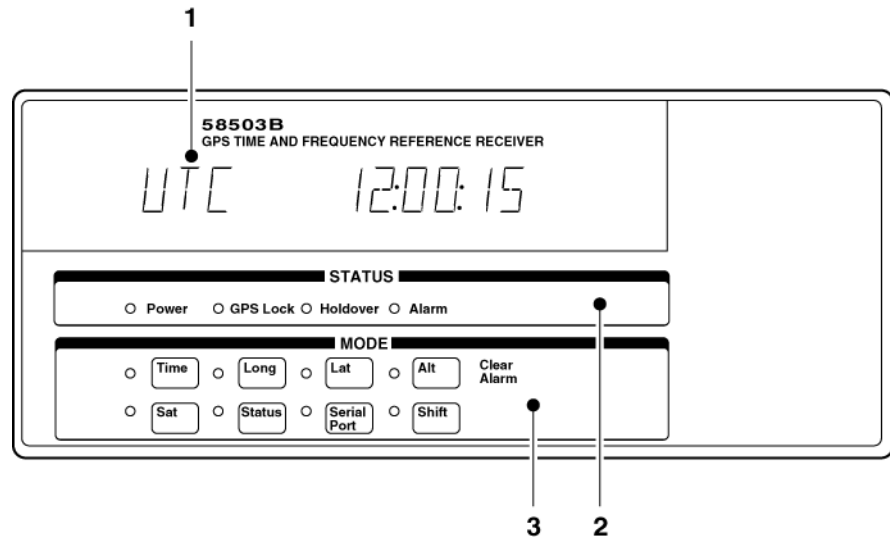

- 1 An alphanumeric display for displaying time, position (i.e., longitude, latitude, and altitude), and Receiver status. The display is a highly visible twelve-character vacuum-fluorescent display.
- 2 **Status** LED indicators:

When the **Power** indicator is illuminated, it indicates that input power is supplied to the Receiver.

When the **GPS Lock** indicator is illuminated, it indicates that the Receiver is tracking satellites and has phase-locked its internal reference to the reference provided by GPS.

When the **Holdover** indicator is illuminated, it indicates that the Receiver is not phase-locking its internal reference to the reference provided by GPS. Typically, this would happen due to loss of satellite tracking.

When the **Alarm** indicator is illuminated, it indicates that the Module has detected a condition that requires attention.
- 3 Eight **MODE** keys with associated LEDs for front-panel access to time, position, and status information: **Time**, **Long** (longitude), **Lat** (latitude) **Alt** (altitude), **Sat** (number of satellites tracking), **Status** (Receiver or system status), and **Serial Port** (serial port settings). Each key selects a different display mode. Also, pressing **Shift** and **Alt** key in sequence clears instrument alarm.

58503B Rear Panel at a Glance

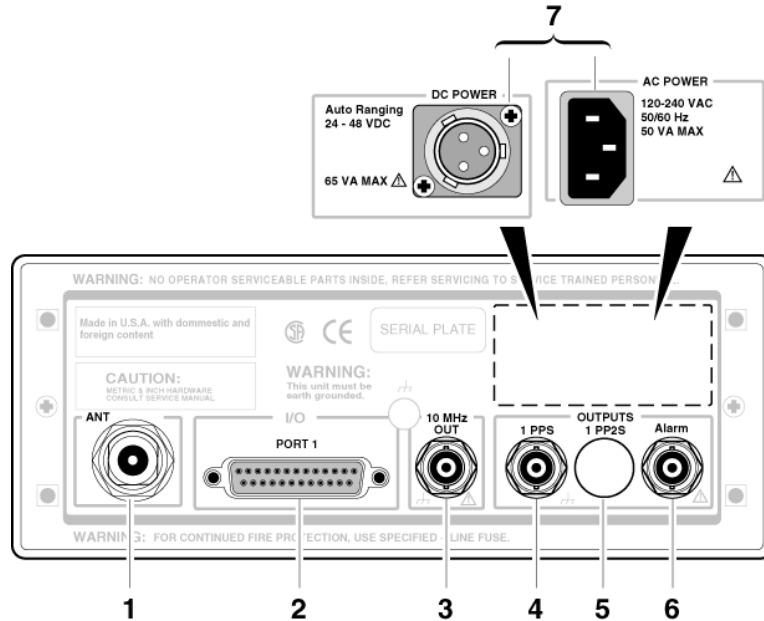

- 1 **ANT** N-type (female) connector for GPS Antenna connection.
- 2 **PORT 1** RS-232C, DB-25 (female) serial interface port for remote control, monitoring, and downloading of the Receiver's memory data and upgrading Receiver software.
- 3 **10 MHz OUT** output for user-specific applications.
- 4 **1 PPS** connector for outputting a continuous 1 Pulse Per Second signal.
- Option 002 **1 PP2S** (One-Pulse-Per-Two-Seconds) connector for outputting a pulse every other second, synchronized to the even seconds in GPS time. Pulses occur on even-numbered seconds (i.e., 2 seconds, 4 seconds, etc.).
- 6 **Alarm** output for external devices (such as red light, bell, or horn) to indicate that the Receiver has detected an internal condition that requires attention.
- 7 **POWER** input jack.

59551A Front Panel at a Glance

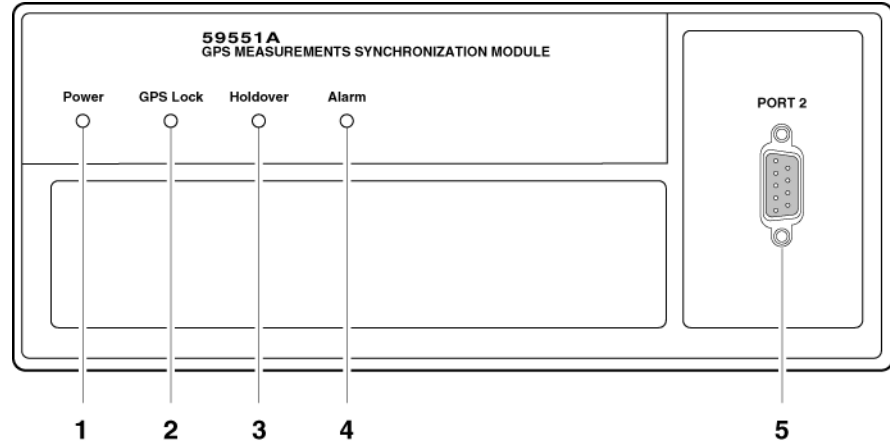

- 1 When the **Power** indicator illuminates, it indicates that the proper input power is supplied to the Module.
- 2 When the **GPS Lock** indicator illuminates, it indicates that the Module is receiving the GPS signal and is locked on one or more satellite(s).
- 3 When the **Holdover** indicator illuminates, it indicates that the Module is NOT locked to the GPS signal. The Module is keeping time based on the internal reference oscillator signal. The internal reference oscillator will determine the accuracy of the 1 PPS signal. (See specification for Accuracy in Holdover in Appendix F, “59551A Specifications,” in this guide.)
- 4 When the **Alarm** indicator illuminates, it indicates that the Module has detected an internal condition that requires attention.
- 5 **PORT 2** RS-232C, DE-9S (female) serial interface port for local monitoring and retrieving data stored in the Module’s memory data.

59551A Rear Panel at a Glance

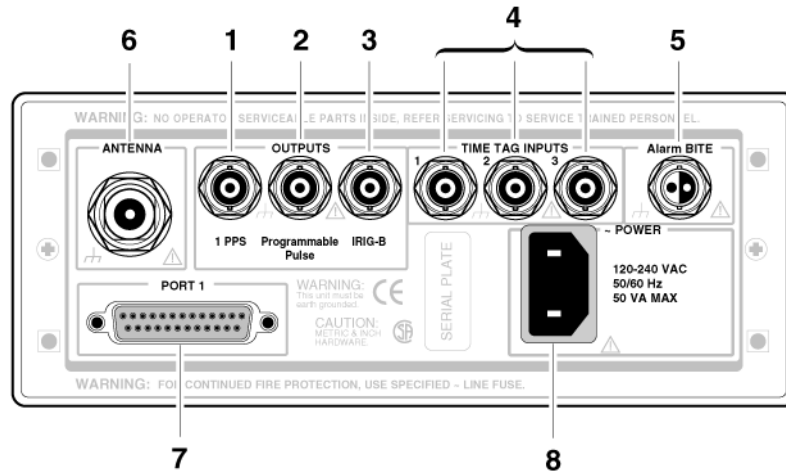

- 1 1 PPS (One-Pulse-Per-Second)** connector for outputting a continuous one pulse per second signal.
- 2 Programmable Pulse** output connector for outputting pulses at user-specified time/period.
- 3 IRIG-B** output for outputting formatted time-code signals. (This signal is used for general purpose time distribution and magnetic tape annotation applications requiring the time of year.)
- 4 Time tag** input connectors for receiving TTL conditioned time tagging signals.
- 5 Alarm BITE (Built-In Test Equipment)** output for external devices (such as red light, bell, or horn) to indicate that the Module has detected an internal condition that requires attention. The relay opens and closes with the **Alarm** indicator. (Mating connector is Amphenol part number 31-224 [glass-filled Noryl] or #31-2226 [Telfon]).
- 6 ANTENNA** N-type (female) connector for GPS antenna connection.
- 7 PORT 1** RS-232C, DB-25 (female) serial interface port for remote control, monitoring, and retrieving of the Module's memory data and upgrading Module software.
- 8 AC POWER** input jack. The AC input jack is standard. The unit operates from ac voltage. It can also be operated from dc voltage via this ac jack by using the supplied IEC 320 dc connector plug.

Chapter Contents

This chapter describes how to operate the 59551A GPS Measurements Synchronization Module and the 58503B GPS Time and Frequency Reference Receiver via the RS-232C serial interface port. Hardware connections and configuration are discussed.

This chapter is organized as follows:

- About the RS-232C Serial Port(s) page 2-3
 - PORT 1 Rear-Panel RS-232C Serial Port page 2-3
 - PORT 2 Front-Panel RS-232C Serial Port (59551A Only) page 2-4
- Connecting a Computer or Modem page 2-5
 - To Connect the GPS Receiver to a PC or Modem Via the Rear-Panel PORT 1 page 2-6
 - To Connect the GPS Receiver to a PC or Modem Via the Rear-Panel PORT 1 page 2-6
- Configuring the RS-232C Port(s) page 2-9
 - Making Changes to the Serial Port Settings (If Needed) page 2-10
 - Determining the Serial Port Settings page 2-11

About the RS-232C Serial Port(s)

The 58503B has only a rear-panel (**PORT 1**) RS-232C serial interface port.

The 59551A has separate rear-panel (**PORT 1**) and front-panel (**PORT 2**) RS-232C serial interface ports.

The rear-panel (**PORT 1**) RS-232C serial interface port is the only port which can be used to upgrade the Receiver firmware; therefore, it is referred to as the PRIMARY port. The 59551A's front-panel (**PORT 2**) RS-232C serial interface port is referred to as the SECONDARY port because it cannot be used to upgrade the Receiver firmware. The operation and configuration of these ports are described in the following paragraphs. More information is provided in the sections titled "Connecting a Computer or Modem" and "Configuring the RS-232C Port(s)" in this chapter on page 2-5 and page 2-9, respectively.

Either port allows you full communication with the Receiver. This can be done by connecting any computer with an RS-232C serial interface and suitable terminal emulation software, then sending the correct commands for transmitting or retrieving data.

PORT 1 Rear-Panel RS-232C Serial Port

This 25-pin female subminiature D (DB-25) connector (**PORT 1**) RS-232C Serial Interface Port is located on the rear panel.

The pins used for **PORT 1** RS-232C communication are described in Table 2-1.

NOTE

We reserve the right to impose signals on other pins; therefore, your connection should be restricted to the pins described in Table 2-1.

Table 2-1. PORT 1 Rear-Panel RS-232C Serial Port Connections

*Pin Number	Input/Output	Description
2	Output	Transmit Data (TxD). GPS Receiver output.
3	Input	Receive Data (RxD). GPS Receiver input.
7	—	Signal Ground (SG)

About the RS-232C Serial Port(s)

Refer to the sections titled “Connecting a Computer or Modem” in this chapter, on page 2-5, for wiring diagrams and more information on the RS-232C interface cables.

PORT 2 Front-Panel RS-232C Serial Port (59551A Only)

This 9-pin female subminiature D (DB-9) connector (**PORT 2**) RS-232C Serial Interface Port is located on the front panel.

The pins used for **PORT 2** RS-232C communication are described in Table 2-2.

NOTE

We reserves the right to impose signals on other pins; therefore, your connection should be restricted to the pins described in Table 2-2.

Table 2-2. PORT 2 Front-Panel RS-232C Serial Port Connections (59551A Only)

*Pin Number	Input/Output	Description
2	Input	Receive Data (RxD). GPS Receiver input.
3	Output	Transmit Data (TxD). GPS Receiver output.
5	—	Signal Ground (SG)

Refer to the sections titled “Connecting a Computer or Modem” in this chapter, on page 2-5, for wiring diagrams and more information on the RS-232C interface cables.

Connecting a Computer or Modem

To connect the GPS Receiver to a computer or modem, you must have the proper interface cable. Most computers are DTE (Data Terminal Equipment) devices. Since the Receiver is also a DTE device, you must use a DTE-to-DTE interface cable when connecting to a computer. These cables are also called “null-modem”, “modem-eliminator”, or “crossover” cables.

Most modems are DCE (Digital Communication Equipment) devices; thus, you must use a DTE-to-DCE interface cable.

The interface cable must also have the proper connector on each end and the internal wiring must be correct. Connectors typically have 9 pins (DE-9 connector) or 25 pins (DB-25 connector) with a “male” or “female” pin configuration. A male connector has pins inside the connector shell and a female connector has holes inside the connector shell.

To simplify interface cable selections, the following sections tells you which cables to use.

Connecting a Computer or Modem

To Connect the GPS Receiver to a PC or Modem Via the Rear-Panel PORT 1

Connecting to the Personal Computer (PC)

Use an HP 24542G interface cable or equivalent to connect the Receiver's rear-panel **PORT 1** DB-25 female connector to a PC as shown in Figure 2-1. See "Making Your Own Cables" starting on page 2-8.

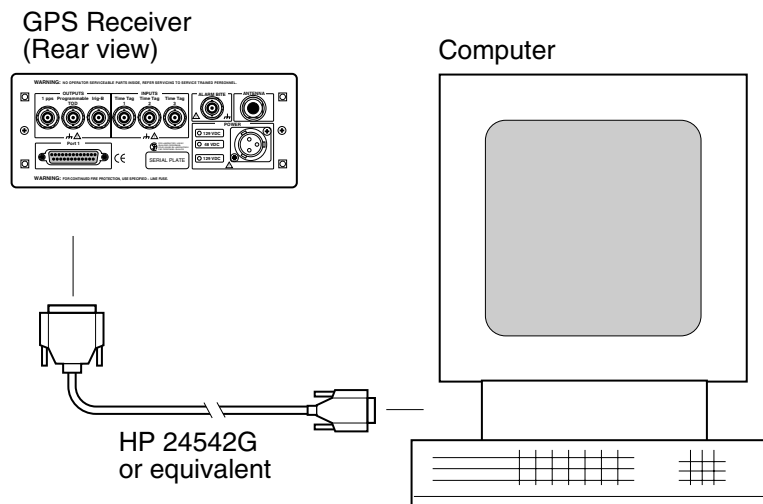

Figure 2-1. Connecting the GPS Receiver to a PC or Laptop

Connecting to a Modem

Use an HP 40242M interface cable or equivalent to connect the Receiver's rear-panel **PORT 1** DB-25 female connector to a modem, which is a DCE (Digital Communication Equipment) device, as shown in Figure 2-2. See "Making Your Own Cables" starting on page 2-8.

Connecting a Computer or Modem

GPS Receiver
(Rear view)

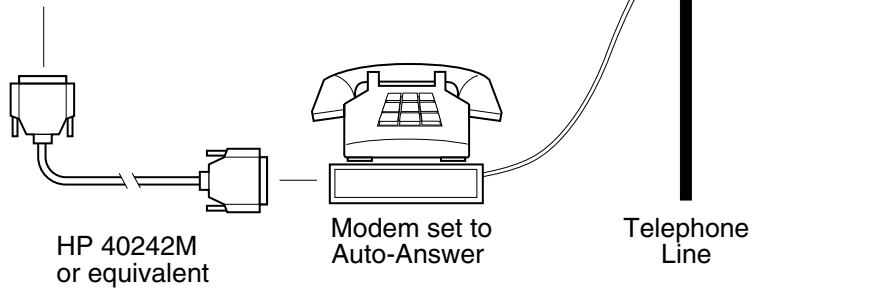
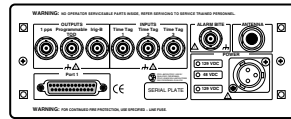

Figure 2-2. Connecting the GPS Receiver to a Modem

Making Your Own Cables

Making Your Own Cables

If you choose to make your own cable, see Figure 2-3 and Figure 2-4.

Figure 2-3 illustrates how to make a DE-9S-to-DE-9P, DTE-to-DCE interface cable that can replace the cable and adapter combination of the HP 24542U cable and the HP 5181-6639 adapter for use with **PORT 2** of the 59551A.

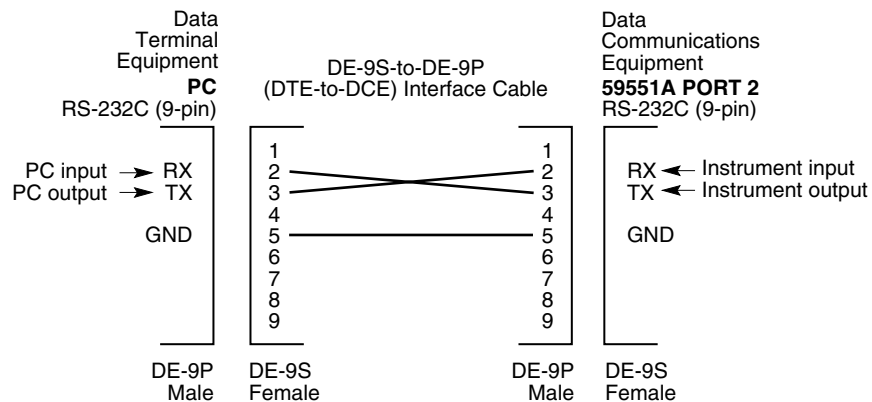

Figure 2-3. DE-9S-to-DE-9P (DTE-to-DCE) Serial Interface Connection to PORT 2

Figure 2-4 illustrates how to make a DE-9S-to-DB-25P, DTE-to-DTE interface cable that can replace the HP 24542G cable (25-pin male to 9-pin female connectors) for use with **PORT 1**.

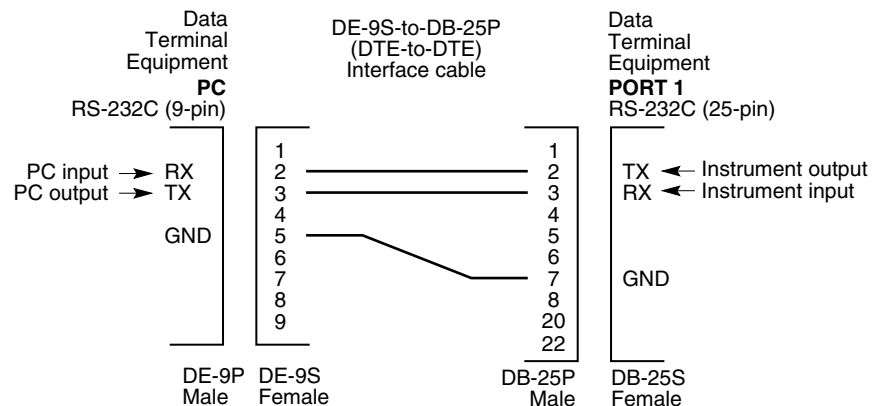

Figure 2-4. DE-9S-to-DB-25P (DTE-to-DTE) Serial Interface Connection to PORT 1

Configuring the RS-232C Port(s)

Configuring the RS-232C Port(s)

The 59551A has separate rear-panel (**PORT 1**) and front-panel (**PORT 2**) RS-232C serial interface ports.

The 58503B has one RS-232C serial interface port (**PORT 1**) on the rear panel. **Note:** **PORT 1** of the 58503B and **PORT 2** of the 59551A have the same configuration capabilities as indicated in Table 2-4.

Software pacing, baud rate, parity, data bits, and stop bits parameters for each port are user-selectable and independent of the configuration of the other.

Table 2-3 and Table 2-4 list the configuration factory-default values for **PORT 1** and **PORT 2**.

Table 2-3. Factory-Default Values for PORT 1 of the 59551A

Parameter	Default	Possible Choices
Software Pacing	NONE	XON or NONE
Baud Rate	9600	1200, 2400, 9600, or 19200
Parity	NONE	EVEN, ODD, or NONE
Data Bits	8	7 or 8
Stop Bits	1	1 or 2
Full Duplex	ON	ON or OFF

Table 2-4. Factory-Default Values for PORT 1 of the 58503B and PORT 2 of the 59551A

Parameter	Default	Possible Choices
Software Pacing	NONE	XON or NONE
Baud Rate	9600	1200, 2400, 9600, or 19200
Parity	NONE	EVEN, ODD, or NONE
Data Bits	8	Fixed at 7 when parity is even or odd. Fixed at 8 when parity is none.
Stop Bits	1	Fixed (no choices available)
Full Duplex	ON	ON or OFF

Procedures for configuring the RS-232C ports are provided in the following paragraphs.

Configuring the RS-232C Port(s)**Making Changes to the Serial Port Settings
(If Needed)**

CAUTION

If you change the serial port settings, your changes will be stored in the Receiver. Cycling power will not reset to factory defaults. Therefore, if you make a change, it is recommended that you record the settings and keep the record with the Receiver.

If you need to change the serial port settings, for example, to set up for a different computer, use the guidelines given in this section.

Serial port settings are changed by issuing commands.

It is recommended that you issue a single compound command which simultaneously sets all the serial port parameters. Then connect the other computer and begin using the instrument with the new settings.

NOTE

If you choose to set parameters one at a time, you will make the procedure more difficult. That is, with each change, the instrument will be updated, but your computer will retain its original settings. At each step, you will have stopped serial communications and be forced to modify your PC settings to match the Receiver in order to continue. It is recommended that you make all changes in a single compound command, verify the changes, and record all parameters.

Configuring PORT 1 of the 59551A

Complete configuration of **PORT 1** of the 59551A requires that you set *five* parameters. The command line sent in the following example would set the RS-232C port pacing to XON, baud rate to 2400, parity to EVEN, data bits to 7, and stop bits to 2. This command line must be transmitted on **PORT 1**.

```
SYST:COMM:SER:PACE XON; BAUD 2400; PARITY EVEN; BITS 7; SBITS 2
```

Configuring PORT 1 of the 58503B and PORT 2 of the 59551A

Complete configuration of **PORT 1** (58503B) and **PORT 2** (59551A) require that you set *three* parameters. The command line sent in the following example would set the RS-232C port pacing to XON, baud rate to 2400, and parity to EVEN. This command line must be transmitted on **PORT 1** or **PORT 2**.

```
SYST:COMM:SER2:PACE XON; BAUD 2400; PARITY EVEN
```

Configuring the RS-232C Port(s)

Determining the Serial Port Settings

Standard 58503B and 59551A

If you connect your PC, press Return, and do not get a **scpi>** prompt back from the Receiver, your Receiver's serial communication settings may have been modified. You need to systematically step through the data communication settings on your PC until your PC matches the Receiver. The Receiver cannot communicate its settings until this process is complete.

Iterate until you are able to verify that settings on your PC match the Receiver.

When you are successful, you will have restored full RS-232C communications, enabling you to query the Receiver's communication settings. Once you establish communications with one serial port, you can query the Receiver for settings of either port.

Issue the following queries to either serial port to verify **PORT 1's** configuration.

```
SYST:COMM:SER:PACE?  
SYST:COMM:SER:BAUD?  
SYST:COMM:SER:PARITY?  
SYST:COMM:SER:BITS?  
SYST:COMM:SER:SBITS?
```

Issue the following queries to either serial port to verify **PORT 2's** configuration.

```
SYST:COMM:SER2:PACE?  
SYST:COMM:SER2:BAUD?  
SYST:COMM:SER2:PARITY?  
SYST:COMM:SER2:BITS?  
SYST:COMM:SER2:SBITS?
```

Chapter 2 Serial Interface Capabilities
Configuring the RS-232C Port(s)

Visual User Interface

Using the Receiver Status Screen

Chapter Contents

This chapter provides a tutorial section on how to use the Receiver Status Screen, a comprehensive reference information section, and an illustrated foldout of the Receiver Status Screen, which is a comprehensive summary of key operation conditions and settings.

This chapter is organized as follows:

- Using and Reading the Visual User Interface (the Receiver Status Screen) page 3-3
 - Tutorial on Using the Status Screen to Interface With the Receiver page 3-3
 - Demonstration of Holdover Operation page 3-8
- Receiver Status Screen Data page 3-11
 - SYNCHRONIZATION Section of the Status Screen page 3-12
 - ACQUISITION Section of the Status Screen page 3-14
 - HEALTH MONITOR Section of the Screen page 3-18
- The Receiver Status Screen at a Glance (foldout) page 3-19

Using and Reading the Visual User Interface (the Receiver Status Screen)

The combination of the PC and the GPS Receiver yields a visual user interface called the Receiver Status Screen that lets you see what the Receiver is doing and how it is progressing towards tracking satellites to eventually lock to the GPS signal.

When connected to a properly configured PC, the Receiver Status Screen can be accessed. There are two ways to access and use the Receiver Status Screen:

- By installing a commercially available terminal emulation program, connecting the Receiver to a PC via the **PORT 1** port, and manually sending the `:SYSTEM:STATUS?` query. (Refer to Chapter 1, “Getting Started,” in *58503B/59551A Getting Started Guide*.)
- By installing and operating the SatStat program, which automatically generates continual status screen updates, and connecting the Receiver to a PC via **PORT 1**. (Refer to the sections titled “Installing the Automated SatStat Program for Continual Status Updates” and “Operating the Automated SatStat Program” in Chapter 1, “Getting Started,” of the *58503B/59551A Getting Started Guide* for details on installation and operation.)

The following tutorial demonstrates how you can use the Receiver Status Screen to observe Receiver operation. The tutorial uses the manual (`:SYSTEM:STATUS?`) method.

Tutorial on Using the Status Screen to Interface With the Receiver

Type `:SYSTEM:STATUS?` at the **scpi>** prompt.

An initial power-up screen is displayed, which is similar to the demonstration screen shown in Figure 3-1. The first data that you should look at is in the SYNCHRONIZATION area of the screen. It is telling you that it is in the Power-up state as indicated by the `>>` marker. That is, the Receiver has just been put on line.

Using and Reading the Visual User Interface (the Receiver Status Screen)

```

----- Receiver Status -----
SYNCHRONIZATION ..... [ Outputs Invalid ]
SmartClock Mode _____ Reference Outputs _____
  Locked                    TFOM      9                FFOM      3
  Recovery                   1PPS TI  --
  Holdover                   HOLD THR 1.000 us
>> Power-up:GPS acquisition Holdover Uncertainty_____
                             Predict  --

ACQUISITION ..... [GPS 1PPS Invalid]
Tracking: 0 _____ Not Tracking: 6 _____
      PRN  El  Az                Time _____
      *1  --  ---                UTC      12:00:00[?] 01 Jan 1996
      *6  --  ---                GPS 1PPS Invalid: not tracking
      *9  --  ---                ANT DLY  0 ns
      *14 --  ---                Position _____
      *22 --  ---                MODE      Survey: 0% complete
      *24 --  ---                Suspended:track <4 sats
                                     INIT LAT N  0:00:00.000
                                     INIT LON W  0:00:00.000
ELEV MASK 10 deg *attempting to track INIT HGT                0 m (GPS)
HEALTH MONITOR ..... [ OK ]
Self Test: OK Int Pwr: OK Oven Pwr: OK OCXO: OK EFC: OK GPS Rcv: OK

```

Figure 3-1. Receiver Status Screen at Powerup

The ACQUISITION area of the screen is telling you that no satellites have been tracked. The identification numbers of several satellites appear in the Not Tracking column. The asterisk next to the satellite identification number, or pseudorandom noise code (PRN), indicates the Receiver is attempting to track it.

The current time and date are shown in the Time quadrant of the ACQUISITION area. The default power-up setting, indicated by [?], is corrected when the first satellite is tracked. Since the Receiver is not tracking any satellites, the GPS 1 PPS reference signal is invalid.

An accurate position is necessary to derive precise time from GPS. The Position quadrant indicates that the Receiver is in survey mode, which uses GPS to determine the position of the GPS antenna. This process has not yet started, since position calculations can be performed only while tracking four or more satellites. INIT LAT, INIT LON, and INIT HGT are the initial estimate of the true position. These coordinates are refined by the survey process. The Receiver uses this position and the time-of-day to select satellites to track. Therefore, you can reduce satellite acquisition time by specifying a close approximation of position and time.

Now, let's send the :SYSTEM:STATUS? query again to see what kind of progress the Receiver has made.

Using and Reading the Visual User Interface (the Receiver Status Screen)

You can now see that the Receiver is tracking several satellites as shown in Figure 3-2. The process of acquiring and tracking satellites is described in the following paragraphs.

```

----- Receiver Status -----
SYNCHRONIZATION ..... [ Outputs Valid/Reduced Accuracy ]
SmartClock Mode _____ Reference Outputs _____
>> Locked to GPS: stabilizing frequency TFOM 6 FFOM 1
Recovery 1PPS TI +71 ns relative to GPS
Holdover HOLD THR 1.000 us
Power-up Holdover Uncertainty _____
Predict --

ACQUISITION ..... [GPS 1PPS Valid]
Tracking: 5 _____ Not Tracking: 4 _____
PRN El Az C/N PRN El Az Time _____
2 70 337 49 9 11 292 UTC 17:56:44 31 Jan 1996
7 46 188 48 16 24 243 GPS 1PPS Synchronized to UTC
15 33 82 38 *26 Acq.. ANT DLY 0 ns
19 28 113 36 31 -- --- Position _____
22 65 91 49 MODE Survey: 1.2% complete

AVG LAT N 37:19:34.746
AVG LON W 121:59:50.502
AVG HGT +34.14 m (GPS)
ELEV MASK 10 deg *attempting to track
HEALTH MONITOR ..... [ OK ]
Self Test: OK Int Pwr: OK Oven Pwr: OK OCXO: OK EFC: OK GPS Rcv: OK

```

Figure 3-2. Receiver Status Screen Displaying Initial Satellite Acquisition

An asterisk (*) next to the PRN of a satellite in the Not Tracking column indicates the Receiver is attempting to track it. The elevation (El) and azimuth (Az) angles of the satellite are indicated. Acq . or Acq .. tell you that the Receiver is attempting to track that satellite. One dot after the Acq indicator shows that the Receiver is attempting to acquire its signal, and two dots indicate impending lock. Eventually, you will see the satellite move to the Tracking column, which shows the satellite PRN, the elevation angle of the satellite in the sky (90° being zenith), the azimuth angle (number of degrees bearing from true north), and the carrier-to-noise ratio (C/N). A good carrier-to-noise ratio is a number above 35, which would be efficient for the Receiver to operate. Numbers below 35, suggest intermittent tracking of the satellite or no tracking; check your antenna system should this be the case.

As indicated by the demonstration screen in Figure 3-2, the Receiver is now surveying for position. It is tracking four satellites which is the minimum number that must be tracked to determine position. As you can see, the Position MODE line indicates survey is 1.2% complete. A complete survey would take two hours during which four satellites or more are continuously tracked.

Using and Reading the Visual User Interface (the Receiver Status Screen)

Also, you can see the initial (estimated) position has been replaced with a computed position, which the Receiver continuously refines until it gets a very accurate position. The status screen indicates that a computed position is being used by displaying the averaged latitude, and longitude height (AVG LAT, AVG LON, and AVG HGT).

If the position were not precise, GPS timing information would be inaccurate by an amount corresponding to the error in the computed position. An error in the computed position of the antenna translates into an error in the derived time and will compromise the Receiver's ability to be a timing source.

Let's consider a case where four satellites are not visible at powerup because of a poor antenna location, such as an "urban canyon" (located between tall city buildings). If accurate position is known from a Geodetic survey of that site, it can be programmed with the position command, thereby bypassing the survey operation. This is useful when four satellites cannot be tracked for an extended period of time.

Let's send the `:SYSTEM:STATUS?` query again to observe the current status of the Receiver.

The updated demonstration status screen in Figure 3-3 indicates that the position survey is now 5.4% complete. Thus, the survey task is beginning to iterate toward an accurate position. In the Time quadrant, the UTC time is now correct. The date is correct, and the GPS reference signal is synchronized to UTC.

Using and Reading the Visual User Interface (the Receiver Status Screen)

```

----- Receiver Status -----
SYNCHRONIZATION ..... [ Outputs Valid/Reduced Accuracy ]
SmartClock Mode _____ Reference Outputs _____
>> Locked to GPS: stabilizing frequency      TFOM      4      FFOM      1
Recovery                                     1PPS TI +20 ns relative to GPS
Holdover                                     HOLD THR 1.000 us
Power-up                                     Holdover Uncertainty _____
                                           Predict 432.0 us/initial 24 hrs

ACQUISITION ..... [GPS 1PPS Valid]
Tracking: 6 _____ Not Tracking: 1 _____
PRN  El  Az  C/N  PRN  El  Az      Time _____
  2   70 301  40   16  13 258      UTC      18:47:07   31 Jan 1996
  7   35 186  38                                     GPS 1PPS Synchronized to UTC
19   40 102  38                                     ANT DLY  0 ns
22   71  60  39                                     Position _____
26   19 317  36                                     MODE      Survey: 5.4% complete
31   16  41  35                                     AVG LAT  N 37:19:34.937
                                           AVG LON  W 121:59:50.457
                                           AVG HGT  +67.94 m (GPS)
ELEV MASK 10 deg
HEALTH MONITOR ..... [ OK ]
Self Test: OK Int Pwr: OK Oven Pwr: OK OCXO: OK EFC: OK GPS Rcv: OK

```

Figure 3-3. Receiver Status Screen Displaying Progress Towards Steady-State Operation

In the SYNCHRONIZATION area, the >> marker is pointed at the Locked to GPS line, indicating that the Receiver is locked to GPS and stabilizing the frequency of its oscillator. This means that the Receiver has phase-locked its oscillator to the 1 PPS reference signal provided by GPS, but it is not at its final, or most stable, state. The Receiver is locked and the front-panel **GPS Lock** LED is illuminated.

For users without the command interface (PC/Terminal emulator connected to the Receiver), the illuminated **GPS Lock** LED is probably the first indication that after powerup that the Receiver is moving towards a stable state.

With the command interface and status screen, you can get more detailed information. For example, you can read the reference outputs quality indicators in the Reference Outputs area of the status screen. These are the Time Figure of Merit (TFOM) and Frequency Figure of Merit (FFOM) indicators. As shown in Figure 3-3, the TFOM is 4 and the FFOM is 1. These values will eventually decrease towards the ultimate values that represent steady-state performance. Refer to the subsection titled ““Reference Outputs” on page 3-13 in this chapter for more information about TFOM and FFOM.

Using and Reading the Visual User Interface (the Receiver Status Screen)

Also indicated is a prediction of the accuracy of the Receiver should it go into holdover operation.

Demonstration of Holdover Operation

CAUTION

The Receiver typically reaches stable state 24 to 72 hours after powerup, and it will learn best if its experiences no holdover in the first 24 hours. Therefore, the holdover demonstration in the following paragraphs will compromise the Receiver's ability to learn the characteristics of its internal reference oscillator. For the purpose of education only, you will be shown how to initiate a holdover.

A user should *never* initiate holdover during the first 24 hours while the Receiver is learning its internal oscillator characteristics. The Receiver should maintain GPS lock during this time because it is using the GPS signal to discipline the oscillator. It will learn what the oscillator drift characteristics are relative to the GPS signal. It will learn how the oscillator ages, and the software will learn how to compensate for that aging.

Thus, it is recommended that the Receiver is always kept locked to GPS during the first 24 hours.

For demonstration purposes, and since the Receiver has been powered up for a while, let's put the Receiver into holdover by simply removing the antenna connection. (*Note that holdover also can be manually initiated by sending the SYNCHRONIZATION:HOLDOVER:INITIATE command; however, for this demonstration, disconnect the antenna cable.*) The following will occur after a verification delay:

- The front-panel **Holdover** LED will illuminate, and
- after sending the :SYSTEM:STATUS? query again, a screen similar to Figure 3-4 should appear.

Let's send the :SYSTEM:STATUS? query. Figure 3-4 should appear.

Using and Reading the Visual User Interface (the Receiver Status Screen)

```

----- Receiver Status -----
SYNCHRONIZATION..... [ Outputs Valid/Reduced Accuracy ]
SmartClock Mode _____ Reference Outputs _____
  Locked to GPS _____ TFOM      3          FFOM      2
  Recovery _____ 1PPS TI  --
>> Holdover: GPS 1PPS invalid HOLD THR 1.000 us
  Power-up _____ Holdover Uncertainty _____
                               Predict 432.0 us/initial 24 hrs
                               Present 1.0 us
                               Holdover Duration: 0m 14s
ACQUISITION ..... [GPS 1PPS Invalid]
Tracking: 0 _____ Not Tracking: 7 _____
      PRN  El  Az  PRN  El  Az  Time _____
      *2   71 316 *31  12  29  UTC      20:56:14  31 Jan 1996
      *7   41 186          GPS 1PPS  Inaccurate: not tracking
      15  11  86          ANT DLY  0 ns
      *19  35 107          Position _____
      *22  68  78          MODE      Survey: 71.1% complete
      *26  23 314          LAT       N 37:19:32.472
                               LON       W 121:59:51.784
                               HGT       +42.19 m (GPS)
ELEV MASK 10 deg *attempting to track
HEALTH MONITOR ..... [ OK ]
Self Test: OK Int Pwr: OK Oven Pwr: OK OCXO: OK EFC: OK GPS Rcv: OK

```

Figure 3-4. Receiver Status Screen Displaying Holdover Operation

In the SYNCHRONIZATION area, you can see that the Receiver has gone into holdover as indicated by >> marker that is pointing at the Holdover line. The status screen indicates that the reason the Receiver is in holdover is because the GPS 1 PPS reference signal is invalid.

You would expect this since the antenna has been disconnected.

The status screen shows loss of the GPS signal. As you can see on the screen, all of the satellites in the Tracking column moved into the Not Tracking column.

The status screen in Figure 3-4 shows that the Receiver has been in holdover operation for 14 seconds.

If the Receiver SmartClock had had enough time to learn the internal oscillator characteristics, the Receiver Status Screen would show that the Receiver went into holdover, and the Receiver's outputs were maintained during holdover by the SmartClock.

Using and Reading the Visual User Interface (the Receiver Status Screen)

When the GPS antenna is re-connected and the GPS signal has been re-acquired, the Receiver has the ability to recover from holdover by itself. The SYNCHRONIZATION area of the screen will show the >> marker pointing at the Recovery line (and then eventually at the Locked to GPS line), the **GPS Lock LED** will illuminate, and the screen will look similar to Figure 3-5.

```

----- Receiver Status -----
SYNCHRONIZATION .....[ Outputs Valid/Reduced Accuracy ]
SmartClock Mode _____ Reference Outputs _____
>> Locked to GPS: Stabilizing frequency TFOM 3 FFOM 1
Recovery 1PPS TI +10.6 ns relative to GPS
Holdover HOLD THR 1.000 us
Power-up Holdover Uncertainty _____
Predict 432.0 us/initial 24 hrs

ACQUISITION ..... [GPS 1PPS Valid]
Tracking: 6 _____ Not Tracking: 0 _____
PRN El Az C/N Time _____
 2 71 317 40 UTC 20:59:28 31 Jan 1996
 7 34 185 38 GPS 1PPS Synchronized to UTC
19 41 101 37 ANT DLY 0 ns
22 67 80 40 Position _____
26 24 312 37 MODE Survey: 71.4% complete
31 12 27 36 LAT N 37:19:32.486
LON W 121:59:52.082
ELEV MASK 10 deg HGT +40.06 m (GPS)
HEALTH MONITOR ..... [ OK ]
Self Test: OK Int Pwr: OK Oven Pwr: OK OCXO: OK EFC: OK GPS Rcv: OK

```

Figure 3-5. Receiver Status Screen Following Recovery from Holdover Operation

You can see the Receiver has recovered from holdover almost immediately and it has returned to locked operation.

Receiver Status Screen Data

This section defines the data displayed in the Receiver Status Screen, shown in Figure 3-6.

```

----- Receiver Status -----
SYNCHRONIZATION ..... [ Outputs Valid ]
SmartClock Mode _____ Reference Outputs _____
>> Locked to GPS          TFOM      3          FFOM      0
Recovery                  1PPS TI +7.2 ns relative to GPS
Holdover                  HOLD THR 1.000 us
Power-up                  Holdover Uncertainty _____
                          Predict 49.0 us/initial 24 hrs

ACQUISITION ..... [GPS 1PPS Valid]
Tracking: 6 _____ Not Tracking: 1 _____
PRN  El  Az  C/N  PRN  El  Az          Time _____ +1 leap second pending
 2   49  243  49   14  11  82          UTC      23:59:59   31 Dec 1995
16   24  282  46                               GPS 1PPS Synchronized to UTC
18   38  154  47                               ANT DLY  120 ns
19   65   52  49                               Position _____
27   62  327  49                               MODE     Survey: 17.5% complete
31   34   61  47                               AVG LAT  N 37:19:32.264
                                          AVG LON  W 121:59:52.112
                                          AVG HGT          +41.86 m (GPS)

ELEV MASK 10 deg
HEALTH MONITOR ..... [ OK ]
Self Test: OK Int Pwr: OK Oven Pwr: OK OCXO: OK EFC: OK GPS Rcv: OK

```

Figure 3-6. Sample Status Screen

The status screen has three major sections:

- SYNCHRONIZATION
- ACQUISITION
- HEALTH MONITOR

The SYNCHRONIZATION section of the status screen shows how the GPS Receiver's SmartClock™ technology is progressing towards its objective, which is to synchronize the Receiver's oscillator to the 1 PPS reference signal produced by the Receiver's internal GPS Engine.

The ACQUISITION section of the status screen shows how the Receiver's internal GPS Engine is progressing towards its objective, which is to produce an accurate internal 1 PPS reference signal. It does so through tracking GPS satellites.

The HEALTH MONITOR section of the status screen summarizes the overall health of the product.

Receiver Status Screen Data

SYNCHRONIZATION Section of the Status Screen

SYNCHRONIZATION Summary Line

The **SYNCHRONIZATION** line in the screen summarizes the **SmartClock Status** and **Reference Outputs**. One of three SYNCHRONIZATION messages is shown:

<i>Outputs Invalid</i>	while the Receiver (unit) is warming up,
<i>Outputs Valid/ Reduced Accuracy</i>	while the unit is in holdover or is locked but has not achieved steady-state operation, or
<i>Outputs Valid</i>	while the unit is in steady-state operation.

SmartClock Mode

The SmartClock Mode area of the screen shows the four operating modes:

- Locked to GPS
- Recovery
- Holdover
- Power-up

As shown in the sample status screen in Figure 3-6, a >> symbol indicates the current operating mode.

Locked to GPS indicates that the Receiver is locked to GPS. The front-panel **GPS Lock** LED will be illuminated.

When *stabilizing frequency ...* is shown, the time output (1 PPS) signal is locked and can be used, but the frequency outputs (10 MHz) are not at their final or most stable state.

Recovery indicates that the Receiver is actively working to become locked to GPS. All conditions needed to proceed towards a lock have been met. Expect an eventual spontaneous transition to a lock (unless changing external conditions prevent this, such as loss of tracked satellites.)

Holdover indicates that the Receiver is waiting for conditions that are needed to allow the process of recovery from holdover to begin. Once these conditions are met, the Receiver will transition on its own to the recovery mode.

When the *GPS 1PPS CLK invalid* message follows the **Holdover** label, the internal GPS 1 PPS reference signal is inaccurate.

Receiver Status Screen Data

When the *manually initiated* message follows the **Holdover** label, the Receiver has been placed in holdover by the user. An explicit command is required to initiate an exit from manual holdover.

When the *1 PPS TI exceeds hold threshold* message follows the **Holdover** label, the phase difference between the 1 PPS time output signal and the internal GPS 1 PPS reference signal has exceeded the user-entered holdover threshold value.

When the *internal hardware problem* message follows the **Holdover** label, a measurement hardware error exists.

The *Holdover Duration* message indicates the duration that the Receiver has been operating in holdover (and recovery). Thus, this message gives you an assessment of the quality of the outputs. The longer the Receiver is in holdover the more degraded the outputs become.

Power-up indicates that the Receiver hasn't yet achieved GPS lock or acquired satellites since it has been powered up. The Receiver is measuring the internal reference oscillator's frequency and adjusting it to 10 MHz during this power-up period. Other queries can provide insight as to the cause if the Receiver is remaining in powerup longer than expected.

Reference Outputs

TFOM (Time Figure of Merit) indicates the *accuracy* of the Receiver's internal 1 PPS signal. A low TFOM value indicates a more accurate signal. In the sample screen of Figure 3-6, a value of 3 is displayed, meaning that the Time Error ranges from 100 to 1000 nanoseconds. The following table lists the TFOM values that could be displayed and the corresponding Time Error.

TFOM Value	Time Error (in nanoseconds)	TFOM Value	Time Error (in nanoseconds)
*0	less than 1	5	$10^4 - 10^5$
*1	1 – 10	6	$10^5 - 10^6$
*2	10 – 100	7	$10^6 - 10^7$
3	100 – 1000	8	$10^7 - 10^8$
4	$10^3 - 10^4$	9	greater than 10^8

*The TFOM values 0, 1, and 2 are not presently used in the Receiver. The Receiver will display TFOM values ranging from 9 to 3, which is consistent with the specified accuracies of each product.

Receiver Status Screen Data

FFOM (Frequency Figure of Merit) indicates the *stability* of the Receiver's internal 10 MHz signal. The 10 MHz signal is controlled by the SmartClock's Phase-Locked Loop (PLL). Thus, the FFOM value is determined by monitoring the status of the PLL.

In the sample screen of Figure 3-6, the 0 indicates that the SmartClock's PLL is stabilized. The following table lists and defines the FFOM values that could be displayed.

FFOM Value	Definition
0	PLL stabilized — internal 10 MHz signal within specification.
1	PLL stabilizing
2	PLL unlocked (holdover) — Initially the 10 MHz signal will be within specifications. However, when in holdover, the 10 MHz signal will eventually drift out of specification.
3	PLL unlocked (not in holdover) — Do not use the output.

1PPS TI indicates the difference (timing shift) between the SmartClock 1 PPS and the internal GPS 1 PPS signals.

HOLD THR (holdover threshold) displays the user-entered time error value.

ACQUISITION Section of the Status Screen***ACQUISITION Line***

The **ACQUISITION** line in the screen summarizes the state of the internal GPS Engine as indicated by the **Tracking**, **Not Tracking**, and **Position** areas of the screen.

If the Receiver Engine was considered to be synchronized to the GPS signal, the [*GPS 1 PPS Valid*] message will appear at the end of the **ACQUISITION** line. If the Receiver has not yet synchronized to GPS, the [*GPS 1 PPS CLK Invalid*] message will be displayed.

Tracking, Not Tracking

The **Tracking** table indicates the number of satellites the Receiver is tracking.

The **Not Tracking** table indicates satellites predicted to be visible that are not tracked, and all of the satellites that are assigned to a GPS Engine channel but are not currently tracked.

Receiver Status Screen Data

Health and status indicators in the tables are defined as follows:

PRN	indicates the pseudorandom noise code assigned to the satellite.
EI	indicates the predicted elevation angle, from a range of 0 to 90°. The predicted elevation is derived from the almanac.
--	indicates that the elevation angle is unknown (the almanac did not provide this data).
Az	indicates the predicted azimuth angle, from a range of 0 to 359°. The predicted azimuth angle is referenced to true north, and is derived from the almanac.
---	indicates that the azimuth angle is unknown (the almanac did not provide this data).
C/N (58503B)	indicates the carrier-to-noise ratio of the received the signal, from a range of 26 to 55. A ratio below 35 is a weak signal that may not be acquired by the Receiver.
or	
SS (59551A)	indicates the strength of the signal, from a range of 0 to 255. A signal strength of 20 to 30 is a weak signal that may not be acquired by the Receiver.

The health and status indicators in the **Not Tracking** table are described as follows:

<i>Ignore</i>	indicates that the user has chosen to exclude this satellite from a list of satellites available for tracking.
<i>Not OK</i>	indicates GPS has reported that this satellite is unhealthy.
<i>Acq</i>	indicates the unit is attempting to acquire the satellite signal.
<i>Acq.</i>	indicates the unit is reading timing information from the satellite.
<i>Acq..</i>	indicates the unit is reading satellite orbital information.
ELEV MASK	indicates the elevation mask angle in degrees. Satellites at or above this elevation angle are considered for tracking.
<i>*attempting to track</i>	indicates that the Receiver is attempting to track a satellite.

Receiver Status Screen Data

Time

When you first power up the unit the time and date that is stored in the internal GPS Engine may not be the actual date. The actual time and date will be valid after one satellite has been tracked by the Receiver.

NOTE

There are two accurate ways to express time (GPS or UTC). GPS time is offset from UTC time by the number of accumulated leap seconds since midnight of January 6, 1980 UTC.

The **Time** area of the status screen provides three types of information: **Time**, **1PPS CLK**, and **ANT DLY**.

Time has four possible modes: *GPS*, *UTC*, *LOCL GPS*, and *LOCAL*.

GPS indicates current time and date collected from a satellite in GPS Time.

LOCL GPS indicates GPS Time, offset for the local time zone.

UTC indicates current time and date collected from a satellite in UTC time.

LOCAL indicates current time and date collected from a satellite offset from UTC for the local time zone.

1PPS CLK can indicate several possible advisory messages. These messages are:

Synchronized 1 PPS locked to GPS, referenced to GPS Time.
to GPS Time

Synchronized 1 PPS locked to GPS, referenced to UTC.
To UTC

Assessing stability ... applying hysteresis to locked 1 PPS signal.

Inaccurate, not tracking not tracking satellites.

Inaccurate, inacc position in survey mode, but has not yet calculated a position.

Absent or freq incorrect no 1PPS signal; or the internal GPS Engine is idle.

Receiver Status Screen Data

ANT DLY (antenna delay) displays the user-entered value that is used to compensate for the propagation delay of the antenna cable.

Position

Position area of the status screen provides four types of information: **MODE** (hold or survey), **LAT** (latitude), **LON** (longitude), and **HGT** (height).

MODE indicates whether the unit is set to Hold or Survey position mode.

When *Hold* is displayed, the unit's antenna position has been provided by the user, or the average position has been found after completion of survey.

If the unit is in the position *Hold* mode, the **LAT**, **LON**, and **HGT** "held" position coordinates will be displayed.

If *Survey*: *57.3% complete* is displayed, for example, the Receiver is set to survey mode trying to determine the position of the antenna. The % value indicates the progress of the surveying.

At the beginning of a survey (0% completion), the following "estimated" position coordinates will be displayed:

INIT LAT indicates the estimated latitude (North or South) position of the unit in degrees, minutes, and seconds.

INIT LON indicates the estimated longitude (East or West) position of the unit in degrees, minutes, and seconds.

INIT HGT indicates estimated height of the unit's antenna, in meters above the GPS ellipsoid for 58503B (in meters above mean sea level, MSL, for the 59551A).

Once survey starts, the following "averaged" position coordinates will be displayed:

AVG LAT indicates the average latitude (North or South) position of the unit in degrees, minutes, and seconds.

AVG LON indicates the average longitude (East or West) position of the unit in degrees, minutes, and seconds.

AVG HGT indicates average height of the unit's antenna, in meters above the GPS ellipsoid for 58503B (in meters above mean sea level, MSL, for the 59551A).

Receiver Status Screen Data

The possible advisory messages that can be displayed when position mode is Survey are:

Suspended: track <4 sats

Suspended: poor geometry

Suspended: no track data

HEALTH MONITOR Section of the Screen

The HEALTH MONITOR section of the status screen reports errors or failures of the key hardware functions. The *OK* summary message at the end of the **HEALTH MONITOR** line indicates that no errors or failures were detected. *Error* indicates that one or more hardware tests failed.

For each hardware function, *OK* is reported when it is operating normally; *Err* is displayed when a failure or an error is detected.

Hardware functions are monitored periodically, with the exception of Self Test, which is performed at powerup or when requested.

The health and status indicators in the HEALTH MONITOR section are described as follows:

Self Test	Last diagnostic check of the microprocessor system, reference oscillator, satellite receiver, and power supplies failed.
Int Pwr	Internal power supply voltage(s) exceeds tolerance.
Oven Pwr	Oscillator oven power supply voltage exceeds tolerance.
OCXO	Oscillator output failed.
EFC	Oscillator control voltage is at or near full-scale.
GPS Rcv	Satellite receiver communication failed, or GPS 1PPS reference is absent.

The Receiver Status Screen at a Glance

11" by 17" foldout.

Chapter Contents

This chapter is a quick reference that summarizes the GPS Receiver commands which allow you to operate and program the Receiver.

This chapter is organized as follows:

- An Introduction to GPS Receiver Commands page 4-4
 - SCPI Conformance Information page 4-4
 - Command Syntax Conventions page 4-4
 - Command Presentation page 4-4
- GPS Satellite Acquisition page 4-5
 - Facilitating Initial Tracking page 4-5
 - Establishing Position page 4-5
 - Selecting Satellites page 4-6
 - Compensating for Antenna Delay page 4-6
 - Monitoring Acquisition page 4-6
- 1 PPS Reference Synchronization page 4-7
 - Monitoring 1 PPS Synchronization page 4-7
 - Assessing 1 PPS Quality page 4-7
 - Operating in Holdover page 4-7
- Operating Status page 4-8
 - Receiver Operation at a Glance page 4-8
 - Reading the Error Queue page 4-8
 - Reading the Diagnostic Log page 4-8
 - Monitoring Status/Alarm Conditions page 4-8
 - Assessing Receiver Health page 4-9

Chapter Contents

- System Time page 4-10
 - Identifying Time of Next 1 PPS Reference Edge page 4-10
 - Reading Current Time page 4-10
 - Applying Local Time Zone Offset page 4-10
 - Defining the 1 PPS Reference Edge (59551A Only) page 4-10
 - Reading Leap Second Status page 4-10
- Programmable Pulse Output (59551A Only) page 4-11
- Event Time Stamping (59551A Only) page 4-12
 - Defining the Time-stamped Edge page 4-12
 - Clearing Time Stamp Memory page 4-12
 - Reading Time Stamps page 4-12
 - Processing Memory Overflow page 4-12
- Serial Interface Communication page 4-13
 - Configuring I/O Port 1 page 4-13
 - Configuring I/O Port 2 (59551A Only) page 4-13
 - Recovering the Last Query Response page 4-13
- Receiver Initialization page 4-14
- Receiver Identification/Upgrade page 4-15
 - Reading Product Identification page 4-15
 - Installing Firmware via I/O Port 1 page 4-15
- Receiver Commands at a Glance/Status Reporting System at a Glance (foldout) page 4-17

An Introduction to GPS Receiver Commands

SCPI Conformance Information

The SCPI commands used in the GPS Receiver are in conformance with the SCPI Standard Version 1994.0.

Details of all the GPS Receiver commands can be found in Chapter 5, “Command Reference,” of this guide.

Information on the SCPI commands format, syntax, parameter, and response types is provided in Appendix B, “Command Syntax and Style,” of this guide.

Command Syntax Conventions

POSition Means you **MUST** use either all the upper case letters or the entire word. The lower case letters are optional. For example, POS and POSITION are both valid. However, POSI is not valid. (Note: POSition is used here as an example, but this convention is true for all command keywords.) In other words, the short form of the keywords is shown in uppercase.

NOTE

When you see quotation marks in the command’s parameter, you must send the quotation marks with the command.

Command Presentation

The shaded commands listed in the following sections are the “basic” (fundamental) or most commonly used commands. These commands are essential for operating the Receiver; thus, a brief description of each of these commands is included in this section. More complete descriptions are provided in Chapter 5, “Command Reference.”

The non-shaded commands listed in this section are not fundamental or not commonly used. These commands are used for one-time setup, advanced, or specialized operation of the Receiver. Descriptions of these commands are provided in Chapter 5 only.



GPS Satellite Acquisition

The following commands are provided to facilitate initial GPS satellite tracking, to establish accurate GPS antenna position, to select or ignore satellites, to compensate for antenna cable delay, and to monitor the acquisition.

Facilitating Initial Tracking

:GPS:INITial:DATE <four-digit year>, <month>, <day>

:GPS:INITial:POSition N or S, <latitude degree>,
 <latitude minute>,
 <latitude second>,
 E or W, <longitude degree>,
 <longitude minute>,
 <longitude second>,
 <height above the GPS ellipsoid, in meters (58503B)>
 or
 <height above mean sea level, in meters (59551A)>

:GPS:INITial:TIME <hour>, <minute>, <second>

Establishing Position

:GPS:POSition N or S, <latitude degree>,
 <latitude minute>,
 <latitude second>,
 E or W, <longitude degree>,
 <longitude minute>,
 <longitude second>,
 <height above the GPS ellipsoid, in meters (58503B)>
 or
 <height above mean sea level, in meters (59551A)>

Specifies the position of the GPS antenna.

:GPS:POSition?

Returns the current average position of the GPS antenna.

:GPS:POSition:ACTual?

Returns the current instantaneous position of the GPS antenna.

:GPS:POSition LAST

:GPS:POSition SURVey

:GPS:POSition:HOLD:LAST?

:GPS:POSition:HOLD:STATe?

:GPS:POSition:SURVey:PROGress?

:GPS:POSition:SURVey:STATe ONCE

:GPS:POSition:SURVey:STATe?

:GPS:POSition:SURVey:STATe:POWerup ON or OFF

:GPS:POSition:SURVey:STATe:POWerup?

Basic command

GPS Satellite Acquisition

Selecting Satellites

<select> = IGNore or INCLude

```
:GPS:SATellite:TRACking:EMANgle <degrees>
Sets the GPS elevation mask angle value.
:GPS:SATellite:TRACking:EMANgle?
Returns the GPS elevation mask angle value.
:GPS:SATellite:TRACking:IGNore <PRN>, ... , <PRN> (59551A)
Sends list of satellites to ignore.
:GPS:SATellite:TRACking:IGNore? (59551A)
Returns list of satellites to ignore.

:GPS:SATellite:TRACking:INCLude <PRN>, ... , <PRN> (59551A)
:GPS:SATellite:TRACking:INCLude? (59551A)
:GPS:SATellite:TRACking:<select>:ALL (59551A)
:GPS:SATellite:TRACking:<select>:COUNT?
:GPS:SATellite:TRACking:<select>:NONE
:GPS:SATellite:TRACking:<select>:STATE? <PRN>
```

Compensating for Antenna Delay

```
:GPS:REFeRence:ADELay <seconds>
Sets the GPS antenna delay value in seconds.
:GPS:REFeRence:ADELay?
Returns the GPS antenna delay value in seconds.
```

Monitoring Acquisition

```
:GPS:REFeRence:VALid?
Indicates whether the date and time are valid (1 = valid).
:GPS:SATellite:TRACking?
Returns a list of all satellites being tracked.
:GPS:SATellite:VISible:PREDicted?
Returns the list of satellites (PRN) that the almanac predicts should be visible, given date, time, and position.

:GPS:SATellite:TRACking:COUNT?
:GPS:SATellite:VISible:PREDicted:COUNT?
```

Basic command



1 PPS Reference Synchronization

The following commands are provided to monitor the operating mode of the reference oscillator, to determine the accuracy and stability of the reference output signal(s), and to control the oscillator holdover process.

Monitoring 1 PPS Synchronization

:SYNChronization:STATe?
Returns the Receiver state.

:DIAGnostic:ROSCillator:EFControl:RELative?
:LED:GPSLock?
:LED:HOLDover?

Assessing 1 PPS Quality

:SYNChronization:FFOMerit?
Returns the Frequency Figure of Merit.

:SYNChronization:HOLDover:TUNCertainty:PREdicted?
Returns an estimate of the time error that can be expected for a one day holdover, given the current state of SmartClock learning in the Receiver.

:SYNChronization:HOLDover:TUNCertainty:PREsent?
Returns the current time interval error at any time during holdover operation, given the current state of SmartClock learning in the Receiver.

:SYNChronization:TFOMerit?
Returns the Time Figure of Merit.

:SYNChronization:TINTerval?
Returns the difference or timing shift between the SmartClock 1 PPS and the GPS 1 PPS signals.

:SYNChronization:HOLDover:DURation?
:SYNChronization:HOLDover:DURation:THReshold <seconds>
:SYNChronization:HOLDover:DURation:THReshold?
:SYNChronization:HOLDover:DURation:THReshold:EXCeeded?

Operating in Holdover

Initiating Manual Holdover

:SYNChronization:HOLDover:INITiate

Recovering from Holdover

:SYNChronization:HOLDover:WAITing?
Returns prioritized reason why the Receiver is waiting to recover.

:SYNChronization:HOLDover:RECOvery:INITiate
:SYNChronization:HOLDover:RECOvery:LIMIT:IGNore
:SYNChronization:IMMEDIATE

Basic command



Operating Status

The following commands are provided to obtain Receiver status information. There are several ways to obtain Receiver status using commands. For example, you can send a command to display the Receiver Status screen, to read the error queue, and to read the diagnostic log. You can also send a sequence of commands to read and control the status registers for alarm generation.

Receiver Operation at a Glance

```
:SYSTem:STATus?
```

Outputs a fully formatted status screen.

```
:SYSTem:STATus:LENGth?
```

Reading the Error Queue

```
:SYSTem:ERRor?
```

Returns the oldest error in the Error Queue and removes that error from the queue (first in, first out).

Reading the Diagnostic Log

```
:DIAGnostic:LOG:CLEar
```

Clears the diagnostic log.

```
:DIAGnostic:LOG:READ:ALL?
```

Returns all of the most recent diagnostic log entries.

```
:DIAGnostic:LOG:CLEar <current log size>
```

```
:DIAGnostic:LOG:COUNT?
```

```
:DIAGnostic:LOG:READ?
```

```
:DIAGnostic:LOG:READ? <entry number>
```

Monitoring Status/Alarm Conditions

Clearing and Presetting Alarms

```
*CLS
```

Clears the event status registers and error queue.

```
:STATus:PRESet:ALARm
```

Reading and Qualifying Alarms

```
:LED:ALARm?
```

Returns status of front-panel Alarm LED.

```
*SRE <bit mask>
```

```
*SRE?
```

```
*STB?
```

Basic command

Operating Status

Reading and Qualifying Receiver Status

<register> = OPERation <register> = QUEStionable

<register> = OPERation:HARDware

<register> = OPERation:HOLDover

<register> = OPERation:POWerup

:STATus:<register>:CONDition?
Returns the Condition Status Register value.

:STATus:<register>:EVENT?
Returns the Event Status Register value.

:STATus:<register>:ENABle <bit mask>

:STATus:<register>:ENABle?

:STATus:<register>:NTRansition <bit mask>

:STATus:<register>:NTRansition?

:STATus:<register>:PTRansition <bit mask>

:STATus:<register>:PTRansition?

Reading and Qualifying Command Error Status

*ESE <bit mask>

*ESE?

*ESR?

Reporting Questionable Status

:STATus:QUEStionable:CONDition:USER SET or CLear

:STATus:QUEStionable:EVENT:USER PTR or NTR

Assessing Receiver Health

*TST?
Executes an internal selftest and reports the results.

:DIAGnostic:LIFetime:COUNT?

:DIAGnostic:TEST? ALL or DISPlay or PROCessor or RAM or EEPROM or UART or QSPI
or FPGA or INTerpolator or IREFerence or GPS or POWer

:DIAGnostic:TEST:RESult?

Basic command



System Time

The following commands are provided to allow you to monitor and control the system date and time. These commands allow you access to a very accurate system clock that provides both date and time, to customize the clock for a local time zone, to identify the exact time, to identify the accumulated time difference (in seconds) between the GPS and UTC timelines, and to monitor leap second occurrences.

Identifying Time of Next 1 PPS Reference Edge

R :PTIME:TCODE?

Returns timecode message 980 to 20 ms prior to 1 PPS of indicated time.

Reading Current Time

:PTIME:DATE? or :SYSTEM:DATE?

:PTIME:TIME? or :SYSTEM:TIME?

:PTIME:TIME:STRing?

Applying Local Time Zone Offset

:PTIME:TZONE <hours>, <minutes>

Sets the time zone local time offset to provide an offset from UTC to serve as the basis for all reported time.

:PTIME:TZONE?

Returns the local time zone offset.

Defining the 1 PPS Reference Edge (59551A Only)

:PTIME:PPS:EDGE RIsing or FALLing

Selects the polarity of the 1 PPS on-time edge.

:PTIME:PPS:EDGE?

Returns the polarity of the 1 PPS on-time edge.

Reading Leap Second Status

:PTIME:LEAPsecond:ACCumulated?

Returns the leap second difference accumulated between GPS time and UTC time since the beginning of GPS time. The time units are seconds.

:PTIME:LEAPsecond:DATE?

:PTIME:LEAPsecond:DURation?

:PTIME:LEAPsecond:STATe?

Basic command

R: Accessible via rear-panel PORT 1.



Programmable Pulse Output (59551A Only)

The following commands are provided to allow you to operate and control the programmable pulse output of the 59551A GPS Receiver. The pulse output, which is programmable by the user, can either generate a stream of pulses at a specified start time and repetition interval, or can produce a single pulse at a specified time and then stop.

```
:PULSe:CONTInuous:PERiod <seconds>  
Sets the interval between pulses in seconds.  
:PULSe:CONTInuous:PERiod?  
Returns the interval between pulses in seconds.  
:PULSe:CONTInuous:STATe ON or OFF  
Selects whether the Programmable Pulse output will be just one pulse or a sequence of pulses.  
:PULSe:CONTInuous:STATe?  
Identifies whether the Programmable Pulse output is set to output a single pulse or sequence of pulses.  
:PULSe:REFerence:EDGE RIsing or FALLing  
Selects the polarity of the Programmable Pulse on-time edge.  
:PULSe:REFerence:EDGE?  
Returns the polarity of the Programmable Pulse on-time edge.  
:PULSe:STARt:DATE <four-digit year>, <month>, <day>  
Sets the date when the individual pulse (or first pulse of the pulse sequence) is to be generated at the Programmable Pulse output.  
:PULSe:STARt:DATE?  
Returns the date when the individual pulse (or first pulse of the pulse sequence) is generated at the Programmable Pulse output.  
:PULSe:STARt:TIME <hour>, <minute>, <second>  
Sets the time when the individual pulse (or first pulse of the pulse sequence) is to be generated at the Programmable Pulse output.  
:PULSe:STARt:TIME?  
Returns the time when the individual pulse (or first pulse of the pulse sequence) is generated at the Programmable Pulse output.
```

Basic command



Event Time Stamping (59551A Only)

The following commands are provided to allow you to time-tag and record events such as power surges and power outages. The time tagging input feature allows you to use the Receiver with equipment which produce a TTL edge when some important event happens in the base station. The Receiver has three time tagging inputs which record the time of occurrence of TTL edge(s).

Defining the Time-stamped Edge

<channel> = 1 or 2 or 3

:SENSe:TSTamp<channel>:EDGE RISING or FALLING
Selects the polarity of the edges the Receiver will timestamp.

:SENSe:TSTamp<channel>:EDGE?
Returns the polarity of the edges the Receiver will timestamp.

Clearing Time Stamp Memory

:SENSe:DATA:CLEAr
Clears the data in the measurement buffer for all Time Tag inputs.

:SENSe:DATA:CLEAr "TSTamp 1" or "TSTamp 2" or "TSTamp 3"

Reading Time Stamps

:SENSe:DATA? "TSTamp 1" or "TSTamp 2" or "TSTamp 3"
Returns the data in the timestamp measurement buffer for the specified Time Tag input.

:FORMat:DATA ASCii or INTeger

:FORMat:DATA?

:SENSe:DATA:POINTs?

:SENSe:DATA:POINTs? "TSTamp 1" or "TSTamp 2" or "TSTamp 3"

:SENSe:DATA:TSTamp? "TSTamp 1" or "TSTamp 2" or "TSTamp 3", <entry number>

Processing Memory Overflow

:SENSe:DATA:MEMory:OVERflow:COUNt?

:SENSe:DATA:MEMory:OVERflow:COUNt? "TSTamp 1" or "TSTamp 2" or "TSTamp 3"

:SENSe:DATA:MEMory:SAVE FIRST or LAST

:SENSe:DATA:MEMory:SAVE?

Basic command



Serial Interface Communication

The following commands are provided to allow you to configure the serial interface port(s) for instrument communications.

Configuring I/O Port 1

```
R :SYSTem:COMMunicate?
R :SYSTem:COMMunicate:SERial1:BAUD 1200 or 2400 or 9600 or 19200
R,F :SYSTem:COMMunicate:SERial1:BAUD?
R :SYSTem:COMMunicate:SERial1:BITS 7 or 8 (59551A)
R,F :SYSTem:COMMunicate:SERial1:BITS?
R :SYSTem:COMMunicate:SERial1:FDUPlex ON or OFF
R,F :SYSTem:COMMunicate:SERial1:FDUPlex?
R :SYSTem:COMMunicate:SERial1:PACe XON or NONE
R,F :SYSTem:COMMunicate:SERial1:PACe?
R :SYSTem:COMMunicate:SERial1:PARity EVEN or ODD or NONE
R,F :SYSTem:COMMunicate:SERial1:PARity?
R :SYSTem:COMMunicate:SERial1:SBITs 1 or 2 (59551A)
R,F :SYSTem:COMMunicate:SERial1:SBITs?
```

Configuring I/O Port 2 (59551A Only)

```
F :SYSTem:COMMunicate?
F :SYSTem:COMMunicate:SERial2:BAUD 1200 or 2400 or 9600 or 19200
R,F :SYSTem:COMMunicate:SERial2:BAUD?
R,F :SYSTem:COMMunicate:SERial2:BITS?
F :SYSTem:COMMunicate:SERial2:FDUPlex ON or OFF
R,F :SYSTem:COMMunicate:SERial2:FDUPlex?
F :SYSTem:COMMunicate:SERial2:PACe XON or NONE
R,F :SYSTem:COMMunicate:SERial2:PACe?
F :SYSTem:COMMunicate:SERial2:PARity EVEN or ODD or NONE or ONE
R,F :SYSTem:COMMunicate:SERial2:PARity?
R,F :SYSTem:COMMunicate:SERial2:SBITs?
```

Recovering the Last Query Response

```
:DIAGnostic:QUERy:RESPonse?
```

Basic command

R: Accessible via rear-panel PORT 1.

F: Accessible via Front-panel PORT 2 of the 59551A



Receiver Initialization

The following commands are provided to allow you to initialize or preset the serial interface port(s) and the Receiver to their factory shipment values.

```
R :SYSTem:COMMunicate:SERial1:PRESet  
  :SYSTem:COMMunicate:SERial2:PRESet (59551A Only)  
  :SYSTem:PRESet
```

Basic command

R: Accessible via Rear-panel PORT 1.



Receiver Identification/Upgrade

The commands provided in this section allow you to query the identification of the Receiver, and to perform firmware upgrades in the field after you obtain a new firmware disk.

Reading Product Identification

***IDN?**

Returns the Receiver identification.

Installing Firmware via I/O Port 1

R *CLS

R :DIAGnostic:DOWNload <Motorola S-record>

R :DIAGnostic:ERASe

R :DIAGnostic:ERASe?

R :SYSTem:ERRor?

R :SYSTem:LANGuage "INSTALL" or "PRIMARY"

R :SYSTem:LANGuage?

Basic command

R: Accessible via Rear-panel Port 1.

Chapter 4 Command Quick Reference
Receiver Identification/Upgrade

Receiver Commands at a Glance

11" by 17" foldout sheet.

Status Reporting System at a Glance

11" by 17" foldout sheet.

Chapter Contents

This chapter provides a description of each command that can be used to operate the GPS Receiver. The commands are grouped by functions. The functions are grouped and ordered the same as they are in Chapter 4, “Command Quick Reference,” and on the foldout “Receiver Commands at a Glance.”

This chapter is organized as follows:

- Command Syntax Conventions page 5-4
- Description Format page 5-5
 - Commands and Returns page 5-5
 - Query-Specific Information page 5-6
- GPS Satellite Acquisition page 5-7
 - Facilitating Initial Tracking page 5-9
 - Establishing Position page 5-12
 - Selecting Satellites page 5-17
 - Compensating for Antenna Delay page 5-22
 - Monitoring Acquisition page 5-24
- 1 PPS Reference Synchronization page 5-27
 - Monitoring 1 PPS Synchronization page 5-28
 - Assessing 1 PPS Quality page 5-30
 - Operating in Holdover page 5-36
- Operating Status page 5-39
 - Receiver Operation at a Glance page 5-41
 - Reading the Error Queue page 5-42
 - Reading the Diagnostic Log page 5-43
 - Monitoring Status/Alarm Conditions page 5-48
 - Assessing Receiver Health page 5-70

Chapter Contents

- System Time page 5-73
 - Identifying Time of Next 1 PPS Reference Edge page 5-74
 - Reading Current Time page 5-75
 - Applying Local Time Zone Offset page 5-77
 - Defining the 1 PPS Reference Edge (59551A Only) page 5-78
 - Reading Leap Second Status page 5-79
- Programmable Pulse Output (59551A Only) page 5-83
- Event Time Stamping (59551A Only) page 5-89
 - Defining the Time-stamped Edge page 5-90
 - Clearing Time Stamp Memory page 5-91
 - Reading Time Stamps page 5-92
 - Processing Memory Overflows page 5-97
- Serial Interface Communication page 5-100
 - Configuring I/O Ports page 5-101
 - Recovering the Last Query Response page 5-108
- Receiver Initialization page 5-109
- Receiver Identification/Upgrade page 5-113
 - Reading Product Identification page 5-114
 - Installing Firmware via I/O Port 1 page 5-115

See Appendix B, “Command Syntax and Style,” for details regarding command Expanded Syntax, parameter types, and query response types.

Command Syntax Conventions

- POSition** Means you **MUST** use either all the uppercase letters or the entire word. The lowercase letters are optional. For example, POS and POSITION are both valid. However, POSI is not valid. (Note POSition is used here as an example, but this convention is true for all command keywords.) In other words, the short form of the keywords is shown in uppercase.
- <n>** The notation <n> ending a command keyword indicates a numeric suffix, used to differentiate multiple instances of the same structure. The numeric suffix is applied to both the short and long forms. The valid range for the value n is specified from an enumerated list, for example [1 | 2 | 3], or from a range, for example [1..3] to indicate any of the integers from 1 to 3.
- "TSTamp 1"** When you see quotation marks in the command's parameter, you must send the quotation marks with the command.

Description Format

Commands and Returns

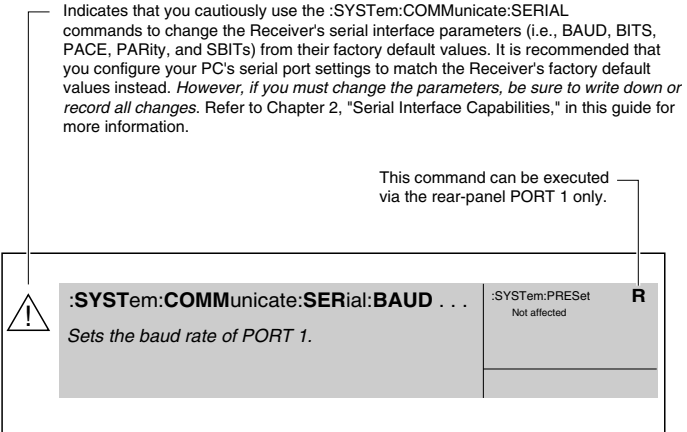
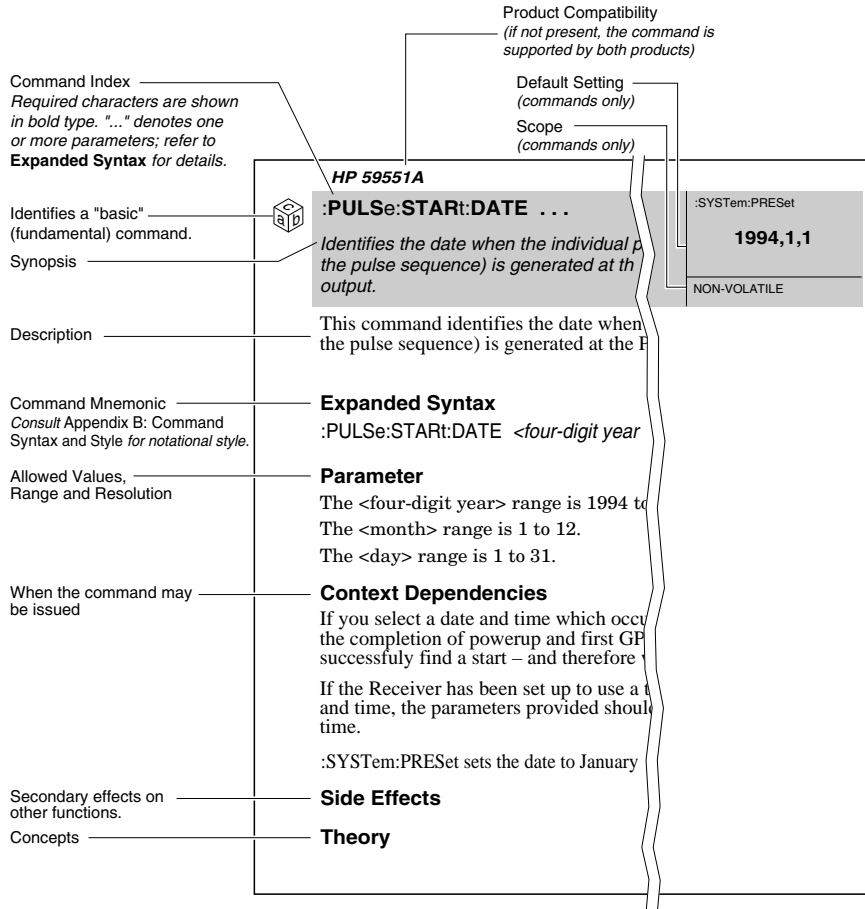

Description Format

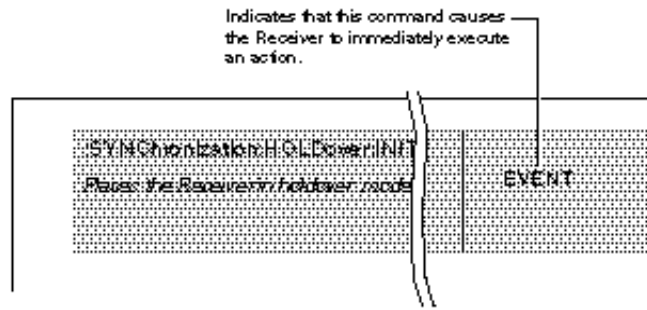

Query-Specific Information

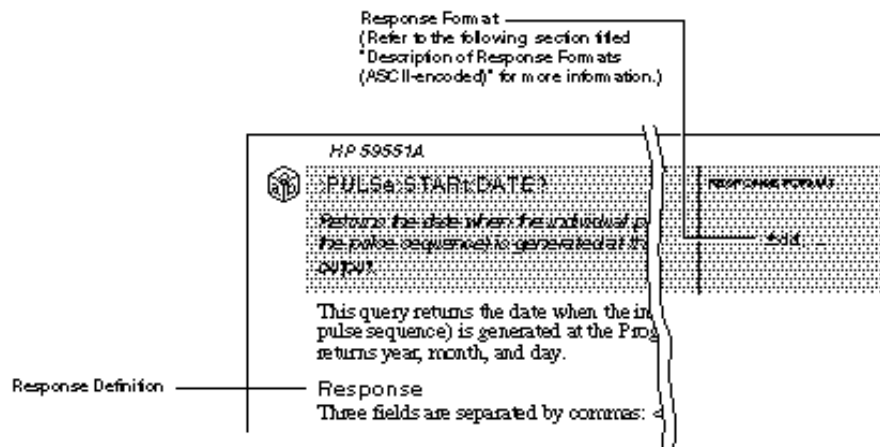

Description of Response Formats (ASCII-encoded)

The following legend provides the meaning of each type of response format. Refer to Table B-3 in Appendix B, "Command Syntax and Style," for details.

RESPONSE FORMAT	Example	Description
0 or 1	0	Single character, one or zero
± dd	+10	Integer
± d.d	+1.5	Fixed-point number
± d.dEe	+1.00000E-009	Floating-point number
XYZ	LOCK	Alphanumeric characters
" XYZ "	"19:49:51" or "No error"	Quoted string
± dd, ...	+14, +15, +18, +22, +29	Comma-separated list of integers
" XYZ", ...	"Log 001:19950101.00:00:00: Power on", "Log 002:19950101.00:10:00: Log cleared"	Comma-separated list of quoted strings



GPS Satellite Acquisition

The GPS Receiver is designed to acquire time transfer information (time, date, and position) from the GPS satellites, which is used by the Receiver's internal reference oscillator and SmartClock™ technology to lock to GPS. It acquires a precise *time* and *date* by tracking at least one satellite. By tracking at least four satellites, it precisely determines the *position* of the antenna. With this information, the Receiver can produce a precise 1 PPS signal that is exactly synchronous to Coordinated Universal Time (UTC) as determined by GPS.

The following commands are provided to facilitate initiate GPS satellite tracking, to establish accurate GPS antenna position, to select or ignore satellites, to compensate for antenna cable delay, and to monitor the acquisition.

■ Facilitating Initial Tracking

```
:GPS:INITial:DATE ...
:GPS:INITial:POSition ...
:GPS:INITial:TIME ...
```

■ Establishing Position

```
:GPS:POSition ...
:GPS:POSition?
:GPS:POSition:ACTual?
:GPS:POSition:HOLD:LAST?
:GPS:POSition:HOLD:STATe?
:GPS:POSition:SURVey:PROGress?
:GPS:POSition:SURVey:STATe ...
:GPS:POSition:SURVey:STATe?
:GPS:POSition:SURVey:STATe:POWerup ...
:GPS:POSition:SURVey:STATe:POWerup?
```

■ Selecting Satellites

```
:GPS:SATellite:TRACking:EMANgle ...
:GPS:SATellite:TRACking:EMANgle?
:GPS:SATellite:TRACking:IGNore ... (59551A)
:GPS:SATellite:TRACking:IGNore? (59551A)
:GPS:SATellite:TRACking:INCLude ... (59551A)
:GPS:SATellite:TRACking:INCLude? (59551A)
:GPS:SATellite:TRACking:<select>:ALL (59551A)
:GPS:SATellite:TRACking:<select>:COUNT?
:GPS:SATellite:TRACking:<select>:STATe? ...
```

GPS Satellite Acquisition

■ **Compensating for Antenna Delay**

:GPS:REFerence:ADELay ...

:GPS:REFerence:ADELay?

■ **Monitoring Acquisition**

:GPS:REFerence:VALid?

:GPS:SATEllite:TRACking?

:GPS:SATEllite:VISible:PREDicted?

:GPS:SATEllite:TRACking:COUNT?

:GPS:SATEllite:VISible:PREDicted:COUNT?



Facilitating Initial Tracking

:GPS:INITial:DATE . . .

Sets an approximate date for faster initial GPS acquisition.

:SYSTEM:PRESet

Not affected

VOLATILE

This command sets an approximate date for faster initial GPS acquisition. Following powerup, the Receiver obtains the current date from satellite data. This process occurs automatically. Providing an approximate date, however, reduces the time to initial GPS tracking by assisting the Receiver in finding satellites.

Expanded Syntax

:GPS:INITial:DATE <four-digit year>,<month>,<day>

Parameter

Range: the year, month, and day must be valid.

Context Dependencies

This command is valid prior to first satellite tracked (see bit 0 of the Operation Status Register). Sending this command after this time will generate **error -221**.

The initial date and time needs to be within 3 minutes of the actual date and time to be effective in enabling faster initial GPS acquisition.



Facilitating Initial Tracking _____ (continued)

:GPS:INITial:POSition . . . <i>Sets an approximate position for faster initial GPS acquisition.</i>	:SYSTem:PRESet :Not affected
	VOLATILE

This command sets an approximate position for faster initial GPS acquisition. Following powerup, the Receiver refines its position from the satellite data. This process occurs automatically. This command is most effective when the retained position differs significantly from the Receiver's true position.

Expanded Syntax

```
:GPS:INITial:POSition N or S, <latitude degree>,
                             <latitude minute>,
                             <latitude second>,
                             E or W, <longitude degree>,
                             <longitude minute>,
                             <longitude second>,
                             <height above the GPS ellipsoid, in meters (58303B)>
                             or
                             <height above mean sea level, in meters (59551A)>
```

Parameter

This command requires three position coordinates: latitude, longitude, and height. Position must be specified with respect to the World Geodetic System 1984 (WGS-1984) datum absolute earth coordinates.

The latitude coordinate is preceded by either N or S, which denotes the northern or southern hemisphere, respectively. The longitude coordinate is preceded by either E or W, which denotes the eastern or western hemisphere, respectively.

The following table lists the allowed settings of other parameters:

Parameter	Range	Precision	Parameter	Range	Precision
<latitude degrees>	0 to 90	1	<longitude degrees>	0 to 180	1
<latitude minutes>	0 to 59	1	<longitude minutes>	0 to 59	1
<latitude seconds>	0 to 59.999	0.001	<longitude seconds>	0 to 59.999	0.001
<height, m>	-1000.00 to 18,000.00	0.01			

Context Dependencies

This command is valid while the Receiver is in survey mode prior to first computed position. Sending this command while the Receiver is not in survey mode will generate **error -221**.

GPS Satellite Acquisition**Facilitating Initial Tracking** _____ *(continued)***:GPS:INITial:TIME . . .***Sets an approximate time for faster initial GPS acquisition.*

:SYSTem:PRESet

Not affected

VOLATILE

This command sets an approximate time for faster initial GPS acquisition. Following powerup, the Receiver obtains the current time from satellite data. This process occurs automatically. Providing an approximate time, however, reduces the time to initial GPS tracking by assisting the Receiver in finding satellites.

Expanded Syntax

:GPS:INITial:TIME <hour>,<minute>,<second>

Parameter

Range: all parameters (hour, minutes, seconds) must be valid.

Context Dependencies

This command is valid prior to first satellite tracked (see bit 0 of the Operation Status Register). Sending this command after this time will generate **error -221**.

The initial date and time needs to be within 3 minutes of the actual date and time to be effective in enabling faster initial GPS acquisition.

GPS Satellite Acquisition



Establishing Position



:GPS:POSition . . .

Defines the position of the Receiver.

:SYSTem:PRESet

latitude: N 0:00:00.000
 longitude: E 0:00:00.000
 height: 0 meters

NON-VOLATILE

This command defines the position of the Receiver. The Receiver uses this position to predict satellite visibility and to determine time. An accurate position is necessary for precise time transfer.

Expanded Syntax

```
:GPS:POSition      N or S, <latitude degree>,
                   <latitude minute>,
                   <latitude second>,
                   E or W, <longitude degree>,
                   <longitude minute>,
                   <longitude second>,
                   <height above the GPS ellipsoid, in meters (58303B)>
                   or
                   <height above mean sea level, in meters (59551A)>
```

:GPS:POSition LAST

:GPS:POSition SURVey

Parameter

The numeric form of this command requires three position coordinates: latitude, longitude, and height. Position must be specified with respect to the World Geodetic System 1984 (WGS-1984) datum absolute earth coordinates.

The latitude coordinate is preceded by either N or S, which denotes the northern or southern hemisphere, respectively. The longitude coordinate is preceded by either E or W, which denotes the eastern or western hemisphere, respectively.

The following table lists the allowed settings of other parameters:

Parameter	Range	Precision	Parameter	Range	Precision
<latitude degrees>	0 to 90	1	<longitude degrees>	0 to 180	1
<latitude minutes>	0 to 59	1	<longitude minutes>	0 to 59	1
<latitude seconds>	0 to 59.999	0.001	<longitude seconds>	0 to 59.999	0.001
<height, m>	-1000.00 to 18,000.00	0.01			

Continued on next page ➡

GPS Satellite Acquisition**Establishing Position** _____ *(continued)*

LAST denotes the last specified position. This parameter is provided to cancel surveying (automatic position computation) and restore the last position setting.

SURVey directs the Receiver to stop surveying and use the computed position. This position is the average of individual position computations.

Context Dependencies

Error -221 is generated if this command is sent as SURV and no valid survey calculation has ever been computed.

Side Effects

This command stops position surveying. The computed position is retained and applied only when SURVey is specified.

**:GPS:POsition?**

Returns the current average position of the GPS antenna.

RESPONSE FORMAT

XYZ or
± dd or
± d.dEe,
 ...

This query returns the current average position of the Receiver.

Response

Returns a list of values defining the Receiver position:

N or S, <latitude degree>, <latitude minute>, <latitude second>,
 E or W, <longitude degree>,<longitude minute>, <longitude second>,
 <height above the GPS ellipsoid, in meters (58303B)> or <height above mean
 sea level, in meters (59551A)>.

Context Dependencies

Error -230 is generated if in survey and first calculation has not occurred.

GPS Satellite Acquisition



Establishing Position (continued)



:GPS:POSition:ACTual?

Returns the current instantaneous position of the GPS antenna.

RESPONSE FORMAT

XYZ or
 \pm **dd** or
 \pm **d.dEe**,
 ...

This query returns the current instantaneous position of the GPS antenna.

Response

Returns a list of values defining the Receiver position:

N or S, <latitude degree>, <latitude minute>, <latitude second>,
 E or W, <longitude degree>,<longitude minute>, <longitude second>,
 <height above the GPS ellipsoid, in meters (58303B)> or <height above mean
 sea level, in meters (59551A)>.

Context Dependencies

Error -230 is generated if in survey and first calculation has not occurred.

:GPS:POSition:HOLD:LAST?

Returns the last position-hold setting.

RESPONSE FORMAT

XYZ or
 \pm **dd** or
 \pm **d.dEe**,
 ...

This query returns the last position-hold setting, which is restored when the :GPS:POSition LAST command is sent. Refer to the description of the :GPS:POSition command on page 5-13 for details.

Response

Returns a list of values defining the Receiver position:

N or S, <latitude degree>, <latitude minute>, <latitude second>,
 E or W, <longitude degree>,<longitude minute>, <longitude second>,
 <height above the GPS ellipsoid, in meters (58303B)> or <height above mean
 sea level, in meters (59551A)>.

Context Dependencies

This query is always valid, but if the Receiver has not been in position-hold mode since it was preset (see :SYSTem:PRESet), the value returned will be the preset position.

GPS Satellite Acquisition



Establishing Position _____ (continued)

:GPS:POsition:HOLD:STATe?

Identifies whether the Receiver is in position-hold or survey mode.

RESPONSE FORMAT

0 or 1

This query identifies whether the Receiver is in position-hold or survey mode. In survey mode, the Receiver continually refines its position. In position-hold mode, the position setting does not change.

Response

A value of 0 indicates not in position hold (in survey mode); a value of 1 indicates in position hold.

:GPS:POsition:SURVey:PROGress?

Returns percent completed while in survey mode.

RESPONSE FORMAT

± d.d

This query returns percent completed while in survey mode. Automatic transition to position-hold mode occurs following completion of survey mode (indicated by 100).

Response

The range is 0 to 100%. The units are percent.

Context Dependencies

This query is only valid while surveying for position (:GPS:POsition:SURV:STATe? returns ONCE or status bit 3 = 0 in the Operation Status Register). If queried while not surveying, **error -221** is generated.

:GPS:POsition:SURVey:STATe . . .

Initiates survey mode during which the Receiver determines its position from satellite data.

:SYSTem:PRESet

ONCE

This command initiates survey mode during which the Receiver determines its position from satellite data. The Receiver refines successive positional estimates to obtain a final position, transitions from survey to position-hold mode.

Expanded Syntax

:GPS:POsition:SURVey:STATe ONCE



Establishing Position (continued)

:GPS:POSition:SURVey:STATe? <i>Identifies whether the Receiver is in survey or position-hold mode.</i>	RESPONSE FORMAT XYZ or 0
--	--

This query identifies whether the Receiver is in survey or position-hold mode. In survey mode, the Receiver continually refines its position. In position-hold mode, the position does not change.

Response

A response of ONCE indicates that the Receiver is in survey mode. A response of 0 indicates the Receiver is in position-hold mode.

:GPS:POSition:SURVey:STATe:POWerup . . . <i>Selects position mode to be used at powerup.</i>	:SYSTem:PRESet ON
	NON-VOLATILE

This command specifies whether the Receiver always surveys at powerup or restores its last position at powerup.

Expanded Syntax

:GPS:POSition:SURVey:STATe:POWerup ON or OFF

Parameter

OFF sets the Receiver to powerup in the last valid position. ON sets the Receiver to survey on powerup.

:GPS:POSition:SURVey:STATe:POWerup? <i>Returns the position mode to be used at powerup.</i>	RESPONSE FORMAT 0 or 1
---	--------------------------------------

This query returns the position mode to be used at powerup.

Response

A value of 0 indicates the Receiver is set to powerup in the last valid position. A value of 1 indicates the Receiver is set to survey on powerup.

GPS Satellite Acquisition**Selecting Satellites**

:GPS:SATellite:TRACking:EMANgLe . . .

Sets the GPS elevation mask angle value (in degrees).

:SYSTem:PRESet

10

NON-VOLATILE

This command instructs the Receiver to allow tracking those satellites for which the elevation angle is greater than this elevation mask angle. Satellites below this elevation are visible, but will not be tracked.

Expanded Syntax

:GPS:SATellite:TRACking:EMANgLe <degrees>

Parameter

<degrees> range is 0 degrees (horizon) to 89 degrees. The resolution is 1 degree.

The maximum recommended value while the position is being surveyed is 15 degrees, to allow tracking of four satellites needed for an accurate position determination.

Once the survey is complete, the elevation mask angle can be increased to avoid interference problems caused by buildings and trees and minimize effects of multipath, if necessary.

Values above 40 degrees severely limit GPS signal availability, and are not recommended.



:GPS:SATellite:TRACking:EMANgLe?

Returns the GPS elevation mask angle value.

RESPONSE FORMAT

± dd

This query returns the GPS elevation mask angle value.

Response

The range is 0 degrees to 89 degrees.

GPS Satellite Acquisition



Selecting Satellites (continued)

59551A

:GPS:SATellite:TRACking:IGNore . . . <i>Adds the specified satellites to the list that the Receiver ignores for tracking.</i>	:SYSTem:PRESet No satellites ignored
	NON-VOLATILE

This command adds the specified satellites to the list that the Receiver ignores for tracking. Each satellite is identified by its pseudorandom noise code (PRN).

Expanded Syntax

```
:GPS:SATellite:TRACking:IGNore <PRN>, . . . , <PRN>
```

```
:GPS:SATellite:TRACking:IGNore:NONE
```

```
:GPS:SATellite:TRACking:IGNore:ALL
```

Parameter

<PRN> parameter is the pseudorandom noise code of the satellite(s) you want the Receiver to ignore. Each satellite has its own unique PRN.

Context Dependencies

This command is always valid. On send, if any item in the <PRN> list is invalid, the entire list will be rejected. **Error -222** will be generated.

59551A



:GPS:SATellite:TRACking:IGNore? <i>Returns list of satellites to ignore.</i>	RESPONSE FORMAT ± dd, ...
--	----------------------------------

This query returns a list of satellites to ignore for tracking. Each satellite is identified by its pseudorandom noise code (PRN). Zero (0) indicates no satellites being ignored.

Response

A value of 0 indicates no satellites being ignored. If any satellite is being ignored, the pseudorandom noise code (PRN) of the satellite is returned.

Context Dependencies

This query is always valid.



Selecting Satellites (continued)

59551A

:GPS:SATellite:TRACking:INCLude . . .

Adds the specified satellites to the list that the Receiver considers for tracking.

:SYSTem:PRESet

All satellites included

NON-VOLATILE

This command adds the specified satellites to the list that the Receiver considers for tracking. Actual satellite selection is based on satellite visibility, geometry, and health.

Expanded Syntax

:GPS:SATellite:TRACking:INCLude <PRN>, . . . , <PRN>

:GPS:SATellite:TRACking:INCLude:NONE

:GPS:SATellite:TRACking:INCLude:ALL

Parameter

<PRN> parameter is the pseudorandom noise code of the satellite(s) you want the Receiver to include. Each satellite has its own unique PRN.

Context Dependencies

This command is always valid. On send, if any item in the <PRN> list is invalid, the entire list will be rejected. **Error -222** will be generated.

59551A

:GPS:SATellite:TRACking:INCLude?

Returns a list of satellites to include.

RESPONSE FORMAT

± dd, ...

This query returns a list of satellites to include for tracking. Each satellite is identified by its pseudorandom noise code (PRN). Zero (0) indicates no satellites being included (i.e., the satellites are still on the ignored list).

Context Dependencies

This query is always valid.



Selecting Satellites (continued)

	RESPONSE FORMAT
:GPS:SATellite:TRACking:IGNore:COUNT? <i>Returns the number of satellites that are on the list to ignore for tracking.</i>	± dd
:GPS:SATellite:TRACking:INCLude:COUNT? <i>Returns the number of satellites that are on the list to include for tracking.</i>	± dd

The query :GPS:SATellite:TRACking:IGNore:COUNT? returns the number of satellites that are on the list to ignore for tracking.

The query :GPS:SATellite:TRACking:INCLude:COUNT? returns the number of satellites that are on the list to be included for tracking.

Response

There may be some delay between changes made to the list of satellites being ignored and their actual removal and inclusion in the tracking process.

At :SYSTEM:PRESet, all satellites are put on the list to include for tracking.



Selecting Satellites (continued)

:GPS:SATellite:TRACking:IGNore:STATe? . . . <i>Returns the ignored status of individual satellites.</i>	RESPONSE FORMAT 0 or 1
:GPS:SATellite:TRACking:INClude:STATe? . . . <i>Returns the include status of the specified satellite.</i>	0 or 1

The query `:GPS:SATellite:TRACking:IGNore:STATe?` returns the ignored status of the specified satellite. A satellite is specified by its pseudorandom noise code (PRN).

The query `:GPS:SATellite:TRACking:INClude:STATe?` returns the include status of the specified satellite. A satellite is specified by its pseudorandom noise code (PRN).

There may be some delay between changes made to the list of satellites being ignored and their actual removal and inclusion in the tracking process.

Expanded Syntax

`:GPS:SATellite:TRACking:IGNore:STATe? <PRN>`

`:GPS:SATellite:TRACking:INClude:STATe? <PRN>`

Parameter

`<PRN>` parameter is the pseudorandom noise code of the satellite(s) you want the Receiver to ignore or include. Each satellite has its own unique PRN.

Response

A value of 0 indicates not on the selected list.

A value of 1 indicates on the selected list.

Context Dependencies

After a `:SYSTem:PRESet`, all satellites are removed from the list to ignore.

GPS Satellite Acquisition**Compensating for Antenna Delay****:GPS:REFerence:ADELay . . .***Sets the GPS antenna delay value in seconds.*

:SYSTem:PRESet

0.0

NON-VOLATILE

This command sets the GPS antenna delay value in seconds. It instructs the Receiver to output its 1 PPS output pulse earlier in time to compensate for antenna cable delay.

CAUTION

Using this command while the Receiver is in normal locked operation could cause the Receiver go into holdover.

Expanded Syntax

:GPS:REFerence:ADELay <numeric_value>

Parameter

Numeric_value range is 0 to 0.000999999 seconds. The resolution is 1 nanosecond.

Zero cable delay is set for a zero-length antenna cable. Consult a cable data book for the delay per meter for the particular antenna cable used in order to compute the total cable delay needed for a particular installation.

See Also

:GPS:REFerence:ADELay?

The tables below list the delay values that you need to use with the :GPS:REFERENCE:ADELAY <seconds> command for the available cable assemblies.

Delay Values for the 58518A/519A and 58518AA/519AA RG-213 Antenna Cables

Cable Option	Length	RG 213 or Belden 8267 Antenna Delay Value
001	1m	5.0 nanoseconds
002	2 m	10.3 nanoseconds
005	5 m	25.2 nanoseconds
010	10 m	50.5 nanoseconds
015	15 m	75.7 nanoseconds
030	30 m	151.5 nanoseconds
050	50 m	252.5 nanoseconds

The nominal delay value is labeled on the cables. Refer to the *Designing Your GPS Antenna System Configuration Guide* for more information.

GPS Satellite Acquisition**Compensating for Antenna Delay** _____ *(continued)***Delay Values for the 58520A/521A and 58520AA/521A LMR 400 Antenna Cables**

Cable Option	Length	LMR 400 Antenna Delay Value
001	1m	3.9 nanoseconds
002	2 m	8.0 nanoseconds
005	5 m	19.6 nanoseconds
010	10 m	39.3 nanoseconds
015	15 m	59.0 nanoseconds
030	30 m	118.0 nanoseconds
060	60 m	236.1 nanoseconds
110	110 m	432.9 nanoseconds

The nominal delay value is labeled on the cables. Refer to the *Designing Your GPS Antenna System Configuration Guide* for more information.

**:GPS:REFerence:ADELay?**

Returns the GPS antenna delay value in seconds.

RESPONSE FORMAT

± d.dEe

This query returns the GPS antenna delay value in seconds. This is the delay value set by the system installer (or the factory default). It is not a value measured by the Receiver.

Response

The time units are seconds.

GPS Satellite Acquisition**Monitoring Acquisition****:GPS:REFerence:VALid?**

Identifies whether the 1 PPS signal is valid.

RESPONSE FORMAT

0 or 1

This query identifies that the 1 PPS signal has locked to a valid GPS reference and the 1 PPS signal itself is valid.

Response

A value of 1 indicates signal is valid.

A value of 0 indicates signal is not valid.

**:GPS:SATellite:TRACking?**

Returns a list of all satellites being tracked.

RESPONSE FORMAT

± dd, ...

This query returns a list of all satellites being tracked. Each satellite is identified by its pseudorandom noise code (PRN).

Response

A comma-separated list of satellite pseudorandom noise codes (<PRN>).

The range of each <PRN> is 1 to 32.

A response of 0 indicates no satellites being tracked.

GPS Satellite Acquisition**Monitoring Acquisition** _____ *(continued)***:GPS:SATellite:VISible:PREDicted?**

Returns the list of satellites (PRN) that the almanac predicts should be visible, given date, time, and location.

RESPONSE FORMAT

± dd, ...

This query returns the list of satellites (PRN) that the almanac predicts should be visible, given date, time, and location (if any of these values are incorrect, the prediction will be incorrect). Each satellite is identified by its pseudorandom noise code (PRN).

Response

A comma-separated list of satellite pseudorandom noise codes (<PRN>).

The range of each <PRN> is 1 to 32.

A response of 0 indicates no satellites predicted visible.

Theory

Satellites must be in view to be tracked. At least four satellites must be in view, and tracked, to determine the position in position survey operation. Only one satellite must be in view, and tracked, to maintain operation of the reference oscillator locked to GPS when in position hold operation.

:GPS:SATellite:TRACking:COUNT?

Returns the number of satellites being tracked.

RESPONSE FORMAT

± dd

This query returns the number of satellites being tracked.

Response

If there are no satellites being tracked, this query returns a 0.



Monitoring Acquisition _____ (continued)

:GPS:SATellite:VISible:PREDicted:COUNT?

Returns the number of satellites that the almanac predicts should be visible, given date, time, and location.

RESPONSE FORMAT

\pm dd

This query returns the number of satellites that the almanac predicts should be visible, given date, time, and location (if any of these are incorrect, the prediction will be incorrect).

Response

Number of satellites predicted visible.

Theory

Satellites must be in view to be tracked. At least four satellites must be in view, and tracked, to determine the position in position survey operation. Only one satellite must be in view, and tracked, to maintain operation of the reference oscillator locked to GPS when in position hold operation.



1 PPS Reference Synchronization

1 PPS and 10 MHz (58503B only) output signals are generated by the Receiver's internal reference oscillator. This oscillator is synchronized (phased locked) to GPS while a sufficient number of satellites are tracked. When the GPS signal is interrupted or absent, the Receiver maintains timing and frequency accuracy through its oscillator "holdover" process. While in holdover, the frequency of the reference oscillator is adjusted as necessary to compensate for aging characteristics. The Receiver returns to "locked" operation through a "holdover recovery" process.

The following commands are provided to monitor the operating mode of the reference oscillator, to determine the accuracy and stability of the reference output signal(s), and to control the oscillator holdover process.

■ Monitoring 1 PPS Synchronization

```
:SYNChronization:STATe?
:DIAGnostic:ROSCillator:EFControl:RELative?
:LED:GPSLock?
:LED:HOLDover?
```

■ Assessing 1 PPS Quality

```
:SYNChronization:FFOMerit?
:SYNChronization:HOLDover:TUNCertainty:PREdicted?
:SYNChronization:HOLDover:TUNCertainty:PREsent?
:SYNChronization:TFOMerit?
:SYNChronization:TINTerval?
:SYNChronization:HOLDover:DURation?
:SYNChronization:HOLDover:DURation:THReshold ...
:SYNChronization:HOLDover:DURation:THReshold?
:SYNChronization:HOLDover:DURation:THReshold:EXCeeded?
```

■ Operating in Holdover

□ Initiating Manual Holdover

```
:SYNChronization:HOLDover:INITiate
```

□ Recovering from Holdover

```
:SYNChronization:HOLDover:WAITing?
:SYNChronization:HOLDover:RECOvery:INITiate
:SYNChronization:HOLDover:RECOvery:LIMIT:IGNore
:SYNChronization:IMMEDIATE
```

1 PPS Reference Synchronization**Monitoring 1 PPS Synchronization****:SYNChronization:STATe?***Returns the Receiver state.*

RESPONSE FORMAT

XYZ

This query returns the Receiver state.

Response

OFF, or HOLD, or WAIT, or REC, or LOCK, or POW.

OFF indicates in diagnostic mode or a temporary start-up mode; HOLD indicates in manual holdover; WAIT indicates waiting for external conditions to allow recovery from holdover; REC indicates actively recovering from holdover; LOCK indicates locked to GPS; POW indicates in powerup prior to first lock.

Context Dependencies

:SYSTem:PRESet sets the state to POWerup.

:DIAGnostic:ROSCillator:EFControl:RELative?*Returns the Electronic Frequency Control (EFC) output value of the internal reference oscillator.*

RESPONSE FORMAT

± d.dEe

This query returns the Electronic Frequency Control (EFC) output value of the internal reference oscillator. It returns a percentage value.

Response

Range is -100% to +100%.

1 PPS Reference Synchronization**Monitoring 1 PPS Synchronization** _____ *(continued)***:LED:GPSLock?**

Returns the state of the front-panel GPS Lock LED.

RESPONSE FORMAT

0 or 1

This query returns the state of the front-panel GPS Lock LED. The Receiver sets this indicator during normal operation when it has locked the internal reference oscillator and 1 PPS output to GPS.

Response

A value of 0 indicates the LED is off.

A value of 1 indicates the LED is on.

:LED:HOLDover?

Returns the state of the front-panel Holdover LED.

RESPONSE FORMAT

0 or 1

This query returns the state of the front-panel Holdover LED. The Receiver sets this indicator when in holdover operation.

Response

A value of 0 indicates the LED is off.

A value of 1 indicates the LED is on.

1 PPS Reference Synchronization**Assessing 1 PPS Quality****:SYNChronization:FFOMerit?***Returns the Frequency Figure of Merit.*

RESPONSE FORMAT

 \pm dd

This query returns the Frequency Figure of Merit (FFOM). Use this query when you want to know the *stability* of the Receiver's 10 MHz output. The 10 MHz output is controlled by the SmartClock's Phase-Locked Loop (PLL). Thus, the FFOM value is determined by monitoring the status of the PLL.

Response

The following table lists and defines the FFOM values (0 thru 3) that could be returned.

FFOM Value	Definition
0	PLL stabilized—10 MHz output within specification.
1	PLL stabilizing
2	PLL unlocked (holdover)—Initially the 10 MHz output will be within specifications. However, when in holdover, the 10 MHz output will eventually drift out of specification.
3	PLL unlocked (not in holdover)—Do not use the output.

1 PPS Reference Synchronization**Assessing 1 PPS Quality** _____ *(continued)***:SYNChronization:HOLDover:TUNCertainty:PREDicted?**

Returns an estimate of the time interval error that can be expected for a one day holdover, given the current state of SmartClock learning in the Receiver.

RESPONSE FORMAT

\pm d.dEe, 0 or 1

This query returns an estimate of the time interval error that can be expected for a one day holdover, given the current state of SmartClock learning in the Receiver.

Response

The first number in the response is the estimated time interval error. The units are seconds, the resolution is 100 nanoseconds.

The second number in the response identifies the holdover state. A value of 0 indicates the Receiver is not in holdover; a value of 1 indicates the Receiver is in holdover.

Context Dependencies

This query is not valid prior to first lock following powerup (see bit 2 of the Powerup Status Register) or :SYSTem:PRESet. Sending this query before first lock will generate **error -230**.

**:SYNChronization:HOLDover:TUNCertainty:PRESent?**

Returns the current time interval error during holdover operation, given the current state of SmartClock learning in the Receiver.

RESPONSE FORMAT

\pm d.dEe

This query returns the current time error during holdover operation, given the current state of SmartClock learning in the Receiver.

Response

The time error units are seconds.

Context Dependencies

This query is valid when the Receiver is in holdover. If not in holdover, **error -230** is generated.

1 PPS Reference Synchronization



Assessing 1 PPS Quality _____ (continued)



:SYNChronization:TFOMerit?

Returns the Time Figure of Merit.

RESPONSE FORMAT

± dd

This query returns the Time Figure of Merit. Use this query when you want to know the *accuracy* of the Receiver's 1 PPS output. A low TFOM value indicates a more accurate output. A value of 3 indicates that the Time Error ranges from 100 to 1000 nanoseconds.

Response

The following table lists the TFOM values that could be returned and provides the corresponding Time Error.

TFOM Value	Time Error (in nanoseconds)	TFOM Value	Time Error (in nanoseconds)
0*	less than 1	5	10 ⁴ –10 ⁵
1*	1–10	6	10 ⁵ –10 ⁶
2*	10–100	7	10 ⁶ –10 ⁷
3	100–1000	8	10 ⁷ –10 ⁸
4	10 ³ –10 ⁴	9	greater than 10 ⁸

* The TFOM values 0, 1, and 2 are not presently used in the 58503B and 59551A products. The 58503B and 59551A products will display TFOM values ranging from 9 to 3, which is consistent with the specified accuracies of each product



:SYNChronization:TINterval?

Returns the difference or timing shift between the SmartClock 1 PPS and the GPS 1 PPS signals.

RESPONSE FORMAT

± d.dEe

This query returns the difference or timing shift between the SmartClock 1 PPS and the GPS 1 PPS signals. It generates an error when this interval is unavailable (That is, if no GPS 1 PPS).

Response

Time interval units are seconds.

Resolution is 1E-10 seconds.

1 PPS Reference Synchronization**Assessing 1 PPS Quality** _____ *(continued)***:SYNChronization:HOLDover:DURation?**

Returns the duration of the present or most recent period of operation in the holdover and holdover processes.

RESPONSE FORMAT

± d.dEe, 0 or 1

This query returns the duration of the present or most recent period of operation in the holdover and holdover processes. This is the length of time the reference oscillator was not locked to GPS. The time units are seconds.

Response

The first number in the response is the holdover duration. The duration units are seconds, and the resolution is 1 second.

If the Receiver is in holdover, the response quantifies the current holdover duration. If the Receiver is not in holdover, the response quantifies the previous holdover.

The second number in the response identifies the holdover state. A value of 0 indicates the Receiver is not in holdover; a value of 1 indicates the Receiver is in holdover.

Context Dependencies

This query is always valid. If this query is sent before the first holdover has occurred, the response will be 0,0, indicating that the Receiver is currently not in holdover and last holdover duration was 0 seconds (user infers there has not been one yet).

Set to 0,0 after a :SYSTem:PRESet. If there was a prior holdover, the duration will be lost.

1 PPS Reference Synchronization**Assessing 1 PPS Quality** _____ *(continued)*

:SYNChronization:HOLDover:DURation:THReshold . . . <i>Sets the duration (in seconds) to be used as a limit each time holdover begins.</i>	:SYSTem:PRESet 86400 (i.e., 1 day)
	NON-VOLATILE

This command sets the duration (in seconds) which represents a limit against which the elapsed time of holdover is compared. If the elapsed time in holdover (and associated processes) exceeds the limit, a flag is set. The flag indicating the limit is exceeded can be queried using the :SYNChronization:HOLDover:DURation:THReshold:EXCeeded? query.

Expanded Syntax

:SYNChronization:HOLDover:DURation:THReshold <seconds>

Parameter

Resolution of the <seconds> parameter is 1 second.

:SYNChronization:HOLDover:DURation:THReshold? <i>Returns the duration (in seconds) which represents a limit against which the elapsed time of holdover is compared.</i>	RESPONSE FORMAT ± dd
---	--------------------------------

This query returns the duration (in seconds) which represents a limit against which the elapsed time of holdover is compared. If the elapsed time of holdover (and associated processes) exceeds the limit, a flag is set.

Expanded Syntax

:SYNChronization:HOLDover:DURation:THReshold?

Response

The threshold units are seconds.

The resolution is 1 second

1 PPS Reference Synchronization**Assessing 1 PPS Quality** _____ *(continued)*

**:SYNChronization:HOLDover:DURation:THReshold
:EXCeeded?**

Identifies if the Receiver has been in holdover longer than the amount of time specified by the THReshold command.

RESPONSE FORMAT

0 or 1

This query identifies if the Receiver has been in holdover longer than the amount of time specified by the THReshold command. If it has, 1 will be returned.

Response

A value of 1 indicates that the Receiver is in holdover, and has been operating in holdover for a duration that exceeds the specified duration.

The value 0 indicates either the Receiver is not in holdover, or it has been in holdover for less than the specified duration.

1 PPS Reference Synchronization**Operating in Holdover** _____**□ Initiating Manual Holdover** _____

:SYNChronization:HOLDover:INITiate <i>Places the Receiver in holdover mode.</i>	EVENT
---	--------------

This command places the Receiver in holdover mode. The Receiver will stay in holdover until you send :SYNC:HOLD:REC:INIT.

Context Dependencies

This command is not valid prior to the first lock following powerup (see bit 2 of the Powerup Status Register) or :SYSTEM:PRESet. Sending this command before the first lock will generate **error -221**.

See Also

:SYNChronization:HOLDover:RECOvery:INITiate

1 PPS Reference Synchronization



Operating in Holdover _____ (continued)

□ Recovering from Holdover _____

:SYNChronization:HOLDover:WAITing?

Returns prioritized reason for why the Receiver is waiting to recover.

RESPONSE FORMAT

XYZ

This query returns prioritized reason for why the Receiver is waiting to recover.

Response

HARD indicates there is an internal hardware reason, GPS indicates there are no satellites, LIM indicates the time interval between GPS and internal oscillator is exceeding the limit, and NONE indicates the Receiver isn't waiting to recover.

Note that if holdover has been initiated by sending the :SYNC:HOLD:INIT command, the Receiver is not waiting to recover; the response is NONE.

This query is always valid. If not in holdover and waiting to recover, NONE will be the response.

:SYNChronization:HOLDover:RECovery:INITiate

Initiates a recovery from manually initiated holdover.

EVENT

This command initiates a recovery from manually initiated holdover. Use this command to take the Receiver out of a *manually selected holdover*. This command is not needed to initiate holdover recovery in any other situation.

See Also

:SYNChronization:HOLDover:INITiate

1 PPS Reference Synchronization**Operating in Holdover** _____ *(continued)*□ **Recovering from Holdover** *(continued)*

:SYNChronization:HOLDover:RECOvery:LIMit:IGNore	EVENT
--	--------------

<i>Initiates recovery from holdover if recovery was inhibited by time intervals exceeding limit.</i>	
--	--

This command initiates recovery from holdover if recovery was inhibited by time intervals exceeding limit.

The time interval used for this comparison is the time interval between the internal oscillator's 1 PPS edge and the GPS system's 1 PPS edge. When this time interval consistently exceeds the specified limit, the instrument enters the holdover state, "Waiting to Recover."

Recovery is initiated when the time intervals consistently fall within limits, or when the limit is ignored by issuing this command.

:SYNChronization:IMMEDIATE	EVENT
-----------------------------------	--------------

<i>Initiates a near-instantaneous alignment of the GPS 1 PPS and Receiver output 1 PPS if the command is issued during recovery from holdover.</i>	
--	--

This command initiates a near-instantaneous alignment of the GPS 1 PPS and Receiver output 1 PPS if the command is issued during recovery from holdover.

Context Dependencies

This command is only valid when recovering from holdover. See bit 2 of the Holdover Status Register (if it is 1, this command is okay). Sending this command when the Receiver is not recovering will generate **error -221**.



Operating Status

This section describes the commands that can be used to obtain Receiver status information. There are several ways to obtain Receiver status using commands. For example, you can send a command to display the Receiver Status screen, to read the error queue, and to read the diagnostic log. You can also send a sequence of commands to read and control the status registers for alarm generation.

This section defines all of the commands used for status reporting. A comprehensive discussion on how you can monitor and control alarm conditions using the status registers is included.

■ Receiver Operation at a Glance

```
:SYSTem:STATus?  
:SYSTem:STATus:LENGth?
```

■ Reading the Error Queue

```
:SYSTem:ERRor?
```

■ Reading the Diagnostic Log

```
:DIAGnostic:LOG:CLEar  
:DIAGnostic:LOG:READ:ALL?  
:DIAGnostic:LOG:CLEar ...  
:DIAGnostic:LOG:COUNt?  
:DIAGnostic:LOG:READ?  
:DIAGnostic:LOG:READ? ...
```

■ Monitoring Status/Alarm Conditions

□ Clearing and Presetting Alarms

```
*CLS  
:STATus:PRESet:ALARm
```

□ Reading and Qualifying Alarms

```
:LED:ALARm?  
*SRE ...  
*SRE?  
*STB?
```

Operating Status



Receiver Operation at a Glance

**:SYSTem:STATus?**

Outputs a formatted status screen.

RESPONSE FORMAT

ASCII Data

This query outputs a formatted Receiver Status screen. Use this screen to monitor GPS acquisition, derivation of time and position, and synchronization of reference outputs to GPS.

Refer to Chapter 3, “Visual User Interface,” for detailed information on the Receiver Status screen.

Response

Sending this command will display a status screen similar to the following figure (58503B screen is shown in this figure).

```

----- Receiver Status -----
SYNCHRONIZATION ..... [ Outputs Valid ]
SmartClock Mode _____ Reference Outputs _____
>> Locked to GPS          TFOM      3          FFOM      0
Recovery                 1PPS TI +7.2 ns relative to GPS
Holdover                 HOLD THR 1.000 us
Power-up                 Holdover Uncertainty _____
                          Predict  49.0 us/initial 24 hrs

ACQUISITION ..... [GPS 1PPS Valid]
Tracking: 6 _____ Not Tracking: 1 _____
PRN  E1  Az  C/N  PRN  E1  Az          Time _____ +1 leap second pending
  2  49 243  49   14 11  82          UTC      23:59:59   31 Dec 1995
 16  24 282  44                               GPS 1PPS Synchronized to UTC
 18  38 154  49                               ANT DLY  120 ns
 19  65  52  43                               Position _____
 27  62 327  44                               MODE      Survey: 17.5% complete
 31  34  61  38                               AVG LAT  N  37:19:32.264
                                              AVG LON  W 121:59:52.112
                                              AVG HGT  +41.86 m (GPS)

ELEV MASK 10 deg
HEALTH MONITOR ..... [ OK ]
Self Test: OK Int Pwr: OK Oven Pwr: OK OCXO: OK EFC: OK GPS Rcv: OK

```

:SYSTem:STATus:LENGth?

Returns the number of lines of formatted text that are in the Receiver Status screen.

RESPONSE FORMAT

± dd

This query returns the number of lines of formatted text that are in the Receiver Status screen.

Operating Status



Reading the Error Queue



:SYSTem:ERRor?

Returns the oldest error in the Error Queue and removes that error from the queue (first in, first out).

RESPONSE FORMAT

± dd, "XYZ"

This query returns the oldest error in the Error Queue and removes that error from the queue (first in, first out).

See Appendix A, "Error Messages," in this guide for detailed error information.

Response

The error response format is: <error_number>, "<error_description>", where

- The <error_number> is an integer transferred as ASCII bytes in <NR1>format (integer). The range is -32768 to 32767.
- Negative error numbers are defined by the SCPI standard.
- Positive error numbers are defined specifically for this Receiver.
- An error number value of zero indicates that the Error Queue is empty.
- The maximum length of the <error_description> is 255 characters.

Context Dependencies

:SYSTem:PRESet clears the Error Queue.

The queue is cleared (emptied) on *CLS, power-on, or upon reading the last error from the queue.

If the Error Queue overflows, the last error in the queue is replaced with the **error -350, "Queue overflow"**. Any time the queue overflows, the least recent errors remain in the queue and the most recent error is discarded. The maximum length of the Error Queue is 30.

Operating Status**Reading the Diagnostic Log**

The Diagnostic Log is one way to obtain Receiver status.

The following activities and events are recorded in the diagnostic log:

- power-on sequence,
- automatic or manual transitions between locked, and holdover,
- automatic or manual transitions between position survey and position hold operation,
- alarm indications, and
- self-test failures.

Each entry is date-and-time tagged. The log entries are stored in non-volatile memory so all data remains valid even if power is lost. Access to the diagnostic log entries is through commands in the :DIAGnostic:LOG subtree.

For example, to read the first diagnostic log entry, use the command

```
:DIAG:LOG:READ? 1
```

The possible log messages that can be displayed on your computer display are listed in the following table.

Table 5-1. Diagnostic Log Messages

Log Message	Comments
Log cleared	Always becomes first log message when the log is cleared. See :DIAG:LOG:CLEAR.
Power on	Indicates Receiver has been powered on.
Re-boot	Indicates Receiver processor has re-booted.
Survey mode started	Indicates beginning of survey for position.
Position hold mode started	Indicates transition from survey to position hold.
GPS lock started	Indicates transition into locked operation.
GPS reference valid at yyyymmdd.hh:mm:ss	Indicates when GPS reference first become valid. Time in log is the present time from GPS.
Holdover started, manual	Indicates transition to holdover based on user request. See :SYNC:HOLD:INIT.
Holdover started, TI error	Indicates transition to holdover due to problem detected with Receiver ability to properly measure interval between GPS 1 PPS and internal oscillator 1 PPS.
Holdover started, TI limit exceeded	Indicates transition to holdover due to the interval from GPS 1 PPS to internal oscillator 1 PPS exceeding a limit threshold for numerous measurements.
Holdover started, not tracking GPS	Indicates transition to holdover since GPS is not tracking sufficient satellites.



Reading the Diagnostic Log _____ (continued)

Table 5-1. Diagnostic Log Messages (Continued)

Log Message	Comments
Holdover started, GPS RAIM alarm	Indicates transition to holdover since time RAIM algorithm has detected GPS 1PPS timing inaccuracy.
Holdover started, GPS Alarm	Indicates transition to holdover due to GPS engine communication failure.
Holdover started, invalid GPS 1 PPS	Indicates transition to holdover due to problem with the GPS 1 PPS signal.
Holdover started, GPS	Indicates transition to holdover due to some other GPS problem.
Holdover started, HW error	Indicates transition to holdover due to internal hardware error.
Holdover started, temporary	Indicates temporary transition to holdover due to changing of certain settings.
Holdover started	Indicates transition to holdover for any reason not covered above.
Self-test failed	Indicates self-test failed on powerup.
System preset	Indicates that the Receiver has been preset to factory settings.
Hardware failure	Indicates that a hardware failure has been detected. See Hardware Status Register for details.
EEPROM save failed	Indicates that an attempt to save information to the EEPROM has failed.

The DIAGnostic commands for the log are described in the following text.

Operating Status



Reading the Diagnostic Log _____

(continued)**:DIAGnostic:LOG:CLEAr***Clears the diagnostic log.*

:SYSTem:PRESet

Log is cleared

NON-VOLATILE

This command is an event that removes all previous diagnostic log entries, and effectively sets the number of diagnostic log entries to one.

**:DIAGnostic:LOG:READ:ALL?***Returns all of the most recent diagnostic log entries.*

RESPONSE FORMAT

"XYZ", ...

This query returns all of the most recent diagnostic log entries.

:DIAGnostic:LOG:CLEAr . . .*Clears only the current diagnostic log.*

:SYSTem:PRESet

Log is cleared

NON-VOLATILE

This command clears the diagnostic log. The optional log count parameter is provided to ensure that no log entries are unread at the time of the clear.

Expanded Syntax

:DIAGnostic:LOG:CLEAr <current log size>

Parameter

If the value sent for the optional log parameter does not match the current log entry count (use :DIAG:LOG:COUN? to obtain this number), the clear will not take place.

Context Dependencies

This command is always valid. If the optional log count parameter is sent, and the current and actual log count does not match log count value, the clear will not be performed and **error -222** will be generated.

Operating Status



Reading the Diagnostic Log _____

(continued)

:DIAGnostic:LOG:COUNt? <i>Identifies the number of entries in the diagnostic log.</i>	RESPONSE FORMAT \pm dd
---	------------------------------------

This query identifies the number of entries in the diagnostic log.

Response

Range is 1 to 222, maximum is subject to change.

:DIAGnostic:LOG:READ? <i>Returns the most recent diagnostic log entry.</i>	RESPONSE FORMAT "XYZ"
--	---------------------------------

This query returns the most recent diagnostic log entry.

Response

The diagnostic log entry format is: "Log NNN: YYYYMMDD.HH:MM:SS: <log_message>", where:

Log indicates a diagnostic log entry, and NNN is the log entry number

YYYYMMDD.HH:MM:SS is the date and time of the diagnostic log entry.

The <log_message> is a sequence of up to 255 characters.

Operating Status**Reading the Diagnostic Log** _____*(continued)***:DIAGnostic:LOG:READ? . . .**

Returns the user-specified diagnostic log entry. Returns the most recent diagnostic log entry if no parameter is supplied.

RESPONSE FORMAT

“XYZ”

This query returns the user-specified diagnostic log entry.

Expanded Syntax

:DIAGnostic:LOG:READ? <entry number>

Parameter

Range is 1 to current log count.

Response

The diagnostic log entry format is: “Log NNN: YYYYMMDD.HH:MM:SS: <log_message>”, where:

Log indicates a diagnostic log entry, and NNN is the log entry number

YYYYMMDD.HH:MM:SS is the date and time of the diagnostic log entry.

The <log_message> is a sequence of up to 255 characters.

Context Dependencies

This query is always valid. If no log message is associated with the requested log number, **error -222** is generated.



Monitoring Status/Alarm Conditions _____

The Receiver is at all times monitoring various operating conditions through a status/alarm reporting system. The Receiver is shipped from the factory with the status system set to generate an alarm under a default set of operating conditions.

The monitored operating conditions are organized by function into three major groups: Questionable status, Command Error status, and Operation status. The Operation status group has three functional subgroups: Powerup status, Holdover status, and Hardware status.

All of the operating conditions are summarized by the Alarm status.

Figure 5-1, on the next page, includes the identification of the default alarm conditions. Those conditions which are enabled to “feed” all the way through the system will generate an alarm in a Receiver configured with the factory defaults. (Note a diagram identical to Figure 5-1 is provided as part of the Receiver Commands at a Glance/Status Reporting System at a Glance foldout—pages 4-17 and 4-18, respectively.)

Operating Status



Monitoring Status/Alarm Conditions _____ (continued)

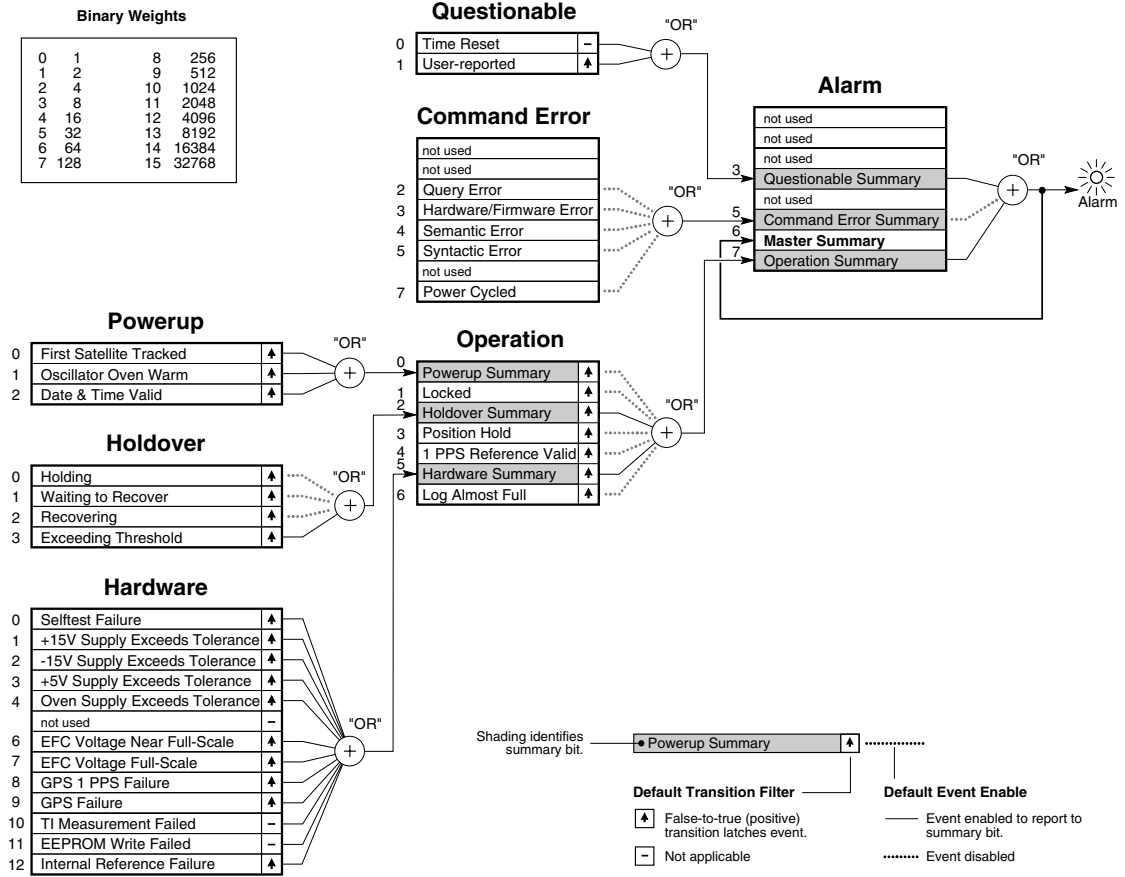

Figure 5-1. 59551A/58503B Status Reporting System Diagram

Operating Status**Monitoring Status/Alarm Conditions** _____ *(continued)*

The following describes, for each functional group of operating status shown in Figure 5-1, each of the operating conditions that is monitored through the status/alarm system.

Each monitored condition bit is “set” (to one) when the named condition is true and “cleared” (to zero) when the named condition is false.

Each monitored event bit is set when the named event has occurred and cleared at powerup and when the user executes a command which reads or clears the event register.

All of the conditions and events are cleared at powerup and :SYSTEM:PRESet.

Alarm Status

The Alarm Status summarizes condition changes from the three major functional status groups (Questionable, Command Error, and Operation).

- The Questionable Summary condition (bit 3) reflects one or more latched condition changes in the Questionable status group.
- The Command Error Summary condition (bit 5) reflects one or more latched condition changes in the Command Error status group.
- The Master Summary condition (bit 6) indicates that there was at least one reason for generating an Alarm.
- The Operation Summary condition (bit 7) reflects one or more latched condition changes in the Operation status group.

Operation Status

The Operation Status is comprised of the Operation subgroup (Powerup, Holdover, and Hardware) summaries, Locked, Position Hold, 1 PPS Reference Valid, and Log Almost Full status.

- The Powerup Summary condition (bit 0) reflects one or more latched condition changes in the Powerup status group.
- The Locked condition (bit 1) indicates whether or not the Receiver is locked to GPS.
- The Holdover Summary condition (bit 2) reflects one or more latched condition changes in the Holdover status group.
- The Position Hold condition (bit 3) indicates whether the Receiver is in position hold or survey mode.
- The 1 PPS Reference Valid condition (bit 4) indicates that the GPS 1 PPS signal is suitable to use as a locking reference.
- The Hardware Summary condition (bit 5) reflects one or more latched condition changes in the Hardware status group.
- The Log Almost Full condition (bit 6) indicates whether or not the diagnostic log is approaching the point where new entries will no longer be logged.

Operating Status**Monitoring Status/Alarm Conditions** _____ *(continued)***Hardware Status**

This Operation subgroup comprises operating status that indicates the health of the Receiver hardware.

One or more of the condition changes from this group are summarized in the Operation Status group.

- The Selftest Failure condition (bit 0) indicates whether a failure was detected during the powerup or last user-initiated self-test.
- The following conditions reflect the status of specific hardware that is continuously monitored by the Receiver:

+15V Supply Exceeds Tolerance condition	(bit 1)
-15V Supply Exceeds Tolerance condition	(bit 2)
+5V Supply Exceeds Tolerance condition	(bit 3)
Oven Supply Exceeds Tolerance condition	(bit 4)
EFC Voltage Near Full-Scale condition	(bit 6)
EFC Voltage Full-Scale condition	(bit 7)
GPS 1 PPS Failure condition	(bit 8)
GPS Failure condition	(bit 9)
Time Interval Measurement Failed event	(bit 10)
Internal Reference Failure condition	(bit 12)

- The EEPROM Write Failed event (bit 11) indicates that an attempt to write to the non-volatile memory failed.

Operating Status**Monitoring Status/Alarm Conditions** _____ *(continued)***Holdover Status**

This Operation subgroup is comprised of operating status that occurs during holdover.

One or more of the condition changes from this group are summarized in the Operation Status group.

- The following conditions indicate that the Receiver is in holdover, and the specific holdover state:

Holding condition (bit 0)

Waiting to Recover condition (bit 1)

Recovering condition (bit 2)

- The Exceeding User-Threshold condition (bit 3) indicates whether or not the user-specified holdover duration (:SYNC:HOLDover:DURation:THReshold) is being exceeded.

Powerup Status

This Operation subgroup is comprised of operating status that occurs at powerup.

One or more of the condition changes from this group are summarized in the Operation Status group.

- The First Satellite Tracked condition (bit 0) is cleared at powerup and set when the first satellite becomes tracked following powerup.
- The Oscillator Oven Warm condition (bit 1) is cleared at powerup and set when the internal oscillator has warmed up following powerup.
- The Date & Time Valid event (bit 2) is cleared at powerup and set when the date and time are set during the first lock is attained after powerup.

Questionable Status

The Time Reset status event (bit 0) indicates that the Receiver reset its time because the Receiver's time was found to be different from the time being reported by the satellites. This could occur after an extensive holdover period.

The User-reported condition (bit 1) indicates the setting reported by the user with the :STATus:QUEStionable:CONDition:USER or :STATus:QUEStionable:EVENT:USER command. This is the only condition in the status/alarm reporting that the user can directly affect.

Operating Status



Monitoring Status/Alarm Conditions _____ *(continued)*

Command Error Status

This group contains events which indicate a command error has occurred, and an event which indicates that the power has cycled. (See Figure 5-1.)

The following status events indicate that a command error occurred:

- The Query Error status event (bit 2). **Errors -400** through **-499** are query errors.
- The Hardware/Firmware Error status event (bit 3). **Errors -300** through **-399** are hardware/firmware errors.
- The Semantic Error status event (bit 4). **Errors -200** through **-299** are semantic errors.
- The Syntactic Error status event (bit 5). **Errors -100** through **-199** are syntactic errors.
- The Power Cycled status event (bit 7) is set at powerup.

Operating Status**Monitoring Status/Alarm Conditions** _____ *(continued)*□ **Clearing and Presetting Alarms** _____***CLS**

Clears the current alarm and prepares the Receiver for the next alarm activation.

EVENT

When the *CLS command clears the event status registers and error queue, the Receiver's Alarm LED and Alarm BITE output will no longer indicate that there was a reason to alarm. Furthermore, the Receiver is then ready to detect a new alarm.

Context Dependencies

In the 59551A, the error queue (and corresponding serial port prompt) of the I/O port which transmitted *CLS will be cleared.

Side Effects

The Alarm LED is extinguished.

The Alarm BITE output is set "inactive/off."

The prompt of the serial I/O port (which transmits *CLS) reflects error queue clearing.

The event status registers are cleared.

The error queue (and corresponding serial port prompt) of the I/O port which transmitted *CLS will be cleared.

Theory

The *CLS command clears the event status registers and error queue. (They are also cleared at power-up.)

Since the Alarm Condition register summarizes the event registers, it is cleared as a result of the clearing of all of the event registers.

The alarm remains active even after the condition that caused it has gone away.

If the condition that caused the alarm to occur is still set, a new alarm cannot be detected until the condition clears and resets.

This command has no effect on condition, enable, or transition filter registers.

Operating Status**Monitoring Status/Alarm Conditions** _____ *(continued)*□ **Clearing and Presetting Alarms** *(continued)***:STATus:PRESet:ALARm**

Presets the status/alarm reporting system to generate an alarm when a factory default set of operating conditions occurs.

EVENT

When the configurable portion of the status/alarm reporting system is preset, the Receiver is configured to generate an alarm under the factory default set of operating conditions.

Use this command to restore only the status/alarm reporting system to the factory (:SYSTem:PRESet) settings.

Theory

The configurable portion of the status/alarm reporting system consists of enable and transition filter registers. Figure 5-1 identifies the factory default enables and transitions.

The status/alarm reporting configuration is stored in non-volatile memory.

This command performs a subset of the :SYSTem:PRESet command in that it only presets the configuration associated with status/alarm reporting system.

This command does not affect condition or event registers.

Operating Status



Monitoring Status/Alarm Conditions _____ (continued)

□ Reading and Qualifying Alarms _____

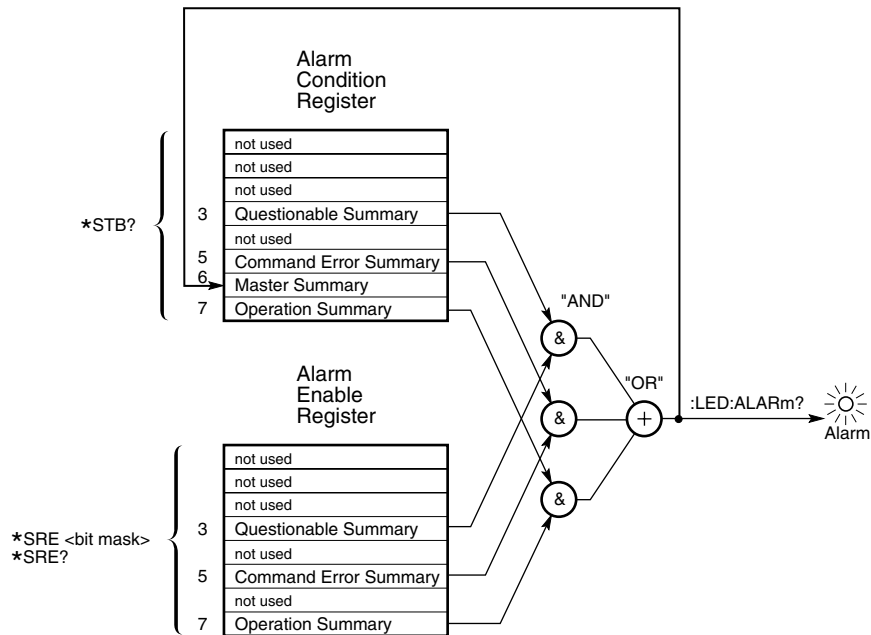

Figure 5-2. Alarm Condition and Enable Registers

**:LED:ALARM?**

Returns the status of the front-panel Alarm LED.

RESPONSE FORMAT

0 or 1

This query returns the status of the front-panel Alarm LED, which indicates that a change in operating conditions was recorded. The alarm remains active even after the condition that caused it has gone away.

Theory

This query essentially reads the Master Summary bit (bit 6) of the Alarm Condition Register.

At power-up, the alarm status is cleared.

Operating Status**Monitoring Status/Alarm Conditions** _____ (continued)□ **Reading and Qualifying Alarms** (continued)

*SRE . . . <i>Sets the Alarm Enable Register.</i>	:SYSTem:PRESet
	136
	NON-VOLATILE

The setting of the Alarm Enable Register (Figure 5-2) selects which summary status from the Alarm Condition Register is enabled to generate an alarm.

Expanded Syntax

*SRE <bit mask>

Semantics

The <bit mask> has a range of 0 to 255.

The <bit mask> value represents the sum of the binary-weighted values of the register. Attempts to set unused bits in the register are ignored—the value of unused bits is zero.

*SRE? <i>Identifies the status conditions enabled to generate an alarm.</i>	RESPONSE FORMAT
	\pm dd

This query identifies the status conditions enabled to generate an alarm.

Reading the Alarm Enable Register identifies which summary status from the Alarm Condition Register is enabled to generate an alarm.

Response

The range is 0 to 255.

The response value represents the sum of the binary-weighted values of the register. The value of unused bits is zero.

Theory

Reading/Querying the Alarm Enable Register does not change its contents.

Operating Status**Monitoring Status/Alarm Conditions** _____ *(continued)*□ **Reading and Qualifying Alarms** *(continued)*

*STB? <i>Reads the Alarm Condition Register.</i>	RESPONSE FORMAT \pm dd
--	--

This query reads the Alarm Condition Register (Figure 5-2).

Response

The range is 0 to 255.

The response value represents the sum of the binary-weighted values of the register. The value of unused bits is zero.

Theory

The Alarm Condition Register continuously monitors the summary status of the instrument.

The Alarm Condition Register bits are updated in real time—there is no latching or buffering.

Reading/Querying the Alarm Condition Register does not change its contents.

At powerup, the Alarm Condition Register is cleared.

Operating Status



Monitoring Status/Alarm Conditions _____ (continued)

□ **Reading and Qualifying Receiver Status** _____

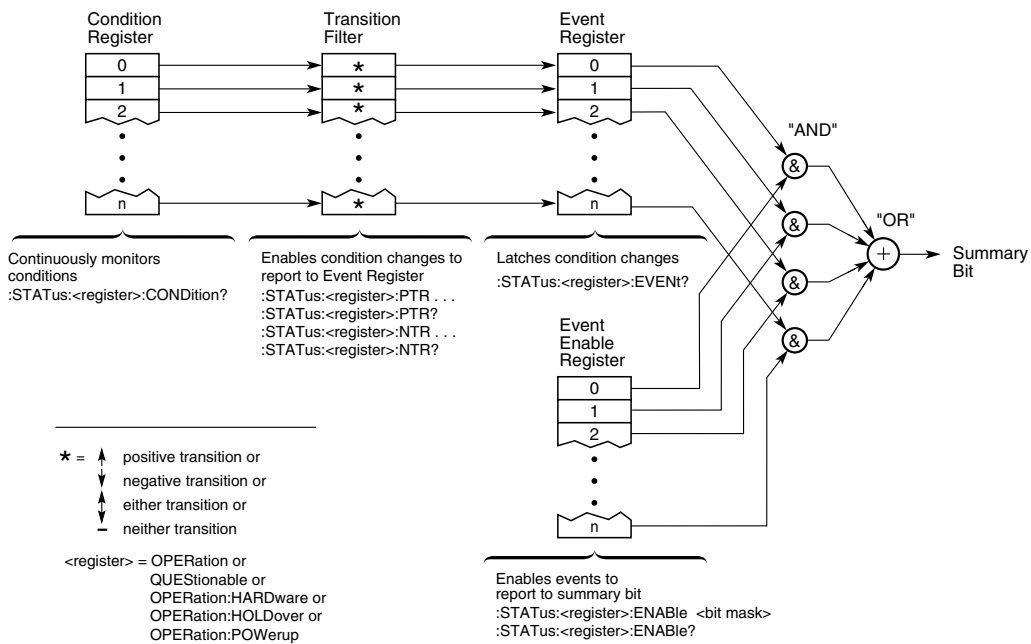

Figure 5-3. Condition, Transition Filter, Event Enable, and Event Registers

Operating Status**Monitoring Status/Alarm Conditions** _____ *(continued)*□ **Reading and Qualifying Receiver Status** *(continued)***:STATus:<register>:CONDition?***Reads the specified condition register.*

RESPONSE FORMAT

± dd

This query reads the specified condition register (figures 5-3 and 5-1).

Expanded Syntax

:STATus:OPERation:CONDition?

:STATus:QUESTionable:CONDition?

:STATus:OPERation:HARDware:CONDition?

:STATus:OPERation:HOLDover:CONDition?

:STATus:OPERation:POWerup:CONDition?

Response

The range is 0 to 65535.

The response value represents the sum of the binary-weighted values of the register. The value of unused bits is zero.

Note that some bits, those which are “event-only”, have no corresponding conditions.

Theory

A condition register continuously monitors the hardware and firmware status (that is, the operating conditions) of the instrument.

Conditions register bits are updated in real time—there is no latching or buffering.

Reading/Querying a condition register does not change its contents.

At powerup, the conditions registers are cleared.

Operating Status**Monitoring Status/Alarm Conditions** _____ *(continued)*□ **Reading and Qualifying Receiver Status** *(continued)***:STATus:<register>:EVENT?***Reads the specified event register.*

RESPONSE FORMAT

± dd

This query reads the specified event register (figures 5-3 and 5-1), retrieving information about what has happened to the instrument since it was last queried, or cleared by :SYSTEM:PRESet or *CLS.

Expanded Syntax

:STATus:OPERation:EVENT?

:STATus:QUESTionable:EVENT?

:STATus:OPERation:HARDware:EVENT?

:STATus:OPERation:HOLDover:EVENT?

:STATus:OPERation:POWerup:EVENT?

Response

The range is 0 to 65535.

The response value represents the sum of the binary-weighted values of the register. The value of unused bits is zero.

Side Effects

Reading/Querying an event register clears it.

Theory

An event register captures changes in conditions. When a transition occurs, the corresponding bit in the event register is set TRUE. The instrument can be configured (using :STATus:<register>:NTRansition and :STATus:<register>:PTRansition), for each bit position, to capture the positive, the negative, either, or neither transition.

Event register bits, once set, are latched. That is, they remain set until they are read. When they are read, they are cleared.

At powerup, the event registers are cleared.

See Also

:STATus:<register>:NTRansition . . .

:STATus:<register>:PTRansition . . .

Operating Status**Monitoring Status/Alarm Conditions** _____ *(continued)*□ **Reading and Qualifying Receiver Status** *(continued)*

```
:STATus:<register>:ENABLE . . .
```

Sets the specified enable register.

```
:SYSTem:PRESet
```

See Figure 5-1 for Default
Event Enable identification

```
NON-VOLATILE
```

The setting of an enable register (figures 5-3 and 5-1) selects which events from the corresponding event register are enabled to report to the corresponding summary bit of the summarizing condition register.

Expanded Syntax

```
:STATus:OPERation:ENABLE <bit mask>
```

```
:STATus:QUEStionable:ENABLE <bit mask>
```

```
:STATus:OPERation:HARDware:ENABLE <bit mask>
```

```
:STATus:OPERation:HOLDOver:ENABLE <bit mask>
```

```
:STATus:OPERation:POWerup:ENABLE <bit mask>
```

Parameter

The <bit mask> has a range of 0 to 65535.

The <bit mask> value represents the sum of the binary-weighted values of the register. Attempts to set unused bits in an enable register are ignored—the value of unused bits is zero.

Operating Status**Monitoring Status/Alarm Conditions** _____ *(continued)*□ **Reading and Qualifying Receiver Status** *(continued)*

:STATus:<register>:ENABLE?	RESPONSE FORMAT
<i>Reads the specified enable register.</i>	± dd

Reading an enable register (figures 5-3 and 5-1) identifies which events from the corresponding event register are enabled to report to the corresponding summary bit of the summarizing condition register.

Expanded Syntax

:STATus:OPERation:ENABLE?

:STATus:QUESTionable:ENABLE?

:STATus:OPERation:HARDware:ENABLE?

:STATus:OPERation:HOLDover:ENABLE?

:STATus:OPERation:POWerup:ENABLE?

Response

The range is 0 to 65535.

The response value represents the sum of the binary-weighted values of the register. The value of unused bits is zero.

Theory

Reading/Querying an enable register does not change its contents.

Operating Status**Monitoring Status/Alarm Conditions** _____ *(continued)*□ **Reading and Qualifying Receiver Status** *(continued)*

<pre>:STATus:<register>:NTRansition . . . :STATus:<register>:PTRansition . . .</pre> <p><i>Sets the specified transition filter registers.</i></p>	<pre>:SYSTem:PRESet</pre> <p>See Figure 5-1 for Default Transition Filter identification</p> <hr/> <p>NON-VOLATILE</p>
--	--

The setting of the transition filter registers selects which condition transitions (positive, negative, either, or neither) are enabled to report events.

Expanded Syntax

```
:STATus:OPERation:NTRansition <bit mask>
:STATus:QUEStionable:NTRansition <bit mask>
:STATus:OPERation:HARDware:NTRansition <bit mask>
:STATus:OPERation:HOLDover:NTRansition <bit mask>
:STATus:OPERation:POWerup:NTRansition <bit mask>

:STATus:OPERation:PTRansition <bit mask>
:STATus:QUEStionable:PTRansition <bit mask>
:STATus:OPERation:HARDware:PTRansition <bit mask>
:STATus:OPERation:HOLDover:PTRansition <bit mask>
:STATus:OPERation:POWerup:PTRansition <bit mask>
```

Parameter

The <bit mask> has a range of 0 to 65535.

The <bit mask> value represents the sum of the binary-weighted values of the register. Attempts to set unused bits in the transition filter are ignored—the value of unused bits is zero.

To enable negative (one to zero) transitions of specific conditions, set the corresponding bits to one in the <bit mask> for the NTRansition register command.

To enable positive (zero to one) transitions of specific conditions, set the corresponding bits to one in the <bit mask> for the PTRansition register command.

Note that some bits, those which are “event-only”, have no transition filter setting. Attempts to set these bits are ignored.

Operating Status**Monitoring Status/Alarm Conditions** _____ *(continued)*□ **Reading and Qualifying Receiver Status** *(continued)*

:STATus:<register>:NTRansition? :STATus:<register>:PTRansition? <i>Reads the specified transition filter registers.</i>	RESPONSE FORMAT \pm dd
---	---------------------------------

Reading the transition filter registers identifies which condition transitions (positive, negative, either, or neither) are enabled to report events.

Expanded Syntax

```

:STATus:OPERation:NTRansition?
:STATus:QUESTionable:NTRansition?
:STATus:OPERation:HARDware:NTRansition?
:STATus:OPERation:HOLDover:NTRansition?
:STATus:OPERation:POWerup:NTRansition?

:STATus:OPERation:PTRansition?
:STATus:QUESTionable:PTRansition?
:STATus:OPERation:HARDware:PTRansition?
:STATus:OPERation:HOLDover:PTRansition?
:STATus:OPERation:POWerup:PTRansition?

```

Response

The range is 0 to 65535.

The response value represents the sum of the binary-weighted values of the register. The value of unused bits is zero.

The bits which are set to one in the <bit mask> of the NTRansition query response indicate the enabled negative transitions of corresponding conditions.

The bits which are set to one in the <bit mask> of the PTRansition query response indicate the enabled positive transitions of corresponding conditions.

Theory

Reading/Querying a transition filter register does not change its contents.



Monitoring Status/Alarm Conditions _____ (continued)

□ Reading and Qualifying Command Error Status _____

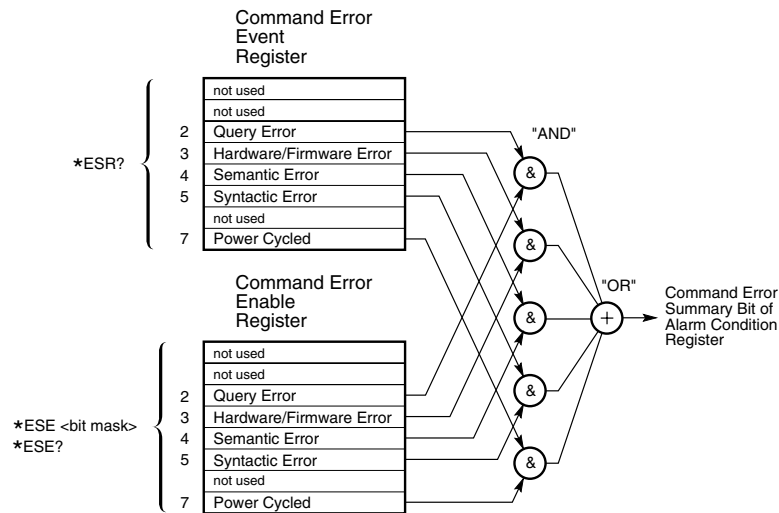

Figure 5-4. Command Error Event and Enable Registers

*ESE . . .	:SYSTEM:PRESet
<i>Sets the Command Error Enable Register.</i>	0
	NON-VOLATILE

The setting of the Command Error Enable Register (Figure 5-4) selects which events from the Command Error Event Register are enabled to report to the Command Error Summary bit of the Alarm Condition Register.

Expanded Syntax

*ESE <bit mask>

Parameter

The <bit mask> has a range of 0 to 255.

The <bit mask> value represents the sum of the binary-weighted values of the register. Attempts to set unused bits in the register are ignored—the value of unused bits is zero.

Operating Status**Monitoring Status/Alarm Conditions** _____ *(continued)*□ **Reading and Qualifying Command Error Status** *(continued)*

*ESE? <i>Reads the Command Error Enable Register.</i>	RESPONSE FORMAT \pm dd
---	------------------------------------

This query identifies the status conditions enabled to generate an alarm.

Reading the Command Error Enable Register (Figure 5-4) identifies which events from the Command Error Event Register are enabled to report to the Command Error Summary bit of the Alarm Condition Register.

Response

The range is 0 to 255.

The response value represents the sum of the binary-weighted values of the register. The value of unused bits is zero.

Theory

Reading/Querying the Command Error Enable Register does not change its contents.

*ESR? <i>Reads the Command Error Event Register.</i>	RESPONSE FORMAT \pm dd
--	------------------------------------

This query reads the Command Error Event Register, retrieving information about errors (or power cycles) that have occurred since the instrument was last queried, or cleared by SYSTEM:PRESet or *CLS.

Response

The range is 0 to 255.

The response value represents the sum of the binary-weighted values of the register. The value of unused bits is zero.

Operating Status**Monitoring Status/Alarm Conditions** _____ *(continued)*□ **Reporting Questionable Status** _____

:STATus:QUESTionable:CONDition:USER . . . <i>Sets the User-reported bit of the Questionable Condition Register.</i>	:SYSTEM:PRESet Clear NON-VOLATILE
---	--

This command sets the User-reported bit of the Questionable Condition Register.

Expanded Syntax

:STATus:QUESTionable:CONDition:USER SET *or* CLear

Parameter

SET will cause the User-reported bit of Questionable Condition Register to be set to 1.

CLear will cause the User-reported bit of Questionable Condition Register to be set to 0.

Side Effects

The User-reported bit of the Questionable Condition Register is set or cleared by this command.

Theory

A condition change (from SET to CLEAR, or CLEAR to SET) of the User-reported bit of the Questionable Condition Register, and the appropriate configuration of the Questionable Transition Filter is necessary to generate an event in the Questionable Event Register.

Furthermore, when the User-reported bit of Questionable Event Enable Register is enabled, and the Questionable Summary bit of the Alarm Enable Register is enabled, then a transition of the User-reported condition will generate an ALARM.

Operating Status**Monitoring Status/Alarm Conditions** _____ *(continued)*□ **Reporting Questionable Status** *(continued)*

:STATus:QUESTionable:EVENT:USER . . . <i>Generates a transition of the User-reported bit of the Questionable Condition Register.</i>	EVENT
	NON-VOLATILE

This command generates a transition of the User-reported bit of the Questionable Condition Register.

Expanded Syntax

:STATus:QUESTionable:EVENT:USER PTRansition or NTRansition

Parameter

PTRansition will cause the User-reported bit of Questionable Condition Register to transition from a setting of 0 to a setting of 1.

NTRansition will cause the User-reported bit of Questionable Condition Register to transition from a setting of 1 to a setting of 0.

Context Dependencies

Issuing PTRansition, while the User-reported bit of the Questionable Positive Transition Register is enabled, sets the User-reported bit of the Questionable Event register.

Issuing NTRansition, while the User-reported bit of the Questionable Negative Transition Register is enabled, sets the User-reported bit of the Questionable Event register.

Side Effects

The user-reported bit of the Questionable Condition Register is set by the PTRansition parameter or cleared by the NTRansition parameter.

Theory

A positive or negative (PTRansition or NTRansition) of the User-reported bit of the Questionable Condition Register, and the appropriate configuration of the Questionable Transition Filter is necessary to generate an event in the Questionable Event Register.

Furthermore, when the User-reported bit of Questionable Event Enable Register is enabled, and the Questionable Summary bit of the Alarm Enable Register is enabled, then a User-reported event will generate an ALARM.

Operating Status**Assessing Receiver Health*****TST?***Executes an internal selftest and reports the results.*

RESPONSE FORMAT

± dd

This query causes an internal selftest and the response indicates whether any errors were detected. This test takes about 40 seconds to complete.

Error -330, “Self test failed” is generated if the selftest fails.

NOTE

Manual operation of internal diagnostics will affect normal Receiver operation, including disruption of any or all of the following: GPS satellite tracking, reference oscillator frequency, 1 PPS output timing, and Receiver status information. When invoked manually, any of these diagnostics should be considered to be destructive tests.

The following elements and functions are tested:

- CPU
- EPROM
- RAM
- EEPROM
- UART
- QSPI
- FPGA logic
- Interpolators
- GPS engine
- Power supply levels
- Reference oscillator

Response

A value of 0 indicates the tests passed, a non-zero value indicates the selftest was not completed or was completed with errors detected.

Operating Status**Assessing Receiver Health** _____ *(continued)***:DIAGnostic:LIFetime:COUNT?**

Returns the lifetime count, indicating the total powered-on time.

RESPONSE FORMAT

\pm **dd**

This query returns the lifetime count, indicating the total powered-on time.

Response

Range of the integer is 0 to 4,294,967,296 with a resolution of 1. Each count represents three hours of operation.

:DIAGnostic:TEST? . . .

Returns information for user-specified test.

RESPONSE FORMAT

\pm **dd**

This query returns information for user-specified test.

Expanded Syntax

:DIAGnostic:TEST? ALL *or* DISPLAY *or* PROCessor *or* RAM *or* EEPROM *or* UART *or* QSPI *or* FPGA *or* INTERpolator *or* GPS *or* POWER.

Response

A value of 0 (zero) indicates test passed.

Parameter

ALL returns test information for all of the tests.



Assessing Receiver Health _____ *(continued)*

:DIAGnostic:TEST:RESult?

Returns the result of the last test and the type of test performed.

RESPONSE FORMAT

\pm dd, XYZ

This query returns the result of the last test and the type of test performed. Use this query, for example, following powerup to check the outcome of the powerup selftest.

Response

A value of 0 indicates test passed. Non-zero value indicates test failed.

The literal or alphanumeric characters portion of the response identifies the specific test.



System Time

The GPS Receiver is designed to allow you access to a very accurate system clock that provides both date and time, to customize the clock for a local time zone, to identify the exact time, to identify the accumulated time difference (in seconds) between the GPS and UTC timelines, and to monitor and adjust for leap second occurrences.

The following commands are provided to allow you to monitor and control the system date and time.

■ Identifying Time of Next 1 PPS Reference Edge

:PTIME:TCODE?

■ Reading Current Time

:PTIME:DATE? or :SYSTEM:DATE?

:PTIME:TIME? or :SYSTEM:TIME?

:PTIME:TIME:STRing?

■ Applying Local Time Zone Offset

:PTIME:TZONE ...

:PTIME:TZONE?

■ Defining the 1 PPS Reference Edge (59551A Only)

:PTIME:PPS:EDGE ...

:PTIME:PPS:EDGE?

■ Reading Leap Second Status

:PTIME:LEAPsecond:ACCumulated?

:PTIME:LEAPsecond:DATE?

:PTIME:LEAPsecond:DURation?

:PTIME:LEAPsecond:STATe?

System Time**Identifying Time of Next 1 PPS Reference Edge** _____**:PTIME:TCODE?**

Returns timecode message 980 to 20 ms prior to 1 PPS of indicated time.

RESPONSE FORMAT

ASCII Data

This query returns timecode message 980 to 20 ms prior to 1 PPS of indicated time. This special query provides not only accurate time but also provides the user the opportunity to correctly correlate this time with a corresponding 1 PPS edge.

Response

The query response provides the following type of information:

- date and time of next on-time edge,
- Time Figure of Merit,
- Frequency Figure of Merit,
- leap second indicator,
- alarm indication, and
- service request.

An example response is:

```
T2199505112055233000049
```

This example is in the "T2YYYYMMDDHHMMSSMFLRVcc" format, where

T2	indicates a timecode message.
YYYYMMDD	is the calendar date at the next 1 PPS on-time edge.
HHMMSS	is the 24 hour time at the next 1 PPS on-time edge. Note that this value is influenced by the ptim:tzon setting.
M	is time figure of merit.
F	is frequency figure of merit.
L	is leapsecond indicator (- means a -1 leapsecond is pending, 0 means no leapsecond pending, + means a 1 leapsecond is pending).
R	is the request for service bit from the status system (0 = no service requested, 1 = service requested). An alarm will be generated when this byte transitions to 1.
V	is validity byte. 1 indicates that time-related information isn't valid, 0 indicates that it is valid.
cc	is the checksum of the prior bytes (two Hex bytes).

System Time**Reading Current Time**

:PTIME:DATE?
:SYSTEM:DATE?

Returns the current calendar date.

RESPONSE FORMAT

± dd, ± dd, ± dd

This query returns the current calendar date. The local calendar date is always referenced to UTC time, offset by any local time zone value that has been provided by the user. The year, month, and day are returned.

Response

Three fields are separated by commas: <year>,<month>,<day>.

- The <year> range is 1994 to 2077.
- The <month> range is 1 to 12.
- The <day> range is 1 to 31.

Context Dependencies

This query is not valid prior to the first lock following powerup (see bit 2 of the Powerup Status Register) or :SYSTEM:PRESet. Sending this query before the first lock will generate **error -230**.

:PTIME:TIME?
:SYSTEM:TIME?

Returns the current 24-hour time.

RESPONSE FORMAT

± dd, ± dd, ± dd

This query returns the current 24-hour time. The local time is always referenced to UTC time, offset by any local time zone value that has been provided by the user. The hour, minute, and second is returned.

Response

Three fields are separated by commas: <hour>,<minute>,<second>.

- The <hour> range is 0 to 23.
- The <minute> range is 0 to 59.
- The <second> range is 0 to 60. The value of 60 only occurs as the UTC leapsecond.

Context Dependencies

This query is not valid prior to the first lock following powerup (see bit 2 of the Powerup Status Register) or :SYSTEM:PRESet. Sending this query before the first lock will generate **error -230**.

System Time**Reading Current Time** _____ *(continued)***:PTIME:TIME:STRing?***Returns the current 24-hour time suitable for display.*

RESPONSE FORMAT

"XYZ"

This query returns the current 24-hour time suitable for display (for example, 15:23:06).

Context Dependencies

This query is not valid prior to the first lock following powerup (see bit 2 of the Powerup Status Register) or :SYSTEM:PRESet. Sending this query before the first lock will generate **error -230**.

System Time



Applying Local Time Zone Offset _____



:PTIME:TZONE ...

Sets the time zone local time offset to provide an offset from UTC to serve as the basis for all reported time.

:SYSTEM:PRESet

0,0

NON-VOLATILE

This command sets the time zone local time offset to provide an offset from Universal Coordinated Time (UTC) to serve as the basis for all reported time. The local 24-hour time and local calendar date depend on the present setting of the time zone parameter, which is used to indicate the offset from UTC. Typical application of this command is to account for time zone differences between the installed Receiver location and the prime meridian at Greenwich, which uses UTC uncorrected.

Expanded Syntax

:PTIME:TZONE <hour>, <minutes>

Parameter

- The <hour> range is -12 to +12, and is rounded to the nearest integer.
- The optionally supplied <minute> range -59 to +59, and is rounded to the nearest integer. The <minute> is defaulted to 0 if not supplied.

Context Dependencies

:SYSTEM:PRESet sets the time zone to zero (0,0).



:PTIME:TZONE?

Returns the local time zone offset.

RESPONSE FORMAT

± dd, ± dd

This query returns the local time zone offset.

Response

The first returned value is offset hours. The second returned value is offset minutes.

System Time**Defining the 1 PPS Reference Edge (59551A Only) _____****59551A**

:PTIME:PPS:EDGE ... <i>Selects the polarity of the 1 PPS on-time edge.</i>	:SYSTem:PRESet
	RISing
	NON-VOLATILE

This command selects the polarity of the 1 PPS on-time edge.

Expanded Syntax

:PTIME:PPS:EDGE RISing or FALLing

Parameter

The RISing parameter sets the 1 PPS rising edge as the on-time edge.

The FALLing parameter sets the 1 PPS falling edge as the on-time edge.

59551A

:PTIME:PPS:EDGE? <i>Returns the polarity of the 1 PPS on-time edge.</i>	RESPONSE FORMAT
	XYZ

This query returns the polarity of the 1 PPS on-time edge.

Response

RIS indicates that the 1 PPS on-time edge is the rising edge.

FALL indicates that the 1 PPS on-time edge is the falling edge.

System Time



Reading Leap Second Status



:PTIME:LEAPsecond:ACCumulated?

Returns the leap second difference accumulated between GPS time and UTC time since the beginning of GPS time. The time units are seconds.

RESPONSE FORMAT

± dd

This query returns the leap second difference accumulated between GPS time and UTC time since the beginning of GPS time. The time units are seconds.

Response

An example response is:

+10

which indicates that the accumulated leap second difference between the GPS time and UTC is 10 seconds.

Context Dependencies

This query is not valid prior to the first lock following powerup (see bit 2 of the Powerup Status Register) or :SYSTEM:PRESet. Sending this query before the first lock will generate **error -230**.

Theory

The leap second value is initialized during the power-on sequence by evaluating :PTIME:LEAPsecond:ACC = GPS time - UTC time. In July 1994, the value was 10 seconds.

The value is automatically adjusted immediately following the occurrence of a leap second correction to the UTC time scale. When a 1 leap second addition is made to the UTC time scale, the extra second delays the arrival of midnight UTC causing :PTIME:LEAP:ACC? to increase by 1 second. When a 1 leap second subtraction is made to the UTC time scale, the missing second hastens the arrival of UTC midnight causing :PTIME:LEAP:ACC? to decrease by 1 second.

System Time



Reading Leap Second Status _____ (continued)

:PTIMe:LEAPsecond:DATE?

Returns the UTC calendar date of next leap second.

RESPONSE FORMAT

\pm **dd**, \pm **dd**, \pm **dd**

This query returns the UTC calendar date of next leap second. The year, month, and day are returned.

Response

Three fields are separated by commas: <year>,<month>,<day>.

- The <year> range is 1994 to 2077.
- The <month> range is 1 to 12.
- The <day> range is 1 to 31.

Context Dependencies

This query is not valid prior to the first lock following powerup (see bit 2 of the Powerup Status Register) or :SYSTem:PRESet, or if no leap second is pending. Sending this query before the first lock or if no leap second is pending will generate **error -230**.

System Time



Reading Leap Second Status _____ (continued)

:PTIME:LEAPsecond:DURation?

Returns the duration of the minute corrected by the next leap second.

RESPONSE FORMAT

± dd

This query identifies whether a leap second is pending, distinguishes between leap seconds which extend the minute, and leap seconds which shorten the minute. This query returns the duration of the minute corrected by the next leap second. The duration units are seconds.

Response

Returns a value of 59, 60 or 61:

- A value of 59 indicates subtraction of 1 second is pending.
- A value of 60 indicates no leap second pending.
- A value of 61 indicates addition of 1 second is pending.

Context Dependencies

This query is not valid prior to the first lock following powerup (see bit 2 of the Powerup Status Register) or :SYSTem:PRESet, or if no leap second is pending. Sending this query before the first lock or if no leap second is pending will generate **error -230**.

System Time



Reading Leap Second Status _____ *(continued)*

:PTIMe:LEAPsecond:STATe?

Identifies if leap second is pending.

RESPONSE FORMAT

0 or 1

This query identifies if a leap second is pending. This query looks ahead to indicate a pending leap second.

Response

A value of 0 indicates no leap second is pending.

A value of 1 indicates a leap second is pending. The leap second adjustment can be either the addition of a second or the subtraction of a second.

Context Dependencies

This query is not valid prior to the first lock following powerup (see bit 2 of the Powerup Status Register) or :SYSTem:PRESet (but is valid if no leap second is pending). Sending this query before the first lock will generate **error -230**.



Programmable Pulse Output (59551A Only)

The Programmable Pulse output feature provides a means of using the GPS Receiver as a pulse generator. The pulse output, which is programmable by the user, can either generate a stream of pulses at a specified start time and repetition interval, or it can produce a single pulse at a specified time and then stop.

The following commands are provided to allow you to operate and control the programmable output of the 59551A GPS Receiver.

Note that the configuring of the Programmable Pulse output requires consideration of five settings: start date, start time, continuous on/off, pulse period, and pulse polarity. Changing any one of the settings will stop any previously configured pulse stream and reassert all five settings. If the start date has already passed when you modify the repetition interval, the pulse output will halt until you provide a new start date.

```
:PULSe:CONTInuous:PERiod ...  
:PULSe:CONTInuous:PERiod?  
:PULSe:CONTInuous:STATe ...  
:PULSe:CONTInuous:STATe?  
:PULSe:REFerence:EDGE ...  
:PULSe:REFerence:EDGE?  
:PULSe:STARt:DATE ...  
:PULSe:STARt:DATE?  
:PULSe:STARt:TIME ...  
:PULSe:STARt:TIME?
```

Programmable Pulse Output (59551A Only)

59551A	
 :PULSe:CONTInuous:PERiod . . . <i>Sets the interval between pulses in seconds.</i>	:SYSTem:PRESet
	1
NON-VOLATILE	

This command sets the interval between pulses in seconds.

Expanded Syntax

:PULSe:CONTInuous:PERiod <seconds>

Parameter

The <seconds> parameter range is 1 to 31536000, equivalent to one year. Resolution is 1.

Context Dependencies

The interval set by this command is only used if :PULSe:CONTInuous:STATe is ON.

59551A	
 :PULSe:CONTInuous:PERiod? <i>Returns the interval between pulses in seconds.</i>	RESPONSE FORMAT
	± dd

This query returns the interval between pulses in seconds.

Programmable Pulse Output (59551A Only)**59551A****:PULSe:CONTInuous:STATe . . .***Controls whether the Programmable Pulse output will be just one pulse or a sequence of pulses.*

:SYSTem:PRESet

OFF

NON-VOLATILE

This command controls whether the Programmable Pulse output will be just one pulse or a sequence of pulses.

Expanded Syntax:PULSe:CONTInuous:STATe ON *or* OFF**Parameter**

OFF selects one pulse. ON selects a sequence of pulses.

Context Dependencies

With either state (OFF or ON) the output commences at the time and date defined by :PULSe:START:DATE and :PULSe:START:TIME commands.

59551A**:PULSe:CONTInuous:STATe?***Identifies whether the Programmable Pulse output is set to output a single pulse or a sequence of pulses.*

RESPONSE FORMAT

0 or 1

This query identifies whether the Programmable Pulse output is set to output a single pulse or a sequence of pulses.

Response

- A value of 0 indicates the Receiver is set to output one pulse.
- A value of 1 indicates the Receiver is set to output a sequence of pulses.

Programmable Pulse Output (59551A Only)

	59551A :PULSe:REFerence:EDGE . . . <i>Selects the polarity of the Programmable Pulse on-time edge.</i>	:SYSTem:PRESet RISing
		NON-VOLATILE

This command selects the polarity of the Programmable Pulse on-time edge.

Expanded Syntax

:PULSe:REFerence:EDGE RISing or FALLing

Parameter

The RISing parameter sets the Programmable Pulse rising edge as the on-time edge.

The FALLing parameter sets the Programmable Pulse falling edge as the on-time edge.

	59551A :PULSe:REFerence:EDGE? <i>Returns the polarity of the Programmable Pulse on-time edge.</i>	RESPONSE FORMAT XYZ

This query returns the polarity of the Programmable Pulse on-time edge.

Response

RIS indicates that the Programmable Pulse on-time edge is the rising edge.

FALL indicates that the Programmable Pulse on-time edge is the falling edge.

Programmable Pulse Output (59551A Only)**59551A****:PULSe:STARt:DATE . . .***Identifies the date when the individual pulse (or first pulse of the pulse sequence) is generated at the Programmable Pulse output.*

:SYSTem:PRESet

1994, 1, 1

NON-VOLATILE

This command identifies the date when the individual pulse (or first pulse of the pulse sequence) is generated at the Programmable Pulse output.

Expanded Syntax

:PULSe:STARt:DATE <four-digit year>,<month>,<day>

Parameter

- The <four-digit year> range is 1994 to 3000.
- The <month> range is 1 to 12.
- The <day> range is 1 to 31.

Context Dependencies

If you select a date and time which occurs prior to the current time or prior to the completion of powerup and first GPS lock, the Receiver will not successfully find a start—and therefore will produce no pulses.

If the Receiver has been set up to use a time zone offset to produce local date and time, the parameters provided should also be expressed as local date and time.

**59551A****:PULSe:STARt:DATE?***Returns the date when the individual pulse (or first pulse of the pulse sequence) is generated at the Programmable Pulse output.*

RESPONSE FORMAT

± dd, ± dd, ± dd

This query returns the date when the individual pulse (or first pulse of the pulse sequence) is generated at the Programmable Pulse output. This query returns year, month, and day.

Response

Three fields are separated by commas: <four-digit year>,<month>,<day>.

- The <four-digit year> range is 1994 to 3000.
- The <month> range is 1 to 12.
- The <day> range is 1 to 31.

Programmable Pulse Output (59551A Only)**59551A**

:PULSe:STARt:TIME . . .	:SYSTem:PRESet
<i>Identifies the time when the individual pulse (or first pulse of the pulse sequence) is generated at the Programmable Pulse output.</i>	0,0,0
	NON-VOLATILE

This command identifies the time when the individual pulse (or first pulse of the pulse sequence) is generated at the Programmable Pulse output.

Expanded Syntax

:PULSe:STARt:TIME <hour>,<minute>,<second>

Parameter

Three fields are separated by commas: <hour>,<minute>, <second>.

- The <hour> range is 0 to 23.
- The <minute> range is 0 to 59.
- The <second> range is 0 to 59.

Context Dependencies

If you select a date and time which occurs prior to the current time or prior to the completion of powerup and first GPS lock, the Receiver will not successfully find a start—and therefore will produce no pulses.

If the Receiver has been set up to use a time zone offset to produce local date and time, the parameters provided should also be expressed as local date and time.

**59551A**

:PULSe:STARt:TIME?	RESPONSE FORMAT
<i>Returns the time when the individual pulse (or first pulse of the pulse sequence) is generated at the Programmable Pulse output.</i>	± dd, ± dd, ± dd

This query returns the time when the individual pulse (or first pulse of the pulse sequence) is generated at the Programmable Pulse output.

Response

Three fields are separated by commas: <hour>, <minute>, <second>.

- The <hour> range is 0 to 23.
- The <minute> range is 0 to 59.
- The <second> range is 0 to 59.



Event Time Stamping (59551A Only)

The time stamping feature allows you to use the Receiver with equipment such as a fault analyzer or a surge detector that produces a TTL edge when some important event happens in the base station. The Receiver has three time tagging inputs (**Time Tag 1**, **Time Tag 2**, **Time Tag 3**) which record the time of occurrence of TTL edge(s).

The following commands are provided to allow you to tag and record events such as power surges and power outages.

■ Defining the Time-stamped Edge

```
:SENSe:TSTamp<channel>:EDGE ...
:SENSe:TSTamp<channel>:EDGE?
```

■ Clearing Time Stamp Memory

```
:SENSe:DATA:CLEAr
:SENSe:DATA:CLEAr ...
```

■ Reading Time Stamps

```
:SENSe:DATA? ...
:FORMat:DATA ...
:FORMat:DATA?
:SENSe:DATA:POINts?
:SENSe:DATA:POINts? ...
:SENSe:DATA:TSTamp? ...
```

■ Processing Memory Overflow

```
:SENSe:DATA:MEMory:OVERflow:COUNT?
:SENSe:DATA:MEMory:OVERflow:COUNT? ...
:SENSe:DATA:MEMory:SAVE ...
:SENSe:DATA:MEMory:SAVE?
```



Defining the Time-stamped Edge _____

59551A



:SENSe:TSTamp<channel>:EDGE . . . <i>Selects the polarity of the edges the Receiver will time stamp.</i>	:SYSTem:PRESet
	RISing
	NON-VOLATILE

This command selects the polarity of the edges the Receiver will time stamp.

Expanded Syntax

:SENSe:TSTamp1:EDGE RISing or FALLing

:SENSe:TSTamp2:EDGE RISing or FALLing

:SENSe:TSTamp3:EDGE RISing or FALLing

Parameter

- The RISing parameter sets the time-stamped edge as the rising edge.
- The FALLing parameter sets the time-stamped edge as the falling edge.

59551A



:SENSe:TSTamp<channel>:EDGE? <i>Returns the polarity of the edges the Receiver will time stamp.</i>	RESPONSE FORMAT
	XYZ

This query returns the polarity of the edges the Receiver will time stamp.

Response

RIS indicates that the time-stamped edge is the rising edge.

FALL indicates that the time-stamped edge is the falling edge.

59551A



:SENSe:DATA:CLEar <i>Clears the data in the measurement buffer for all Time Tag inputs.</i>	
	EVENT

This command clears the data in the measurement buffer and clears the overflow counts for all Time Tag inputs.

Context Dependencies

:SYSTem:PRESet clears the time stamp measurement buffers and overflow counts.

Event Time Stamping (59551A Only)**Clearing Time Stamp Memory** _____**59551A**

:SENSe:DATA:CLEAr . . .	EVENT
--------------------------------	--------------

Clears the data in the time stamp measurement buffer for the user-specified Time Tag input.

This command clears the data in the time stamp measurement buffer for the user-specified Time Tag input. Use "TSTamp 1" or "TSTamp 2" or "TSTamp 3" to select one input.

Expanded Syntax

:SENSe:DATA:CLEAr "TSTamp 1" or "TSTamp 2" or "TSTamp 3"

Parameter

"TSTamp 1" clears the data in **Time Tag 1** input buffer.

"TSTamp 2" clears the data in **Time Tag 2** input buffer.

"TSTamp 3" clears the data in **Time Tag 3** input buffer.

Context Dependencies

:SYSTem:PRESet clears the time stamp measurement buffers.



Reading Time Stamps



59551A

:SENSe:DATA? ...

Outputs data from the one specified time stamp measurement buffer.

RESPONSE FORMAT

FORMAT = ASCii

± dd, ...

FORMAT = INTeger

BINARY Data

This query outputs data from the one specified time stamp measurement buffer (or Time Tag input). This query does not clear the buffer. Each time stamp provides the year, month, day, hours, minutes, seconds, milliseconds, microseconds, nanoseconds, and TFOM (Time Figure of Merit).

Expanded Syntax

:SENSe:DATA? "TSTamp 1" or "TSTamp 2" or "TSTamp 3"

Response

If the format is ASCii (the default format), the response is a sequence of comma-separated integers.

If the format is INTeger, the response is BINARY Data (see Table B-3, in Appendix B, "Command Syntax and Style," in this guide for details).

To determine which format is selected, use query :FORmat:DATA?.

Parameter

Use "TSTamp 1" or "TSTamp 2" or "TSTamp 3" to select one input at a time:

- "TSTamp 1" outputs the data from **Time Tag 1** input buffer.
- "TSTamp 2" outputs the data from **Time Tag 2** input buffer.
- "TSTamp 3" outputs the data from **Time Tag 3** input buffer.

Context Dependencies

:SYSTem:PRESet clears the time stamp measurement buffers and overflow counts.

Time stamps are not collected until after the Receiver has completed its powerup, and has reached initial lock to GPS.

Time stamps are not collected while the user is reading/clearing or otherwise accessing the time stamp buffers.



Reading Time Stamps _____ (continued)

59551A

:FORMat:DATA . . . <i>Selects output format for the time stamps.</i>	:SYSTem:PRESet
	ASCIi
	NON-VOLATILE

This command selects the output format for the time stamps.

Expanded Syntax

:FORMat:DATA ASCii or INTeger

Parameter

If the format is ASCii (the default format), the response is a sequence of comma-separated integers.

If the format is INTeger, the response to the :SENSe:DATA? query is BINARY Data (see Table B-3, in Appendix B, “Command Syntax and Style,” in this guide for details).

When ASCii formatting is selected the output stream data is buffered. In general, INT mode will provide faster output than ASC, but will require special data-handling routines to interpret the BINARY Data.

59551A

:FORMat:DATA? <i>Returns the output format for time stamp data.</i>	RESPONSE FORMAT
	XYZ

This query returns the output format for time stamp data.

Response

ASC or INT is returned.



Reading Time Stamps _____ (continued)

59551A

:SENSe:DATA:POINts? <i>Returns the number of time stamps in each of the three Time Tag inputs.</i>	RESPONSE FORMAT ± dd, ...
--	-------------------------------------

This query returns the number of time stamps in each of the three Time Tag inputs.

Response

Returns three comma-separated integers corresponding to the number of time stamps recorded for inputs 1, 2, and 3.

The numeric range for each integer is 0 to 256.

Context Dependencies

:SYSTem:PRESet clears the time stamp measurement buffers and overflow counts.

Time stamps are not collected until after the Receiver has completed its powerup and has reached initial GPS lock.

59551A

:SENSe:DATA:POINts? . . . <i>Returns the number of time stamps recorded for the one specified Time Tag input.</i>	RESPONSE FORMAT ± dd
---	--------------------------------

This query returns the number of time stamps recorded for the one specified Time Tag input. Use "TSTamp 1", "TSTamp 2", or "TSTamp 3" to select one input.

Expanded Syntax

:SENSe:DATA:POINts? "TSTamp 1" or "TSTamp 2" or "TSTamp 3"

Response

Returns an integer corresponding to the number of time stamps recorded for the specified input.

- Numeric range is 0 to 256.

Continued on next page Æ

Event Time Stamping (59551A Only)



Reading Time Stamps _____ (continued)

Parameter

"TSTamp 1" queries for the number of points in **Time Tag 1** input buffer.

"TSTamp 2" queries for the number of points in **Time Tag 2** input buffer.

"TSTamp 3" queries for the number of points in **Time Tag 3** input buffer.

Context Dependencies

:SYSTem:PRESet clears the time stamp measurement buffers and overflow counts.

Time stamps are not collected until after the Receiver has completed its powerup and has reached initial GPS lock.

59551A

:SENSe:DATA:TSTamp? . . .

Returns a single time stamp.

RESPONSE FORMAT

\pm dd, ...

This query returns a single time stamp. Use "TSTamp 1" or "TSTamp 2" or "TSTamp 3" to select an input channel. Use *<time stamp entry>* to select a single time stamp recorded on that input.

Expanded Syntax

:SENSe:DATA:TSTamp? "TSTamp 1" or "TSTamp 2" or "TSTamp 3",
<time stamp entry>

Response

The query response represents the single time stamp requested.

The query response is a sequence of ten comma-separated integers constituting a single time stamp. The time stamp provides the year, month, day, hours, minutes, seconds, milliseconds, microseconds, nanoseconds, and TFOM (Time Figure of Merit).

For example,

:SENSe:DATA:TSTamp? "TSTamp 2", 37

Selects the 37th time stamp recorded on Time Tag Input 2.

Continued on next page



Reading Time Stamps _____ *(continued)*

Parameter

<time tag input> parameter:

- "TSTamp 1" to select Time Tag 1 input buffer.
- "TSTamp 2" to select Time Tag 2 input buffer.
- "TSTamp 3" to select Time Tag 3 input buffer.

<time stamp entry> parameter range is 1 to 256.

Context Dependencies

:SYSTEM:PRESet clears the time stamp measurement buffers and overflow counts.

Time stamps are not collected until after the Receiver has completed its powerup and has reached initial GPS lock.

Event Time Stamping (59551A Only)



Processing Memory Overflows

59551A

:SENSe:DATA:MEMory:OVERflow:COUNT?

Returns an overflow count for each of the three Time Tag inputs.

RESPONSE FORMAT

\pm d.dEe, ...

This query returns an overflow count for each of the three Time Tag inputs. An “overflow count” occurs after 256 time stamps have been recorded. When any additional events are detected at the input, the overflow count increments.

If memory management protocol has been set to “FIRST,” the first 256 time stamps are recorded. The overflow count indicates the number of time stamps which followed the last recorded stamp, and which were discarded.

If memory management protocol has been set to “LAST,” the most recent 256 time stamps are recorded. The overflow count indicates the number of stamps which were collected prior to the first recorded stamp, and which were overwritten.

Response

Returns three comma-separated floating-point numbers corresponding to the overflow count of each of the three inputs: 1, 2, 3.

Context Dependencies

:SYSTem:PRESet clears the time stamp measurement buffers and overflow counts.

Time stamps are not collected until after the Receiver has completed its powerup and has reached initial GPS lock.



Processing Memory Overflows _____ (continued)

59551A

:SENSe:DATA:MEMory:OVERflow:COUNt? . . . <i>Returns an overflow count for the selected Time Tag input.</i>	RESPONSE FORMAT ± d.dEe
--	---------------------------------------

This query returns an overflow count for the selected Time Tag input. Use "TSTamp 1", "TSTamp 2", or "TSTamp 3" to select or query one input at a time.

Expanded Syntax

:SENSe:DATA:MEMory:OVERflow:COUNt? "TSTamp 1" or "TSTamp 2" or "TSTamp 3"

Response

Returns one floating-point number corresponding to the overflow count of the selected Time Tag input.

Context Dependencies

:SYSTem:PRESet clears the time stamp measurement buffers and overflow counts.

Time stamps are not collected until after the Receiver has completed its powerup and has reached initial GPS lock.

59551A

:SENSe:DATA:MEMory:SAVE . . . <i>Sets the Receiver's memory management protocol.</i>	:SYSTem:PRESet FIRSt <hr/> NON-VOLATILE
--	--

This command sets the Receiver's memory management protocol.

Expanded Syntax

:SENSe:DATA:MEMory:SAVE FIRSt or LAST

Parameter

FIRSt retains time stamps for the first 256 events detected.

LAST retains time stamps of the last (most recent) 256 events detected.

Context Dependencies

:SYSTem:PRESet sets memory management protocol to retain time stamps for FIRSt 256 events.



Processing Memory Overflows _____ (continued)

59551A

:SENSe:DATA:MEMory:SAVE?

Returns the state of the memory management protocol.

RESPONSE FORMAT

XYZ

This query returns the state of the memory management protocol.

Response

FIRST indicates that the memory retains time stamps for the first 256 events detected.

LAST indicates that the memory retains time stamps for the last (most recent) 256 events detected.



Serial Interface Communication

The 59551A and 58503B GPS Receivers provide a set of commands that allow you to configure the serial interface port(s) for instrument communications. A set of special commands is provided for the 59551A Receiver since it has two different serial ports (PORT 1, PORT 2).

Both Receivers have the rear-panel RS-232C serial interface port (PORT 1). The 59551A has an additional front-panel RS-232C serial interface port (PORT 2).

The following commands are provided to allow you to configure the ports.

■ Configuring I/O Port 1 *<port>* = SERIAL1 or SERIAL

Configuring I/O Port 2 *<port>* = SERIAL2 (59551A Only)

```
:SYSTEM:COMMunicate?  
:SYSTEM:COMMunicate:<port>:BAUD ...  
:SYSTEM:COMMunicate:<port>:BAUD?  
:SYSTEM:COMMunicate:SERial1:BITS ... (59551A)  
:SYSTEM:COMMunicate:<port>:BITS?  
:SYSTEM:COMMunicate:<port>:FDUPlex ...  
:SYSTEM:COMMunicate:<port>:FDUPlex?  
:SYSTEM:COMMunicate:<port>:PACE ...  
:SYSTEM:COMMunicate:<port>:PACE?  
:SYSTEM:COMMunicate:<port>:PARity ...  
:SYSTEM:COMMunicate:<port>:PARity?  
:SYSTEM:COMMunicate:SERial1:SBITs ... (59551A)  
:SYSTEM:COMMunicate:<port>:SBITs?
```

■ Recovering the Last Query Response

```
:DIAGnostic:QUERy:RESPonse?
```



Configuring I/O Ports

:SYSTem:COMMunicate?
Identifies which serial port is being used.

RESPONSE FORMAT

XYZ

This query identifies which serial port is being used. Use this query when the Receiver is installed out of sight or at a remote location. The distinction between SERIAL1 and SERIAL2 is required in communication commands for setting parameters such as baud and parity.

Response

SER1 or SER2 is returned.



:SYSTem:COMMunicate:<port>:BAUD . . .
Sets the baud rate of specified port.

:SYSTem:PRESet

R, F⁼

Not affected

NON-VOLATILE

This command sets the baud rate of the specified port.

Expanded Syntax

:SYSTem:COMMunicate:SERial1:BAUD 1200 or 2400 or 9600 or 19200

:SYSTem:COMMunicate:SERial2:BAUD 1200 or 2400 or 9600 or 19200

Parameter

The possible baud rate values that can be entered are 1200, 2400, 9600, or 19200.

Context Dependencies

The baud rate value is stored in non-volatile memory. It is unaffected by powerup and :SYSTem:PRESet.

:SYSTem:COMMunicate:<port>:PRESet sets the baud rate to 9600, which is the factory-default value.

⁼ Must be received via the specified I/O port.



Configuring I/O Ports (continued)

:SYSTem:COMMunicate:<port>:BAUD? <i>Returns the baud rate of specified port.</i>	RESPONSE FORMAT R, F ±dd
--	--

This query returns the baud rate of specified port.

Expanded Syntax

:SYSTem:COMMunicate:SERial1:BAUD?

:SYSTem:COMMunicate:SERial2:BAUD?

59551A



:SYSTem:COMMunicate:SERial1:BITS ... <i>Sets the data bits value of PORT 1.</i>	:SYSTem:PRESet R Not affected
	NON-VOLATILE

This command sets the data bits of PORT 1.

Expanded Syntax

:SYSTem:COMMunicate:SERial1:BITS 7 or 8

Parameter

The possible data bits values that can be entered are 7 or 8.

Context Dependencies

The data bits value is stored in non-volatile memory. It is unaffected by powerup and :SYSTem:PRESet.

:SYSTem:COMMunicate:SERial1:PRESet sets the data bits to 8, which is the factory-default value.



Configuring I/O Ports (continued)

:SYSTem:COMMunicate:<port>:BITS? <i>Returns the data bits value of specified port.</i>	RESPONSEFORMAT R, F \pm dd
--	---

This query returns the data bits value of the specified port.

Expanded Syntax

:SYSTem:COMMunicate:SERial1:BITS?

:SYSTem:COMMunicate:SERial2:BITS?



:SYSTem:COMMunicate:<port>:FDUPlex . . . <i>Sets the duplex state of specified port.</i>	:SYSTem:PRESet R, F⁼ Not affected
	NON-VOLATILE

This command sets the duplex state of the specified port. Use this command when you cannot see on the computer screen the characters you are typing for your command.

Expanded Syntax

:SYSTem:COMMunicate:SERial1:FDUPlex ON or OFF

:SYSTem:COMMunicate:SERial2:FDUPlex ON or OFF

Parameter

ON enables echoing of the characters you type (i.e., when typing a command, the ON state allows you to see on the computer screen the characters you type).

OFF disables the echoing of the characters you type.

Context Dependencies

The duplex state is stored in non-volatile memory. It is unaffected by powerup and :SYSTem:PRESet.

SYSTem:COMMunicate:<port>:PRESet sets the duplex state to ON, which is the factory-default state.

⁼ Must be received via the specified I/O port.



Configuring I/O Ports _____ (continued)

<p>:SYSTem:COMMunicate:<port>:FDUPlex?</p> <p><i>Returns the duplex state of the specified port.</i></p>	<p>RESPONSEFORMAT R, F</p> <p>0 or 1</p>
---	--

This query returns the duplex state of the specified port.

Expanded Syntax

:SYSTem:COMMunicate:SERial1:FDUPlex?

:SYSTem:COMMunicate:SERial2:FDUPlex?

Response

A value of 0 indicates echo is OFF.

A value of 1 indicates echo is ON.



<p>:SYSTem:COMMunicate:<port>:PACE ...</p> <p><i>Sets flow control of the specified port.</i></p>	<p>:SYSTem:PRESet R, F⁼</p> <p>Not affected</p>
	<p>NON-VOLATILE</p>

This command sets flow control of the specified port.

Expanded Syntax

:SYSTem:COMMunicate:SERial1:PACE XON or NONE

:SYSTem:COMMunicate:SERial2:PACE XON or NONE

Parameter

The choices are XON or NONE.

Context Dependencies

The software pacing or flow control state is stored in non-volatile memory. It is unaffected by powerup and :SYSTem:PRESet.

:SYSTem:COMMunicate:<port>:PRESet sets the flow control to NONE, which is the factory-default state.

⁼ Must be received via the specified I/O port.



Configuring I/O Ports _____ (continued)

:SYSTem:COMMunicate:<port>:PACE? <i>Returns flow control state of the specified port.</i>	RESPONSEFORMAT R, F XYZ
---	--

This query returns the flow control state of specified port.

Expanded Syntax

:SYSTem:COMMunicate:SERial1:PACE?

:SYSTem:COMMunicate:SERial2:PACE?

Response

XON or NONE is returned.



:SYSTem:COMMunicate:<port>:PARity . . . <i>Sets parity of the specified port.</i>	:SYSTem:PRESet R, F⁼ Not affected
	NON-VOLATILE

This command sets parity of the specified port.

Expanded Syntax

:SYSTem:COMMunicate:SERial1:PARity: EVEN or ODD or NONE

:SYSTem:COMMunicate:SERial2:PARity: EVEN or ODD or NONE or ONE

Parameter

The choices for SERial1 are EVEN, ODD, or NONE.

The choices for SERial2 are EVEN, ODD, NONE, or ONE.

Context Dependencies

The parity state is stored in non-volatile memory. It is unaffected by powerup and :SYSTem:PRESet.

:SYSTem:COMMunicate:<port>:PRESet sets the parity to NONE, which is the factory-default state.

If parity is enabled, the Receiver sends/receives 7 data bits plus 1 parity bit. If parity is disabled, the Receiver sends/receives 8 data bits.

⁼ Must be received via the specified I/O port.



Configuring I/O Ports (continued)

:SYSTem:COMMunicate:<port>:PARity? <i>Returns parity setting of the specified port.</i>	RESPONSE FORMAT R, F XYZ
---	---

This query returns the parity setting of the specified port.

Expanded Syntax

:SYSTem:COMMunicate:SERial1:PARity?

:SYSTem:COMMunicate:SERial2:PARity?

Response

EVEN, ODD, NONE, or ONE is returned.



59551A

:SYSTem:COMMunicate:SERial1:SBITs ... <i>Sets the stop bits value of PORT 1.</i>	:SYSTem:PRESet R Not affected
	NON-VOLATILE

This command sets the stop bits value of PORT 1.

Expanded Syntax

:SYSTem:COMMunicate:SERial1:SBITs 1 or 2

Parameter

The possible stop bits values that can be entered are 1 or 2.

Context Dependencies

The stop bits value is stored in non-volatile memory. It is unaffected by powerup and :SYSTem:PRESet.

:SYSTem:COMMunicate:SERial1:PRESet sets the stop bits value to 1, which is the factory-default value.



Configuring I/O Ports _____ (continued)

:SYSTem:COMMunicate:<port>:SBITs?

Returns the stop bits value of the specified port.

RESPONSE FORMAT

R, F

± dd

This query returns the stop bits value of specified port.

Expanded Syntax

:SYSTem:COMMunicate:SERial1:SBITs?

:SYSTem:COMMunicate:SERial2:SBITs?



Recovering the Last Query Response

:DIAGnostic:QUERy:RESPonse?

Returns the last response item issued through the Receiver's serial interface for use in an error recovery process.

RESPONSE FORMAT

Format depends on the last issued query.

This query returns the last response item issued through the Receiver's serial interface for use in an error recovery process.

In the case of a serial interface data transmission error, this query can be used to get the last response item which may otherwise be unavailable because of the side effects of the original command. For example, the :SYST:ERRor? query removes the oldest entry from the error queue, so to see the entry again following a data transmission error, use :DIAG:QUER:RESP? instead of repeating the original command.

Response

The format depends on the last issued query.



Receiver Initialization

The following commands are provided to allow you to initialize or preset the serial interface port(s) and the Receiver to their factory shipment values.

:SYSTem:COMMunicate:SERial1:PRESet

:SYSTem:COMMunicate:SERial2:PRESet (59551A Only)

:SYSTem:PRESet

Receiver Initialization

:SYSTem:COMMunicate:<port>:PRESet <i>Sets the specified port configuration to its factory-default values.</i>	EVENT
---	--------------

This command is an event that sets specified port parameters to their factory-default values.

Expanded Syntax

:SYSTem:COMMunicate:SERial1:PRESet

:SYSTem:COMMunicate:SERial2:PRESet

Factory-Default Settings for PORT 1 of the 59551A

Parameter	Default	Possible Choices
Software Pacing	NONE	XON or NONE
Baud Rate	9600	1200, 2400, 9600, or 19200
Parity	NONE	EVEN, ODD, or NONE
Data Bits	8	7 or 8
Stop Bits	1	1 or 2
Full Duplex	ON	ON or OFF

Factory-Default Settings for PORT 1 of the 58503B and PORT 2 of the 59551A

Parameter	Default	Possible Choices
Software Pacing	NONE	XON or NONE
Baud Rate	9600	1200, 2400, 9600, or 19200
Parity	NONE	EVEN, ODD, NONE, or ONE
Data Bits	8	Fixed at 7 when parity is even or odd. Fixed at 8 when parity is none.
Stop Bits	1	Fixed (no choices available)
Full Duplex	ON	ON or OFF

Context Dependencies

The SERIAL1 preset command only is valid if transmitted on the rear-panel (PORT 1).

:SYSTem:PRESet <i>Restores the Receiver parameters settings to their factory-default values.</i>	EVENT
--	--------------

This command is an event that restores the Receiver parameters settings to their factory shipment or factory-default values (see the following Table 5-2).

NOTE

Issuing this command will result in disruption of all of the following: GPS satellite tracking, reference oscillator frequency, 1 PPS output timing, and Receiver status information.

Receiver Initialization

Table 5-2. System Preset (Factory Default) Parameter Settings Summary

Commands	:SYSTem:PRESet
ESE ...	0 (NV []) — See footnotes on the bottom of the next page
*SRE ...	136 (NV)
:DIAGnostic:LOG:CLEAr	Log is cleared.
:DIAGnostic:LOG:COUNT?	2
:DIAGnostic:QUERy:RESPonse?	cleared.
:FORMat:DATA ...	ASCII (NV)
:GPS:POSition ...	N,0,0,0,E,0,0,0,0 (NV) LAST is also set to this position. (NV)
:GPS:POSition:HOLD:LAST?	N,0,0,0,E,0,0,0,0 (NV)
:GPS:POSition:HOLD:STATe?	0 (NV)
:GPS:POSition:SURVey:STATe ...	ONCE
:GPS:POSition:SURVey:STATe:POWerup ...	ON (NV)
:GPS:REFerence:ADELay ...	0.0 (NV)
:GPS:SATEllite:TRACking:EMANgle ...	10 (NV)
:GPS:SATEllite:TRACking:IGNore:STATe? ...	0 for every PRN.
:GPS:SATEllite:TRACking:IGNore ...	No satellites ignored (NV)
:GPS:SATEllite:TRACking:INCLude ...	All satellites included (NV)
:GPS:SATEllite:TRACking:INCLude:STATe? ...	1 for every PRN.
:PTIME:TZONE ...	0,0 (NV)
:PULSE:CONTInuous:PERiod ...	1 (NV)
:PULSE:CONTInuous:STATe ...	OFF (NV)
:PULSE:STARt:DATE ...	1994,1,1 (NV)
:PULSE:STARt:TIME ...	0,0,0 (NV)
:SENSe:DATA?	Data is cleared.
:SENSe:DATA:MEMory:OVERflow:COUNT?	All counts are cleared (V ^{**}).
:SENSe:DATA:MEMory:SAVE ...	FIRSt (NV)
:SENSe:DATA:POINts?	All responses become 0 (zero). (V)
:SENSe:DATA:TSTamp? ...	All timestamps cleared.

Receiver Initialization**Table 5-2. System Preset (Factory Default) Parameter Settings Summary (Continued)**

Commands	:SYSTem:PRESet
:STATus:OPERation:ENABle ...	36 (NV)
:STATus:OPERation:HARDware:ENABle ...	8191 (NV)
:STATus:OPERation:HARDware:NTRansition ...	0 (NV)
:STATus:OPERation:HARDware:PTRansition ...	5119 (NV)
:STATus:OPERation:HOLDover:ENABle ...	8 (NV)
:STATus:OPERation:HOLDover:NTRansition ...	0 (NV)
:STATus:OPERation:HOLDover:PTRansition ...	15 (NV)
:STATus:OPERation:NTRansition ...	0 (NV)
:STATus:OPERation:POWerup:ENABle ...	7 (NV)
:STATus:OPERation:POWerup:NTRansition ...	0 (NV)
:STATus:OPERation:POWerup:PTRansition ...	7 (NV)
:STATus:OPERation:PTRansition ...	127 (NV)
:STATus:QUEStionable:CONDition:USER ...	Cleared (NV)
:STATus:QUEStionable:ENABle ...	3 (NV)
:STATus:QUEStionable:NTRansition ...	0 (NV)
:STATus:QUEStionable:PTRansition ...	2 (NV)
:SYNChronization:HOLDover:DURation?	0,0 (Even if there was a prior holdover, its duration will be lost.)
:SYNChronization:HOLDover:DURation:THReshold ...	86400 (that is, 1 day), (NV)
:SYNChronization:STATe?	POWerup
:SYSTem:ERRor?	Error queue is cleared.
:SYSTem:LANGuage ...	"PRIMARY"

* NV stands for non-volatile memory.

** V stands for volatile memory.



Receiver Identification/Upgrade

The commands provided in this section allow you to query the identification of the Receiver, and to perform firmware upgrades in the field after you obtain a new firmware disk.

■ Reading Product Identification

*IDN?

■ Installing Firmware via I/O PORT 1

*CLS

:DIAGnostic:DOWNload ...

:DIAGnostic:ERASe

:DIAGnostic:ERASe?

:SYSTem:ERRor?

:SYSTem:LANGuage ...

:SYSTem:LANGuage?



Reading Product Identification



*IDN? <i>Returns the Receiver identification.</i>	RESPONSE FORMAT ASCII Data
---	--------------------------------------

This query returns the Receiver identification.

Response

- A sequence of ASCII-encoded bytes:
HEWLETT-PACKARD, 59551A, XXXXYZZZZZ, WWWW – V
where 59551A is the product model number, XXXXYZZZZZ is the product serial number, and WWWW is the product's firmware revision date code, and V is the hardware revision letter.
In the product serial number (XXXXYZZZZZ):
 - XXXX is a four-digit prefix that identifies a series of instruments.
 - Y identifies the country in which the instrument was manufactured (e.g., the “A” in 3426A000123 stands for America).
 - ZZZZZ is a five-digit suffix that identifies a particular instrument within a series.
- For example,
HEWLETT-PACKARD, 59551A,3426A00123,3422 – A
This query should be the last query in a terminated program message; otherwise, **error -440** is generated.

Context Dependencies

Preparatory to installation of new product firmware, the instrument is switched to the “INSTALL” language, available only on PORT 1. The “INSTALL” language includes an *IDN? query which returns the revision identification for the installation firmware. The response format is the same as described above for the instrument's “PRIMARY” language, but the identification code may be different.



Installing Firmware via I/O PORT 1 _____

The commands in this section represent the command set of the “INSTALL” language. The “INSTALL” language is part of a highly-specialized set of features used to erase the Receiver’s firmware, and to install a new firmware revision. It should be selected only when firmware installation is required.

The “INSTALL” language offers the limited number of commands and queries which are documented in this section. This set is designed to provide the Receiver status and control capability required during firmware upgrade.

NOTE

The SatStat program provides a Service menu which automates firmware installation.

<p>*CLS <i>Clears errors.</i></p>	<p style="text-align: right;">R</p> <p style="text-align: center;">EVENT</p>
---	--

This command clears errors.

<p>:DIAGnostic:DOWNload . . . <i>Sends down a Motorola®S-record.</i></p>	<p style="text-align: right;">R</p> <p style="text-align: center;">EVENT</p>
--	--

This command sends down a Motorola® S-record.

Expanded Syntax

:DIAGnostic:DOWNload <Motorola S-record>



<p>:DIAGnostic:ERASe <i>Erases the flash EEPROM.</i></p>	<p style="text-align: right;">R</p> <p style="text-align: center;">EVENT</p>
--	--

This command erases the flash EEPROM. It should ONLY be sent to the Receiver as a preparatory step during firmware upgrade. Erasing flash EEPROM will disable the instrument until flash EEPROM is reloaded with factory-supplied instrument firmware.



Installing Firmware via I/O Port 1 _____ (continued)

<p>:DIAGnostic:ERASe? <i>Verifies flash EEPROM has been erased.</i></p>	<p>RESPONSE FORMAT R 0 or 1</p>
---	---

This query verifies the flash EEPROM has been erased.

Response

A value of 1 indicates that flash EEPROM has been erased.

This condition normally occurs when the instrument software in flash EEPROM is erased in preparation for installation of a more recent software revision. That is, after command :DIAG:ERASe has been issued and erase is complete, the :DIAG:ERASe? query response is "1".



<p>:SYSTem:ERRor? <i>Returns the oldest error in the Error Queue and removes that error from the queue (first in, first out).</i></p>	<p>RESPONSE FORMAT R ± dd, "XYZ"</p>
---	--

This query returns the oldest error in the Error Queue and removes that error from the queue (first in, first out).

See Appendix A, "Error Messages," in this guide for detailed error information.

Response

The error response format is: <error_number>,"<error_description>", where

- The <error_number> is an integer transferred as ASCII bytes in <NR1> format (integer). The range is -32768 to 32767.
- Negative error numbers are defined by the SCPI standard.
- Positive error numbers are defined specifically for this Receiver.
- An error number value of zero indicates that the Error Queue is empty.
- The maximum length of the <error_description> is 255 characters.

Continued on next page **Ë**



Installing Firmware via I/O Port 1 _____ (continued)

Context Dependencies

:SYSTem:PRESet clears the Error Queue.

The queue is cleared (emptied) on *CLS, power-on, or upon reading the last error from the queue.

If the Error Queue overflows, the last error in the queue is replaced with the **error -350, "Queue overflow"**. Any time the queue overflows, the least recent errors remain in the queue and the most recent error is discarded.

The maximum length of the Error Queue is 30.

:SYSTem:LANGUage . . . <i>Switches the operation mode (primary or install) of the Receiver.</i>	:SYSTem:PRESet
	"PRIMARY"
	NON-VOLATILE

This command switches the operation mode (primary or install) of the Receiver.

Expanded Syntax

:SYSTem:LANGUage "INSTALL" or "PRIMARY".

Parameter

The "INSTALL" language is part of a highly-specialized set of features used to erase the Receiver's firmware, and to install a new firmware revision. It should be selected only when firmware installation is required.

The "INSTALL" language offers the limited number of commands and queries which are documented in this section. This set is designed to provide the Receiver status and control capability required during firmware upgrade.

NOTE

The SatStat program provides a Service menu which automates firmware installation.

The "PRIMARY" language provides the capabilities required for normal Receiver operation. If the "INSTALL" language has been selected as part of the firmware upgrade, the "PRIMARY" language should be selected after the upgrade to restore normal operation.



Installing Firmware via I/O Port 1 _____ (continued)

:SYSTem:LANGUage? <i>Identifies the operation mode (primary or install) of the Receiver.</i>	RESPONSE FORMAT R "XYZ"
--	---------------------------------------

This query identifies the operation mode (primary or install) of the Receiver.

Response

"INSTALL" or "PRIMARY" is returned.

A

Error Messages

Introduction

Introduction

This appendix explains how to read any errors from the Receiver, discusses the error queue, types of errors and general error behavior, and provides a table of all of the Receiver's errors and their probable causes.

Reading an Error

Executing the `:SYSTEM:ERROR?` command reads the oldest error from the error queue and erases that error from the queue. The `:SYST:ERR?` response has the form:

<error number>, <error string>

An example response is:

-113,"Undefined header"

Positive error numbers are specific to the Receiver. Negative error numbers are command language related and are discussed later in this appendix.

All errors set a corresponding bit in the Standard Event Status Register (see Figure 5-1).

Error Queue

As errors are detected, they are placed in an error queue. This queue is first in, first out. That is, if there has been more than one error, the first one in the queue is read out with `:SYST:ERR?`. Subsequent responses continue until the queue is empty.

If the error queue overflows, the last error in the queue is replaced with **error -350, "Queue overflow"**. Any time the queue overflows, the least recent errors remain in the queue, and the most recent error is discarded. The length of the Receiver's error queue is 30 (29 positions for the error messages, and 1 position for the "Queue overflow" error). Reading an error from the head of the queue removes that error from the queue, and opens a position at the tail of the queue for a new error, if one is subsequently detected.

When all errors have been read from the queue, further error queries return **+0, "No error"**.

The error queue is cleared when any of the following occur:

- Upon power-on.
- Upon receipt of a `*CLS` command.
- Upon reading the last item from the queue.

Error Types

Error Types

Error numbers are categorized by type as shown in Table A-1. Each error is listed in Table A-2.

Table A-1. Error Types

Error Number	Error Type
+0	No Error
-100 to -199	Syntactic Errors
-200 to -299	Semantic Errors
-300 to -350	Hardware/Firmware Errors
-400 to -499	Query Errors

The first error described in each class (for example, -100, -200, -300, -400) is a “generic” error.

No Error

The :SYST:ERR? response **+0, "No error"** indicates that the Receiver has no errors. The error queue is empty when every error in the queue has been read (:SYST:ERR? query) or the queue was cleared by power-on or *CLS.

Syntactic Error

An <error number> in the range [-100 to -199] indicates that an IEEE 488.2 syntax error has been detected by the Receiver’s parser.

The occurrence of any error in this class causes the syntactic error bit (bit 5) in the Event Status Register to be set. One of the following events has occurred:

- An IEEE 488.2 syntax error has been detected by the parser. That is, a controller-to-Receiver message was received that is in violation of the IEEE 488.2 Standard. Possible violations include a data element that violates the Receiver listening formats or whose type is unacceptable to the Receiver.
- An unrecognized header was received. Unrecognized headers include incorrect Receiver-specific headers and incorrect or unimplemented IEEE 488.2 Common Commands.

Events that generate syntactic errors do not generate semantic errors, hardware/firmware errors, or query errors.

Error Types

Semantic Error

An <error number> in the range [-200 to -299] indicates that an error has been detected by the Receiver's execution control block.

The occurrence of any error in this class causes the semantic error bit (bit 4) in the Event Status Register to be set. One of the following events has occurred:

- A <PROGRAM DATA> element following a header was evaluated by the Receiver as outside of its legal input range or is otherwise inconsistent with the Receiver's capabilities.
- A valid program message could not be properly executed due to some Receiver condition.

Semantic errors are reported by the Receiver after rounding and expression evaluation operations have been taken place. Rounding a numeric data element, for example, is not reported as a semantic error. Events that generate semantic errors do not generate syntactic errors, hardware/firmware errors, or query errors.

Hardware/Firmware Error

An <error number> in the range [-300 to -399] or [+1 to +32767] indicates that the Receiver has detected an error that is not a syntactic error, a query error, or a semantic error; some Receiver operations did not properly complete, possibly due to an abnormal hardware or firmware condition. These codes are also used for self-test response errors. The occurrence of any error in this class causes the hardware/firmware error bit (bit 3) in the Event Status Register to be set.

Query Error

An <error number> in the range [-400 to -499] indicates that the output queue control of the Receiver has detected a problem with the message exchange protocol. The occurrence of any error in this class should cause the query error bit (bit 2) in the Event Status Register to be set. One of the following is true:

- An attempt is being made to read data from the output queue when no output is either present or pending.
- Data in the output queue has been lost.

General Error Behavior

For Commands (i.e., non-query; doesn't provide a response):

- For any command that has numeric parameters, if the value is out of range (beyond either the min or max allowed settings), the value will be clipped to the appropriate limit and **error -222** will be generated (data out-of-range error) as an indication that the value wasn't set to the requested value.

There are some commands having numeric parameters where the clipping behavior described above doesn't make sense. These include the satellite include and ignore commands, and the status system mask commands. For these commands, an out-of-bounds value is ignored and **error -222** is generated. Also, a single out-of-bounds value may cause the entire command to be ignored. For example, `GPS:SAT:TRAC:INCL 3,87,5` will be entirely ignored because 87 is out-of-range (i.e., 3 and 5 do not become included even though they are in-range).

- Commands with multiple numeric parameters can produce multiple errors. For example, if the initial date command is sent as `GPS:INIT:TIME 25,66,-7`, the actual programmed value will be 23:59:00 (23 is max hour, 59 is max minute, 0 is min second) and three out-of-range errors will be generated. As always, only a single prompt will be returned, but in this case three errors will be in the error queue (de-queued via `SYST:ERR?` or `*CLS`).
- Numeric parameters between in-range values are rounded to the closest value. For example, sending `GPS:REF:ADEL 1.7 ns` will set the antenna delay to 2 ns.

For Queries (response-generating commands)

- If the query produces an error, there will not be a response (other than the prompt that always occurs).
- If the query includes a numeric parameter, and that parameter is out of range, **error -222** will be generated and there won't be a response (this is consistent with the prior bullet). An example of this would be `DIAG:LOG:READ? 25` when there are fewer than 25 messages in the log. Note that for this specific example, to get the most recent log entry, simply use `DIAG:LOG:READ?`.
- Another way you can view this: if you get a query response you can know that it is responding precisely to the question asked by the query.

List of Errors

List of Errors

Table A-2 lists and describes the error messages

Table A-2. Error Messages

Number	Error String	Cause
+0	No error	The error queue is empty. Every error in the queue has been read (SYSTEM:ERRor? query) or the queue was cleared by power-on or *CLS.
-100	Command error	This is the generic syntax error used if the Receiver cannot detect more specific errors.
-101	Invalid character	A syntactic element contains a character that is invalid for that type.
-102	Syntax error	An unrecognized command or data type was encountered.
-103	Invalid separator	The parser was expecting a separator and encountered an illegal character.
-104	Data type error	The parser recognized a data element different than one allowed. For example, numeric or string data was expected, but block data was received.
-108	Parameter not allowed	More parameters were received than expected for the header.
-109	Missing parameter	Fewer parameters were received than required for the header.
-112	Program mnemonic too long	The header or character data element contains more than twelve characters.
-113	Undefined header	The header is undefined. For example, the command ":HELLO".
-120	Numeric data error	This error, as well as errors -121 through -129, is generated when parsing a data element which appears to be numeric. This particular error message is used when the Receiver cannot detect a more specific error.
-121	Invalid character in number	An invalid character for the data type being parsed was encountered. For example, a "9" in octal data.
-123	Exponent too large	Numeric overflow.
-124	Too many digits	The mantissa of a decimal numeric data element contained more than 255 digits excluding leading zeros.
-128	Numeric data not allowed	A legal numeric data element was received, but the Receiver does not accept one in this position for the header.
-131	Invalid suffix	The suffix does not follow the syntax described in IEEE 488.2 or the suffix is inappropriate for the Receiver.
-134	Suffix too long	The suffix contained more than 12 characters.
-138	Suffix not allowed	A suffix was encountered after a numeric element that does not allow a suffix.
-141	Invalid character data	The character data element contains an invalid character.
-148	Character data not allowed	A legal character data element was encountered where prohibited by the Receiver.
-150	String data error	This error can be generated when parsing a string data element. This particular error message is used if the Receiver cannot detect a more specific error.
-151	Invalid string data	A string data element was expected but was invalid for some reason.
-158	String data not allowed	A string data element was encountered but was not allowed by the Receiver at this point in parsing.
-170	Expression error	This error can be generated when parsing an expression data element. It is used if the Receiver cannot detect a more specific error.

Appendix A Error Messages

List of Errors

Table A-2. Error Messages (Continued)

Number	Error String	Cause
-178	Expression data not allowed	Expression data was encountered but was not allowed by the Receiver at this point in parsing.
-200	Execution error	This is the generic syntax error if the Receiver cannot detect more specific errors.
-220	Parameter error	Indicates that a program data element error occurred. This error is used when the Receiver cannot detect more specific errors.
-221	Settings conflict	Indicates that a legal program data element was parsed but could not be executed due to the current Receiver state.
-222	Data out of range	Indicates that a legal program data element was parsed but could not be executed because the interpreted value is outside the legal range defined by the Receiver.
-223	Too much data	Indicates that a legal program data element of block, expression, or string type was received that contained more data than the Receiver could handle due to memory or related receiver-specific requirements.
-224	Illegal parameter value	Used where exact value, from a list of possible values, was expected (but not received).
-230	Data corrupt or stale	No valid data available.
-240	Hardware error	Indicates that a legal program command or query could not be executed because of a hardware problem in the Receiver.
-241	Hardware missing	Indicates that a legal program command or query could not be executed because of missing Receiver hardware.
-300	Device-specific error	This is the generic device-dependent error.
-310	System error	Indicates that a system error occurred.
-311	Memory error	Occurs on EEPROM write failure.
-315	Configuration memory lost	Could happen on powerup or preset if a nonvolatile memory problem is detected.
-321	Out of memory	Indicates that the Receiver has detected that insufficient memory is available.
-330	Self-test failed	Indicates at least one failure occurred when *TST? or :DIAG:TEST? was executed.
-350	Queue overflow	An error occurred but was not recorded because the error queue is full.
-360	Communication error	This is the generic communication error for devices that cannot detect the more specific errors described for errors -361 through -363.
-361	Parity error in program message	Parity bit not correct when data received for example, on a serial port.
-362	Framing error in program message	A stop bit was not detected when data was received. For example, on a serial port (for example, a baud rate mismatch).
-363	Input buffer overrun	Software or hardware input buffer on serial port overflows with data caused by improper or nonexistent pacing.
-440	Query UNTERMINATED after indefinite response	Indicates that a query was received in the same program message after a query requesting an indefinite response (e.g., *IDN? or :PTIM:TCOD? or :SYST:STAT?).

B

Command Syntax and Style

Appendix Contents

This appendix provides an overview of the Standard Commands for Programming Instrument (SCPI) syntax and style to help you program the Receiver. A section that lists SCPI reference documentation is also provided.

This appendix is organized as follows:

- Command Types, Format, and Elements page B-3
 - Command Types page B-3
 - Command Formats page B-3
 - Elements of SCPI Commands page B-4
 - Using Multiple Commands page B-7
 - Elements of Response Messages page B-9
- Reference Documentation page B-12

Command Types, Format, and Elements

Command Types

There are two types of GPS Receiver programming commands: IEEE 488.2 Common Commands and Standard Commands for Programmable Instruments (SCPI). The IEEE 488.2 Common Commands control and manage communications between the Receiver and the controller, terminal, or personal computer. The SCPI commands control instrument functions. The format of each type of command is described in the following paragraphs.

Command Formats

Common Command Format

The IEEE 488.2 Standard defines the Common commands as commands that perform functions like reset, self-test, status byte query, and identification. Common commands always begin with the asterisk (*) character, and may include parameters. The command keyword is separated from the first parameter by a space character. Some examples of Common commands are as follows:

*IDN? *ESE 32

SCPI Command and Query Format

SCPI commands perform functions like instrument setup. A subsystem command has a hierarchical structure that usually consists of a top level (or root) keyword, one or more lower-level keywords, and parameters. The following example shows a command and its associated query:

:GPS:POSition:SURVey:STATe ONCE
:GPS:POSition:SURVey:STATe?

GPS is a root-level keyword with POSition the second-level keyword, SURVey the third-level keyword, and STATe the fourth-level. ONCE is the command parameter.

Elements of SCPI Commands

A program command or query is composed of functional elements that include a header (keywords with colon separators), program data, and terminators. These elements are sent to the Receiver over the serial interface as a sequence of ASCII characters. Examples of a typical Common Command and Subsystem Command are:

```
*CLS  
:SYST:ERR?
```

Common Command Syntax

Figure B-1 shows the simplified syntax of a Common Command. You must use a space (SP) between the command mnemonic and the parameter in a Common Command.

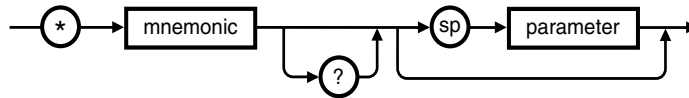

NOTE: sp = space. ASCII character decimal 32

Figure B-1. Simplified Common Command Syntax Diagram

Subsystem Command Syntax

Figure B-2 shows the simplified syntax of a Subsystem Command. You must use a space (SP) between the last command mnemonic and the first parameter in a Subsystem Command. Note that if you send more than one parameter with a single command, you must separate adjacent parameters with a comma.

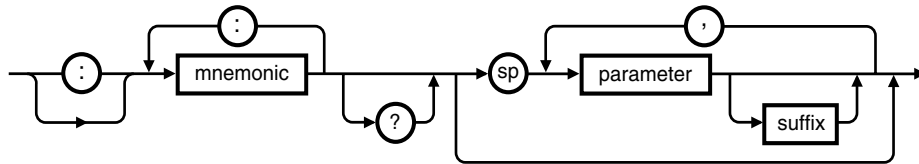

NOTE: sp = space. ASCII character decimal 32

Figure B-2. Simplified Program Command Syntax Diagram

Abbreviated Commands

The command syntax shows most keywords as a mixture of upper and lower case letters. Upper case letters indicate the abbreviated spelling for the command. For better program readability, you may send the entire keyword. The Receiver accepts either command form and is not case sensitive.

For example, if the command syntax shows SYNChronization, then SYNC and SYNCHRONIZATION are both acceptable forms. Other forms of SYNChronization, such as SYNCHR or SYNCHRONIZ will generate an error. You may use upper and/or lower case letters. Therefore, SYNCHRONIZATION, synchronization, SyNchRONizatioN, and SYnC are all acceptable.

Keyword Separator

A colon (:) always separates one keyword from the next lower-level keyword as shown below:

:SYST:ERR?

Parameter Data Types

Table B-1 contains explanations and examples of parameter types. Parameter types may be numeric value, Boolean, literal, NRf, string, or non-decimal numeric.

Table B-1. Command and Query Parameter Types

TYPE	EXPLANATIONS AND EXAMPLES
<numeric value>	<p>Accepts all commonly used decimal representation of numbers including optional signs, decimal points, and scientific notation: 123, 123e2, -123, -1.23e2, .123, 1.23e-2, 1.23000E-01.</p> <p>Special cases include MINimum and MAXimum as follows: MINimum selects minimum value available. MAXimum selects maximum value available.</p> <p>Queries using MINimum or MAXimum return the associated numeric value.</p>
<Boolean>	<p>Represents a single binary condition that is either true or false: 1 or ON, 0 or OFF (Query response returns only 1 or 0.)</p> <p>An <NRf> is rounded to an integer. A non-zero value is interpreted as 1.</p>
<literal>	<p>Selects from a finite number of choices. These parameters use mnemonics to represent each valid setting. An example of a <literal> parameter is: GPS</p>
<NRf>	<p>Flexible numeric representation. Only positive integers are used for NRf parameters in the instrument.</p>
<string>	<p>A string parameter is delimited by either single quotes or double quotes. Within the quotes, any characters in the ASCII B-bit code may be specified.</p>
<non-decimal numeric>	<p>Format for specifying hexadecimal (#H1F), octal (#Q1077), and binary (#B10101011) numbers using ASCII characters. May be used in :STATus subsystem commands.</p>

Parameter Separator

If you send more than one parameter with a single command, you must separate adjacent parameters with a comma.

Query Parameters

All selectable <numeric value> parameters can be queried to return the minimum or maximum values they are capable of being set to by sending a MINimum or MAXimum parameter after the “?”
For example, consider the :GPS:REF:ADEL? query.

If you send the query without specifying a parameter (:GPS:REF:ADEL?), the present antenna delay value is returned. If you send the MIN parameter (using :GPS:REF:ADEL? MIN), the command returns the minimum value currently available. If you send the MAX parameter, the command returns the maximum value currently available. Be sure to place a space between the question mark and the parameter.

Suffixes

A suffix is the combination of suffix elements and multipliers that can be used to interpret the <numeric value> sent. If a suffix is not specified, the Receiver assumes that <numeric value> is unscaled (that is, Volts, seconds, etc.)

For example, the following two commands are equivalent:

```
:GPS:REF:ADELay 100 NS  
:GPS:REF:ADELay 100E-9
```

Suffix Elements

Suffix elements, such as HZ (Hertz), S (seconds), V (Volts), OHM (Ohms), PCT (percent), and DEG (degrees) are allowed within this format.

Suffix Multipliers

Table B-2 lists the suffix multipliers that can be used with suffix elements (except PCT and DEG).

Table B-2. Suffix Multipliers

DEFINITION	MNEMONIC	NAME
1E9	G	GIGA
1E6	MA (or M for OHM and HZ)*	MEGA
1E3	K	KILO
1E-3	M (except for OHM and HZ)*	MILLI
1E-6	U	MICRO
1E-9	N	NANO
1E-12	P	PICO

* The suffix units, MHZ and MOHM, are special cases that should not be confused with <suffix multiplier>HZ and <suffix multiplier>OHM.

Command Terminator

A command may be terminated with a line feed (ASCII LF character 10 decimal), a carriage return (ASCII CR character 13 decimal), or one followed immediately by the other in any order.

Using Multiple Commands

Program Messages

Program Messages are a combination of one or more properly formatted SCPI Commands. Program messages always go from the DTE to the Receiver. They are sent to the Receiver over the Receiver's serial interface as a sequence of ASCII characters.

Program Message Syntax

Figure B-3 shows the simplified syntax of a program message. You can see Common Commands and Subsystem Commands in the same program message. If you send more than one command in one message, you must separate adjacent commands with a semicolon.

Appendix B Command Syntax and Style
Command Types, Format, and Elements

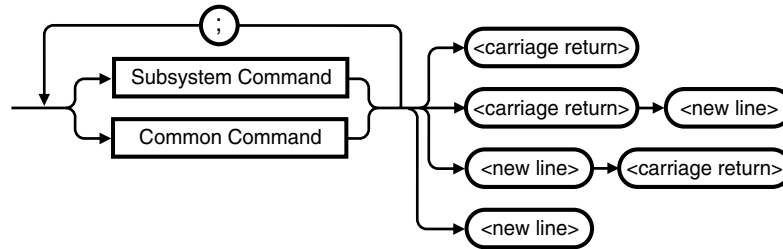

NOTE:
 <new line> = ASCII character decimal 10
 <carriage return> = ASCII character decimal 13

Figure B-3. Simplified Program Message Syntax Diagram

When using IEEE 488.2 Common commands with SCPI Subsystem commands on the same line, use a semicolon between adjacent commands. For example:

*CLS;:SYST:ERR?

When multiple SCPI Subsystem commands are sent in one program message, the first command is always referenced to the root node. Subsequent commands, separated by “;”, are referenced to the same level as the preceding command if no “:” is present immediately after the command separator (the semicolon).

For example, sending

:GPS:INIT:DATE 1994,7,4;TIME 12,34,56

is equivalent to sending:

:GPS:INIT:DATE 1994,7,4

:GPS:INIT:TIME 12,34,56

or

:GPS:INIT:DATE 1994,7,4;:GPS:INIT:TIME 12,34,56

The “:” must be present to distinguish another root level command. For example:

:SYNC:HOLD:DUR?;:GPS:SAT:VIS:PRED?

is equivalent to sending:

:SYNC:HOLD:DUR?

:GPS:SAT:VIS:PRED?

Appendix B Command Syntax and Style

Command Types, Format, and Elements

If the “.”(which is following the “;” and is in front of GPS) is omitted, the Receiver assumes that the second command is

```
:SYNC:HOLD:GPS:SAT:VIS:PRED?
```

and generates a syntax error.

Elements of Response Messages

Response Messages

Response messages are data sent from the Receiver to the DTE in response to a query. (A query is a command followed by a question mark. Queries are used to find out how the Receiver is currently configured and to transfer data from the Receiver to the DTE.)

After receiving a query, the Receiver interrogates the requested configuration and issues its response message as soon as possible. The message is transmitted across the serial interface to the DTE.

Response Message Syntax

Figure B-4 shows the simplified syntax of a Response Message. Response messages may contain both commas and semicolon separators. When a single query command returns multiple values, a comma is used to separate each item. When multiple queries are sent in the same program message, the groups of data corresponding to each query are separated by a semicolon.

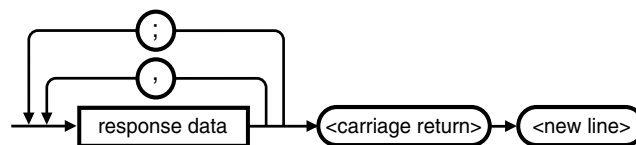

NOTE:

<new line> = ASCII character decimal 10

<carriage return> = ASCII character decimal 13

; = multiple response separator (ASCII character decimal 59)

, = data separator within a response (ASCII character decimal 44)

Figure B-4. Simplified Response Message Syntax Diagram

Appendix B Command Syntax and Style
Command Types, Format, and Elements

Response Formats

Table B-3 contains explanations of response formats.

Table B-3. Response Formats

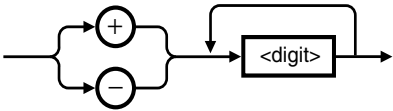
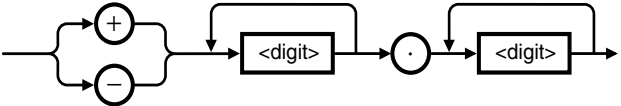
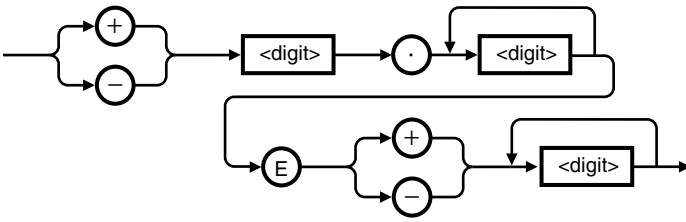
Format	Description
$\pm \mathbf{dd}$	<p>This numeric format represents an integer (e.g., +9).</p>  <p>The maximum number of characters in $\pm \mathbf{dd}$ response data is 17 (maximum 16 digits, 1 sign).</p>
$\pm \mathbf{dd}, \dots$	<p>This numeric format represents a comma-separated list of integers (e.g., +1,+2,+3).</p>
$\pm \mathbf{d.d}$	<p>This numeric format represents a fixed (e.g., +10.5).</p> 
$\pm \mathbf{d.dEe}$	<p>This numeric format represents a floating-point number (e.g., +1.00E+000).</p>  <p>The maximum number of characters in $\pm \mathbf{d.dEe}$ response data is 13 (maximum 6 mantissa digits, 2 signs, 1 decimal point, 1 'E' character, 3 exponent digits).</p>
$\pm \mathbf{d.dEe},$	<p>This numeric format represents comma-separated list of floating-numbers (e.g., +1.00000E-009, +2.00000E-009, +5.00000E-009).</p>
0 or 1	<p>A single ASCII-encoded byte, 0 or 1, is returned for the query of settings that use ON, OFF, 1, or 0 parameters.</p>

Appendix B Command Syntax and Style
Command Types, Format, and Elements

Table B-3. Response Formats (Continued)

Format	Description
XYZ	<p>ASCII-encoded bytes corresponding to the literal used as the command parameter.</p> <div data-bbox="797 457 1177 600" data-label="Diagram"> </div> <p>An example of an alphanumeric response is: NONE</p>
“XYZ”	<p>A string response consists of ASCII characters enclosed by double quotes. For example, string data is used for the “<error description>” portion of :SYST:ERR? response.</p>
“XYZ”, ...	<p>A list of string responses consist of comma-separated ASCII characters enclosed by double quotes. (e.g., “log 224:19951017.00:00:26:30: Holdover started, GPS”, “log 225:19951017.00:00:29:02: GPS lock started”)</p>
ASCII Data	<p>A sequence of ASCII-encoded bytes.</p>
Binary Data	<p>The syntax is a pound sign (#) followed by a non-zero digit representing the number of digits in the subsequent decimal integer. The decimal integer specifies the number of 8-bit data bytes being sent. This is followed by the actual data. The terminator is a line feed. For example, for transmitting 8 bytes of data, the format might be:</p> <div data-bbox="711 1213 1258 1390" data-label="Diagram"> </div> <p>The “2” indicates the number of digits that follow and the two digits “08” indicate the number of <i>data</i> bytes to be transmitted. <carriage return> is defined as a single ASCII-encoded byte corresponding to 13 decimal. <new line> is defined as a single ASCII-encoded byte corresponding to 10 decimal.</p>

Reference Documentation

This section contains a list of documentation related to the use of the Receiver's RS-232C serial port. Additional information that you may find useful can be found in the following publications:

1. **Beginner's Guide to SCPI (HP Part Number H2325-90001, July 1990 Edition).**
2. **Beginner's Guide to SCPI, Barry Eppler (Hewlett-Packard Press, Addison-Wesley Publishing Co. 1991).**
3. **Standard Commands for Programmable Instruments (SCPI), Version 1992.0.**

This standard is a guide for the selection of messages to be included in programmable instrumentation. It is primarily intended for instrument firmware engineers. However, you may find it useful if you are programming more than one instrument that claims conformance to the SCPI standard. You can verify the use of standard SCPI commands in different instruments.

To obtain a copy of this standard, contact:

SCPI Consortium
8380 Hercules, Suite P3
La Mesa, CA 91942
Phone: (619) 697-8790
FAX: (619) 697-5955

4. **The International Institute of Electrical Engineers and Electronic Engineers, IEEE Standard 488.2-1987, IEEE Standard Codes, Formats, Protocols, and Common Commands for Use with ANSI/IEEE Std 488.1-1987 Programmable Instrumentation.**

This standard defines the underlying message formats and data types used in SCPI. It is intended more for firmware engineers than for instrument users/programmers. However, it can be useful if you need to know the precise definition of specific message formats, data type, or common commands.

To obtain a copy of this standard, write to:

The Institute of Electrical and Electronic Engineers Inc.
345 East 47th Street
New York, NY 10017 USA

C

Receiver Firmware Installation

Downloading New Firmware Using SatStat Program

- 1 Copy the file of the updated firmware disk to a directory on your PC disk drive.

If you haven't already installed SatStat, you should install it now (follow instructions on the disk label or in the section titled "To Install the Automated SatStat Program for Continual Status Updates" in Chapter 3, "Visual User Interface," of this guide).

- 2 Start SatStat (easiest way is to double-click on the icon).
- 3 You should establish communication with the GPS Receiver. This requires connection from a serial RS-232 port on your PC to the GPS Receiver's serial port (a 25-pin RS-232 connection). Assuming you've got the cable attached to make this connection, you may want to check the settings.

- a. Select **CommPort**, then choose **Settings**.

The Communication Settings dialog box is displayed. Unless someone has reprogrammed the CommPort settings on the GPS Receiver, these settings are probably OK. *The one setting that is likely to need changing is the Com Port. The application defaults it to Com1, but the serial port on your PC may be assigned to a different Com Port. Select the appropriate setting. If you are unsure, Com1 will be your best bet (worst case, you can cycle through all of them until it works).*

- b. If you made any changes on this form, select **OK**, otherwise you can just **Cancel**.

- 4 Select **CommPort**, then choose **Port Open**.

The main form of the Receiver Status screen is displayed. The application will send some commands to the GPS Receiver and then the main form should begin to periodically update every few seconds. If you are getting screen updates, proceed to the next step. Otherwise, something is wrong with your CommPort settings or perhaps the physical connection between your PC and the GPS Receiver.

Downloading New Firmware Using SatStat Program

NOTE

Prior to download, interrogate the product, record any custom configuration parameters. This step is necessary because downloading new instrument firmware will reset all parameters to system-preset defaults. Parameters typically recorded include:

- *antenna delay*
- *elevation mask angle*
- *timezone offset*

A table of all system-preset defaults is printed in Table 5-2 on page 5-111 in Chapter 5 of this guide; refer to it to identify additional parameters whose default values are inappropriate for your application. Record the settings you use prior to download.

- 5 Performing the download works best if the periodic updates are disabled. On the main form, select the **Function** menu, choose **Status** (check mark appears), and choose **Disable Updates** (check mark appears).
- 6 Activate the form titled “Control & Query” by clicking anywhere on it. Select **Service**, then choose **Download Firmware**. This will bring up a form titled “Firmware Download”.
- 7 Now you need to select the file that you will download. Select the control labeled **File**.

This brings up a form for file selection. Download files for the GPS Receiver have a .s appended to the file name. This form is set to only find .s type files. In this case, you want to find and select the filename, for example **s_3503.s**. Depending on where you have placed this file, you may have to use this form to navigate for it. If it is on a different drive, use the Drives selection in the lower right. Once you’ve located **s_3503.s** select it (clicking on the name is probably the easiest) and then select **OK**. The file, along with its path should now appear in the “File to Download” portion of the “Firmware Download” form.

- 8 You’re now ready to perform the download. Select the control titled **Download** and an erase warning will appear. This is just a double-check to make sure you really want to do this. Assuming you do, select **Yes, Perform the Download**.

The program will switch the GPS Receiver to the “INSTALL” language, erase the flash memory, and begin downloading S-records. The S-records are the long character strings that appear in the lower part of the form as the downloading process proceeds. The total

Downloading New Firmware Using SatStat Program

downloading time varies depending on the type of PC you have, but with communication settings optimized a typical time is about 30 minutes. Once the download is under way, an estimate of the time to complete the process is updated every 100 S-records.

- 9 When the downloading has completed, the “Minutes Until Finished” field will say “DONE”. You can then select **Close** on the Firmware Download form.

There are a couple of ways to confirm that the new firmware has been installed; the easiest is to just power-cycle the unit. Once it has powered up, you can confirm that the new revision is in place by selecting **Query**, then choosing **Product ID** (from the “Control & Query” form) and selecting **Send Cmd**. The product ID will appear on the Control & Query form and should contain the new date code “3503”, for example. An alternative way to check the download is to type SYST:LANG "PRIMARY" in the edit field on the “Control & Query” form and select **Send Cmd**. This will return the unit to normal operating mode without power-cycling. If you do this, you could then check the product ID as described above. NOTE: it is expected that in early software revisions the alarm will come on the first time you power-cycle (or switch to “primary” using SYST:LANG “PRIMARY”). If you investigate the alarm, you will find it is the software safeguard—it has gone off because you have changed the instrument firmware. On subsequent power-ons the alarm will not come on.

After upgrading instrument firmware, you will need to restore the instrument settings recorded prior to the download, and restore the instrument and PC communications settings so that BAUD rate and echo are set according to the requirements of your installation.

D

Performance Tests

Verifying Specifications

Introduction

Introduction

This appendix provides procedures to test the electrical performance of the 58503B and 59551A GPS Receivers specifications listed in and Appendix E, “58503B Specifications,” and Appendix F, “59551A Specifications,” of the. Two types of testing are provided:

- Operational Verification, *starting on page D-5*
- Complete Performance Tests, *starting on page D-17*

Operational Verification

The Operational Verification operational verification test is an abbreviated series of checks that may be performed to give a high degree of confidence that the instrument is operating properly without performing the Complete Performance Tests. An operational verification is useful for incoming inspection, routine maintenance, and after instrument repair.

Complete Performance Tests

The Complete Performance Tests performance tests verify the specifications listed in Appendix E, “58503B Specifications or Appendix F, “59551A Specifications.” All tests can be performed without access to the inside of the instrument.

Test Record

The results of the Operational Verification and Complete Performance Tests should be recorded on a copy of the appropriate (i.e., 58503B or 59551A) Performance Test Record, located at the end of this chapter.

Equipment Required

Equipment Required**Table D-1. Recommended Test Equipment**

Instrument	Required Characteristics	Recommended Model	Use*
Digitizing Oscilloscope	2 channels 500 MHz bandwidth (repetitive)	HP 54600B (or equivalent)	OV, P
Digital Multimeter (DMM)	Microvolt accuracy with leads	HP 34401A (or equivalent)	OV, P
Terminal or computer	Communication Software, RS-232C connection	Any Model	OV, P
Universal Counter	Resolution: 300 ps or better in T.I. Mode	HP 53132A (or equivalent)	P
Frequency Standard	1 PPS Source. Jitter: <1 ns rms pulse-to-pulse 10 MHz House Standard. Accuracy: 2×10^{-12} or better	HP 5071A (or equivalent)	P
50Ω Feedthrough	_____	HP 10100C (or equivalent)	OV
50Ω Coaxial Cable with BNC connectors	BNC(m) to BNC(m), 48 inches	HP 10503A (or equivalent)	P
GPS Antenna or Antenna Assembly	_____	58504A or 58513A	P
GPS Antenna Cable Assembly	RG-213 or LMR 400 cables with TNC (m)-to-N (m) connectors	58518A, 58520A	P
Antenna Interconnect Cable Assembly	RG-213 or LMR 400 cables with N (m)-to-N (m) connectors	58519A, 8521A	P
Barrel adapter	N (f)-to-N (f)	HP 1250-0777 (or equivalent)	P

*OV = Operational Verification

P = Performance Tests

T = Troubleshooting

Before You Start

The time required to acquire lock as described in the following section can vary significantly depending on your local conditions. In general, it is strongly recommended that your antenna and cables be set up in accordance with the information provided in the documents listed below prior to performing any of the tests that follow, or the results cannot be assumed to be valid.

Documents providing GPS Antenna System information are:

- *Designing Your GPS Antenna System* Configuration Guide configuration guide, which discusses the components of an GPS timing receiver system and how to custom design the configuration of your antenna system. *Contact your local Sales office for a copy of this guide.*
- Information Notes that provide installation procedures for the applicable GPS antenna and accessories that you purchase.

Acquiring lock does not mean that the unit is fully operational and meeting specifications. It just means that the GPS Receiver has detected enough satellites to start its survey mode to determine its precise location. An Internal measurement FFOM (Frequency Figure of Merit) becomes 0 when the internal loops reach their proper time constants, indicating that the output frequency and 1 PPS signals are now fully operational and meeting their specifications. Under the worst conditions, the GPS Receiver may take 24 to 72 hours to achieve FFOM = 0. FFOM can be monitored in the Reference Outputs quadrant of the Receiver Status screen (see the sample status screen, Figure 3-1, in Chapter 3, “Visual User Interface,” of this guide if needed). Also, using `:PTIME:TCODE?` query command will provide the FFOM value.

Operational Verification

Introduction

The 58503B and 59551A GPS Receivers are designed to automatically detect and acquire satellites in order to begin providing precise frequency and time information.

Until such acquisition is complete and the unit is locked with FFOM = 0, the signals produced on the rear panel are not precise. However, it is possible to verify that the Receiver has been received in good working condition by performing some simple operational verification tests upon receipt.

Except for two tests (Time Stamp Verification and Programmable Pulse Verification), all of the following operational verification tests do not require usage of the GPS antenna. These tests are designed to provide a high degree of confidence that the Receiver is functioning, but the tests will not verify the specified performance characteristics. Such testing requires more expensive equipment and very long test times (over 72 hours per unit). We recommend that full or complete Performance Testing be restricted to testing only after any repairs to the 58503B or 59551A.

The 58503B and 59551A require no calibration.

Record the results of the Operational Verification in the appropriate place on the appropriate (i.e., 58503B or 59551A) Performance Test Record, which is located at the end of this chapter.

Power-Up Procedure

NOTE

Use the HP 10100C 50Ω feedthrough on the input of the oscilloscope for the following test.

- 1 Connect the Receiver to a suitable power source. The unit will perform a self-test of internal components.
- 2 Verify that after 15 seconds the **Power** indicator is on and the **Alarm** indicator is off. This ensures that all internal components and connections are functioning. (If needed, refer to the subsection titled “To Connect Power” in Chapter 1 of the *58503B/59551A Getting Started Guide* for assistance in connecting the Receiver to a power source.)

Operational Verification**10 MHz Verification (58503B Only)**

- 1 Set the HP 54600B oscilloscope or equivalent sweep rate to 100 ns/div, input amplitude to 0.2 Volts/div, and input coupling to ac.
- 2 Connect the oscilloscope to the rear-panel **10 MHz OUT** output of the 58503B as shown in Figure 2.

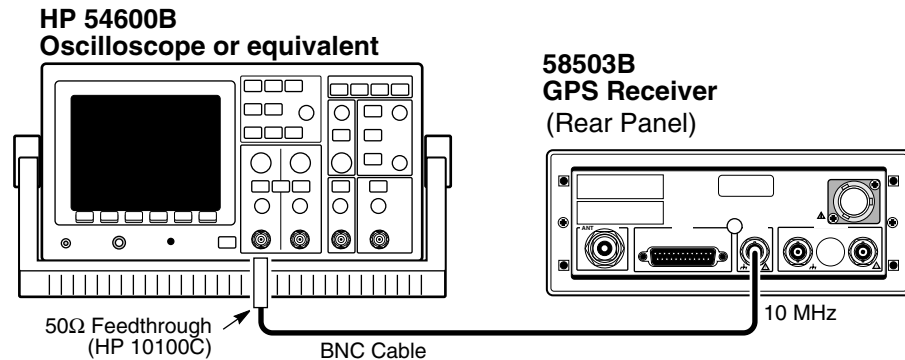
**Figure D-1. 58503B 10 MHz Operational Verification Setup**

- 3 Verify that there is a 10 MHz sine wave present with approximately 1 Volt peak-to-peak into the 50 ohm load.
- 4 Mark Pass or Fail in Line 1 on the Operational Verification portion of the 58503B Performance Test Record, located at the end of this chapter.

1 PPS Verification

- 1 Set the oscilloscope sweep rate to 5 μ s/div, input amplitude to 5 Volts, and input coupling to dc.
- 2 Connect the oscilloscope to the rear-panel **1 PPS** output of the Receiver as shown in Figure D-2.

Operational Verification

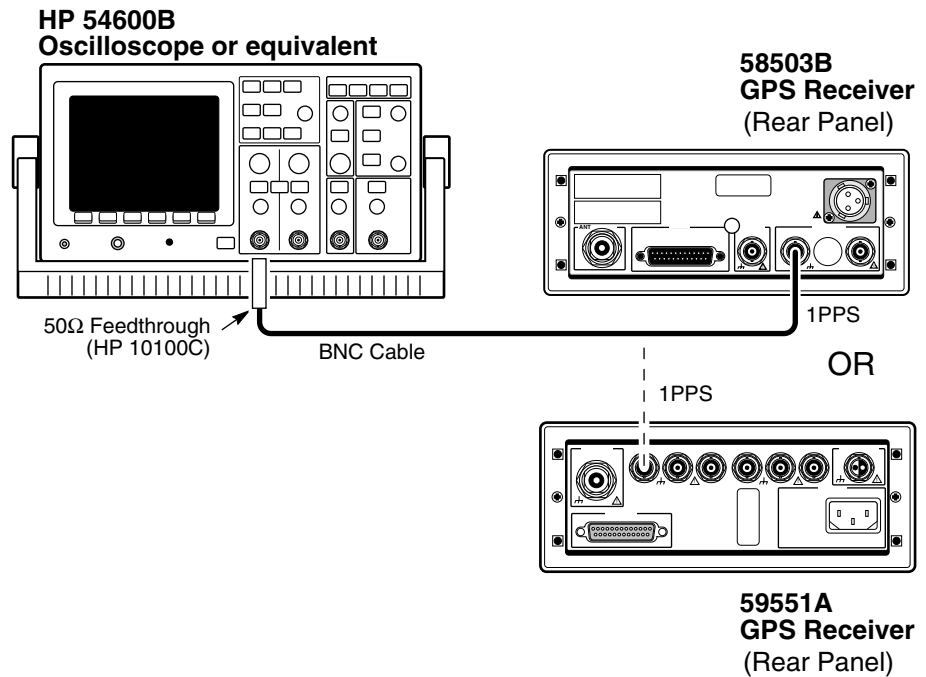

Figure D-2. 1 PPS Operational Verification Setup

- 3 Verify the presence of a TTL level pulse with approximately 20 μ s pulse width.
- 4 Mark Pass or Fail in Line 2 on the Operational Verification portion of the appropriate (58503B or 59551A) Performance Test Record, located at the end of this chapter.

IRIG-B Verification (59551A Only)

- 1 Set the oscilloscope sweep rate to 1 msec/div and input amplitude to 5 Volts/div, dc-coupled.
- 2 Connect the oscilloscope to the rear-panel **IRIG-B** output of the 59551A GPS Receiver as shown in Figure 2.

Verify that the display shows a sine wave with a period of 1 ms, changing in amplitude from 5 Volts peak-to-peak, to greater than 10 Volts peak-to-peak. This is the IRIG-B time code modulating a 1 kHz carrier.

- 3 Mark Pass or Fail in Line 3 on the Operational Verification portion of the 59551A Performance Test Record, located at the end of this chapter.

Operational Verification

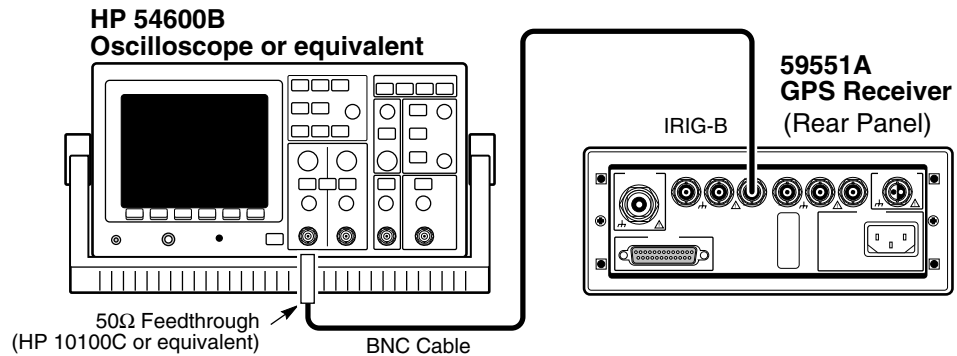

Figure D-3. 59551A IRIG-B Operational Verification Setup

Time of Day and PORT 1 RS-232C Serial Interface Verification

- 1 Connect a terminal or computer (set to 9600 baud, 8 data bits, 1 stop bit, and no parity and no pace) to the rear-panel **PORT 1**. If you need assistance in setting the serial parameters, refer to the Getting Started guide.
- 2 Press the Return key on the terminal.

Verify that either a **SCPI >** or **E-xxx>** prompt is returned. The **xxx** can be any number for this test. If **E-xxx>** is returned, send the ***CLS** command to clear the error.

- 3 Type **:SYSTEM:STATUS?**, then press Enter (or Return) key.

The terminal screen displays the Receiver Status screen, which is a complete status report of the Receiver. Without a GPS antenna, most data will be blank or indicating that the instrument is in “Power-Up” mode. The **FFOM = 3** in the upper right corner indicates that the Receiver is in power-up mode and frequency outputs are invalid. At this point, the data at the bottom of the screen lists the results of all internal self-tests. The **HEALTH MONITOR, SelfTest, Int Pwr, Oven Pwr, OCXO, EFC, and GPS Rcv** should all show **OK**.

- 4 From the terminal keyboard, type **:PTIME:TCODE?** and press Return.

Operational Verification

An alphanumeric string which starts with a “T” should be displayed as shown in the following example:

T2199505112055233000049

Note that the value above will be different for each test, depending on the local date and time.

- 5 Mark Pass or Fail in Line 4 on the Operational Verification portion of the appropriate (58503B or 59551A) Performance Test Record, located at the end of this chapter.

Antenna Power Verification

- 1 Set the DMM to read a range of 5 Volts dc.
- 2 Measure the dc voltage from the center pin of the antenna (Type N) connector with respect to the threaded connector shell.

Verify that the voltage is between 4.5 and 5.0 Volts dc.

- 3 Mark Pass or Fail in Line 5 on the Operational Verification portion of the appropriate (58503B or 59551A) Performance Test Record, located at the end of this chapter.
- 4 If you are testing the 58503B with Option 001 Front Panel and Keypad, perform the procedure in the following section titled “Front Panel Display/Keypad Verification (58503B Option 001 Only)” on page D-10.

If you are testing the standard 58503B, go to the section titled “Operational Verification Conclusion” on page D-15 in this chapter.

If you are testing a 59551A, go to the section titled “Time Tagging (Stamping) Verification and Programmable Verification (59551A Only)” on page D-11.

Operational Verification

Front Panel Display/Keypad Verification (58503B Option 001 Only)

This tests the operation of the Front Panel Display/Keypad option for the 58503B.

- 1 Disconnect and re-apply power to the 58503B.
- 2 While the letters "HP" are moving from right to left (about 2 seconds), press **Sat** key and then **Time** key to enter the TEST/DEMO mode.
- 3 The words **VFD DSP TEST** will momentarily appear.

The display should then show a test pattern that sequentially illuminates all 15 segments of all digits and punctuation marks in the display.

- 4 Verify that all segments illuminate.
- 5 When the segment illumination sequence is complete, the words **DEMO MODE** should then appear.
- 6 Press each key one at a time. Each keypress should:
 - illuminate the LED corresponding to that key, and
 - display a simulated response to the function.

NOTE

(1) The **Clear Alarm (Shift , Alt)** function will exit the test. (2) The values displayed are not related to the 58503B under test. They are displayed for demonstration only.

- 7 To exit the diagnostic, press **Shift** key, and then press **Alt** key.
- 8 The 58503B power-up sequence should then continue. No further tests are necessary.
- 9 Mark Pass or Fail in Line 5 on the Operational Verification portion of the 58503B Performance Test Record, located at the end of this chapter.
- 10 Proceed to the section titled "Operational Verification Conclusion" on page D-15 to complete the operational verification.

Operational Verification**Time Tagging (Stamping) Verification and Programmable Verification (59551A Only)****NOTE**

GPS ANTENNA REQUIRED. The steps below require that a GPS antenna be properly set up, and the 59551A is in GPS locked mode before proceeding. For information on how to make such a setup, refer to the antenna information provided on page D-4 in this chapter.

If you determine that these tests will not be performed for your facility, please proceed to the next section titled “Operational Verification Conclusion” on page D-15.

- 1 Connect a GPS Antenna and cable to the 59551A and allow the Receiver to indicate it is in “GPS Lock” mode as indicated by the illuminated **GPS Lock** indicator. Until GPS lock is attained, the following tests will not be valid. Your test setup should be similar to Figure 1.

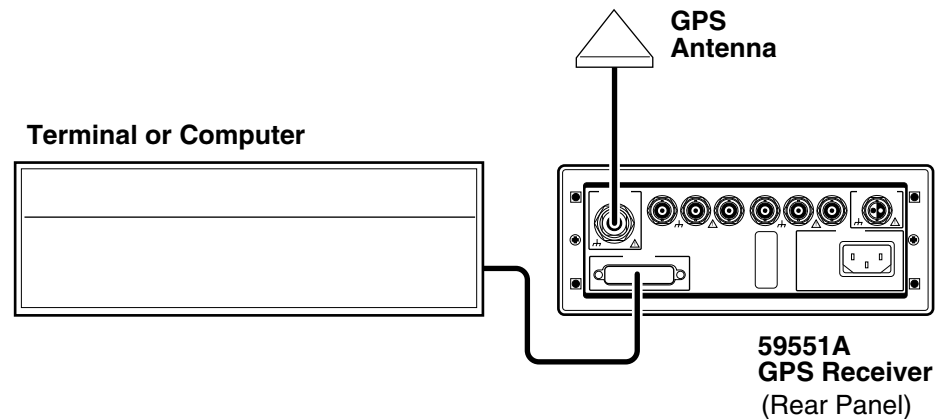

Figure D-4. 59551A Time Tagging Operational Verification Setup

- 2 Enter the following commands from the terminal or computer to note the current date and time.

```
:PTIME:DATE?
```

```
:PTIME:TIME?
```
- 3 On the computer or terminal, type :SENSE:DATA:CLEAR and press the Return key.

Operational Verification

This clears the Time Tagging event registers of any data prior to the next step.

- 4 On the computer or terminal, type `:FORMAT:DATA ASCII` and press the Return key.

This sets the output format of the Time Tagging Data to an ASCII string for easier interpretation.

- 5 Refer to Chapter 2, “Features and Functions,” in the *58503B/59951A Getting Started Guide* to identify types of stimulus equipment that could be used for this test.

A suggested general-purpose device could be a pulse generator, set to output a TTL level pulse.

- 6 Use this signal to send an event to each of the three Time Tagging inputs.
- 7 From the terminal or computer, send the following query commands to verify that an event was recorded in each of the Time Tagging event registers. Note that there is a space between the question mark (?) and the quotation mark (") in the following commands.

```
:SENSE:DATA? "TSTAMP 1"  
:SENSE:DATA? "TSTAMP 2"  
:SENSE:DATA? "TSTAMP 3"
```

Note that the actual date and time of the record is not being tested.

- 8 Verify that each response is the following format:
`yyyy,mm,dd,hh,mm,sssssss,xxxxxxxxxx`
- 9 On the terminal, type `:SENSE:DATA:CLEAR` and press the Return key.
- 10 This again clears the Time Tagging event registers of any data from this test.
- 11 Mark Pass or Fail in Line 6 on the Operational Verification portion of the 59551A Performance Test Record, located at the end of this chapter.

Operational Verification

Programmable Pulse Verification (59551A Only)

- 1 Enter the following commands from the terminal or computer:

```
:PULSE:CONTINUOUS:PERIOD 1
```

This sets the period to 1 second.

```
:PULSE:CONTINUOUS:STATE ON
```

This sets the programmable pulse output to provide a continuous stream of pulses.

```
:PULSE:START:DATE <four-digit year>, <month>, <day>
```

- 2 Set the year, month, and day to the same values read in step 2 in the previous procedure “Time Tagging Verification.”

Example:

```
:PULSE:START:DATE 1995, 7, 25 is July 25, 1995.
```

```
:PULSE:START:TIME <hours>, <minutes>, <seconds>
```

- 3 Set the hours, minutes, and seconds to the same values observed in step 2 of the previous procedure “Time Tagging Verification.”

Example:

```
:PULSE:START:TIME 13, 1, 5 is 13:01:05 in 24-hour format.
```

NOTE

Setting the time to a value earlier than the present time will start the pulse stream immediately. If a time is input with a value some time in the future, the pulse stream will not start until that time is attained.

- 4 Set the oscilloscope sweep rate to 5 msec/div, input amplitude to 5 Volts/div, and input coupling to dc.
- 5 Connect the oscilloscope to the rear-panel **Programmable Pulse** output as shown in Figure 5.

Operational Verification

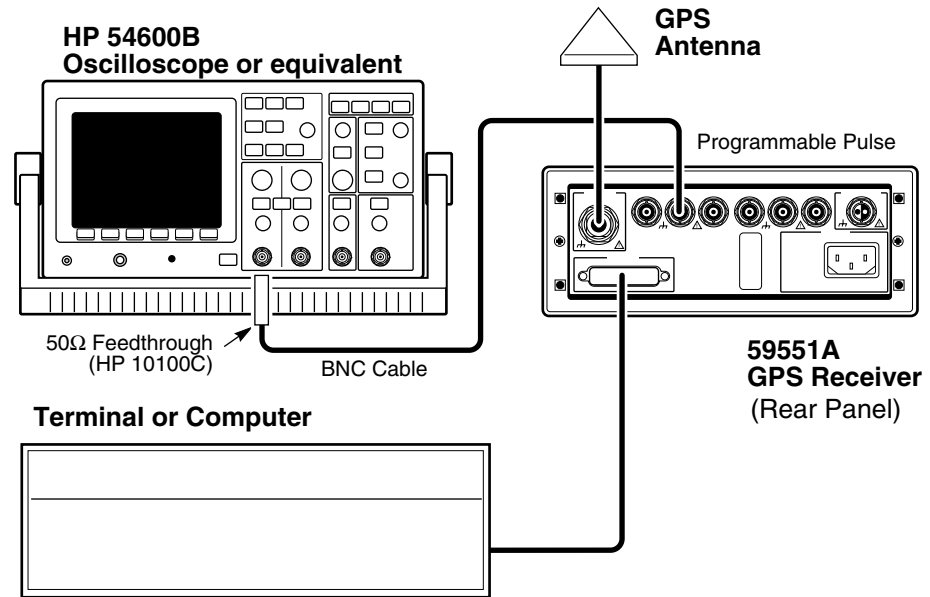

Figure D-5. 59551A Programmable Pulse Operational Verification Setup

- 6 Verify that a continuous stream of TTL-compatible pulses are occurring at a 1 second rate.
- 7 Mark Pass or Fail in Line 7 on the Operational Verification portion of the 59551A Performance Test Record, located at the end of this chapter.

Operational Verification

Operational Verification Conclusion

NOTE

Perform the following step only if you wish to restore memory of the 58503B or 59551A Receiver to the factory default states. Doing this can change several parameters that have been stored by a previous user. If you have any questions or concerns, refer to Table 5-2 under the description of the :SYSTEM:PRESET command on page 5-111 of Chapter 5 in this guide for information on the type of information that is stored.

On the terminal or computer, type:

:SYSTEM:PRESET and press the Return key.

This will ensure that your Receiver has been restored to the factory defaults as originally received.

This completes the operational verification.

In Case of Difficulty

In Case of Difficulty

If any of the above tests fail it should be re-checked before assuming that the unit is defective. Return any defective unit.

Complete Performance Tests

The specifications of the 58503B and 59551A can be verified by performing the Performance Tests provided in this section. Table D-2 lists a summary of the 58503B/59551A Complete Performance Tests.

Table D-2. The 58503B/59551A Complete Performance Tests

Page Number	Time and Frequency Output Tests
D-18	Preliminary Test Setup
D-19	Test 1: 10 MHz Frequency Accuracy and 1 PPS Jitter (Locked to GPS)
D-22	Test 2: 10 MHz Holdover Aging and 1 PPS Accumulated Time Error (Unlocked)
D-24	Test 3: 1 PPS Time Accuracy (Locked)
D-24	Test 4: 10 MHz Frequency Stability (Time Domain) and Phase Noise (Frequency Domain) Measurements

The following tests will ensure that the 58503B GPS Time and Frequency Reference Receiver and 59551A GPS Measurements Synchronization Module are meeting the published specifications. Some of these tests will require that the Receiver be operating continuously for at least 3 days, others require that the Receiver be disconnected from GPS, and others will require further investigation in order to produce a satisfactory setup and measurement.

The critical specifications to be tested are the 10 MHz Frequency Accuracy (1 day) and the 1 PPS Jitter (1 day) specifications. As long as the Receiver is locked, the proper performance of these two specifications will imply that the other specifications are in conformance.

The following tests do not test “typical” or “nominal” specifications, or “supplemental characteristics,” “supplemental information,” or “features.”

Record the results of the Performance Test in the appropriate place on the appropriate (i.e., 58503B or 59551A) Performance Test Record, which is located at the end of this chapter.

Complete Performance Tests

Preliminary Test Setup

If you have not connected the GPS antenna to the Receiver, perform the following preliminary procedure in this section.

If you have already connected the GPS antenna to the Receiver, go to the next subsection titled “Test 1: 10 MHz Frequency Accuracy and 1 PPS Jitter (Locked to GPS).”

- 1 Connect the antenna system to the rear-panel **ANTENNA** Type-N connector of the Receiver as described in the instructions given in the section titled “Preparing the GPS Receiver for Use” in Chapter 1, of the *58503B/59551A Getting Started Guide*.

NOTE

Do not apply power to the Receiver unless a fully operational antenna system is connected to the ANTENNA input connector. Power applied with no antenna input or a non-functioning antenna will initiate an extended search process that may increase time to reach GPS lock. You can halt the extended search by disconnecting and reconnecting (cycling) the external supply voltage to the Receiver (you may need to leave power disconnected for greater than five seconds).

- 2 Connect the Receiver to a suitable power source. (If needed, refer to the subsection titled “To Connect Power” in Chapter 1 of the *58503B/59551A Getting Started Guide*.)
- 3 The Receiver will perform a self-test of internal components. Verify that after 15 seconds the **Power** indicator illuminates and the Alarm indicator is off. This ensures that all internal components and connections are functioning.

Complete Performance Tests

Test 1: 10 MHz Frequency Accuracy and 1 PPS Jitter (Locked to GPS)

This test measures the relative change in the 1 PPS pulses between the unit under test and a known accurate source. A time interval is measured and the data is stored to be compared with a second measurement, 24 hours later. The 1 PPS source is derived from the internal 10 MHz, and the relative accuracy of 1 PPS is directly related to the accuracy of the 10 MHz.

Specifications Tested

Frequency Accuracy (locked): Better than 1×10^{-12} for a one day average, 0 degrees to 50 degrees C.

1 PPS Jitter of leading edge: <750 ps with at least one satellite in view, Selective Availability on.

Procedure

- 1 Connect the terminal or computer to the Receiver using the cable recommended in the Getting Started Guide and ensure that they are both communicating.
- 2 Ensure that the Receiver is in “GPS Lock” mode as indicated by the illuminated **GPS Lock** indicator, and that FFOM = 0. The current value of FFOM and many other characteristics of the unit can be determined by typing :SYSTEM:STATUS? on the terminal.
- 3 Connect the 10 MHz reference output from the reference 1 PPS source (HP 5071A or another stable, traceable house standard) to the rear-panel **Ref In** of the Universal Counter, as shown in Figure D-6, to provide an external timebase for the Counter.

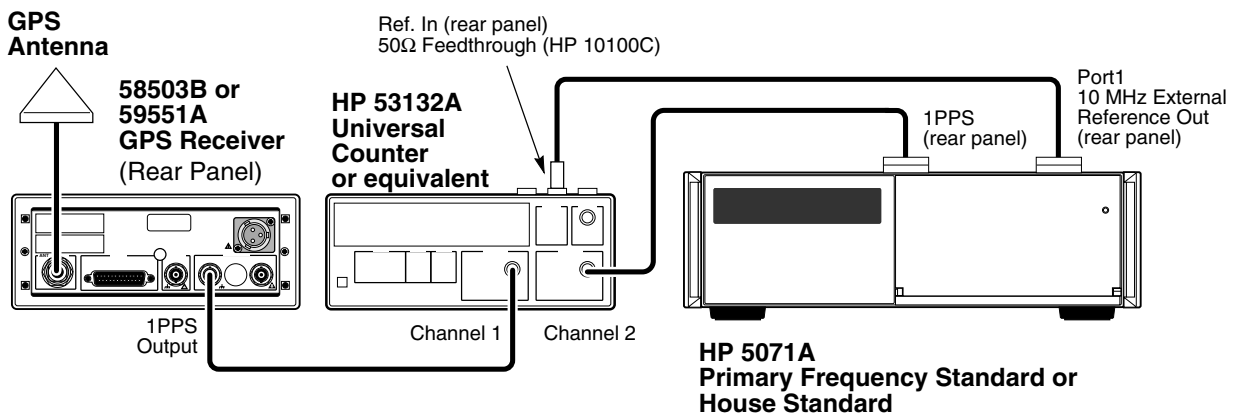

Figure D-6. 10 MHz Frequency Accuracy and 1 PPS Jitter Test Setup (58503B GPS Receiver shown)

Complete Performance Tests

- 4 Connect the rear-panel 1 PPS from Receiver under test to Channel 1 of the Universal Counter.
- 5 Connect the 1 PPS from the reference standard (5071A) to Channel 2.
- 6 On the terminal or computer, enter the following command to clear all entries in the Diagnostic (status) Log:

:DIAG:LOG:CLEAR and press the Enter (or Return) key.
- 7 Set the Universal Counter function to take 100 samples of Time Interval and compute the Mean value. Ensure that the inputs are set to DC-coupled, 50 Ohms, and rising edge. Set the trigger level for both inputs to 1Volt dc.
- 8 Record the average time interval for later comparison.

_____ seconds.
- 9 Disconnect the reference 1 PPS from input 2 and set the counter to “COMMON” mode so the 1 PPS from the Receiver is input to both channels. For this step, be sure the trigger levels are both set to 1 Volt dc.
- 10 Set the counter to compute the Standard Deviation for the same 100 samples.

This is the RMS Jitter of the 1 PPS.

Complete Performance Tests

11 Again, allow the counter to accumulate 100 samples of time interval.

12 Note the largest deviation (greater or less) from exactly 1 second.

This the worst-case 1 PPS leading edge jitter.

13 Record the results of 1 PPS Jitter on Line 2 of Test 1 of the Performance Test Record.

14 Wait 24 hours to complete the Frequency Accuracy test.

15 On the terminal or computer, enter the following command:

:DIAG:LOG:READ:ALL? and press the Enter (or Return) key.

Observe the messages (if any) that appear and verify that none of the messages indicate that the 58503B/59551A has entered holdover mode. If it has, the entire test must be re-started from step 2 above.

16 Repeat steps 2 through 8 above after the 24-hour period.

17 Compute the Frequency Accuracy using the following formula:

$$\frac{(t1 - t2)\text{seconds}}{\Delta t\text{seconds}} = \text{Accuracy (unitless)}$$

Where,

t1 is the average time interval first measured

t2 is the average time interval last measured

Δt is the time between measurements (86,400 seconds = 24 hours)

18 Record the results of Frequency Accuracy in Line 1 of Test 1 of the Performance Test Record.

Complete Performance Tests

Test 2: 10 MHz Holdover Aging and 1 PPS Accumulated Time Error (Unlocked)

The following tests are identical to the previous tests, with the exception that during the actual test, the Receiver is not locked to the GPS. However, the test must adhere to the restrictions noted below with the specification in order for the results to be valid.

Specifications Tested

Holdover aging: $< 1 \times 10^{-10}$ /day average frequency change in 24 hours unlocked after 3 days locked operation for any 10 degrees C range between 10 degrees C and 40 degrees C.

Accumulated time error: < 8.6 us accumulated in 24 hours unlocked after 3 days of locked operation with a fixed antenna location, any 10 degrees C range between 10 degrees and 40 degrees C.

Procedure

- 1 Ensure that the Receiver has been in GPS Lock mode for at least three (3) days without entering holdover mode by typing the following command on the terminal or computer:

:DIAG:LOG:READ:ALL? and press the Enter (or Return) key.

Verify that there are no messages to indicate that holdover mode was started during the last 72 hours of operation.

- 2 Ensure that the temperature restrictions described above will be met for the next 24 hours.
- 3 Connect the 10 MHz reference output from the reference 1 PPS source (5071A or another stable, traceable house standard) to the rear-panel **Ref In** of the Universal Counter, as shown in Figure D-6, to provide an external timebase for the Counter.
- 4 Connect the rear-panel 1 PPS from Receiver under test to Channel 1 of the Universal Counter.
- 5 Connect the 1 PPS from the reference standard (5071A) to Channel 2. Ensure that the inputs are set to DC-coupled, 50 Ohms, and rising edge. Set the trigger level for both inputs to 1 Volt dc.
- 6 Disconnect the antenna cable (N-type connector) at the rear of the Receiver to force it into Holdover Mode.
- 7 Ensure that the **Holdover** indicator is illuminated and the **GPS Lock** is not illuminated.

Complete Performance Tests

- 8 Note the time interval average for 100 samples, either positive or negative.

NOTE

Do not re-connect the antenna at this time. It must remain disconnected for the entire 24-hour period.

- 9 Wait 24 hours to complete the Holdover Aging test. During this 24-hour period, ensure that the temperature restrictions are maintained. If the temperature does exceed the range, the Receiver will have to be re-connected to the antenna, allowed to lock, run for at least 3 days, and re-tested with this procedure.
- 10 Repeat steps 3, 4, 5, and 8 above after the 24 hour period.
- 11 If desired, re-connect the antenna cable at this time.
- 12 Compute the Holdover Aging rate using the following formula:

$$\frac{(t1 - t2) \text{ seconds}}{\Delta t \text{ seconds}} = \text{Aging rate (unitless)}$$

Where,

t1 is the average time interval first measured

t2 is the average time interval last measured

Δt is the time between measurements (86,400 seconds = 24 hours)

- 13 Compute the Accumulated Time Error using the following formula:

$$(t1 - t2) \text{ seconds} = \text{Error (seconds)}$$

Where t1 and t2 are defined as in the previous step.

- 14 Record the results of Holdover Aging and 1 PPS Accumulated Time Error in the Test 2 row of the Performance Test Record.

Complete Performance Tests

Test 3: 1 PPS Time Accuracy (Locked)

This specification is a statistical probability that the Receiver will conform to the standard as described. This cannot be tested with any degree of confidence except at NIST or an equivalent National Standards Laboratory. Actual accuracy obtained depends on the exact knowledge of the geophysical location, characteristics and delay in the antenna, calibration of all measurement delays, and calibration of antenna cable delay. Calibration of both ionospheric and tropospheric delay use the standard algorithms provided in the GPS data messages. At the 95% confidence level, time errors associated with the Receiver, GPS system, and ionospheric and tropospheric effects will be less than 110 ns.

Test 4: 10 MHz Frequency Stability (Time Domain) and Phase Noise (Frequency Domain) Measurements

NOTE

High accuracy precision measurements of both time and frequency domain stability are available through the National Institute of Standards and Technology (NIST) in the USA, and at other equivalent National Standards Laboratories. NIST can completely characterize and verify all major specifications of the 58503B or 59551A. For information regarding the various tests available, contact:

National Institute of Standards and Technology,
Measurements Services Office
325 Broadway, Boulder CO 80303-3328 USA,
Telephone: (303) 497-3753

Frequency Stability (Time Domain)

This is an engineering-level measurement requiring a special test setup. The test setup must be carefully designed to eliminate all sources of noise. For more information on how to make this measurement, see Application Note 358-12. Also, see NIST Technical Note 1337 (available from US Government Printing Office, Washington DC., USA). This is an excellent theoretical as well as technical reference for this measurement.

Phase Noise (Frequency Domain)

This measurement requires the HP 3048A Phase Noise Measurement System or equivalent, a highly specialized test system. In order to perform properly, this system must contain a reference oscillator with phase noise characteristics that are equal to or better than the 58503B or 59551A.

This completes the performance tests.

Appendix D Performance Tests
Complete Performance Tests

Appendix D Performance Tests
58503B Performance Test Record

58503B Performance Test Record

Model 58503B GPS Time and Frequency Reference Receiver			
Serial Number: _____		Repair/Work Order No. _____	
Test Performed By: _____		Temperature: _____	
Date: _____		Relative Humidity: _____	
Notes: _____			
Line Number	Operational Verification	Test Results	
		Pass	Fail
1	10 MHz Verification	_____	_____
2	1 PPS Verification	_____	_____
3	Time of Day RS-232 Serial Interface Verification	_____	_____
4	Antenna Power Verification	_____	_____
5	Front Panel Display/Keypad Verification (Option 001 Only)	_____	_____
58503B Complete Performance Tests			
Test Number	Test Description	Results	Limits
1	10 MHz Frequency Accuracy and 1 PPS Jitter (Locked to GPS)	1. _____ 2. _____	Better than 1×10^{-12} for a one day average, 0° to 50° C. <750 ps with at least one satellite in view, Selective Availability on.
2	10 MHz Holdover Aging and 1 PPS Accumulated Time error (Unlocked)	1. _____ 2. _____	< 1×10^{-10} /day average frequency change in 24 hours unlocked after 3 days locked operation for any 10° C range between 10° C and 40° C. <8.6 us accumulated in 24 hours unlocked after 3 days of locked operation with a fixed antenna location, any 10° C range between 10° C and 40° C.
3	1 PPS Time Accuracy (Locked)	_____	
4	10 MHz Frequency Stability (Time Domain) and Phase Noise (Frequency Domain) Measurement	_____	

59551A Performance Test Record**59551A Performance Test Record**

Model 59551A GPS Measurements Synchronization Module			
Serial Number: _____		Repair/Work Order No. _____	
Test Performed By: _____		Temperature: _____	
Date: _____		Relative Humidity: _____	
Notes: _____			
Line Number	Operational Verification	Test Results	
		Pass	Fail
1	10 MHz Verification	_____	_____
2	1 PPS Verification	_____	_____
3	IRIG-B Verification	_____	_____
4	Time of Day RS-232 Serial Interface Verification	_____	_____
5	Antenna Power Verification	_____	_____
6	Time Tagging (Stamping) Verification	_____	_____
7	Programmable Pulse Verification	_____	_____
59551A Complete Performance Tests			
Test Number	Test Description	Results	Limits
1	10 MHz Frequency Accuracy and 1 PPS Jitter (Locked to GPS)	1. _____ 2. _____	Better than 1×10^{-12} for a one day average, 0° to 50° C. <750 ps with at least one satellite in view, Selective Availability on.
2	10 MHz Holdover Aging and 1 PPS Accumulated Time error (Unlocked)	1. _____ 2. _____	< 1×10^{-10} /day average frequency change in 24 hours unlocked after 3 days locked operation for any 10° C range between 10° C and 40° C. <8.6 us accumulated in 24 hours unlocked after 3 days of locked operation with a fixed antenna location, any 10° C range between 10° C and 40° C.
3	1 PPS Time Accuracy (Locked)	_____	
4	10 MHz Frequency Stability (Time Domain) and Phase Noise (Frequency Domain) Measurement	_____	

Appendix D Performance Tests
59551A Performance Test Record

E

58503B Specifications

Specifications and Characteristics

The specifications and characteristics of the 58503B GPS Time and Frequency Reference Receiver are provided in this chapter.

GPS Receiver Features

Eight-channel, parallel tracking GPS engine
C/A Code, L1 Carrier
SmartClock™ technology
Enhanced GPS technology

10 MHz Output

Specifications

Locked:

Frequency Accuracy: Better than 1×10^{-12} , for a one-day average, 0° C to 50° C.

Unlocked:

Holdover aging:
 $<1 \times 10^{-10}$ per day average frequency change in 24 hours of unlocked operation. (See Note 1.)

Phase Noise: (Locked)

Offset From Signal (Hz)	SSB Phase Noise (dBc)
1	-85
10	-125
100	-135
1000	-140
10000	-145

Time Domain Stability: (Locked) *(See graph on next page.)*

Averaging Time Seconds	Root Allan Variance
0.01	1.5×10^{-10}
0.1	1.5×10^{-11}
1	5×10^{-12}
10	5×10^{-12}
100	5×10^{-11}
1000	5×10^{-11}

Supplemental Information

- Waveform: Sine wave
- Amplitude: >1 volt p-p into a 50Ω load
- Harmonic Distortion: <-25 dBc (Typical)
- Non-harmonic signals: <-60 dBc (Typical)
- Source impedance: 50Ω (nominal)
- Coupling: ac
- Connector: BNC

Note 1

This specification has a 95% probability, and is based on the availability of four or more GPS satellites during three days of locked operation with a fixed antenna location. The temperature must remain within a 10° C range between 10° C and 40° C.

Note 2

When a quartz crystal oscillator has not been operated for a period of time, or if it has been subjected to severe thermal or mechanical shock, as might be encountered during product shipment, the oscillator may take some time to stabilize. In most cases, the oscillator will drift and then stabilize at or below its specified rate within a few days after being turned on. In isolated cases, depending upon the amount of time the oscillator has been off and the environmental conditions it has experienced, the oscillator may take up to one week to reach its specified aging rate and to operate without significant frequency "jumps."

When a GPS Receiver is initially turned on and locked to the GPS satellite system, it will achieve GPS lock within 30 minutes of operation. It has a 95% probability of meeting unlocked (holdover) specifications after 24 hours of warmup, followed by GPS lock for 48 hours. The longer GPS Receiver (and its quartz oscillator) operates, the better its stability and unlocked (holdover) performance becomes.

1 PPS Output

Specifications

Locked:

Jitter of leading edge: <750 ps rms with at least one satellite in view, SA on.

Time Accuracy:

<110 ns with respect to UTC (USNO MC)—95% probability when unit is properly installed, calibrated, and locked to GPS.

Unlocked:

Accumulated time error: <8.6 μs accumulated in 24 hours of unlocked operation. (See Note 1.)

Supplemental Information

- Pulse Width: 26 μsec
- Amplitude: >2.4 volts into 50Ω load. (TTL compatible)
- Connector: BNC
- Rise time: <25 ns

Additional Features

Alarm Output: TTL open collector

with internal pull-up resistor. Circuit can sink up to 10 ma. Provides a logic output to allow monitoring of normal (H) and abnormal (L) operation externally and remotely. BNC connector.

Front Panel Indicators (LEDs):

Power
 GPS Lock
 Holdover Mode
 Alarm

Remote Interface:

RS-232-C DTE configuration:

Complete remote control and interrogation of all instrument functions and parameters.

Factory defaults: baud rate 9600, 8 data bits, 1 start bit, 1 stop bit, no parity. Other settings are programmable.

Connector: 25-pin female rectangular D subminiature on rear panel.

Time code output is available to a computer immediately preceding the 1 PPS signal for the current second.

Environmental Specifications

Time and Frequency Reference Receiver (58503B)

Operating: 0° C to +50° C
 Storage: -40° C to +80° C

Antenna (58532A)

Operating: -30° C to +80° C
 Storage: -40° C to +85° C

Power Requirements

AC Power (standard):

90 to 132 Vac or 198 to 264 Vac,
automatically selected;
50 to 60 Hz.

Option AWQ:

Unit accepts:
+24 Vdc or +48 Vdc nominal.
Actual operating range:
+19 to +60 Vdc operating range.
Greater than
+23 Vdc required to start.

Input Power (all options):

<35 watts (nominal).

Weight and Size

Dimensions:

88.5 mm H ×
212.6 mm W × 348.3 mm D.
Half-Rack Module

Weight: 3.6 kg (8 lbs).

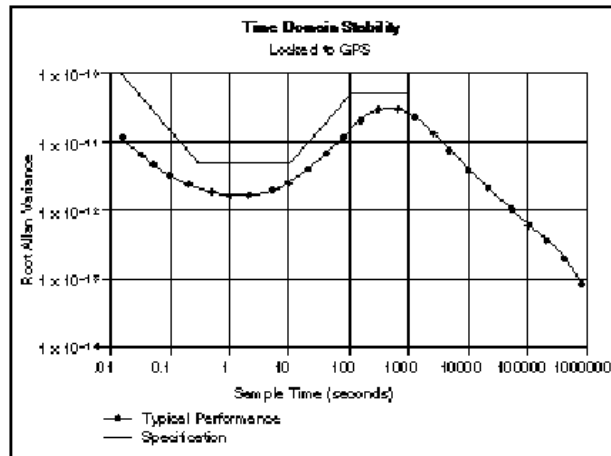

10 MHz Root Allan Variance

Other Information

The standard 58503B does not include a display or a keypad. While not necessary, it may be convenient to track the Receiver's progress during installation and startup by monitoring the satellites being tracked, location (position), time and other parameters. The 58503B, however, is supplied with a small Windows 3.1 program named SatStat (59551-13401), which can serve to display important parameters. SatStat operates on any PC that can run Windows 3.1, and that has an available serial interface.

SatStat provides several useful functions. It continuously polls the RS-232C interface and displays Receiver information most likely to be of interest. This includes satellites being tracked along with their elevation and azimuth, SmartClock State (locked, holdover, etc.), antenna coordinates, time and frequency figures of merit and other data. In addition, a clock window is provided to display time of day in real time. Finally, SatStat allows you to easily change many receiver parameters, such as antenna delay, by simply picking the item from a pop-up menu and entering a new value. With SatStat and a PC, you can monitor and control many aspects of the Receiver status without developing software.

Achieving accurate time of day requires care in determining cable delays, Receiver bias, position (Lat, Lon, Alt), atmospheric conditions and other parameters which are dependent on each individual installation.

Options and Accessories

Available options and accessories include an antenna, an antenna environmental cover and ground plane, pre-configured cables, a lightning arrester, an antenna line amplifier, a built-in display and dc power.

Appendix E 58503B Specifications
Specifications and Characteristics

F

59551A Specifications

Specifications and Characteristics

The specifications and characteristics of the 59551A GPS Measurements Synchronization Module are provided in this chapter.

GPS Receiver Features

Eight-channel, parallel tracking GPS engine
C/A Code, L1 Carrier
SmartClock™ technology
Enhanced GPS technology

Appendix F 59551A Specifications

Specifications and Characteristics

1 PPS Output

Specifications

Locked:

Jitter of leading edge: <750 ps rms with at least one satellite in view.

Time Accuracy:

<110 ns with respect to UTC (USNO MC)—95% probability when unit is properly installed, calibrated, and locked to GPS.

Unlocked:

Accumulated time error: <8.6 μ s accumulated in 24 hours of unlocked operation. (See Note 1.)

Supplemental Information

- Pulse Width: 26 μ sec
- Amplitude: >2.4 volts into 50 Ω load. (TTL compatible)
- Connector: BNC
- Rise time: <5 ns

Additional Features

Alarm BITE Output:

Basic unit output: solid state relay (normally open); closed contact indicates system fault or loss of satellite lock. Contact rating 200 Vdc @ 0.5 amps.

Connector: Twin BNC

IRIG-B123 Output Port

BNC connector

Note 1

This specification has a 95% probability, and is based on availability of four or more GPS satellites during three days locked operation with a fixed antenna location. The temperature must remain within a 10° C range between 10° C and 40° C.

Note 2

When a quartz crystal oscillator has not been operated for a period of time, or if it has been subjected to severe thermal or mechanical shock, as might be encountered during product shipment, the oscillator may take some time to stabilize. In most cases, the oscillator will drift and then stabilize at or below its specified rate within a few days after being turned on. In isolated cases, depending upon the

amount of time the oscillator has been off and the environmental conditions it has experienced, the oscillator may take up to one week to reach its specified aging rate and to operate without significant frequency "jumps."

When a GPS Receiver is initially turned on and locked to the GPS satellite system, it will achieve GPS lock within 30 minutes of operation. It has a 95% probability of meeting unlocked (holdover) specifications after 24 hours of warmup, followed by GPS lock for 48 hours. The longer GPS Receiver (and its quartz oscillator) operates, the better its stability and unlocked (holdover) performance becomes.

Three Time-tag Inputs

Received signal: TTL, 50 Ω .

Time-tag accuracy: same as the accuracy of the 59551A.

Quantization: 100 ns

Input Interface: BNC

Minimum Pos/Neg pulse width: 200 ns

Three time-tag buffers: 256 events each, retrievable via RS-232C.

Minimum time between events: 1 ms

Maximum stamp rate: 1 measurement per ms

Timer/Clock Output

Programmable Pulse Output:

Single pulse at the time programmed via RS-232C port, or repetitive output pulse at a programmable repetition period from 1 second to 1 year.

Quantization: 100 ns

Accuracy: same as the time accuracy of the 59551A.

Front Panel Indicators (LEDs):

Power
GPS Lock
Holdover Mode
Alarm

Remote Interface: (Two RS-232C Ports)

RS-232-C DTE configuration:
PRIMARY PORT

Complete remote control and interrogation of all instrument functions and parameters.

SECONDARY PORT

Interrogation of all instrument functions and parameters.

Factory defaults: baud rate 9600—8 data bits, 1 start bit, 1 stop bit, no parity. Other settings are programmable.

Connectors: 9-pin female rectangular D subminiature (DB-9) on front panel, 25-pin female rectangular D subminiature (DB-25) on rear panel.

Time code output is available to a computer immediately preceding the 1 PPS signal for the current second.

Appendix F 59551A Specifications
Specifications and Characteristics

Environmental Specifications

Measurements Synchronization Module (59551A)

Operating: 0° C to +50° C
Storage: -40° C to +80° C

Antenna (58532A)

Operating: -40° C to +80° C
Storage: -40° C to +85° C

Power Requirements

AC Power:

90 to 132 Vac or 198 to 264 Vac, automatically selected;
50 to 60 Hz.

or

DC Power:

129 Vdc nominal (115 to 140 Vdc operating range).

Input Power (all options):

<35 watts (nominal).

Weight and Size

Dimensions:

88.5 mm H × 212.6 mm W × 348.3 mm D. Half-Rack Module

Weight: 3.6 kg (8 lbs).

Surge Withstand:

Meets IEEE/ANSI C37.90, C37.90.1

Other Information

The standard 59551A does not include a display or a keypad. While not necessary, it may be convenient to track the Receiver's progress during installation and startup by monitoring the satellites being tracked, location (position), time and other parameters. The 59551A, however, is supplied with a small Windows 3.1 program named SatStat (59551-13401), which can serve to display important parameters. SatStat operates on any PC that can run Windows 3.1, and that has an available serial interface.

SatStat provides several useful functions. It continuously polls the RS-232C interface and displays Receiver information most likely to be of interest. This includes satellites being tracked along with their elevation and azimuth, SmartClock State (locked, holdover, etc.), antenna coordinates, time and frequency figures of merit and other data. In addition, a clock window is provided to display time of day in real time. Finally, SatStat allows you to easily change many receiver parameters, such as antenna delay, by simply picking the item from a pop-up menu and entering a new value. With SatStat and a PC, you can monitor and control many aspects of the Receiver status without developing software.

Achieving accurate time of day requires care in determining cable delays, Receiver bias, position (Lat, Lon, Alt), atmospheric conditions and other parameters which are dependent on each individual installation.

Options and Accessories

Available options and accessories include an antenna, an antenna environmental cover and ground plane, pre-configured cables, a lightning arrester, an antenna line amplifier, a built-in display and ac power.

Appendix F 59551A Specifications
Specifications and Characteristics

Command Index

*CLS, 5-54, 5-115
*ESE, 5-66
*ESE?, 5-67
*ESR?, 5-67
*IDN?, 5-114
*SRE, 5-57
*SRE?, 5-57
*STB?, 5-58
*TST?, 5-70

:DIAGnostic:DOWNload, 5-115
:DIAGnostic:ERASe, 5-115
:DIAGnostic:ERASe?, 5-116
:DIAGnostic:LIFetime:COUNt?, 5-71

:DIAGnostic:LOG:CLEAr, 5-45
:DIAGnostic:LOG:CLEAr <current log size>, 5-45
:DIAGnostic:LOG:COUNt?, 5-46
:DIAGnostic:LOG:READ:ALL?, 5-45
:DIAGnostic:LOG:READ?, 5-46
:DIAGnostic:LOG:READ? <entry number>, 5-47

:DIAGnostic:QUERy:RESPOse?, 5-108
:DIAGnostic:ROSCillator:EFControl:RELative?, 5-28

:DIAGnostic:TEST:RESult?, 5-72
:DIAGnostic:TEST?, 5-71

:FORMat:DATA, 5-93
:FORMat:DATA?, 5-93

:GPS:INITial:DATE, 5-9
:GPS:INITial:POSition, 5-10
:GPS:INITial:TIME, 5-11

:GPS:POSition, 5-12

:GPS:POSition:ACTual?, 5-14

:GPS:POSition:HOLD:LAST?, 5-14
:GPS:POSition:HOLD:STATe?, 5-15

:GPS:POSition:SURVey:PROGress?, 5-15
:GPS:POSition:SURVey:STATe, 5-15
:GPS:POSition:SURVey:STATe:POWerup, 5-16
:GPS:POSition:SURVey:STATe:POWerup?, 5-16
:GPS:POSition:SURVey:STATe?, 5-16

:GPS:POSition?, 5-13

:GPS:REFerence:ADELay, 5-22
:GPS:REFerence:ADELay?, 5-23

Command Index

:GPS:REFerence:VALid?, 5-24

:GPS:SATellite:TRACking:COUNT?, 5-25
:GPS:SATellite:TRACking:EMANgle, 5-17
:GPS:SATellite:TRACking:EMANgle?, 5-17

:GPS:SATellite:TRACking:IGNore, 5-18
:GPS:SATellite:TRACking:IGNore:ALL, 5-18
:GPS:SATellite:TRACking:IGNore:COUNT?, 5-20
:GPS:SATellite:TRACking:IGNore:NONE, 5-18
:GPS:SATellite:TRACking:IGNore:STATe?, 5-21
:GPS:SATellite:TRACking:IGNore?, 5-18

:GPS:SATellite:TRACking:INCLude, 5-19
:GPS:SATellite:TRACking:INCLude:ALL, 5-19
:GPS:SATellite:TRACking:INCLude:COUNT?, 5-20
:GPS:SATellite:TRACking:INCLude:NONE, 5-19
:GPS:SATellite:TRACking:INCLude:STATe?, 5-21
:GPS:SATellite:TRACking:INCLude?, 5-19

:GPS:SATellite:TRACking?, 5-24

:GPS:SATellite:VISible:PREdicted:COUNT?, 5-26
:GPS:SATellite:VISible:PREdicted?, 5-25

:LED:ALARm?, 5-56
:LED:GPSLock?, 5-29
:LED:HOLDover?, 5-29

:PTIME:DATE?, 5-75
:PTIME:LEAPsecond:ACCumulated?, 5-79
:PTIME:LEAPsecond:DATE?, 5-80
:PTIME:LEAPsecond:DURation?, 5-81
:PTIME:LEAPsecond:STATe?, 5-82

:PTIME:PPS:EDGE, 5-78
:PTIME:PPS:EDGE?, 5-78

:PTIME:TIME:STRing?, 5-76
:PTIME:TIME?, 5-75

:PTIME:TZONE, 5-77
:PTIME:TZONE?, 5-77

:PULSE:CONTInuous:PERiod, 5-84
:PULSE:CONTInuous:PERiod?, 5-84
:PULSE:CONTInuous:STATe, 5-85
:PULSE:CONTInuous:STATe?, 5-85

:PULSE:REFerence:EDGE, 5-86
:PULSE:REFerence:EDGE?, 5-86

:PULSE:STARt:DATE, 5-87
:PULSE:STARt:DATE?, 5-87
:PULSE:STARt:TIME, 5-88
:PULSE:STARt:TIME?, 5-88

Command Index

:SENSe:DATA:CLEAr, 5-90
:SENSe:DATA:CLEAr <data set>, 5-91

:SENSe:DATA:MEMory:OVERflow:COUNT?, 5-97
:SENSe:DATA:MEMory:OVERflow:COUNT? <data set>, 5-98
:SENSe:DATA:MEMory:SAVE, 5-98
:SENSe:DATA:MEMory:SAVE?, 5-99

:SENSe:DATA:POINts?, 5-94
:SENSe:DATA:POINts? <data set>, 5-94
:SENSe:DATA:TSTamp?, 5-95

:SENSe:DATA?, 5-92

:SENSe:TSTamp <channel>:EDGE, 5-90
:SENSe:TSTamp <channel>:EDGE?, 5-90

:STATus:<register>:CONDition?, 5-60
:STATus:<register>:ENABle, 5-62
:STATus:<register>:ENABle?, 5-63
:STATus:<register>:EVENT?, 5-61

:STATus:<register>:NTRansition, 5-64
:STATus:<register>:NTRansition?, 5-65
:STATus:<register>:PTRansition, 5-64
:STATus:<register>:PTRansition?, 5-65

:STATus:PRESet:ALARm, 5-55

:STATus:QUEStionable:CONDition:USER, 5-68
:STATus:QUEStionable:EVENT:USER, 5-69

:SYNChronization:FFOMerit?, 5-30

:SYNChronization:HOLDOver:DURation:THReshold, 5-34
:SYNChronization:HOLDOver:DURation:THReshold:EXCeeded?, 5-35
:SYNChronization:HOLDOver:DURation:THReshold?, 5-34
:SYNChronization:HOLDOver:DURation?, 5-33

:SYNChronization:HOLDOver:INITiate, 5-36

:SYNChronization:HOLDOver:RECOvery:INITiate, 5-37
:SYNChronization:HOLDOver:RECOvery:LIMit:IGNore, 5-38

:SYNChronization:HOLDOver:TUNCertainty:PREDicted?, 5-31
:SYNChronization:HOLDOver:TUNCertainty:PRESent?, 5-31
:SYNChronization:HOLDOver:WAITing?, 5-37

:SYNChronization:IMMediate, 5-38
:SYNChronization:STATe?, 5-28
:SYNChronization:TFOMerit?, 5-32
:SYNChronization:TINTerval?, 5-32

Command Index

:SYSTem:COMMunicate:<port>:BAUD, 5-101
:SYSTem:COMMunicate:<port>:BAUD?, 5-102
:SYSTem:COMMunicate:<port>:BITS?, 5-103
:SYSTem:COMMunicate:<port>:FDUPlex, 5-103
:SYSTem:COMMunicate:<port>:FDUPlex?, 5-104
:SYSTem:COMMunicate:<port>:PACE, 5-104
:SYSTem:COMMunicate:<port>:PACE?, 5-105
:SYSTem:COMMunicate:<port>:PARity, 5-105
:SYSTem:COMMunicate:<port>:PARity?, 5-106
:SYSTem:COMMunicate:<port>:PRESet, 5-110
:SYSTem:COMMunicate:<port>:SBITS?, 5-107
:SYSTem:COMMunicate:SERial1:BITS, 5-102
:SYSTem:COMMunicate:SERial1:SBITS, 5-106
:SYSTem:COMMunicate?, 5-101

:SYSTem:DATE?, 5-75

:SYSTem:ERRor?, 5-42, 5-116

:SYSTem:LANGuage?, 5-118

:SYSTem:PRESet, 5-110

:SYSTem:STATus:LENGth?, 5-41
:SYSTem:STATus?, 5-41

:SYSTem:TIME?, 5-75

General Index

SYMBOLS

- *CLS, 5-54, 5-115
- *ESE, 5-66
- *ESE?, 5-67
- *ESR?, 5-67
- *IDN?, 5-114
- *SRE, 5-57
- *SRE?, 5-57
- *STB?, 5-58
- *TST?, 5-70
- :DIAGnostic:DOWNload, 5-115
- :DIAGnostic:ERASe, 5-115
- :DIAGnostic:ERASe?, 5-116
- :DIAGnostic:LIFetime:COUNT?, 5-71
- :DIAGnostic:LOG:CLEar, 5-45
- :DIAGnostic:LOG:CLEar <current log size>, 5-45
- :DIAGnostic:LOG:COUNT?, 5-46
- :DIAGnostic:LOG:READ:ALL?, 5-45
- :DIAGnostic:LOG:READ?, 5-46
- :DIAGnostic:LOG:READ? <entry number>, 5-47
- :DIAGnostic:QUERy:RESPonse?, 5-108
- :DIAGnostic:ROSCillator:EFControl:RELative?, 5-28
- :DIAGnostic:TEST:RESult?, 5-72
- :DIAGnostic:TEST?, 5-71
- :FORMat:DATA, 5-93
- :FORMat:DATA?, 5-93
- :GPS:INITial:DATE, 5-9
- :GPS:INITial:POSition, 5-10
- :GPS:INITial:TIME, 5-11
- :GPS:POSition, 5-12
- :GPS:POSition:ACTual?, 5-14
- :GPS:POSition:HOLD:LAST?, 5-14
- :GPS:POSition:HOLD:STATe?, 5-15
- :GPS:POSition:SURVey:PROGress?, 5-15
- :GPS:POSition:SURVey:STATe, 5-15
- :GPS:POSition:SURVey:STATe:POWerup, 5-16
- :GPS:POSition:SURVey:STATe:POWerup?, 5-16
- :GPS:POSition:SURVey:STATe?, 5-16
- :GPS:POSition?, 5-13
- :GPS:REFerence:ADELay, 5-22
- :GPS:REFerence:ADELay?, 5-23
- :GPS:REFerence:VALid?, 5-24
- :GPS:SATellite:TRACking:COUNT?, 5-25
- :GPS:SATellite:TRACking:EMANgle, 5-17
- :GPS:SATellite:TRACking:EMANgle?, 5-17
- :GPS:SATellite:TRACking:IGNore, 5-18
- :GPS:SATellite:TRACking:IGNore:ALL, 5-18
- :GPS:SATellite:TRACking:IGNore:COUNt?, 5-20
- :GPS:SATellite:TRACking:IGNore:NONE, 5-18
- :GPS:SATellite:TRACking:IGNore:STATe?, 5-21
- :GPS:SATellite:TRACking:IGNore?, 5-18
- :GPS:SATellite:TRACking:INCLude, 5-19
- :GPS:SATellite:TRACking:INCLude:ALL, 5-19
- :GPS:SATellite:TRACking:INCLude:COUNt?, 5-20
- :GPS:SATellite:TRACking:INCLude:NO NE, 5-19
- :GPS:SATellite:TRACking:INCLude:STATe?, 5-21
- :GPS:SATellite:TRACking:INCLude?, 5-19
- :GPS:SATellite:TRACking?, 5-24
- :GPS:SATellite:VISible:PREDicted:COUNt?, 5-26
- :GPS:SATellite:VISible:PREDicted?, 5-25
- :LED:ALARm?, 5-56
- :LED:GPSLock?, 5-29
- :LED:HOLDover?, 5-29
- :PTIME:DATE?, 5-75
- :PTIME:LEAPsecond:ACCumulated?, 5-79
- :PTIME:LEAPsecond:DATE?, 5-80
- :PTIME:LEAPsecond:DURation?, 5-81
- :PTIME:LEAPsecond:STATe?, 5-82
- :PTIME:PPS:EDGE, 5-78
- :PTIME:PPS:EDGE?, 5-78
- :PTIME:TIME:STRing?, 5-76
- :PTIME:TIME?, 5-75
- :PTIME:TZONE, 5-77
- :PTIME:TZONE?, 5-77
- :PULSE:CONTInuous:PERiod, 5-84
- :PULSE:CONTInuous:PERiod?, 5-84
- :PULSE:CONTInuous:STATe, 5-85
- :PULSE:CONTInuous:STATe?, 5-85
- :PULSE:REFerence:EDGE, 5-86
- :PULSE:REFerence:EDGE?, 5-86
- :PULSE:START:DATE, 5-87
- :PULSE:START:DATE?, 5-87
- :PULSE:START:TIME, 5-88
- :PULSE:START:TIME?, 5-88
- :SENSe:DATA:CLEar, 5-90
- :SENSe:DATA:CLEar <data set>, 5-91

- :SENSe:DATA:MEMory:OVERflow:COU
Nt?, 5-97
 - :SENSe:DATA:MEMory:OVERflow:COU
Nt? <data set>, 5-98
 - :SENSe:DATA:MEMory:SAVE, 5-98
 - :SENSe:DATA:MEMory:SAVE?, 5-99
 - :SENSe:DATA:POINts?, 5-94
 - :SENSe:DATA:POINts? <data set>, 5-94
 - :SENSe:DATA:TSTamp?, 5-95
 - :SENSe:DATA?, 5-92
 - :SENSe:TSTamp <channel>:EDGE, 5-90
 - :SENSe:TSTamp <channel>:EDGE?, 5-90
 - :STATus:<register>:CONDition?, 5-60
 - :STATus:<register>:ENABle, 5-62
 - :STATus:<register>:ENABle?, 5-63
 - :STATus:<register>:EVENT?, 5-61
 - :STATus:<register>:NTRansition, 5-64
 - :STATus:<register>:NTRansition?, 5-65
 - :STATus:<register>:PTRansition, 5-64
 - :STATus:<register>:PTRansition?, 5-65
 - :STATus:PRESet:ALARm, 5-55
 - :STATus:QUEStionable:CONDition:USE
R, 5-68
 - :STATus:QUEStionable:EVENT:USER, 5
-69
 - :SYNChronization:FFOMerit?, 5-30
 - :SYNChronization:HOLDOver:DURation:
THReshold, 5-34
 - :SYNChronization:HOLDOver:DURation:
THReshold:EXCeeded?, 5-35
 - :SYNChronization:HOLDOver:DURation:
THReshold?, 5-34
 - :SYNChronization:HOLDOver:DURation?
, 5-33
 - :SYNChronization:HOLDOver:INITiate,
5-36
 - :SYNChronization:HOLDOver:RECOvery:
INITiate, 5-37
 - :SYNChronization:HOLDOver:RECOvery:
LIMit:IGNore, 5-38
 - :SYNChronization:HOLDOver:TUNCertai
nty:PREDicted?, 5-31
 - :SYNChronization:HOLDOver:TUNCertai
nty:PRESent?, 5-31
 - :SYNChronization:HOLDOver:WAITing?,
5-37
 - :SYNChronization:IMMediate, 5-38
 - :SYNChronization:STATe?, 5-28
 - :SYNChronization:TFOMerit?, 5-32
 - :SYNChronization:TINTerval?, 5-32
 - :SYSTem:COMMunicate:<port>:BAUD, 5
-101
 - :SYSTem:COMMunicate:<port>:BAUD?,
5-102
 - :SYSTem:COMMunicate:<port>:BITs?, 5
-103
 - :SYSTem:COMMunicate:<port>:FDUPlex
, 5-103
 - :SYSTem:COMMunicate:<port>:FDUPlex
?, 5-104
 - :SYSTem:COMMunicate:<port>:PACE, 5
-104
 - :SYSTem:COMMunicate:<port>:PACE?,
5-105
 - :SYSTem:COMMunicate:<port>:PARity,
5-105
 - :SYSTem:COMMunicate:<port>:PARity?,
5-106
 - :SYSTem:COMMunicate:<port>:PRESet,
5-110
 - :SYSTem:COMMunicate:<port>:SBITs?,
5-107
 - :SYSTem:COMMunicate:SERial1:BITs,
5-102
 - :SYSTem:COMMunicate:SERial1:SBITs,
5-106
 - :SYSTem:COMMunicate?, 5-101
 - :SYSTem:DATE?, 5-75
 - :SYSTem:ERRor?, 5-42, 5-116
 - :SYSTem:LANGuage?, 5-118
 - :SYSTem:PRESet, 5-110
 - :SYSTem:STATus:LENGth?, 5-41
 - :SYSTem:STATus?, 5-41
 - :SYSTem:TIME?, 5-75
- NUMERICS**
- 1 PPS, 1-4
 - 1 PPS error estimation, 5-31
 - 1 PPS output, 5-27
 - 1 PPS output quality, 4-7, 4-10, 5-27,
5-28, 5-29, 5-30, 5-31, 5-32, 5-33, 5-34,
5-35
 - 1 PPS polarity, 4-10, 5-78
 - 1 PPS reference edge, 4-10
 - 1 PPS reference synchronization, 4-7
 - 1 PPS output, 1-6
 - 1 PP2S connector (optional), 1-4
 - 1 PP2S output, 1-4
 - 1 PPS signal is locked to valid GPS
reference, 5-24
 - 1 PPS signal is valid, 5-24
 - 10 MHz OUT, 1-4
 - 10 MHz output, 5-27
 - 10 MHz output quality, 4-7, 4-10, 5-27,
5-28, 5-29, 5-30, 5-31, 5-32, 5-33, 5-34,
5-35
- A**
- abbreviated commands, B-5
 - ac power, 1-6
 - ACQUISITION, 3-11, 3-14
 - acquisition of satellites, 4-5, 4-6, 5-7, 5-8
 - Alarm, 1-2, 1-4

- alarm analysis, 4-8, 5-39, 5-40, 5-48, 5-49, 5-50, 5-51, 5-52, 5-53, 5-54, 5-55, 5-56, 5-57, 5-58, 5-59, 5-60, 5-61, 5-62, 5-63, 5-64, 5-65, 5-66, 5-67, 5-68, 5-69
- Alarm BITE, 1-6
- alarm BITE, 4-8, 5-39, 5-48, 5-49, 5-50, 5-51, 5-52, 5-53, 5-54, 5-56, 5-57, 5-58, 5-59, 5-60, 5-61, 5-62, 5-63, 5-64, 5-65, 5-66, 5-67, 5-68, 5-69
- alarm clear, 4-8, 5-39, 5-54, 5-55, 5-56, 5-57, 5-58
- Alarm condition, 1-2, 1-4, 1-5
- Alarm indicator, 1-6, 4-8, 5-39, 5-56
- Alarm LED, 1-3
- alarm relay, 4-8, 5-39, 5-48, 5-49, 5-50, 5-51, 5-52, 5-53, 5-54, 5-55, 5-56, 5-57, 5-58, 5-59, 5-60, 5-61, 5-62, 5-63, 5-64, 5-65, 5-66, 5-67, 5-68, 5-69
- alarm setup, 4-8, 5-39, 5-48, 5-49, 5-50, 5-51, 5-52, 5-53, 5-54, 5-56, 5-57, 5-58, 5-59, 5-60, 5-61, 5-62, 5-63, 5-64, 5-65, 5-66, 5-67, 5-68, 5-69
- alarm status, 5-50
- alarm test, 4-8, 5-39, 5-40, 5-68, 5-69, 5-70, 5-71, 5-72
- antenna
 - delay values, 5-22
- antenna connection, 5-22
- ANTENNA connector, 1-4, 1-6
- antenna delay, 3-17
- antenna delay compensation, 4-6, 5-8
- antenna placement, 4-6, 5-8, 5-22
- ASCII Data, B-11
- azimuth angle, 3-15
- B**
- baud, 2-9, 5-101, 5-102, 5-110
- baud rate, 2-9
- BINARY Data, 5-93, B-11
- Boolean, B-5
- C**
- C/N, 3-15
- cable delay compensation, 4-6, 5-8
- cables, 5-22
 - crossover, 2-5
 - HP 24542G interface, 2-6
 - HP 24542U, 2-8
 - HP 40242M interface, 2-6
 - modem-eliminator, 2-5
 - null-modem, 2-5
- carrier-to-noise ratio, 3-15
- characteristics
 - 58503B, E-2
 - 59551A, F-2
- clear, 5-90, 5-91
 - alarm, 4-8, 5-39, 5-54
 - errors, 4-8, 5-39, 5-42, 5-115
- clear time stamp memory, 5-89
- comma, B-4, B-6, B-9
- command
 - abbreviated, B-5
 - common, B-3
 - format, 5-5
 - parameter, B-5
 - SCPI, B-3
 - syntax, B-2, B-5
 - terminator, B-7
 - terminators, B-4
- command error, 4-9, 5-40, 5-48, 5-53
- Command Error status, 5-48
- command syntax conventions, 4-4, 5-4
- commands
 - introduction, 4-4
- Commands at a Glance, 4-17
- commands summary, 4-17
- common command
 - syntax, B-4
- Common Command Format, B-3
- common commands
 - description, B-3
- communication
 - serial interface port, 2-3, 2-4, 5-100, 5-101, 5-103, 5-104, 5-105, 5-106
- compensating for antenna delay, 5-22
- configuration
 - PORT 1, 2-11, 5-100
 - PORT 2, 2-11, 5-100
- configuration factory-default values, 5-110
- configuring PORT 1, 2-10, 4-13
- configuring PORT 2, 2-10, 4-13
- configuring serial interface port(s), 5-100
- configuring the RS-232C ports, 2-9
- conformance Information
 - SCPI, 4-4
- connecting a computer, 2-5
- connecting a laptop, 2-6
- connecting a modem, 2-5, 2-6
- connecting a PC, 2-6
- connecting antenna system, 4-6, 5-8, 5-22
- conventions
 - command syntax, 4-4, 5-4
- Coordinated Universal Time, 5-7
- CPU, 5-70
- crossover cable, 2-5
- current time, 4-10
- D**
- d.dEe, B-10
- d.dEe, ..., B-10
- d.dEed.dEe, B-10
- data, 5-92

General Index

- data bits, 2-9, 5-102, 5-103, 5-110
- date and time outputs, 4-6, 4-10, 5-8
- DB-25 connector, 2-5
- DB-9 connector, 2-5
- dc power, 1-6
- DCE, 2-5
- dd, ..., B-10
- dddd, B-10
- decimal point, B-5, B-10
- defaults, factory settings, 2-9, 4-14, 5-110, 5-111
- delay value, 5-22
- delay values, 5-22
- delay values, antenna cables, 4-6, 5-8
- diagnostic log, 4-8, 5-39, 5-43, 5-44, 5-45, 5-46, 5-47
- diagnostic log messages, 5-43
- diagnostic tests, 4-9, 5-40, 5-70, 5-71, 5-72
 - result, 5-72
- diagnostics
 - internal self-test, 5-70
- documents
 - list, B-12
 - related, B-12
- download, 5-115
- downloading
 - Using HP SatStat, C-2
- downloading new firmware, C-2
- DTE, 2-5
- duplex state, 5-103, 5-104

E

- echoing of the characters you type, 5-103, 5-104, 5-110
- EEPROM, 5-70, 5-115
- elevation angle, 3-15
- elevation mask angle, 3-15
- EPROM, 5-70
- erasing
 - EEPROM, 5-116
- error
 - hardware/firmware, A-5
 - query, A-5
 - semantic, A-5
 - syntactic, A-4
- error analysis, 4-8, 5-39, 5-40, 5-42, 5-116
- error behavior, A-6
- error log, 4-8, 5-39, 5-40, 5-42, 5-116
- error messages, 4-8, 5-39, A-7
- error queue, 4-8, 5-39, 5-42, 5-116, A-3
- error recovery, serial port, 4-8, 4-13, 5-39, 5-108
- error types, A-4
- error, command, 5-48, 5-53
- error, reading, A-2

F

- factory default settings, 2-9, 4-14, 5-109, 5-110
- failure protection, satellite loss, 4-7, 5-27, 5-33, 5-34, 5-35
- FFOM, 4-7, 5-30
- FFOM value, 3-14
- Figure
 - command list, 4-17
 - factory instrument settings, 5-111
 - factory serial port settings, 5-111
 - status reporting system, 5-49
- figure of merit, 5-30, 5-32, 5-74
- firmware error, A-5
- firmware installation, 2-3, 4-15, 5-113, 5-115, 5-116, 5-117, 5-118
- firmware revision code, 2-3, 4-15, 5-114
- firmware upgrade, 2-3, 5-115
- flash EEPROM, 5-115
- flow control state, 5-104, 5-105
- format
 - ASCIi, 5-93
 - INTEger, 5-93
- FPGA logic, 5-70
- front panel
 - 59551A, 1-5
 - PORT 2, 2-4
- full duplex, 2-9, 5-104, 5-110

G

- GPS engine, 5-70
- GPS Lock, 1-2
- GPS lock, 4-5, 4-6, 5-7, 5-33, 5-34, 5-35
- GPS Lock indicator, 4-7, 5-29
- GPS Lock LED, 1-3, 1-5
- GPS position, 4-5, 5-7, 5-13, 5-14, 5-15
- GPS satellite acquisition, 4-5, 4-6, 5-7, 5-33, 5-34, 5-35
- GPS time, 3-16
- GPS timeline, 5-73

H

- Hardware status, 5-48, 5-51, 5-60, 5-61, 5-62, 5-63, 5-64, 5-65
- hardware/firmware error, A-5
- HEALTH MONITOR, 3-11
- health monitor screen, 3-11
- Hold position mode, 3-17
- Holdover, 1-2, 3-12
- holdover
 - process, 5-27
 - recovery, 5-27, 5-37
 - status, 5-48, 5-52
 - tutorial, 3-8
- Holdover indicator, 4-7, 5-29
- Holdover LED, 1-3, 1-5
- holdover loss of satellites, 4-7

General Index

holdover mode, 1-2, 1-5
holdover operation, 3-8
holdover recovery, 4-7, 5-37
holdover status, 4-9
holdover threshold, 3-14
How to use the Status Screen, 3-3
HP 58518A/519A cable, 5-22
HP 58518AA/519AA cable, 5-22
HP 58520A/521A cable, 5-23
HP 58520AA/521AA cable, 5-23
HP SatStat, 3-3, C-2
HP SmartClock, 3-11
HP 24542G interface cable, 2-6
HP 24542U cable, 2-8
HP 40242M interface cable, 2-6

I

I/O
 PORT 1, 59551A, 1-6
 PORT 2, 59551A, 1-5
I/O PORT 1, 4-13
identification of Receiver, 4-15, 5-114
IEEE Standard 488.2
 obtaining copy of standard, B-12
IEEE 488.2
 description, B-3
 syntax, B-4
In This Guide, ix
indicator
 Alarm, 1-2, 1-5, 1-6
 GPS Lock, 1-2, 1-5
 Holdover, 1-2, 1-5
 Power, 1-2, 1-5
indicators
 Alarm, 1-3
 GPS Lock, 1-3
 Holdover, 1-3
 Power, 1-3
initialization, 5-109
initializing the Receiver, 4-14
initiating manual Holdover, 5-27, 5-36
input
 antenna, 1-6, 4-6, 5-8, 5-22
 Power, 1-4
 Time Tag, 1-6, 4-12
input jack, 1-6
inputs
 Time tag, 1-6
install
 firmware, 2-3, 4-15, 5-113, 5-115
 Receiver, 5-9, 5-17, 5-22
install firmware, 5-115
INSTALL language, 5-115, 5-117
installation, 4-15
interface
 RS-232C, 2-3

internal reference oscillator, 5-7, 5-27
internal self-test diagnostics, 5-70
interpolators, 5-70
introduction
 commands, 4-4
IRIG-B output, 1-6

K

keyword
 separator, B-5

L

latitude, 4-5, 5-7, 5-12, 5-13, 5-14
leap second, 4-10
leap second status, 5-73
LED

 Alarm, 1-2, 1-3, 1-5, 1-6, 4-8, 5-39
 GPS Lock, 1-2, 1-3, 1-5, 4-7
 Holdover, 1-3, 1-5, 4-7
 Power, 1-2, 1-3, 1-5

lifetime count, 5-71

list of

 commands, 4-17
 configuration factory-default
 values, 5-110
 error messages, A-7
 error types, A-4
 factory-default values, 5-110
 response format, B-10
 system preset, 5-111

literal, B-5

local time, 4-10

local time zone, 3-16

locking to GPS satellites, 4-5, 4-6, 5-7,
5-8, 5-9, 5-10, 5-11, 5-12, 5-13, 5-14, 5-15,
5-16, 5-17, 5-18, 5-19, 5-20, 5-21, 5-22,
5-23, 5-24, 5-25, 5-26, 5-33, 5-34, 5-35,
5-36, 5-37, 5-38, 5-39

log, diagnostic, 4-8, 5-39, 5-43, 5-44, 5-45,
5-46, 5-47

log, error, 4-8, 5-39, 5-40, 5-42, 5-116

longitude, 4-5, 5-7, 5-12, 5-13, 5-14

M

MAXimum, B-6

memory overflow, 4-12, 5-89

messages

 program, B-7
 response, B-9

messages, error, A-7

MINimum, B-6

modem-eliminator cable, 2-5

multipliers, B-7

N

new line, B-11

not tracking., 3-14

General Index

- Nrf, B-5
- null-modem cable, 2-5
- O**
- OHM, B-6
- Operation status, 5-39, 5-48, 5-50, 5-60, 5-61, 5-62, 5-63, 5-64, 5-65
- operational verification, D-2
- output
 - 1 PPS, 1-4, 1-6, 4-7, 4-10, 5-27, 5-28, 5-29, 5-30, 5-31, 5-32, 5-33, 5-34, 5-35, 5-78
 - 10 MHz, 4-7, 4-10, 5-27, 5-28, 5-29, 5-30, 5-31, 5-32, 5-33, 5-34, 5-35
 - 10 MHz OUT, 1-4
 - Alarm, 1-4
 - alarm, 4-7
 - Alarm BITE, 1-6
 - IRIG-B, 1-6
 - Programmable Pulse, 1-6, 4-11, 5-83, 5-84, 5-85, 5-86, 5-87, 5-88
 - synchronization, 5-28, 5-29, 5-30, 5-31, 5-32, 5-33, 5-34, 5-35
- output pulse, 4-11, 5-83, 5-84, 5-85, 5-86, 5-87, 5-88
- output synchronization, 4-7
- outputs
 - 1 PP2S (optional), 1-4
 - 1 PPS, 1-6
 - IRIG-B, 1-6
 - Programmable Pulse, 1-6
- P**
- pace, 2-9, 5-104, 5-105, 5-110
- pacing, 5-110
- parameter separator, B-6
- parameter types, B-5
 - Boolean, B-5
 - literal, B-5
 - string, B-5
- parity, 2-9, 5-105, 5-106, 5-110
- performance tests, D-2
- pin assignment
 - PORT 1, 2-3
 - PORT 2, 2-4
- polarity of edges
 - 1 PPS, 4-10, 5-78
 - programmable pulse, 4-11
 - time stamp, 4-12, 5-89, 5-90
- PORT, 1-6
- PORT 1, 2-6, 4-13, 5-100, 5-101, 5-102, 5-103, 5-104, 5-105, 5-106, 5-107, 5-110
 - factory-default values, 2-9
- PORT 1 configuration, 2-11
- PORT 1 rear panel, 2-3
- PORT 1, 58503B, 1-4
- PORT 2, 1-5, 4-13, 5-100, 5-101, 5-102, 5-103, 5-104, 5-105, 5-106, 5-107, 5-110
 - factory-default values, 2-9
- PORT 2 configuration, 2-11
- PORT 2 front panel, 2-4
- Position, 3-17
- position, 4-5, 5-7, 5-12, 5-13, 5-14, 5-15
- position at powerup, 5-16
- position hold, 5-15
- Power, 1-2
- power
 - ac, 1-6
 - dc, 1-6
- POWER input, 1-4
- power input jack, 1-6
- Power input jack, 58503A, 1-4
- Power LED, 1-3, 1-5
- power outages, 5-89
- power supply, 1-6
- Power supply levels, 5-70
- power surges, 5-89
- Powerup status, 5-48, 5-52
- predicted visible satellites, 5-25
- preface, ix
- preset, 5-109
- preset to factory defaults, 2-9, 4-14, 5-109, 5-110
- product identification, 4-15, 5-114
- program messages
 - definition, B-7
 - syntax, B-7
- programmable pulse, 4-11, 5-83, 5-84, 5-85, 5-86, 5-87, 5-88
- Programmable Pulse output, 1-6
- pseudorandom noise, 3-15
- pulse generator, 4-11, 5-83, 5-84, 5-85, 5-86, 5-87, 5-88
- pulse output, 4-11, 5-83, 5-84, 5-85, 5-86, 5-87, 5-88
- Q**
- QSPI, 5-70
- quality
 - FFOM, 3-14
 - signal, 3-13, 3-14
 - TFOM, 3-13
- query, B-6, B-9
- query error, A-5
- query parameters
 - <numeric value>, B-6
 - MAXimum, B-6
 - MINimum, B-6
- querying instrument identification, 5-113
- Questionable status, 5-48, 5-52
- queue overflows, A-3
- queue, error, 4-8, 5-39, 5-116

quick reference
 command list, 4-17
 factory instrument settings, 5-111
 factory serial port settings, 5-110
 status reporting system, 4-18

R

RAM, 5-70
 rear panel
 58503A, 1-4
 59551A, 1-6
 PORT 1, 2-3
 Receiver Commands at a Glance, 4-17
 Receiver identification, 4-15, 5-113, 5-114
 Receiver initialization, 4-14
 Receiver Status Screen, 3-3
 Receiver status screen, 5-41
 recovering from holdover, 4-7, 5-27, 5-37
 recovering the last query response, 4-13, 5-100
 Recovery, 3-12
 Reference oscillator, 5-70
 related ocumentation, B-12
 relay, alarm, 4-8, 5-39, 5-48, 5-49, 5-50, 5-51, 5-52, 5-53, 5-54, 5-55, 5-56, 5-57, 5-58, 5-59, 5-60, 5-61, 5-62, 5-63, 5-64, 5-65, 5-66, 5-67, 5-68, 5-69
 removes error from error queue, 5-116
 reset to factory defaults, 2-9, 4-14, 5-109, 5-110
 response message syntax, B-9
 response messages, B-9
 data types, B-10
 restore to factory defaults, 2-9, 4-14, 5-109, 5-110
 revision code, 4-15, 5-114
 RS-232C, 1-4, 1-5, 1-6
 RS-232C interface, 4-13, 5-100, 5-101, 5-102, 5-103, 5-104, 5-105, 5-106, 5-107
 RS-232C ports, 2-3

S

satellite acquisition, 4-5, 4-6, 5-7, 5-33, 5-34, 5-35
 satellite failure protection, 4-7, 5-27, 5-33, 5-34, 5-35
 satellite loss, 4-7, 5-33, 5-34, 5-35
 satellite management, 4-5, 4-6, 5-7, 5-9, 5-10, 5-11, 5-12, 5-13, 5-14, 5-15, 5-16, 5-17, 5-18, 5-19, 5-20, 5-21, 5-22, 5-23, 5-24, 5-25, 5-26, 5-33, 5-34, 5-35, 5-36, 5-37, 5-38, 5-39
 satellite reacquisition, 4-7
 satellite selection, 4-6, 5-7
 Satellite Status, 3-14
 satellite tracking at installation, 4-5, 5-7, 5-9

SCPI, B-2
 description, B-3
 version, 4-4
 SCPI Command and Query Format, B-3
 SCPI conformance Information, 4-4
 SCPI standard, B-12
 Self Test, 3-18
 self test, 4-9, 5-40, 5-70, 5-71, 5-72
 semantic error, A-5
 separator
 keyword, B-5
 parameter, B-6
 serial interface, 1-4, 1-5, 1-6
 serial interface communication, 4-13
 serial interface port, 2-3, 2-4
 preset, 5-109
 serial number, 5-114
 serial port error recovery, 4-8, 4-13, 5-39, 5-108
 serial port I/O, 4-13, 5-110
 serial port settings, 2-11
 setting up the Receiver, 4-15, 5-9, 5-17
 settings, serial port, 2-11
 signal
 quality, 3-13, 3-14
 signal loss, 4-7, 5-27, 5-33, 5-34, 5-35, 5-36, 5-37, 5-38
 signal strength, 3-15
 SmartClock Mode, 3-12
 SmartClock PLL, 3-14
 software pacing, 2-9
 specifications
 58503B, E-2
 59551A, F-2
 SS, 3-15
 status
 alarm, 5-50, 5-56
 command error, 5-53, 5-66
 hardware, 5-51, 5-60, 5-61, 5-62, 5-63, 5-64, 5-65
 holdover, 5-52, 5-60, 5-61, 5-62, 5-63, 5-64, 5-65
 operation, 5-50, 5-60, 5-61, 5-62, 5-63, 5-64, 5-65
 powerup, 5-52, 5-60, 5-61, 5-62, 5-63, 5-64, 5-65
 questionable, 5-52, 5-60, 5-61, 5-62, 5-63, 5-64, 5-65, 5-68
 status information, 5-39
 status registers, 5-48
 status reporting, 4-8, 4-9, 5-39, 5-40, 5-48, 5-49, 5-50, 5-51, 5-52, 5-53, 5-54, 5-56, 5-57, 5-58, 5-59, 5-60, 5-61, 5-62, 5-63, 5-64, 5-65, 5-66, 5-67, 5-68, 5-69
 status reporting system, 5-48
 Status Reporting System Diagram, 5-49

General Index

- status screen, 4-8, 5-41
- status/alarm reporting system, 5-48
- stop bits, 2-9, 5-106, 5-107, 5-110
- strength of the signal, 3-15
- string, B-5
- subsystem command
 - syntax, B-4
- suffix
 - elements, B-6
 - multipliers, B-7
- suffix, multiplier, B-7
- suffixes, B-6
- summary
 - commands, 4-17
- survey mode, 5-15
- Survey position mode, 3-17
- SYNCHRONIZATION, 3-11
- synchronization of output signals, 4-7, 5-28, 5-29, 5-30, 5-31, 5-32, 5-33, 5-34, 5-35
- synchronizing to reference, 4-7, 5-27
- syntactic error, A-4
- syntax, 4-4, 5-4
 - program messages, B-7
 - response messages, B-9
- syntax, SCPI, B-2
- SYSTEM
 - STATUS? query, 3-3
- system preset, 5-111
- system time, 4-10, 5-73

T

Table

- command list, 4-17
- factory instrument settings, 5-110, 5-111
- factory serial port settings, 5-110
- status reporting system, 5-49

terminator

- command, B-7

test record, D-2

test result, 5-72

TFOM, 4-7, 5-32, 5-74

TFOM value, 3-13

time and date outputs, 4-6, 4-10, 5-8, 5-73, 5-74, 5-75, 5-76, 5-77

time of day outputs, 4-6, 4-10, 5-8, 5-73, 5-74, 5-75, 5-76, 5-77

Time Stamp memory, 4-12

time stamp polarity, 4-12, 5-89, 5-90

time stamping, 4-12, 5-89, 5-90, 5-91, 5-92, 5-93, 5-94, 5-95, 5-96, 5-97, 5-98, 5-99

time tag, 4-12, 5-89, 5-90, 5-91, 5-92, 5-93, 5-94, 5-95, 5-96, 5-97, 5-98, 5-99

Time Tag inputs, 4-12

Time tag inputs, 1-6

time transfer information, 5-7

time zone setting, 4-10, 5-73, 5-77

Time-stamped Edge, 4-12, 5-90

time-stamped edge, 5-90

timing outputs, 4-7, 5-28, 5-29, 5-30, 5-31, 5-32, 5-33, 5-34, 5-35

timing shift, 3-14

tutorial, 3-3

- using the Status Screen, 3-3

U

UART, 5-70

units, B-6

upgrading firmware, 2-3, 4-15, 5-113

UTC, 5-7

UTC time, 3-16

UTC timeline, 5-73

V

visible satellites, 5-25

W

Windows program

- Receiver Status screen, C-2

X

XON, 5-104

XYZ, B-11